

FINAL REPORT

Bioaugmentation for Groundwater Remediation

ESTCP Project ER-0515

FEBRUARY 2010

Robert Steffan
Charles Schaefer
David Lippincott
Shaw Environmental and Infrastructure, Inc.

Distribution Statement A: Approved for Public Release,
Distribution is Unlimited



Environmental Security Technology
Certification Program

Report Documentation Page

*Form Approved
OMB No. 0704-0188*

Public reporting burden for the collection of information is estimated to average 1 hour per response, including the time for reviewing instructions, searching existing data sources, gathering and maintaining the data needed, and completing and reviewing the collection of information. Send comments regarding this burden estimate or any other aspect of this collection of information, including suggestions for reducing this burden, to Washington Headquarters Services, Directorate for Information Operations and Reports, 1215 Jefferson Davis Highway, Suite 1204, Arlington VA 22202-4302. Respondents should be aware that notwithstanding any other provision of law, no person shall be subject to a penalty for failing to comply with a collection of information if it does not display a currently valid OMB control number.

1. REPORT DATE FEB 2010	2. REPORT TYPE	3. DATES COVERED 00-00-2010 to 00-00-2010			
4. TITLE AND SUBTITLE Bioaugmentation for Groundwater Remediation		5a. CONTRACT NUMBER			
		5b. GRANT NUMBER			
		5c. PROGRAM ELEMENT NUMBER			
6. AUTHOR(S)		5d. PROJECT NUMBER			
		5e. TASK NUMBER			
		5f. WORK UNIT NUMBER			
7. PERFORMING ORGANIZATION NAME(S) AND ADDRESS(ES) Shaw Environmental and Infrastructure, Inc, 4171 Essen Ln, Baton Rouge, LA, 70809		8. PERFORMING ORGANIZATION REPORT NUMBER			
9. SPONSORING/MONITORING AGENCY NAME(S) AND ADDRESS(ES)		10. SPONSOR/MONITOR'S ACRONYM(S)			
		11. SPONSOR/MONITOR'S REPORT NUMBER(S)			
12. DISTRIBUTION/AVAILABILITY STATEMENT Approved for public release; distribution unlimited					
13. SUPPLEMENTARY NOTES					
14. ABSTRACT					
15. SUBJECT TERMS					
16. SECURITY CLASSIFICATION OF:			17. LIMITATION OF ABSTRACT	18. NUMBER OF PAGES	19a. NAME OF RESPONSIBLE PERSON
a. REPORT unclassified	b. ABSTRACT unclassified	c. THIS PAGE unclassified	Same as Report (SAR)	345	

LIST OF TABLES	ii
LIST OF FIGURES	iii
LIST OF APPENDICES	iv
ABBREVIATIONS AND ACRONYMS.....	v
ACKNOWLEDGMENTS	vii
EXECUTIVE SUMMARY	viii
1.0 INTRODUCTION.....	1
1.1 BACKGROUND.....	1
1.2 OBJECTIVE OF THE DEMONSTRATION	2
1.3 REGULATORY DRIVERS	3
2.0 TECHNOLOGY.....	4
2.1 TECHNOLOGY DESCRIPTION	4
2.1.1 Previous Testing of the Technology.....	7
2.1.2 Factors Affecting Cost and Performance	8
2.2 TECHNOLOGY DEVELOPMENT.....	10
2.3 ADVANTAGES AND LIMITATIONS OF THE TECHNOLOGY	10
3.0 PERFORMANCE OBJECTIVES.....	12
3.1 DHC DOSAGE COMPARISON.....	13
3.2 BIOAUGMENTATION/BIOSTIMULATION COMPARISON.....	13
3.3 ELECTRON DONOR DISTRIBUTION	14
3.4 pH ADJUSTMENT	15
3.5 REMEDIAL EFFECTIVENESS	15
4.0 SITE DESCRIPTION.....	17
4.1 SITE LOCATION AND HISTORY	19
4.2 SITE GEOLOGY/HYDROGEOLOGY.....	21
4.3 CONTAMINANT DISTRIBUTION	23
5.0 TEST DESIGN	26
5.1 CONCEPTUAL EXPERIMENTAL DESIGN	26
5.2 BASELINE CHARACTERIZATION	26
5.2.1 Direct-Push Investigation.....	26
5.2.2 Piezometer Installation	34
5.2.3 Slug Testing.....	34
5.2.4 Aquifer Pump Testing	37
5.2.5 Baseline Groundwater Sampling.....	39
5.2.6 Baseline Groundwater Elevation Measurements.....	65
5.3 TREATABILITY AND LABORATORY STUDY RESULTS	68
5.3.1 Laboratory Microcosm Testing	68
5.3.2 Preliminary Testing to Evaluate SDC-9 Transport and Kinetics through Saturated Soil.....	68
5.3.3 Column Testing using MAG-1 Soil and Groundwater.....	70
5.4 DESIGN AND LAYOUT OF TECHNOLOGY COMPONENTS.....	71
5.4.1 Groundwater Modeling and Final System Conceptual Design	71
5.4.2 Permitting	74
5.4.3 Well and Equipment Installation	75
5.4.4 Biofouling Mitigation Approach	83
5.5 FIELD TESTING	84

5.5.1	System Testing	84
5.5.2	System Start-up and Tracer Testing	84
5.5.3	Bioaugmentation, Systems Operation, and Performance Monitoring.....	86
5.5.4	Demobilization	90
5.6	SAMPLING METHODS	90
5.7	SAMPLING RESULTS	93
5.7.1	Water Level Measurements	93
5.7.2	Tracer Testing.....	95
5.7.3	System Start-up Sampling	99
5.7.4	Performance Sampling	100
5.7.5	Systems Operation.....	108
6.0	PERFORMANCE ASSESSMENT.....	110
6.1	DHC DOSAGE COMPARISON.....	110
6.2	BIOAUGMENTATION/BIOSTIMULATION COMPARISON.....	115
6.3	ELECTRON DONOR DISTRIBUTION	116
6.4	pH ADJUSTMENT	116
6.5	REMEDIAL EFFECTIVENESS	117
7.0	COST ASSESSMENT	118
7.1	COST MODEL	118
7.2	COST DRIVERS	120
7.3	COST ANALYSIS.....	122
7.3.1	Active Bioaugmentation, Active Biostimulation and Pump & Treat Comparison.....	122
7.3.2	Passive Bioaugmentation and Passive Biostimulation Comparison	128
8.0	IMPLEMENTATION ISSUES.....	135
9.0	REFERENCES.....	138

LIST OF TABLES

Table 2-1	Application of Shaw Bioaugmentation Cultures at Federally-Owned Facilities
Table 3-1	Performance Objectives
Table 5-1	Demonstration Schedule & Operation Summary
Table 5-2	Summary of Direct-Push Investigation Soil Analytical Data
Table 5-3	Summary of Direct-Push Investigation Groundwater Analytical Data
Table 5-4	Summary of As-Built Well Construction Details
Table 5-5	Summary of Slug Testing Analysis Data
Table 5-6	Summary of Pump Testing Analysis Data
Table 5-7	Summary of Demonstration Sampling Locations and Parameters
Table 5-8	Summary of Laboratory Analytical Data
Table 5-9	Summary of Laboratory DHC Data
Table 5-10	Summary of Field Parameter Data

Table 5-11	Baseline Groundwater Elevations, November 7, 2007
Table 5-12	Analytical Methods for Sample Analysis
Table 5-13	Summary of Groundwater Sample Quantities
Table 7-1	Demonstration Cost Components
Table 7-2	Cost Components for In Situ Bioaugmentation with Groundwater Recirculation
Table 7-3	Cost Components for In Situ Biostimulation with Groundwater Recirculation
Table 7-4	Cost Components for Pump and Treat
Table 7-5	Summary of Passive Bioremediation Cost Comparison

LIST OF FIGURES

Figure 2-1	Anaerobic Degradation Pathway for Chlorinated Ethenes
Figure 2-2	Bioaugmentation Process
Figure 4-1	Site Location Map
Figure 4-2	Location of Bioaugmentation Field Demonstration
Figure 4-3	Conceptual Site Model Cross Section
Figure 4-4	TCE Concentration Contours in Kirkwood Formation
Figure 4-5	cis-1,2-DCE Concentration Contours in Kirkwood Formation
Figure 5-1	Field Demonstration Schedule
Figure 5-2	Geoprobe [®] Sampling Locations
Figure 5-3	Geologic Cross Section A-A', Geoprobe [®] Investigation
Figure 5-4	Geologic Cross Section B-B', Demonstration Area Pump Test
Figure 5-5	Demonstration Well Layout
Figure 5-6	Baseline Chlorinated Ethene Concentrations
Figure 5-7	Geologic Cross Section of Loop 3
Figure 5-8	Potentiometric Surface Contours for the Kirkwood Aquifer, Baseline Conditions– November 7, 2007
Figure 5-9	Schematic of Column Apparatus used in Laboratory Testing
Figure 5-10	Results of the Laboratory Column Testing
Figure 5-11	Particle Tracking Simulation
Figure 5-12	Photograph of 20-foot and 40-foot Conex Boxes
Figure 5-13	Generalized System PI&D (figures a & b)
Figure 5-14	Photograph of Injection Well Connections
Figure 5-15	Photograph of PLC Cabinet

- Figure 5-16 Photograph of SCADA System Main Screen
- Figure 5-17 Photograph of Lactate Metering Pumps
- Figure 5-18 Photograph of Buffer Tanks in 40-foot Conex Box
- Figure 5-19 Photograph of Amendment Injection Rack
- Figure 5-20 Potentiometric Surface Contours For The Kirkwood Aquifer, Operational Conditions–November 20, 2007
- Figure 5-21 Tracer Concentrations, Kirkwood Aquifer, January 3, 2008
- Figure 5-22 Bromide Concentrations: Loop 3, December 4, 2007
- Figure 5-23 Chlorinated Ethene Concentrations, January 5, 2009
- Figure 5-24 Ethene Concentrations, January 5, 2009
- Figure 6-1 Ethenes and DHC Concentrations Plotted as a Function of Time for Loop 1
- Figure 6-2 Ethenes and DHC Concentrations Plotted as a Function of Time for Loop 3
- Figure 6-3 Model Simulations of Cell Dosage Affects on Treatment of TCE in Loop 3
- Figure 6-4 Model Simulations of Cell Dosage Affects on Treatment of TCE in Biobarrier Applications

LIST OF APPENDICES

- Appendix A Points of Contact
- Appendix B ESTCP/SERDP Chapter
- Appendix C Publication: “Bioaugmentation for chlorinated ethenes using *Dehalococcoides* sp.: Comparison between batch and column experiments”. *Chemosphere*, 2009.
- Appendix D Publication: “Large-scale production of bacterial consortia for remediation of chlorinated solvent-contaminated groundwater”. *Journal of Industrial Microbiol Biotechnology*, in press, 2009.
- Appendix E Submitted for publication: “Field Scale Evaluation of Bioaugmentation Dosage for Treating Chlorinated Ethenes”.
- Appendix F Slug Testing and Pump Testing Analysis
- Appendix G NJDEP Permit-by-Rule Application and Approval Letters
- Appendix H Quality Assurance Project Plan (QAPP)
- Appendix I Chlorinated Ethenes, Ethene and DHC Trend Graphs
- Appendix J Summary of DHC Replicate Sample Data: Georgia Institute of Technology

ABBREVIATIONS AND ACRONYMS

AFP4	Air Force Plant 4 (Fort Worth, TX)
bgs	below ground surface
BMW	Bioaugmentation monitoring well
CERCLA	Comprehensive Environmental Response Compensation and Liability Act
cm	centimeters
COC	Chain of custody
CVOCs	Chlorinated volatile organic compounds
cDCE	cis-1,2-dichloroethene
DHC	<i>Dehalococcoides</i> sp.
DGW	Discharge to Groundwater (permit)
DoD	United States Department of Defense
DOE	United States Department of Energy
DOT	United States Department of Transportation
EPA	Environmental Protection Agency
ESTCP	Environmental Security Technology Certification Program
EW	Extraction well
ft	feet
g	grams
GFPR/PBC	Guaranteed Fixed Price Remediation/Performance Based Contract
GP	Geoprobe®
gpm	gallon per minute
GWQS	Ground Water Quality Standards
HASP	Health and Safety Plan
hr	hour
HSA	Hollow stem auger
IDW	Investigation Derived Waste
IW	Injection well
JSA	Job safety analysis
L	Liter
µg/L	micrograms per liter
mg/L	milligrams per liter
mL	milliliters
MAG-1	Magazine 1 Area, Fort Dix, NJ
MSL	Mean sea level
MW	Monitoring well
mV	millivolts
N.J.A.C.	New Jersey Administrative Code
NJDEP	New Jersey Department of Environmental Protection
NTU	Nephelometric Turbidity Units
ORP	Oxidation-reduction potential
PCE	Tetrachloroethene
PCR	Polymerase chain reaction
pH	activity of hydrogens
P&ID	Piping & Instrumentation Diagram

P&T	Pump & Treat
PID	Photo-ionization detector
PPE	Personal protective equipment
ppm	Parts per million
PQL	Practical Quantitation Level
PVC	Polyvinyl chloride
QA/QC	Quality Assurance/Quality Control
qPCR	Quantitative polymerase chain reaction
RCRA	Resource Conservation and Recovery Act
SDC-9	Shaw Dechlorinating Consortium
SERDP	Strategic Environmental Research and Development Program
SOP	Standard Operating Procedure
TCE	Trichloroethene
THPS	Tetrakis (hydroxymethyl)phosphonium sulfate
USEPA	United States Environmental Protection Agency
USGS	United States Geological Survey
VC	Vinyl chloride
VFA	Volatile fatty acid
VOC	Volatile organic carbon

ACKNOWLEDGMENTS

This demonstration was entirely funded by the Department of Defense's (DoD) Environmental Security Technology Certification Program (ESTCP). We thank William Lewendoski, Kenneth Smith and Stephen Whitmore of Ft. Dix for providing site access and oversight of this project and Dr. Nancy Ruiz of Naval Facilities Command Engineering Service Center (NAVFAC ESC), Restoration Development Branch, for serving as COR. We also are grateful to Dr. Kirsti M. Ritalahti and Dr. Frank E. Löffler of Georgia Institute of Technology for providing valuable PCR analysis of site samples. Finally, we thank the large number of support, field, and laboratory staff of Shaw Environmental, Inc. who supported and/or participated in this work. Any opinions, findings and conclusions or recommendations expressed in this material are those of the authors and do not necessarily reflect those of ESTCP or the U.S. Army Corp. of Engineers, Humphreys Engineer Center Support Activity.

EXECUTIVE SUMMARY

BACKGROUND

The application of bioaugmentation technology has the potential to reduce both the time and cost associated with remediating groundwater contaminated with chlorinated volatile organic compounds (CVOCs), and it has become widely used as an *in situ* treatment alternative. The primary goals of this field demonstration were to evaluate the amount of *Dehalococcoides* sp. (DHC)-containing bacterial culture needed to effectively remediate a CVOC-contaminated plume, and to determine the effect of inoculum dose on remedial time. In addition, because of the low natural pH at the demonstration site, the ability to increase and maintain an elevated pH sufficient for successful bioremediation by adding buffers was evaluated.

A chlorinated ethene groundwater plume present in the MAG-1 Area at Fort Dix, New Jersey was selected for the field demonstration component of this project. Bioaugmentation using Shaw's SDC-9 DHC-containing culture was performed in three separate groundwater recirculation loops, with one loop bioaugmented with 1 L of culture, the second loop bioaugmented with 10 L of culture, and the third loop bioaugmented with 100 L of culture. A fourth "control" loop was not bioaugmented. Groundwater monitoring was performed to evaluate *Dehalococcoides* (DHC) growth and migration, dechlorination kinetics, and aquifer geochemistry.

The results of the demonstration were used to develop, evaluate and refine a one-dimensional bioaugmentation fate and transport screening model. The model developed during this project provided a reasonable prediction of the data generated during the field demonstration. The ability to predict results suggests that modeling potentially can serve as an effective tool for determining bioaugmentation dosage and predicting overall remedial timeframes, thus providing the Department of Defense (DoD) with more efficient and less expensive approaches for treating CVOC contaminated groundwater. The results of the demonstration also were used to assist SERDP and ESTCP in the production Remediation Technology Monograph on bioaugmentation.

OBJECTIVES OF THE DEMONSTRATION

Primary objectives of the field demonstration were to evaluate the amount of culture needed to effectively remediate a CVOC-contaminated plume, to determine the affect of inoculum dose on remedial time, to evaluate the affect of site characteristics on the effectiveness of the technology, and to evaluate the ability to increase and maintain an elevated pH for successful bioremediation.

A secondary objective of this work was to evaluate and describe methodology for isolation, production, storage, and distribution of DHC-containing cultures suitable for field scale applications. This work has been published in the scientific literature and prepared as a chapter for publication in an upcoming SERDP/ESTCP-sponsored monograph on bioaugmentation for remediation of chlorinated solvents.

DEMONSTRATION RESULTS

The results of this project demonstrated that CVOC-contaminated aquifers can be effectively remediated by using active groundwater recirculation, bioaugmentation with Shaw's SDC-9 consortium, and pH adjustment. Results of this field demonstration have provided a detailed evaluation of the use of a groundwater recirculation design for the distribution of groundwater amendments (including a Trichloroethene [TCE]-degrading microbial culture), use of buffering agents to control *in situ* pH, and an application model to allow practitioners to plan bioaugmentation applications and predict their performance. As such, critical design and implementation issues regarding microbial dosage requirements, remedial timeframes, and system optimization have been addressed and are being made available to environmental professionals and stakeholders.

Results for the loops inoculated with 1 L and 100 L of culture showed similar rates of dechlorination. TCE concentrations in the test loop performance monitoring wells declined significantly during the demonstration, with TCE decreases in these wells ranging from 90 to 100 percent. *cis*-1,2-dichloroethene (cDCE) concentrations in test loop performance monitoring wells declined between 73 and 99 percent, and were generally trending downward at the end of the demonstration period, while cDCE concentrations in the control loop increased during the demonstration. Transient increases (followed by decreases) in VC were observed in 5 of the six test loop performance wells, with VC in 2 of the wells below detection at the end of the demonstration. VC was not observed in the control loop monitoring wells. Ethene data collected during the demonstration clearly indicated that complete degradation was occurring within the 3 test loops that were bioaugmented with SDC-9, and not within the control loop that received only electron donor, buffer and nutrients. Final DHC concentrations in these two test loops ranged from 1.8×10^7 to 2.0×10^9 cells/liter. The greatest down-gradient DHC concentrations were achieved in the test loop with the greater level of CVOC contamination, rather than the loop with the greatest inoculation.

Results of this demonstration also showed that many factors including groundwater flow velocity, contaminant concentration, groundwater chemistry, and heterogeneity of the subsurface can affect the amount of culture needed to effectively treat CVOC-contaminated aquifers. As a result, precisely determining the amount of culture needed for a given site still requires a site-by-site evaluation. The amount of culture needed cannot be reliably determined solely by estimating the volume of water to be treated, which is currently the approach commonly used by culture vendors. In this demonstration, significantly different amounts of DHC-containing culture were added to the test treatment loops, but the final treatment results were comparable. The lowest amount of culture, however, was added in a treatment loop with the greatest VOC concentration and *in situ* growth of the culture aided in distribution of DHC and efficient treatment of the aquifer. Conversely, the greater amount of culture was added in a treatment loop with lower CVOC concentrations, and growth of the added culture was limited by the rapid degradation of the needed electron acceptors (i.e., CVOCs); distribution of the culture was presumably dominated by transport of the added culture. Ultimately, distributed DHC concentrations in both treatment loops were similar, and in both loops treatment was effective. The loop inoculated with 10 L of culture showed slower dechlorination kinetics and DHC

migration/growth compared to the other two test loops due to persistent low pH conditions that were not adequately adjusted by adding buffer.

Because the results of this study demonstrated that many factors affect the amount of culture needed for effective treatment, and that selecting the amount of culture needed cannot reliably be based solely on the amount of groundwater to be treated, we developed a 1-dimensional model to aid practitioners in determining the amount of culture needed. Importantly, the 1-dimensional model reasonably described the results of the demonstration. Consequently, the model appears suitable for evaluating the effect of different DHC dosages on treatment times and effectiveness, and it will be a useful design tool for planning bioaugmentation applications. A significant component of its use, however, is the need to determine the attachment-detachment factor (f) which varies based on aquifer geochemistry, hydrology and soil texture. Work is ongoing to allow up-front estimates of this factor based on analysis of site samples. Currently, however, this factor (f) must be determined by performing laboratory column testing, or by the careful analysis of field pilot test results. To make the model more accessible to remediation practitioners, it is currently being incorporated in to a widely used fate and transport model package, and it will be widely available in the near future.

IMPLEMENTATION ISSUES

The two major challenges encountered during the demonstration were pH adjustment of the aquifer, and injection well fouling. pH adjustment, however, may not be required during most applications provided the aquifer has sufficient natural buffering capacity. Well fouling typically is of less concern during passive or semi-active application of the technology, and it may be reduced in aquifers that do not require extensive buffer addition or by using an improved injection well design.

In addition, as observed during performance of model simulations, a DHC attachment-detachment factor plays a significant role in determining the relative importance of DHC dosage on bioaugmentation kinetics (Schaefer et al., 2009). Thus, the impact of DHC dosage on bioaugmentation performance likely will need to be evaluated on a site-by-site basis. However, the model developed during this project can assist in predicting the affect of different cell dosages on *in situ* performance of the cultures.

1.0 INTRODUCTION

The application of bioaugmentation technology has the potential to reduce both the time and cost associated with remediating groundwater contaminated with chlorinated volatile organic compounds (CVOCs). The primary goals of this field demonstration, funded by the Environmental Security Technology Certification Program (ESTCP) were to evaluate the amount of bacterial culture needed to effectively remediate a CVOC-contaminated plume, and to determine the effect of inoculum dose on remedial time. The field demonstration involved the construction and operation of four groundwater recirculation loops, three of which were inoculated with a different amount of Shaw's SDC-9 dechlorinating culture. CVOC biodegradation and growth of the added organisms were monitored. In addition, because of the low natural pH at the site, the ability to increase and maintain an elevated pH sufficient for successful bioremediation by adding buffers was evaluated.

The demonstration project was performed by Shaw Environmental, Inc. (Shaw) at the Magazine 1 (MAG-1) Area at Fort Dix, New Jersey (the Site), in accordance with the *Draft Field Demonstration Plan for Bioaugmentation for Groundwater Remediation* (Demonstration Plan), dated January, 2007. Shaw has prepared this Bioaugmentation for Groundwater Remediation Final Report (Final Report) to detail the system design, construction and operation, and groundwater monitoring results for the demonstration, as well as the applicability of this technology for full scale treatment of CVOC contaminated groundwater at this and other Sites. The results of the demonstration were also used to validate a bioaugmentation treatment model, and to assist the United States Department of Defense (DoD) in the production of a bioaugmentation guidance document. Points of contact involved in the demonstration, including investigators and sponsors are provided in **Appendix A**.

1.1 BACKGROUND

Chlorinated volatile organic compounds (CVOCs) have been used extensively as industrial solvents and cleaning agents at several DoD, United States Department of Energy (DOE), and private sector facilities. This widespread use, in addition to improper disposal practices and the chemical properties and stability of CVOCs, have led to them becoming common groundwater contaminants. They are also the primary pollutants at many Superfund sites (Westrick et al., 1984).

Bioremediation applications have been applied *in situ* at many DoD facilities. As the result of the widespread occurrence of chlorinated solvent contamination, a number of treatment technologies, including anaerobic bioaugmentation, have emerged and evolved. Although bioaugmentation is gaining acceptance as a remedial technology, and despite the fact that continuing field demonstration of the technology is producing useful data to aid in the maturation of the technology, critical questions exist that can only be answered by careful laboratory research and multi-condition science-based field demonstrations.

One key question addressed during this demonstration is how many organisms must be added to a site for successful application of the technology. The amount of microorganisms needed depends upon contaminant concentrations, site hydrogeochemical conditions, competition by

indigenous microorganisms, the relative concentration of *Dehalococcoides* sp. (DHC) in the bioaugmentation culture, *in situ* growth, transport and decay of the bioaugmented culture, and various other site-specific factors including access and shipping costs. Answers to these questions were explored through laboratory studies with site samples, and by field testing the SDC-9 culture under a range of concentrations to determine a minimum required concentration. This field-scale demonstration also allowed assessment of delivery methods, distribution of the cultures *in situ*, and survival and growth of the culture in the subsurface.

At Fort Dix, New Jersey a chlorinated ethene groundwater plume present in the MAG-1 Area was selected for the field demonstration component of this project during which we evaluated the effect of bacterial dosing on dechlorination kinetics and microbial distribution. The results of the demonstration were used to develop, evaluate and refine a one-dimensional bioaugmentation fate and transport screening model (Schaefer et al., 2009). The model developed during this project provided a reasonable prediction of the data generated during the field demonstration. The ability to predict results suggests that modeling potentially can serve as an effective tool for determining bioaugmentation dosage and predicting overall remedial timeframes, thus providing the DoD with more efficient and less expensive approaches for treating CVOC contaminated groundwater.

1.2 OBJECTIVE OF THE DEMONSTRATION

Primary objectives of the pilot-scale field demonstration were to evaluate the amount of culture needed to effectively remediate a CVOC-contaminated plume, to determine the effect of inoculum dose on remedial time, and to evaluate the affect of site characteristics on the effectiveness of the technology. Implementation of the bioaugmentation field demonstration, along with development of a corresponding bioaugmentation application model, will be beneficial to the entire DoD and DOE stakeholder community, as well as to those responsible for remediation efforts at commercial sites. Specifically, results of this field demonstration have provided a detailed evaluation of the use of a groundwater recirculation design for the distribution of groundwater amendments (including a Trichloroethene [TCE]-degrading microbial culture), use of buffering agents to control *in situ* pH, and an application model to allow practitioners to plan bioaugmentation applications and predict their performance. As such, critical design and implementation issues regarding microbial dosage requirements, remedial timeframes, and system optimization have been addressed and are being made available to environmental professionals and stakeholders. As an added benefit, the field demonstration performed at the Fort Dix MAG-1 site has provided site-specific information needed to optimize the design and implementation of the full scale remedial system that is currently planned for treatment of the MAG-1 TCE-contaminated groundwater plume.

A secondary objective of this work was to evaluate and describe methodology for isolation, production, storage, and distribution of DHC-containing cultures suitable for field scale applications. This work has been published in the scientific literature (Vainberg et al., 2009) and prepared as a chapter for publication in an upcoming SERDP/ESTCP-sponsored volume on bioaugmentation for remediation of chlorinated solvents (SERDP/ESTCP/2009; **APPENDIX B**).

1.3 REGULATORY DRIVERS

The main contaminants of concern in the MAG-1 groundwater plume, the site of the demonstration, are trichloroethene (TCE) and *cis*-1,2-dichloroethene (cDCE). TCE is a suspected carcinogen, with a current Federal Drinking Water Standard of 5 microgram per liter ($\mu\text{g/L}$). The current Federal Drinking Water Standard for cDCE is 70 $\mu\text{g/L}$ (EPA, 2009).

The New Jersey Department of Environmental Protection (NJDEP) is the lead Agency for most Fort Dix restoration activities including the MAG-1 Area, with some review by United States Environmental Protection Agency (USEPA). In the State of New Jersey, groundwater cleanup standards protective of groundwater classifications are based on the primary receptors within that class as established pursuant to the New Jersey Ground Water Quality Standards (GWQS) (NJDEP, 2008). As such, NJDEP has established natural groundwater quality as the cleanup standard for all contaminants in Class IA and I-Pinelands (Preservation Area) groundwater, which includes the groundwater at Fort Dix. The numerical criterion for any organic contaminant discovered at a contaminated site that is not the result of natural processes is zero. Since zero can only be measured with a certain degree of certainty, the Practical Quantitation Levels (PQLs) for groundwater have been selected for use in determining whether organic contaminant concentrations observed in groundwater meet the groundwater standard/criteria. Based upon the New Jersey criteria the groundwater standard for TCE is 1 $\mu\text{g/L}$ and cDCE is 2 $\mu\text{g/L}$ (NJDEP, 2008).

2.0 TECHNOLOGY

Bioaugmentation, which consists of adding exogenous microorganisms to enhance degradation of contaminants, has been utilized as a treatment technology in various settings over the past 10 years. In the case of chlorinated ethene remediation, the most accepted form of bioaugmentation involves the use of mixed anaerobic cultures containing DHC that can reductively dechlorinate the chlorinated ethenes. Compared to conventional technologies such as pump-and-treat and air sparging/soil vapor extraction, bioaugmentation using DHC is a relatively new technology, but it has now been successfully implemented at many sites throughout the United States and elsewhere. Currently, bioaugmentation cultures are being marketed by several vendors, but many questions remain about the technology, limiting its selection by site managers as a valid treatment alternative. Key questions include the extent of distribution of microbial amendments in the subsurface, the rate of growth of these microbial amendments, and uncertainties about the required amendment dosages. Many of these questions have been addressed and answered through laboratory studies and field demonstration performed during this project. This work was built on ESTCP-supported work, both past and present, performed in the area of chlorinated solvent biodegradation and bioaugmentation.

2.1 TECHNOLOGY DESCRIPTION

The predominant biodegradation pathway for chlorinated ethenes under anaerobic conditions is via microbial-mediated reductive dechlorination. During reductive dechlorination, chlorinated ethenes are used as electron acceptors, not as a source of carbon, and a chlorine atom on the ethene backbone is removed and replaced with a hydrogen atom (McCarty, 1997). Sequential dechlorination of tetrachloroethene (PCE) proceeds to TCE, *cis*-1,2-dichloroethene (cDCE), vinyl chloride (VC), and innocuous ethene. **Figure 2-1** presents published pathways for the anaerobic degradation of chlorinated ethenes. Because the chlorinated ethenes are used as electron acceptors during reductive dechlorination, there must be an appropriate source of electrons and a carbon source for microbial growth in order for this process to occur (Bouwer, 1994). Potential carbon and electron sources include natural organic matter, fuel hydrocarbons, or other anthropogenic organic compounds such as lactate, molasses, or vegetable oil. The actual electron donor for reductive dechlorination is molecular hydrogen. The added carbon sources, therefore, must first be fermented via a pathway that yields hydrogen by other organisms in the environment or consortium. Incomplete reductive dechlorination often results in an accumulation of cDCE and VC, indicating that the carbon source is depleted and/or that microorganisms capable of complete anaerobic reductive dechlorination are not present.

Figure 2-1. Anaerobic Degradation Pathway for Chlorinated Ethenes

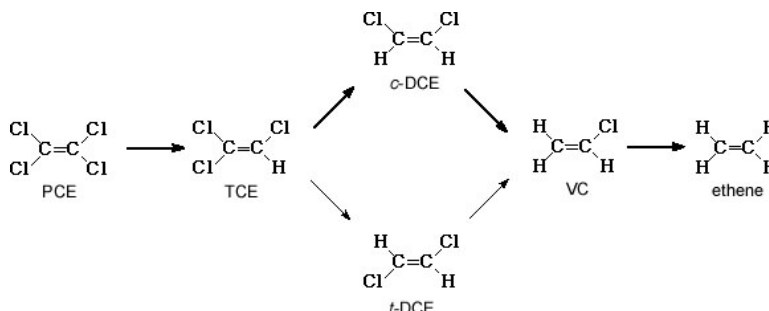

Reductive dechlorination may occur by either of two distinct processes: cometabolic reductive dechlorination or halorespiration. Cometabolic reductive dechlorination is a relatively slow process whereby chlorinated ethenes are gratuitously degraded during the anaerobic biodegradation of other organic compounds under sulfate-reducing or methanogenic conditions. Halorespiration is a much more rapid form of reductive dechlorination whereby the chlorinated contaminant is used as a terminal respiratory electron acceptor (McCarty, 1997). A carbon source is fermented yielding hydrogen in the process. The energy generated during the process is used to convert simple carbon sources, most notably acetate, into cellular biomass. DHC species within the SDC-9TM bioaugmentation culture are able to respire chlorinated ethenes, including cDCE and VC, as indicated by their ability to grow effectively on these compounds (Schaefer et al., 2009; Vainberg et al., 2009). In aquifers without natural DHC populations like those in SDC-9TM, CVOC metabolites like cDCE and VC, which are more toxic than PCE and TCE, can accumulate resulting in what is termed a “DCE stall” or “VC stall”.

While many dechlorinating microorganisms have been isolated, only one group, DHC, is capable of completely dechlorinating PCE and TCE to ethene. Few pure *Dehalococcoides* cultures have been isolated. *Dehalococcoides ethenogenes* strain 195 can dehalogenate PCE and TCE completely, but it can not utilize VC as a growth substrate. Rather, it cometabolizes VC only when reductive dechlorination of PCE or TCE is occurring (Maymo-Gatell et al., 1997; 2001). Yet another strain, BAV1, is able to metabolize VC to ethene, but it does not reduce higher chlorinated compounds like PCE and TCE (He et al., 2003). The dechlorinating consortium used in this study, SDC-9TM, utilizes PCE, TCE, cDCE, and VC as growth substrates (Schaefer et al., 2009; Vainberg et al., 2009). DHC-like microbes are not ubiquitous at all sites contaminated with chlorinated ethenes, and not all populations within the DHC group are capable of performing the same physiological activities (He et al., 2003).

The role of DHC in bioremediation was further documented by Hendrickson et al., (2002) who conducted a survey of multiple chlorinated ethene contaminated sites using a 16S rRNA gene molecular detection method. The results indicated that complete reductive dechlorination of chlorinated ethenes *in situ* strongly correlates with the presence of DHC and DHC-like strains. The sites lacking these microorganisms exhibited incomplete dechlorination of PCE and TCE, and often had an accumulation of cDCE and VC. Several stable, natural microbial consortia containing DHC have been isolated that are capable of fully dechlorinating TCE to ethene via halorespiration (Hendrickson et al., 2002, Lendvay et al., 2003, Major et al., 2002, Schaefer et al., 2009), and some of these have been tested in pilot-scale projects.

Key design criteria for applying bioaugmentation for remediating chlorinated ethene-contaminated sites include identification of a microbial culture, large-scale growth of the culture, injection the culture, and distribution optimization. A schematic of the bioaugmentation process is provided in **Figure 2-2**. The first step is to identify a microbial culture that contains a DHC strain capable of complete reductive dechlorination of the target contaminants to ethene. The bioaugmentation culture can either be obtained from a site exhibiting complete reductive dechlorination via a laboratory enrichment process, or an exogenous consortium can be identified from qualified vendors. A small amount of the selected microbial culture is then grown to the target concentration and required culture volume (Vainberg et al., 2009). The

enriched and grown culture is tested to ensure complete reductive dechlorination activity and desired cell density, and shipped to the site. At the site, the bioaugmentation culture is injected into the subsurface via injection wells or by using direct push injection points. Distribution of the bioaugmented culture is achieved using either groundwater recirculation or ambient groundwater flow. A carbon source is typically added prior to bioaugmentation or with the bioaugmentation culture in order to promote and maintain the highly reducing, anaerobic conditions and to supply carbon and H₂ needed for *in situ* growth of DHC and degradation of chlorinated ethenes.

Figure 2-2. Bioaugmentation Process

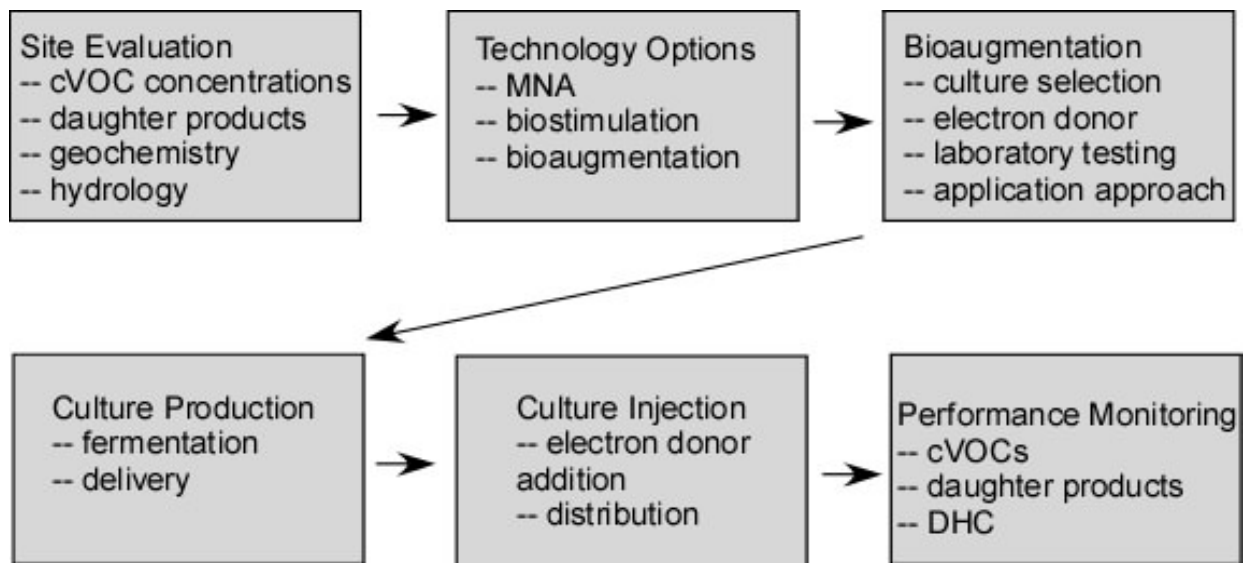

Bioaugmentation is applicable to sites where adequate microbial populations are absent, as well as to sites where relatively rapid cleanup times are desired. Bioaugmentation can accelerate the reductive dechlorination process and provide dechlorinating microorganisms to areas not populated with native DHC microorganisms. It also can accelerate the rate of reductive dechlorination even if native microorganisms capable of dehalogenation are present. Although bioaugmentation has demonstrated complete reductive dechlorination of PCE and TCE to ethene at sites where DHC populations are sparse or non-existent, successful bioaugmentation requires adequate distribution of the added bacteria within the treatment zone and favorable groundwater conditions for the growth and activity of the microorganisms.

Bioaugmentation cultures are actively marketed by several bacterial culture vendors, thus multiple microbial cultures for anaerobic bioaugmentation are commercially available. A recent study by MACTEC, Inc. and researchers from Clemson University evaluated three commercially available cultures for their ability to degrade PCE and its reductive dechlorination daughter products (Cashwell et al., 2004). The cultures each degraded PCE and all of its daughter products to ethene at approximately the same apparent rate, and they each responded rapidly to multiple additions of cDCE. The researchers also calculated the ratio of degradation rates to protein concentrations for each of the three cultures. The results suggest that the activity of a particular culture does not necessarily correlate with cell density, as the concentration of DHC to

non-DHC microorganisms in the cultures varied considerably. Since the specific activity of different batches of culture may vary significantly, a higher cell density (i.e. more biomass) may be needed with some cultures to achieve the same degradation rate. Further research confirmed that the degradation rates did not directly correlate with the amount of culture added. Therefore, the commercially available cultures cannot be compared on a volumetric basis, and further work, like that performed here, is needed to determine how much culture is really needed to treat actual field sites.

2.1.1 Previous Testing of the Technology

The first field demonstration of pilot-scale *in situ* bioaugmentation with DHC was conducted by the Remediation Technologies Development Forum at Dover Air Force Base, Delaware (Ellis et al., 2000). Prior to bioaugmentation, the selected pilot-test area was amended with 100 milligrams per liter (mg/L) lactate to enhance the anaerobic reductive dechlorination of TCE and cDCE to ethene. Initial results after 269 days confirmed previous laboratory work that dechlorination did not occur beyond cDCE. Following this 269 day period, a microbial consortium containing DHC enriched from soil and groundwater samples from the DOEs Pinellas site in Largo, Florida was injected into the pilot-test area. After a 90-day lag period, VC and ethene began to appear in select monitoring wells. The activity of the dechlorinating microorganisms increased with time and spread across the pilot-test area. Approximately 250 days following bioaugmentation, TCE and cDCE within the pilot-test area had undergone complete reductive dechlorination to ethene (Ellis et al., 2000). The Pinellas culture used in the Dover Air Force Base pilot study has been distributed by Terra Systems, Inc. of Wilmington, DE. (www.terrasystems.net).

A microcosm study and pilot-scale field test was conducted at Kelly Air Force Base in Texas (Major et al., 2002). Prior to bioaugmentation, laboratory microcosm testing was performed using site soil and groundwater. The microcosms were amended with lactate or methanol, and inoculated with a microbial consortium capable of complete dechlorination to confirm complete degradation. The pilot test area was amended with methanol and acetate to establish reducing conditions and then injected with 13 L of the bioaugmentation culture. Within 200 days, the concentrations of PCE, TCE, and cDCE were reduced to below 5 µg/L and ethene production accounted for the observed loss in mass. The bioaugmentation culture used at Kelly Air Force, known as KB-1, is marketed by SiREM and has reportedly been injected into the subsurface at more than 100 sites (www.siremlab.com).

A pilot study at the Bachman Road site in Michigan demonstrated that bioaugmentation was successful in reducing cleanup times at a site which had indigenous DHC populations capable of complete reductive dechlorination to ethene (Lendvay et al., 2003). A comparison of biostimulation and bioaugmentation were performed using recirculation loops injected with sodium lactate, nutrients, and an enriched microbial consortia containing DHC (in the bioaugmentation loop only). Results from the pilot study indicated complete dechlorination of the chlorinated ethenes to ethene within six weeks in the bioaugmentation loop, and complete dechlorination to ethene following a three month lag in the biostimulation loop. Real time quantitative polymerase chain reaction (qPCR) analysis results indicated that DHC populations increased 3-4 orders of magnitude in the bioaugmentation loop and at a slower rate in the

biostimulation loop. The Bachman Road culture has been sold under the Bio-Dechlor INOCULUM label by Regenesis. According to Regenesis, Bio-Dechlor INOCULUM has been used at >30 sites (www.regenesis.com). BC2, a bioaugmentation culture marketed by Bioaug LLC, is also believed to be an enrichment of the Bachman Road culture.

In a recent bioaugmentation application by Shaw at Naval Station Treasure Island in San Francisco, California, a dechlorinating culture was grown to a high cell density ($>4 \times 10^6$ cells DHC per mL) in a 750-L fermentor and injected into a recirculation loop at the site. PCE, TCE, and cDCE concentrations in the treated aquifer decreased from approximately 20 mg/L to below detection in about 70 days. DCE and VC produced from PCE and TCE were also degraded rapidly (180 days) in the bioaugmentation test plot. Less biodegradation was observed in the test plot that received only lactate. The enriched culture used by Shaw at Treasure Island is marketed as SDC-9TM, and was enriched from a contaminant plume at Naval Air Station North Island, in San Diego, California. SDC-9 and has now been used for bioaugmentation at more than 195 sites, and it is marketed by 6 distributors under a variety of trade names. Shaw also markets dechlorinating cultures called Hawaii-05TM for use in the Hawaiian Islands and PJKSTM that was isolated for use in high TDS aquifers (Vainberg et al., 2009). **Table 2-1** provides a list of some of the federally-owned facilities where these three cultures have been used.

2.1.2 Factors Affecting Cost and Performance

The amount of microorganisms needed to treat a site directly affects both the cost and performance of a remedial activity. The amount of microorganisms needed depends upon contaminant concentrations, site hydrogeochemical conditions, competition by indigenous microorganisms, the relative concentration of DHC in the bioaugmentation culture, *in situ* growth, transport, and decay of the bioaugmented culture, and various other site-specific factors including access and shipping costs. In addition, the cost of the bioaugmentation culture is based on vendor selection, as commercially available cultures vary significantly in price, DHC concentration and activity. Several field-related factors have been discussed previously (Lee et al., 1998).

The only available guidance on the amount of DHC needed was presented in a recent paper by Lu and colleagues (2006) who evaluated 8 sites to determine the amount of DHC needed to achieve reasonable rates of remediation at field scale. Of the 8 sites evaluated, 2 served as controls because hydrogeochemical conditions were unfavorable for reductive dehalogenation; both sites were aerobic. For their analysis they defined a “generally useful” dechlorination rate as a rate necessary to reduce cVOC concentrations from 70 mg/L to 5 µg/L within 30 yrs (a rate constant of 0.32/yr). They then use the BIOCHLOR model to fit site data to a rate constant by using a trial and error process, and correlated DHC numbers in site groundwater to the fitted rate. Test sites with a “generally useful” rate of dechlorination of cDCE and VC (rate constant ≥ 0.3 /yr) had DHC densities greater than 10^7 DHC/L of groundwater. Although this data set was small, the results appear consistent with results where bioaugmentation led to DHC numbers $>10^7$ /L that were accompanied by measureable rates of dechlorination (Hood et al., 2008; Ellis et al., 2000; Lendvay et al., 2003; Major et al., 2002; Ritalati et al., 2005). Surprisingly, however, Röling (2007) analyzed the data provided by Lu et al. by using “metabolic control analysis” (MCA) and concluded that the flux reported by Lu and colleagues was not regulated by

**Table 2-1
Application of Shaw Bioaugmentation Cultures at Federally Owned Facilities**

Site Designation	Total VOCs (ppb)	Geology	Approx Surface Area (ft ²)	Approx. Saturated Thickness (ft)	Volume of Culture added (L)	Approx. time to significant degradation ¹	Electron Donor	Treatment Method
Air Force Plant 4: Building 181	50,000	silt and clay	8000	10	7.5	3 months	Veg oil	Passive: 12 injection wells
Air Force Plant 4: Building 181	DNAPL	Tight sands and clay	23,500	10	6	6 months	Lactate	Biowall - 4 permeate injection wells
Air Force Plant 4: Landfill 3	500	sand and silty sand	880	2	3	ongoing	Lactate	13 permeate injection wells
Camp Bullis	~ 2000	karst	47,250	5	7.5	6 months	Veg oil	Passive: 5 horizontal wells (~240 feet in length)
Columbus AFB: SS32	400	sand/gravel	275,870	20	539	6 months	Lactate / SRS	Passive: 442 injection points, grid pattern
Fort Dix: MAG-1 Area	200 - 1,500	silty sand	2,400	10	111	8 months	lactate	Recirculation: 4 injection wells, 4 extraction wells
Hickam AFB: CG-110	~800	volcanic sand and silt	10,600	15	60	< 34 days **	Sodium lactate	Passive: 15 direct injection locations
Hickam AFB: LF-05	~100,000	calcium carbonate sand	100	10	60	60 days	Sodium lactate	Passive: 2 injection wells
Moody AFB: FT-07	~10,000	sand/silt	8000	20	28.5	3-6 months	Sodium lactate	Passive: 57 gravity feed injection points
Moody AFB: SD-16 (east)	>100	sand/silt	156,000	10	17.7	3-6 months	Veg oil	Passive: 175 injection points
Moody AFB: SD-16 (west)	~ 1000	sand/silt	100,000	10	290	9-12 months	Veg oil	Passive: 110 injection points
Moody AFB: SS-38	>1000	sand/silt	400,000	10	92.5	<90 days	Sodium lactate	Recirculation: 700-ft horizontal wells: 1 injection, 1 extraction
Moody AFB: SS-39	>500	sand/silt	360,000	10	36	<3 months	Sodium lactate	Recirculation: 10 injection wells, 9 extraction wells
Myrtle Beach AFB	~200	silty sand	18750	2	351	pending	Lactoil	DPT injection grid to target 2-ft silty sand layer
Myrtle Beach AFB: Bldg. 505	900	sand with clay lenses	35,600	20	90	pending	Lactate / LactOil	76 DPT injection points in a grid pattern and aided by groundwater extraction
Myrtle Beach AFB: Bldg. 575	1000	sand and silty sand	27,067	2	104	ongoing	Lactoil	176 DPT injection points
Myrtle Beach AFB: FT-11	500	sand with clay lenses	65,000	10	~1000	6 months	Lactate / LactOil	4 large DPT injection points in a grid pattern and aided by groundwater extraction
Myrtle Beach AFB: FT-11	70 - 900	sand/silt	78,000	5	27.6	6 months	Sodium Lactate	Passive: 337 injection points
Myrtle Beach AFB: VMA Site	150	sand	5000	10	104	2-months	lactate	DPT injection grid to target 10-ft thick treatment zone
Naval Station Treasure Island: Site 21	~ 1,500	sand, silty sand and clay	37,500	20	60	90 days	Lactic acid	Passive: 45-1" diameter direct injection points
Naval Station Treasure Island: Site 21	~1,000	sand, silty sand and clay	25,000	12	60	60 days	WiClear Plus Lactic Acid	High pressure 32-1" diameter direct injection points
Naval Station Treasure Island: Site 24	~ 35,000	sand, silty sand and clay	350,000	25	60	90 days	Lactic acid	Recirculation: 19 injection, 27 extraction wells. 105 bio-barrier injection points
Naval Station Treasure Island: Site 24	~25,000	sand, silty sand and clay	10,500	25	6	75 days*	Sodium lactate	Recirculation: 3 injection 3 extraction wells.
Naval Station Treasure Island: Site 24 (extend. plume area, 2-3)	~1000	sand, silty sand and clay	220,000	25	40	ongoing	WiClear Plus Lactic Acid	Recirculation: 9 injection 13 extraction wells
Naval Station Treasure Island: Site 24 (source area)	~40,000	sand, silty sand and clay	8,000	25	20	ongoing	WiClear Plus Lactic Acid and LactOil	Recirculation: 2 injection 4 extraction wells
Naval Station Treasure Island: Site 24 (extended plume area, 1)	~2000	sand, silty sand and clay	80,000	25	15	ongoing	WiClear Plus Lactic Acid	Recirculation: 6 injection 7 extraction wells
Pearl Harbor Naval Base: Former Aiea Laundry Facility	~100	volcanic sand and silt	100	10	60	< 60 days	Sodium lactate and Veg oil and Vitamin B	Passive: 2 injection wells
Pearl Harbor Naval Base: Former Aiea Laundry Facility	~100	volcanic sand and silt	100	10	60	< 60 days	Sodium lactate and Veg oil and Vitamin B	Passive: 2 injection wells
PJKS: D-4	~700	crystalline fractured bedrock, gneiss	20,000	40	38	15 months	Sodium lactate and Restore 375	Passive: 6 injection wells
PJKS: EPL Full Scale	~8,600	sandstone	60,000	40	189	ongoing	Sodium lactate and Restore 375	Passive: 4 horizontal wells
PJKS: EPL Pilot Study	~3,600	sandstone	500	40	56	1 month	Sodium lactate and Restore 375	Passive: Three injection wells
PJKS: SCA North Full Scale	~1,600	sandstone	40,000	40	75	4 months	Sodium lactate and Restore 375	Passive: 2 horizontal wells
PJKS: SCA South Full Scale	~9,100	sandstone	35,000	40	151	ongoing	Sodium lactate and Restore 375	Passive: 4 horizontal wells
Pueblo Chemical Depot 14	~400	sand, silty sand	4,500	9	135	ongoing	Sodium lactate and SDC-9	Passive: 6 injection wells, 4 extraction wells
Pueblo Chemical Depot 58	~40	sand, silty sand, clay	4,000	8	55	ongoing	Sodium lactate and SDC-9	Direct push injections
Pueblo Chemical Depot (28/36/West)	~500	sand, silty sand, clay	10,000	11	12	ongoing	Sodium lactate and SDC-9	11 injection wells, 20 extraction wells, & 12 of both : Infiltration gallery (East Terrace)
Raritan Arsenal: Area 18C-Deep Zone	100 - 2,000	sand/silt	40,000	8	400	ongoing	Lactoil + lactate	Recirculation: 9 injection wells, 9 extraction wells
Raritan Arsenal: Area 18C-Shallow Zone	100 - 1,000	sand/silt	27,000	8	200	ongoing	Lactoil	Passive: 200 injection points
Vandenberg AFB	8,600	sand	70,000	7	720	ongoing	Sodium Lactate	Passive and Recirculation
Vandenberg AFB	15,000	sands/silty sands	10,000	10	180	ongoing	Sodium Lactate	direct-push injections
Vandenberg AFB: Site 9	~1,000	sand and silty sand	10,000	5	60	6 months	Sodium lactate	Passive: Injected in 10 monitoring wells.

¹ Operationally defined by project managers.

* Complete conversion of TCE to ethene by day 75

** Complete conversion of TCE to ethene by day 34

population size, but rather it was regulated at the cellular level (e.g., the specific activity of the cells). The MCA approach quantifies the control exerted by properties of individual components (pathway enzymes, enzyme kinetics, functional groups of organisms, inhibitory metabolites, etc.) upon system variables such as fluxes (flow of materials) and metabolite concentration. Thus, effective bioaugmentation relies on both achieving a sufficient population of dechlorinating organisms and the physiological condition of the dechlorinating organisms in the treatment environment. All these findings complicate the challenge of predicting the amount of DHC organisms that must be added to a target aquifer to achieve timely and cost effective remediation.

2.2 TECHNOLOGY DEVELOPMENT

The performance of bioaugmentation cultures in the subsurface is impacted by competing indigenous microbes, aquifer conditions including contaminant concentrations, and distribution of the bioaugmentation culture within the treatment zone. The current lack of knowledge regarding the specific amount of DHC-like microorganisms needed to effectively treat a site makes it difficult to accurately assess the cost of successfully implementing bioaugmentation. The data generated during this project will aid in the selection and costing of bioaugmentation in future projects by establishing criteria to estimate the required concentration and volume of microbial consortia containing DHC-like microorganisms.

During initial laboratory work performed during this project, studies were performed to evaluate SDC-9 dechlorination kinetics and microbial transport/growth. These data were used to develop a one-dimensional bioaugmentation fate and transport screening model for applying the technology in the field (Schaefer et al., 2009). Results of the studies also demonstrated that DHC dechlorination kinetics can be estimated based on measured aqueous phase DHC concentrations. Development and initial validation of the model is discussed in detail in **Appendix C**.

In addition, we evaluated the isolation and enrichment of dechlorinating bacterial cultures from target sites, and we developed and described a general method for large scale production of dehalogenating cultures (Vainberg et al., 2009). We also evaluated the suitability of cell concentration by membrane filtration to reduce the volume of such cultures to reduce shipping and storage costs, the stability of cultures stored for extended period prior to application at sites, and the affect of pH on dehalogenation by SDC-9. The enrichment culturing experiments demonstrated that new cultures can be isolated from contaminated sites and effectively grown in large volumes and to high cell density using the fermentation protocols developed during this project. The enrichment work resulted in the isolation of a culture from Hickam AFB in Hawaii, Hawaii-05TM, that is approved for use in the Hawaiian Islands, and a culture from Air Force Plant PJKS, Colorado that is suitable for use in high alkalinity and high TDS aquifers. Results of this work are presented in **Appendix D**.

2.3 ADVANTAGES AND LIMITATIONS OF THE TECHNOLOGY

The main advantages of anaerobic bioaugmentation with DHC are (1) complete reductive dechlorination of chlorinated ethenes to the innocuous by-product ethene, (2) reduced cleanup times, and (3) cost-effective remediation. In addition, bioaugmentation is a “green” and

“sustainable” technology that can be performed with renewable materials (lactate, soy oil, molasses, etc.) and with minimal energy consumption. It can be applied in a wide range of aquifers and can treat even very high concentrations of chlorinated solvents. As discussed in **Section 2.2**, this technology has now been successfully demonstrated at full-scale at multiple sites, and commercially available bioaugmentation cultures are now widely available from multiple vendors.

One potential limitation to bioaugmentation is that effective treatment is contingent upon adequate distribution of the degradative bacteria within the treatment area. Before implementing bioaugmentation, or any *in situ* technology, an evaluation is necessary to consider site-specific characteristics and to determine the most effective treatment technology based on current contaminant and hydrogeochemical conditions and site access. A second potential limitation for successful bioaugmentation is that unfavorable aquifer conditions such as low pH, low temperatures, elevated dissolved oxygen levels, or lack of adequate organic carbon may limit the activity of the bioaugmentation culture or necessitate additional treatments like pH adjustment or pre-treatment to reduce DO levels. In addition, excessively low concentrations of chlorinated ethenes may not provide a sufficient source of electron acceptors needed to support halorespiration, thereby limiting *in situ* growth of the added culture. Excessively high concentrations of chlorinated ethenes may have a toxic effect on the added DHC population, and the presence of some co-contaminants like chloroform (Duhamel et al., 2002) and chlorinated ethanes (Grostern and Edwards, 2006) may inhibit some dehalogenating cultures.

3.0 PERFORMANCE OBJECTIVES

Performance objectives were established for this demonstration to provide a basis for evaluating the performance and costs of anaerobic bioaugmentation. The primary performance objectives for this demonstration are summarized in **Table 3-1**.

Table 3-1. Performance Objectives

Performance Objective	Data Requirements	Success Criteria	Results
Quantitative Performance Objectives			
Determine the amount of SDC-9 culture required for effective remediation	Baseline, demonstration, and post-demonstration contaminant and DHC concentrations in groundwater	<ul style="list-style-type: none"> DHC concentrations $>10^7$ cells/liter at downgradient monitoring wells 	<ul style="list-style-type: none"> An effective 1-D model was developed for determining the amount of culture needed to effectively treat aquifers
Compare SDC-9 dechlorination to dechlorination in the presence of existing microorganisms only (biostimulation)	Baseline, demonstration, and post-demonstration contaminant and DHC concentrations in groundwater	<ul style="list-style-type: none"> Complete dechlorination of TCE and cis-1,2-DCE to ethene in the 3 SDC-9 test loops Slow or incomplete dechlorination of TCE and cis-1,2-DCE in control loop 	<ul style="list-style-type: none"> Ethene observed in all 3 test loops DHC concentrations orders of magnitude higher in test loops “DCE stall” observed in control loop
Effectively distribute electron donor throughout all 4 loops	VFA concentrations in groundwater during demonstration	<ul style="list-style-type: none"> VFA concentrations >5 mg/L at downgradient monitoring wells 	<ul style="list-style-type: none"> Objective fully achieved in all 4 demonstration loops
Adjust and maintain acceptable groundwater pH for dechlorination to occur	Baseline and demonstration field pH measurements	<ul style="list-style-type: none"> Increase and maintain groundwater pH levels between 5.5 and 8.0 standard units 	<ul style="list-style-type: none"> pH increased from ~4.5 to > 5.5 during most of demonstration Temporary drops in pH below 5.5 observed at some wells Spike in pH to $>pH 9$ occurred during pH adjustment efforts.
Determine remedial effectiveness of bioaugmentation with SDC-9	Baseline, demonstration, and post-demonstration contaminant concentrations in groundwater	<ul style="list-style-type: none"> $>90\%$ reduction of TCE and cis-1,2-DCE considered successful Complete dechlorination of TCE and cis-1,2-DCE to ethene 	<ul style="list-style-type: none"> 90-100% reduction of TCE, and 73-99% reduction of cis-1,2-DCE observed in test loops Ethene observed in all 3 test loops

As summarized in **Table 3-1**, the established performance objectives were generally met during the demonstration. The following subsections provide details for each of the above performance objectives, including what data were collected and to what extent the success criteria were met.

3.1 DHC DOSAGE COMPARISON

The key objective of this demonstration was to determine the DHC dosage required to effectively remediate a chlorinated-ethene contaminated site. Specifically, bioaugmentation using Shaw's SDC-9 DHC-containing culture was performed in three separate groundwater re-circulation loops, with one loop bioaugmented with 1 L of culture (5×10^5 DHC/L), the second loop bioaugmented with 10 L of culture (5×10^6 DHC/L), and the third loop bioaugmented with 100 L of culture (5×10^7 DHC/L). A fourth "control" loop was not bioaugmented. Groundwater monitoring was performed to evaluate DHC growth and transport, dechlorination kinetics, and aquifer geochemistry.

The loop inoculated with 10 L of culture showed slower dechlorination kinetics and DHC migration/growth compared to the other two test loops. This relatively poor performance was attributed to persistent low pH conditions that were not adequately controlled by adding buffer. Results for the loops inoculated with 1 L and 100 L of culture showed similar rates of dechlorination, as measured at a monitoring well approximately 10 feet downgradient of the DHC injection well (as well as the injection and extraction wells and other monitoring wells). Final DHC concentrations in these two test loops ranged from 1.8×10^7 to 2.0×10^9 cells/liter.

Because there was no apparent correlation between the cell dosage and *in situ* dechlorination during the demonstration, we developed a one-dimensional bioaugmentation fate and transport screening model to address the affects of *in situ* growth and transport properties on remediation activity (Schaefer et al., 2009; Appendix C). Specifically, the model incorporates Monod kinetic parameters that relate growth and dechlorination rates of the biocatalyst to contaminant concentration, and attachment and detachment of the catalyst which affect distribution of the bioaugmented culture. Based on results of the modeling, aquifers with higher contaminant concentration and sediments that allow detachment and transport of daughter cells of growing bacteria may require lower bioaugmentation dosages than aquifers with low contaminant concentrations or sediments that limit transport of daughter cells. Application of the model to the field demonstration results resulted in close fit between the experimental and simulation results (Schaefer et al., submitted; **Appendix E**). Overall, these results suggest that increasing bioaugmentation dosage does not necessarily result in increased dechlorination kinetics in the field; other factors such as contaminant concentration and factors that affect DHC transport (e.g., geology and groundwater velocity) may be equally important. Thus, the impact of DHC dosage on bioaugmentation performance likely will still need to be evaluated on a site-by-site basis, but models developed during this project are now available to aid in the planning process (Schaefer et al., 2009; Schaefer et al., in review).

3.2 BIOAUGMENTATION/BIOSTIMULATION COMPARISON

Another performance objective was to compare dechlorination in the three test loops bioaugmented with SDC-9 to dechlorination by indigenous microorganisms through biostimulation in the control loop. Groundwater monitoring was performed at all four loops to evaluate DHC growth and migration, dechlorination kinetics, and aquifer geochemistry. Success

criteria were established as; 1) complete dechlorination of TCE and cDCE to ethene in the three test loops, and 2) slow or incomplete dechlorination of TCE and cDCE in the control loop.

Groundwater sampling results indicated that aqueous DHC concentrations increased in the 3 test loops, as well as the control, biostimulation only, loop. However, aqueous DHC concentrations increases were orders of magnitude higher in the test loops, compared to the control loop. Final DHC concentrations in the two control loop performance monitoring wells were 2.1×10^6 and 1.1×10^6 cells/liter (respectively), while DHC concentrations in the test loop performance monitoring wells (with the exception of one well, which had a low pH) ranged from 1.8×10^7 to 2.0×10^9 cells/liter.

TCE concentrations in the test loop performance monitoring wells declined significantly during the demonstration, with TCE decreases in these wells ranging from 90 to 100 percent (or non-detect; less than 5 $\mu\text{g/L}$) (see **Section 5.7.4**). TCE concentrations in the control loop performance monitoring wells declined as well, with decreases in these wells between 98 and 100 percent (see **Section 5.7.4**). TCE decreases were expected in the control loop, as the addition of electron donor in the microcosm studies (**Section 5.3.1**) stimulated degradation of TCE (but not cDCE).

cDCE concentrations in test loop performance monitoring wells declined between 73 and 99 percent, and were generally trending downward at the end of the demonstration period, while cDCE concentrations in the Control Loop generally increased during the demonstration (see **Section 5.7.4**). Transient increases (followed by decreases) in VC were observed in 5 of the 6 test loop performance wells, with VC in 2 of the wells below detection at the end of the demonstration. VC was not observed in the control loop monitoring wells.

The presence of aqueous ethene is a key indicator of complete dechlorination of TCE. Ethene data collected during the demonstration clearly indicated that complete degradation was occurring within the test loops that were bioaugmented with SDC-9, and not within the control loop that received only electron donor, buffer and nutrients. Reductions in TCE concentrations, VC and ethene concentration trends, and increased DHC concentrations (**Section 5.7.4**) in test loop extraction wells indicated that degradation was occurring through the entire length of the test loops. VC and ethene were not observed in the control loop (with the exception of three detections of ethene below 1 $\mu\text{g/L}$ at one of the performance monitoring wells) during the demonstration, indicating that degradation of TCE had “stalled” at cDCE in the absence of bioaugmentation.

3.3 ELECTRON DONOR DISTRIBUTION

The third performance objective was to effectively distribute electron donor throughout all four demonstration recirculation loops (3 test loops and 1 control loop). The effective distribution of electron donor was critical to create anaerobic conditions within the aquifer, and to provide a source of carbon and hydrogen for microbial growth and dehalogenation of the target contaminants. In order to determine if this goal was achieved, VFA concentration data were collected at performance monitoring, injection, and extraction wells throughout the

demonstration. Success criteria were established as total VFA concentrations >5 mg/L at downgradient performance monitoring wells.

VFA data collected during the demonstration indicated that lactate injection and groundwater recirculation rates used during the demonstration provided effective distribution of electron donor throughout all 4 recirculation loops. VFA concentrations were observed in performance monitoring wells throughout most of the demonstration, with total VFA concentrations generally ranging from 50 mg/L to 2,000 mg/L. VFA data were consistent with results from the groundwater model and tracer test, indicating that the primary treatment zone for each loop was approximately 20 feet wide and at least 30 feet long.

3.4 pH ADJUSTMENT

The fourth performance objective of the demonstration, which was specific to the Ft. Dix site, was to increase and maintain groundwater pH levels within an acceptable range required for biological reductive dechlorination. This objective was critical for success at the Ft. Dix site because of its naturally low pH (pH ~4.5), and because preliminary testing revealed that DHC in the SDC-9 culture are sensitive to pH and that they do not dechlorinate well below pH ~5.5 (Vainberg et al., 2009). Therefore, the demonstration site groundwater pH levels needed to be increased from approximately 4.5 to above 5.5-6.0 standard units for this demonstration to be successful.

As discussed throughout this document, increasing and maintaining pH levels within the recirculation loops was challenging. pH was increased from generally below 5.0 to between 6.0 and 7.1 standard units, except at injection wells where pH levels were often greater than 9.0 standard units due to the injection of sodium carbonate. The pH levels often dropped below 5.5 (the level at which dechlorination rates drop significantly) in some of the wells during periods of the demonstration. Despite preliminary laboratory testing, sodium bicarbonate was determined to be too weak to increase aquifer pH. Therefore, the buffer used was changed to sodium carbonate (a stronger buffer) to more effectively increase pH within the aquifer. Additionally, two bulk injections of sodium carbonate were needed (a total of 250 lbs. per well) to further elevate groundwater pH values that still largely remained below 5.5 standard units after several weeks of system operation. A total of 7,000 lbs. of sodium bicarbonate and 9,600 lbs. of sodium carbonate (including the bulk injections) were injected into the four Loops during the 12 months of system operation.

3.5 REMEDIAL EFFECTIVENESS

The final performance objective was to determine remedial effectiveness of bioaugmentation with SDC-9. Groundwater monitoring was performed in the three test loops bioaugmented with SDC-9 to evaluate DHC growth and transport, dechlorination kinetics, and aquifer geochemistry. Success criteria were established as; 1) >90% reduction of TCE and cDCE, and 2) complete dechlorination of TCE and cDCE to ethene.

The results of this project demonstrated that CVOCs in the Ft. Dix MAG-1 aquifer can be effectively remediated by using bioaugmentation with the SDC-9 consortium and pH adjustment. TCE concentrations in the test area decreased by 90 to 100%, and cDCE concentrations

decreased by 73 to 99% and were trending downward at the termination of the demonstration project. The production of ethene confirmed complete dehalogenation of the target contaminants and demonstrated the effectiveness of the applied bioaugmentation culture. The CVOC and ethene data indicate that conversion of TCE and cDCE to ethene can exceed 95 percent in the treatment zones.

4.0 SITE DESCRIPTION

Several field sites for the demonstration were evaluated during the first six months of the project. Final selection came down to Air Force Plant No. 4 (AFP4) in Fort Worth, TX, and the Naval Amphibious Base in Virginia Beach, VA. Both sites are contaminated primarily with TCE with some cDCE accumulation. AFP4 was originally selected as the field demonstration site and extensive work was performed to prepare for the demonstration at AFP4. However, severe and persistent drought conditions in the region led to significant reduction of the saturated thickness in the aquifer zone being considered for the field demonstration project. Consequently, during July and August 2006, Shaw evaluated other potential demonstration sites as alternatives to the AFP4 site. The MAG-1 Area at Fort Dix, New Jersey was ultimately chosen for the field demonstration. **Figure 4-1** shows the location of MAG-1 and Fort Dix, New Jersey.

The MAG-1 Area groundwater plume met many of the selection criteria for a field demonstration site based on the following: (1) PCE and/or TCE concentrations between 1-30 mg/L with limited cDCE and no VC or ethene; (2) shallow sand or silty sand aquifer (less than 30 feet below ground surface); (3) sufficient area to allow operation of four approximately 50 ft long by 30-40 ft wide recirculation loops; and (4) proximity to a Shaw office and vendors used to support the field demonstration. The first criterion was necessary for evaluating the impact of enhanced bioremediation and bioaugmentation separately from intrinsic biodegradation. The second criterion is a microbial consideration; the aquifer needed to be sufficiently conductive to allow distribution of microbes without slowing or inhibiting microbial activity.

One potentially challenging issue identified with the MAG-1 site was the low natural pH (<5). Laboratory studies demonstrated that the SDC-9 culture used for the demonstration is inhibited at pH values less than 5.5 (Vainberg et al., 2009), and as discussed in **Sections 5.3.1** and **5.3.3**, laboratory studies showed that pH adjustment would be required to facilitate bioremediation at the site.

The MAG-1 Area at Fort Dix has been subject to numerous studies and several remedial investigations, detailed in the following reports;

- ABB-ES. 1997. Final Remedial Investigation Report MAG-1 Area. April 1997.
- Dames & Moore 1993. Interim Phase II Remedial Investigation Report, Fort Dix, NJ. Volume II and III. April 1993.
- Dames & Moore 1992. Interim Phase I Remedial Investigation Report, Fort Dix, NJ. January 1993.

Shaw has been tasked by the Army since 2004 with a Guaranteed Fixed Price Remediation/Performance Based Contract (GFPR/PBC) to remediate 14 sites at Fort, Dix. The MAG-1 Area groundwater plume is part of this contract. As part the MAG-1 site remediation work, Shaw has conducted additional site characterization studies including the installation of additional monitoring wells, conducted soil and groundwater treatability studies for biostimulation and bioaugmentation and developed a conceptual site model and groundwater model for the area. Shaw maintains technical and field staff in several offices located near Fort

OFFICE: Pittsburgh, PA
 DATE: 2/23/09
 DESIGNED BY: D. Lippincott
 DRAWN BY: B. Snyder
 CHECKED BY: C. Schaefer
 APPROVED BY: R. Steffan
 DRAWING NUMBER: 115869-A3

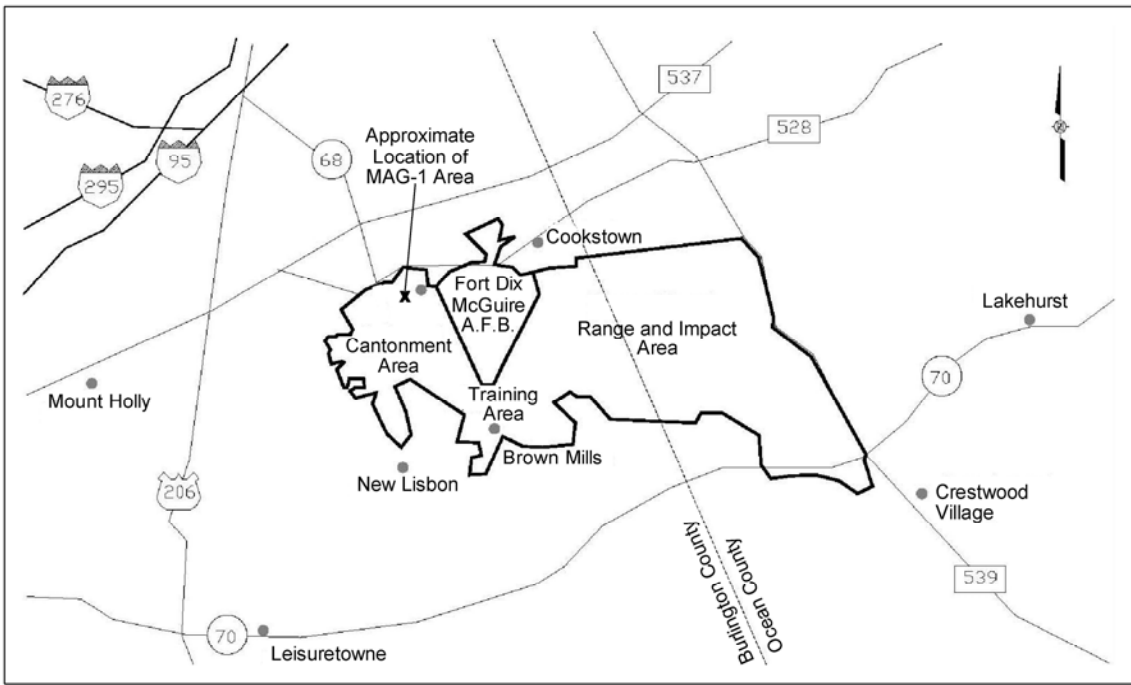

VICINITY MAP OF FORT DIX



STATE OF NEW JERSEY

File: O:\Project\AFCEE\Fort Dix\115869A3.dwg
 Plot Date/Time: Jul 24, 2009 - 9:34am
 Plotted By: william.snyder
 Xref: 115869m1.jpg
 Image: FIG 1-2.jpg

REFERENCE:

DAMES & MOORE DRAWING FIG 1-1 LOCATION OF FORT DIX, NEW JERSEY.

Shaw Shaw Environmental, Inc.

ESTCP FIELD DEMONSTRATION
 BIOAUGMENTATION FOR
 GROUNDWATER REMEDIATION

FIGURE 4-1
SITE LOCATION MAP

MAG-1 AREA
 FORT DIX, NEW JERSEY

Dix at our Edison, Trenton and Lawrenceville, New Jersey offices. Shaw has a long history at the site (from current and previous contracts) and a good working relationship with base personnel and site oversight personnel (Army Environmental Center (AEC), the EPA, and NJDEP regulators assigned to the site). This long-standing relationship at the site ensured that we had access to existing and historical site data, relationships with local support contractors (drillers, electricians, etc.), and the base support needed to perform the demonstration. It also allowed us to leverage this project with existing work being performed by Shaw personnel at the facility.

Like any demonstration site, the MAG-1 Area had issues of concern. The issues were related to site logistics and access including soft ground that required selective tree removal and construction of a road and the use of tracked drilling equipment. Efforts and planning were necessary to minimize unnecessary damage to the forest resources. In addition, there were concerns about the heterogeneity and grain size characteristics of the test site unconsolidated sediments, and the pH of the aquifer.

4.1 SITE LOCATION AND HISTORY

Fort Dix is located in Burlington and Ocean counties, New Jersey, approximately 25 miles southeast of Trenton. The MAG-1 Area is located in the northern part of the Cantonment Area at Fort Dix (**Figure 4-1**). **Figure 4-2** shows the location of the demonstration area within the MAG-1 Area, and the location of monitoring wells that existed prior to the demonstration.

Review of historic blueprints of the area indicates that the active MAG-1 Area existed as early as 1919, along the southern side of a Penn Atlantic Railroad spur (Dames & Moore, 1993). The MAG-1 Area was the site of an ammunitions and weapons magazine storage area and a vapor-degreasing operation. From approximately 1942 through 1965, vapor-degreasing of small arms was conducted at the MAG-1 Area. The vapor-degreasing operation used TCE to remove Cosmoline, a Vaseline-type petroleum product used for packing rifles.

According to the Dames & Moore Phase II RI report (Dames & Moore, 1993), an employee at Fort Dix who participated in the degreasing operations reported that drums of TCE were used until saturated with Cosmoline. The drums of spent material then were transported to a rubble pile along the southern boundary of the MAG-1 Area, where the TCE/Cosmoline mixture was poured into holes in the rubble pile. Unconfirmed reports indicate one 55 gallon drum containing approximately 40 to 60 percent TCE was discarded each day. During busy periods, approximately two drums per day were reportedly discarded (Dames & Moore, 1993). The reliability of this historical information is suspect due to lack of free-product contamination at the site and questions regarding TCE generation rates. It is unlikely the estimated quantities of TCE were consistently generated during operations and it is possible that partially-filled drums were often emptied onto the rubble pile.

Except for one drum of TCE/Cosmoline that was spilled adjacent to the degreasing operations building, all wastes generated during this operation reportedly were disposed of in the rubble pile, approximately 100 feet south of the degreasing operations building. It is not known if any TCE was spilled inside the building. No surface ponding was reported from wastes poured into

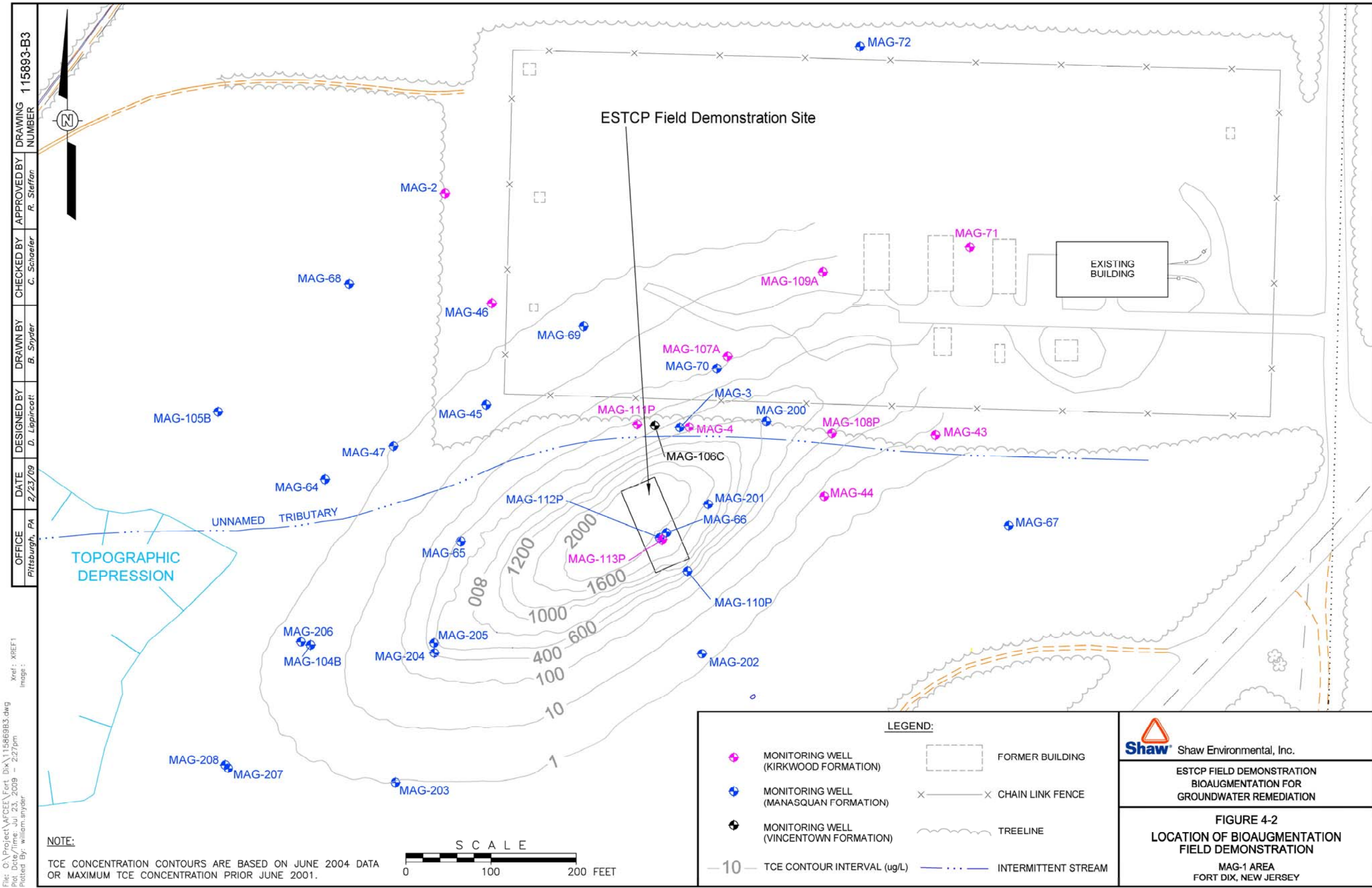

OFFICE: Pittsburgh, PA
 DATE: 2/23/09
 DESIGNED BY: D. Lippincott
 DRAWN BY: B. Snyder
 CHECKED BY: C. Schroeder
 APPROVED BY: R. Steffan
 DRAWING NUMBER: 115893-B3

File: O:\Project\MAFCEEN\Fort Dix\115893B3.dwg
 Plot: D:\w\mbe\jul_23_2009 - 2277pm
 Plotted By: william.anyler

the rubble pile, and TCE was disposed of in different holes within the pile. Visible surface seepage from beneath the rubble pile reportedly occurred along its southern and western edges. Due to the porous characteristic of rubble piles, volatilization losses of TCE were likely to be significant during this disposal process.

4.2 SITE GEOLOGY/HYDROGEOLOGY

The MAG-1 Area is located at the base of an escarpment, over which surface elevations drop approximately 40 to 80 feet. The topography in the MAG-1 Area slopes to the west and northwest. Local groundwater discharges to ponds and wetlands and streams at this escarpment base. Groundwater in the area appears to discharge to several streams and wetlands that mainly intersect the Kirkwood and Vincentown formations. The MAG-1 Area is located near one such stream that is referred to as the unnamed tributary (**Figure 4-2**). This tributary flows intermittently past the demonstration area, through a low area known as the topographical depression and a wetland area, and eventually joins with other small streams to form Indian Run.

As shown in **Figure 4-3**, the unconsolidated hydrogeologic units (sequentially, from the uppermost unit down) in the vicinity of the MAG-1 Area are the Cohansey, Kirkwood, Manasquan, Vincentown, Hornerstown-Navesink, and Wenonah-Mount Laurel Sands. Surficial geological maps of the area (presented in the ABB, 1997 report) indicate that the Cohansey Sand is present east of, but not within, the MAG-1 Area. The Kirkwood formation is the uppermost unit in the immediate vicinity of MAG-1 Area, but is absent west of the site. A natural gamma borehole investigation performed by the United States Geologic Survey (USGS) in 1996 (ABB, 1997) suggests that a thin (0.5 to 1.0 feet) “formation interface zone” (Interface Zone) consisting of fine to coarse sand and fine gravel at the base of the Kirkwood Formation may limit downward groundwater flow by creating a highly conductive horizontal flow path. Vertical contaminant distribution (**Section 5.2.1**) and bromide tracer testing results (**Section 5.7.2**) seem to confirm this assertion.

The geology underlying the field demonstration site consists of unconsolidated materials from the Kirkwood and Manasquan formations. Test area hydrogeology, including lithology, groundwater flow direction, and hydraulic conductivities and gradients was evaluated as part of the pre-demonstration testing, and are discussed in detail in **Section 5-2**. Shallow soils (down to ~104 feet MSL) are a mixture of silty and clayey sands. Mottling within this zone (particularly within the clayey sand) indicates seasonal water table fluctuations. Soils from approximately 104 to 90 feet MSL consist of saturated, light gray silty fine sands (Kirkwood Formation). A 4- to 8-inch Interface Zone, consisting of fine to coarse sands and fine gravel, is present at the base of this unit. This zone appears to exhibit significantly higher permeability than the formations above and below. Soils below this unit (down to at least 70 feet MSL) consist of saturated, greenish-gray fine sands (Manasquan Formation).

The demonstration was performed within the Kirkwood aquifer. Groundwater flow direction for the Kirkwood aquifer is generally to the southwest. The hydraulic gradient across the demonstration area is approximately 0.012, and the groundwater velocity for this aquifer is estimated at approximately 0.08 ft/day (**Section 5.2.6**). Water level measurements at select

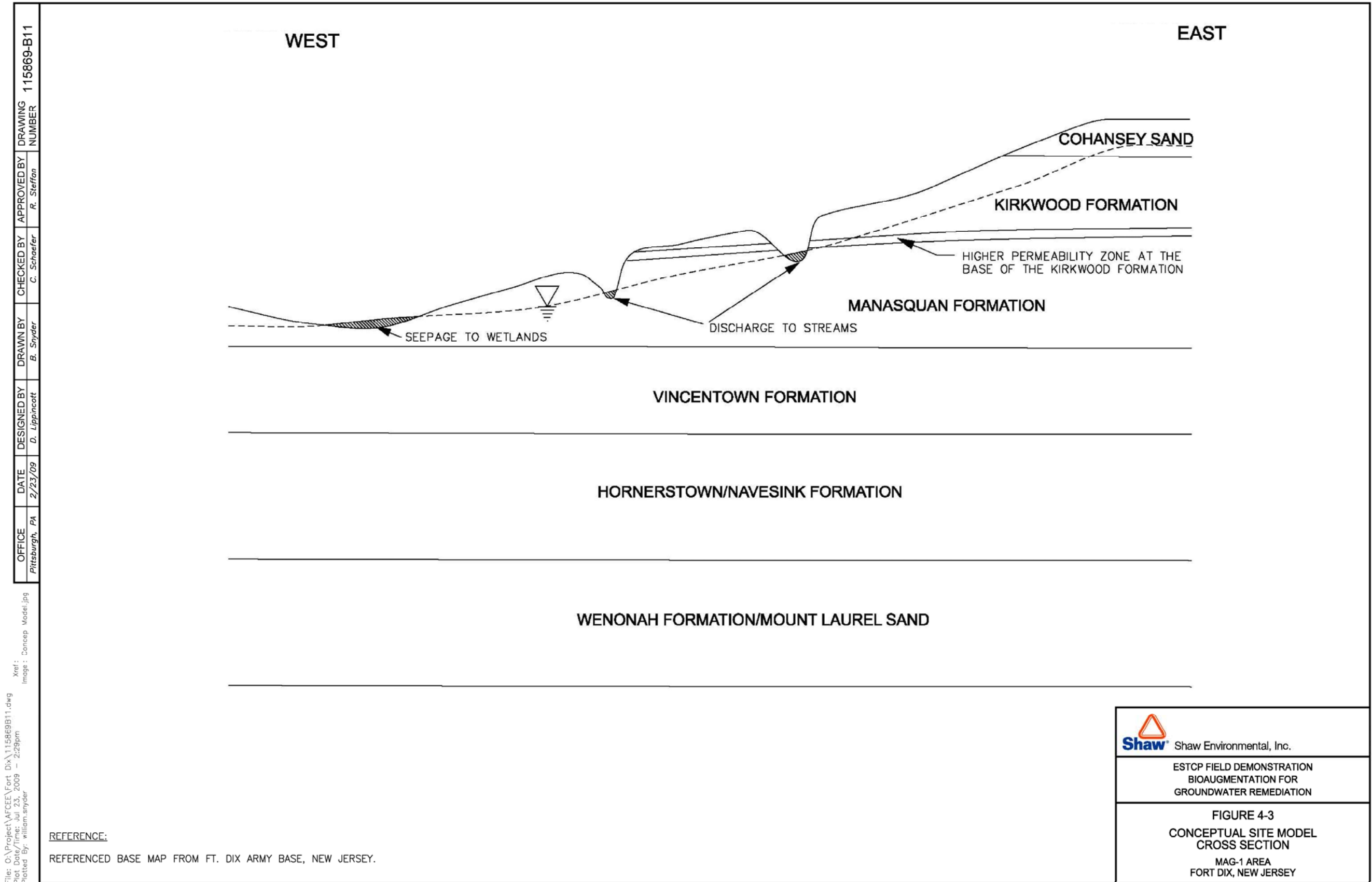

OFFICE	DATE	DESIGNED BY	DRAWN BY	CHECKED BY	APPROVED BY	DRAWING NUMBER
Pittsburgh, PA	2/23/09	D. Lippincott	B. Snyder	C. Schaefer	R. Steffan	115869-B11

File: O:\Project\AFCEE\Fort Dix\115869B11.dwg
 Plot Date/Time: Jul 23, 2009 - 2:29pm
 Plotted By: william.snyder
 Xref: Concept Model.jpg

REFERENCE:
 REFERENCED BASE MAP FROM FT. DIX ARMY BASE, NEW JERSEY.

 Shaw Environmental, Inc.
ESTCP FIELD DEMONSTRATION BIOAUGMENTATION FOR GROUNDWATER REMEDIATION
FIGURE 4-3 CONCEPTUAL SITE MODEL CROSS SECTION MAG-1 AREA FORT DIX, NEW JERSEY

monitoring wells indicate that there is no measureable vertical gradient between the Kirkwood and Manasquan aquifers (at the demonstration location).

4.3 CONTAMINANT DISTRIBUTION

Several geologic and hydraulic investigations have been performed in the MAG-1 area, as discussed in the Demonstration Plan (Shaw 2007). Dames and Moore and ABB remedial investigation activities (soil gas surveys, geophysical surveys, soil and groundwater sampling) focused on the area near the MAG-1 buildings (**Figure 4-2**). Later field activities included the collection of soil and groundwater samples and single well slug-tests in the MAG-1 plume area.

TCE and cDCE are the main chlorinated solvents detected in the MAG-1 Area groundwater. **Figures 4-4** and **4-5** show the estimated horizontal extents of the TCE and cDCE plumes within the Kirkwood formation. The plume contours for these figures were based on the maximum TCE or cDCE concentration collected in June 2004 or from maximum concentrations detected prior to 2001. Based on these data, the TCE plume with a maximum concentration of approximately 2,000 ug/L near Monitoring Well MAG-113P, is approximately 900 feet long and 450 feet wide. The cDCE plume, with a maximum concentration of approximately 1,200 ug/L near monitoring well MAG-113P, is approximately 750 feet long by 350 feet wide. However, as discussed in **Section 5-2**, more recent groundwater data indicates that both TCE and cDCE concentrations are currently substantially lower (at least in the Demonstration Area) than those observed during and prior to June 2004.

The field demonstration area was located in the plume area with the highest VOC concentrations (**Figure 4-2**). Based on the total VOCs observed at wells near the demonstration site (MAG-112P, MAG-113P, MAG-66,) the highest total VOC concentrations are in the 90 to 100 foot msl range (i.e. Kirkwood Formation). Total VOC concentrations in well MAG-113P (screen interval across the Kirkwood and Manasquan Formations: 87.5-97.5 ft msl) in June 2004 were 2,400 ug/L, while VOC concentrations in well MAG-112P (screen interval within the Manasquan Formation: 78.2-88.2 ft msl) were below the analytical detection limit. The significant difference in VOC concentrations between these wells suggests that the formation interface (higher permeability zone discussed in **Section 4.2**) existing near 90 feet msl inhibits downward groundwater flow and mixing. Lithological and analytical data obtained during the Demonstration Area characterization activities significantly improved delineation of the horizontal and vertical VOC distribution, and better defined the stratigraphy within the demonstration area. Results of these characterization activities are discussed in **Section 5.2**.

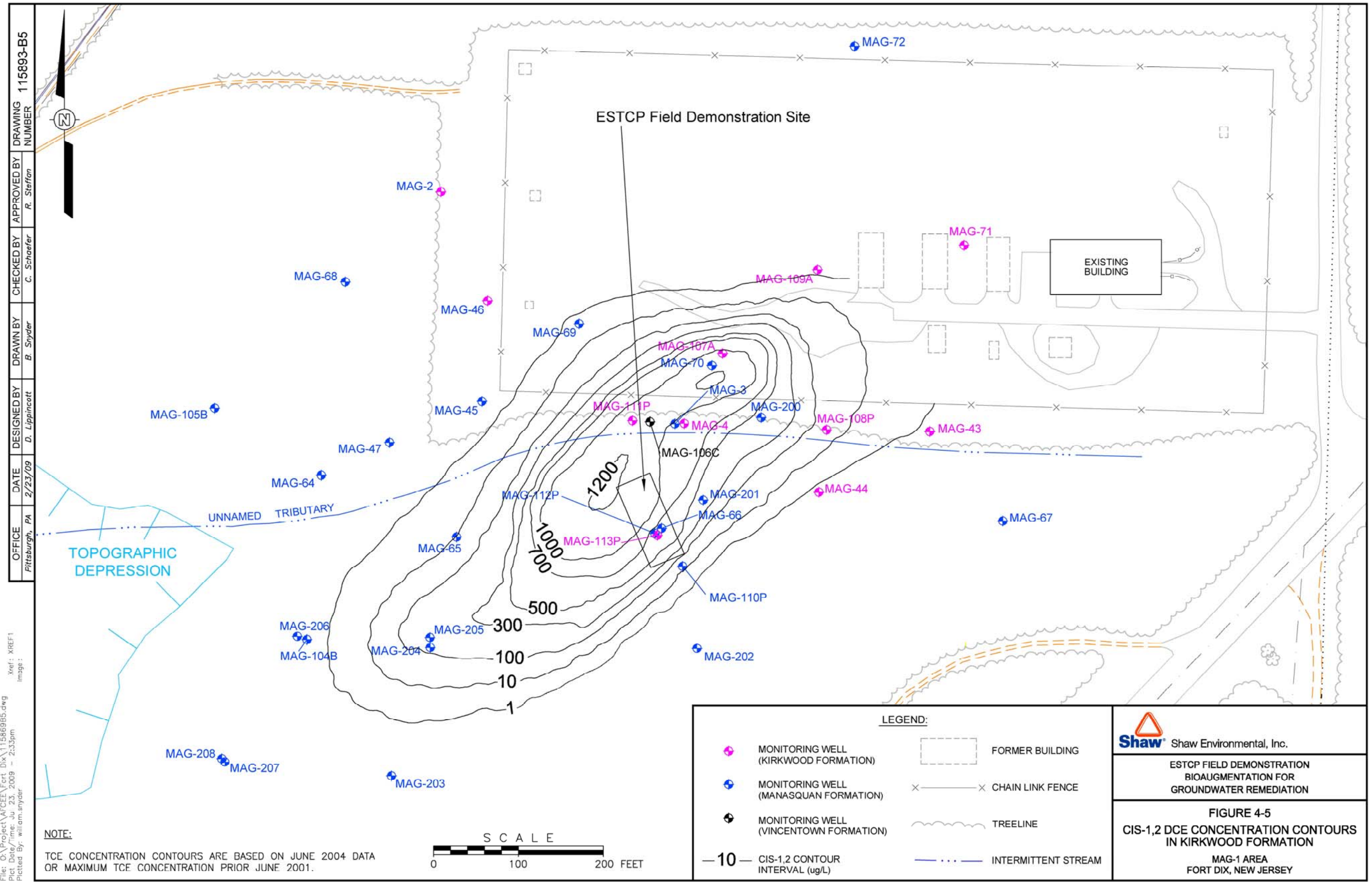

5.0 TEST DESIGN

The following subsections provide detailed description of testing conducted during the demonstration, including site characterization, treatability and laboratory studies, and demonstration design, construction and field testing.

5.1 CONCEPTUAL EXPERIMENTAL DESIGN

The primary goals of this field demonstration were to evaluate the amount of culture needed to effectively remediate a CVOC-contaminated plume, and to determine the affect of inoculum dose on remedial time. The field demonstration involved the construction and operation of four groundwater recirculation loops in the MAG-1 Area at Fort Dix, New Jersey. Three of the loops (test loops) were inoculated with a different amount of Shaw's SDC-9 dechlorinating culture, while the fourth loop (control loop) only received electron donor, buffer and nutrients. CVOC biodegradation and growth of the added organisms were monitored. In addition, because of the low natural pH at the site, the ability to increase and maintain an elevated pH sufficient for successful bioremediation by adding buffers was evaluated. The results of the demonstration were used to evaluate and refine the one-dimensional bioaugmentation fate and transport screening model that was generated from laboratory experiments performed during the project (Schaefer et al., 2009).

5.2 BASELINE CHARACTERIZATION

The following sections describe laboratory and field sampling/characterization activities that were conducted prior to the field demonstration. Laboratory results and field data were used to prepare the final design of the field demonstration layout, and to determine the most appropriate bioaugmentation amendments. Once the demonstration system was installed, groundwater samples and water table elevation data were collected to establish baseline conditions prior to system start-up.

5.2.1 Direct-Push Investigation

A direct-push (Geoprobe®) investigation was conducted in the MAG-1 Area between January 8 and January 12, 2007 (**Figure 5-1, Table 5-1**). The purpose of the investigation was to improve delineation of the stratigraphy in the field demonstration test area, and to further evaluate the vertical and lateral contaminant distribution. Information obtained from the investigation was used to optimize/verify well screen intervals for the injection/extraction and monitoring wells, and confirm that the four injection/extraction recirculation loops were placed in the core of the TCE plume.

Soil samples were collected from six locations (GP-1 through GP-6) shown on **Figure 5-2**. Continuous soil core samples for lithologic evaluation were collected from each boring to a depth of 35 to 40 feet bgs (~70-75 feet MSL). Soil cores were screened for VOCs using a photoionization detector (PID); one soil sample from each boring location, correlating to the depth interval where the highest PID readings were recorded below the water table, was collected and

Figure 5-1
 Field Demonstration Schedule

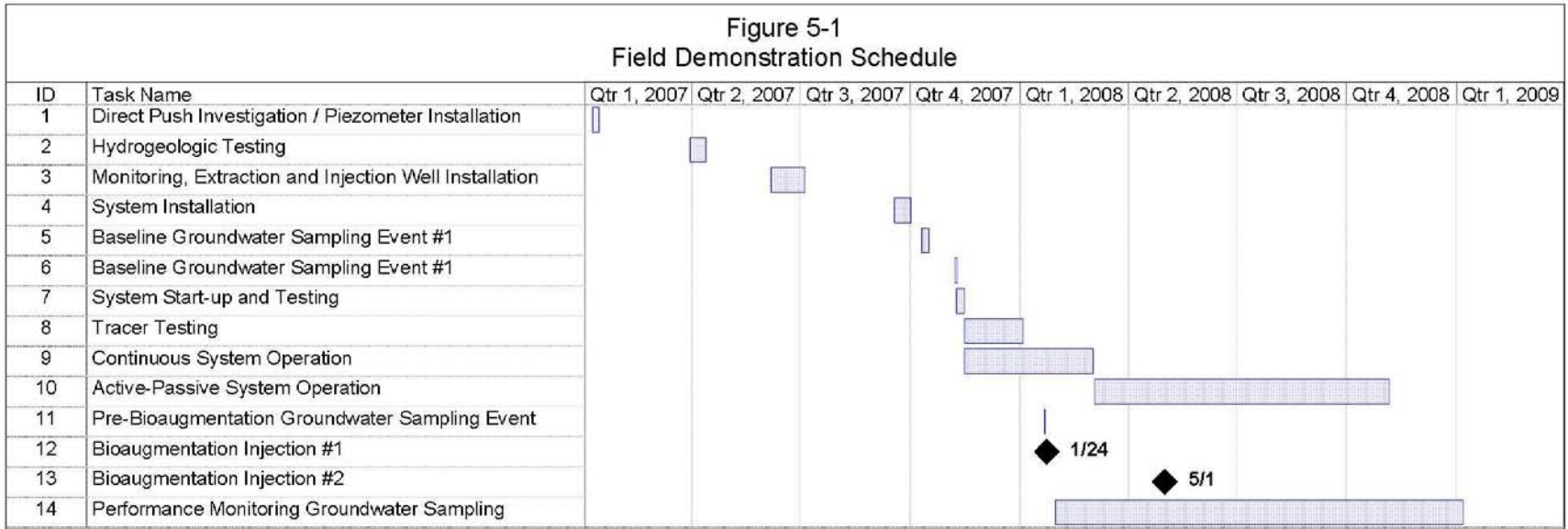

◆ 1/24

◆ 5/1

**Figure 5-1
Demonstration Schedule and System Operation Summary**

Starting Date	Activity	Duration	Summary
Demonstration Area Characterization			
1/8/2007	Direct-Push Investigation	5 days	Performed 6 soil borings: continuous soil cores, collected soil VOC samples Collected discrete groundwater samples from 6 locations. Installed piezometers PZ-1 & PZ-2
3/30/2007	Slug Testing	1 day	Performed rising head and falling head slug tests on 5 demonstration area wells
4/10/2007	Step-Drawdown Pump Test at PZ-1	1 day	Performed 3-step pump test to determine pumping rate for constant rate pump test
4/11/2007	Constant Rate Pump Test at PZ-1	1 day	5-hour constant rate pump test
Phase 1: Well and Equipment Installation			
6/6/2007	Monitoring Well and Injection/Extraction Well Installations and Development	4 weeks	Installed and developed 11 performance monitoring, 4 extraction and 4 injection wells
9/17/2007	Systems Installation	2 weeks	Installed well pumps & piping, electron donor, buffer, & nutrient injection systems, and system controls (PLC & SCADA)
Phase 2: Baseline Monitoring			
10/10/2007	Baseline Sampling Event #1	6 days	See Table 5-7 for sampling locations and parameters
11/7/2007	Baseline Sampling Event #2	2 days	See Table 5-7 for sampling locations and parameters
Phase 3: Systems Testing			
11/8/2007	Systems Testing	1 week	Tested and calibrated all pumps, controls, alarms & sensors. Tested PLC/SCADA, Collected groundwater elevation data to determine impacts or recirculation
Phase 4: Recirculation System Start-up and Tracer Testing			
11/15/2007	System Start-up	7 days	Started groundwater recirculation: 0.5 gpm per loop
11/16/2007	Begin Injecting Buffer, Electron Donor, and Nutrients	NA	Injecting sodium bicarbonate, lactate and diammonium phosphate solutions
11/16/2007	Bromide & Fluoride Tracer Injection	28 days	510 gallons of solution containing ~23 kg of sodium bromide injected in Loops 1 and 3 510 gallons of solution containing ~23 kg of sodium fluoride injected in Loops 2 and 4
11/20/2007	Tracer Sampling Event #1	1 day	See Table 5-7 for sampling locations and parameters
11/26/2007	Tracer Sampling Event #2	1 day	See Table 5-7 for sampling locations and parameters
12/4/2007	Tracer Sampling Event #3	2 days	See Table 5-7 for sampling locations and parameters
12/11/2007	Tracer Sampling Event #4	1 day	See Table 5-7 for sampling locations and parameters
12/11/2007	Changed Buffer Being Injected	NA	Switch buffer from sodium bicarbonate to sodium carbonate
12/18/2007	Tracer Sampling Event #5	1 day	See Table 5-7 for sampling locations and parameters
12/20/2007	Redeveloped Injection Wells	6 days	Used acid, surging, and pumping to redevelop all 4 injection wells
12/27/2007	Bulk Buffer Injection	1 day	Injected 100 lbs. of sodium carbonate in each of the 4 injection wells
1/3/2008	Tracer Sampling Event #6	1 day	See Table 5-2 for sampling locations and parameters
1/3/2008	Reduced Recirculation Rates	NA	Reduced groundwater extraction/re-injection from 0.5 to 0.4 gpm at each loop
1/15/2008	Bulk Buffer Injection	1 day	Injected 150 lbs. of sodium carbonate in each of the 4 injection wells
1/15/2008	Reduced Recirculation Rates	NA	Reduced groundwater extraction/re-injection from 0.4 to 0.3 gpm at each loop
1/21/2008	Pre-Bioaugmentation Sampling Event	1 day	See Table 5-2 for sampling locations and parameters

**Figure 5-1
Demonstration Schedule and System Operation Summary**

Starting Date	Activity	Duration	Summary
Phase 5: Bioaugmentation, Systems Operation, and Performance Monitoring			
1/24/2008	Bioaugmentation Injection #1	1 day	Injection of SDC-9: 100 liters into IW-1, 10 liters into IW-2, and 1 liter into IW-3
1/30/2008	Performance Monitoring Sampling Event #1	1 day	See Table 5-7 for sampling locations and parameters
2/5/2008	Performance Monitoring Sampling Event #2	2 days	See Table 5-7 for sampling locations and parameters
2/7/2008	Reduced Recirculation Rates	NA	Reduced groundwater extraction/re-injection from 0.3 to 0.25 gpm at each loop
2/19/2008	Performance Monitoring Sampling Event #3	1 day	See Table 5-7 for sampling locations and parameters
2/19/2008	Reduced Recirculation Rates	NA	Reduced groundwater extraction/re-injection from 0.25 to 0.2 gpm at each loop
3/3/2008	Begin Active-Passive Operation	NA	Operating groundwater recirculation and amendment addition systems ~50% of the time
3/17/2008	Performance Monitoring Sampling Event #4	1 day	See Table 5-7 for sampling locations and parameters
4/17/2008	Performance Monitoring Sampling Event #5	1 day	See Table 5-7 for sampling locations and parameters
5/1/2008	Bioaugmentation Injection #2	1 day	Injection of SDC-9: 100 liters into MW-1, 10 liters into MW-3, and 1 liter into MW-5
5/19/2008	Performance Monitoring Sampling Event #6	1 day	See Table 5-7 for sampling locations and parameters
5/30/2008	Changed Buffer Being Injected	NA	Switch buffer from sodium carbonate to sodium bicarbonate
6/3/2008	Reduced Recirculation Rates	NA	Reduced groundwater extraction/re-injection from 0.2 to 0.15 gpm at each loop
6/4/2008	Performance Monitoring Sampling Event #7	1 day	See Table 5-7 for sampling locations and parameters
6/23/2008	Performance Monitoring Sampling Event #8	1 day	See Table 5-7 for sampling locations and parameters
6/25/2008	Redeveloped Injection Wells	5 days	Used acid, surging, and pumping to redevelop all 4 injection wells
7/3/2008	Reduced Recirculation Rates	NA	Reduced groundwater extraction/re-injection from 0.15 to 0.1 gpm at each loop
7/15/2008	Changed Buffer Being Injected	NA	Switch buffer from sodium bicarbonate to sodium carbonate
7/22/2008	Performance Monitoring Sampling Event #9	1 day	See Table 5-7 for sampling locations and parameters
9/22/2008	Performance Monitoring Sampling Event #10	1 day	See Table 5-7 for sampling locations and parameters
10/1/2008	Shut Down Loop 1	NA	Stopped recirculation & amendment injection. Groundwater reaching surface at IW-1
11/5/2008	System Shut-down	NA	Ceased groundwater recirculation and amendment injections at remaining 3 loops
11/11/2008	Performance Monitoring Sampling Event #11	2 days	See Table 5-7 for sampling locations and parameters
1/5/2009	Performance Monitoring Sampling Event #12	1 day	See Table 5-7 for sampling locations and parameters

File: C:\Project\AFCEE\Fort Dix\115869A5.dwg
 Plot Date/Time: Aug '9, 2009 - 2:06pm
 Plotted By: william.snyder

Xref:
 mge:

OFFICE	DATE	DESIGNED BY	DRAWN BY	CHECKED BY	APPROVED BY	DRAWING NUMBER
Pittsburgh, PA	3/3/09	D. Lippincott	B. Snyder	C. Schaefer	R. Steffan	115869-A5

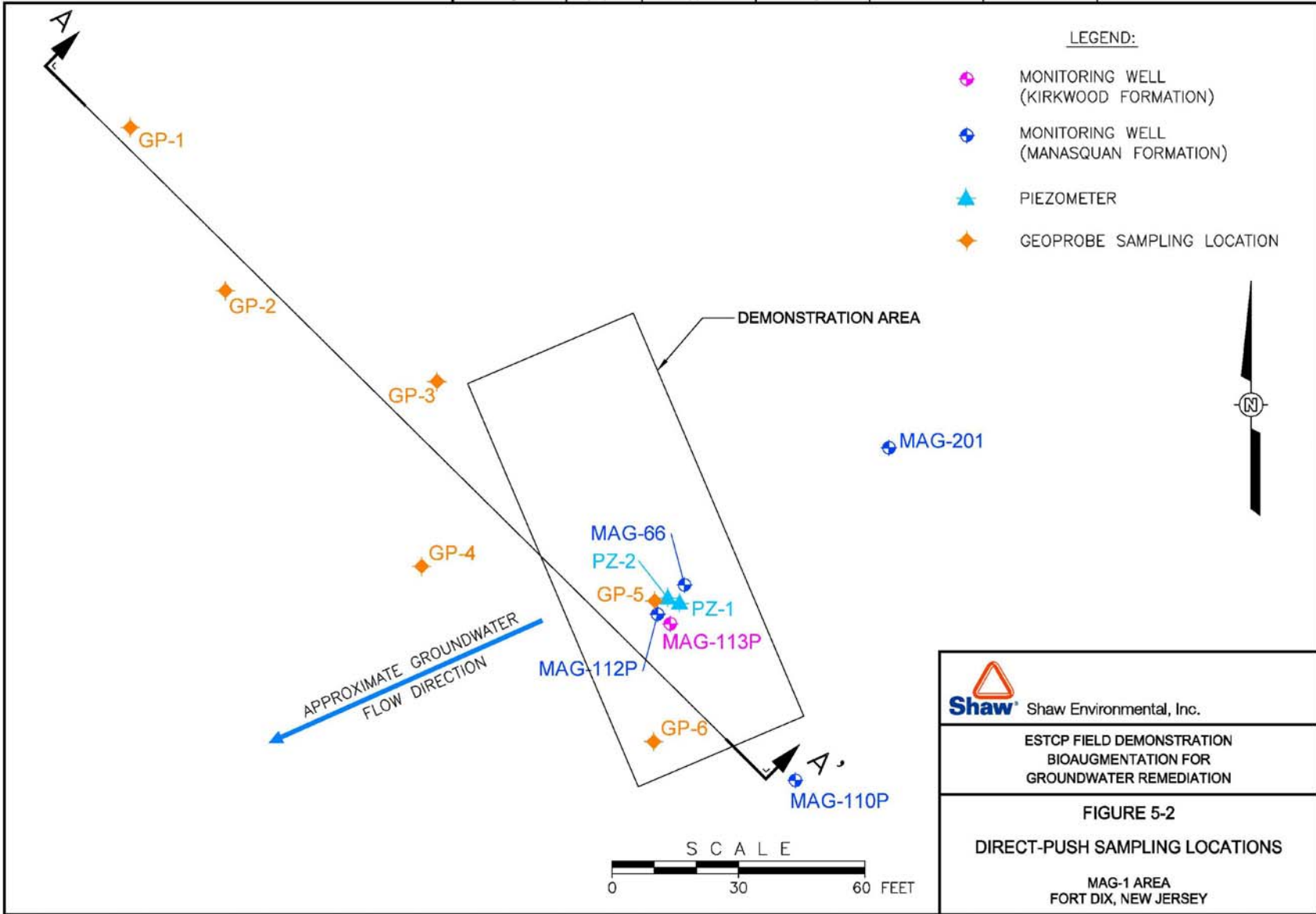

analyzed for VOCs via EPA Method 8260. All soil analyses were performed by Shaw's New Jersey-certified laboratory in Lawrenceville, New Jersey. Soil analytical results are summarized in **Table 5-2**. TCE concentrations ranging from 0.14 to 3.2 mg/kg, and cDCE concentrations ranging from non-detect (<0.012 mg/kg) to 0.97 mg/kg were observed. No other VOCs were detected.

Table 5-2
Summary of Direct-Push Investigation Soil Analytical Data

Sample ID	Sample Depth (ft bgs)	TCE (mg/kg)	cis-DCE (mg/kg)
GP-1	15.0	0.43	0.043
GP-2	24.6	0.14	<0.012
GP-3	20.0	1.7*	0.029
GP-4	19.6	0.96*	0.97*
GP-5	16.2	3.2*	0.29*
GP-6	28.3	0.26	0.23

*Sample prepared via SHW846 Method 5035 due to elevated VOC levels.

Figure 5-3 presents a geologic cross section of the field demonstration site. Based on observations of the Geoprobe® soil cores collected within this area, shallow soils (down to ~104 feet MSL) are a mixture of silty and clayey sands. Mottling within this zone (particularly within the clayey sand) indicates seasonal water table fluctuations. Soils from approximately 104 to 90 feet MSL consist of saturated, light gray silty fine sands (Kirkwood Formation). A 4- to 8-inch Interface Zone, consisting of fine to coarse sands and fine gravel, is present at the base of this unit. This zone appears to exhibit significantly higher permeability than the formations above and below. Soils below this unit (down to at least 70 feet MSL) consist of saturated, greenish-gray fine sands (Manasquan Formation).

Groundwater samples were also collected from six locations, located immediately adjacent (within 3 feet) to the six soil sampling locations described above (**Figure 5-2**). Four to five discrete groundwater samples were collected at each of the locations, using a Geoprobe® stainless steel Screen Point sampler. Sample intervals were based on observed lithology and PID readings. Samples were analyzed for VOCs at Shaw's Lawrenceville, NJ laboratory. Groundwater sampling intervals and analytical results are summarized in **Table 5-3**, and shown in cross section on **Figure 5-3**. TCE concentrations ranging from non-detect (<5 ug/L) to 2,900 ug/L, and cDCE concentrations ranging from non-detect (<5 ug/L) to 1,700 ug/L were observed. Estimated concentrations of trans-1,2 DCE and 1,1 DCE were also reported (**Table 5-3**). As indicated in **Figure 5-3**, the majority of the TCE and cDCE contamination resides within the Kirkwood Formation and the Interface Zone, with contaminant concentrations significantly lower in the Manasquan Formation. The significant difference in VOC concentrations between these formations suggests that the higher permeability Interface Zone inhibits downward groundwater flow and mixing by creating preferential horizontal flow.

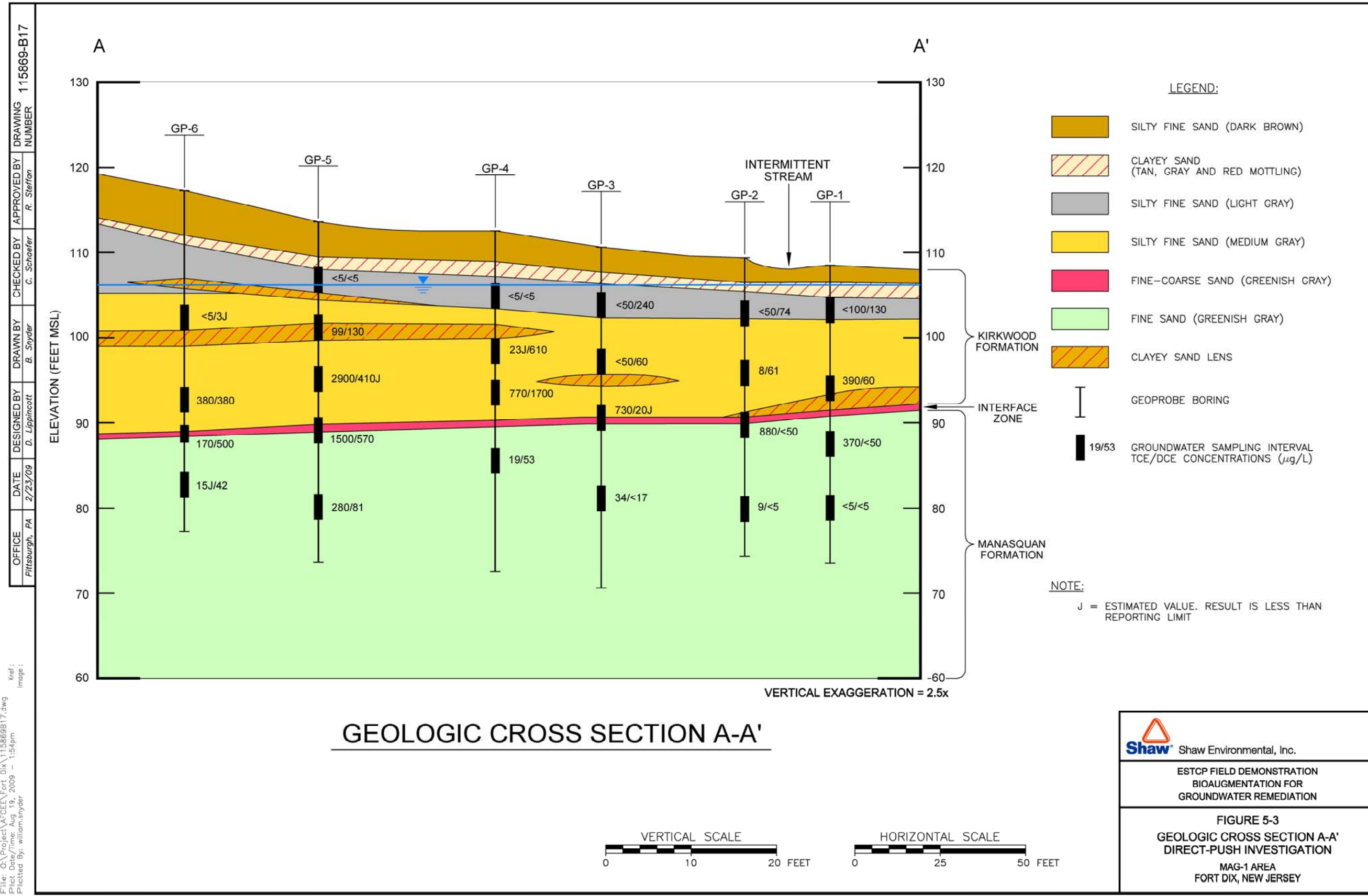

File: O:\Project\FCEE\Fort Dix\115869B17.dwg
 Plot Date/Time: Aug 19, 2009 - 1:54pm
 Plotted By: william.snyder

Shaw Shaw Environmental, Inc.

ESTCP FIELD DEMONSTRATION
 BIOAUGMENTATION FOR
 GROUNDWATER REMEDIATION

FIGURE 5-3
GEOLOGIC CROSS SECTION A-A'
DIRECT-PUSH INVESTIGATION
 MAG-1 AREA
 FORT DIX, NEW JERSEY

**Table 5-3
Summary of Direct-Push Investigation Groundwater Analytical Data**

Sample ID	Depth Interval (ft bgs)	TCE (mg/L)	<i>cis</i> -DCE (mg/L)	<i>trans</i> -DCE (mg/L)	1,1-DCE (mg/L)
GP-1	4-7	<100	130	<100	<100
	13-16	390	60	<50	<50
	19-22	370	<50	<50	<50
	27-30	<5	<5	<5	<5
GP-2	5-8	<50	74	<50	<50
	12-15	8	61	<5	<5
	18-21	880	<50	<50	<50
	28-31	9	<5	<5	<5
GP-3	5-8	<50	240	<50	<50
	12-15	<50	160	<50	<50
	18.5-21.5	730	20*	<50	<50
	28-31	34	<17	<17	<17
GP-4	6-9	<5	<5	<5	<5
	12-15	23*	610	<50	<50
	17-20	770	1700	27*	<50
	25-28	19	53	<17	<17
GP-5	6-9	<5	<5	<5	<5
	11-14	99	130	<25	<25
	17-20	2900	410*	<500	<500
	22.5-25.5	1500	570	<500	<500
	32-35	280	81	1*	2*
GP-6	13-16	<5	3*	<5	<5
	23-26	380	380	13*	<50
	27.5-29.5	170	500	14*	13*
	33-36	15*	42	<17	<17

*Estimated result; Result is less than reporting limit

During the investigation, additional soil (approximately 2 kilograms) was collected from the GP-5 location (17-21.5 feet bgs) for the column testing described in **Section 5.3.3**. Sixteen liters of groundwater was also collected from monitoring well MAG-113P at this time for the study. Investigation activities (including sample collection techniques and equipment decontamination) and management of investigation derived waste (IDW) were conducted as detailed in the Demonstration Plan (Shaw 2007). Field activities were conducted in Level D Protection. Underground utility clearances were obtained for all intrusive site activities. Clearance of all underground utilities was arranged with appropriate Fort Dix facility personnel and local utility companies.

5.2.2 Piezometer Installation

One pair of nested piezometers was installed during the direct-push investigation (**Section 5.2.1**). The nested piezometers were located approximately midway between existing monitoring wells MAG-13P and MAG-66 (**Figure 5-2**). The shallow piezometer (PZ-1) is screened from 10 to 15 feet bgs (97.9-102.9 feet MSL). The intermediate piezometer (PZ-2) is screened from 20.5 to 25.5 feet bgs (92.2-87.2 feet MSL). Placement of the piezometers at these depth intervals facilitated evaluation of hydraulic conductivities within the Kirkwood and Manasquan formations, as well as the higher permeability Interface Zone (**Figure 5-4**).

Piezometer installations were performed by a New Jersey licensed driller (SGS Environmental Services, Inc.) using the hollow stem auger (HSA) drilling method and supervised by a Shaw geologist. The wells were installed in a nominal 6-inch diameter borehole. Piezometers were constructed with flush-threaded, 2 inch diameter, Schedule 40, PVC riser and 0.010-inch slotted PVC well screen. The filter pack for each piezometer consisted of #1 Morie sand, extending to 1.0 to 1.5 feet above the top of screen. A six-inch transition pack of #0 sand was placed above the #1 Morie sand, and a 3-foot bentonite seal was placed above the filter pack. The remaining annular space was filled with cement bentonite grout emplaced to within 2 feet of the surface via Tremie pipe. Each well was completed with a locking steel well casing protector installed in a 24 inch by 24 inch concrete pad at the ground surface. Well construction details are summarized in **Table 5-4**.

Well development was accomplished by surging the well with a surge block and pumping the groundwater until the water was clear and the well was sediment free to the fullest extent practical. Wells were developed using a submersible pump and water was not be added to the well to aid in development. The pump, hose, and cable were decontaminated following the procedures outlined in Demonstration Plan.

Well installation and development activities (including equipment decontamination), and management of IDW were conducted as detailed in the Demonstration Plan (Shaw 2007). Field activities were conducted in Level D Protection. Underground utility clearances were obtained for all intrusive site activities. Clearance of all underground utilities was arranged with appropriate Fort Dix facility personnel and local utility companies.

After the wells were completed, each well was surveyed by a licensed surveyor to determine its horizontal location to within ± 1 foot, and the elevation of the top of the inner PVC well casing to a ± 0.01 -foot precision.

5.2.3 Slug Testing

Rising and falling head slug tests were performed on March 30, 2007 at selected demonstration area monitoring wells and piezometers to verify and/or estimate the hydraulic conductivity in the various stratigraphic layers within the demonstration area. This information was ultimately used to select the most appropriate screen intervals for the field demonstration injection/extraction and monitoring wells. Slug testing was performed at the following locations:

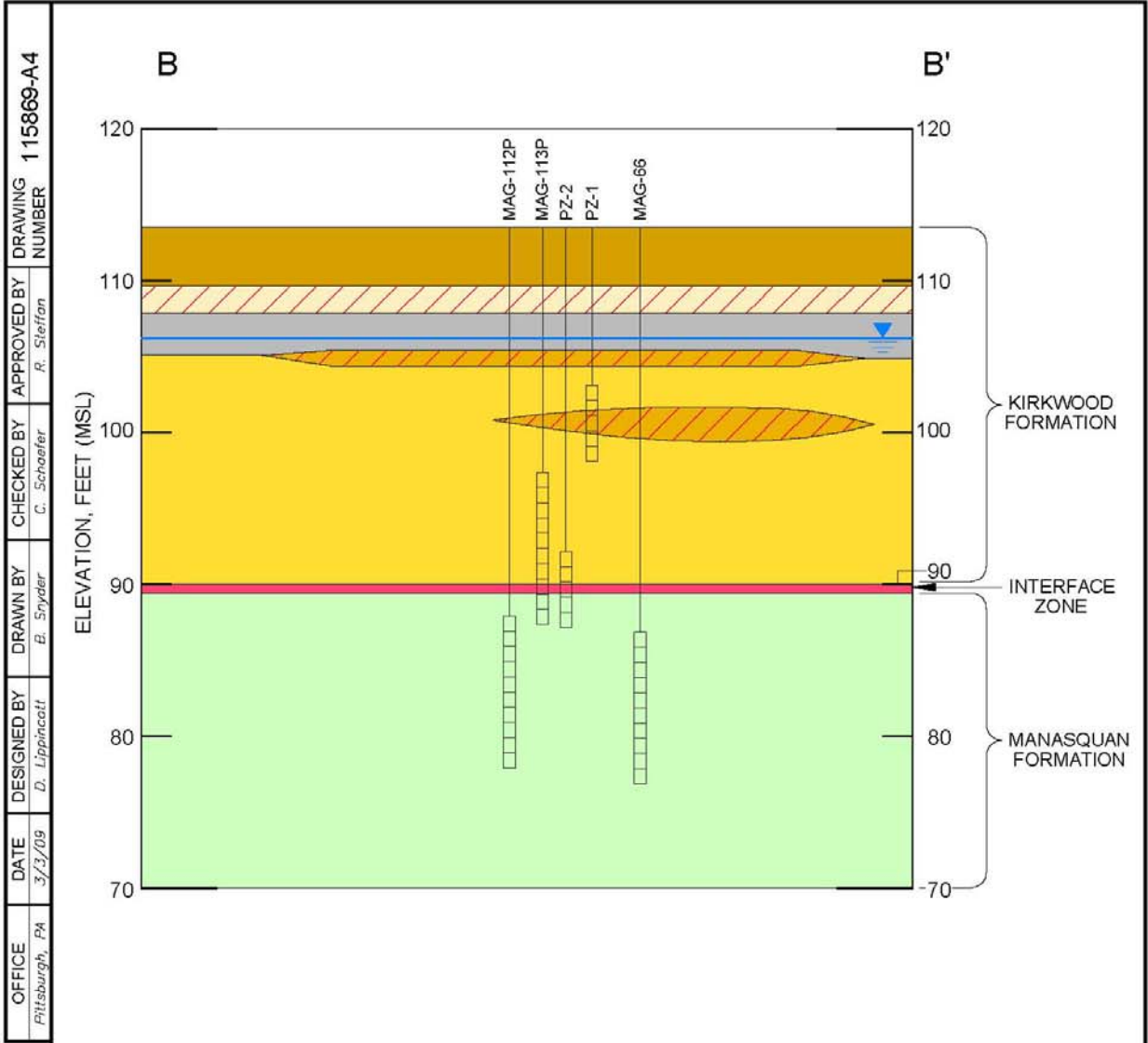

File: O:\Project\MFCEE\Fort Dix\115869A4.dwg
 Plot Date/Time: Jul 23, 2009 - 2:39pm
 Plotted By: William Snyder

LEGEND:

- SILTY FINE SAND (DARK BROWN)
- CLAYEY SAND (TAN, GRAY AND RED MOTTLING)
- SILTY FINE SAND (LIGHT GRAY)
- SILTY FINE SAND (MEDIUM GRAY)
- FINE-COARSE SAND (GREENISH GRAY)
- FINE SAND (GREENISH GRAY)
- CLAYEY SAND LENS
- MONITORING WELL SCREEN INTERVAL

Shaw Environmental, Inc.
ESTCP FIELD DEMONSTRATION BIOAUGMENTATION FOR GROUNDWATER REMEDIATION
FIGURE 5-4 GEOLOGIC CROSS SECTION B-B' DEMONSTRATION AREA PUMP TEST MAG-1 AREA FORT DIX, NEW JERSEY

**Table 5-4
Summary of As-Built Well Construction Details**

Well ID	Ground Surface Elevation (feet MSL)	Top of Casing Elevation (feet MSL)	Well Diameter (inches)	Depth to Top of Screen (feet bgs)	Depth to Bottom of Screen (feet bgs)	Screen Length (feet)	Top of Screen Elevation (feet MSL)	Bottom of Screen Elevation (feet MSL)
Injection Wells								
IW-1	109.27	111.44	6.0	8.0	18.0	10.0	101.3	91.3
IW-2	110.93	113.54	6.0	9.5	19.5	10.0	101.4	91.4
IW-3	112.38	115.28	6.0	11.5	21.5	10.0	100.9	90.9
IW-4	114.87	118.70	6.0	13.5	23.5	10.0	101.4	91.4
Extraction Wells								
EX-1	110.15	113.85	6.0	8.5	18.5	10.0	101.7	91.7
EX-2	111.90	115.06	6.0	10.5	20.5	10.0	101.4	91.4
EX-3	113.46	116.54	6.0	12.0	22.0	10.0	101.5	91.5
EX-4	116.25	118.91	6.0	15.0	25.0	10.0	101.3	91.3
Monitoring Wells								
BMW-1	109.76	112.10	2.0	8.0	18.0	10.0	101.8	91.8
BMW-2	110.10	112.44	2.0	8.5	18.5	10.0	101.6	91.6
BMW-3	111.43	111.14	2.0	10.0	20.0	10.0	101.4	91.4
BMW-4	110.70	111.28	2.0	10.5	20.5	10.0	100.2	90.2
BMW-5	112.98	115.38	2.0	11.5	21.5	10.0	101.5	91.5
BMW-6	113.25	112.88	2.0	11.5	21.5	10.0	101.8	91.8
BMW-7	115.50	117.77	2.0	14.0	24.0	10.0	101.5	91.5
BMW-8	116.31	118.31	2.0	14.5	24.5	10.0	101.8	91.8
BMW-9	109.66	111.96	2.0	8.0	18.0	10.0	101.7	91.7
BMW-10	109.24	111.72	2.0	8.0	18.0	10.0	101.2	91.2
BMW-11	110.27	109.92	2.0	9.0	19.0	10.0	101.3	91.3
Piezometers								
PZ-1	112.86	115.41	2.0	10.0	15.0	5.0	102.9	97.9
PZ-2	112.71	115.23	2.0	20.5	25.5	5.0	92.2	87.2
Existing Monitoring Wells								
MAG-4	109.50	111.31	4.0	15.0	25.0	10.0	94.5	84.5
MAG-66	112.33	114.42	4.0	25.5	35.5	10.0	86.8	76.9
MAG-112P	113.22	115.37	2.0	25.0	35.0	10.0	88.2	78.2
MAG-113P	113.46	115.42	2.0	16.0	26.0	10.0	97.5	87.5

- MAG-66
- MAG-112P
- MAG-113P
- PZ-1
- PZ-2

Slug test data were analyzed using AQTESOLV Pro software (See **Appendix F** for analysis). Results of the slug testing are summarized in **Table 5-5**. Hydraulic conductivities ranged from 2.1 ft/day to 5.5 ft/day. Results of the slug testing were used to refine the site hydrogeologic conceptual model, and in constructing a three-dimensional groundwater hydrogeologic fate and transport model (**Section 5.4.1**).

Table 5-5
Summary of Slug Testing Analysis Data

Well	Slug Test	Hydraulic Conductivity		Geometric Mean Hydraulic Conductivity	
		ft/day	cm/sec	ft/day	cm/sec
PZ-1	Falling Head	2.37	8.36E-04	2.06	7.27E-04
	Rising Head	1.79	6.32E-04		
PZ-2	Falling Head	5.61	1.98E-03	5.50	1.94E-03
	Rising Head	5.40	1.91E-03		
MAG-113P	Falling Head	3.85	1.36E-03	2.70	9.52E-04
	Rising Head	1.89	6.67E-04		
MAG-112P	Falling Head	2.70	9.54E-04	2.76	9.73E-04
	Rising Head	2.81	9.92E-04		
MAG-66	Falling Head	3.17	1.12E-03	3.50	1.24E-03
	Rising Head	3.87	1.36E-03		

5.2.4 Aquifer Pump Testing

Short-term aquifer pump tests were performed to evaluate vertical hydraulic conductivities and extraction well radius of influence within the demonstration area. Information obtained during these pump tests was ultimately used to determine well spacing and pumping rates for the demonstration. Specifically, the aquifer pump tests were needed to determine the impact of the higher permeability Interface Zone has on the Manasquan formation during pumping within the Kirkwood formation. As discussed in **Section 4.2**, the 4- to 8-inch Interface Zone at the base of the Kirkwood formation consists of fine to coarse sands and fine gravel. This zone appears to exhibit significantly higher permeability than the formations above and below. Additionally, significant difference in VOC concentrations above and below this zone suggests that the higher permeability formation interface inhibits downward groundwater flow and mixing by creating preferential horizontal flow paths.

Pump tests were performed at piezometer PZ-1 (**Figure 5-2**), which is screened completely within the Kirkwood formation, and above the Interface Zone (**Figure 5-4**). During testing, water levels in the pumping well and seven nearby monitoring wells were monitored. Data loggers were used in the pumping well and the four closest monitoring wells (PZ-2, MAG-66, MAG-112P, and MAG-113P; **Figures 5-2** and **5-4**) to record groundwater elevation data during the testing. Manual water level measurements were collected periodically at three additional nearby monitoring wells (MAG-110P, MAG-201, and MAG-202; **Figure 5-2**).

A step-drawdown test was performed on April 10, 2007 to estimate well performance, and determine a sustainable optimum pumping rate for the pump test well. Three pumping steps, each lasting between 30 and 90 minutes, were conducted. Pumping rates for each step of the step drawdown test were 0.5 gpm, 0.8 gpm, and 1.0 gpm, respectively. The corresponding water level drawdown in nearby observation wells were measured as a function of time. Data from the step tests were analyzed to determine the optimum pumping rate for the constant rate test at this well. Based on these data, the pumping rate selected for the constant rate pump test was 0.8 gpm.

The constant rate pumping test was conducted on April 11, 2007. Groundwater was extracted from PZ-1 at a constant rate of 0.8 gpm for 5 hours. Measurements of drawdown versus time were collected at the same monitoring well locations as the step-drawdown test, including wells MAB-66 and MAG-112P (which are screened just below the Interface Zone) and wells MAG-113P and MAG-PZ2 (which are screened across the Interface Zone) (**Figure 5-4**). The recovery of water levels in the pumping well and observation wells were also monitored after pumping was terminated (recovery phase).

The pump test data were analyzed using AQTESOLV Pro software. Pump test analysis is included in **Appendix F**. **Table 5-6** summarizes the hydraulic parameters calculated from the pumping well and the four monitoring wells that had data loggers installed. The hydraulic conductivity value and storage coefficient for PZ-1 (screened entirely within the Kirkwood formation) were calculated at 1.9 ft/day and 0.01, respectively. This value of the aquifer storage coefficient is a typical value for an unconfined aquifer. The hydraulic conductivity values for MAG-66 and MAG-112P (screened entirely within the Manasquan formation, and below the Interface Zone) were calculated at 9.0 ft/day and 11.2 ft/day, respectively. Storage coefficients at these two wells were 2.1×10^{-5} and 5.5×10^{-5} , respectively. The higher hydraulic conductivity values calculated for these observation wells (compared to PZ-1 and slug test results at these wells) are most likely due to the influence of the higher permeability Interface Zone between the pumping well and these two wells.

Hydraulic conductivity values and storage coefficients for PZ-2 and MAG-113P (screened across the Interface Zone, and partially within the Kirkwood and Manasquan formations) were similar to those of the pumping well (**Table 5-6**). The anisotropy ratios (vertical hydraulic conductivity divided by horizontal hydraulic conductivity) for PZ-2 and MAG-113P were extremely low (0.045 and 0.005, respectively) (**Table 5-6**), indicating that the horizontal hydraulic conductivities at these wells (screened across the Interface Zone) are 2 to 3 orders of magnitude higher than the vertical hydraulic conductivities. These results suggest that there is preferential horizontal groundwater flow within the Interface Zone that is likely minimizing mixing of

groundwater between the Kirkwood and Manasquan Formations, and hence minimizing downward migration of contaminants.

**Table 5-6
Summary of Pump Testing Analysis Data**

Well	Transmissivity (ft ² /day)	Hydraulic Conductivity (ft/day)	Storativity	Specific Yield	Anisotropy (K _z /K _r)
PZ-1	93.0	1.9	1.0E-03	0.021	0.45
PZ-2	63.6	1.3	1.0E-03	0.021	0.045
MAG-113P	254	5.1	2.0E-03	0.030	0.005
MAG-112P	560	11.2	5.5E-05	0.0034	1.00
MAG-66	452	9.0	2.1E-05	0.0028	1.00

Based on these results, and the contaminant distribution, it was determined that the treatment zone for the demonstration would be within the Kirkwood formation.

Approximately 450 gallons of groundwater was extracted during the pump tests. This groundwater was collected and stored in a temporary storage tank, treated by passing through a drum of activated carbon, then discharged to the ground surface, as described in the Demonstration Plan.

5.2.5 Baseline Groundwater Sampling

Baseline groundwater sampling events were conducted on October 10, 2007 and November 7, 2007 in the demonstration Area, after the new demonstration wells were installed (**Section 5.4.3.2**) and prior to system testing (**Section 5.5.1**). These samples were used to establish the baseline conditions of groundwater quality and biogeochemistry prior to system start-up and bromide tracer testing. The demonstration well layout is provided in **Figure 5-5**. **Figure 5-1** and **Table 5-1** summarize the groundwater sampling schedule, and **Table 5-7** lists the wells that were sampled and the analyses that were performed during baseline sampling.

Sampling was performed by Shaw personnel, in accordance with the procedures described in the Demonstration Plan (Shaw, 2007). Groundwater samples were collected utilizing low-flow purging in accordance with NJDEP Low Flow Purging and Sampling Guidance, with the exception of purge times being limited to 60 minutes at each well before samples were collected. Samples were obtained using a dedicated submersible bladder pump and Teflon tubing. A YSI field meter with a flow-through cell was used to collect measurement of field geochemical parameters (pH, ORP, temperature, specific conductivity, and dissolved oxygen). Groundwater samples were submitted to the Shaw Environmental Analytical Laboratory in Lawrenceville, New Jersey.

OFFICE: Pittsburgh, PA
 DATE: 2/26/09
 DESIGNED BY: D. Lippincott
 DRAWN BY: B. Snyder
 CHECKED BY: C. Schoefer
 APPROVED BY: R. Steffan
 DRAWING NUMBER: 115869-B8

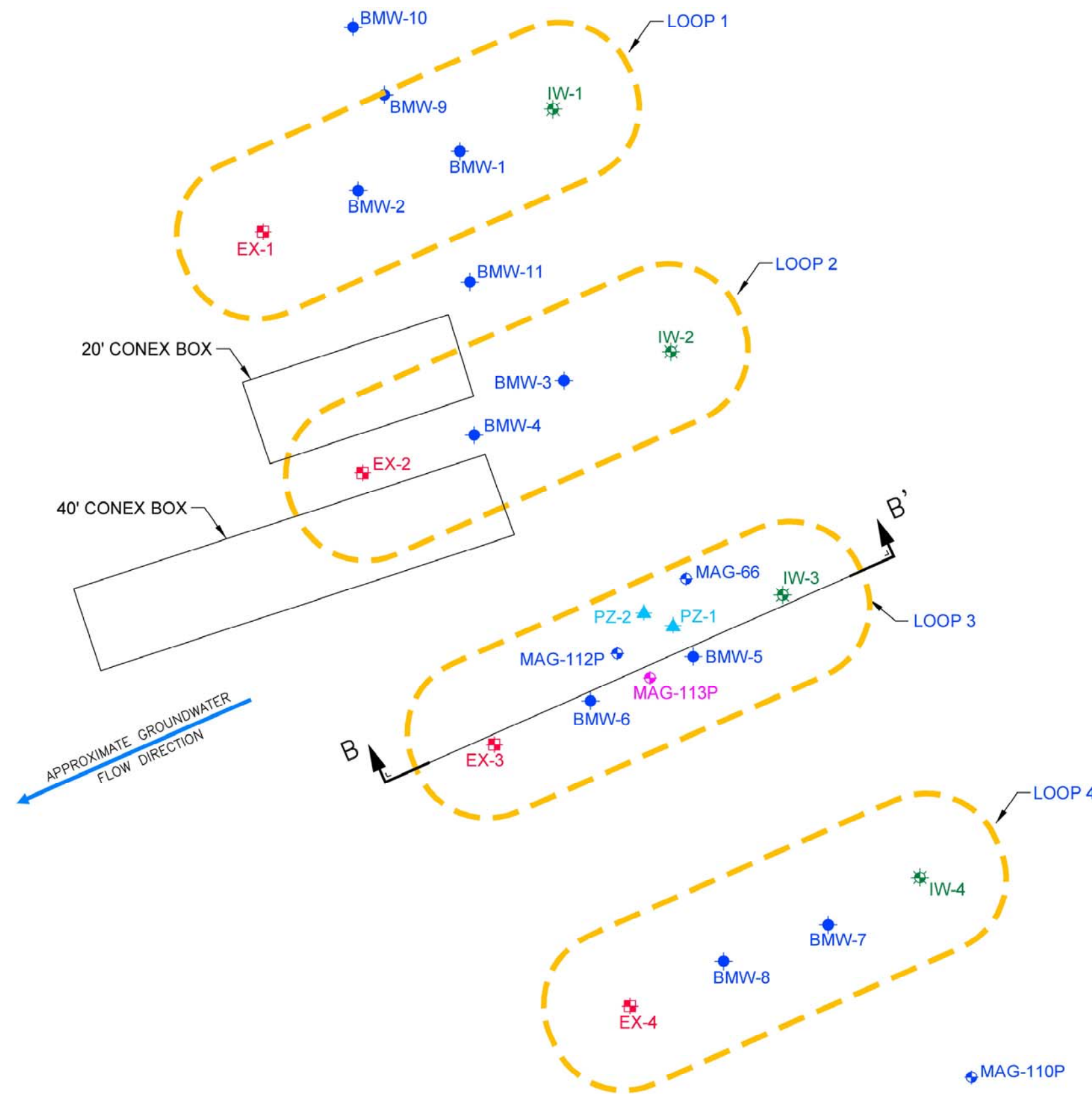

- LEGEND:**
- MONITORING WELL (KIRKWOOD FORMATION)
 - MONITORING WELL (MANASQUAN FORMATION)
 - DEMONSTRATION MONITORING WELL (KIRKWOOD FORMATION)
 - INJECTION WELL
 - EXTRACTION WELL
 - PIEZOMETER



Shaw Shaw Environmental, Inc.

ESTCP FIELD DEMONSTRATION
 BIOAUGMENTATION FOR
 GROUNDWATER REMEDIATION

FIGURE 5-5
 DEMONSTRATION WELL LAYOUT

MAG-1 AREA
 FORT DIX, NEW JERSEY

File: O:\Project\AFCEE\Fort Dix\115869B8.dwg
 Plot Date/Time: Jul 23, 2009 - 1:08pm
 Plotted By: william.snyder

**Table 5-7
Summary of Demonstration Sampling Locations and Parameters**

Description	Duration	Sampling Event	Frequency	Wells Sampled	Parameters Analyzed
Baseline Monitoring	5 weeks	Baseline #1	5 weeks prior to start-up	BMW-1 through BMW-11, PZ-1, PZ-2, MAG-113P, and IW-1 through IW-4	List 1 Dissolved Iron and Manganese
		Baseline #2	1 week prior to start-up	BMW-1 through BMW-11, EX-1 through EX-4, and IW-1 through IW-4	VOCs, reduced gases, Anions, and VFAs Dissolved Iron and Manganese and qPCR on EX wells
System Start-Up and Tracer Testing	10 weeks	Tracer #1	Day 4	BMW-1 through BMW-8	Anions
		Tracer #2	Day 10	BMW-1 through BMW-11, PZ-1, PZ-2, MAG-113P, and EX-1 through EX-4	Anions and VFAs
		Tracer #3	Day 18	BMW-1 through BMW-11, PZ-1, PZ-2, MAG-113P, and EX-1 through EX-4	List 1
		Tracer #4 and #5	Days 25 and 32	BMW-1 through BMW-11, PZ-1, PZ-2, MAG-113P, and EX-1 through EX-4	Anions and VFAs
		Tracer #6	Day 48	BMW-1 through MW-8, PZ-1, PZ-2, MAG-113P, and EX-1 through EX-4	Anions and VFAs
		Pre-Bioaugmentation	3 days prior to Bioaugmentation #1	BMW-1 through BMW-11, PZ-1, PZ-2, MAG-4, MAG-113P, EX-1 through EX-4, and IW-1 through IW-4	List 1 Dissolved Iron and Manganese
		Performance Monitoring #1 and #2	Weeks 1 and 3	BMW-1 through MW-8, and EX-1 through EX-4	List 1
		Performance Monitoring #3 and #4	Weeks 4 and 8	BMW-1, BMW-3, BMW-5, BMW-7, PZ-2, and IW-1 through IW-4	List 1
		Performance Monitoring #5	Month 3	BMW-1, BMW-2, BMW-3, BMW-5, BMW-7, PZ-2, and IW-1 through IW-4	List 1
		Performance Monitoring #6	Month 4	BMW-1 through BMW-8, PZ-2, and EX-1 through EX-4	List 1
		Performance Monitoring #7 through #10	Months 4, 5, 6 and 8	BMW-1 through BMW-8, PZ-1, PZ-2, MAG-113P, and EX-1 through EX-4	List 1
		Performance Monitoring #11	Month 9	BMW-1 through BMW-11, PZ-1, PZ-2, MAG-4, MAG-113P, EX-1 through EX-4, and IW-1 through IW-4	List 1 Dissolved Iron and Manganese
Performance Monitoring #12	Month 11	BMW-1 through BMW-8, PZ-1, PZ-2, MAG-113P, and EX-1 through EX-4	List 1		
Bioaugmentation, Systems Operation, and Performance Monitoring	11.5 months				

Notes:

- Field parameters (pH, ORP, DO, conductivity and temperature) and water table elevation measurements were collected from each well during sampling.
- See Table 5-13 for sample quantities.

<p><u>List 1</u> VOCs Reduced gases (methane, ethane, ethene) Anions (bromide, nitrate, sulfate, chloride) Volatile Fatty Acids (VFAs) qPCR (quantitative polymerase chain reaction)</p>
--

Samples were analyzed for VOCs, reduced gases, anions (including nitrate and sulfate), VFAs, dissolved iron and manganese, and DHC (**Table 5-7**). With the exception of dissolved iron and manganese, all analyses were performed by Shaw's New Jersey Certified Analytical Laboratory in Lawrenceville, NJ. Dissolved iron and manganese analyses were performed by ChemTech Laboratories, Mountainside, NJ, under subcontract to Shaw.

Laboratory analytical, DHC data, and field parameter results are summarized in **Tables 5-8, 5-9, and 5-10**, respectively. With the exception of wells PZ-1, PZ-2, and MAG-113P (sampled during the first Baseline sampling event), the following summarizes results from the second baseline sampling, as all of the injection and extraction wells were sampled during this event.

Chlorinated Ethenes

Figure 5-6 shows the baseline chlorinated ethene (TCE, cDCE and VC) concentrations within the demonstration area. TCE concentrations within the Kirkwood aquifer ranged from 17 µg/L to 1,800 µg/L (**Table 5-8**). Concentrations were generally higher in Loops 2 and 3, located within the center of the demonstration area. TCE concentrations in PZ-2 and MAG-113P (screened across the Formation Interface, and partially within the Kirkwood and Manasquan aquifers, **Figure 5-7**) were 1,000 µg/L and 1,400 µg/L, respectively.

cDCE concentrations within the Kirkwood aquifer ranged from 45 µg/L to 1,400 µg/L (**Table 5-8**). As with TCE concentrations, cDCE concentrations were generally higher in Loops 2 and 3. TCE concentrations in PZ-2 and MAG-113P were 130 µg/L and 270 µg/L, respectively. Vinyl chloride was not detected in any of the wells sampled during either of the Baseline events. The presence of cDCE and lack of VC (and ethene) indicated that the indigenous microbial population within the aquifer were incapable of dechlorination of TCE beyond cDCE. This was also observed in the microcosm testing (**Section 5.3.1**), and is referred to as a "DCE stall".

Reduced gases

Ethene was not detected in any of the wells sampled during either of the Baseline events. Methane concentrations within the Kirkwood aquifer ranged from 3.34 µg/L to 4,140 µg/L (**Table 5-8**). Concentrations were generally higher in Loops 1 and 2 (particularly Loop 1), located in the northern portion of the demonstration area. Methane concentrations in PZ-2 and MAG-113P were 31.2 µg/L and 88.2 µg/L, respectively. Ethane was not detected in any of the wells throughout the demonstration area. The absence of measurable ethene concentrations indicated that complete dechlorination of TCE was not occurring in the demonstration area.

Anions

Anion data collected during Baseline sampling included nitrate, sulfate, bromide, and fluoride. Bromide and fluoride were the tracers used during tracer test, and are discussed in **Section 5.5.2**. Nitrate was not detected in any of the wells sampled during either of the Baseline events. Sulfate concentrations within the Kirkwood aquifer ranged from 23.0 mg/L to 73.0 mg/L (**Table 5-8**). Sulfate concentrations in wells PZ-2 and MAG-113P were 63.6 mg/L and 62.9 mg/L, respectively. The lack of nitrate and presence of sulfate at these concentrations (in addition to field ORP and DO measurements, discussed below) indicated that mildly reducing conditions existed in the demonstration area.

Table 5-8
Summary of Laboratory Analytical Data

Event	Sampling Date	Days	TCE (µg/L)										
			BMW-1	BMW-2	BMW-3	BMW-4	BMW-5	BMW-6	BMW-7	BMW-8	BMW-9	BMW-10	BMW-11
Baseline Sampling #1	10/10/2007	-105	140	30	98	680	1500	950	190	260	110	250	580
Baseline Sampling #2	11/7/2007	-77	67	23	110	650	1600	1200	170	180	46	73	440
Tracer Sampling #3	12/4/2007	-50	81	52	260	510	1300	670	66	87	40	88	450
Pre-Bioaugmentation Sampling	1/21/2008	-3	74	57	170	200	940	390	27	240	43	42	400
Performance Monitoring #1	1/30/2008	6	94	110	250	220	930	170	45	190	NS	NS	NS
Performance Monitoring #2	2/5/2008	12	94	54	230	300	740	180	22	340	NS	NS	NS
Performance Monitoring #3	2/19/2008	26	93	NS	150	NS	670	NS	24	NS	NS	NS	NS
Performance Monitoring #4	3/17/2008	53	98	NS	200	NS	310	NS	14	NS	NS	NS	NS
Performance Monitoring #5	4/17/2008	84	93	43	340	NS	122	NS	7	NS	NS	NS	NS
Performance Monitoring #6	5/19/2008	116	1**	38	59	420	27	200	4**	100	NS	NS	NS
Performance Monitoring #7	6/4/2008	132	4**	81	56	560	50	230	4**	46	NS	NS	NS
Performance Monitoring #8	6/23/2008	151	1**	110	68	480	30	130	5	71	NS	NS	NS
Performance Monitoring #9	7/22/2008	180	<5	110	33	300	2	200	4**	13	NS	NS	NS
Performance Monitoring #10	9/22/2008	242	8	70	5	180	39	20	21	15	NS	NS	NS
Performance Monitoring #11	11/11/2008	292	2**	52	6	180	5	8	18	8	20	290	910
Performance Monitoring #12	1/5/2009	347	<5	1**	9	66	<5	<5	<5	4**	NS	NS	NS

Event	Sampling Date	Days	TCE (µg/L)										
			PZ-1	PZ-2	MAG-113P	MAG-4	IW-1	IW-2	IW-3	IW-4	EX-1	EX-2	EX-3
Baseline Sampling #1	10/10/2007	-105	490	1000	1400	NS	620	970	1600	78	NS	NS	NS
Baseline Sampling #2	11/7/2007	-77	NS	NS	NS	NS	450	620	1800	180	150	17	180
Tracer Sampling #3	12/4/2007	-50	480	600	830	NS	NS	NS	NS	NS	260	420	440
Pre-Bioaugmentation Sampling	1/21/2008	-3	300	310	460	190	NS	NS	NS	NS	290	720	390
Performance Monitoring #1	1/30/2008	6	NS	NS	NS	NS	NS	NS	NS	NS	250	550	730
Performance Monitoring #2	2/5/2008	12	NS	NS	NS	NS	NS	NS	NS	NS	350	720	120
Performance Monitoring #3	2/19/2008	26	NS	450	NS	NS	NS	NS	NS	NS	NS	NS	NS
Performance Monitoring #4	3/17/2008	53	NS	570	NS	NS	240	650	630	160	NS	NS	NS
Performance Monitoring #5	4/17/2008	84	NS	425	NS	NS	180	448	530	107	NS	NS	NS
Performance Monitoring #6	5/19/2008	116	NS	460	NS	NS	NS	NS	NS	NS	90	200	460
Performance Monitoring #7	6/4/2008	132	170	270	68	NS	NS	NS	NS	NS	190	380	480
Performance Monitoring #8	6/23/2008	151	90	140	110	NS	NS	NS	NS	NS	180	360	380
Performance Monitoring #9	7/22/2008	180	28	57	81	NS	NS	NS	NS	NS	180	220	300
Performance Monitoring #10	9/22/2008	242	97	44	120	NS	NS	NS	NS	NS	180	320	490
Performance Monitoring #11	11/11/2008	292	40	18	27	460	110	2**	<5	11	48	35	80
Performance Monitoring #12	1/5/2009	347	4**	<5	2**	NS	NS	NS	NS	NS	26	96	77

**Estimated result; Result is less than reporting limit
NS, Not Sampled

Table 5-8
Summary of Laboratory Analytical Data

Event	Sampling Date	Days	cis-DCE (µg/L)										
			BMW-1	BMW-2	BMW-3	BMW-4	BMW-5	BMW-6	BMW-7	BMW-8	BMW-9	BMW-10	BMW-11
Baseline Sampling #1	10/10/2007	-105	210	190	470	1300	410	480	110	140	130	62	37
Baseline Sampling #2	11/17/2007	-77	310	280	480	1400	370	550	90	150	160	100	45
Tracer Sampling #3	12/4/2007	-50	310	380	580	1300	580	630	82	120	220	150	160
Pre-Bioaugmentation Sampling	1/21/2008	-3	430	200	750	520	300	600	80	260	270	170	89
Performance Monitoring #1	1/30/2008	6	350	180	630	820	330	420	90	260	NS	NS	NS
Performance Monitoring #2	2/5/2008	12	440	200	850	640	450	250	75	250	NS	NS	NS
Performance Monitoring #3	2/19/2008	26	440	NS	940	NS	400	NS	110	NS	NS	NS	NS
Performance Monitoring #4	3/17/2008	53	240	NS	930	NS	350	NS	100	NS	NS	NS	NS
Performance Monitoring #5	4/17/2008	84	338	194	1020	NS	543	NS	99	NS	NS	NS	NS
Performance Monitoring #6	5/19/2008	116	3**	170	180	670	550	340	86	270	NS	NS	NS
Performance Monitoring #7	6/4/2008	132	17	200	210	730	340	360	78	140	NS	NS	NS
Performance Monitoring #8	6/23/2008	151	5	170	170	830	530	440	100	250	NS	NS	NS
Performance Monitoring #9	7/22/2008	180	9	220	200	900	240	640	120	150	NS	NS	NS
Performance Monitoring #10	9/22/2008	242	79	230	110	1700	480	470	160	190	NS	NS	NS
Performance Monitoring #11	11/11/2008	292	39	280	48	1200	62	98	150	290	280	77	110
Performance Monitoring #12	1/5/2009	347	4**	71	130	310	14	20	150	96	NS	NS	NS

Event	Sampling Date	Days	cis-DCE (µg/L)										
			PZ-1	PZ-2	MAG-113P	MAG-4	IW-1	IW-2	IW-3	IW-4	EX-1	EX-2	EX-3
Baseline Sampling #1	10/10/2007	-105	500	130	270	NS	49	62	260	50	NS	NS	NS
Baseline Sampling #2	11/17/2007	-77	NS	NS	NS	NS	49	60	260	110	220	210	430
Tracer Sampling #3	12/4/2007	-50	280	600	520	NS	NS	NS	NS	NS	290	140	550
Pre-Bioaugmentation Sampling	1/21/2008	-3	310	670	740	34	NS	NS	NS	NS	390	1200	660
Performance Monitoring #1	1/30/2008	6	NS	NS	NS	NS	NS	NS	NS	NS	270	810	610
Performance Monitoring #2	2/5/2008	12	NS	NS	NS	NS	NS	NS	NS	NS	270	830	580
Performance Monitoring #3	2/19/2008	26	NS	1300	NS	NS	NS	NS	NS	NS	NS	NS	NS
Performance Monitoring #4	3/17/2008	53	NS	1500	NS	NS	310	590	620	200	NS	NS	NS
Performance Monitoring #5	4/17/2008	84	NS	1077	NS	NS	379	602	782	133	NS	NS	NS
Performance Monitoring #6	5/19/2008	116	NS	1200	NS	NS	NS	NS	NS	NS	280	870	420
Performance Monitoring #7	6/4/2008	132	450	1000	1200	NS	NS	NS	NS	NS	310	620	540
Performance Monitoring #8	6/23/2008	151	650	1000	1300	NS	NS	NS	NS	NS	340	720	570
Performance Monitoring #9	7/22/2008	180	900	880	1200	NS	NS	NS	NS	NS	290	380	550
Performance Monitoring #10	9/22/2008	242	850	1200	1300	NS	NS	NS	NS	NS	400	860	1200
Performance Monitoring #11	11/11/2008	292	630	1200	1500	40	420	1300	1400	330	420	1300	1400
Performance Monitoring #12	1/5/2009	347	210	2100	1600	NS	NS	NS	NS	NS	210	800	620

**Estimated result; Result is less than reporting limit
NS, Not Sampled

Table 5-8
Summary of Laboratory Analytical Data

		Vinyl Chloride (µg/L)											
Event	Sampling Date	Days	BMW-1	BMW-2	BMW-3	BMW-4	BMW-5	BMW-6	BMW-7	BMW-8	BMW-9	BMW-10	BMW-11
Baseline Sampling #1	10/10/2007	-105	<5	<5	<100	<100	<5	<100	<5	<100	<5	<5	<100
Baseline Sampling #2	11/7/2007	-77	<10	<10	<100	<100	<100	<100	<10	<10	<10	<10	<10
Tracer Sampling #3	12/4/2007	-50	<100	<100	<100	<100	<42	<42	<42	<42	<42	<42	<100
Pre-Bioaugmentation Sampling	1/21/2008	-3	<5	<5	<5	<5	<5	<5	<5	<5	<5	<5	<5
Performance Monitoring #1	1/30/2008	6	<5	<5	<5	<5	<5	<5	<5	<5	NS	NS	NS
Performance Monitoring #2	2/5/2008	12	<5	<5	<5	<5	<5	<5	<5	<5	NS	NS	NS
Performance Monitoring #3	2/19/2008	26	<5	NS	<5	NS	<5	NS	<5	NS	NS	NS	NS
Performance Monitoring #4	3/17/2008	53	<5	NS	<5	NS	<5	NS	<5	NS	NS	NS	NS
Performance Monitoring #5	4/17/2008	84	<5	<5	<5	NS	0.86	NS	<5	NS	NS	NS	NS
Performance Monitoring #6	5/19/2008	116	43	<5	110	<5	84	1**	<5	<5	NS	NS	NS
Performance Monitoring #7	6/4/2008	132	28	12	77	<5	110	<5	<5	<5	NS	NS	NS
Performance Monitoring #8	6/23/2008	151	24	17	90	<5	160	2**	<5	<5	NS	NS	NS
Performance Monitoring #9	7/22/2008	180	13	<5	96	<5	94	2**	<5	<5	NS	NS	NS
Performance Monitoring #10	9/22/2008	242	11	<5	35	<5	31	66	<5	<5	NS	NS	NS
Performance Monitoring #11	11/11/2008	292	5	<5	25	3**	14	19	<5	<5	<5	<5	<5
Performance Monitoring #12	1/5/2009	347	<5	<5	63	25	14	5	<5	<5	NS	NS	NS

		Vinyl Chloride (µg/L)												
Event	Sampling Date	Days	PZ-1	PZ-2	MAG-1/3P	MAG-4	IW-1	IW-2	IW-3	IW-4	EX-1	EX-2	EX-3	EX-4
Baseline Sampling #1	10/10/2007	-105	<100	<100	<100	NS	<100	<100	<100	<100	NS	NS	NS	NS
Baseline Sampling #2	11/7/2007	-77	NS	NS	NS	NS	<10	<50	<50	<10	<10	<10	<10	<10
Tracer Sampling #3	12/4/2007	-50	<70	<100	<100	NS	NS	NS	NS	NS	<100	<100	<100	<42
Pre-Bioaugmentation Sampling	1/21/2008	-3	<5	<5	<5	<5	NS	NS	NS	NS	<5	<5	<5	<5
Performance Monitoring #1	1/30/2008	6	NS	NS	NS	NS	NS	NS	NS	NS	<5	<5	<5	<5
Performance Monitoring #2	2/5/2008	12	NS	NS	NS	NS	NS	NS	NS	NS	<5	<5	<5	<5
Performance Monitoring #3	2/19/2008	26	NS	<5	NS	NS	NS	NS	NS	NS	NS	NS	NS	NS
Performance Monitoring #4	3/17/2008	53	NS	<5	NS	NS	<5	<5	<5	<5	NS	NS	NS	NS
Performance Monitoring #5	4/17/2008	84	NS	3**	NS	NS	<5	<5	<5	<5	NS	NS	NS	NS
Performance Monitoring #6	5/19/2008	116	NS	2**	NS	NS	NS	NS	NS	NS	<5	<5	<5	<5
Performance Monitoring #7	6/4/2008	132	<5	4**	2**	NS	NS	NS	NS	NS	<5	<5	<5	<5
Performance Monitoring #8	6/23/2008	151	1**	5	2**	NS	NS	NS	NS	NS	<5	<5	<5	<5
Performance Monitoring #9	7/22/2008	180	<5	3**	1**	NS	NS	NS	NS	NS	<5	<5	<5	<5
Performance Monitoring #10	9/22/2008	242	<5	2**	2**	NS	NS	NS	NS	NS	<5	<5	<5	<5
Performance Monitoring #11	11/11/2008	292	38	<5	33	<5	5	<5	120	<5	<5	<5	26	<5
Performance Monitoring #12	1/5/2009	347	57	17	97	NS	NS	NS	NS	NS	<5	<5	86	<5

**Estimated result; Result is less than reporting limit
NS, Not Sampled

Table 5-8
Summary of Laboratory Analytical Data

Event	Sampling Date	Days	Ethene (µg/L)													
			BMW-1	BMW-2	BMW-3	BMW-4	BMW-5	BMW-6	BMW-7	BMW-8	BMW-9	BMW-10	BMW-11			
Baseline Sampling #1	10/10/2007	-105	<5	<5	<5	<5	<5	<5	<5	<5	<5	<5	<5	<5	<5	<5
Baseline Sampling #2	11/7/2007	-77	<5	<5	<5	<5	<5	<5	<5	<5	<5	<5	<5	<5	<5	<5
Tracer Sampling #3	12/4/2007	-50	<5	<5	<5	<5	<5	<5	<5	<5	<5	<5	<5	<5	<5	<5
Pre-Bioaugmentation Sampling	1/21/2008	-3	<5	<5	<5	<5	<5	<5	<5	<5	<5	<5	<5	<5	<5	<5
Performance Monitoring #1	1/30/2008	6	<5	<5	<5	<5	<5	<5	<5	<5	<5	<5	<5	<5	<5	<5
Performance Monitoring #2	2/5/2008	12	<5	<5	<5	<5	<5	<5	<5	<5	<5	<5	<5	<5	<5	<5
Performance Monitoring #3	2/19/2008	26	<5	NS	<5	NS	<5	<5	<5	<5	<5	<5	<5	<5	<5	<5
Performance Monitoring #4	3/17/2008	53	<2	NS	<2	NS	2.06	NS	0.95	NS	NS	NS	NS	NS	NS	NS
Performance Monitoring #5	4/17/2008	84	<2	<2	<2	NS	1.04**	NS	0.70	NS	NS	NS	NS	NS	NS	NS
Performance Monitoring #6	5/19/2008	116	41.5	<2	77.6	<2	9.40	2.09	0.87	<2	NS	NS	NS	NS	NS	NS
Performance Monitoring #7	6/4/2008	132	35.9	<2	75.5	<5	25.3	<5	<5	<5	<5	<5	<5	<5	<5	<5
Performance Monitoring #8	6/23/2008	151	25.3	3.16	78.5	<5	65.1	1.16	<5	<5	<5	<5	<5	<5	<5	<5
Performance Monitoring #9	7/22/2008	180	27.8	4.79	53.8	<5	80.8	0.74	<5	<5	<5	<5	<5	<5	<5	<5
Performance Monitoring #10	9/22/2008	242	44.5	14.7	78.4	2.39**	96.7	19.3	<5	<5	<5	<5	<5	<5	<5	<5
Performance Monitoring #11	11/11/2008	292	48.0	3.83	48.6	7.01	125	103	<5	<5	<5	<5	<5	<5	<5	<5
Performance Monitoring #12	1/5/2009	347	36.3	15.0	43.5	6.39	186	209	<5	<5	<5	<5	<5	<5	<5	<5

Event	Sampling Date	Days	Ethene (µg/L)													
			PZ-1	PZ-2	MAG-113P	IW-4	IW-3	IW-2	IW-1	EX-1	EX-2	EX-3	EX-4			
Baseline Sampling #1	10/10/2007	-105	<5	<5	<5	<5	<5	<5	<5	<5	<5	<5	<5	<5	<5	<5
Baseline Sampling #2	11/7/2007	-77	NS	NS	NS	NS	NS	NS	NS	NS	NS	NS	NS	NS	NS	NS
Tracer Sampling #3	12/4/2007	-50	<5	<5	<5	<5	<5	<5	<5	<5	<5	<5	<5	<5	<5	<5
Pre-Bioaugmentation Sampling	1/21/2008	-3	<5	<5	<5	<5	<5	<5	<5	<5	<5	<5	<5	<5	<5	<5
Performance Monitoring #1	1/30/2008	6	NS	NS	NS	NS	NS	NS	NS	NS	NS	NS	NS	NS	NS	NS
Performance Monitoring #2	2/5/2008	12	NS	NS	NS	NS	NS	NS	NS	NS	NS	NS	NS	NS	NS	NS
Performance Monitoring #3	2/19/2008	26	NS	<5	NS	NS	NS	NS	NS	NS	NS	NS	NS	NS	NS	NS
Performance Monitoring #4	3/17/2008	53	NS	0.76**	NS	NS	<2	<2	<2	<2	<2	<2	<2	<2	<2	<2
Performance Monitoring #5	4/17/2008	84	NS	2.80	NS	NS	<2	<2	<2	<2	<2	<2	<2	<2	<2	<2
Performance Monitoring #6	5/19/2008	116	NS	0.84**	NS	NS	NS	NS	NS	NS	NS	NS	NS	NS	NS	NS
Performance Monitoring #7	6/4/2008	132	<5	<5	<5	<5	<5	<5	<5	<5	<5	<5	<5	<5	<5	<5
Performance Monitoring #8	6/23/2008	151	<5	2.07	<5	<5	<5	<5	<5	<5	<5	<5	<5	<5	<5	<5
Performance Monitoring #9	7/22/2008	180	<5	1.99**	1.08**	NS	NS	NS	NS	NS	NS	NS	NS	NS	NS	NS
Performance Monitoring #10	9/22/2008	242	0.36**	4.01**	2.35**	NS	NS	NS	NS	NS	NS	NS	NS	NS	NS	NS
Performance Monitoring #11	11/11/2008	292	65.1	8.14	11.3	<5	3.08**	<5	20.1	<5	<5	<5	<5	1.10**	16.6	<5
Performance Monitoring #12	1/5/2009	347	97.5	4.06**	27.4	NS	NS	NS	NS	NS	NS	NS	NS	14.0	1.66**	35.4

**Estimated result; Result is less than reporting limit
NS, Not Sampled

Table 5-8
Summary of Laboratory Analytical Data

Event	Sampling Date	Days	Methane (µg/L)											
			BMW-1	BMW-2	BMW-3	BMW-4	BMW-5	BMW-6	BMW-7	BMW-8	BMW-9	BMW-10	BMW-11	
Baseline Sampling #1	10/10/2007	-105	2730	2940	779	260	86.7	253	9.33	14.5	2670	581	104	
Baseline Sampling #2	11/7/2007	-77	2870	3110	698	360	48.7	272	5.77	11.9	4140	1750	239	
Tracer Sampling #3	12/4/2007	-50	1140	1800	248	313	121	256	14.2	21.7	2420	2420	691	
Pre-Bioaugmentation Sampling	1/21/2008	-3	1000	1090	126	193	98.6	252	69.1	78.0	1460	2230	974	
Performance Monitoring #1	1/30/2008	6	1230	999	145	279	129	327	68.0	112	NS	NS	NS	
Performance Monitoring #2	2/5/2008	12	1690	1220	169	207	160	143	77.5	94.9	NS	NS	NS	
Performance Monitoring #3	2/19/2008	26	990	NS	136	NS	116	NS	83.6	NS	NS	NS	NS	
Performance Monitoring #4	3/17/2008	53	1830	NS	101	NS	111	NS	113	NS	NS	NS	NS	
Performance Monitoring #5	4/17/2008	84	1240	1340	92.1	NS	50.8	NS	65.6	NS	NS	NS	NS	
Performance Monitoring #6	5/19/2008	116	1850	1630	514	86	298	118	71.7	40.2	NS	NS	NS	
Performance Monitoring #7	6/4/2008	132	1090	1370	671	132	159	93.0	35.0	25.6	NS	NS	NS	
Performance Monitoring #8	6/23/2008	151	766	897	752	272	250	104	46.6	49.7	NS	NS	NS	
Performance Monitoring #9	7/22/2008	180	758	739	666	650	222	243	41.7	49.6	NS	NS	NS	
Performance Monitoring #10	9/22/2008	242	1610	765	902	678	1029	384	58.6	39.0	NS	NS	NS	
Performance Monitoring #11	11/11/2008	292	2050	826	568	1080	1040	621	332	77.2	1390	1560	749	
Performance Monitoring #12	1/5/2009	347	2300	660	913	380	2240	579	366	174	NS	NS	NS	

Event	Sampling Date	Days	Methane (µg/L)											
			PZ-1	PZ-2	MAG-113P	MAG-4	IW-1	IW-2	IW-3	IW-4	EX-1	EX-2	EX-3	EX-4
Baseline Sampling #1	10/10/2007	-105	141	31.2	88.2	NS	459	32.4	63.7	4.51	NS	NS	NS	
Baseline Sampling #2	11/7/2007	-77	NS	NS	NS	NS	231	42.0	65.5	12.8	1418	109	81.6	
Tracer Sampling #3	12/4/2007	-50	54.5	43.2	45.0	NS	NS	NS	NS	NS	1690	61.0	54.9	
Pre-Bioaugmentation Sampling	1/21/2008	-3	75.1	53.7	84.7	11	NS	NS	NS	NS	1850	178	70.9	
Performance Monitoring #1	1/30/2008	6	NS	NS	NS	NS	NS	NS	NS	NS	1820	226	97.5	
Performance Monitoring #2	2/5/2008	12	NS	NS	NS	NS	NS	NS	NS	NS	1840	263	88.8	
Performance Monitoring #3	2/19/2008	26	NS	116	NS	NS	NS	NS	NS	NS	NS	NS	NS	
Performance Monitoring #4	3/17/2008	53	NS	208	NS	NS	1560	372	89.0	52.3	NS	NS	NS	
Performance Monitoring #5	4/17/2008	84	NS	104	NS	NS	1320	154	61.5	34.8	NS	NS	NS	
Performance Monitoring #6	5/19/2008	116	NS	78.8	NS	NS	NS	NS	NS	NS	2160	198	93.5	
Performance Monitoring #7	6/4/2008	132	33.8	109	187	NS	NS	NS	NS	NS	1555	250	91.9	
Performance Monitoring #8	6/23/2008	151	50.8	336	1240	NS	NS	NS	NS	NS	1540	188	66.9	
Performance Monitoring #9	7/22/2008	180	159	1850	3630	NS	NS	NS	NS	NS	1360	211	63.8	
Performance Monitoring #10	9/22/2008	242	341	1110	1722	NS	NS	NS	NS	NS	1176	282	180	
Performance Monitoring #11	11/11/2008	292	379	643	974	390	6880	362	332	67.1	1040	569	93.1	
Performance Monitoring #12	1/5/2009	347	545	334	562	NS	NS	NS	NS	NS	999	285	178	

**Estimated result; Result is less than reporting limit
NS, Not Sampled

Table 5-8
Summary of Laboratory Analytical Data

Event	Sampling Date	Days	Nitrate-N (mg/L)												
			BMW-1	BMW-2	BMW-3	BMW-4	BMW-5	BMW-6	BMW-7	BMW-8	BMW-9	BMW-10	BMW-11		
Baseline Sampling #1	10/10/2007	-105	<0.5	<0.5	<0.5	<0.5	<0.5	<0.5	<0.5	<0.5	<0.5	<0.5	<0.5	<0.5	<0.5
Baseline Sampling #2	11/17/2007	-77	<0.5	<0.5	<0.5	<0.5	<0.5	<0.5	<0.5	<0.5	<0.5	<0.5	<0.5	<0.5	<0.5
Tracer Sampling #1	11/20/2007	-64	<0.5	<0.5	<0.5	<0.5	<0.5	<0.5	<0.5	<0.5	<0.5	<0.5	<0.5	NS	NS
Tracer Sampling #2	11/26/2007	-58	<0.5	<0.5	<0.5	<0.5	<0.5	<0.5	<0.5	<0.5	<0.5	<0.5	<0.5	<0.5	<0.5
Tracer Sampling #3	12/4/2007	-50	<0.5	<0.5	<0.5	<0.5	<0.5	<0.5	<0.5	<0.5	<0.5	<0.5	<0.5	<0.5	<0.5
Tracer Sampling #4	12/11/2007	-43	<0.5	<0.5	<0.5	<0.5	<0.5	<0.5	<0.5	<0.5	<0.5	<0.5	<0.5	<0.5	<0.5
Tracer Sampling #5	12/18/2007	-36	<0.5	<0.5	<0.5	<0.5	<0.5	<0.5	<0.5	<0.5	<0.5	<0.5	<0.5	<0.5	<0.5
Tracer Sampling #6	1/3/2008	-21	<0.5	<0.5	<0.5	<0.5	<0.5	<0.5	<0.5	<0.5	<0.5	<0.5	<0.5	NS	NS
Pre-Bioaugmentation Sampling	1/21/2008	-3	<0.5	<0.5	<0.5	<0.5	<0.5	<0.5	<0.5	<0.5	<0.5	<0.5	<0.5	<0.5	<0.5
Performance Monitoring #1	1/30/2008	6	<0.5	<0.5	<0.5	<0.5	<0.5	<0.5	<0.5	<0.5	<0.5	<0.5	<0.5	NS	NS
Performance Monitoring #2	2/5/2008	12	<0.5	<0.5	<0.5	<0.5	<0.5	<0.5	<0.5	<0.5	<0.5	<0.5	<0.5	NS	NS
Performance Monitoring #3	2/19/2008	26	<0.5	NS	<0.5	NS	<0.5	NS	<0.5	NS	<0.5	NS	<0.5	NS	NS
Performance Monitoring #4	3/17/2008	53	<0.5	NS	<0.5	NS	<0.5	NS	<0.5	NS	<0.5	NS	<0.5	NS	NS
Performance Monitoring #5	4/17/2008	84	<0.5	<0.5	<0.5	<0.5	<0.5	<0.5	<0.5	<0.5	<0.5	<0.5	<0.5	NS	NS
Performance Monitoring #6	5/19/2008	116	<0.5	<0.5	<0.5	<0.5	<0.5	<0.5	<0.5	<0.5	<0.5	<0.5	<0.5	NS	NS
Performance Monitoring #7	6/4/2008	132	<0.5	<0.5	<0.5	<0.5	<0.5	<0.5	<0.5	<0.5	<0.5	<0.5	<0.5	NS	NS
Performance Monitoring #8	6/23/2008	151	<0.5	<0.5	<0.5	<0.5	<0.5	<0.5	<0.5	<0.5	<0.5	<0.5	<0.5	NS	NS
Performance Monitoring #9	7/22/2008	180	<0.5	<0.5	<0.5	<0.5	<0.5	<0.5	<0.5	<0.5	<0.5	<0.5	<0.5	NS	NS
Performance Monitoring #10	9/22/2008	242	<0.5	<0.5	<0.5	<0.5	<0.5	<0.5	<0.5	<0.5	<0.5	<0.5	<0.5	NS	NS
Performance Monitoring #11	11/11/2008	292	<0.5	<0.5	<0.5	<0.5	<0.5	<0.5	<0.5	<0.5	<0.5	<0.5	<0.5	<0.5	<0.5
Performance Monitoring #12	1/5/2009	347	<0.2	<0.2	<0.2	<0.2	<0.2	<0.2	<0.2	<0.2	<0.2	<0.2	<0.2	NS	NS

Event	Sampling Date	Days	Nitrate-N (mg/L)												
			PZ-1	PZ-2	MAG-113P	MAG-4	IW-1	IW-2	IW-3	IW-4	EX-1	EX-2	EX-3	EX-4	
Baseline Sampling #1	10/10/2007	-105	<0.5	<0.5	<0.5	NS	<0.5	NS	<0.5	<0.5	<0.5	<0.5	NS	NS	NS
Baseline Sampling #2	11/17/2007	-77	NS	NS	NS	NS	<0.5	NS	<0.5	<0.5	<0.5	<0.5	<0.5	<0.5	<0.5
Tracer Sampling #1	11/20/2007	-64	NS	NS	NS	NS	NS	NS	NS	NS	NS	NS	<0.5	<0.5	<0.5
Tracer Sampling #2	11/26/2007	-58	<0.5	<0.5	<0.5	NS	NS	NS	NS	NS	NS	NS	<0.5	<0.5	<0.5
Tracer Sampling #3	12/4/2007	-50	<0.5	<0.5	<0.5	NS	NS	NS	NS	NS	NS	NS	<0.5	<0.5	<0.5
Tracer Sampling #4	12/11/2007	-43	<0.5	<0.5	<0.5	<0.5	<0.5	NS	NS	NS	NS	NS	<0.5	<0.5	<0.5
Tracer Sampling #5	12/18/2007	-36	<0.5	<0.5	<0.5	<0.5	<0.5	NS	NS	NS	NS	NS	<0.5	<0.5	<0.5
Tracer Sampling #6	1/3/2008	-21	<0.5	<0.5	<0.5	NS	<0.5	NS	NS	NS	NS	NS	<0.5	<0.5	<0.5
Pre-Bioaugmentation Sampling	1/21/2008	-3	<0.5	<0.5	<0.5	<0.5	<0.5	NS	NS	NS	NS	NS	<0.5	<0.5	<0.5
Performance Monitoring #1	1/30/2008	6	NS	NS	NS	NS	<0.5	NS	NS	NS	NS	NS	<0.5	<0.5	<0.5
Performance Monitoring #2	2/5/2008	12	NS	NS	NS	NS	<0.5	NS	NS	NS	NS	NS	<0.5	<0.5	<0.5
Performance Monitoring #3	2/19/2008	26	NS	NS	NS	NS	<0.5	NS	NS	NS	NS	NS	<0.5	<0.5	<0.5
Performance Monitoring #4	3/17/2008	53	NS	NS	NS	NS	<0.5	NS	NS	NS	NS	NS	<0.5	<0.5	<0.5
Performance Monitoring #5	4/17/2008	84	NS	NS	NS	NS	<0.5	NS	NS	NS	NS	NS	<0.5	<0.5	<0.5
Performance Monitoring #6	5/19/2008	116	NS	NS	NS	NS	<0.5	NS	NS	NS	NS	NS	<0.5	<0.5	<0.5
Performance Monitoring #7	6/4/2008	132	<0.5	<0.5	<0.5	NS	NS	NS	NS	NS	NS	NS	<0.5	<0.5	<0.5
Performance Monitoring #8	6/23/2008	151	<0.5	<0.5	<0.5	NS	NS	NS	NS	NS	NS	NS	<0.5	<0.5	<0.5
Performance Monitoring #9	7/22/2008	180	<0.5	<0.5	<0.5	NS	NS	NS	NS	NS	NS	NS	<0.5	<0.5	<0.5
Performance Monitoring #10	9/22/2008	242	<0.5	<0.5	<0.5	<0.5	<0.5	NS	NS	NS	NS	NS	<0.5	<0.5	<0.5
Performance Monitoring #11	11/11/2008	292	<0.5	<0.5	<0.5	<0.5	<0.5	<0.5	<0.5	<0.5	<0.5	<0.5	<0.5	<0.5	<0.5
Performance Monitoring #12	1/5/2009	347	<0.2	<0.2	<0.2	<0.2	<0.2	NS	NS	NS	NS	NS	<0.2	<0.2	<0.2

NS, Not Sampled

Table 5-8
Summary of Laboratory Analytical Data

Event	Sampling Date	Days	Sulfate as SO ₄ (mg/L)										
			BMW-1	BMW-2	BMW-3	BMW-4	BMW-5	BMW-6	BMW-7	BMW-8	BMW-9	BMW-10	BMW-11
Baseline Sampling #1	10/10/2007	-105	57.0	52.1	60.8	34.1	39.6	23.2	26.7	26.9	52.2	55.2	63.7
Baseline Sampling #2	11/17/2007	-77	44.8	57.1	68.6	36.8	43.0	28.8	27.7	28.8	53.2	41.5	70.5
Tracer Sampling #1	11/20/2007	-64	46.6	43.1	56.4	35.7	27.2	25.7	21.4	27.4	NS	NS	NS
Tracer Sampling #2	11/26/2007	-58	61.5	56.9	70.4	44.2	28.8	27.5	38.5	36.0	60.2	57.1	78.2
Tracer Sampling #3	12/4/2007	-50	55.5	35.3	62.7	37.2	30.2	32.5	22.9	39.5	73.1	43.0	45.3
Tracer Sampling #4	12/11/2007	-43	64.9	47.4	72.7	43.6	44.7	31.8	20.2	33.6	61.9	67.8	54.4
Tracer Sampling #5	12/18/2007	-36	59.7	37.0	64.7	44.9	27.5	27.1	11.2	29.6	61.0	60.5	39.9
Tracer Sampling #6	1/3/2008	-21	40.2	49.0	48.8	53.0	12.0	28.9	9.37	7.84	NS	NS	NS
Pre-Bioaugmentation Sampling	1/21/2008	-3	28.9	32.8	47.5	24.7	10.3	13.3	8.67	11.8	30.4	60.2	53.0
Performance Monitoring #1	1/30/2008	6	14.0	27.0	39.1	19.3	3.78	10.4	4.51	9.86	NS	NS	NS
Performance Monitoring #2	2/5/2008	12	19.1	26.3	49.7	24.9	6.32	8.54	12.4	6.89	NS	NS	NS
Performance Monitoring #3	2/19/2008	26	16.3	NS	33.4	NS	3.96	NS	12.6	NS	NS	NS	NS
Performance Monitoring #4	3/17/2008	53	7.58	NS	23.3	NS	1.86	NS	8.24	NS	NS	NS	NS
Performance Monitoring #5	4/17/2008	84	4.58	4.89	6.81	NS	3.89	NS	8.02	NS	NS	NS	NS
Performance Monitoring #6	5/19/2008	116	0.96	2.38	3.74	8.22	<0.5	0.62	1.05	0.78	NS	NS	NS
Performance Monitoring #7	6/4/2008	132	<0.5	6.13	<0.5	11.8	<0.5	1.53	0.43	1.78	NS	NS	NS
Performance Monitoring #8	6/23/2008	151	1.88	4.80	2.21	19.8	<0.5	1.15	3.77	1.49	NS	NS	NS
Performance Monitoring #9	7/22/2008	180	<0.5	5.61	2.04	3.26	<0.5	2.72	<0.5	1.01	NS	NS	NS
Performance Monitoring #10	9/22/2008	242	2.51	17.5	1.38	4.18	0.94	<0.5	1.64	<0.5	NS	NS	NS
Performance Monitoring #11	11/11/2008	292	0.49**	27.7	<0.5	6.23	<0.5	<0.5	1.26	<0.5	2.36	82.4	56.9
Performance Monitoring #12	1/5/2009	347	0.49**	6.71	0.51	0.95	<0.2	<0.2	<0.2	0.27**	NS	NS	NS

Event	Sampling Date	Days	Sulfate as SO ₄ (mg/L)											
			PZ-1	PZ-2	MAG-113P	MAG-4	IW-1	IW-2	IW-3	IW-4	EX-1	EX-2	EX-3	EX-4
Baseline Sampling #1	10/10/2007	-105	27.4	63.6	62.9	NS	71.8	73.0	53.8	21.4	NS	NS	NS	NS
Baseline Sampling #2	11/17/2007	-77	NS	NS	NS	NS	52.2	79.0	59.0	23.0	58.1	57.6	24.7	24.7
Tracer Sampling #1	11/20/2007	-64	NS	NS	NS	NS	NS	NS	NS	NS	54.3	74.8	24.4	26.9
Tracer Sampling #2	11/26/2007	-58	33.9	38.8	44.3	NS	NS	NS	NS	NS	58.8	55.7	27.7	30.8
Tracer Sampling #3	12/4/2007	-50	43.9	164	47.3	NS	NS	NS	NS	NS	59.2	55.3	26.9	36.2
Tracer Sampling #4	12/11/2007	-43	47.7	40.0	20.4	91.6	NS	NS	NS	NS	43.5	51.1	44.7	22.7
Tracer Sampling #5	12/18/2007	-36	28.5	12.3	7.30	NS	NS	NS	NS	NS	40.4	45.1	35.9	34.4
Tracer Sampling #6	1/3/2008	-21	8.22	6.42	3.03	NS	NS	NS	NS	NS	34.7	50.7	41.7	33.0
Pre-Bioaugmentation Sampling	1/21/2008	-3	9.78	7.34	8.58	103	NS	NS	NS	NS	30.6	46.8	29.8	36.3
Performance Monitoring #1	1/30/2008	6	NS	NS	NS	NS	NS	NS	NS	NS	22.1	33.9	21.0	28.9
Performance Monitoring #2	2/5/2008	12	NS	NS	NS	NS	NS	NS	NS	NS	25.8	43.8	30.5	34.5
Performance Monitoring #3	2/19/2008	26	NS	8.85	NS	NS	NS	NS	NS	NS	NS	NS	NS	NS
Performance Monitoring #4	3/17/2008	53	NS	2.86	NS	NS	16.3	10.5	5.47	9.25	NS	NS	NS	NS
Performance Monitoring #5	4/17/2008	84	NS	6.28	NS	NS	10.6	1.03	2.61	7.58	NS	NS	NS	NS
Performance Monitoring #6	5/19/2008	116	NS	1.46	NS	NS	NS	NS	NS	NS	6.17	0.90	1.71	2.69
Performance Monitoring #7	6/4/2008	132	1.43	0.82	<0.5	NS	NS	NS	NS	NS	11.0	2.36	2.75	6.58
Performance Monitoring #8	6/23/2008	151	0.73	1.63	1.09	NS	NS	NS	NS	NS	12.7	4.55	3.48	7.21
Performance Monitoring #9	7/22/2008	180	<0.5	3.54	1.55	NS	NS	NS	NS	NS	13.3	4.23	2.59	6.35
Performance Monitoring #10	9/22/2008	242	2.97	7.23	1.52	NS	NS	NS	NS	NS	11.5	3.16	2.20	4.13
Performance Monitoring #11	11/11/2008	292	0.24**	12.0	0.52	84.7	27.3	0.70	<0.5	0.68	1.04	0.33**	<0.5	1.01
Performance Monitoring #12	1/5/2009	347	<0.2	0.69	0.76	NS	NS	NS	NS	NS	10.6	0.87	<0.2	3.71

**Estimated result; Result is less than reporting limit

NS, Not Sampled

Table 5-8
Summary of Laboratory Analytical Data

Event	Phosphate as P, ortho (mg/L)												
	Sampling Date	Days	BMW-1	BMW-2	BMW-3	BMW-4	BMW-5	BMW-6	BMW-7	BMW-8	BMW-9	BMW-10	BMW-11
Baseline Sampling #1	10/10/2007	-105	<0.5	<0.5	<0.5	<0.5	<0.5	<0.5	<0.5	<0.5	<0.5	<0.5	<0.5
Baseline Sampling #2	11/17/2007	-77	<0.5	1.44	<0.5	<0.5	<0.5	<0.5	<0.5	<0.5	<0.5	<0.5	<0.5
Tracer Sampling #1	11/20/2007	-64	<0.5	<0.5	<0.5	<0.5	<0.5	<0.5	<0.5	<0.5	NS	NS	NS
Tracer Sampling #2	11/26/2007	-58	<0.5	<0.5	<0.5	<0.5	<0.5	<0.5	<0.5	<0.5	<0.5	<0.5	<0.5
Tracer Sampling #3	12/4/2007	-50	4.63	3.50	2.00	<0.5	<0.5	<0.5	<0.5	<0.5	<0.5	<0.5	<0.5
Tracer Sampling #4	12/11/2007	-43	<0.5	<0.5	<0.5	<0.5	<0.5	<0.5	<0.5	<0.5	<0.5	<0.5	<0.5
Tracer Sampling #5	12/18/2007	-36	<0.5	<0.5	<0.5	<0.5	<0.5	<0.5	<0.5	<0.5	<0.5	<0.5	<0.5
Tracer Sampling #6	1/3/2008	-21	<0.5	1.46	0.79	0.6	<0.5	0.37	0.76	<0.5	NS	NS	NS
Pre-Bioaugmentation Sampling	1/21/2008	-3	<0.5	<0.5	<0.5	<0.5	<0.5	<0.5	<0.5	<0.5	<0.5	<0.5	<0.5
Performance Monitoring #1	1/30/2008	6	<0.5	<0.5	<0.5	<0.5	<0.5	<0.5	<0.5	<0.5	NS	NS	NS
Performance Monitoring #2	2/5/2008	12	<0.5	<0.5	<0.5	<0.5	<0.5	<0.5	<0.5	<0.5	NS	NS	NS
Performance Monitoring #3	2/19/2008	26	<0.5	NS	<0.5	NS	<0.5	NS	<0.5	NS	NS	NS	NS
Performance Monitoring #4	3/17/2008	53	<0.5	NS	<0.5	NS	1.22	NS	1.89	NS	NS	NS	NS
Performance Monitoring #5	4/17/2008	84	<0.5	<0.5	<0.5	NS	<0.5	NS	<0.5	NS	NS	NS	NS
Performance Monitoring #6	5/19/2008	116	14.1	<0.5	10.6	<0.5	10.3	1.52	1.11	<0.5	NS	NS	NS
Performance Monitoring #7	6/4/2008	132	4.54	1.84	5.60	1.24	4.05	<0.5	<0.5	<0.5	NS	NS	NS
Performance Monitoring #8	6/23/2008	151	4.97	3.33	5.83	1.97	3.09	1.07	<0.5	<0.5	NS	NS	NS
Performance Monitoring #9	7/22/2008	180	7.83	1.67	22.6	3.54	2.64	0.66	<0.5	<0.5	NS	NS	NS
Performance Monitoring #10	9/22/2008	242	7.37	<0.5	14.2	15.9	9.15	13.1	<0.5	<0.5	NS	NS	NS
Performance Monitoring #11	11/11/2008	292	5.15	<0.5	<0.5	<0.5	12.2	9.30	13.0	<0.5	<0.5	<0.5	<0.5
Performance Monitoring #12	1/5/2009	347	1.58	0.45	<0.2	1.58	<0.2	<0.2	1.39	1.54	NS	NS	NS

Event	Phosphate as P, ortho (mg/L)													
	Sampling Date	Days	PZ-1	PZ-2	MAG-113P	MAG-4	IW-1	IW-2	IW-3	IW-4	EX-1	EX-2	EX-3	EX-4
Baseline Sampling #1	10/10/2007	-105	<0.5	<0.5	<0.5	NS	<0.5	<0.5	<0.5	<0.5	NS	NS	NS	NS
Baseline Sampling #2	11/17/2007	-77	NS	NS	NS	NS	<0.5	<0.5	<0.5	<0.5	<0.5	<0.5	<0.5	<0.5
Tracer Sampling #1	11/20/2007	-64	NS	NS	NS	NS	NS	NS	NS	NS	<0.5	<0.5	<0.5	<0.5
Tracer Sampling #2	11/26/2007	-58	<0.5	<0.5	<0.5	NS	NS	NS	NS	NS	<0.5	<0.5	<0.5	<0.5
Tracer Sampling #3	12/4/2007	-50	<0.5	<0.5	<0.5	NS	NS	NS	NS	NS	<0.5	<0.5	<0.5	<0.5
Tracer Sampling #4	12/11/2007	-43	<0.5	<0.5	<0.5	<0.5	NS	NS	NS	NS	<0.5	<0.5	<0.5	<0.5
Tracer Sampling #5	12/18/2007	-36	<0.5	<0.5	<0.5	NS	NS	NS	NS	NS	<0.5	2.15	<0.5	<0.5
Tracer Sampling #6	1/3/2008	-21	<0.5	<0.5	4.00	NS	NS	NS	NS	NS	1.42	0.38	<0.5	<0.5
Pre-Bioaugmentation Sampling	1/21/2008	-3	<0.5	<0.5	<0.5	<0.5	NS	NS	NS	NS	<0.5	<0.5	<0.5	<0.5
Performance Monitoring #1	1/30/2008	6	NS	NS	NS	NS	NS	NS	NS	NS	<0.5	<0.5	3.13	1.13
Performance Monitoring #2	2/5/2008	12	NS	NS	NS	NS	NS	NS	NS	NS	<0.5	<0.5	<0.5	<0.5
Performance Monitoring #3	2/19/2008	26	NS	<0.5	NS	NS	NS	NS	NS	NS	<0.5	<0.5	<0.5	<0.5
Performance Monitoring #4	3/17/2008	53	NS	0.79	NS	NS	1.85	13.1	10.5	6.18	NS	NS	NS	NS
Performance Monitoring #5	4/17/2008	84	NS	<0.5	NS	NS	8.52	1.05	11.5	10.1	NS	NS	NS	NS
Performance Monitoring #6	5/19/2008	116	NS	<0.5	NS	NS	NS	NS	NS	NS	<0.5	<0.5	<0.5	<0.5
Performance Monitoring #7	6/4/2008	132	<0.5	1.63	2.96	NS	NS	NS	NS	NS	0.9	<0.5	<0.5	<0.5
Performance Monitoring #8	6/23/2008	151	<0.5	8.79	36.5	NS	NS	NS	NS	NS	1.59	1.00	<0.5	<0.5
Performance Monitoring #9	7/22/2008	180	<0.5	14.3	32.0	NS	NS	NS	NS	NS	<0.5	<0.5	<0.5	<0.5
Performance Monitoring #10	9/22/2008	242	25.7	14.7	31.6	NS	NS	NS	NS	NS	<0.5	<0.5	<0.5	<0.5
Performance Monitoring #11	11/11/2008	292	8.56	2.43	7.35	<0.5	37.3	<0.5	<0.5	<0.5	<0.5	<0.5	<0.5	<0.5
Performance Monitoring #12	1/5/2009	347	0.44	<0.2	1.82	NS	NS	NS	NS	NS	<0.2	0.59	<0.2	<0.2

**Estimated result; Result is less than reporting limit

NS, Not Sampled

Table 5-8
Summary of Laboratory Analytical Data

Event	Sampling Date	Days	Bromide (mg/L)													
			BMW-1	BMW-2	BMW-3	BMW-4	BMW-5	BMW-6	BMW-7	BMW-8	BMW-9	BMW-10	BMW-11			
Baseline Sampling #1	10/10/2007	-105	<0.5	<0.5	<0.5	<0.5	<0.5	<0.5	<0.5	<0.5	<0.5	<0.5	<0.5	<0.5	<0.5	<0.5
Baseline Sampling #2	11/17/2007	-77	<0.5	<0.5	<0.5	<0.5	<0.5	<0.5	<0.5	<0.5	<0.5	<0.5	<0.5	<0.5	<0.5	<0.5
Tracer Sampling #1	11/20/2007	-64	<0.5	<0.5	<0.5	<0.5	<0.5	1.60	<0.5	<0.5	<0.5	<0.5	<0.5	NS	NS	NS
Tracer Sampling #2	11/26/2007	-58	3.49	<0.5	<0.5	<0.5	<0.5	2.28	6.36	<0.5	<0.5	<0.5	<0.5	<0.5	<0.5	<0.5
Tracer Sampling #3	12/4/2007	-50	79.3	<0.5	<0.5	<0.5	<0.5	42.6	18.7	<0.5	<0.5	<0.5	<0.5	21.5	<0.5	<0.5
Tracer Sampling #4	12/11/2007	-43	159	<0.5	<0.5	<0.5	<0.5	70.3	9.80	<0.5	<0.5	<0.5	<0.5	55.0	<0.5	<0.5
Tracer Sampling #5	12/18/2007	-36	210	10.3	<0.5	<0.5	<0.5	107	8.62	21.9	<0.5	<0.5	<0.5	68.2	<0.5	<0.5
Tracer Sampling #6	1/3/2008	-21	227	73.1	2.26	0.28**	<0.5	109	36.7	15.8	2.00	NS	NS	NS	NS	NS
Pre-Bioaugmentation Sampling	1/21/2008	-3	176	59.9	1.42	0.69	80.3	85.6	5.03	3.59	102	0.88	<0.5	<0.5	<0.5	<0.5
Performance Monitoring #1	1/30/2008	6	144	53.5	1.66	<0.5	76.1	64.8	0.87	2.70	NS	NS	NS	NS	NS	NS
Performance Monitoring #2	2/5/2008	12	128	47.1	2.81	<0.5	80.5	64.7	4.22	5.25	NS	NS	NS	NS	NS	NS
Performance Monitoring #3	2/19/2008	26	115	NS	3.43	NS	68.6	NS	NS	11.0	NS	NS	NS	NS	NS	NS
Performance Monitoring #4	3/17/2008	53	56.3	NS	3.50	NS	55.3	NS	2.58	NS	NS	NS	NS	NS	NS	NS
Performance Monitoring #5	4/17/2008	84	50.2	25.8	1.06	NS	38.9	NS	1.93	NS	NS	NS	NS	NS	NS	NS
Performance Monitoring #6	5/19/2008	116	53.2	38.5	0.91	1.29	32.2	64.3	2.32	3.83	NS	NS	NS	NS	NS	NS
Performance Monitoring #7	6/4/2008	132	41.3	48.3	<0.5	<0.5	24.1	46.0	1.08	2.71	NS	NS	NS	NS	NS	NS
Performance Monitoring #8	6/23/2008	151	39.8	34.6	<0.5	<0.5	23.3	39.4	1.12	2.69	NS	NS	NS	NS	NS	NS
Performance Monitoring #9	7/22/2008	180	29.6	35.0	<0.5	<0.5	19.4	36.6	1.22	1.88	NS	NS	NS	NS	NS	NS
Performance Monitoring #10	9/22/2008	242	24.5	49.1	<0.5	<0.5	18.6	25.0	<0.5	<0.5	NS	NS	NS	NS	NS	NS
Performance Monitoring #11	11/11/2008	292	22.5	54.4	<0.5	1.36	21.9	25.0	1.59	<0.5	41.8	38.5	<0.5	<0.5	<0.5	<0.5
Performance Monitoring #12	1/5/2009	347	23.1	20.1	<0.2	<0.2	20.7	23.1	1.23	1.48	NS	NS	NS	NS	NS	NS

Event	Sampling Date	Days	Bromide (mg/L)													
			PZ-1	PZ-2	MAG-113P	MAG-4	IW-1	IW-2	IW-3	IW-4	EX-1	EX-2	EX-3	EX-4		
Baseline Sampling #1	10/10/2007	-105	<0.5	<0.5	<0.5	NS	<0.5	NS	<0.5	NS	<0.5	<0.5	<0.5	NS	NS	NS
Baseline Sampling #2	11/17/2007	-77	NS	NS	NS	NS	NS	<0.5	<0.5	<0.5	<0.5	<0.5	<0.5	<0.5	<0.5	<0.5
Tracer Sampling #1	11/20/2007	-64	NS	NS	NS	NS	NS	NS	NS	NS	NS	NS	NS	<0.5	<0.5	<0.5
Tracer Sampling #2	11/26/2007	-58	<0.5	191	167	NS	NS	NS	NS	NS	NS	NS	NS	9.91	<0.5	<0.5
Tracer Sampling #3	12/4/2007	-50	48.4	215	212	NS	NS	NS	NS	NS	NS	NS	NS	29.0	<0.5	<0.5
Tracer Sampling #4	12/11/2007	-43	104	211	187	<0.5	NS	NS	NS	NS	NS	NS	NS	15.5	0.71	5.30
Tracer Sampling #5	12/18/2007	-36	117	224	172	NS	NS	NS	NS	NS	NS	NS	NS	52.4	1.28	9.55
Tracer Sampling #6	1/3/2008	-21	116	74.8	74.5	NS	NS	NS	NS	NS	NS	NS	NS	65.4	0.38	14.0
Pre-Bioaugmentation Sampling	1/21/2008	-3	58.2	74.2	61	<0.5	NS	NS	NS	NS	NS	NS	NS	66.4	0.79	23.5
Performance Monitoring #1	1/30/2008	6	NS	NS	NS	NS	NS	NS	NS	NS	NS	NS	NS	52.5	<0.5	27.8
Performance Monitoring #2	2/5/2008	12	NS	NS	NS	NS	NS	NS	NS	NS	NS	NS	NS	59.4	1.63	38.3
Performance Monitoring #3	2/19/2008	26	NS	25.9	NS	NS	NS	NS	NS	NS	NS	NS	NS	NS	NS	NS
Performance Monitoring #4	3/17/2008	53	NS	16.6	NS	NS	NS	NS	<0.5	28.8	4.14	NS	NS	NS	NS	NS
Performance Monitoring #5	4/17/2008	84	NS	41.6	NS	NS	NS	NS	<0.5	26.4	2.06	NS	NS	NS	NS	NS
Performance Monitoring #6	5/19/2008	116	NS	66.6	NS	NS	NS	NS	NS	NS	NS	NS	NS	40.6	0.78	26.4
Performance Monitoring #7	6/4/2008	132	24.2	36.8	31.3	NS	NS	NS	NS	NS	NS	NS	NS	21.7	<0.5	23.6
Performance Monitoring #8	6/23/2008	151	23.4	32.6	23.6	NS	NS	NS	NS	NS	NS	NS	NS	18.9	<0.5	24.0
Performance Monitoring #9	7/22/2008	180	22.7	20.3	21.2	NS	NS	NS	NS	NS	NS	NS	NS	19.4	<0.5	26.6
Performance Monitoring #10	9/22/2008	242	20.3	11.8	17.6	NS	NS	NS	NS	NS	NS	NS	NS	16.1	<0.5	25.1
Performance Monitoring #11	11/11/2008	292	22.9	8.53	18.4	<0.5	14.0	<0.5	19.1	1.34	<0.5	<0.5	<0.5	27.8	<0.5	22.6
Performance Monitoring #12	1/5/2009	347	18.9	29.0	19.0	NS	NS	NS	NS	NS	NS	NS	NS	21.3	0.49	30.0

**Estimated result; Result is less than reporting limit
NS, Not Sampled

Table 5-8
Summary of Laboratory Analytical Data

Event	Sampling Date	Days	Fluoride (mg/L)													
			BMW-1	BMW-2	BMW-3	BMW-4	BMW-5	BMW-6	BMW-7	BMW-8	BMW-9	BMW-10	BMW-11			
Baseline Sampling #2	11/7/2007	-77	<0.5	<0.5	<0.5	<0.5	<0.5	<0.5	<0.5	<0.5	<0.5	<0.5	<0.5	<0.5	<0.5	<0.5
Tracer Sampling #1	11/20/2007	-64	0.16	0.58	0.1	<0.5	<0.5	<0.5	<0.5	<0.5	1.26*	<0.5	<0.5	NS	NS	NS
Tracer Sampling #2	11/26/2007	-58	<0.5	<0.5	<0.5	<0.5	<0.5	<0.5	<0.5	<0.5	<0.5*	<0.5	0.14	0.26	0.14	0.14
Tracer Sampling #3	12/4/2007	-50	<0.5	0.87	<0.5*	<0.5	<0.5	<0.5*	<0.5*	<0.5*	<0.5*	<0.5*	0.29	0.64	<0.5	<0.5
Tracer Sampling #4	12/11/2007	-43	0.16^	0.07^	0.22^	0.05^	0.07^	0.02^	0.02^	0.02^	37.5^	0.03^	0.15^	0.1^	0.04^	0.04^
Tracer Sampling #5	12/18/2007	-36	0.17^	0.08^	0.25^	<0.2^	0.08^	<0.2^	<0.2^	<0.2^	80.5^	<0.2^	NS	NS	NS	NS
Tracer Sampling #6	1/3/2008	-21	0.29^	0.12^	8.57^	0.07^	<0.2^	<0.2^	<0.2^	<0.2^	23.7^	<0.2^	NS	NS	NS	NS
Pre-Bioaugmentation Sampling	1/21/2008	-3	0.58^	0.23^	10.1^	0.3^	0.33^	0.16^	0.16^	0.16^	33.2^	0.15^	0.2	0.3	0.2	0.2

Event	Sampling Date	Days	Fluoride (mg/L)													
			PZ-1	PZ-2	MAG-113P	MAG-4	IW-1	IW-2	IW-3	IW-4	EX-1	EX-2	EX-3	EX-4		
Baseline Sampling #2	11/7/2007	-77	NS	NS	NS	NS	NS	<0.5	<0.5	<0.5	<0.5	<0.5	<0.5	<0.5	<0.5	<0.5
Tracer Sampling #1	11/20/2007	-64	NS	NS	NS	NS	NS	NS	NS	NS	NS	NS	NS	<0.5*	<0.5	<0.5
Tracer Sampling #2	11/26/2007	-58	<0.5	<0.5*	<0.5*	NS	NS	NS	NS	NS	NS	NS	0.24	0.95*	<0.5	<0.5
Tracer Sampling #3	12/4/2007	-50	<0.5*	<0.5*	<0.5*	NS	NS	NS	NS	NS	NS	NS	<0.5	2.67	<0.5	<0.5
Tracer Sampling #4	12/11/2007	-43	0.16^	0.07^	0.08^	0.03^	NS	NS	NS	NS	NS	NS	0.09^	6.13^	0.02^	0.32^
Tracer Sampling #5	12/18/2007	-36	0.10^	0.05^	0.08^	NS	NS	NS	NS	NS	NS	NS	0.06^	3.47^	<0.2^	<0.2^
Tracer Sampling #6	1/3/2008	-21	<0.2^	<0.2^	0.24^	NS	NS	NS	NS	NS	NS	NS	0.11^	1.73^	<0.2^	<0.2^
Pre-Bioaugmentation Sampling	1/21/2008	-3	1.22^	0.32^	0.52^	0.13^	NS	NS	NS	NS	NS	NS	0.27^	2.39^	0.16^	0.16^

*Indicates interference with VFAs (IC)

^Indicates data obtained by ISE probe

NS, Not Sampled

Table 5-8
Summary of Laboratory Analytical Data

Event	Lactate (mg/L)												
	Sampling Date	Days	BMW-1	BMW-2	BMW-3	BMW-4	BMW-5	BMW-6	BMW-7	BMW-8	BMW-9	BMW-10	BMW-11
Baseline Sampling #1	10/10/2007	-105	<5	<5	<5	<5	<5	<5	<5	<5	<5	<5	<5
Baseline Sampling #2	11/7/2007	-77	<5	<5	<5	<5	<5	<5	<5	<5	<5	<5	<5
Tracer Sampling #2	11/26/2007	-58	17.1	<5	1.31**	<5	38.0	418	<5	<5	<5	<5	<5
Tracer Sampling #3	12/4/2007	-50	11.7	<5	116	<5	36.3	165	115	<5	<5	<5	17.1
Tracer Sampling #4	12/11/2007	-43	2.16**	<5	67.7	7.32	14.8	28.4	212	9.34	<5	<5	<5
Tracer Sampling #5	12/18/2007	-36	<5	<5	46.6	<5	5.28	440	46.3	2.27**	<5	<5	<5
Tracer Sampling #6	1/3/2008	-21	2.84**	<5	57.3	<5	6.55	5.37	12.0	NS	NS	NS	NS
Pre-Bioaugmentation Sampling	1/21/2008	-3	<5	<5	15.9	<5	43.0	<5	<5	<5	<5	<5	<5
Performance Monitoring #1	1/30/2008	6	<5	<5	7.59	<5	14.7	<5	0.89	NS	NS	NS	NS
Performance Monitoring #2	2/5/2008	12	<5	<5	6.09	<5	14.7	<5	0.89	NS	NS	NS	NS
Performance Monitoring #3	2/19/2008	26	<5	NS	7.49	NS	<5	<5	NS	NS	NS	NS	NS
Performance Monitoring #4	3/17/2008	53	<5	NS	<5	NS	<5	<5	NS	NS	NS	NS	NS
Performance Monitoring #5	4/17/2008	84	<5	<5	<5	NS	<5	<5	NS	NS	NS	NS	NS
Performance Monitoring #6	5/19/2008	116	<5	<5	<5	<5	<5	<5	<5	<5	<5	<5	<5
Performance Monitoring #7	6/4/2008	132	<5	<5	<5	<5	<5	<5	<5	<5	<5	<5	<5
Performance Monitoring #8	6/23/2008	151	<5	<5	<5	<5	<5	<5	<5	<5	<5	<5	<5
Performance Monitoring #9	7/22/2008	180	<5	<5	<5	<5	<5	<5	<5	<5	<5	<5	<5
Performance Monitoring #10	9/22/2008	242	<5	<5	<5	<5	<5	<5	<5	<5	<5	<5	<5
Performance Monitoring #11	11/11/2008	292	<5	<5	<5	18.5	<5	<5	<5	<5	<5	<5	<5
Performance Monitoring #12	1/5/2009	347	<5	<5	5.51	9.15	<5	<5	27.8	<5	<5	<5	<5

Event	Lactate (mg/L)													
	Sampling Date	Days	PZ-1	PZ-2	MAG-113P	MAG-4	IW-1	IW-2	IW-3	IW-4	EX-1	EX-2	EX-3	EX-4
Baseline Sampling #1	10/10/2007	-105	<5	<5	<5	NS	<5	<5	<5	<1	NS	NS	NS	NS
Baseline Sampling #2	11/7/2007	-77	NS	NS	NS	NS	<5	<5	<5	<5	<5	<5	<5	<5
Tracer Sampling #2	11/26/2007	-58	<5	655	900	NS	NS	NS	NS	NS	3.77**	225	<5	<5
Tracer Sampling #3	12/4/2007	-50	229	293	355	NS	NS	NS	NS	NS	1.10**	7.03	1.72**	<5
Tracer Sampling #4	12/11/2007	-43	413	618	199	<5	NS	NS	NS	NS	19.5	68.9	3.07**	2.00**
Tracer Sampling #5	12/18/2007	-36	286	335	134	<5	NS	NS	NS	NS	<5	<5	<5	<5
Tracer Sampling #6	1/3/2008	-21	60.4	91.7	36.8	NS	NS	NS	NS	NS	<5	1.58**	12.3	29.7
Pre-Bioaugmentation Sampling	1/21/2008	-3	12.7	<5	<5	<5	NS	NS	NS	NS	<5	<5	9.43	3.90**
Performance Monitoring #1	1/30/2008	6	NS	NS	NS	NS	NS	NS	NS	NS	<5	<5	4.53**	2.40**
Performance Monitoring #2	2/5/2008	12	NS	NS	NS	NS	NS	NS	NS	NS	<5	<5	<5	<5
Performance Monitoring #3	2/19/2008	26	NS	<5	NS	NS	NS	NS	NS	NS	<5	<5	3.16**	1.52**
Performance Monitoring #4	3/17/2008	53	NS	<5	NS	NS	<5	<5	<5	<5	NS	NS	NS	NS
Performance Monitoring #5	4/17/2008	84	NS	<5	NS	NS	<5	364	<5	<5	NS	NS	NS	NS
Performance Monitoring #6	5/19/2008	116	NS	<5	NS	NS	<5	NS	NS	NS	<5	<5	<5	<5
Performance Monitoring #7	6/4/2008	132	<5	<5	<5	NS	NS	NS	NS	NS	<5	<5	<5	<5
Performance Monitoring #8	6/23/2008	151	<5	<5	<5	NS	NS	NS	NS	NS	<5	<5	<5	<5
Performance Monitoring #9	7/22/2008	180	<5	<5	451	NS	NS	NS	NS	NS	<5	<5	<5	<5
Performance Monitoring #10	9/22/2008	242	<5	<5	452	NS	NS	NS	NS	NS	<5	<5	<5	<5
Performance Monitoring #11	11/11/2008	292	<5	<5	<5	<5	<5	<5	<5	<5	<5	<5	<5	<5
Performance Monitoring #12	1/5/2009	347	<5	<5	<5	NS	NS	NS	NS	NS	<5	8.52	<5	<5

**Estimated result; Result is less than reporting limit

NS, Not Sampled

Table 5-8
Summary of Laboratory Analytical Data

Event	Sampling Date	Days	Other Fatty Acids (acetate, propionate, formate, butyrate, pyruvate, valerate; mg/L)														
			BMW-1	BMW-2	BMW-3	BMW-4	BMW-5	BMW-6	BMW-7	BMW-8	BMW-9	BMW-10	BMW-11				
Baseline Sampling #1	10/10/2007	-105	<30	<30	<30	<30	<30	<30	<30	<30	<30	<30	<30	<30	<30	<30	<30
Baseline Sampling #2	11/17/2007	-77	<30	<30	<30	<30	<30	<30	<30	<30	<30	<30	<30	<30	<30	<30	<30
Tracer Sampling #2	11/26/2007	-58	<30	<30	<30	<30	<30	<30	14.7	<30	<30	<30	<30	<30	<30	<30	<30
Tracer Sampling #3	12/4/2007	-50	14.0	<30	136	<30	<30	136	56.1	332	5.70	<30	<30	<30	<30	<30	<30
Tracer Sampling #4	12/11/2007	-43	92.9	<30	230	<30	<30	239	52.7	809	200	12.37	<30	<30	<30	<30	<30
Tracer Sampling #5	12/18/2007	-36	241	2,99**	452	51.0	571	45.6	504	281	63.8	<30	<30	<30	<30	<30	<30
Tracer Sampling #6	1/3/2008	-21	466	152	500	174	624	94.6	702	390	NS	NS	NS	NS	NS	NS	NS
Pre-Bioaugmentation Sampling	1/21/2008	-3	354	96.6	312	83.0	225	368	305	251	200	<30	<30	<30	<30	<30	<30
Performance Monitoring #1	1/30/2008	6	348	88.0	400	67.1	538	318	275	210	NS	NS	NS	NS	NS	NS	NS
Performance Monitoring #2	2/5/2008	12	307	55.1	427	82.1	281	266	392	245	NS	NS	NS	NS	NS	NS	NS
Performance Monitoring #3	2/19/2008	26	375	NS	462	NS	422	NS	522	NS	NS	NS	NS	NS	NS	NS	NS
Performance Monitoring #4	3/17/2008	53	536	NS	526	NS	558	NS	600	NS	NS	NS	NS	NS	NS	NS	NS
Performance Monitoring #5	4/17/2008	84	452	288	969	NS	579	NS	658	NS	NS	NS	NS	NS	NS	NS	NS
Performance Monitoring #6	5/19/2008	116	658	629	1420	744	492	406	790	361	NS	NS	NS	NS	NS	NS	NS
Performance Monitoring #7	6/4/2008	132	736	132	1592	449	737	338	726	544	NS	NS	NS	NS	NS	NS	NS
Performance Monitoring #8	6/23/2008	151	657	306	1365	530	1055	334	1146	439	NS	NS	NS	NS	NS	NS	NS
Performance Monitoring #9	7/22/2008	180	676	394	1665	619	1349	575	1293	271	NS	NS	NS	NS	NS	NS	NS
Performance Monitoring #10	9/22/2008	242	1052	364	2170	1505	2099	1283	2770	1381	NS	NS	NS	NS	NS	NS	NS
Performance Monitoring #11	11/11/2008	292	839	214	1617	1112	1646	1817	1550	1463	630	<30	<30	<30	<30	<30	<30
Performance Monitoring #12	1/5/2009	347	433	217	1183	670	888	1035	766	<30	NS	NS	NS	NS	NS	NS	NS

Event	Sampling Date	Days	Other Fatty Acids (acetate, propionate, formate, butyrate, pyruvate, valerate; mg/L)														
			PZ-1	PZ-2	MAG-1/13P	MAG-4	IW-1	IW-2	IW-3	IW-4	EX-1	EX-2	EX-3	EX-4			
Baseline Sampling #1	10/10/2007	-105	<30	<30	<30	NS	NS	<30	<30	<30	<30	<30	<30	<30	<30	<30	<30
Baseline Sampling #2	11/17/2007	-77	NS	NS	NS	NS	NS	NS	NS	NS	NS	NS	NS	NS	NS	NS	NS
Tracer Sampling #2	11/26/2007	-58	<30	155	215	NS	NS	NS	NS	NS	NS	NS	NS	NS	NS	NS	NS
Tracer Sampling #3	12/4/2007	-50	1.56**	902	1149	NS	NS	NS	NS	NS	NS	NS	NS	NS	NS	NS	NS
Tracer Sampling #4	12/11/2007	-43	283	1297	1042	<30	<30	NS	NS	NS	NS	NS	NS	NS	NS	NS	NS
Tracer Sampling #5	12/18/2007	-36	605	1221	951	NS	NS	NS	NS	NS	NS	NS	NS	NS	NS	NS	NS
Tracer Sampling #6	1/3/2008	-21	721	676	809	NS	NS	NS	NS	NS	NS	NS	NS	NS	NS	NS	NS
Pre-Bioaugmentation Sampling	1/21/2008	-3	214	352	294	<30	<30	NS	NS	NS	NS	NS	NS	NS	NS	NS	NS
Performance Monitoring #1	1/30/2008	6	NS	NS	NS	NS	NS	NS	NS	NS	NS	NS	NS	NS	NS	NS	NS
Performance Monitoring #2	2/5/2008	12	NS	NS	NS	NS	NS	NS	NS	NS	NS	NS	NS	NS	NS	NS	NS
Performance Monitoring #3	2/19/2008	26	NS	261	NS	NS	NS	NS	NS	NS	NS	NS	NS	NS	NS	NS	NS
Performance Monitoring #4	3/17/2008	53	NS	190	NS	NS	NS	71.7	202	192	138	NS	NS	NS	NS	NS	NS
Performance Monitoring #5	4/17/2008	84	NS	464	NS	NS	NS	66.5	322	211	162	NS	NS	NS	NS	NS	NS
Performance Monitoring #6	5/19/2008	116	NS	597	NS	NS	NS	NS	NS	NS	NS	NS	NS	NS	NS	NS	NS
Performance Monitoring #7	6/4/2008	132	897	554	810	NS	NS	NS	NS	NS	NS	NS	NS	NS	NS	NS	NS
Performance Monitoring #8	6/23/2008	151	1002	732	1611	NS	NS	NS	NS	NS	NS	NS	NS	NS	NS	NS	NS
Performance Monitoring #9	7/22/2008	180	2104	1223	2690	NS	NS	NS	NS	NS	NS	NS	NS	NS	NS	NS	NS
Performance Monitoring #10	9/22/2008	242	3479	1536	3269	NS	NS	NS	NS	NS	NS	NS	NS	NS	NS	NS	NS
Performance Monitoring #11	11/11/2008	292	911	551	801	<30	<30	631	693	467	266	NS	NS	NS	NS	NS	NS
Performance Monitoring #12	1/5/2009	347	<30	616	740	NS	NS	NS	NS	NS	NS	NS	NS	NS	NS	NS	NS

**Estimated result; Result is less than reporting limit
NS, Not Sampled

Table 5-8
Summary of Laboratory Analytical Data

Dissolved Iron (µg/L)													
Event	Sampling Date	Days	BMW-1	BMW-2	BMW-3	BMW-4	BMW-5	BMW-6	BMW-7	BMW-8	BMW-9	BMW-10	BMW-11
Baseline Sampling #1	10/10/2007	-105	5760	5930	7570	3600	3490	3640	1420	2180	5780	4870	2620
Baseline Sampling #2	11/17/2007	-77	NS	NS	NS	NS	NS	NS	NS	NS	NS	NS	NS
Tracer Sampling #3	12/4/2007	-50	10500	4880	7450	3610	4850	5650	822	2150	8940	6230	2640
Tracer Sampling #6	1/3/2008	-21	NS	NS	NS	NS	NS	NS	NS	NS	NS	NS	NS
Pre-Bioaugmentation Sampling	1/21/2008	-3	4820	4820	5170	3360	2660	7230	797	4760	5660	6260	3040
Performance Monitoring #11	11/11/2008	292	1370	10000	4960	1880.0	1050	8050	251	1700	1340	5470	3340

Dissolved Iron (µg/L)														
Event	Sampling Date	Days	PZ-1	PZ-2	MAG-113P	MAG-4	IW-1	IW-2	IW-3	IW-4	EX-1	EX-2	EX-3	EX-4
Baseline Sampling #1	10/10/2007	-105	1770	2780	3540	NS	2960	1800	2870	1400	NS	NS	NS	NS
Baseline Sampling #2	11/17/2007	-77	NS	NS	NS	NS	NS	NS	NS	NS	3410	1550	4390	3120
Tracer Sampling #3	12/4/2007	-50	3340	3210	2730	NS	NS	NS	NS	NS	4710	1540	3000	900
Tracer Sampling #6	1/3/2008	-21	NS	NS	NS	NS	NS	NS	NS	NS	5070	3130	3750	9490
Pre-Bioaugmentation Sampling	1/21/2008	-3	1220	641	409	398	NS	NS	NS	NS	5630	4430	5210	2630
Performance Monitoring #11	11/11/2008	292	1030	124	120	2580	<100	2590	7110	3420	1250	1340	3970	1990

NS, Not Sampled

Dissolved Manganese (µg/L)													
Event	Sampling Date	Days	BMW-1	BMW-2	BMW-3	BMW-4	BMW-5	BMW-6	BMW-7	BMW-8	BMW-9	BMW-10	BMW-11
Baseline Sampling #1	10/10/2007	-105	63.5	62.8	63.1	34.4	35.5	49.5	19.2	23.7	59.8	63.7	14.1
Baseline Sampling #2	11/17/2007	-77	NS	NS	NS	NS	NS	NS	NS	NS	NS	NS	NS
Tracer Sampling #3	12/4/2007	-50	102	58.6	69.5	58.1	50.3	57.6	<15	24.1	78.4	66.3	69.0
Pre-Bioaugmentation Sampling	1/21/2008	-3	55.1	53.5	43	25.1	18	43	<15	37.6	49	60.3	47.1
Performance Monitoring #11	11/11/2008	292	16	96.5	<75	36.6	<15	<15	<15	15	29.6	52.4	47.8

Dissolved Manganese (µg/L)														
Event	Sampling Date	Days	PZ-1	PZ-2	MAG-113P	MAG-4	IW-1	IW-2	IW-3	IW-4	EX-1	EX-2	EX-3	EX-4
Baseline Sampling #1	10/10/2007	-105	17.1	42.4	49.7	NS	42.1	39.1	46.2	15.4	NS	NS	NS	NS
Baseline Sampling #2	11/17/2007	-77	NS	NS	NS	NS	NS	NS	NS	NS	66.6	39.6	31.6	33.0
Tracer Sampling #3	12/4/2007	-50	41.0	64.7	44.6	NS	NS	NS	NS	NS	52.5	37.1	21.6	22.1
Pre-Bioaugmentation Sampling	1/21/2008	-3	<15	<15	<15	<15	NS	NS	NS	NS	54.8	44.8	31.5	20.2
Performance Monitoring #11	11/11/2008	292	<15	<15	<15	38.0	54.0	25.6	37.1	29.3	22.4	18.8	25.8	19.2

NS, Not Sampled

Table 5-9
Summary of Laboratory DHC Data

		DHC (cells/liter)											
Event	Sampling Date	Days	BMW-1	BMW-2	BMW-3	BMW-4	BMW-5	BMW-6	BMW-7	BMW-8	BMW-9	BMW-10	BMW-11
Baseline Sampling #1	10/10/2007	-105	9.80E+01	4.25E+03	6.00E+03	1.71E+03	1.93E+03	4.47E+02	2.28E+02	2.36E+02	1.06E+03	0.00E+00	5.48E+04
Pre-Bioaugmentation Sampling	1/21/2008	-3	3.08E+04	3.05E+04	5.00E+04	2.52E+05	3.92E+05	5.38E+03	2.15E+05	5.10E+04	8.87E+03	1.00E+03	0.00E+00
Performance Monitoring #3	2/19/2008	26	4.30E+04	NS	1.16E+04	NS	1.43E+04	NS	4.53E+04	NS	NS	NS	NS
Performance Monitoring #4	3/17/2008	53	8.24E+04	NS	2.98E+04	NS	1.74E+05	NS	2.80E+05	NS	NS	NS	NS
Performance Monitoring #5	4/17/2008	84	6.24E+04	4.70E+04	4.00E+04	NS	1.95E+05	NS	1.87E+05	NS	NS	NS	NS
Performance Monitoring #6	5/19/2008	116	6.32E+10	1.63E+05	1.12E+09	1.34E+04	1.92E+07	1.03E+06	2.65E+05	4.04E+05	NS	NS	NS
Performance Monitoring #7	6/4/2008	132	1.02E+10	1.67E+07	1.25E+08	8.07E+04	1.87E+07	5.56E+04	4.82E+04	1.02E+05	NS	NS	NS
Performance Monitoring #8	6/23/2008	151	1.75E+10	2.61E+07	6.51E+07	9.98E+03	2.90E+06	4.80E+05	1.32E+05	2.54E+05	NS	NS	NS
Performance Monitoring #9	7/22/2008	180	3.04E+09	2.47E+06	2.96E+08	1.60E+05	1.12E+08	8.95E+05	7.24E+05	8.24E+05	NS	NS	NS
Performance Monitoring #10	9/22/2008	242	7.15E+09	8.87E+06	3.78E+08	1.07E+06	1.51E+08	5.76E+07	NS	2.66E+05	NS	NS	NS
Performance Monitoring #11	11/11/2008	292	3.89E+09	4.23E+05	2.97E+08	7.69E+05	7.44E+08	8.35E+08	4.07E+06	4.50E+04	1.50E+05	0.00E+00	1.32E+04
Performance Monitoring #12	1/5/2009	347	2.02E+09	1.77E+07	1.11E+09	8.96E+06	1.74E+08	8.67E+08	2.08E+06	1.14E+06	NS	NS	NS

		DHC (cells/liter)												
Event	Sampling Date	Days	PZ-1	PZ-2	MAG-113	MAG-4	IW-1	IW-2	IW-3	IW-4	EX-1	EX-2	EX-3	EX-4
Baseline Sampling #1	10/10/2007	-105	4.10E+02	4.07E+02	3.43E+03	0.00E+00	6.15E+04	4.67E+02	7.10E+03	1.45E+03	NS	NS	NS	NS
Pre-Bioaugmentation Sampling	1/21/2008	-3	2.18E+05	1.19E+05	0.00E+00	1.51E+04	NS	NS	NS	NS	8.90E+02	2.56E+04	3.98E+03	8.90E+02
Performance Monitoring #3	2/19/2008	26	NS	8.70E+03	NS	NS	NS	NS	NS	NS	NS	NS	NS	NS
Performance Monitoring #4	3/17/2008	53	NS	7.33E+03	NS	NS	1.74E+04	3.88E+02	4.53E+04	1.02E+05	NS	NS	NS	NS
Performance Monitoring #5	4/17/2008	84	NS	6.50E+04	NS	NS	1.13E+02	7.10E+04	8.40E+03	4.66E+02	NS	NS	NS	NS
Performance Monitoring #6	5/19/2008	116	NS	8.09E+04	NS	NS	NS	NS	NS	NS	2.95E+04	1.94E+04	9.31E+04	5.66E+04
Performance Monitoring #7	6/4/2008	132	1.43E+05	9.20E+04	5.59E+04	NS	NS	NS	NS	NS	NS	6.06E+04	2.62E+04	6.85E+04
Performance Monitoring #8	6/23/2008	151	5.92E+05	7.50E+05	2.58E+05	NS	NS	NS	NS	NS	NS	NS	NS	NS
Performance Monitoring #9	7/22/2008	180	9.49E+04	4.59E+05	1.53E+05	NS	NS	NS	NS	NS	NS	1.89E+05	1.85E+05	9.29E+04
Performance Monitoring #10	9/22/2008	242	1.36E+06	2.52E+06	3.32E+05	NS	NS	NS	NS	NS	8.30E+05	2.40E+05	7.35E+05	7.79E+05
Performance Monitoring #11	11/11/2008	292	3.89E+08	4.87E+06	8.53E+04	9.42E+05	NS	NS	NS	NS	1.27E+07	9.74E+05	2.58E+05	NS
Performance Monitoring #12	1/5/2009	347	6.46E+08	4.58E+06	5.33E+07	NS	NS	NS	NS	NS	5.78E+06	3.66E+07	1.28E+08	0.00E+00

NS: Not sampled
qPCR values = DHC cells per liter.

Table 5-10
Summary of Field Parameter Data

pH (SU)													
Event	Sampling Date	Days	BMW-1	BMW-2	BMW-3	BMW-4	BMW-5	BMW-6	BMW-7	BMW-8	BMW-9	BMW-10	BMW-11
Baseline Sampling #1	10/10/2007	-105	4.3	4.5	4.2	4.6	4.7	5.4	4.6	4.8	4.4	4.7	4.8
Baseline Sampling #2	11/17/2007	-77	4.1	4.3	4.2	4.8	4.6	5.1	4.5	4.6	4.3	4.8	4.4
Tracer Sampling #1	11/20/2007	-64	3.9	4.2	3.9	4.3	4.7	5.3	5.7	4.4	NS	NS	NS
Tracer Sampling #2	11/26/2007	-58	4.3	4.6	4.3	4.6	5.2	5.1	4.5	4.4	4.6	NS	4.2
Tracer Sampling #3	12/4/2007	-50	4.3	4.6	4.8	4.6	4.5	4.9	6.3	4.2	4.2	4.4	5.6
Tracer Sampling #4	12/11/2007	-43	4.8	4.5	4.4	4.9	4.4	4.8	6.0	4.3	4.0	4.4	5.4
Tracer Sampling #5	12/18/2007	-36	4.9	4.9	4.5	4.6	4.5	4.7	6.5	4.7	4.3	4.3	5.3
Tracer Sampling #6	1/3/2008	-21	5.6	4.1	5.5	4.4	4.5	4.8	5.9	5.4	NS	NS	NS
Field Parameter Sampling	1/17/2008	-7	5.7	4.8	5.8	5.9	5.9	4.5	6.5	5.3	NS	NS	NS
Pre-Bioaugmentation Sampling	1/21/2008	-3	6.1	5.7	6.0	6.2	6.4	4.7	6.7	5.4	5.1	4.4	4.9
Performance Monitoring #1	1/30/2008	6	6.4	6.0	6.3	6.6	6.3	4.6	6.9	5.3	NS	NS	NS
Performance Monitoring #2	2/5/2008	12	6.6	6.2	6.2	6.6	6.5	4.4	7.0	5.2	NS	NS	NS
Performance Monitoring #3	2/19/2008	26	6.5	6.9	6.0	NS	7.1	NS	7.1	NS	NS	NS	NS
Performance Monitoring #4	3/17/2008	53	6.2	NS	5.9	NS	6.8	NS	6.6	NS	NS	NS	NS
Performance Monitoring #5	4/17/2008	84	6.3	6.6	5.7	NS	6.3	NS	6.9	NS	NS	NS	NS
Performance Monitoring #6	5/19/2008	116	6.6	6.3	6.0	5.9	6.5	5.9	7.2	5.7	NS	NS	NS
Performance Monitoring #7	6/4/2008	132	6.1	6.2	5.9	5.8	6.3	5.9	7.1	5.8	NS	NS	NS
Performance Monitoring #8	6/23/2008	151	6.0	5.9	5.9	4.9	6.2	6.3	7.0	5.9	NS	NS	NS
Performance Monitoring #9	7/22/2008	180	6.0	5.6	5.8	5.4	6.2	6.0	5.8	6.0	NS	NS	NS
Performance Monitoring #10	9/22/2008	242	6.6	5.6	6.4	6.5	6.7	6.3	7.2	6.3	NS	NS	NS
Performance Monitoring #11	11/11/2008	292	6.3	4.5	6.3	6.7	6.7	6.4	7.2	6.3	6.4	4.2	3.5
Performance Monitoring #12	1/5/2009	347	6.4	6.0	6.4	6.5	6.7	7.1	7.0	6.6	NS	NS	NS

pH (SU)														
Event	Sampling Date	Days	PZ-1	PZ-2	MAG-113P	MAG-4	IW-1	IW-2	IW-3	IW-4	EX-1	EX-2	EX-3	EX-4
Baseline Sampling #1	10/10/2007	-105	4.6	4.3	4.2	NS	4.2	4.1	4.4	5.4	NS	NS	NS	NS
Baseline Sampling #2	11/17/2007	-77	NS	NS	NS	NS	5.1	3.9	4.2	5.0	NS	NS	NS	NS
Tracer Sampling #1	11/20/2007	-64	NS	NS	NS	NS	NS	NS	NS	NS	4.4	4.4	4.8	4.7
Tracer Sampling #2	11/26/2007	-58	4.4	5.2	5.5	NS	NS	NS	NS	NS	4.5	5.5	4.9	4.5
Tracer Sampling #3	12/4/2007	-50	4.0	4.7	5.0	NS	NS	NS	NS	NS	4.6	5.7	4.8	4.4
Tracer Sampling #4	12/11/2007	-43	4.2	4.6	5.3	3.6	NS	NS	NS	NS	5.4	5.7	4.6	5.2
Tracer Sampling #5	12/18/2007	-36	4.8	5.1	5.8	NS	NS	NS	NS	NS	5.2	5.6	4.7	4.5
Tracer Sampling #6	1/3/2008	-21	5.6	5.7	6.2	NS	NS	NS	NS	NS	4.5	5.1	4.0	4.8
Field Parameter Sampling	1/17/2008	-7	NS	NS	NS	NS	NS	NS	NS	NS	4.9	5.2	4.5	4.4
Pre-Bioaugmentation Sampling	1/21/2008	-3	5.8	6.1	6.4	3.9	NS	NS	NS	NS	5.0	5.5	4.5	4.4
Performance Monitoring #1	1/30/2008	6	NS	NS	NS	NS	9.6	7.1	4.9	5.1	5.1	5.8	4.7	4.6
Performance Monitoring #2	2/5/2008	12	NS	NS	NS	NS	10.2	6.0	10.4	10.5	4.9	5.5	4.3	4.3
Performance Monitoring #3	2/19/2008	26	NS	5.2	NS	NS	NS	NS	NS	NS	NS	NS	NS	NS
Performance Monitoring #4	3/17/2008	53	NS	5.9	NS	NS	5.7	9.9	9.2	8.9	NS	NS	NS	NS
Performance Monitoring #5	4/17/2008	84	NS	7.2	NS	NS	6.6	5.8	6.5	6.6	NS	NS	NS	NS
Performance Monitoring #6	5/19/2008	116	NS	6.5	NS	NS	NS	NS	NS	NS	5.6	5.5	5.4	5.1
Performance Monitoring #7	6/4/2008	132	6.5	6.8	6.2	NS	NS	NS	NS	NS	5.5	5.8	5.4	5.2
Performance Monitoring #8	6/23/2008	151	6.2	8.4	7.4	NS	NS	NS	NS	NS	5.7	5.9	5.6	5.6
Performance Monitoring #9	7/22/2008	180	6.4	9.1	8.4	NS	NS	NS	NS	NS	5.5	5.9	5.5	5.4
Performance Monitoring #10	9/22/2008	242	7.3	9.0	8.9	NS	NS	NS	NS	NS	5.9	5.9	6.0	5.7
Performance Monitoring #11	11/11/2008	292	6.9	7.3	7.2	4.2	7.8	5.9	5.9	5.7	6.1	6.1	6.0	5.7
Performance Monitoring #12	1/5/2009	347	6.8	6.1	6.3	NS	NS	NS	NS	NS	6.3	6.1	6.2	5.7

NS, Not sampled

Table 5-10
Summary of Field Parameter Data

Event	Sampling Date	Days	Oxidation Reduction Potential (mV)											
			BMW-1	BMW-2	BMW-3	BMW-4	BMW-5	BMW-6	BMW-7	BMW-8	BMW-9	BMW-10	BMW-11	
Baseline Sampling #1	10/10/2007	-105	142	40	121	94	60	62	137	145	86	104	152	
Baseline Sampling #2	11/17/2007	-77	138	50	137	57	55	19	146	116	91	108	126	
Tracer Sampling #1	11/20/2007	-64	47	24	21	2	16	36	84	127	NS	NS	NS	
Tracer Sampling #2	11/26/2007	-58	57	-69	22	-41	25	-49	85	135	116	NS	125	
Tracer Sampling #3	12/4/2007	-50	6	66	39	75	25	-77	-123	52	83	63	94	
Tracer Sampling #4	12/11/2007	-43	-17	38	-38	44	-6	-9	-140	-34	-1	173	43	
Tracer Sampling #5	12/18/2007	-36	17	-114	90	108	-114	40	-105	-129	-105	97	81	
Tracer Sampling #6	1/3/2008	-21	-148	23	-153	-44	-112	-126	-204	-188	NS	NS	NS	
Field Parameter Sampling	1/17/2008	-7	-127	-98	-149	-134	-160	-103	-196	-154	NS	NS	NS	
Pre-Bioaugmentation Sampling	1/21/2008	-3	-95	-53	-56	-45	-148	-61	-89	-93	-7	95	61	
Performance Monitoring #1	1/30/2008	6	-107	-207	-183	-205	-244	-125	-261	-172	NS	NS	NS	
Performance Monitoring #2	2/5/2008	12	-211	-149	-215	-248	-249	-121	-261	-138	NS	NS	NS	
Performance Monitoring #3	2/19/2008	26	-161	-200	-167	NS	-200	NS	-250	NS	NS	NS	NS	
Performance Monitoring #4	3/17/2008	53	-87	NS	-72	NS	-175	NS	-125	NS	NS	NS	NS	
Performance Monitoring #5	4/17/2008	84	-113	-141	-127	NS	-197	NS	-213	NS	NS	NS	NS	
Performance Monitoring #6	5/19/2008	116	-82	-101	-115	-98	-304	-275	-332	-282	NS	NS	NS	
Performance Monitoring #7	6/4/2008	132	-79	-126	-179	-115	-161	-113	-220	82	NS	NS	NS	
Performance Monitoring #8	6/23/2008	151	-182	-236	-229	-175	-218	-200	-261	-167	NS	NS	NS	
Performance Monitoring #9	7/22/2008	180	-64	-64	-92	-82	-142	-117	-67	-123	NS	NS	NS	
Performance Monitoring #10	9/22/2008	242	-101	-72	-99	-160	-171	-157	-230	-148	NS	NS	NS	
Performance Monitoring #11	11/11/2008	292	-211	-201	-268	-236	-247	-259	-338	-254	-195	-87	-74	
Performance Monitoring #12	1/5/2009	347	-166	-242	-248	-222	-152	-243	-300	-276	NS	NS	NS	

Event	Sampling Date	Days	Oxidation Reduction Potential (mV)											
			PZ-1	PZ-2	MAG-113P	MAG-4	IW-1	IW-2	IW-3	IW-4	EX-1	EX-2	EX-3	EX-4
Baseline Sampling #1	10/10/2007	-105	146	155	142	NS	156	169	100	159	NS	NS	NS	
Baseline Sampling #2	11/17/2007	-77	NS	NS	NS	NS	219	123	120	147	NS	NS	NS	
Tracer Sampling #1	11/20/2007	-64	NS	NS	NS	NS	NS	NS	NS	NS	132	141	126	
Tracer Sampling #2	11/26/2007	-58	141	-54	-147	NS	NS	NS	NS	NS	-5	-49	24	
Tracer Sampling #3	12/4/2007	-50	135	24	-20	NS	NS	NS	NS	NS	68	-33	112	
Tracer Sampling #4	12/11/2007	-43	13	-47	-96	418	NS	NS	NS	NS	32	-8	35	
Tracer Sampling #5	12/18/2007	-36	-124	-107	-70	NS	NS	NS	NS	NS	95	52	106	
Tracer Sampling #6	1/3/2008	-21	-139	-171	-191	NS	NS	NS	NS	NS	-110	-159	-68	
Field Parameter Sampling	1/17/2008	-7	NS	NS	NS	NS	NS	NS	NS	NS	-147	-141	-64	
Pre-Bioaugmentation Sampling	1/21/2008	-3	-46	-96	-83	341	NS	NS	NS	NS	-57	-114	-14	
Performance Monitoring #1	1/30/2008	6	NS	NS	NS	NS	-364	-242	-129	-165	-102	-110	-46	
Performance Monitoring #2	2/5/2008	12	NS	NS	NS	NS	-390	-213	-322	-259	-156	-144	-67	
Performance Monitoring #3	2/19/2008	26	NS	NS	NS	NS	NS	NS	NS	NS	NS	NS	NS	
Performance Monitoring #4	3/17/2008	53	NS	-100	NS	NS	-175	-248	-239	-101	NS	NS	NS	
Performance Monitoring #5	4/17/2008	84	NS	-235	NS	NS	-179	-184	-182	-184	NS	NS	NS	
Performance Monitoring #6	5/19/2008	116	NS	-246	NS	NS	NS	NS	NS	NS	-91	-87	-80	
Performance Monitoring #7	6/4/2008	132	-146	-145	-149	NS	NS	NS	NS	NS	-169	-183	-171	
Performance Monitoring #8	6/23/2008	151	-184	-244	-218	NS	NS	NS	NS	NS	-134	-182	-145	
Performance Monitoring #9	7/22/2008	180	-144	-220	-186	NS	NS	NS	NS	NS	-42	-64	-36	
Performance Monitoring #10	9/22/2008	242	-162	-220	-129	NS	NS	NS	NS	NS	-49	-91	-85	
Performance Monitoring #11	11/11/2008	292	-295	-235	-310	241	-312	-250	-225	-215	-263	-267	-227	
Performance Monitoring #12	1/5/2009	347	-142	-127	-161	NS	NS	NS	NS	NS	-182	-218	-167	

NS, Not sampled

Table 5-10
Summary of Field Parameter Data

Event	Sampling Date	Days	Dissolved Oxygen (mg/L)												
			BMW-1	BMW-2	BMW-3	BMW-4	BMW-5	BMW-6	BMW-7	BMW-8	BMW-9	BMW-10	BMW-11		
Baseline Sampling #1	10/10/2007	-105	2.0	0.5	0.7	0.7	0.6	0.6	0.7	0.7	0.7	0.7	4.9	5.8	0.6
Baseline Sampling #2	11/17/2007	-77	1.4	0.7	0.9	0.3	0.5	0.7	0.6	0.6	0.6	0.7	0.8	3.4	0.8
Tracer Sampling #1	11/20/2007	-64	0.4	2.1	0.4	0.7	1.0	1.5	0.9	1.1	0.4	1.1	NS	NS	NS
Tracer Sampling #2	11/26/2007	-58	1.0	0.2	0.2	0.5	0.4	0.7	1.1	0.4	1.7	0.4	1.7	NS	0.4
Tracer Sampling #3	12/4/2007	-50	0.4	0.2	2.6	0.2	0.2	0.7	0.3	0.3	0.6	0.4	0.6	0.4	2.3
Tracer Sampling #4	12/11/2007	-43	3.5	0.4	0.2	7.7	1.7	0.8	0.2	0.2	1.7	0.3	0.3	4.7	2.3
Tracer Sampling #5	12/18/2007	-36	0.5	0.1	0.4	-0.3	-0.2	-0.4	3.7	0.0	0.0	-0.1	0.0	-0.1	0.4
Tracer Sampling #6	1/3/2008	-21	2.2	0.9	1.3	0.5	1.4	0.5	1.6	1.4	1.4	NS	NS	NS	NS
Field Parameter Sampling	1/17/2008	-7	0.7	0.5	1.0	0.5	1.0	0.9	1.3	1.1	NS	NS	NS	NS	NS
Pre-Bioaugmentation Sampling	1/21/2008	-3	-0.1	-0.1	-0.6	-0.1	1.0	0.0	-0.7	0.0	-0.1	0.4	-0.1	0.4	0.2
Performance Monitoring #1	1/30/2008	6	0.9	0.4	1.2	0.8	0.3	0.5	0.3	0.4	NS	NS	NS	NS	NS
Performance Monitoring #2	2/5/2008	12	0.4	0.7	0.1	0.1	0.1	0.2	0.3	0.6	NS	NS	NS	NS	NS
Performance Monitoring #3	2/19/2008	26	0.0	0.1	0.0	NS	-0.1	NS	0.1	NS	NS	NS	NS	NS	NS
Performance Monitoring #4	3/17/2008	53	0.1	NS	0.1	NS	0.2	NS	0.1	NS	NS	NS	NS	NS	NS
Performance Monitoring #5	4/17/2008	84	0.3	0.2	0.4	NS	0.6	NS	0.1	NS	NS	NS	NS	NS	NS
Performance Monitoring #6	5/19/2008	116	0.5	0.4	0.5	0.2	2.6	11.4	8.6	28.8	NS	NS	NS	NS	NS
Performance Monitoring #7	6/4/2008	132	5.9	3.0	4.4	4.7	8.2	5.4	6.2	5.0	NS	NS	NS	NS	NS
Performance Monitoring #8	6/23/2008	151	1.9	0.8	4.4	1.4	10.6	0.2	10.7	0.2	NS	NS	NS	NS	NS
Performance Monitoring #9	7/22/2008	180	6.3	6.3	18.9	1.5	0.2	0.2	8.7	0.2	NS	NS	NS	NS	NS
Performance Monitoring #10	9/22/2008	242	0.0	0.0	0.0	0.0	3.0	3.5	2.9	5.0	NS	NS	NS	NS	NS
Performance Monitoring #11	11/11/2008	292	1.5	5.2	ND	0.6	ND	4.5	3.4	0.7	2.1	NS	NS	NS	NS
Performance Monitoring #12	1/5/2009	347	0.3	0.0	0.0	0.4	1.9	1.0	1.5	2.1	NS	NS	NS	NS	NS

Event	Sampling Date	Days	Dissolved Oxygen (mg/L)												
			PZ-1	PZ-2	MAG-113P	MAG-4	IW-1	IW-2	IW-3	IW-4	EX-1	EX-2	EX-3	EX-4	
Baseline Sampling #1	10/10/2007	-105	0.5	0.6	0.6	NS	0.7	0.6	0.5	8.8	NS	NS	NS	NS	NS
Baseline Sampling #2	11/17/2007	-77	NS	NS	NS	NS	1.1	0.6	0.4	0.5	NS	NS	NS	NS	NS
Tracer Sampling #1	11/20/2007	-64	NS	NS	NS	NS	NS	NS	NS	NS	NS	6.8	5.9	6.8	5.9
Tracer Sampling #2	11/26/2007	-58	0.7	1.0	0.7	NS	NS	NS	NS	NS	NS	5.3	6.1	5.9	6.5
Tracer Sampling #3	12/4/2007	-50	0.6	1.9	0.7	NS	NS	NS	NS	NS	NS	53.9	27.7	62.2	52.5
Tracer Sampling #4	12/11/2007	-43	2.9	1.3	1.5	1.9	NS	NS	NS	NS	NS	9.0	7.1	11.0	6.4
Tracer Sampling #5	12/18/2007	-36	0.0	0.0	6.0	NS	NS	NS	NS	NS	NS	8.7	3.9	8.1	3.2
Tracer Sampling #6	1/3/2008	-21	0.6	2.0	0.7	NS	NS	NS	NS	NS	NS	2.4	3.5	3.4	0.4
Field Parameter Sampling	1/17/2008	-7	NS	NS	NS	NS	NS	NS	NS	NS	NS	1.2	2.4	1.2	1.4
Pre-Bioaugmentation Sampling	1/21/2008	-3	0.1	0.8	0.1	3.5	NS	NS	NS	NS	NS	0.0	3.6	5.8	0.1
Performance Monitoring #1	1/30/2008	6	NS	NS	NS	NS	0.6	0.5	1.0	0.6	1.2	1.2	1.0	2.4	0.5
Performance Monitoring #2	2/5/2008	12	NS	NS	NS	NS	0.0	0.3	0.3	0.4	0.4	0.4	0.5	0.7	0.5
Performance Monitoring #3	2/19/2008	26	NS	0.3	NS	NS	NS	NS	NS	NS	NS	NS	NS	NS	NS
Performance Monitoring #4	3/17/2008	53	NS	0.6	NS	NS	0.3	0.5	0.4	0.1	NS	NS	NS	NS	NS
Performance Monitoring #5	4/17/2008	84	NS	0.1	NS	NS	0.8	0.1	0.1	0.1	NS	NS	NS	NS	NS
Performance Monitoring #6	5/19/2008	116	NS	5.3	NS	NS	NS	NS	NS	NS	NS	0.2	2.1	0.1	0.4
Performance Monitoring #7	6/4/2008	132	8.2	8.1	4.8	NS	NS	NS	NS	NS	NS	7.6	9.3	9.2	7.9
Performance Monitoring #8	6/23/2008	151	1.2	1.4	0.3	NS	NS	NS	NS	NS	NS	0.3	0.3	0.3	0.3
Performance Monitoring #9	7/22/2008	180	0.2	0.3	0.2	NS	NS	NS	NS	NS	NS	2.7	3.9	2.7	2.9
Performance Monitoring #10	9/22/2008	242	4.7	0.7	0.0	NS	NS	NS	NS	NS	NS	3.5	6.4	2.1	3.4
Performance Monitoring #11	11/11/2008	292	0.4	2.1	0.4	ND	0.7	ND	ND	ND	NS	2.1	3.1	3.1	2.8
Performance Monitoring #12	1/5/2009	347	1.5	1.8	3.3	NS	NS	NS	NS	NS	NS	1.8	0.2	0.9	0.1

NS, Not sampled
ND, No data due to probe malfunction

Table 5-10
Summary of Field Parameter Data

Event	Sampling Date	Days	Specific Conductivity (µS/cm)											
			BMW-1	BMW-2	BMW-3	BMW-4	BMW-5	BMW-6	BMW-7	BMW-8	BMW-9	BMW-10	BMW-11	
Baseline Sampling #1	10/10/2007	-105	186	182	201	120	131	106	78	88	19	231	213	
Baseline Sampling #2	11/17/2007	-77	113	127	140	87	89	79	50	57	151	164	151	
Tracer Sampling #1	11/20/2007	-64	164	161	179	115	121	3	419	87	NS	NS	NS	
Tracer Sampling #2	11/26/2007	-58	237	186	225	141	110	201	340	75	202	NS	192	
Tracer Sampling #3	12/4/2007	-50	266	146	407	100	262	189	1058	145	184	140	158	
Tracer Sampling #4	12/11/2007	-43	515	127	351	139	391	137	1687	291	227	158	144	
Tracer Sampling #5	12/18/2007	-36	512	101	348	103	419	89	1970	196	182	110	103	
Tracer Sampling #6	1/3/2008	-21	1179	296	860	188	494	174	1354	511	NS	NS	NS	
Field Parameter Sampling	1/17/2008	-7	1733	352	1433	649	1397	394	4147	454	NS	NS	NS	
Pre-Bioaugmentation Sampling	1/21/2008	-3	1633	469	1147	530	1626	436	3863	415	493	85	108	
Performance Monitoring #1	1/30/2008	6	3308	885	2529	870	2009	387	5804	364	NS	NS	NS	
Performance Monitoring #2	2/5/2008	12	4455	1183	3392	1589	3337	315	6102	467	NS	NS	NS	
Performance Monitoring #3	2/19/2008	26	3488	1426	2492	NS	4359	NS	5463	NS	NS	NS	NS	
Performance Monitoring #4	3/17/2008	53	2755	NS	2905	NS	3454	NS	3544	NS	NS	NS	NS	
Performance Monitoring #5	4/17/2008	84	2786	1719	3894	NS	2565	NS	2539	NS	NS	NS	NS	
Performance Monitoring #6	5/19/2008	116	1908	1029	3135	1092	3797	1559	3874	1310	NS	NS	NS	
Performance Monitoring #7	6/4/2008	132	2301	1104	2907	1159	3169	1214	3363	1593	NS	NS	NS	
Performance Monitoring #8	6/23/2008	151	3545	1406	4498	849	4730	1902	5630	1262	NS	NS	NS	
Performance Monitoring #9	7/22/2008	180	3584	1511	5341	2375	5694	3062	4298	3022	NS	NS	NS	
Performance Monitoring #10	9/22/2008	242	3847	948	6206	4075	5349	3457	7170	2969	NS	NS	NS	
Performance Monitoring #11	11/11/2008	292	4723	542	8672	8962	7275	8096	11750	6983	5337	345	246	
Performance Monitoring #12	1/5/2009	347	2264	2253	3291	1743	2972	4336	4219	4327	NS	NS	NS	

Event	Sampling Date	Days	Specific Conductivity (µS/cm)											
			PZ-1	PZ-2	MAG-113P	MAG-4	IW-1	IW-2	IW-3	IW-4	EX-1	EX-2	EX-3	EX-4
Baseline Sampling #1	10/10/2007	-105	82	230	212	NS	236	236	160	78	NS	NS	NS	
Baseline Sampling #2	11/17/2007	-77	NS	NS	NS	NS	144	162	113	56	NS	NS	NS	
Tracer Sampling #1	11/20/2007	-64	NS	NS	NS	NS	NS	NS	NS	NS	200	402	100	
Tracer Sampling #2	11/26/2007	-58	79	1	2	NS	NS	NS	NS	NS	251	527	117	
Tracer Sampling #3	12/4/2007	-50	268	1079	1268	NS	NS	NS	NS	NS	242	463	117	
Tracer Sampling #4	12/11/2007	-43	559	1320	1478	210	NS	NS	NS	NS	365	495	111	
Tracer Sampling #5	12/18/2007	-36	533	972	1231	NS	NS	NS	NS	NS	211	320	105	
Tracer Sampling #6	1/3/2008	-21	1112	1010	2066	NS	NS	NS	NS	NS	320	365	145	
Field Parameter Sampling	1/17/2008	-7	NS	NS	NS	NS	NS	NS	NS	NS	321	384	218	
Pre-Bioaugmentation Sampling	1/21/2008	-3	1496	2753	4375	232	NS	NS	NS	NS	342	535	193	
Performance Monitoring #1	1/30/2008	6	NS	NS	NS	NS	3964	2266	422	275	369	646	231	
Performance Monitoring #2	2/5/2008	12	NS	NS	NS	NS	8184	1196	8288	6963	395	783	230	
Performance Monitoring #3	2/19/2008	26	NS	NS	NS	NS	NS	NS	NS	NS	NS	NS	NS	
Performance Monitoring #4	3/17/2008	53	NS	323	NS	NS	520	7110	3379	2171	NS	NS	NS	
Performance Monitoring #5	4/17/2008	84	NS	2127	NS	NS	3628	1356	3144	2991	NS	NS	NS	
Performance Monitoring #6	5/19/2008	116	NS	2138	NS	NS	NS	NS	NS	NS	357	391	208	
Performance Monitoring #7	6/4/2008	132	3550	2570	2456	NS	NS	NS	NS	NS	417	563	615	
Performance Monitoring #8	6/23/2008	151	4636	4823	6217	NS	NS	NS	NS	NS	503	570	610	
Performance Monitoring #9	7/22/2008	180	6537	6274	1028	NS	NS	NS	NS	NS	635	474	926	
Performance Monitoring #10	9/22/2008	242	8005	5419	9888	NS	NS	NS	NS	NS	631	552	757	
Performance Monitoring #11	11/11/2008	292	7367	4456	6492	311	10360	1774	1879	1245	670	2407	2878	
Performance Monitoring #12	1/5/2009	347	2982	1772	2169	NS	NS	NS	NS	NS	1574	1653	2597	

NS, Not sampled

Table 5-10
Summary of Field Parameter Data

Event	Sampling Date	Days	Temperature (°C)											
			BMW-1	BMW-2	BMW-3	BMW-4	BMW-5	BMW-6	BMW-7	BMW-8	BMW-9	BMW-10	BMW-11	
Baseline Sampling #1	10/10/2007	-105	15.7	14.9	14.4	14.8	14.2	14.2	13.5	13.4	15.1	15.0	14.5	
Baseline Sampling #2	11/17/2007	-77	13.8	14.1	14.0	14.2	13.6	13.8	12.8	12.6	13.7	14.2	14.0	
Tracer Sampling #1	11/20/2007	-64	13.3	13.2	13.7	13.9	13.7	13.6	13.1	13.3	NS	NS	NS	
Tracer Sampling #2	11/26/2007	-58	13.3	13.8	13.7	13.9	13.4	13.5	13.3	13.2	13.3	NS	13.6	
Tracer Sampling #3	12/4/2007	-50	12.6	12.7	13.3	13.2	12.2	13.1	12.4	12.5	11.9	12.9	13.0	
Tracer Sampling #4	12/11/2007	-43	12.1	12.7	13.2	13.1	12.9	12.9	13.2	12.7	11.9	12.6	12.6	
Tracer Sampling #5	12/18/2007	-36	11.8	10.7	12.3	11.6	12.6	12.0	12.2	12.0	11.8	12.1	12.1	
Tracer Sampling #6	1/3/2008	-21	7.1	5.8	11.2	11.2	11.8	12.0	12.3	12.0	NS	NS	NS	
Field Parameter Sampling	1/17/2008	-7	9.3	11.4	12.3	12.3	11.8	11.8	11.9	12.1	NS	NS	NS	
Pre-Bioaugmentation Sampling	1/21/2008	-3	7.0	9.5	11.2	9.5	10.6	11.1	12.1	11.2	9.5	10.3	11.3	
Performance Monitoring #1	1/30/2008	6	10.0	10.6	11.4	11.0	11.5	9.9	12.1	10.9	NS	NS	NS	
Performance Monitoring #2	2/5/2008	12	10.5	11.2	11.8	11.4	12.3	11.9	12.4	12.5	NS	NS	NS	
Performance Monitoring #3	2/19/2008	26	11.4	10.4	11.8	NS	11.4	NS	11.0	NS	NS	NS	NS	
Performance Monitoring #4	3/17/2008	53	9.7	NS	11.7	NS	11.0	NS	11.7	NS	NS	NS	NS	
Performance Monitoring #5	4/17/2008	84	11.0	11.3	15.0	NS	12.0	NS	NS	NS	NS	NS	NS	
Performance Monitoring #6	5/19/2008	116	12.0	11.9	12.1	11.8	13.1	11.2	11.8	11.4	NS	NS	NS	
Performance Monitoring #7	6/4/2008	132	12.8	12.4	12.8	12.5	12.7	12.7	12.8	12.5	NS	NS	NS	
Performance Monitoring #8	6/23/2008	151	16.4	13.8	13.9	13.3	15.3	13.0	16.0	12.8	NS	NS	NS	
Performance Monitoring #9	7/22/2008	180	17.3	15.8	16.6	14.9	14.9	14.3	15.0	13.1	NS	NS	NS	
Performance Monitoring #10	9/22/2008	242	16.0	15.3	15.9	15.3	15.4	15.5	15.2	14.9	NS	NS	NS	
Performance Monitoring #11	11/11/2008	292	14.8	13.9	13.5	14.6	14.3	14.6	14.1	13.6	14.5	14.3	14.0	
Performance Monitoring #12	1/5/2009	347	10.9	12.2	12.5	12.8	11.4	12.2	11.5	11.9	NS	NS	NS	

Event	Sampling Date	Days	Temperature (°C)											
			PZ-1	PZ-2	MAG-113P	MAG-4	IW-1	IW-2	IW-3	IW-4	EX-1	EX-2	EX-3	EX-4
Baseline Sampling #1	10/10/2007	-105	15.4	15.2	14.4	NS	15.6	15.5	14.9	14.7	NS	NS	NS	
Baseline Sampling #2	11/17/2007	-77	NS	NS	NS	NS	13.8	13.4	13.1	12.2	NS	NS	NS	
Tracer Sampling #1	11/20/2007	-64	NS	NS	NS	NS	NS	NS	NS	NS	14.4	13.7	13.9	
Tracer Sampling #2	11/26/2007	-58	13.2	13.1	13.0	NS	NS	NS	NS	NS	14.5	14.6	14.4	
Tracer Sampling #3	12/4/2007	-50	12.2	12.7	11.6	NS	NS	NS	NS	NS	13.2	12.5	14.3	
Tracer Sampling #4	12/11/2007	-43	13.4	13.3	12.9	12.7	NS	NS	NS	NS	13.5	13.8	14.0	
Tracer Sampling #5	12/18/2007	-36	10.9	11.0	11.3	NS	NS	NS	NS	NS	13.8	13.1	14.7	
Tracer Sampling #6	1/3/2008	-21	11.5	10.9	12.6	NS	NS	NS	NS	NS	14.0	14.0	13.7	
Field Parameter Sampling	1/17/2008	-7	NS	NS	NS	NS	NS	NS	NS	NS	12.8	12.8	12.2	
Pre-Bioaugmentation Sampling	1/21/2008	-3	9.8	9.9	11.1	9.2	NS	NS	NS	NS	13.1	13.7	13.2	
Performance Monitoring #1	1/30/2008	6	NS	NS	NS	NS	10.7	9.8	9.7	12.4	12.8	16.1	12.3	
Performance Monitoring #2	2/5/2008	12	NS	NS	NS	NS	12.8	13.9	12.5	13.9	13.9	14.1	13.6	
Performance Monitoring #3	2/19/2008	26	NS	9.8	NS	NS	NS	NS	NS	NS	NS	NS	NS	
Performance Monitoring #4	3/17/2008	53	NS	10.3	NS	NS	10.7	12.1	12.0	11.9	NS	NS	NS	
Performance Monitoring #5	4/17/2008	84	NS	10.7	NS	NS	16.6	13.2	12.1	11.8	NS	NS	NS	
Performance Monitoring #6	5/19/2008	116	NS	12.4	NS	NS	NS	NS	NS	NS	12.8	13.2	12.8	
Performance Monitoring #7	6/4/2008	132	13.5	13.4	12.9	NS	NS	NS	NS	NS	13.7	14.4	16.0	
Performance Monitoring #8	6/23/2008	151	16.1	17.8	13.3	NS	NS	NS	NS	NS	19.6	15.3	15.6	
Performance Monitoring #9	7/22/2008	180	16.2	14.5	13.7	NS	NS	NS	NS	NS	18.8	17.4	18.0	
Performance Monitoring #10	9/22/2008	242	16.9	15.0	14.6	NS	NS	NS	NS	NS	16.9	16.3	17.3	
Performance Monitoring #11	11/11/2008	292	14.7	14.0	13.8	13.4	12.2	14.1	14.5	13.2	15.4	15.5	15.6	
Performance Monitoring #12	1/5/2009	347	11.3	12.0	12.7	NS	NS	NS	NS	NS	13.3	13.9	12.3	

NS, Not sampled

Table 5-10
Summary of Field Parameter Data

Event	Sampling Date	Days	Water Levels (ft TOC)										
			BMW-1	BMW-2	BMW-3	BMW-4	BMW-4	BMW-5	BMW-6	BMW-7	BMW-8	BMW-9	BMW-10
Baseline Sampling #1	10/10/2007	-105	7.30	7.95	6.23	7.72	10.15	8.53	12.65	13.25	7.51	7.63	5.00
Baseline Sampling #2	11/7/2007	-77	6.10	6.83	5.81	5.44	10.07	7.88	12.62	13.22	6.57	6.31	3.95
Tracer Sampling #1	11/20/2007	-64	5.92	7.60	4.89	5.97	9.38	7.53	11.64	12.84	NS	NS	NS
Tracer Sampling #2	11/26/2007	-58	6.52	7.49	4.93	5.64	7.55	9.49	11.70	12.84	6.00	NS	3.96
Tracer Sampling #3	12/4/2007	-50	5.35	6.31	5.31	5.04	9.07	8.00	11.16	12.36	5.51	5.23	3.55
Tracer Sampling #4	12/11/2007	-43	NS	6.69	4.93	5.12	9.06	7.11	11.26	13.50	5.94	5.35	3.46
Tracer Sampling #5	12/18/2007	-36	6.20	7.05	5.34	5.73	9.09	8.71	11.60	12.25	5.70	5.85	4.25
Tracer Sampling #6	1/3/2008	-21	5.13	6.08	4.29	4.97	8.89	6.63	11.01	NS	NS	NS	NS
Field Parameter Sampling	1/17/2008	-7	NS	NS	NS	NS	NS	NS	NS	NS	NS	NS	NS
Pre-Bioaugmentation Sampling	1/21/2008	-3	5.42	6.14	4.56	4.70	9.43	7.54	11.35	12.90	5.40	5.89	3.50
Performance Monitoring #1	1/30/2008	6	5.45	6.54	4.74	4.75	9.10	6.97	11.75	12.35	NS	NS	NS
Performance Monitoring #2	2/5/2008	12	4.97	5.51	4.94	4.41	8.45	6.14	10.78	11.41	NS	NS	NS
Performance Monitoring #3	2/19/2008	26	5.19	5.56	4.03	NS	8.64	NS	11.09	NS	NS	NS	NS
Performance Monitoring #4	3/17/2008	53	4.97	NS	4.21	NS	8.54	NS	10.57	NS	NS	NS	NS
Performance Monitoring #5	4/17/2008	84	4.71	6.10	4.36	NS	8.02	NS	11.02	NS	NS	NS	NS
Performance Monitoring #6	5/19/2008	116	4.79	5.96	3.80	4.35	8.55	6.95	10.95	11.70	NS	NS	NS
Performance Monitoring #7	6/4/2008	132	5.10	5.97	4.10	4.43	9.43	6.11	11.44	11.39	NS	NS	NS
Performance Monitoring #8	6/23/2008	151	7.31	7.76	6.09	6.10	10.20	8.15	12.08	13.25	NS	NS	NS
Performance Monitoring #9	7/22/2008	180	7.25	8.15	6.28	6.49	10.68	8.67	13.00	13.86	NS	NS	NS
Performance Monitoring #10	9/22/2008	242	9.05	9.15	6.80	7.20	11.58	9.23	13.71	14.16	NS	NS	NS
Performance Monitoring #11	11/11/2008	292	8.70	7.75	6.59	7.15	10.65	8.81	13.05	13.75	7.19	7.27	5.10
Performance Monitoring #12	1/5/2009	347	5.73	6.55	4.93	5.11	9.40	7.42	12.05	12.61	NS	NS	NS

Event	Sampling Date	Days	Water Levels (ft TOC)										
			PZ-1	PZ-2	MAG-113P	MAG-4	IW-1	IW-2	IW-3	IW-4			
Baseline Sampling #1	10/10/2007	-105	10.71	10.07	10.30	NS	6.39	8.19	10.00	13.70	NS	NS	NS
Baseline Sampling #2	11/7/2007	-77	NS	NS	NS	NS	6.08	8.05	9.82	13.36	NS	NS	NS
Tracer Sampling #1	11/20/2007	-64	NS	NS	NS	NS	NS	NS	NS	NS	NS	NS	NS
Tracer Sampling #2	11/26/2007	-58	10.27	NS	9.68	NS	NS	NS	NS	NS	NS	NS	NS
Tracer Sampling #3	12/4/2007	-50	9.05	8.84	9.13	NS	NS	NS	NS	NS	NS	NS	NS
Tracer Sampling #4	12/11/2007	-43	9.09	8.90	9.14	3.95	NS	NS	NS	NS	NS	NS	NS
Tracer Sampling #5	12/18/2007	-36	9.75	8.71	8.90	NS	NS	NS	NS	NS	NS	NS	NS
Tracer Sampling #6	1/3/2008	-21	8.83	8.68	8.87	NS	NS	NS	NS	NS	NS	NS	NS
Field Parameter Sampling	1/17/2008	-7	NS	NS	NS	NS	NS	NS	NS	NS	NS	NS	NS
Pre-Bioaugmentation Sampling	1/21/2008	-3	NS	9.45	9.35	3.45	NS	NS	NS	NS	NS	NS	NS
Performance Monitoring #1	1/30/2008	6	NS	NS	NS	NS	3.32	5.86	8.61	11.00	NS	NS	NS
Performance Monitoring #2	2/5/2008	12	NS	NS	NS	NS	1.55	2.01	8.25	10.99	NS	NS	NS
Performance Monitoring #3	2/19/2008	26	NS	8.30	NS	NS	NS	NS	NS	NS	NS	NS	NS
Performance Monitoring #4	3/17/2008	53	NS	8.10	NS	NS	0.92	5.52	8.14	5.83	NS	NS	NS
Performance Monitoring #5	4/17/2008	84	NS	8.66	NS	NS	4.10	5.06	10.03	9.98	NS	NS	NS
Performance Monitoring #6	5/19/2008	116	NS	8.11	NS	NS	NS	NS	NS	NS	NS	NS	NS
Performance Monitoring #7	6/4/2008	132	8.43	8.41	8.79	NS	NS	NS	NS	NS	NS	NS	NS
Performance Monitoring #8	6/23/2008	151	9.83	9.38	9.80	NS	NS	NS	NS	NS	NS	NS	NS
Performance Monitoring #9	7/22/2008	180	10.45	10.11	10.55	NS	NS	NS	NS	NS	NS	NS	NS
Performance Monitoring #10	9/22/2008	242	11.18	10.86	10.85	NS	NS	NS	NS	NS	NS	NS	NS
Performance Monitoring #11	11/11/2008	292	10.70	10.39	10.45	5.20	6.67	5.12	11.25	15.12	NS	NS	NS
Performance Monitoring #12	1/5/2009	347	9.39	9.15	8.79	NS	NS	NS	NS	NS	NS	NS	NS

NS, Not sampled

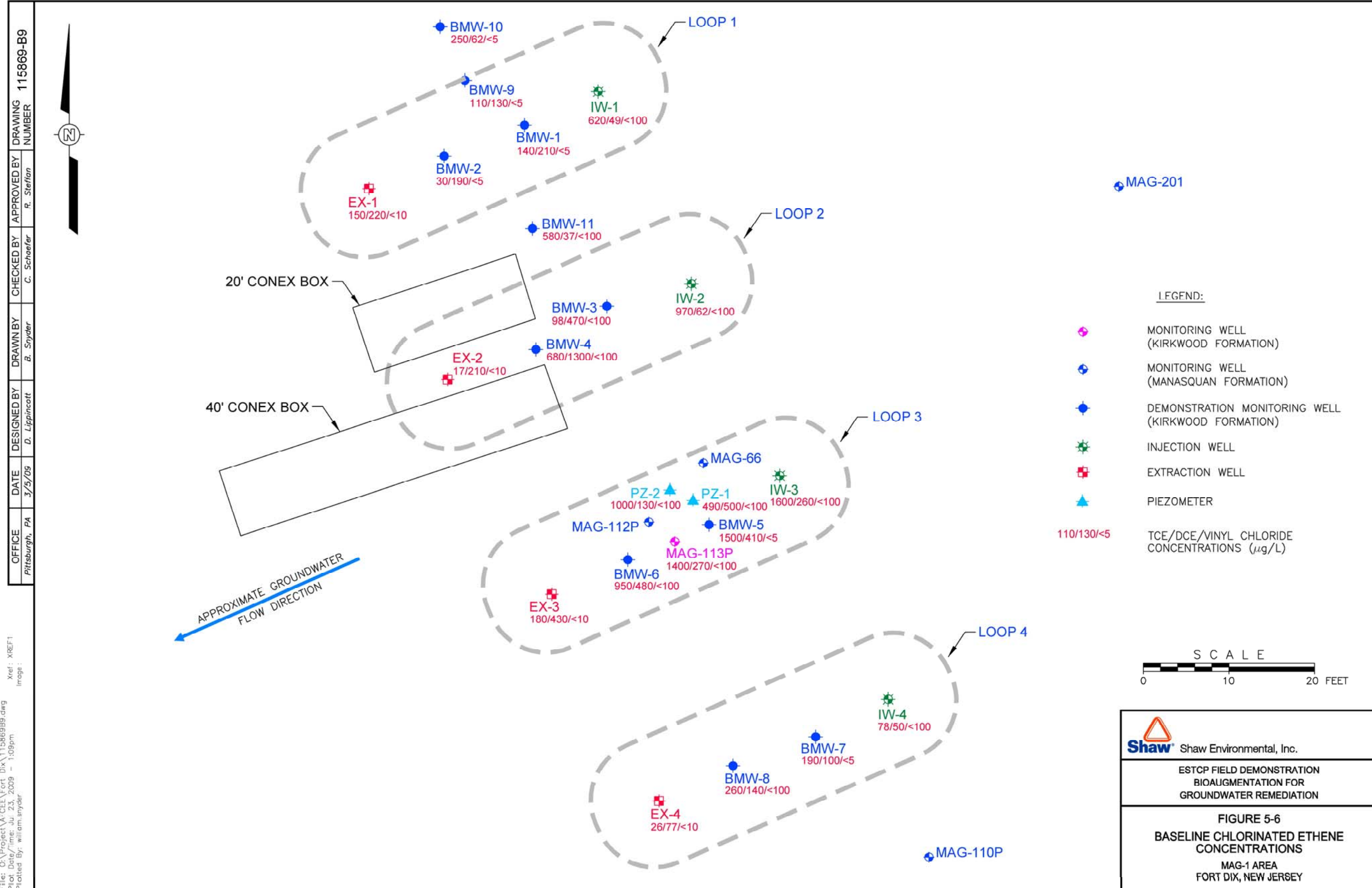

File: C:\Project\A\FCEE\Fort Dix\115869B9.dwg
Plot Date/Time: Jul 23, 2009 - 1:09pm
Plotted By: william.snyder
Xref: XREF1
Inrge:

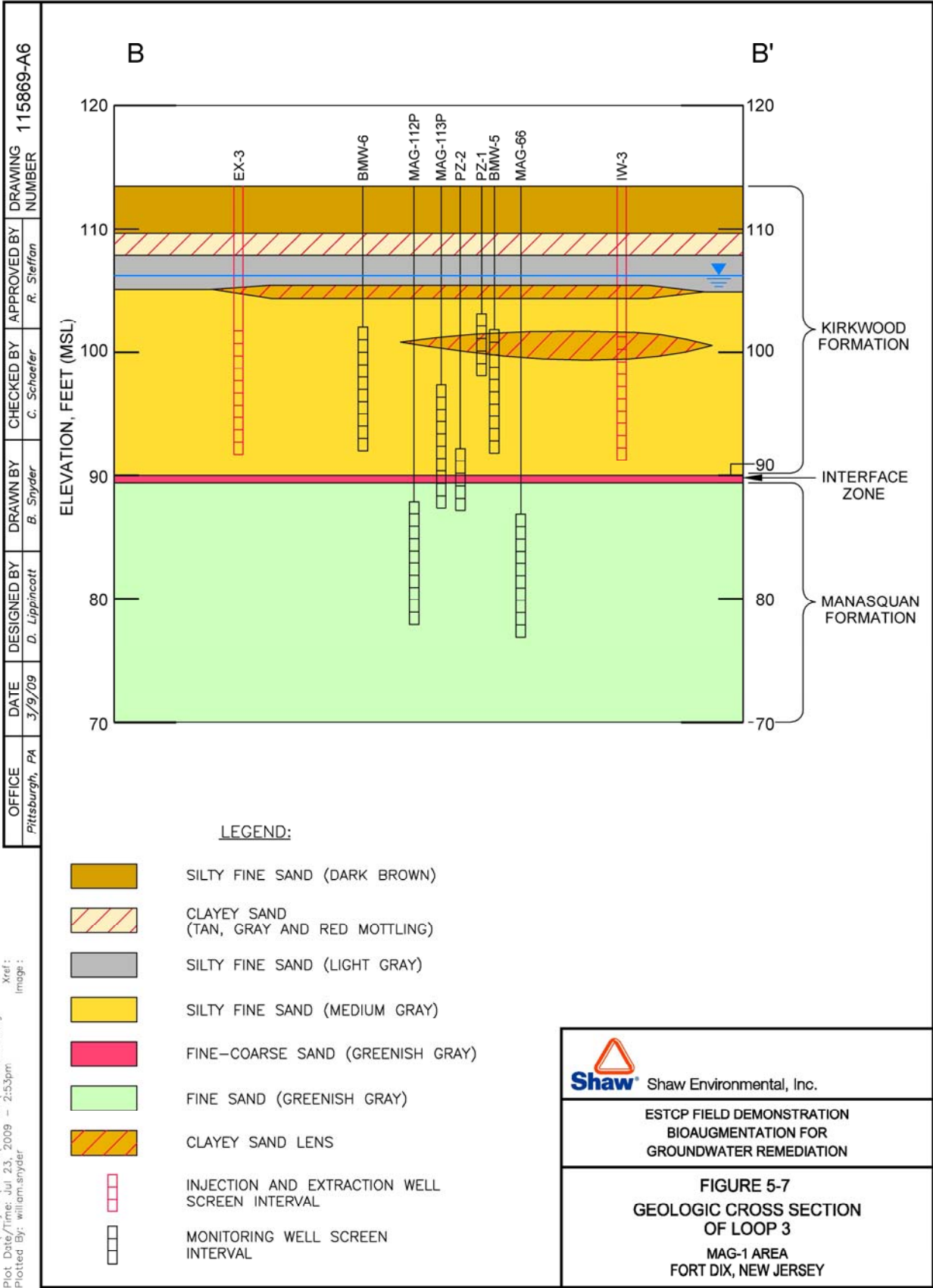

Volatile Fatty Acids

VFA analysis included the following fatty acids; lactate, acetate, propionate, formate, butyrate, pyruvate, and valerate. There were no detectable concentrations (PQL of 5.0 mg/L for each) of any of these acids in any of the wells sampled during either of the Baseline events (**Table 5-8**).

Metals

With the exception of the four extraction wells, groundwater samples were collected for dissolved iron and manganese from all of the demonstration area wells during the first Baseline sampling event (**Table 5-7**). Dissolved iron concentrations within the Kirkwood aquifer ranged from 1,400 µg/L to 7,570 µg/L (**Table 5-8**). Dissolved iron concentrations in wells PZ-2 and MAG-113P were also within this range. The presence of dissolved iron concentrations in this range further indicates that mildly reducing condition existed in the demonstration area (Dragun, 1998).

Dissolved manganese concentrations within the Kirkwood aquifer ranged from 15.4 µg/L to 63.7 µg/L (**Table 5-8**). Dissolved manganese concentrations in wells PZ-2 and MAG-113P were also within this range. The lack of significant dissolved manganese concentrations, along with the Site's mildly reducing and low pH conditions, suggest that manganese is not present at significant concentrations within Site soils (Dragun, 1998).

DHC

Data collected during the two baseline sampling events indicated that DHC concentrations ranged from non-detect to 3.92×10^5 cells per liter (**Table 5-9**).

Field Parameters

The key field parameters collected during Baseline sampling included pH, specific conductivity, oxidation-reduction potential (ORP), and dissolved oxygen (DO). Groundwater temperature and turbidity were also collected. Field parameter data collected are summarized in **Table 5-10**. The following summarizes the key field parameter data collected:

- pH: ranged from 4.1 (IW-2) to 5.4 (BMW-6 and IW-4) standard units, indicating that the groundwater was acidic.
- Specific conductivity: ranged from 19 microSiemens per centimeter (µS/cm) (BMW-9) to 236 µS /cm (IW-1).
- ORP: ranged from +19 milliVolts (mV) (BMW-6) to +219 mV (IW-1), indicating oxygen and nitrate reduction may have been occurring in portions of the aquifer.
- Dissolved Oxygen: ranged from 0.3 mg/L (BMW-4) to 3.4 mg/L (BMW-10), and was generally below 1.0 mg/L, indicating that the aquifer was anaerobic to anoxic.

5.2.6 Baseline Groundwater Elevation Measurements

Baseline groundwater elevation measurements were collected from all monitoring and extraction wells within the demonstration area on November 7, 2007, prior to collecting Baseline

groundwater samples. These data (summarized in **Table 5-11**) were used to establish baseline water table elevations, and hydraulic gradient and estimated groundwater flow directions within the Demonstration Area. A Baseline potentiometric surface contour map for the Shallow Alluvium aquifer is presented in **Figure 5-8**.

Table 5-11
Baseline Groundwater Elevations, November 7, 2007

Well	Measuring Point Elevation (ft. MSL)	Water Levels (ft. below MP)	Water Levels (ft. MSL)
BMW-1	112.12	5.92	106.20
BMW-2	112.46	6.37	106.09
BMW-3	111.16	5.01	106.15
BMW-4	111.29	5.25	106.04
BMW-5	115.39	9.27	106.12
BMW-6	112.90	6.89	106.01
BMW-7	117.79	11.69	106.10
BMW-8	118.33	12.32	106.01
BMW-9	111.97	5.82	106.15
BMW-10	111.74	5.54	106.20
BMW-11	109.93	3.77	106.16
PZ-1	115.41	9.29	106.12
PZ-2	115.23	9.10	106.13
EX-1	114.34	8.36	105.98
EX-2	115.39	9.46	105.93
EX-3	117.05	11.16	105.89
EX-4	119.13	13.24	105.89
IW-1	112.12	NM	NM
IW-2	114.41	NM	NM
IW-3	116.14	NM	NM
IW-4	118.73	NM	NM
MAG-201	112.77	5.87	106.90

Based on the baseline data, groundwater flow direction is generally to the southwest and the hydraulic gradient across the demonstration area was approximately 0.012 for the Kirkwood aquifer. Using the hydraulic conductivity data derived from the pump test, and assuming an effective porosity of 25 percent, the groundwater velocity within the Kirkwood formation was estimated at approximately 0.08 ft/day. Water level measurements at monitoring wells MAG-112P and MAG-113P indicated that there was no measureable vertical gradient between the Kirkwood and Manasquan aquifers (at this location) under baseline conditions.

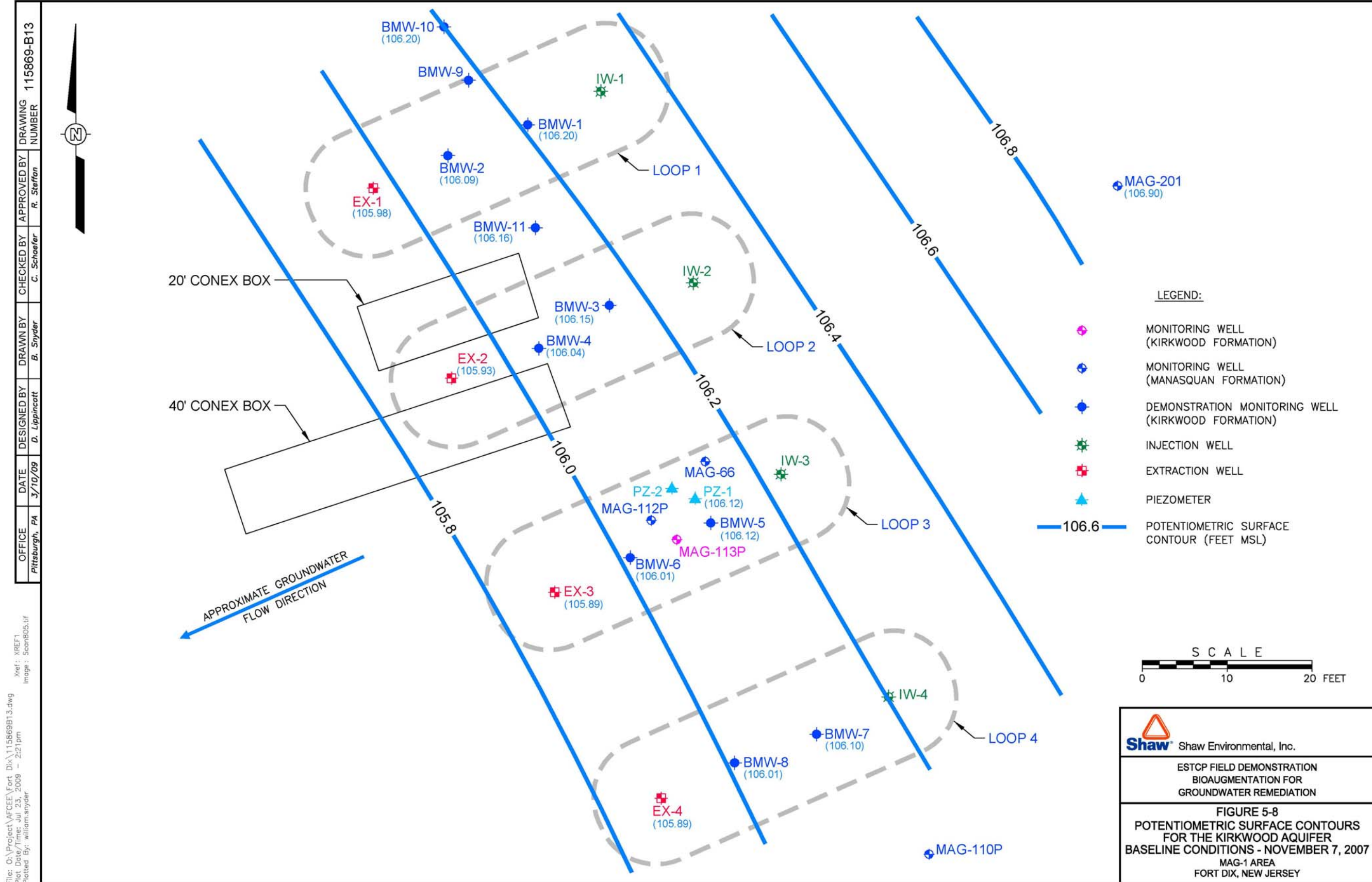

OFFICE: Pittsburgh, PA
 DATE: 3/10/09
 DESIGNED BY: D. Lippincott
 DRAWN BY: B. Snyder
 CHECKED BY: C. Schoefer
 APPROVED BY: R. Steffen
 DRAWING NUMBER: 115869-B13

File: O:\Project\AFCEE\Fort Dix\115869B13.dwg
 Plot Date/Time: Jul 23, 2009 - 2:21pm
 Plotted By: william.snyder

5.3 TREATABILITY AND LABORATORY STUDY RESULTS

Laboratory studies associated with this project included two separate microcosm tests and two separate column tests. Implementation and results of these studies are detailed in the following subsections.

5.3.1 Laboratory Microcosm Testing

Prior to ESTCP funding of this project, an initial laboratory microcosm study was begun in June, 2004. Details of the study and results are presented in Appendix E of the Demonstration Plan (Shaw 2007). Briefly, soil and groundwater collected from the MAG-1 Area were used to determine if addition of biostimulation amendments could facilitate the biodegradation of TCE. Three electron donors (lactate, emulsified vegetable oil, and polylactate ester), combined with a sodium phosphate buffer (pH 7), were evaluated. Results collected over a 97-day period showed that no measurable biodegradation of the TCE occurred relative to the controls. Thus, biostimulation-alone was insufficient for treating the TCE, likely due to a deficiency in the indigenous DHC populations.

A second laboratory microcosm study was initiated in June, 2005. This second study, described in detail in Appendix F of the Demonstration Plan (Shaw 2007), was performed similarly to the first study. However, bioaugmentation using Shaw's SDC-9 culture (along with lactate, nutrients, and carbonate buffer) was selected as the treatment. Results showed that chlorinated ethene concentrations in the treatments were below the analytical detection limit within 11 days of inoculation; ethene and ethane were generated as end products. The SDC-9 dosage in the study was approximately 10^6 cells/mL. Approximately 0.007g sodium bicarbonate per 30 g soil was needed to raise the pH from 4.6 to 6.0. Thus, bioaugmentation, combined with pH buffering, was shown to be a potentially feasible option for treating TCE in the MAG-1 Area.

Overall, results of the laboratory microcosms testing showed that biostimulation-alone was insufficient for treating TCE in the demonstration area, and that addition of DHC was needed to biodegrade the chlorinated ethenes.

5.3.2 Preliminary Testing to Evaluate SDC-9 Transport and Kinetics through Saturated Soil

Preliminary column tests were performed using Shaw's SDC-9 microbial culture. The objectives of these tests were to evaluate SDC-9 transport, growth, and chlorinated ethene degradation kinetics through a sandy soil (MAG-1 soil and groundwater were not used in these preliminary tests).

Columns were prepared using a 7.2 cm diameter x 20 cm long section of aluminum tubing sealed with ½" thick Teflon end caps. The Teflon end caps had circular channels cut to one half their thickness to accommodate rubber o-rings as a sealant, and were secured with ¼" threaded rods. The center of the end caps were drilled and tapped to attach stainless steel fittings for influent and effluent lines and sampling ports. Two additional sampling ports were equally spaced along

the length of the column with 16 gauge stainless steel needles extending to the columns center and controlled by stop cocks. A schematic of the column is shown in **Figure 5-9**.

Figure 5-9. Schematic of Column Apparatus Used in Laboratory Testing

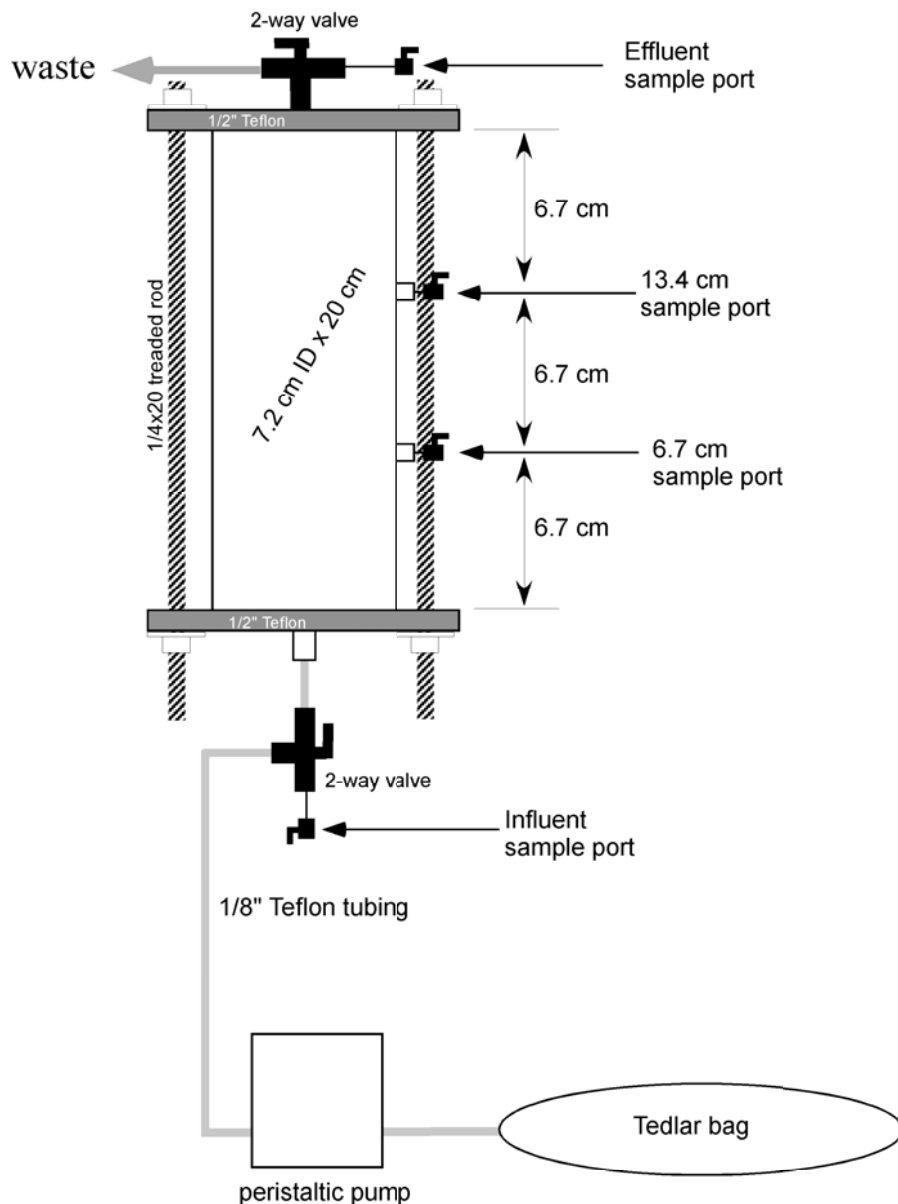

Groundwater contaminated with cDCE and amended with lactate was pumped from a Tedlar bag upward through the column at 5 mL per hour using a peristaltic pump; injection of the cDCE contaminated groundwater continued until equilibrium conditions were established across the length of the column. 28 mL (equivalent to 0.1 column pore volumes) of Shaw's DHC-containing microbial consortia, SDC-9, was then injected at a DHC concentration of approximately 4×10^5 DHC/mL; injection (5 mL/hr) of the cDCE contaminated and lactate amended groundwater was resumed immediately after the SDC-9 was delivered.

Groundwater was sampled at each of the three sampling ports as a function of time during the 8-week experiment. Samples were analyzed for VOCs, DHC (via qPCR analysis), volatile fatty acids, and ethane/ethene. The column experiment was performed in duplicate.

Results of the column testing showed that a small fraction of the DHC initially injected was able to migrate through the column. The concentration of DHC migrating through the column increased with time as DHC growing from immobilized DHC near the column effluent detached and migrated through the column. This rate of increase correlated to increased degradation of the chlorinated ethenes, as indicated by decreasing chlorinated ethene concentrations throughout the column as a function of time. The rates of increase in measured DHC concentrations, as well as the rate of chlorinated ethene decreases, were well predicted by a Monod kinetic model that had been previously calibrated to results obtained from batch experiments. Column data, along with the corresponding model simulations, are shown in **Figure 5-10**. Thus, these column studies demonstrated our ability to predict chlorinated ethene biodegradation rates and DHC distribution during bioaugmentation. The Monod model also was validated as a useful tool for selecting DHC dosages for the bioaugmentation demonstration (Schaefer et al, 2009).

Figure 5-10. Results of Laboratory Column Testing

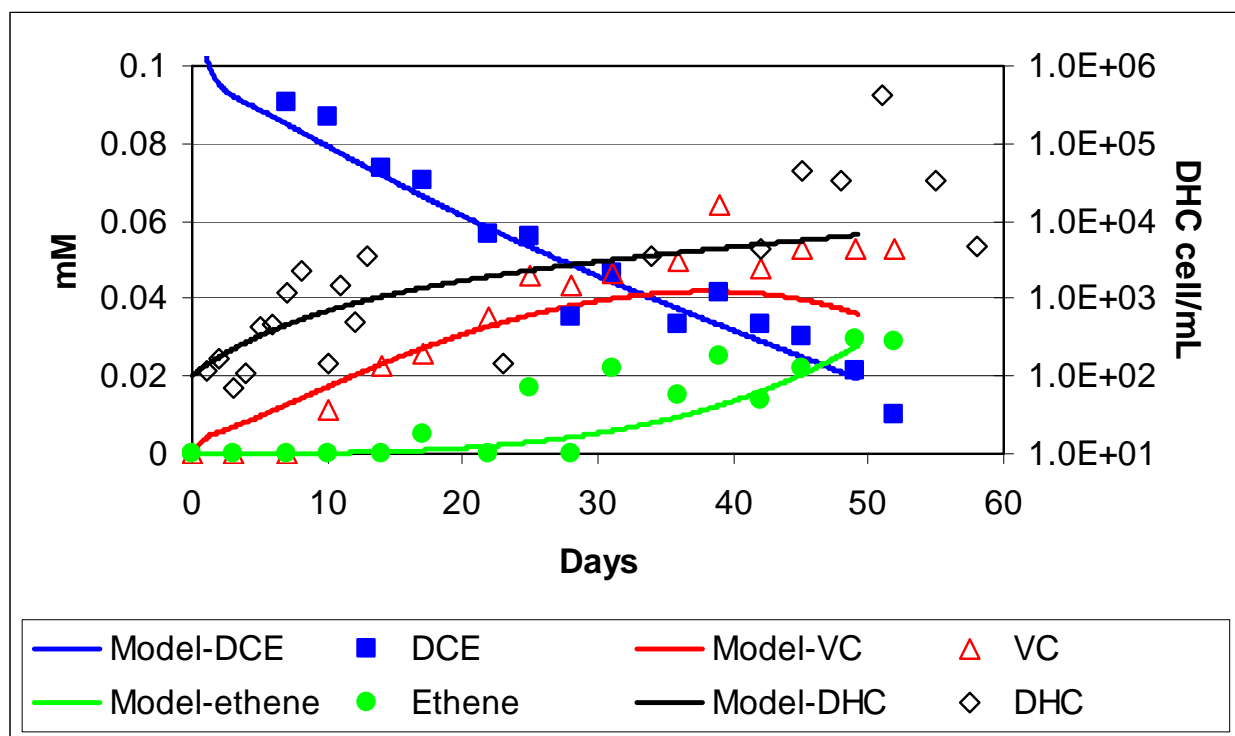

Results are shown for 6 cm from the column influent

5.3.3 Column Testing using MAG-1 Soil and Groundwater

Laboratory column testing was performed to verify results of the microcosm and preliminary column testing, and to evaluate microbial distribution, growth, and dechlorination activity through site soils. Column testing also was used to verify the dosage of SDC-9 that was to be

used in the field demonstration. Soil from the MAG-1 area, at the depth interval used in the demonstration, was used to prepare the columns. The MAG-1 soil was classified as a silty, fine to very fine sand, and was less permeable than the sand used in the preliminary column testing.

Column design and testing procedures were essentially identical to those described in the previous section, with the exception of pH buffering (using sodium bicarbonate). Column results showed that the SDC-9 inoculation resulted in measurable ethene generation in the column. The column study was only performed for a relatively short duration, so a complete evaluation of dechlorination kinetics could not be observed. However, evaluation of the column kinetics showed that the kinetics were reasonably similar to those observed using the sandy soil described in the previous section, although a longer lag period was observed. Thus, the column testing confirmed the results of the microcosm testing, indicating that bioaugmentation, combined with pH buffering, was a potentially feasible option for treating TCE in the MAG-1 Area.

5.4 DESIGN AND LAYOUT OF TECHNOLOGY COMPONENTS

Design and installation of the groundwater recirculation and amendment delivery systems, as well as the layout and installation of the demonstration wells is described in detail in the following subsections. System installation began in June 2007, and took approximately 3½ months to complete (**Table 5-1, Figure 5-1**).

5.4.1 Groundwater Modeling and Final System Conceptual Design

Final system conceptual design was based on results of the laboratory microcosm and column studies (**Section 5.3**), the Direct-Push investigation (**Section 5.2.1**), slug/pump testing (**Sections 5.2.3 and 5.2.4**), and a site-specific groundwater hydrogeologic fate and transport model. Final system design included the following:

- Location and screen intervals for injection and extraction wells
- Injection/extraction well flow rates
- Location and screen intervals for monitoring wells
- Amendment (i.e., lactate, DHC) dosage

MODFLOW (USGS, 1996), a three-dimensional groundwater flow model, was used to construct a geologic and hydraulic model of the demonstration area. RT3D (Clement et al., 1997), a solute fate and transport model used within the MODFLOW groundwater flow model, was used to simulate the migration and biodegradation of target contaminants. RT3D was also used to evaluate the mixing and fate of cosubstrate amendments. Both the MODFLOW and RT3D models were developed using the site-specific hydraulic, geologic, and biological (i.e., contaminant and electron donor biodegradation rates) data obtained during the baseline characterization described in **Section 5.2** and the laboratory microcosm and column testing data described in **Section 5.3**.

The model was used to facilitate the design of the *in situ* bioaugmentation system (i.e. determine injection/extraction well locations, pumping rates, and the lactate injection schedule) in order to achieve decreases in groundwater chlorinated ethene concentrations. The model simulated

transport of the lactate and target contaminants in the groundwater flow field induced by operation of the treatment system. The rate of contaminant degradation was modeled using Monod kinetics, with the electron donor (i.e., lactate) present in excess. Kinetic parameters for contaminant biodegradation within the model were estimated based on the laboratory microcosm and column studies. Additional details of the model are presented in Appendix G of the Demonstration Plan.

Transport and growth of the injected DHC microorganisms were not explicitly simulated in the MODFLOW/RT3D model. Instead, a constant and uniform DHC population was inherently assumed within the model. This simplification is based on the results of the laboratory column experiments and corresponding Monod microbial kinetic model, which indicated that approximately 0.1% of the injected DHC were readily mobile (i.e., adhesion deficient) through the saturated soil; the concentration of DHC throughout the column increased at a rate that was proportional to the rate predicted by the Monod kinetic model. Parallel batch experiments showed that cDCE biodegradation rates could be approximated by a pseudo first order biodegradation rate constant, where

$$\text{DHC concentration} = 5 \times 10^4 \text{ cell/mL} \rightarrow k = 0.019/\text{day}$$

$$\text{DHC concentration} = 5 \times 10^2 \text{ cell/mL} \rightarrow k = 0.0014/\text{day}$$

Thus, an effective first order biodegradation rate constant was estimated for a given DHC concentration (or, dosage). This estimation formed the basis for the estimated biodegradation rate constant (0.001/day) used in the model. It should be noted that a first-order rate constant is an approximation, as this rate constant incorporates an average value of both microbial kinetics and growth. Such an approximation, however, is sufficient for estimating the overall rate of contaminant decay during bioaugmentation treatment, and allows the use of simpler and commercially available microbial kinetic models to be used within the framework of a hydrogeologic model (as demonstrated for the model presented in Appendix G of the Demonstration Plan).

The overall goal of the model was to facilitate the conceptual design of an *in situ* bioaugmentation system. Specifically, the model was used to verify and evaluate the following:

- Mixing of injected amendments with groundwater. Simulated amendment concentrations in the treatment zone were evaluated as a function of depth and distance from the injection well to determine the well flow rates, spacing, and screen interval needed to ensure proper mixing;
- Biodegradation (via bioaugmentation) of chlorinated ethenes within the treatment zone, and within a reasonable timeframe. Simulated contaminant biodegradation rate constants were based on the results of the laboratory microcosm and column studies. These rate constants were used within the model to verify that the conceptual system design provided sufficient residence time such that substantial decreases in chlorinated ethene concentrations would be observed within the timeframe of the demonstration.

- Determination of DHC dosage. As previously discussed, chlorinated ethene biodegradation rates are, in part, controlled by the DHC concentrations. Thus, the model was used to verify that the selected DHC dosages would result in substantial chlorinated ethene biodegradation rates within the timeframe of the project, and that measurable differences in contaminant biodegradation rates among the selected dosages would be expected.
- Design of a monitoring well network to sufficiently evaluate system performance. The model was used to determine locations and screen intervals for monitoring wells so that system performance could be assessed. Specifically, wells were placed in locations so that simulated extraction well capture (i.e., drawdown), amendment delivery, and contaminant concentrations could be observed.

The system design, based on the MODFLOW/RT3D simulation, consists of four pairs of injection/extraction wells (IW-1 through IW-4, and EX-1 through EX-4) operating at 0.50 gpm per pair. The actual surveyed system layout, including two performance monitoring wells within each recirculation loop is shown in **Figure 5-5**. These monitoring wells (BMW-1 through BMW-8) are spaced approximately 10 feet and 20 feet downgradient of the injection well. Three additional performance monitoring wells (BMW-9 through BMW-11) are located between or side-gradient of select loops. As described in **Section 4.3**, the system is located within the core of the dissolved TCE/cDCE plume. Based on the demonstration area lithology, contaminant distribution, and results of the demonstration area characterization activities (**Section 5.2**), all extraction, injection and performance monitoring wells were screened within the Kirkwood formation, and above the Interface Zone (**Figure 5-7**). The injection/extraction well pairs were oriented parallel to groundwater flow, and Loop 3 was positioned so as to utilize existing monitoring wells, as well as the nested piezometers installed during the hydrogeologic investigation (**5.2.2**). **Table 5-4** summarizes the well construction details for the injection and extraction wells, monitoring wells, and piezometers.

Particle tracking analysis was performed using the model to determine the travel time between the injection and extraction wells, and to ensure that the spacing between well pairs was sufficient to prevent any substantial cross-flow between the well pairs. Results of the particle tracking analysis are shown in **Figure 5-11**. Results showed that 30-foot separation spacing between injection/extraction well pairs is sufficient for preventing any substantial cross-flow, and that the particle travel time from the injection to the extraction well is approximately 35 days.

Model simulations presented in the Demonstration Plan showed the expected changes in groundwater chlorinated ethene concentrations as a function of time for initial DHC dosages of 5×10^7 cell/mL and 5×10^5 cell/L, respectively. Results showed that measurable biodegradation within 120 days after bioaugmentation was expected for each dosage. In addition, a substantial difference was expected in the overall rate of remediation between the two treatment dosages. Thus, the three DHC dosages selected for the field demonstration were approximately 5×10^7 cell/L, 5×10^6 cell/L, and 5×10^5 cell/L, which equate to SDC-9 injection volumes of 100 L, 10 L, and 1 L, respectively. These selected dosages were expected to provide measurable VOC biodegradation within the duration of the demonstration period, and were expected to exhibit

degradation rates that are measurably different from each other. Observed demonstration degradation rates, as they relate to DHC dosage, are discussed in **Sections 5.7.4** and **6.1**. NOTE: DHC concentrations are based on injected DHC cells divided by the saturated treatment volume of each loop.

Figure 5-11. Particle Tracking Simulation

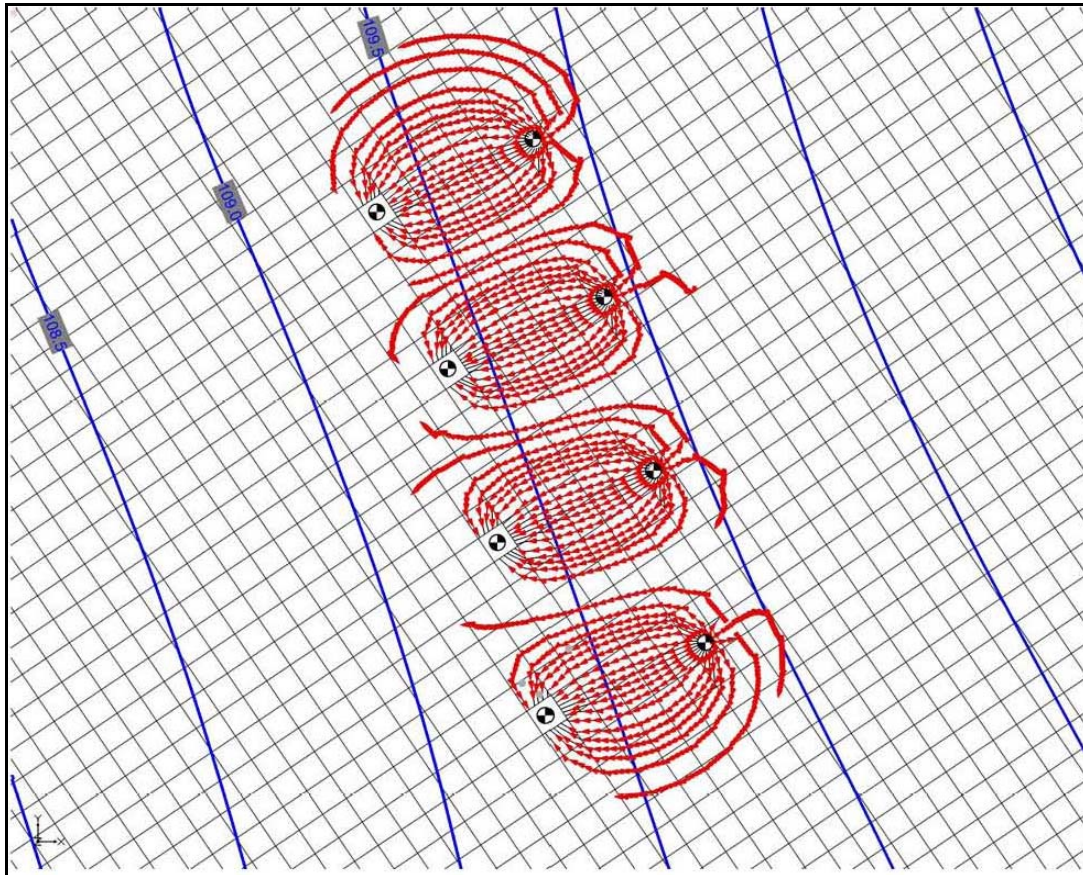

5.4.2 Permitting

Shaw applied for a New Jersey Discharge Elimination System (NJPDES) Discharge to Groundwater (DGW) Permit-By-Rule from the NJDEP case manager for the multiple injections of bioaugmentation amendments, aquifer conditioning agents, and bromide/fluoride tracers. The Permit-By-Rule submittal letter was submitted on March 28, 2007, and contained all required technical design information necessary for the NJDEP case manager to write and approve the permit. NJDEP approval was provided in a letter dated September 21, 2007. Shaw's Permit-by-Rule submittal letter and the NJDEP approval letter are provided in **Appendix G**.

All monitoring, extraction and injection well permits were obtained by the subcontracted drilling company (SGS Environmental Services, Inc.) directly through the NJDEP Bureau of Water Allocation. All facility specific protocols were adhered to and field activities were coordinated through the appropriate facility representatives for the necessary safety permits, and utility clearances.

5.4.3 Well and Equipment Installation

5.4.3.1 Grubbing and Clearing

As shown on **Figure 4-2**, the Demonstration Area is located within a wooded area. A temporary access road was created, starting from the tree-line west-southwest of monitoring well MAG-67, to the Demonstration Area. The road was intentionally built around larger trees. Smaller trees (less than 10 inches in diameter) were cut down flush with the ground surface with a chainsaw and moved to a designated area. Locations were also cleared for the Demonstration wells and remediation systems (housed within two Conex boxes; **Figure 5-5**). Dense gravel aggregate was used to create two level pads for the Conex boxes, and to improve portions of the access road. Grubbing, clearing and gravel spreading activities were conducted between March 28 and April 6, 2007 (**Table 5-1**).

5.4.3.2 Well Installations

Installation and development of extraction, injection and monitoring wells was performed between June 6 and July 2, 2007 (**Table 5-1, Figure 5-1**). The final Demonstration well layout is provided in **Figure 5-5**. Four recirculation loops were installed, with an orientation parallel to groundwater flow. The layout includes approximately 25 feet of separation between each recirculation loop. The distance between the injection well (designated as IW) and extraction well (designated as EX) in each loop is approximately 30 feet. Two performance monitoring wells (designated as BMW) were installed along each of the injection/extraction well transects, at distances of approximately 10 and 20 feet from the injection well, respectively. Each of the injection/extraction well pairs, along with the two intermediate monitoring wells, comprised a recirculation loop. The four loops allowed the following amendment dosages to be tested.

- Loop 1: Lactate, buffer, nutrients, and 100 L of SDC-9 injected
- Loop 2: Lactate, buffer, nutrients, and 10 L of SDC-9 injected
- Loop 3: Lactate, buffer, nutrients, and 1 L of SDC-9 injected
- Loop 4: Lactate, buffer, and nutrients only

Three additional performance monitoring wells (BMW-9 through BMW-11) were installed side-gradient of the Loop 1 injection/extraction well transect to monitor lateral distribution of amendments, and possible cross flow between loops (**Figure 5-5**). A cross-sectional view of Loop 3 is shown in **Figure 5-7**. Well construction details for Demonstration Area injection, extraction, and monitoring wells are summarized in **Table 5-4**.

All well installations were performed by a New Jersey licensed driller (SGS Environmental Services, Inc.) and supervised by a Shaw geologist. The injection and extraction wells were installed within a nominal 10-inch diameter borehole using HSA drilling methods. Injection and extraction wells were constructed using flush-threaded, 6 inch diameter, Schedule 40, PVC, with 10 feet of 0.020 inch slotted screen (**Table 5-4**).

The filter pack for each injection and extraction well consists of #2 Morie sand extending to 1.5 feet above the top of screen. A 1.5-foot transition pack of #00 Morie sand was placed above the #2 sand, and cement-bentonite grout was emplaced to within 3 feet of the surface via Tremie pipe (grout was not installed above 3-feet bgs to allow for the below-ground installation of pitless adapters through the well casing). Each well was completed with an approximate 2-foot PVC stick-up.

The BMW series performance monitoring wells were also installed using the HSA drilling method. The wells were installed within a nominal 8-inch diameter borehole. Performance monitoring wells were constructed with flush-threaded, 2 inch diameter, Schedule 40, PVC riser and 10 feet of 0.010-inch slotted PVC well screen (**Table 5-4**).

The filter pack for each monitoring well consists of #1 Morie sand extending to 1.5 to 2.0 feet above the top of screen. A 1.0 to 1.5-foot transition pack of #00 Morie sand was placed above the #1 sand, and cement bentonite grout was emplaced to within 2 feet of the surface via Tremie pipe. Each well was completed with a locking steel well casing protector installed in a 24 inch by 24 inch concrete pad at the ground surface. Well construction details are summarized in **Table 5-4**.

Development of all the extraction, injection and monitoring wells was accomplished by surging the well with a surge block and pumping the groundwater until the water was clear and the well was sediment free to the fullest extent practical. Wells were developed using a submersible pump and water was not be added to the well to aid in development. The pump, hose, and cable were decontaminated between wells following the procedures outlined in Demonstration Plan.

Well installation and development activities (including equipment decontamination), and management of IDW were conducted as detailed in the Demonstration Plan (Shaw 2007). Field activities were conducted in Level D Protection. Underground utility clearances were obtained for all intrusive site activities. Clearance of all underground utilities was arranged with appropriate Fort Dix facility personnel and local utility companies.

After the wells were completed, each well was surveyed by a licensed surveyor to determine its horizontal location to within ± 1 foot, and the elevation of the top of the inner PVC well casing to a ± 0.01 -foot precision.

5.4.3.3 Well Pumps, Piping, and Controls Installation

The majority of the groundwater recirculation and amendment injection systems were installed during the weeks of September 17 and September 24, 2007 (**Table 5-1, Figure 5-1**). The systems were constructed within one 40-foot long and one 20-foot long Conex box, located within the demonstration area (**Figure 5-5**). A photograph of the Conex boxes is provided in **Figure 5-12**. A diagram showing the general design of the system, including extraction and injection wells and the associated equipment, is provided in **Figure 5-13**. Submersible variable-speed pumps were installed in the extraction wells to extract groundwater from the aquifer. The extraction well pumps were centered within the screen interval of the extraction wells.

Figure 5-12. Photograph of 20-foot and 40-foot Conex Boxes



Three-foot deep trenches were excavated from each of the extraction and injection wells to the 20-foot Conex box. Piping and conduit were connected to each of the wells (**Figure 5-14**), installed within the trenches, and passed through the bottom of the Conex box. Conduits were used for pump power supply wires, level control probe wires, and cables connected to pressure transducers installed in each of the extraction and/or injection wells. Valves, gauges, and fittings were installed as necessary to complete the piping runs and connections. The trenches were backfilled after leak testing was performed on the piping and all wires and cables were successfully installed.

Shaw coordinated installation of single-phase, 240 Volt, 150 Amp electrical service and a wireless communications system to the 20-foot Conex box. Shaw subcontracted Calcon Systems, Inc. to update a process controls system within the Conex box (the Conex box and controls system were used during a previous bioremediation project). The controls system consisted of a Programmable Logic Controller (PLC) panel (**Figure 5-15**) connected to a desktop computer, and a Supervisory Control and Data Acquisition (SCADA) system (**Figure 5-16**). The PLC panel was connected to flow meters/totalizers and level control probes within the extraction wells, and the electron donor and biocide dosing systems. The SCADA system collected data from various sensors and system components and sent the data to the computer for recording and storage. The SCADA system and wireless communications system allowed for remote real-time monitoring and control of several system operating conditions. Parameters measured and recorded during operation included electron donor and buffer metering pump run times, extraction and injection well pump run times, flow rates, and speed, and water levels within the injection wells. By remotely monitoring these parameters, system operating problems could be quickly identified and resolved.

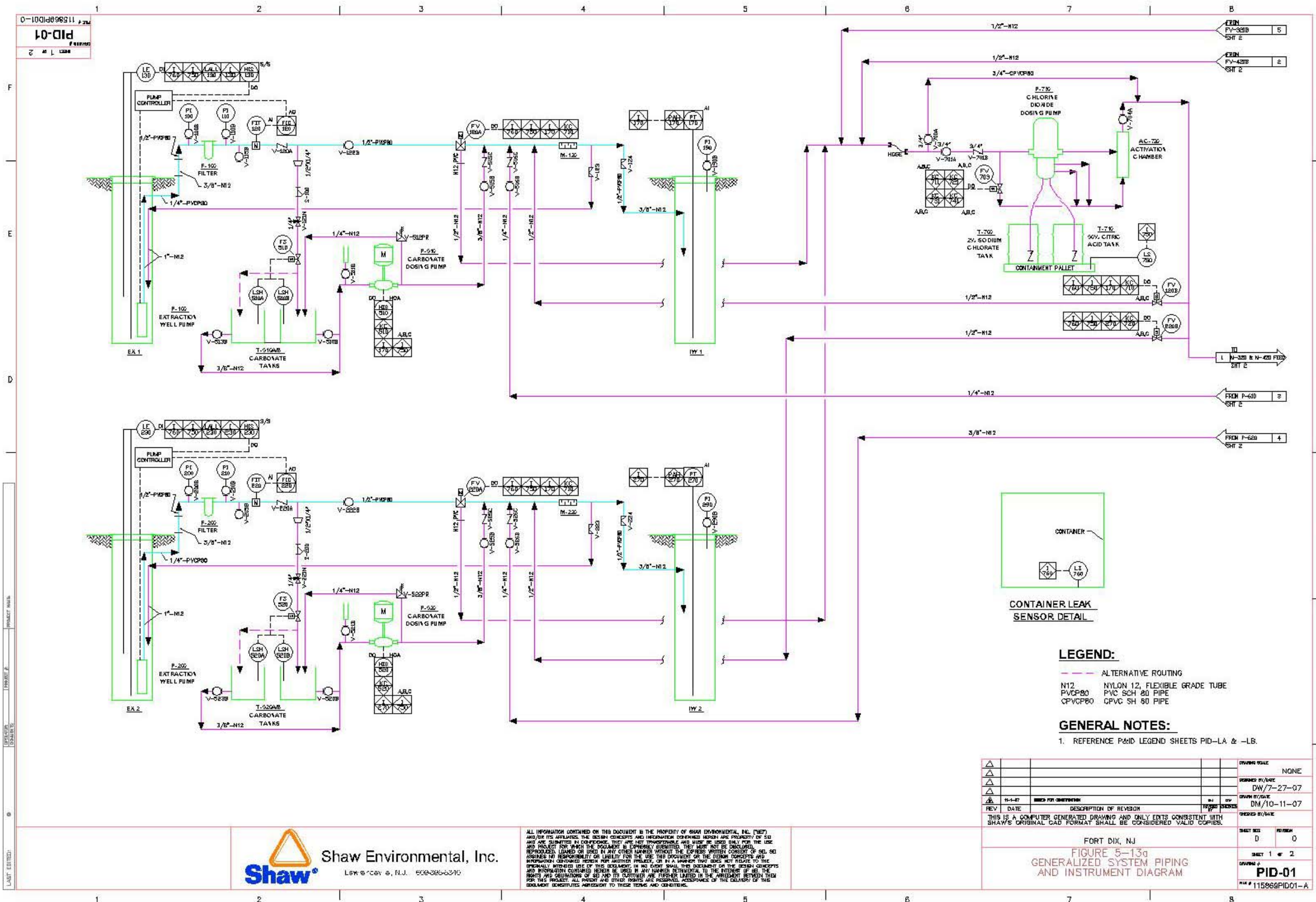

115969PID01-0
 PID-01
 2 of 2

PROJECT NAME: BIOAUGMENTATION FOR GROUNDWATER REMEDIATION
 PROJECT #:
 DRAWING NO: DW/7-27-07
 DATE: 11-1-07
 DRAWN BY: DM/10-11-07
 CHECKED BY: [Signature]
 PROJECT NO: 50A386-0210
 SHEET NO: 0 OF 0
 SHEET 1 OF 2
 DRAWING: PID-01
 P&ID # 115969PID01-A



ALL INFORMATION CONTAINED ON THIS DOCUMENT IS THE PROPERTY OF SHAW ENVIRONMENTAL, INC. ("SEI") AND/OR ITS AFFILIATES. THE DESIGN CONCEPTS AND INFORMATION CONTAINED HEREIN ARE PROPERTY OF SEI AND ARE SUBMITTED IN CONFIDENCE. THEY ARE NOT TRANSFERABLE AND MUST BE USED ONLY FOR THE USE AND PROJECT FOR WHICH THE DOCUMENT IS EXPRESSLY SUBMITTED. THEY MUST NOT BE DISCLOSED, REPRODUCED, LOANED OR USED IN ANY OTHER MANNER WITHOUT THE EXPRESS WRITTEN CONSENT OF SEI. SEI ASSUMES NO RESPONSIBILITY OR LIABILITY FOR THE USE OF THIS DOCUMENT OR THE DESIGN CONCEPTS AND INFORMATION CONTAINED HEREIN FOR ANY OTHER PROJECT, OR IN A MANNER THAT DOES NOT RELY ON THE ORIGINAL INTENT OF THIS DOCUMENT. IN NO EVENT SHALL THIS DOCUMENT OR THE DESIGN CONCEPTS AND INFORMATION CONTAINED HEREIN BE USED IN ANY MANNER RETROACTIVE TO THE PRESENT OR FUTURE DESIGN OR CONSTRUCTION OF SEI OR ITS CLIENTS OR BE FURTHER LIAISED IN THE AGREEMENT BETWEEN THEM FOR THIS PROJECT. ALL RIGHTS AND OTHER RIGHTS ARE RESERVED. ACCEPTANCE OF THE DELIVERY OF THIS DOCUMENT CONSTITUTES ACCEPTANCE OF THESE TERMS AND CONDITIONS.

DESIGNED BY/DATE	NONE		
DRAWN BY/DATE	DW/7-27-07		
CHECKED BY/DATE	DM/10-11-07		
REV	DATE	DESCRIPTION OF REVISION	ISSUED BY/DATE
1	11-1-07	ISSUED FOR CONSTRUCTION	DM/10-11-07
THIS IS A COMPUTER GENERATED DRAWING AND ONLY EDITS CONSISTENT WITH SHAW'S ORIGINAL CAD FORMAT SHALL BE CONSIDERED VALID COPIES.			
FORT DIX, NJ			
FIGURE 5-13a			
GENERALIZED SYSTEM PIPING AND INSTRUMENT DIAGRAM			
SHEET NO.	0	TOTAL SHEETS	0
DRAWING NO.		PID-01	
PROJECT NO.		115969PID01-A	

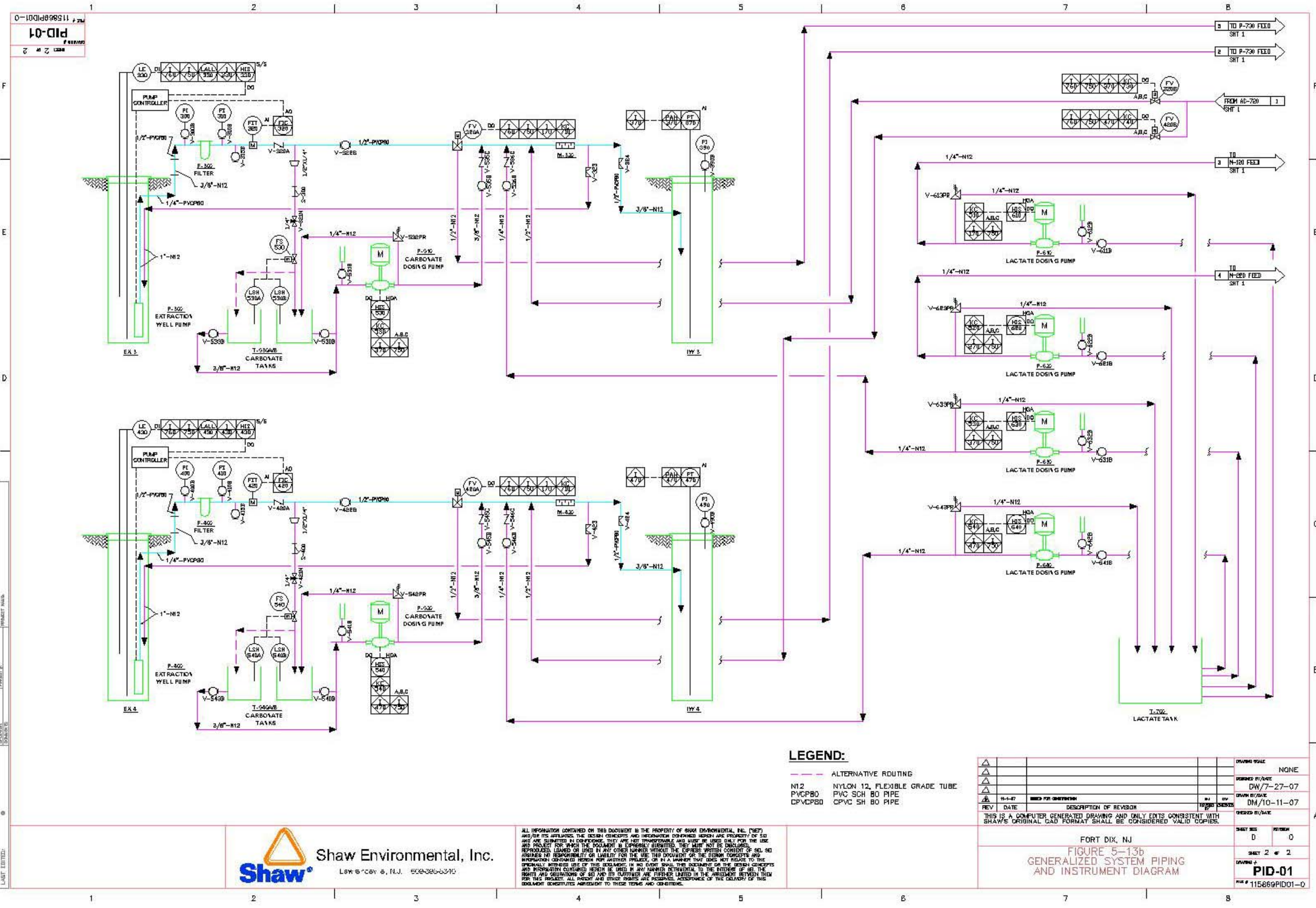

PID-01
SHEET 2 OF 2
115869PID01-0

LEGEND:
 - - - ALTERNATIVE ROUTING
 N12 NYLON 12, FLEXIBLE GRADE TUBE
 PVCPSB PVC SCH 80 PIPE
 CPVCPB CPVC SH 80 PIPE

DESIGNED BY/DATE	DM/10-11-07	REVISIONS	
DRAWN BY/DATE	DM/10-11-07	DATE	
CHECKED BY/DATE		DESCRIPTION OF REVISION	
DATE			
THIS IS A COMPUTER GENERATED DRAWING AND ONLY EDITS CONSISTENT WITH SHAW'S ORIGINAL CAD FORMAT SHALL BE CONSIDERED VALID COPIES.			
FORT DIX, NJ			
FIGURE 5-13b			
GENERALIZED SYSTEM PIPING AND INSTRUMENT DIAGRAM			
SHEET NO.	D	TOTAL SHEETS	0
DRAWING NO.		PID-01	
SHEET 2 OF 2		115869PID01-0	



ALL INFORMATION CONTAINED ON THIS DOCUMENT IS THE PROPERTY OF SHAW ENVIRONMENTAL, INC. (SEI) AND/OR ITS AFFILIATES. THE DESIGN, CONCEPTS AND INSTRUMENTATION CONCEPTS ARE PROPERTY OF SEI AND ARE SUBMITTED IN CONFIDENCE. THEY ARE NOT TO BE REPRODUCED OR USED FOR ANY OTHER PROJECT WITHOUT THE EXPRESS WRITTEN CONSENT OF SEI. NO LIABILITY OR RESPONSIBILITY OR WARRANTY FOR THE USE OF THIS DOCUMENT OR THE DESIGN, CONCEPTS AND INSTRUMENTATION CONCEPTS HEREIN FOR ANY OTHER PROJECT, OR IN A MANNER THAT DOES NOT RELATE TO THE SPECIFICALLY INTENDED USE OF THIS DOCUMENT, IS AND SHALL BE THE SOLE RESPONSIBILITY OF THE USER. THE DESIGN AND INSTRUMENTATION CONCEPTS HEREIN BE USED IN ANY MANNER DETRIMENTAL TO THE INTEREST OF SEI, THE USER OR SUBMITTERS OF SEI AND ITS AFFILIATES ARE FURTHER LIMITED BY THE AGREEMENT BETWEEN THEM FOR THIS PROJECT. ALL PATENT AND OTHER RIGHTS ARE RESERVED. ACCEPTANCE OF THE DELIVERY OF THIS DOCUMENT CONSTITUTES AGREEMENT TO THESE TERMS AND CONDITIONS.

Figure 5-14. Photograph of Injection Well Connections



Figure 5-15. Photograph of PLC Cabinet

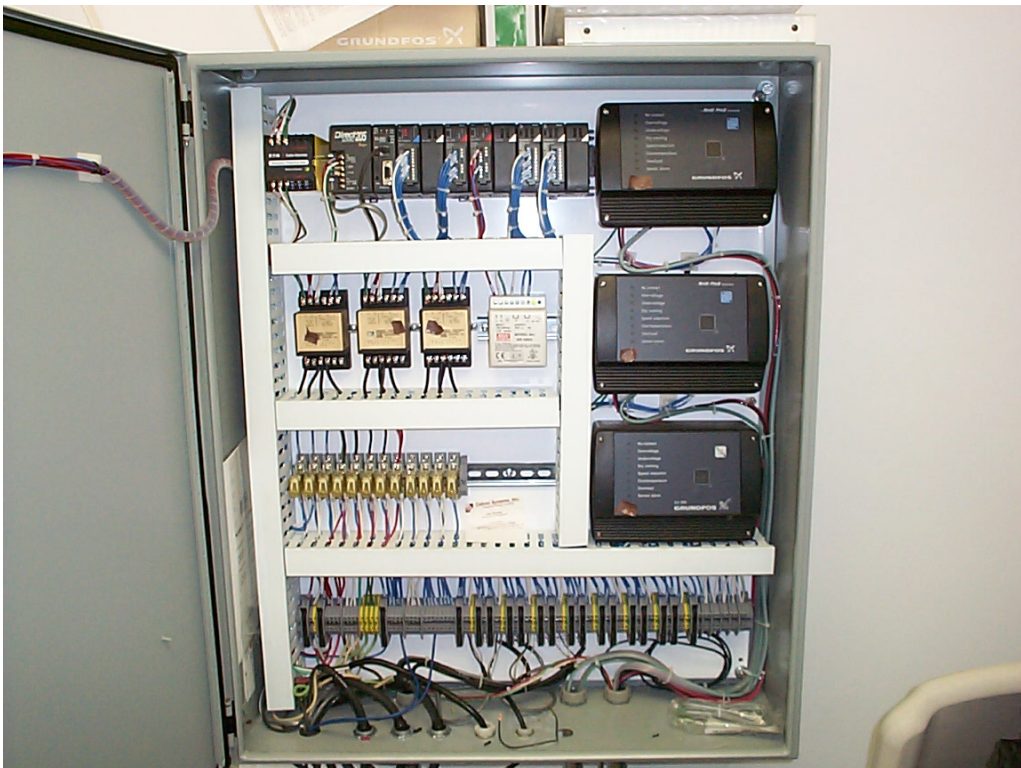
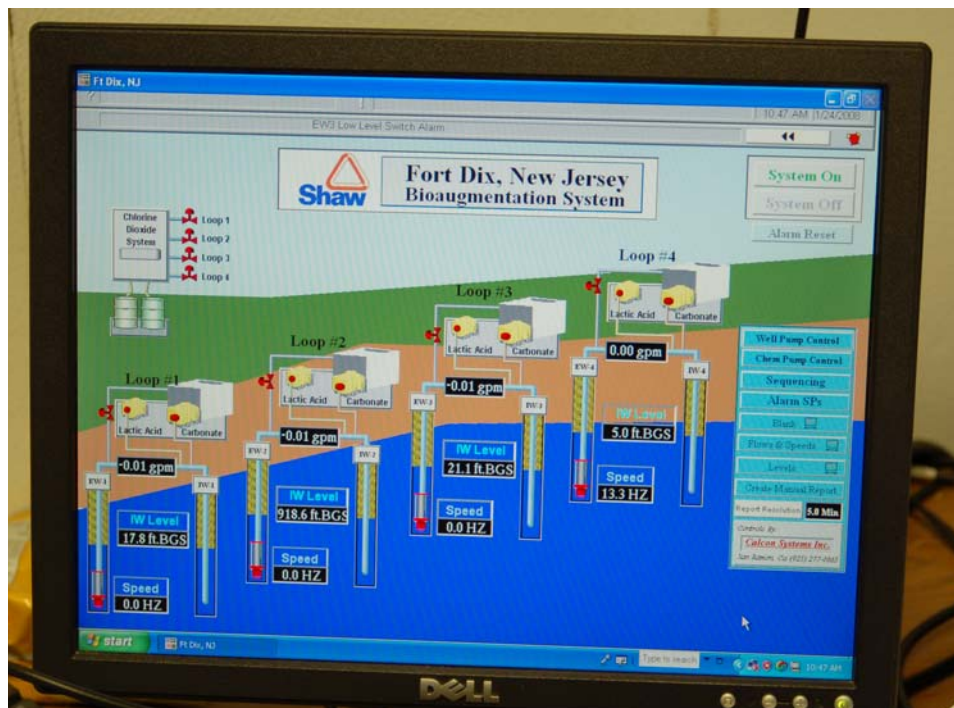

Figure 5-16. Photograph of SCADA System Main Screen



5.4.3.4 Construction of Electron Donor and Buffer Injection Systems

Amendment metering pumps for delivery of the electron donor (sodium lactate) and buffer (sodium bicarbonate and/or sodium carbonate) solutions were installed within the 40-foot Conex box (**Figure 5-17**). A 220-gallon poly tank containing a 50:50 mix of 60% liquid sodium lactate solution and de-ionized water was located along the wall, near the front of the Conex box. Yeast extract was sometimes added to this mix to further enhance biological activity. Eight 220-gallon poly tanks containing Site groundwater, buffer, and nutrients (diammonium phosphate) were located along one side of the Conex box (**Figure 5-18**). Individual feed lines were run from the tanks to the corresponding metering pump and from the metering pump through a pass through between the two Conex boxes to two injection racks installed within the 20-foot Conex box. The injection racks (**Figure 5-19**) contained filter housings, flow meters, pressure gauges, and injection ports for the amendments. All selected piping, tubing, and associated materials were designed to be compatible with the liquid amendments.

Electron donor and buffer metering pump operations (i.e. dosing duration and frequency) were set and monitored via the SCADA system. Batches of electron donor and buffer solution were mixed manually, as needed. The injection rate of the electron donor and buffer solutions were set manually using adjustments on the metering pump. The daily volume of amendments could be controlled by either manually adjusting the feed rate of the metering pump, or by changing the dosing duration and frequency via the SCADA system. Therefore, the system provided excellent flexibility with respect to dosage concentrations and frequencies. Lactate and buffer were added continuously during active groundwater recirculation periods. Injection schedules, concentrations and volumes are discussed in detail in **Sections 5.5.2** and **5.5.3**.

Figure 5-17. Photograph of Lactate Metering Pumps



Figure 5-18. Photograph of Buffer Tanks in 40-foot Conex Box



Figure 5-19. Photograph of Amendment Injection Rack



5.4.4 Biofouling Mitigation Approach

Microbial biofouling is a significant concern with any *in situ* bioremediation system, and particularly with those requiring active pumping. Various chemical and operational approaches have been tested (or are currently being tested) to mitigate biofouling, including “oxidizing” amendments (e.g., chlorine dioxide, sodium hypochlorite, and hydrogen peroxide), acid treatment, enzyme addition, liquid carbon dioxide, intermittent pumping strategies, and other techniques. At present, there does not appear to be a simple solution for this problem.

Biofouling was not observed during the column experiments (**Section 5.3.3**). Additionally, the primary goals of the field demonstration were to evaluate the amount of culture needed to effectively remediate a CVOC-contaminated plume, and to determine the effect of inoculum dose on remedial time. Injecting an anti-biofouling agent on a regular basis could potentially impact the results of the demonstration by killing some of the injected SDC-9 culture. Therefore, biofouling mitigation was limited to redevelopment of the injection wells during the demonstration.

Well redevelopment was accomplished by adding an acid and conditioner (NuWell 120 and 310) to the wells, surging the wells with a surge block, and allowing the acid to remain in the well

overnight. The well was then surged and pumped with a submersible pump multiple times until well performance improved and the pH of the extracted water measured higher than approximately 4.5 standard units (baseline pH value). This method was intended to limit the impacts of well-fouling treatment on injected culture, by limiting treatment to the injection well screen, sandpack, and immediate surrounding formation.

5.5 FIELD TESTING

Field Testing began in November 2007, and lasted for approximately 14 months. Testing was performed in three operational phases; 1) system testing, 2) System start-up and tracer testing, and 3) bioaugmentation, systems operation and performance monitoring.

5.5.1 System Testing

The recirculation system was successfully tested between November 8 through November 14, 2007 to insure proper operation of pumps and controls. During this process, various operating and alarm conditions were simulated, and all equipment and sensors were checked for proper calibration. The communication between the PLC and the various pieces of equipment and sensors was monitored to insure all data was being communicated and logged accurately. Additionally, brief testing of the electron donor and buffer injection systems was performed using potable water to check for leaks and allow for selection of proper flow rates and pressures. Water levels were measured manually in demonstration area monitoring wells and extraction wells, and automatically at the injection wells by the SCADA system during this period to determine the impacts of groundwater extraction and injection on local water table elevations.

5.5.2 System Start-up and Tracer Testing

Operation of the four recirculation loops began on November 15, 2007. Groundwater was pumped from each of the four extraction wells at a rate of approximately 0.5 gpm, and re-injected into the corresponding injection wells at the same rate. Operation of the amendment injection systems began on November 16, 2007, after a full day of successful groundwater recirculation. Groundwater extraction rates for each extraction well were reduced from 0.5 gpm to 0.4 gpm on January 3, 2008, and to 0.3 gpm on January 15, 2008, to minimize injection pressures at the injection wells.

The system Start-up period lasted for 10 weeks, leading up to the addition of the SDC-9 bioaugmentation culture on January 24, 2008. During this period, lactate, buffer (sodium bicarbonate or sodium carbonate), and nutrients (diammonium phosphate and yeast extract) were injected into each of the four injection wells in equal amounts, using the amendment delivery systems described in **Section 5.4.3.4**. Addition of these amendments created biogeochemical conditions within the aquifer that were favorable to bioaugmentation with the SDC-9 culture. The groundwater recirculation and amendment delivery systems operated nearly continuously (except for brief O&M shutdown periods) during the Start-up period. All four injection wells were redeveloped between December 20 and December 26, 2007 using the methods described in **Section 5.4.4**.

5.5.2.1 Amendment Addition

Electron donor and buffer metering pump operations (i.e. dosing duration and frequency) were set and monitored via the SCADA system. Batches of electron donor, nutrients, and buffer solution were mixed manually, as needed. Liquid sodium lactate (60% by weight) was mixed with an equal volume of de-ionized water in a 220-gallon poly tank. During the start-up period, lactate solution was metered into each of the injection wells (operating at approximately 0.5 gpm) at 2.5 ml/minute, thereby attaining a final sodium lactate injection concentration of approximately 480 mg/L (weighted average of 1.2 kg/day per loop).

Buffer solution was prepared in 220-gallon poly tanks (2 tanks dedicated to each of the 4 loops) using groundwater and sodium bicarbonate or sodium carbonate powder. The solution was metered into each of the injection wells between 0.75 gallons per hour (gph) and 1.82 gph, thereby attaining a final buffer injection concentration of between approximately 1,700 mg/L and 4,300 mg/L (weighted average of 6.82 kg/day per loop). Sodium bicarbonate buffer was used from Start-up (November 16, 2007) until December 11, 2007, at which time the buffer used was changed to sodium carbonate (a stronger buffer) to more effectively increase pH within the aquifer. Additionally, diammonium phosphate (nutrients) was mixed into the buffer solution tanks, attaining a final injection concentration of approximately 20 mg/L (weighted average of 49 g/day per loop).

The injection rate of the electron donor and buffer/nutrient solutions were set manually using adjustments on the metering pump. Lactate, buffer, and nutrients were added continuously during active groundwater recirculation periods. The groundwater recirculation and amendment delivery systems generally ran at these settings during the first 9 weeks of operation (i.e. system start-up). Additionally, bulk injections of sodium carbonate were performed on December 27, 2007 (100 lbs per well) and January 15, 2008 (150 lbs. per well) at each of the four injection wells. Sodium carbonate powder was mixed in drums with groundwater extracted from each of the injections wells, then re-injected into the wells. These bulk injections were performed to further elevate groundwater pH values that still largely remained below 5.5 standard units after several weeks of system operation.

A total of approximately 416 L (110 gallons) of 60% sodium lactate solution (containing 330 kg lactate), 680 kg (1,500 lbs.) of sodium bicarbonate, 1,680 kg (3,700 lbs.) of sodium carbonate (including the bulk injections), and 13.6 kg (30 lbs.) of diammonium phosphate were injected in equal amounts into the four Loops during the 10-week Start-up period.

5.5.2.2 Tracer Testing

A tracer test was performed during the start-up period to evaluate/verify local hydrogeologic characteristics, including hydraulic conductivity, heterogeneity, vertical component of groundwater flow, and dispersivity. Injection of conservative tracers bromide (in the form of sodium bromide) and fluoride (in the form of sodium fluoride) were performed at the injection wells during the first four weeks of the start-up period. Sodium bromide was used in recirculation loops 1 and 3, and sodium fluoride was used in loops 2 and 4. By using alternating

tracers among the loops, the potential for any cross-flow between well pairs was evaluated. Tracer injection occurred relatively continuously for a 28-day period.

One-hundred pounds (45.5 kg) each of sodium bromide and sodium fluoride (crystalline form) was mixed into the buffer tanks (located within the 40-foot Conex box) with Site groundwater. A total of 510 gallons of solution (three 170-gallon batches), with an average bromide concentration of approximately 9,100 mg/L was prepared in the buffer tanks for Loops 1 and 3, and a total of 510 gallons of solution (three 170-gallon batches), with an average fluoride concentration of approximately 5,300 mg/L was prepared in the buffer tanks for Loops 2 and 4. Tracer injections began on November 16, 2006, and were completed on December 14, 2007. The buffer metering pumps were used to inject the tracer solution continuously into the injection wells during active groundwater recirculation periods. The bromide and fluoride solutions were metered into the injection wells at approximately 0.75 gallons per hour (gph) (2.84 Liters per hour) at average injection concentrations of approximately 225 mg/L (bromide) and 130 mg/L (fluoride), respectively.

During the system start-up and tracer testing phase, six groundwater sampling events were performed at select monitoring locations within the demonstration area to monitor migration of tracers and lactate, determine the appropriate changes in aquifer geochemical conditions (i.e., increases in pH, decreases in dissolved oxygen and other electron acceptors, decreases in oxidation-reduction potential (ORP)), to evaluate changes in dissolved chlorinated ethene concentrations due to system mixing, and to determine baseline conditions prior to bioaugmentation. **Table 5-1 and Figure 5-1** summarize the groundwater sampling schedule, and **Table 5-7** lists the wells that were sampled and the analyses that were performed during this phase of the demonstration.

5.5.3 Bioaugmentation, Systems Operation, and Performance Monitoring

Two bioaugmentation events, continued operation of the groundwater recirculation and amendment delivery systems, and twelve rounds of performance monitoring were performed during this phase of the demonstration. These activities are summarized in the following subsections.

5.5.3.1 Bioaugmentation

The first of two bioaugmentation injection events was conducted on January 24, 2008. The SDC-9 culture used for the bioaugmentation was grown at Shaw's fermentation facility in Lawrenceville, New Jersey immediately prior to injection. The DHC concentration in the injected culture was measured at 2.17×10^{10} cells/liter via qPCR analysis at Shaw's analytical laboratory in Lawrenceville, New Jersey.

Immediately prior to the bioaugmentation injections, approximately 50 gallons of groundwater was pumped from injection wells IW-1 through IW-3 into individual 55-gallon drums. The culture was delivered to the Site under nitrogen pressure in three individual soda kegs. The bioaugmentation injections were performed through Tygon tubing that was lowered into the water column within each well, to the approximate middle of the screened interval. The tubing

was connected to a valve on the outlet port of each soda keg containing the bacteria. A nitrogen cylinder was connected to the inlet port of the soda keg. The soda keg was pressurized to approximately 10 psi using the nitrogen, and the outlet valve was opened allowing the culture to be injected into each well. This injection method limited exposure of the SDC-9 culture to oxygen.

A total of 100 liters, 10 liters, and 1 liter of culture were injected into injection wells IW-1, IW-2 and IW-3, respectively. Bioaugmentation was not performed at injection well IW-4, as this well was part of the control loop. Each bioaugmentation injection took approximately 20 minutes to perform. Once the injection of the culture was complete, the 50 gallons of groundwater extracted from each of the injection wells was pumped back into the respective wells to further distribute the culture within the surrounding formation.

It is believed that high pH levels (>10 standard units) measured in injection wells IW-1 through IW-3 shortly after the first bioaugmentation injection may have adversely affected the injected SDC-9 culture, as no substantial dechlorination or downgradient migration of DHC were observed over a 12-week period (see **Section 5.7.4**). Therefore, a second bioaugmentation event was conducted on May 1, 2008. Unlike the first injection, the culture was injected into the first downgradient monitoring well within Loops 1 through 3, to prevent high pH levels in the injection wells from impacting the injected culture. A total of 100 liters, 10 liters, and 1 liter were injected into injection wells BMW-1, BMW-3 and BMW-5, respectively. Injection procedures were as described above, with the exception of lactate (16,000 mg/L), diammonium phosphate (1,000 mg/L) and yeast extract (1,000 mg/L) being added to the 50 gallons of chase water. The DHC concentration in the injected culture was measured at 1.45×10^{12} cells/liter (approximately 2 orders of magnitude higher than the first injected culture) via qPCR analysis at Shaw's Laboratory in Lawrenceville, New Jersey.

5.5.3.2 System Operation

After the first bioaugmentation injection on January 24, 2008, the groundwater recirculation and amendment delivery systems were operated continuously until March 3, 2008 (39 days). Groundwater extraction rates for each extraction well were reduced from 0.3 gpm to 0.25 gpm on February 7, 2008.

Between March 3, 2008 and November 5, 2008, the systems were operated in an "Active-Passive" mode. During "Active" cycles, groundwater was continuously recirculated, and lactate, buffer, and nutrients (i.e., diammonium phosphate and yeast extract) were continuously injected into the aquifer. During "Passive" cycles, the systems were not operated, and the injected amendments were allowed to move naturally with the groundwater. Each individual Active and Passive period lasted generally 1-2 weeks. The systems were operated in Active mode approximately 50 percent of the time during this 8-month period. This approach provided mixing of electron donor and nutrients within the designed treatment areas, and allowed natural groundwater flow to further distribute the amendments downgradient.

The amendment delivery system normally operated while groundwater was being re-circulated, with the exception of the last 25 days of operation (October 10, 2008 to November 5, 2008),

when amendment delivery was halted. Groundwater extraction rates for each extraction well were reduced from 0.25 gpm to 0.15 gpm on June 3, 2008, and to 0.1 gpm on July 3, 2008, to minimize injection pressures at the injection wells. Additionally, Loop 1 groundwater recirculation and amendment addition was ceased on October 1, 2008 (approximately 1 month before Loops 2 through 4) due to excessive groundwater mounding in the vicinity of injection well IW-1.

Electron donor and buffer metering pump operations (i.e. dosing duration and frequency) were set and monitored via the SCADA system. Batches of electron donor and buffer solution were mixed manually, as needed. Liquid sodium lactate (60% by weight) was mixed with an equal volume of de-ionized water in a 220-gallon poly tank. The lactate solution was metered into each of the injection wells between 2.5 ml/min and 5.0 ml/minute, thereby attaining a final sodium lactate injection concentration of between approximately 1,000 mg/L and 4,500 mg/L during system operational periods (weighted average of 1.46 kg/day per loop). Yeast extract (nutrients) was also mixed into the lactate solution tank, attaining a final injection concentration of approximately 110 mg/L (weighted average of 66.7 g/day per loop).

Buffer solution was prepared in 220-gallon poly tanks (2 tanks dedicated to each of the 4 loops) using groundwater and sodium bicarbonate and/or sodium carbonate powder. The solution was metered into each of the injection wells between 0.25 gallons per hour (gph) and 1.85 gph, thereby attaining a final buffer injection concentration of between approximately 1,500 mg/L and 12,000 mg/L (weighted average of 5.08 kg/day per loop). Sodium carbonate buffer was used from January 24, 2008 until May 30, 2008, at which time the buffer was changed to sodium bicarbonate (a weaker buffer) to maintain the desired pH within the aquifer. The buffer was switched back to sodium carbonate on July 15, 2008 (and continued until the end of the demonstration) when it was observed that pH levels were dropping within the aquifer. Additionally, diammonium phosphate (nutrients) was mixed into the buffer solution tanks, attaining a final injection concentration of approximately 160 mg/L (weighted average of 98 g/day per loop).

A total of approximately 1875 L (495 gallons) of 60% sodium lactate solution (containing 1,485 kg lactate), 2,500 kg (5,500 lbs.) of sodium bicarbonate, 2,680 kg (5,900 lbs.) of sodium carbonate (including the bulk injections), 100 kg (220 lbs.) of diammonium phosphate, and 68 kg (150 lbs.) of yeast extract were injected into the four Loops during the 9 ½-month operational period (January 24 through November 5, 2008).

The SCADA system allowed for remote monitoring and adjustments of groundwater extraction and injection rates, as well as electron donor injection frequency and duration. System operating parameters were adjusted as necessary to optimize performance. Additionally, Shaw personnel performed regular site checks and maintenance of the groundwater recirculation and amendment delivery systems during this phase of the demonstration. Site checks included measurements of system pressures (manual gauges), water levels, extraction and injection flow rates and totals, mixing of amendment solutions, as well as leak checks and filter changes. The mixing of amendment solutions was the most time-intensive O&M component.

The general approach for biofouling control was discussed in **Section 5.4.4**. Water levels in the extraction wells and water levels and/or injection pressures in the injection wells were monitored for signs of fouling. As discussed in **Section 5.5.2**, all four injection wells were redeveloped in December 2007, during the Start-up phase. All four injection wells were redeveloped again between June 25 and June 29, 2008, using the methods described in **Section 5.4.4**. Well fouling appeared to be occurring from an accumulation of carbonate and insoluble complexes (most likely iron sulfides and iron carbonates, as discussed in **Section 5.7.4**) within the well screen, sandpack and the immediate surrounding formation. This biofouling mitigation approach (i.e. well redevelopment) was chosen because injection of an anti-biofouling agent on a regular basis could have potentially impacted the results of the demonstration by killing some of the injected SDC-9 culture.

5.5.3.3 Performance Monitoring

During this Period of Operation, extensive groundwater monitoring was performed to evaluate changes in biogeochemical conditions, chlorinated ethene concentrations, electron donor concentrations and consumption rates, and microbial growth and distribution (via qPCR analysis). A total of twelve performance monitoring groundwater sampling events were conducted in the demonstration area between January 30, 2008 and January 5, 2009 to monitor treatment performance. A schedule summarizing performance monitoring sampling events is provided in **Table 5-1** and **Figure 5-1**. The first five sampling events were performed between the first and second bioaugmentation events. The next five sampling events were performed after the second bioaugmentation event, and while the groundwater recirculation system was operating. The final two sampling events were performed after the groundwater recirculation system had been shut down.

Sampling was performed by Shaw personnel, in accordance with the procedures described in the Demonstration Plan (Shaw, 2007). Groundwater samples were collected utilizing low-flow purging in accordance with NJDEP Low Flow Purging and Sampling Guidance, with the exception of purge times being limited to 60 minutes at each. Samples were obtained using a dedicated submersible bladder pump and Teflon tubing. A YSI field meter with a flow-through cell was used to collect measurement of field geochemical parameters (pH, ORP, temperature, specific conductivity, and dissolved oxygen). Groundwater samples were submitted to the Shaw Environmental Analytical Laboratory in Lawrenceville, New Jersey.

Analyses of groundwater collected during the performance monitoring sampling events included VOCs, reduced gases, VFAs, anions (including nitrate and sulfate), dissolved iron and manganese, and DHC (via qPCR analysis) (**Table 5-7**). With the exception of dissolved iron and manganese, all analyses were performed by the Shaw's New Jersey Certified Analytical Laboratory in Lawrenceville, NJ. Dissolved iron and manganese analyses were performed by Accutest Laboratories, Dayton, NJ, under subcontract to Shaw.

Groundwater elevation measurements were also collected during this phase of the demonstration to evaluate changes in hydraulic gradients induced by operation of the injection/extraction well system in the Demonstration Area.

5.5.4 Demobilization

At the completion of this study all groundwater recirculation and amendment injection equipment was disconnected and removed from the MAG-1 Area. These efforts included disconnecting the power line, removing and cleaning all pumps and other down hole components within the injection and extraction wells, and disconnecting and removing all piping connections between the injection and extraction wells and the recirculation system. The 20-foot Conex box (and associated equipment) was shipped to a Shaw storage facility. The 40-foot Conex box was left in the MAG-1 Area for future use during full scale remedial activities. All drums and poly tanks were cleaned (using a power-washer), cut up, and placed in a dumpster for disposal. The injection, extraction, and monitoring wells installed for this study have become the property and responsibility of Fort Dix for use in future monitoring, demonstration, or remedial efforts.

5.6 SAMPLING METHODS

The Quality Assurance Project Plan (QAPP) that was followed during the demonstration is provided in **Appendix H**. The QAPP provides details on calibration of analytical and field equipment, quality assurance (QA) sampling, decontamination procedures, and sample documentation, as well as other QA/QC procedures adhered to during the demonstration. The procedures in the QAPP were followed during site characterization activities (direct-push soil and groundwater sampling) as well as during all demonstration groundwater sampling events.

Site Characterization Sampling

As discussed in **Section 5.2.1**, a direct-push (Geoprobe®) investigation was conducted in the MAG-1 Area between January 8 and January 12, 2007. During the investigation, soil samples were collected from the six locations (GP-1 through GP-6) shown on **Figure 5-2**. Continuous soil core samples for lithologic evaluation were collected from each boring to a depth of 35 to 40 feet bgs (~70-75 feet MSL). Soil cores were screened for VOCs using a photo-ionization detector (PID); one soil sample from each boring location, correlating to the depth interval where the highest PID readings were recorded below the water table, was collected using the NJDEP approved “closed-system vials, no chemical preservation” method (NJDEP, 2005). This is a preferred method of preservation by USEPA CLP SOW (NJDEP 2005). The samples were analyzed for VOCs via EPA Method 8260. Soil analyses were performed by Shaw’s New Jersey certified laboratory in Lawrenceville, New Jersey.

Groundwater samples were also collected from six locations, located immediately adjacent (within 3 feet) to the six soil sampling locations described above (**Figure 5-2**). Samples were collected using an NJDEP approved direct-push method (NJDEP 2005). Four to five discrete groundwater samples were collected at each of the locations, using a Geoprobe® stainless steel Screen Point sampler. Dedicated tubing was lowered into the sampler through the direct-push rods, and a peristaltic pump was used to pump water from the sampler. Samples were collected once the purged groundwater was relatively free of sediment. Sample intervals were based on observed lithology and PID readings. A total of 26 aqueous samples (including one equipment

blank) were collected and analyzed for VOCs at Shaw's Lawrenceville, New Jersey laboratory. Two trip blanks were also analyzed for VOCs.

Demonstration Groundwater Sampling

All groundwater sampling during the demonstration was performed by Shaw personnel, in accordance with the procedures described in the Demonstration Plan (Shaw, 2007). Groundwater samples were collected utilizing low-flow purging in accordance with NJDEP Low Flow Purging and Sampling Guidance, with the exception of purge times being limited to 60 minutes at each. Samples were obtained using a dedicated submersible bladder pump and Teflon tubing. A YSI field meter with a flow-through cell was used to collect measurement of field geochemical parameters (pH, ORP, temperature, specific conductivity, and dissolved oxygen). Groundwater samples were submitted to the Shaw Environmental Analytical Laboratory in Lawrenceville, New Jersey.

Analyses of groundwater collected during sampling events included VOCs, reduced gases, VFAs, anions, dissolved iron and manganese, and DHC (via qPCR analysis). **Table 5-1** summarizes the groundwater sampling schedule, and **Table 5-7** lists the wells that were sampled and the analyses that were performed during the demonstration. Analytical methods and sample quantities are summarized in **Tables 5-12** and **5-13**, respectively. With the exception of dissolved iron and manganese, all analyses were performed by the Shaw's New Jersey Certified Analytical Laboratory in Lawrenceville, NJ. Dissolved iron and manganese analyses were performed by ChemTech Laboratories, Mountainside, NJ, and Accutest Laboratories, Dayton, NJ, under subcontract to Shaw.

Table 5-12
Analytical Methods for Sample Analysis

Parameter	Method/Procedure	Preservative	Bottle Size/Type
VOCs	EPA 8260	Hydrochloric Acid, 4°C	40 mL VOA /glass
Anions	EPA 300.0	4°C	100 mL/plastic
Volatile Fatty Acids (VFAs)	EPA 300 m	4°C	40 mL VOA/glass
Reduced gases	EPA 3810/RSK-175	Hydrochloric Acid, 4°C	40 mL VOA/glass
qPCR	--	4°C	100 mL/glass
Dissolved Iron and Manganese	EPA 200.7	Nitric Acid	250 mL/plastic
Redox Potential	Field Meter	--	--
Dissolved Oxygen	Field Meter	--	--
pH	Field Meter	--	--
Conductivity	Field Meter	--	--

Table 5-13
Summary of Groundwater Sample Quantities

Sampling Event	VOCs			MEEs		Anions		VFAs		DHC		Dissolved Iron & Manganese	
	Primary	Duplicate	Trip Blank	Primary	Duplicate	Primary	Duplicate	Primary	Duplicate	Primary	Duplicate	Primary	Duplicate
Baseline #1	18	1	2	18	1	18	1	18	1	18	1	18	1
Baseline #2	19	1	2	19	1	19	1	19	1	4		4	1
Tracer #1						12	1						
Tracer #2						18	1	18	1				
Tracer #3	18	1	1	18	1	18	1	18	1	18	1	18	1
Tracer #4						19	1	19	1				
Tracer #5						19	1	19	1				
Tracer #6						15	1	15	1				
Pre-Bioaugmentation	19	1	1	19	1	19	1	19	1	19	1	19	1
Performance #1	12	1	1	12	1	12	1	12	1	16	1	16	
Performance #2	12	1	1	12	1	12	1	12	1	16	1	16	
Performance #3	9	1	1	9	1	9	1	9	1	9	1	9	
Performance #4	9	1	1	9	1	9	1	9	1	9	1	9	
Performance #5	10	1	1	10	1	10	1	10	1	10	1	10	
Performance #6	13	1	1	13	1	13	1	13	1	13	1	13	
Performance #7	15	1	1	15	1	15	1	15	1	15	1	15	
Performance #8	15	1	1	15	1	15	1	15	1	15	1	15	
Performance #9	15	1	1	15	1	15	1	15	1	15	1	15	
Performance #10	15	1	1	15	1	15	1	15	1	15	1	15	
Performance #11	23	2	1	23	2	23	2	23	2	19	2	23	2
Performance #12	15	1	1	15	1	15	1	15	1	15	1	15	
Subtotals	237	17	18	237	17	320	22	308	21	226	16	82	6
Totals	272			254		342		329		242		88	

5.7 SAMPLING RESULTS

A total of 21 groundwater sampling events were conducted during the demonstration, including:

- Two baseline sampling events
- Six System Start-Up and Tracer Testing groundwater sampling events
- One pre-bioaugmentation sampling event, and
- Twelve performance monitoring sampling events

Baseline groundwater data were compared to data collected during the Start-Up/Tracer Testing phase, and the Performance Monitoring (System Operation) phase.

5.7.1 Water Level Measurements

Water level measurements were collected manually at monitoring wells and remotely by pressure transducers (in the 4 injection wells) throughout the demonstration. Baseline measurements were collected and compared to measurements collected during the Start-Up phase and the System Operation and Performance Monitoring phases.

Baseline groundwater elevation measurements were collected from all monitoring and extraction wells within the demonstration area on November 7, 2007, prior to collecting Baseline groundwater samples. These data (summarized in **Table 5-11**) were used to establish baseline water table elevations, and hydraulic gradient and estimated groundwater flow directions within the Demonstration Area. A Baseline potentiometric surface contour map for the Shallow Alluvium aquifer is presented in **Figure 5-8**. Based on the baseline data, groundwater flow direction is to the southwest and the hydraulic gradient across the demonstration area is approximately 0.012 for the Kirkwood aquifer. Using the hydraulic conductivity data derived from the pump test, and assuming an effective porosity of 25 percent, the groundwater velocity within the Kirkwood formation is approximately 0.08 ft/day. Water level measurements at monitoring wells MAG-112P and MAG-113P indicated that there was no measureable vertical gradient between the Kirkwood and Manasquan aquifers (at this location) under baseline conditions.

Manual groundwater elevation measurements were collected during system start-up and tracer testing sampling events to evaluate hydraulic gradients induced by operation of the injection/extraction well system in the Demonstration Area. Water level data for the injection wells were collected by pressure transducers installed in these wells. The data were recorded and logged by the SCADA system, and could be viewed instantaneously (either on site or remotely), or downloaded to generate reports or trend graphs. Groundwater elevation data were collected on November 20, 2007, when groundwater was being extracted at 0.5 gpm at each of the 4 extraction wells. A potentiometric surface contour map for the Kirkwood aquifer, based on data collected during active groundwater recirculation is presented in **Figure 5-20**. Cones of depression are observed at extraction wells EX-1, EX-2 and EX-4, with maximum drawdown occurring at EX-4. Minor mounding was observed at Injection wells IW-1 and IW-4. As with the baseline data, groundwater flow direction is to the southwest. The hydraulic

OFFICE: Pittsburgh, PA
 DATE: 3/12/09
 DESIGNED BY: D. Lippincott
 DRAWN BY: B. Snyder
 CHECKED BY: C. Schaefer
 APPROVED BY: R. Steffan
 DRAWING NUMBER: 115869-B14

File: O:\Project\AFCEE\Fort Dix\115869B14.dwg
 Plot Date/Time: Jul 23, 2009 - 2:23pm
 Plotted By: william.snyder

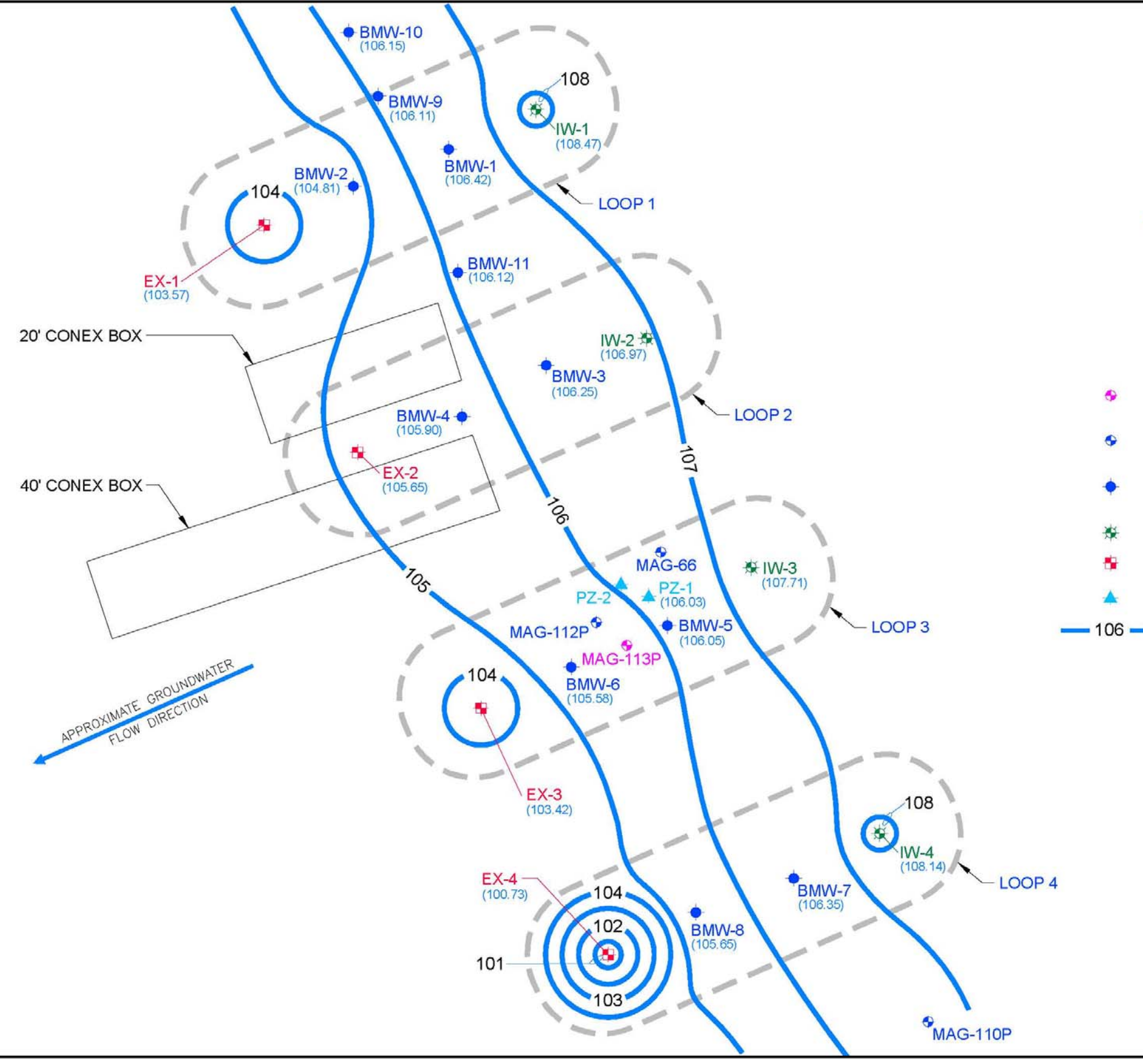

- LEGEND:
- MONITORING WELL (KIRKWOOD FORMATION)
 - MONITORING WELL (MANASQUAN FORMATION)
 - DEMONSTRATION MONITORING WELL (KIRKWOOD FORMATION)
 - INJECTION WELL
 - EXTRACTION WELL
 - PIEZOMETER
 - 106 POTENTIOMETRIC SURFACE CONTOUR (FEET MSL)



Shaw Shaw Environmental, Inc.

ESTCP FIELD DEMONSTRATION
 BIOAUGMENTATION FOR
 GROUNDWATER REMEDIATION

FIGURE 5-20
 POTENTIOMETRIC SURFACE CONTOURS
 FOR THE KIRKWOOD AQUIFER
 OPERATIONAL CONDITIONS - NOV. 20, 2007
 MAG-1 AREA
 FORT DIX, NEW JERSEY

gradient increased approximately ten-fold to 0.10 in the middle of the test plots (between performance monitoring wells), and was significantly greater still in the vicinity of the injection and extraction wells. Based on this data, the groundwater velocity between performance monitoring wells was 0.65 ft/day. As with the Baseline measurements, no measureable vertical gradient was observed (wells MAG-112P and MAG-113P) during the operation of the recirculation system.

As the groundwater recirculation and amendment delivery systems continued to operate, increased mounding and injection pressures were observed at the injection wells. As discussed in **Sections 5.5.2** and **5.5.3**, recirculation rates were gradually lowered from 0.5 gpm to 0.1 gpm over the course of the 12-month operating period to help mitigate this problem. Reduction of pumping rates reduced gradients in the middle of the test plots to approximately 0.02 (a five-fold decrease). At a pumping rate of 0.1 gpm per extraction well, the hydraulic gradient was approximately double that measured during Baseline sampling.

5.7.2 Tracer Testing

A tracer test was performed during the start-up period to evaluate/verify local hydrogeologic characteristics, including hydraulic conductivity, heterogeneity, vertical component of groundwater flow, and dispersivity. Injection of conservative tracers bromide (in the form of sodium bromide) and fluoride (in the form of sodium fluoride) were performed at the injection wells during the first four weeks of the start-up period. Sodium bromide was used in recirculation loops 1 and 3, and sodium fluoride was used in loops 2 and 4. By using alternating tracer among the loops, the potential for any cross-flow between well pairs was evaluated. Tracer injection occurred relatively continuously for a 28-day period between November 16, 2006 and December 14, 2007. Details of tracer and amendment solution mixing and injection (including concentrations) are discussed in **Section 5.5.2**.

Six Tracer sampling events were performed at select monitoring locations within the demonstration area to monitor migration and distribution of tracers. Analyses of groundwater collected during each of these sampling events included anions (including bromide and fluoride). **Table 5-1** and **Figure 5-1** summarize the groundwater sampling schedule, and **Table 5-7** lists the wells that were sampled and the analyses that were performed during this phase of the demonstration. Laboratory analytical results are summarized in **Table 5-8**. Lactate, buffer and nutrients were also injected continuously during this period. Results related to the injection of these amendments during the Start-up period are discussed in **Section 5.7.3**.

Sampling results indicated that the bromide tracer was distributed through Loops 1 and 3 quickly, with detectable concentrations of bromide observed at extraction wells EX-1 (Loop 1) and EX-3 (Loop 3) within 10 and 18 days, respectively. **Figure 5-21** shows the horizontal bromide distribution within the Kirkwood aquifer during the final tracer sampling event (January 3, 2008). Bromide concentrations peaked at extraction well EX-1 (66.4 mg/L) within 66 days and EX-3 (38.3 mg/L) within 81 days (**Table 5-8**). Analysis of the pump test data indicated that the estimated travel time of the bromide tracer through Loops 1 and 3 (from the injection to the extraction well) was approximately 30 to 40 days (an average groundwater velocity of 0.75 to 1.0 ft/day). These estimates were based on groundwater extraction/reinjection rates of 0.5 gpm

OFFICE: Pittsburgh, PA
 DATE: 3/15/09
 DESIGNED BY: D. Lippincott
 DRAWN BY: B. Snyder
 CHECKED BY: C. Schoefer
 APPROVED BY: R. Steffan
 DRAWING NUMBER: 115869-B15

File: D:\Project\AFCEE\Fort Dix\115869B15.dwg
 Plot Date/Time: Jul 23, 2009 - 2:25pm
 Plotted By: William Snyder
 Xref: XREF1
 Image: 1041_001.jpg

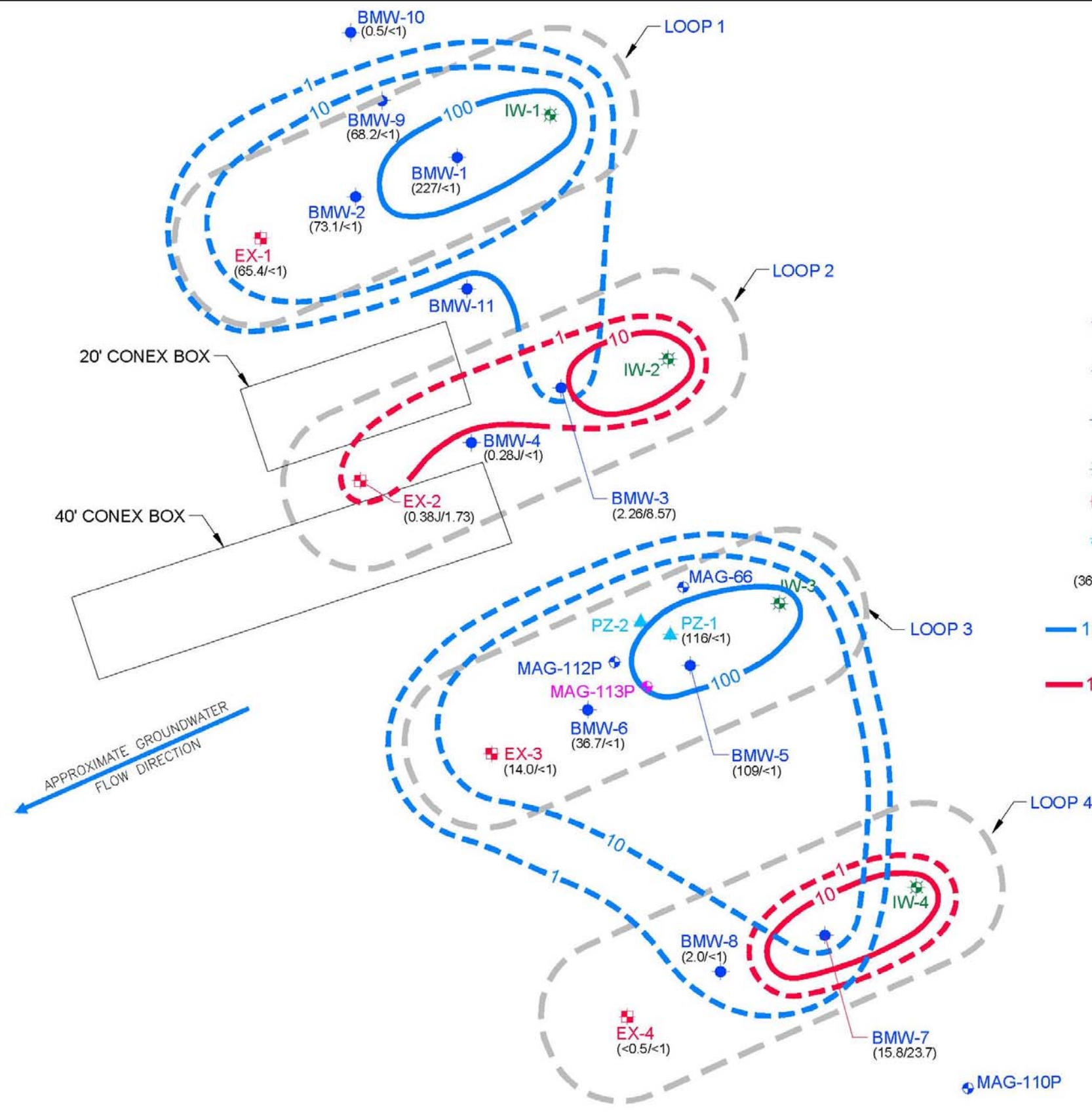

- LEGEND:**
- MONITORING WELL (KIRKWOOD FORMATION)
 - MONITORING WELL (MANASQUAN FORMATION)
 - DEMONSTRATION MONITORING WELL (KIRKWOOD FORMATION)
 - INJECTION WELL
 - EXTRACTION WELL
 - PIEZOMETER
 - (36.7/<1) BROMIDE/FLUORIDE CONCENTRATIONS (mg/L)
 - 100 BROMIDE CONCENTRATION CONTOUR (mg/L). DASHED WHERE INFERRED
 - 10 FLUORIDE CONCENTRATION CONTOUR (mg/L). DASHED WHERE INFERRED

NOTE:
FLUORIDE CONCENTRATIONS BELOW 1.0 mg/L NOT SHOWN.



Shaw Environmental, Inc.
 ESTCP FIELD DEMONSTRATION
 BIOAUGMENTATION FOR
 GROUNDWATER REMEDIATION
FIGURE 5-21
TRACER CONCENTRATIONS
KIRKWOOD AQUIFER
JANUARY 3, 2008
MAG-1 AREA
FORT DIX, NEW JERSEY

per loop. However, as discussed in **Section 5.5.3.2**, groundwater extraction rates were gradually reduced to 0.1 gpm over the course of the demonstration. Therefore, travel times through the loops were significantly increased (most likely to greater than 120 days).

Bromide was observed at wells PZ-2 and MAG-113P at high concentrations (191 mg/L and 167 mg/L, respectively) after only 10 days (note: these wells were not sampled before 10 days). These two wells are screened across the higher permeability Formation Interface, and exhibited higher bromide concentrations than any of the other of the wells sampled during the demonstration (**Table 5-8**). It took an additional 8 days for bromide to be detected in well PZ-1 (at 48.4 mg/L), which is screened in the upper portion of the Kirkwood aquifer (**Figure 5-7**), and is located closer to the injection well (IW-3) than PZ-2 and MAG-113P (**Figure 5-5**).

Figure 5-22 shows the vertical bromide distribution through Loop 3 during the 3rd Tracer sampling event (December 4, 2007). As indicated in the figure, bromide concentrations are several times higher in the two wells screen across the Formation Interface. Even though injection well IW-3 is screened within the Kirkwood aquifer (above the Interface Zone), a portion of the injected bromide migrated into, and preferentially along, the Formation Interface. These data, coupled with data from the Geoprobe investigation, slug tests, and pump test, indicate that the higher permeability Formation Interface provides preferential horizontal flow, and most likely inhibits downward groundwater flow and mixing.

Figure 5-21 shows the horizontal fluoride distribution within the Kirkwood aquifer during the final tracer sampling event (January 3, 2008). As indicated in the figure, the fluoride tracer did not distribute and transport in the same way as the bromide tracer. Although fluoride was considered to be a conservative tracer, results of the fluoride tracer test (when compared to the bromide tracer test and groundwater modeling results) indicated that fluoride was reacting or sorbing to materials within the aquifer. Sorbtion of fluoride to organic matter had been observed during tracer testing in 1985-1986, at a Site in Cape Cod, Massachusetts (Batu, 2005). Therefore, data from the fluoride tracer test could not be used to determine hydrogeologic characteristics (travel times, etc.) within Loops 2 and 4.

As indicated by the bromide concentration contours in **Figure 5-21**, a minor amount of cross flow occurred between Loops 1 and 3 and Loops 3 and 4 during the tracer test. Bromide concentrations observed within Loops 2 and 4 were generally 1 to 2 orders of magnitude below those observed in Loops 1 and 3. As previously discussed, groundwater extraction rates were 0.5 gpm for each of the 4 extraction wells during the tracer testing. These pumping rates were reduced shortly after the tracer test was completed, which was expected to limit the cross flow of injected amendments between loops. Additionally, as discussed below (**Section 5.7.4**), vinyl chloride and ethene were not observed in the control loop (Loop 4) during the demonstration, indicating that the injected DHC did not migrate from Loop 3 into the control loop. Therefore, cross flow between loops did not significantly impact results of the demonstration.

The tracer test results, along with VFA concentration data collected during the Start-up period (discussed in **Section 5.7.3**), indicated that soluble amendments could be quickly delivered throughout the Kirkwood aquifer and the Formation Interface. Based on the overall tracer test results, it was determined that the basic site conceptual model developed by Shaw was

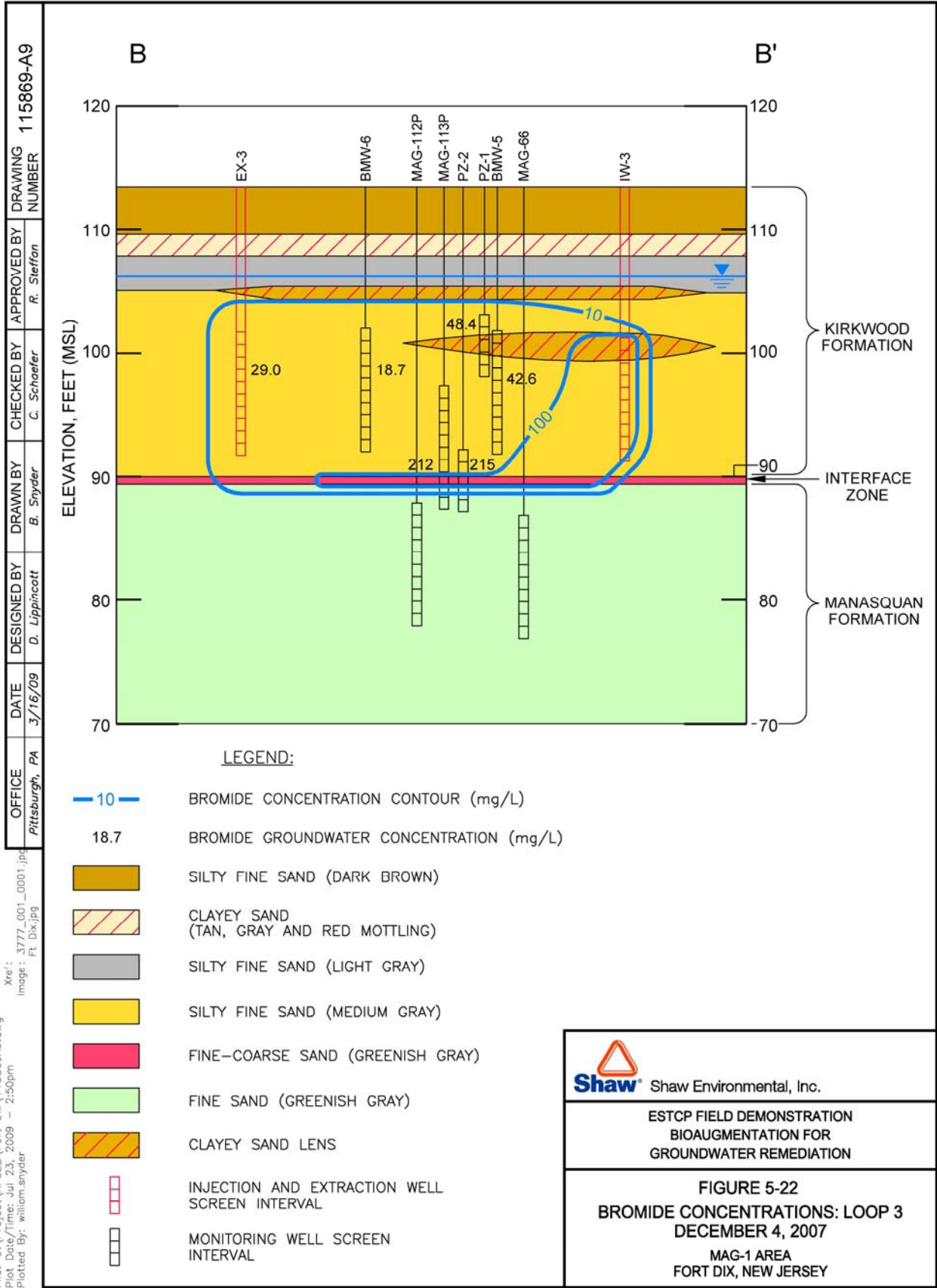

reasonable. Additionally, based on the effective distribution of the tracer and amendments, the groundwater recirculation and amendment delivery systems were operated in an “Active-Passive” mode (as described in **Section 5.5.3.2**), beginning on March 3, 2008 (**Table 5-1**).

5.7.3 System Start-up Sampling

Six Tracer sampling events and one Pre-bioaugmentation sampling event were performed at select monitoring locations within the demonstration area during this phase of the demonstration. In addition to monitoring for the bromide and fluoride tracers (**Section 5.7.2**), these events were conducted to:

1. Monitor migration of lactate and lactate breakdown products,
2. Determine changes in aquifer geochemical conditions (i.e., decreases in dissolved oxygen and other electron acceptors, decreases in ORP, and changes in pH),
3. To evaluate changes in dissolved chlorinated ethene concentrations due to groundwater recirculation,
4. To evaluate potential dechlorination of TCE, and
5. To determine baseline conditions prior to bioaugmentation.

Anion data were collected during all seven of the sampling events, and VFA data were collected during every event except for Tracer sampling event #1. VOC, reduced gases, and DHC data were collected during Tracer sampling event #3 and the Pre-bioaugmentation sampling event, and dissolved iron and manganese data were collected during the Pre-bioaugmentation sampling event. **Table 5-1 and Figure 5-1** summarize the groundwater sampling schedule, and **Table 5-7** lists the wells that were sampled and the analyses that were performed during this phase of the demonstration. Laboratory analytical results are summarized in **Table 5-8**.

VOC data were used to evaluate the impacts of system operation (i.e. groundwater recirculation) on dissolved chlorinated ethene concentrations. Analytical results indicated that while some fluctuations in CVOC concentrations were observed, few significant increases or decreases (>2 fold) were observed in any of demonstration area monitoring wells (**Table 5-8**). It should be noted that TCE and cDCE concentrations in EX-2 during the 2nd Baseline sampling event (this well was not sampled during the 1st Baseline event) were significantly lower than surrounding wells, and did increase substantially (to levels comparable to other wells in Loop 2) in subsequent sampling events. Some decreases in TCE and increases in cDCE may have been attributable to partial dechlorination, as a result of electron donor and buffer addition.

VFA and pH data were used to evaluate the migration and impacts of lactate and buffer (sodium bicarbonate and sodium carbonate) addition. VFAs were observed in all 8 transect performance monitoring wells (BMW-1 through BMW-8), all 4 extraction wells (EX-1 through EX-4), and wells BMW-9, PZ-1, PZ-2 and MAG-113P within 32 days of starting amendment addition. These data indicated that electron donor was quickly distributed throughout all 4 recirculation loops.

While electron donor was quickly distributed, it took longer for the impacts of the injected buffer (i.e. increased pH) to be seen downgradient (**Table 5-10**). This was most likely due to the acidic soil at the Site consuming the injected buffer and slowing its downgradient progress. However, by the end of the Start-up period, pH levels in 6 of the 8 transect wells (plus wells PZ-1, PZ-2 and MAG-113P) had increased to >5.5 from baseline levels of approximately 4.5 standard units. At the end of the Start-up period, pH levels in wells BMW-4 and BMW-8 were 4.7 and 5.4 standard units, respectively (**Table 5-10**). It should be noted that pH levels in the four extraction wells were often below 5.5 standard units because these wells were also pulling in water from outside (downgradient and side-gradient) the treatment zone.

Anion and field parameter data were used to evaluate changes in aquifer geochemistry. ORP levels in the 8 transect performance monitoring wells decreased from between +19 and +146 mV to between -45 and -148 mV during the Start-up period (**Table 5-10**). Dissolved oxygen concentrations were generally below 0.5 mg/L at the end of the Start-up period. These conditions were sufficiently reducing to cause decreases in sulfate concentrations between 31 and 76 percent in the 8 transect performance monitoring wells (**Table 5-8**).

5.7.4 Performance Sampling

Twelve performance monitoring sampling events were performed at select monitoring locations within the demonstration area after bioaugmentation with SDC-9. This extensive groundwater monitoring was performed to evaluate:

1. Changes in aquifer geochemical conditions (i.e., decreases in dissolved oxygen and other electron acceptors, decreases in ORP, and changes in pH),
2. Changes in chlorinated ethene concentrations,
3. Electron donor concentrations and distribution, and
4. DHC growth and distribution (via qPCR analysis).

Table 5-1 and **Figure 5-1** summarize the groundwater sampling schedule, and **Table 5-7** lists the wells that were sampled and the analyses that were performed during this phase of the demonstration. The first five sampling events were performed between the first and second bioaugmentation events (**Section 5.5.3.1**). The next five sampling events were performed after the second bioaugmentation event, and while the groundwater recirculation system was operating in “Active-Passive” mode. The final two sampling events were performed after the groundwater recirculation system had been shut down.

Analyses of groundwater collected during the performance monitoring sampling events included VOCs, reduced gases, VFAs, anions (including nitrate and sulfate), dissolved iron and manganese, and DHC (**Table 5-7**). Field parameters were also collected during well purging. Laboratory analytical, laboratory DHC, and field parameter results are summarized in **Tables 5-8, 5-9, and 5-10**, respectively.

Chlorinated Ethenes and Ethene

Figure 5-23 shows chlorinated ethene (TCE, cDCE and VC) concentrations at the end of the demonstration. Most of these data were collected on January 5, 2009. However, the figure includes earlier CVOC data from wells BMW-9 through BMW-11 and the 4 injection wells, as they were sampled for the last time on November 11, 2008. Analytical data are summarized in **Table 5-8**. **Figures I-1** through **I-22**, located in **Appendix I**, provide chlorinated ethene and ethene trend graphs for demonstration area wells. The data presented in the trend graphs are in molar units (microMolars (μM)), rather than mass units of aqueous concentrations (i.e. $\mu\text{g/L}$). Presenting the data in this way allows for evaluating product stoichiometry associated with the degradation of chlorinated ethenes.

TCE concentrations in transect performance monitoring wells BMW-1 through BMW-6 in Loops 1 through 3 (test loops) declined significantly during the demonstration. TCE decreases in these wells ranged from 90 to 100 percent (or non-detect; less than $5 \mu\text{g/L}$) (**Table 5-8**). As shown on **Figures I-1** through **I-6** (**Appendix I**), with the exception of well BMW-5, these declines primarily occurred after the second bioaugmentation. TCE decreases in wells PZ-1, PZ-2 and MAG-113P (Loop 3) ranged from 99 to 100 percent (**Table 5-8, Appendix I**).

TCE concentrations in the transect performance monitoring wells BMW-7 and BMW-8 in Loop 4 (control loop) declined as well, with decreases in these wells between 98 and 100 percent (**Table 5-8, Appendix I**). TCE decreases were expected in the control loop, as the addition of electron donor in the microcosm studies (**Section 5.3.1**) stimulated degradation of TCE (but not cDCE). With the exception of EX-2, decreases in TCE concentrations (19 to 83 percent) were also observed in the extraction wells. As discussed in **Section 5.2.5**, TCE and cDCE concentrations in EX-2 during the 2nd Baseline sampling event (this well was not sampled during the 1st Baseline event) were significantly lower than surrounding wells, and did increase substantially (to levels comparable to other wells in Loop 2) in subsequent sampling events. TCE concentrations increased from $190 \mu\text{g/L}$ to $460 \mu\text{g/L}$ in background well MAG-4 during the demonstration.

A 57 percent decrease in TCE concentrations was observed in well BMW-9 (located 7.5 feet side-gradient of the Loop 1 transect; **Figure 5-5**). However, decreases in TCE concentrations were not observed in wells BMW-10 (located 15 feet side-gradient of the Loop 1 transect) and BMW-11 (located between, and ~ 12.5 feet side-gradient of Loops 1 and 2) (**Figure 5-5**). These data indicate that the width of the treatment zone in Loop 1 was between approximately 15 and 20 feet.

cDCE concentrations in performance monitoring wells BMW-1 through BMW-6 in Loops 1 through 3 (test loops) declined between 73 and 99 percent, and were generally trending downward at the end of the demonstration period (**Table 5-8, Figures I-1** through **I-6** in **Appendix I**). Transient increases (followed by decreases) in VC were observed in 5 of these six wells, with 2 of the wells (BMW-1 and BMW-2) below detection at the end of the demonstration. Well BMW-4 showed a small increase (non-detect to $25 \mu\text{g/L}$) in VC concentrations during the final 2 sampling events. Ethene concentration trends in all 6 wells indicated that complete dechlorination of TCE was occurring in all three test loops (**Table 5-8, Figures I-1** through **I-6** in **Appendix I**). The data indicate that greater than 95 percent of the

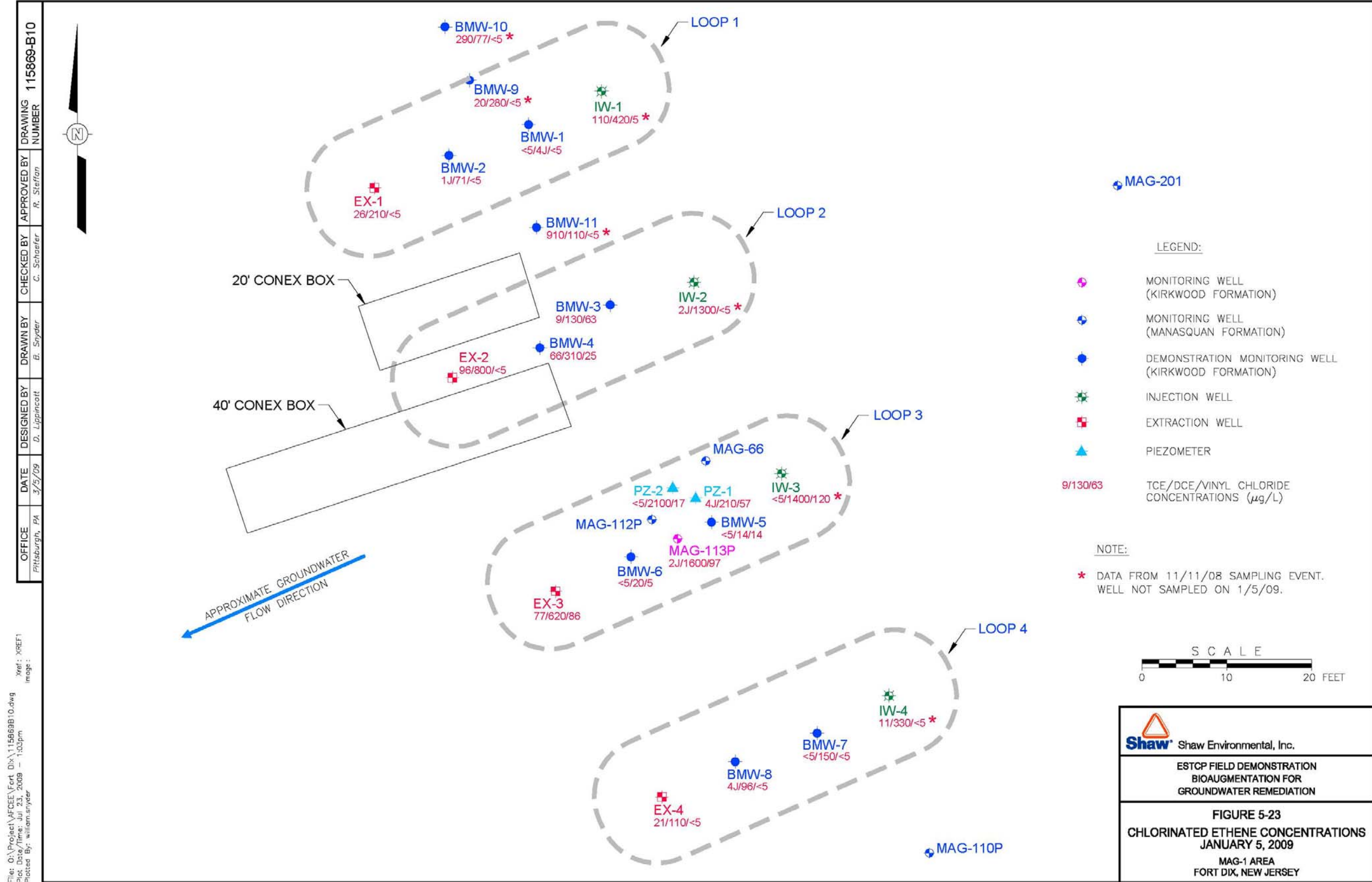

TCE and cDCE observed at three of the six performance monitoring wells in Loops 1 through 3 (BMW-1, BMW-5 and BMW-6) had been converted to ethene. Loop 2 (which had issues with the pH dropping below 5.5) had the lowest ethene conversion rates; 39 percent at BMW-3, and 5 percent at BMW-4. Molar balance calculations performed using concentration data collected during the final sampling event indicated that ending Molar balances (which included TCE, cDCE, VC and ethene) were generally in the 40 to 70 percent range, when compared to starting CVOC concentrations. The lack of a complete Molar balance is most likely due to the fact that ethene sampling often underestimates true concentrations due to losses through volatilization during sampling (because of its high Henry's Law coefficient), and is consistent with results from similar field studies.

cDCE concentrations in Control Loop monitoring well BMW-7 increased by 67 percent (**Table 5-8**). Concentrations in well BMW-8 during the demonstration were generally above baseline, with the exception of the final sampling event. Vinyl chloride and/or ethene were not observed in either of these wells at the end of the demonstration, indicating that degradation of TCE had "stalled" at cDCE in the absence of bioaugmentation (**Table 5-8, Figures I-7 and I-8 in Appendix I**). cDCE concentrations in background well MAG-4 remained essentially unchanged during the demonstration (**Table 5-8**).

In well PZ-1 (shallow well in Loop 3), cDCE concentrations decreased 58 percent (after a temporal increase) and were trending downward at the end of the demonstration, while VC and ethene concentrations were increasing (**Table 5-8, Figure I-12 in Appendix I**). These data, when compared to wells BMW-5 and BMW-6, suggest that treatment is a little slower in the upper portion of the Kirkwood aquifer.

cDCE concentrations in wells PZ-2 and MAG-113P (Formation Interface) generally increased throughout the demonstration (**Figures I-13 and I-14 in Appendix I**). It should be noted that the treatment system was designed to treat contaminants within the Kirkwood aquifer, and was not designed to treat the underlying higher permeability Interface Zone. Therefore, bioaugmentation with SDC-9 was not performed within this zone. cDHC data (discussed below) indicated that the injected bacteria were beginning to migrate to this zone at the end of the demonstration. Additionally, vinyl chloride and ethene concentration data (discussed below) from the final sampling event indicated that degradation of cDCE was beginning at well MAG-113P (where increases in DHC were being observed). It is expected that had SDC-9 been injected directly into this zone, degradation of cDCE would have begun sooner.

A 75 percent increase in cDCE concentrations was observed in well BMW-9 (**Table 5-8, Figure I-9 in Appendix I**). Vinyl chloride and ethene were not observed at this well throughout the demonstration. Additionally, laboratory analytical data (discussed below) indicated that the DHC concentrations at this well were not high enough (<approximately 10^7 cells/liter) for significant levels of cDCE dechlorination to occur. These data further indicate that this well was located along the outer edge of the treatment zone of Loop 1. The lack of any observed VC and/or ethene, along with VFA and field parameter data (discussed below), indicated that wells BMW-10 and BMW-11 were outside of the treatment zone. Vinyl chloride, ethene, and VFAs were not observed in background well MAG-4 during the demonstration.

The presence of aqueous ethene concentrations is a key indicator of complete dechlorination of TCE. Ethene concentrations observed at the end of the demonstration are presented in **Figure 5-24**. These data clearly indicated that complete degradation is occurring within the 3 test loops (Loop 1 through Loop 3) that were bioaugmented with SDC-9, and not within the control loop (Loop 4) that received only electron donor, buffer and nutrients. Reductions in TCE concentrations, vinyl chloride and ethene concentration trends, and increased DHC concentrations (discussed below) in extraction wells EX-1, EX-2 and EX-3 indicated that degradation was occurring through the entire lengths of Loop 1 through Loop 3 (test loops). Vinyl chloride and ethene were not observed in extraction well EX-4 (located within the control loop).

Anions

Nitrate was not detected in any of the wells sampled throughout the demonstration period. Sulfate concentrations in performance monitoring wells BMW-1 through BMW-9 declined between 88 and 100 percent during the demonstration (**Table 5-8**). Sulfate concentrations in wells PZ-1, PZ-2 and MAG-113P declined between 99 and 100 percent. Sulfate concentrations in wells BMW-10 and BMW-11 (outside the treatment zone) generally remained the same, with the exception of a nearly two-fold increase in well BMW-10 during the second to last sampling event (**Table 5-8**). Significant reductions (82 to 100 percent) in sulfate were also observed in the four extraction wells. These data indicate that sulfate-reducing conditions existed in all 4 recirculation loops during the demonstration. Sulfate concentrations in background well MAG-4 were consistent during the demonstration (**Table 5-8**).

Volatile Fatty Acids

VFA concentrations were observed in performance monitoring wells BMW-1 through BMW-9 throughout most of the demonstration. Total VFA concentrations generally ranged from 50 mg/L to 2,000 mg/L (**Table 5-8**). VFAs were observed at similar to slightly higher concentrations at wells PZ-1, PZ-2 and MAG-113P. With only one exception (BMW-11 on 12/4/07), VFAs were not detected in wells BMW-10 and BMW-11 (outside the treatment zone) during the demonstration. VFAs were observed at concentrations between 50 and 1,000 mg/L at all four extraction wells. These data indicate that lactate injection rates provided effective distribution of electron donor throughout all 4 recirculation loops during the demonstration. VFAs were not detected in background well MAG-4 during the demonstration (**Table 5-8**).

Metals

With few exceptions, there were no significant increases or decreases in dissolved iron or manganese concentrations during the demonstration. Dissolved iron concentrations in the 14 demonstration monitoring wells (BMW-1 through BMW-11, PZ-1, PZ-2, and MAG-113P) ranged from 251 µg/L to 10,000 µg/L at the end of the demonstration (**Table 5-8**). Dissolved iron concentrations in the four extraction wells were also within that range. Dissolved iron concentrations in background well MAG-4 increased from 298 µg/L to 2,580 µg/L during the demonstration. Under the reducing conditions that were induced during the demonstration one would expect that dissolved iron concentrations would increase. However, with the observed reduction of sulfate, the addition of carbonate buffers, and the ORP and pH ranges observed

OFFICE: Pittsburgh, PA
 DATE: 3/25/09
 DESIGNED BY: D. Lippincott
 DRAWN BY: B. Snyder
 CHECKED BY: C. Schaefer
 APPROVED BY: R. Steffon
 DRAWING NUMBER: 115869-B12

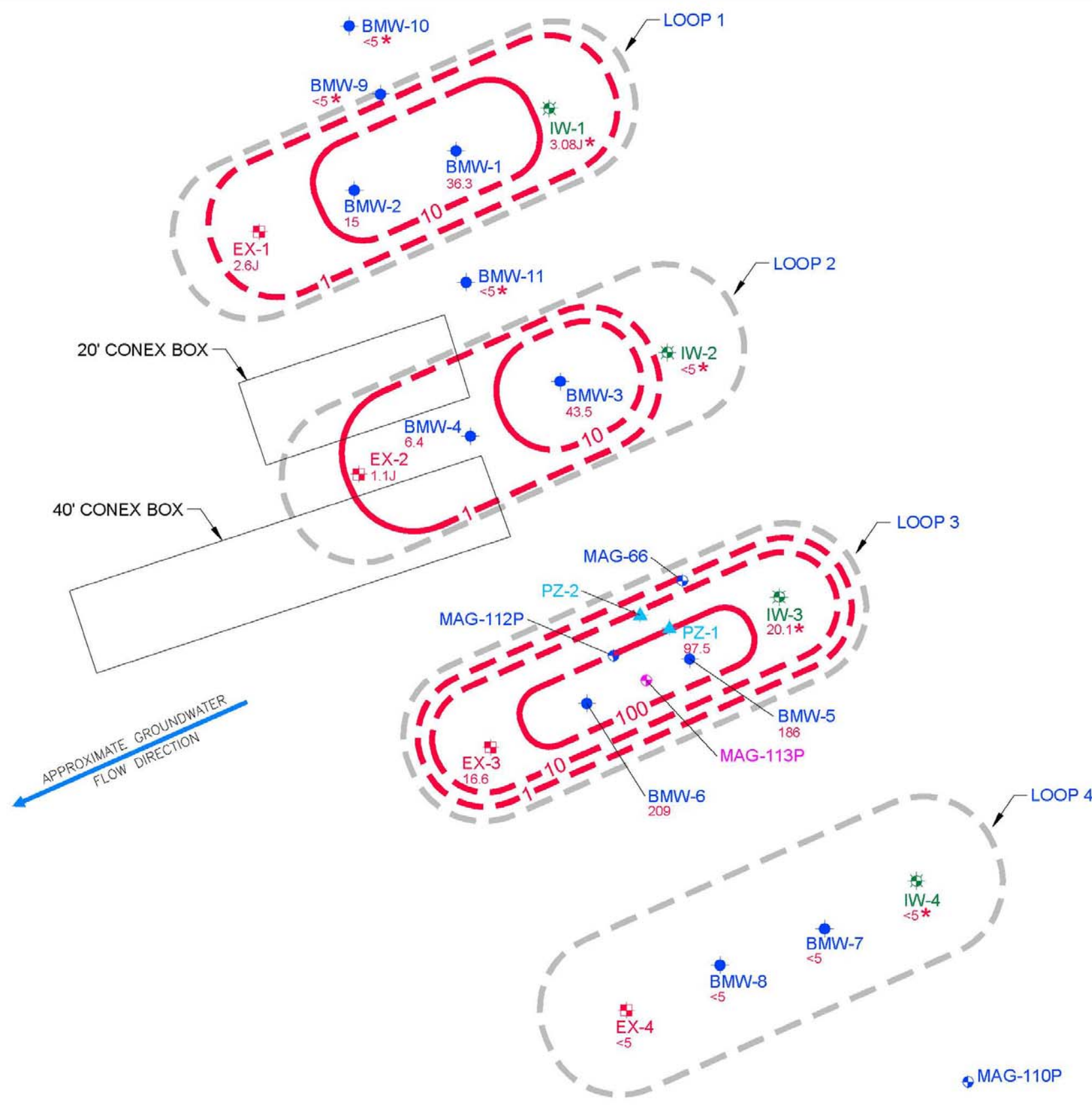

LEGEND:

- MONITORING WELL (KIRKWOOD FORMATION)
- MONITORING WELL (MANASQUAN FORMATION)
- DEMONSTRATION MONITORING WELL (KIRKWOOD FORMATION)
- INJECTION WELL
- EXTRACTION WELL
- PIEZOMETER

110/130/<math><5</math> ETHENE CONCENTRATION ($\mu\text{g/L}$)
 - - 10 - - ETHENE CONCENTRATION CONTOUR ($\mu\text{g/L}$) DASHED WHERE INFERRED

NOTE:

- * DATA FROM 11/11/08 SAMPLING EVENT. WELL NOT SAMPLED ON 1/5/09.



Shaw Environmental, Inc.
 ESTCP FIELD DEMONSTRATION
 BIOAUGMENTATION FOR
 GROUNDWATER REMEDIATION
FIGURE 5-24
ETHENE CONCENTRATIONS
JANUARY 5, 2009
 MAG-1 AREA
 FORT DIX, NEW JERSEY

File: O:\Project\AFCEE\Fort Dix\115869B12.dwg
 Plot Date/Time: Jul 23, 2009 - 1:06pm
 Plotted By: william.snyder

during the demonstration, dissolved iron could have precipitated out as iron sulfides (FeS₂) or iron carbonates (FeCO₃) (Dragun, 1998).

Dissolved manganese concentrations in the 14 demonstration monitoring wells ranged from non-detect (<15 µg/L) to 96.5 µg/L at the end of the demonstration (**Table 5-8**). Dissolved manganese concentrations in the four extraction wells were also within that range. Dissolved manganese concentrations in background well MAG-4 remained essentially the same during the demonstration (**Table 5-8**). At the ORP and pH ranges observed during the demonstration, dissolved manganese would most likely have increased, if manganese was present at significant concentrations within the soil (Dragun, 1998).

DHC

One of the key objectives of this demonstration was to determine the DHC dosage required to effectively remediate a chlorinated-ethene contaminated site. As such, comparisons were made among the four loops to quantify the impacts of the varying DHC dosage on the rate and extent of TCE remediation, and the distribution of growth of DHC in the subsurface. qPCR analyses was used to measure DHC concentration as a function of time and distance from the injection wells during the demonstration. DHC data are summarized in **Table 5-9** and presented in the trend graphs in **Appendix I**. Replicate samples were graciously analyzed in the laboratory of Dr. Frank Loeffler at the Georgia Institute of Technology (**Appendix J**).

The main challenges associated with analyzing DHC data from the demonstration were:

1. Two bioaugmentation injection events were performed. The first injections were performed at injection wells IW-1 through IW-3, and the second injections were performed 10 feet downgradient at monitoring wells BMW-1, BMW-3, and BMW-5 (**Section 5.5.3.1**), making interpretation of DHC data more difficult,
2. The concentration of the injected culture during the second bioaugmentation was approximately two orders of magnitude higher than those injected during the first bioaugmentation (**Section 5.5.3.1**),
3. Fluctuations in pH levels within the recirculation loops (especially loop 2) affected activity and growth of DHC,
4. DHC samples collected from injection wells generally provide only aqueous DHC concentrations, as a significant fraction of the injected culture may be associated with aquifer sediments. However, subsequent generations of the culture tend to be more mobile, and do not attach to soil as readily as the injected culture (**Section 5.3.2**) (Schaefer et al., 2009).
5. Not all DHC are capable of dechlorination of TCE and/or its daughter products (cDCE and VC), and DHC that were incapable of complete dechlorination (or possibly any dechlorination) were already present at the site. Therefore, DHC concentrations are not always a clear indicator of degradation potential.

Despite these challenges, the following observations were made based on DHC and CVOC data collected during the demonstration:

- Aqueous DHC concentrations increased in test Loops 1 through Loop 3, as well as control Loop 4 (monitoring wells BMW-1 through BMW-9) (see #5 above). However, aqueous DHC concentrations increases were orders of magnitude higher in Loops 1 through 3, compared to Loop 4. Final DHC concentrations in wells BMW-7 and BMW 8 (control loop) were 2.08×10^6 and 1.14×10^6 cells/liter (respectively), while DHC concentrations in wells BMW-1 through BMW-6 (with the exception of BMW-4, which had low pH issues) ranged from 1.77×10^7 to 2.02×10^9 cells/liter.
- Bacteria injected during the first bioaugmentation (injection wells IW-1, IW-2 and IW-3) appear to have been killed, or rendered ineffective, by a high pH spike in the injection wells. pH values >10 were measured in the injection wells shortly after the injections.
- After the second bioaugmentation, aqueous DHC concentrations increased immediately by orders of magnitude in the injection wells (BMW-1, BMW-3 and BMW-5), and increased more slowly (but also by orders of magnitude) in the downgradient monitoring wells, as the injected culture moved through the aquifer via both transport and growth.
- DHC were not distributed as quickly or as extensively within the subsurface as the soluble amendments. This is due to the fact that the SDC-9 culture is not soluble, and that it partially relies on growth for distribution.
- Vinyl chloride and ethene were generally observed when aqueous DHC concentrations reached a level of approximately 1.0×10^7 cells/liter, or greater. These data indicate the complete degradation of TCE occurs readily at (and above) this cell concentration at this Site. These results are consistent with the findings of Lu et al., 2006.
- Aqueous DHC concentrations in the 3 test loops tended to reach and maintain an apparent equilibrium of approximately 10^8 to 10^9 cells/liter (**Table 5-9, Appendix I**). DHC concentrations in well BMW-1 were 3.32×10^{10} cells/liter shortly after the second injection, and decreased to between 2.02×10^9 and 7.15×10^9 cells/liter during the last 4 sampling events (**Figure I-1 in Appendix I**). DHC concentrations in BMW-3 remained in the 10^8 to 10^9 cells/liter range from injection through the end of the demonstration (**Figure I-3 in Appendix I**). Further, DHC in well BMW-5 increased from 1.92×10^7 shortly after the second injection, to between 1.12×10^8 and 7.44×10^8 during the last 4 sampling events (**Figure I-5 in Appendix I**).
- There did not appear to be a correlation between DHC dosage and downgradient DHC transport. The data suggest that DHC concentration increased downgradient of the injection wells at similar rates.

Field Parameters

Field parameters were collected during each of the performance sampling events. Key field parameters included pH, specific conductivity, ORP, and dissolved oxygen. Groundwater temperature and turbidity were also collected. Field parameter data are summarized in **Table 5-9**. Significant changes to the key field parameters were observed at wells where electron donor was observed (BMW-1 through BMW-9, PZ-1, PZ-2, MAG-113P). The following summarizes the changes observed to the key field parameters at these locations by the end of the demonstration:

- **pH:** increased from generally below 5.0 to between 6.0 and 7.1 standard units. Maintaining pH levels in this range was difficult, with levels dropping below 5.5 (the level at which SDC-9 dechlorination rates drop significantly) in some of the wells during periods of the demonstration.
- **Specific conductivity:** increased from between 19 and 236 $\mu\text{S}/\text{cm}$ to between 1,743 and 4,336 $\mu\text{S}/\text{cm}$. These increases are most likely due to the large amounts of sodium carbonate and sodium bicarbonate (as well as diammonium phosphate and sodium lactate) that were injected into the aquifer to raise and maintain pH levels.
- **ORP:** decreased from generally greater than +50 mV to between -127 and -300mV (consistent with sulfate reduction), as a result of electron donor addition and biological activity.
- **Dissolved Oxygen:** generally exhibited decreases from baseline concentrations (that were already largely < 1.0 mg/L) as a result of electron donor addition and biological activity. It should be noted that dissolved oxygen concentration data collected in the field is not as accurate as many of the other field parameter data due to meter limitations.

Similar changes in key field parameters were observed in all of the extraction and injection wells. Field parameters did not change significantly at wells BMW-10 and BMW-11 (outside the treatment zone), and background well MAG-4.

5.7.5 Systems Operation

Operation of the four groundwater recirculation loops began on November 15, 2007, with operation of the amendment injection systems beginning on November 16, 2007, after a full day of successful groundwater recirculation. The groundwater recirculation and amendment delivery systems operated nearly continuously (except for brief O&M shutdown periods) during the 10-week Start-up period (**Section 5.5.2**). After the first bioaugmentation injection on January 24, 2008, the groundwater recirculation and amendment delivery systems continued to be operated continuously until March 3, 2008 (39 additional days) (**Section 5.5.3.2**). Groundwater extraction rates began at 0.5 gpm for each extraction well, and were decreased incrementally to 0.25 gpm during this period to minimize injection pressures at the injection wells.

Between March 3, 2008 and November 5, 2008, the systems were operated in an “Active-Passive” mode (**Section 5.5.3.2**). This approach provided mixing of electron donor and nutrients within the designed treatment areas, and allowed natural groundwater flow to further distribute the amendments downgradient. This approach also helped to mitigate biofouling issues during the demonstration. System operational periods are summarized in **Table 5-1**. The amendment delivery system generally operated while groundwater was being re-circulated, with the exception of the last 25 days of operation (October 10, 2008 to November 5, 2008), when amendment delivery was halted. Groundwater extraction rates for each extraction well were reduced further, from 0.25 gpm to 0.1 gpm during this 8-month period. Additionally, Loop 1 groundwater recirculation and amendment addition was ceased on October 1, 2008 (approximately 1 month before Loops 2 through 4) due to excessive groundwater mounding in the vicinity of injection well IW-1.

There were no significant mechanical problems during the demonstration. A total of approximately 333,000 L (88,000 gallons) (an estimated 6.5 pore volumes) of groundwater were extracted and re-injected within each of the 4 loops during the demonstration. A total of 2,290 L (605 gallons) of 60% sodium lactate solution, 114 kg (250 lbs.) of diammonium phosphate, and 68 kg (150 lbs.) of yeast extract, were injected evenly into the four loops during the 12 months of system operation.

Sodium bicarbonate buffer was used from Start-up (November 16, 2007) until December 11, 2007, at which time the buffer used was changed to sodium carbonate (a stronger buffer) to more effectively increase pH within the aquifer. Additionally, bulk injections of sodium carbonate were performed on December 27, 2007 (100 lbs per well) and January 15, 2008 (150 lbs. per well) at each of the four injection wells. These bulk injections were performed to further elevate groundwater pH values that still largely remained below 5.5 standard units after several weeks of system operation. Sodium carbonate buffer was used from December 11, 2007 until May 30, 2008, at which time the buffer used was changed back to sodium bicarbonate (a weaker buffer) to maintain the desired pH within the aquifer. The buffer was switched back to sodium carbonate on July 15, 2008 (and continued until the end of the demonstration) when it was observed that pH levels were dropping within the aquifer. A total of 3180 kg (7,000 lbs.) of sodium bicarbonate and 4,360 kg (9,600 lbs.) of sodium carbonate (including the bulk injections) were injected into the four Loops during the 12 months of system operation.

The SCADA system allowed for remote monitoring and adjustments of groundwater extraction and injection rates, as well as amendment (electron donor, buffer and nutrient) injection frequency and duration. System operating parameters were adjusted as necessary to optimize performance. Additionally, Shaw personnel performed regular site checks and maintenance of the groundwater recirculation and amendment delivery systems during the demonstration. Site checks included measurements of system pressures (manual gauges), water levels, extraction and injection flow rates and totals, changing of filter cartridges, mixing of amendment solutions, as well as leak checks and filter changes. The mixing of buffer solutions was by far the most time-intensive O&M component.

The general approach for biofouling control was discussed in **Section 5.4.4**. Water levels in the extraction wells and water levels and/or injection pressures in the injection wells were monitored for signs of fouling. As discussed in **Sections 5.5.2** and **5.5.3.2**, all four injection wells were redeveloped in December 2007 during the Start-up phase, and again in June 2008 during the Systems Operation phase using the methods described in **Section 5.4.4**. Well fouling appeared to be occurring from an accumulation of carbonate and insoluble complexes (most likely iron sulfides and iron carbonates, as discussed in **Section 5.7.4**) within the well screen, sandpack and the immediate surrounding formation. The accumulation of biomass did not appear to be a major cause of well fouling. This is most likely due to the fact that injection well pH levels were often too high (generally >9 standard units) for significant biological growth to occur.

6.0 PERFORMANCE ASSESSMENT

Performance objectives were established for this demonstration to provide a basis for evaluating the performance and costs of anaerobic bioaugmentation. The primary performance objectives for this demonstration are discussed in **Section 3.0**, and summarized in **Table 3-1**.

As summarized in **Table 3-1**, the established performance objectives were generally met during the demonstration. The following subsections summarize data collected and provides an assessment of the performance objectives, including to what extent the success criteria were achieved.

6.1 DHC DOSAGE COMPARISON

The key objective of this demonstration was to determine the DHC dosage required to effectively remediate a chlorinated-ethene contaminated site. The current industry standard for estimating the amount of culture involves estimating the volume of water in the treatment zone by multiplying the length, width and thickness of the contaminated saturating zone by the estimated porosity (length x width x thickness x porosity), and then adding enough culture to achieve 10^7 DHC/L assuming even distribution of the added culture. We evaluated 40 successful field-scale bioaugmentation applications performed by Shaw at DoD facilities (**Table 2-1**). The average volume of aquifer treated during these projects was approximately 29,000 m³, and the average volume of culture applied was 115 L. The culture contained 10^{11} DHC/L. Assuming an average of 25% porosity, the volume of treated water was 7.7×10^6 L. This equates to an inoculum dosage of 0.2×10^7 DHC/L of treated groundwater, which is within the range predicted to be effective by Lu et al. (2006) and similar to the industry standard of 10^7 DHC/L. This approach, however, does not account for differences in contaminant concentration that can affect the growth of the added organisms, or the hydrogeology of the aquifer which can affect distribution of the bacteria.

Groundwater monitoring was performed to evaluate DHC growth and migration, dechlorination kinetics, and aquifer geochemistry. These data indicated that the bacteria injected during the first bioaugmentation (injection wells IW-1, IW-2 and IW-3) appear to have been killed, or rendered ineffective by a high pH spike in the injection wells. Therefore, a second bioaugmentation was performed at monitoring wells BMW-1, BMW-3, and BMW-5 (located 10 feet downgradient of the injection wells) to prevent the high pH issues encountered after the first bioaugmentation (**Section 5.7.4**). This represented target final DHC concentrations of 5×10^7 , 5×10^8 , 5×10^9 , and 0 DHC/L, respectively. After the second bioaugmentation, aqueous DHC concentrations increased immediately by orders of magnitude in wells BMW-1, BMW-3 and BMW-5, and increased more slowly (but also by orders of magnitude) in the downgradient monitoring wells, as the injected culture moved through the aquifer via both transport and growth (**Section 5.7.4**). The data indicate that there was no apparent correlation between DHC dosage and down gradient transport of DHC. That is, greater DHC dosages did not result in faster down gradient distribution of DHC. Consequently, the results demonstrate that even at lower DHC dosages bioaugmentation can be effective, provided CVOC concentrations are sufficient to promote *in situ* growth of the added DHC.

The loop inoculated with 10 L of culture (Loop 2) showed slower dechlorination kinetics and DHC migration/growth compared to the other two test loops. This relatively poor performance

was attributed to low pH conditions that were not effectively controlled by the addition of buffer (**Section 5.7.4**). Results for the loops inoculated with 1 L (Loop 3) and 100 L (Loop 1) of culture showed similar rates of dechlorination, as measured at a monitoring well approximately 10 feet downgradient of the DHC injection well (as well as the injection and extraction wells and other monitoring wells). Final DHC concentrations in these two test loops ranged from 1.8×10^7 to 2.0×10^9 cells/liter. Complete dechlorination (as indicated by the presence of and ethene) was generally observed when aqueous DHC concentrations reached a level of approximately 1.0×10^7 cells/liter, or greater. These data indicate the complete degradation of TCE occurs readily at (and above) this cell concentration at this Site. These results are consistent with the findings of Lu et al., 2006.

To provide a first level evaluation of *in situ* dechlorination kinetics and DHC growth, the 1-dimensional screening level bioaugmentation model developed during the project (Schaefer et al. 2009) for the SDC-9 culture was applied to demonstration loops 1 and 3. This model employs Monod kinetics to describe DHC growth and dechlorination kinetics (determined for the SDC-9 culture in batch kinetic studies), and applies an attachment-detachment type model to describe DHC migration through soil. Immobile and mobile DHC near the bioaugmentation injection well, and mobile DHC migrating downgradient from the bioaugmentation injection well, contribute to contaminant dechlorination. This finite difference model ($\Delta x=1$ ft, $\Delta t=0.4$ days) was applied to describe DHC growth and dechlorination from BMW-1 to BMW-2, and from BMW-5 to BMW-6. Because of the low pH issue at BMW-4, which likely resulted in inhibition of DCE dechlorination, the model was not applied to loop 2. The simulated porosity was assumed to be 0.35, and the superficial velocity for loops 1 and 3 were estimated (based on the bromide tracer data, and adjusted based on the reduction in recirculation flow rate after bioaugmenting in each loop) at 0.021 m day⁻¹ and 0.029 m day⁻¹, respectively. The dispersivity was estimated based on the bromide tracer data at 0.15 m. The linear sorption coefficient for vinyl chloride was estimated at 3.8 L kg⁻¹, which was calculated based on the DCE sorption coefficient and the organic carbon partition coefficient of vinyl chloride relative to that of DCE (USEPA 1996). The linear sorption coefficient for ethene was assumed equal to that of vinyl chloride. The lone fitting parameter in the model was the attachment-detachment ratio of growing DHC in the soil. The best fit of this parameter (*f*) was approximately 0.1, indicating that 90% of the DHC growing in the soil detached and subsequently migrated through the aquifer.

Model predictions for loops 1 and 3 are shown in **Figures 6-1** and **6-2**. While intended to serve as only a semi-quantitative tool, the model provided a reasonable prediction of the timeframe for DCE treatment at each of the monitoring wells in these treatment loops. In addition, the model provided a reasonable prediction of the DHC concentrations in groundwater, although the elevated DHC levels at BMW-2 at 40 to 50 days after bioaugmentation are not readily explained. Most importantly, the model showed that treatment kinetics at BMW-2 and BMW-6 were similar despite a 100-fold difference in DHC bioaugmentation dosage at BMW-1 and BMW-5. It also showed that *in situ* DHC growth in loop 3 was greater than the DHC growth in loop 1. The rapid decrease in chlorinated ethene concentrations in BMW-1, which resulted from the large DHC inoculation dosage in this well, limits the subsequent rate of DHC growth within this treatment loop. Thus, *in situ* growth in loop 3 acted to compensate for the decreased DHC inoculation

dosage, and explains why results for these two treatment loops are similar despite the 100-fold difference in bioaugmentation dosage.

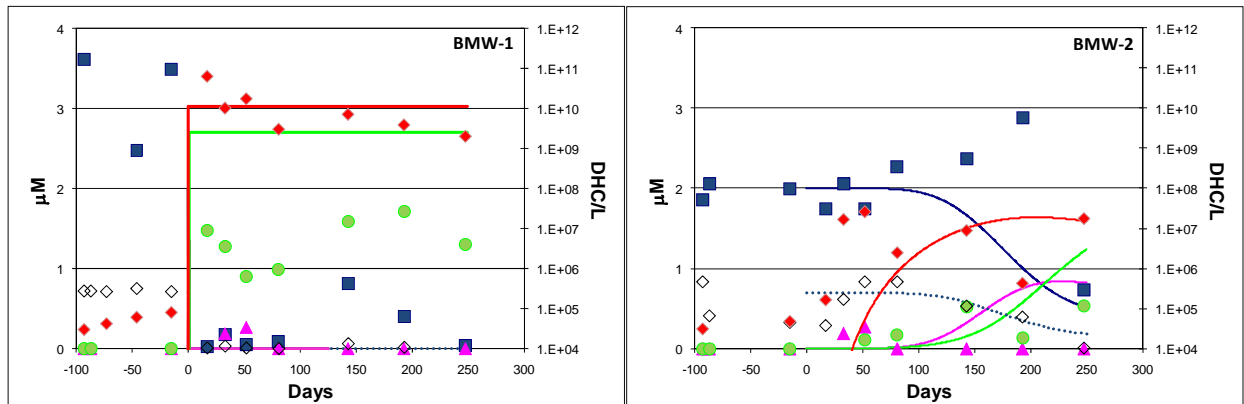

Figure 6-1. Ethenes and DHC concentrations plotted as a function of time for loop 1.

Bioaugmentation was performed at 0 days. \diamond - TCE, \blacksquare - DCE, \blacktriangle - vinyl chloride, \bullet - ethene, \blacklozenge - DHC. Solid and dotted lines represent corresponding model simulations. Simulated DHC concentrations in the bioaugmentation injection well (BMW-1) includes the total (mobile and immobile) DHC.

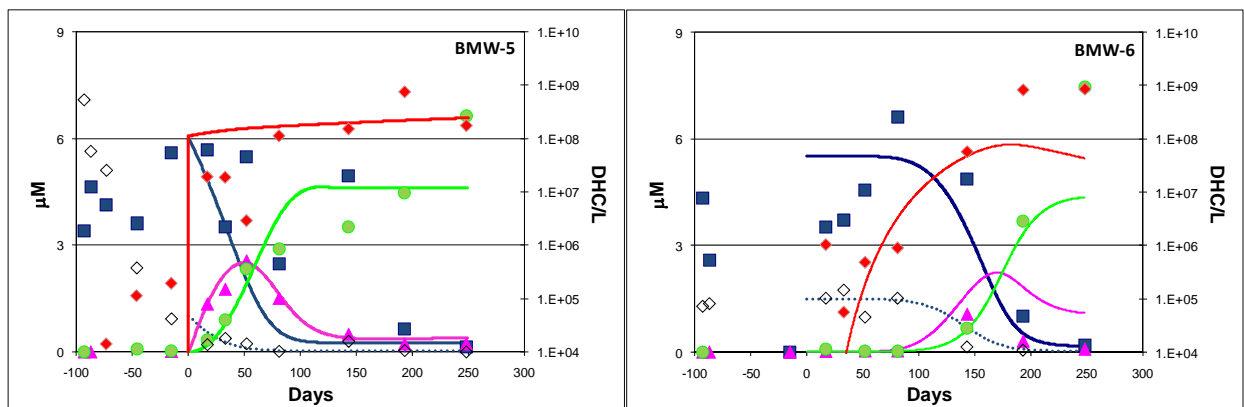
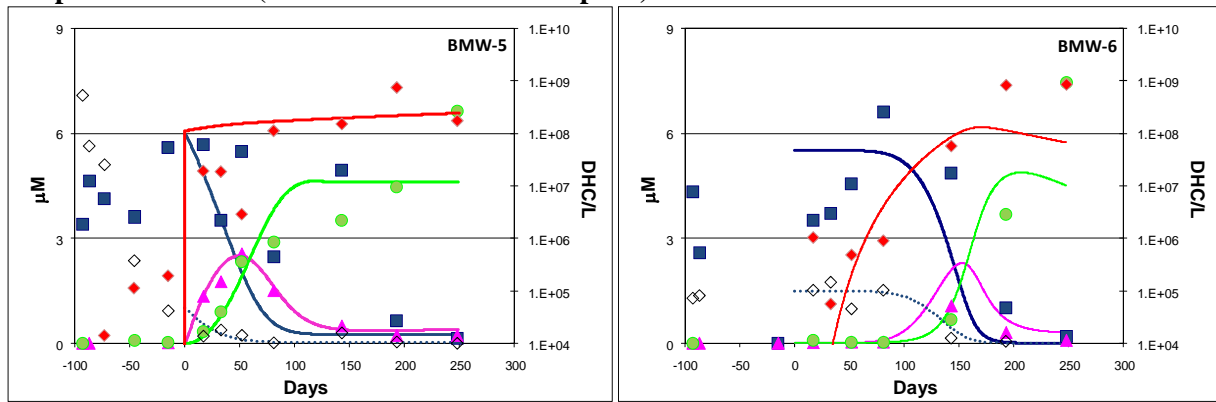

Figure 6-2. Ethenes and DHC concentrations plotted as a function of time for loop 3.

Bioaugmentation was performed at 0 days. \diamond - TCE, \blacksquare - DCE, \blacktriangle - vinyl chloride, \bullet - ethene, \blacklozenge - DHC. Solid and dotted lines represent corresponding model simulations. Simulated DHC concentrations in the bioaugmentation injection well (BMW-5) includes the total (mobile and immobile) DHC.

The treatment model also was applied to evaluate the expected performance of two lower cell dosages in loop 3 of the test plot. During the field demonstration, the second dose of SDC-9 applied to loop 3 would result in 10^7 DHC/L if evenly distributed through the plume/loop. Model simulations were performed assuming both 10^6 and 10^5 DHC/L. The results of these simulations are shown in **Figures 6-3**. They demonstrate that adding a 10-fold lower cell dosage (10^6 DHC/L) would have resulted in only a moderate delay (~ 3 months) in treatment at the down gradient monitoring well. Adding only 10^5 DHC/L would result in a significant delay in treatment. Thus, the optimum dosage for this treatment loop appears to be between 10^6 and 10^7 DHC/L. Interestingly, however, the simulations also demonstrated that adding 10-fold fewer cells (i.e., 10^6 DHC/L) in this test loop would have resulted in significantly reduced treatment near the injection well, and that treatment effectiveness convergence between the two dosages

Loop 3: 10⁷ DHC/L (measured and simulated plots)



Loop 3: 10⁶ DHC/L (simulated plots)

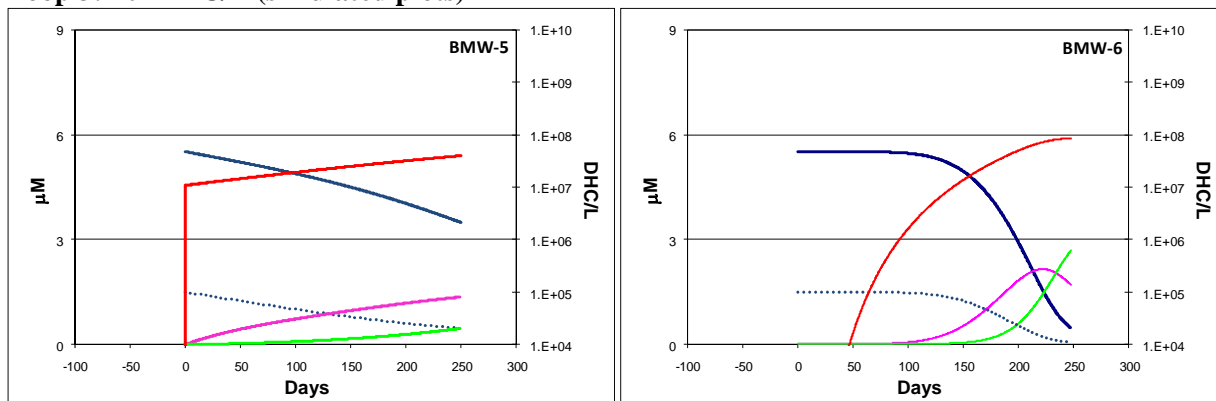

Loop 3: 10⁵ DHC/L (simulated plots)

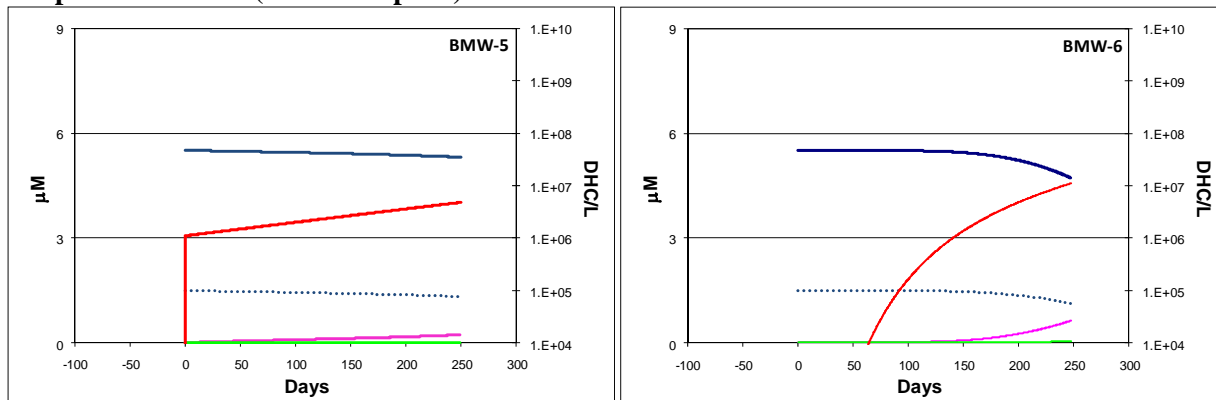

Figure 6-3. Model Simulation of cell dosage affects on treatment of TCE in Loop 3. Bioaugmentation was performed at 0 days. , Measured values: \diamond - TCE, \blacksquare - DCE, \blacktriangle - vinyl chloride, \bullet - ethene, \blacklozenge - DHC. Solid and dotted lines represent corresponding model simulations. Simulated DHC concentrations in the bioaugmentation injection well (BMW-5) includes the total (mobile and immobile) DHC.

only occurred with prolonged treatment time (i.e., further down gradient of the injection point). The important implication of this is that the model can be used to predict, based on culture dosage, how far down gradient from the injection points compliance concentrations may be reached. In some cases adding more culture will reduce the length of a plume. For example, at the demonstration site adding 10-fold less cells would have resulted in nearly 3-months longer

treatment time. If the groundwater moved 30 feet/month, adding the greater cell dosage could shorten the plume by 90 feet. This could be significant if the plume was nearing a sensitive receptor or a compliance point (e.g., a property line).

To further evaluate the affect of cell dosage during other bioaugmentation applications, additional model simulations were performed. The simulations evaluated how dosage affects the time required to reach 99% cVOC reduction. For example, one simulation evaluated the affect of cell dosage in a biobarrier application at low and high TCE concentrations and at two different f (attachement/detachment factors) values (**Figure 6-4**). With high TCE concentration (0.5 mM) and bioaugmentation dosages between $\sim 10^6$ and 10^9 DHC/L there was minimal difference in treatment time between the dosages, but a greater affect at a low f value ($f=0.1$) than at a high f value ($f=0.55$). Conversely, at a low TCE concentration (0.005 mM TCE), there was a significant difference in treatment times between the dosages especially at the higher f value. The f value can be affected by soil pore size, distribution and architecture, groundwater velocity (although constant in these simulations; 0.5 ft/day), sheer forces, and/or soil geochemistry that affects detachment and transport of the catalyst. A similar affect was observed for treatment of a DNAPL source area where adding higher cell dosages significantly shortened treatment time. A limited cell dosage affect was observed for simulated treatment of a low concentration TCE source area (data not shown).

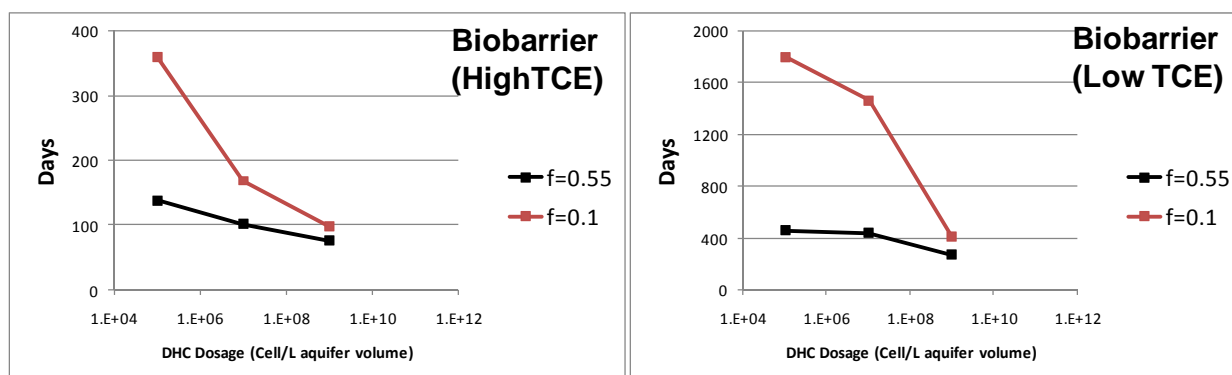

FIGURE 6-4. Model simulation of cell dosage effects on treatment of TCE in biobarrier applications (Schaefer et al., 2009). Data represent the amount of time required to reach 99% removal of cVOCs. All simulations assumed a groundwater velocity of 0.5 ft/day. High concentration TCE was 0.5 mM, and low concentration TCE was 0.005 mM.

Overall, the results of this field demonstration show that many factors including groundwater flow velocity, contaminant concentration, groundwater chemistry, and heterogeneity of the subsurface can affect the amount of culture needed to effectively treat chlorinated solvent-contaminated aquifers. Simply adding organisms based on the volume of groundwater to be treated may or may not lead to successful and timely remediation.

In cases like loop 3 in this demonstration where contaminant concentrations are fairly high, the formation is suitable for microbial transport, and groundwater recirculation is used to enhance the flow gradient and culture distribution, adding smaller amounts of culture may be warranted provided the organisms can grow in the treated environment. In cases where contaminant concentrations are lower (e.g., loop 1), or where bacterial transport conditions are not optimum, a

higher bioaugmentation dosage appears warranted. In either case, precisely determining the amount of culture needed for a given site still requires a site-by-site evaluation.

Importantly, the 1-dimensional model developed during this project and used to predict and evaluate growth of DHC and treatment effectiveness (Schaefer et al., 2009; **Appendix C**) reasonably described the results of the field demonstration. Consequently, the model appears suitable for evaluating the affect of different DHC dosages on treatment times and effectiveness, and it is a useful design tool for planning bioaugmentation applications and more precisely determining the desired culture dosage. A significant component of the model's use, however, is the need to determine the attachment-detachment factor (f) which varies based on aquifer geochemistry and soil texture. Work is on going to allow up-front estimates of this factor based on analysis of site samples, and efforts are in progress to incorporate the 1-dimmmensional model into existing groundwater flow and bioremediation models to make it more accessible to remediation practitioners. The model soon will be available in spreadsheet form incorporated into the widely used RT3D fate and transport model.

6.2 BIOAUGMENTATION/BIOSTIMULATION COMPARISON

Another performance objective was to compare dechlorination in the three test loops bioaugmented with SDC-9 to dechlorination by indigenous microorganisms through biostimulation in the control loop. Groundwater monitoring was performed at all four loops to evaluate DHC growth and migration, dechlorination kinetics, and aquifer geochemistry. Success criteria were established as; 1) complete dechlorination of TCE and cDCE to ethene in the three test loops, and 2) slow or incomplete dechlorination of TCE and cDCE in the control loop.

Groundwater sampling results indicated that aqueous DHC concentrations increased in the 3 test loops, as well as the control, biostimulation only, loop. However, aqueous DHC concentrations increases were orders of magnitude higher in the test loops, compared to the control loop. Final DHC concentrations in the two control loop performance monitoring wells were 2.1×10^6 and 1.1×10^6 cells/liter (respectively), while DHC concentrations in the test loop performance monitoring wells (with the exception of well BMW-4, which had a low pH) ranged from 1.8×10^7 to 2.0×10^9 cells/liter.

TCE concentrations in the test loop performance monitoring wells declined significantly during the demonstration, with TCE decreases in these wells ranging from 90 to 100 percent (or non-detect; less than $5 \mu\text{g/L}$) (see **Section 5.7.4**). TCE concentrations in the control loop performance monitoring wells declined as well, with decreases in these wells between 98 and 100 percent (see **Section 5.7.4**). TCE decreases were expected in the control loop, as the addition of electron donor in the microcosm studies (**Section 5.3.1**) stimulated degradation of TCE (but not cDCE).

cDCE concentrations in test loop performance monitoring wells declined between 73 and 99 percent, and were generally trending downward at the end of the demonstration period, while cDCE concentrations in the Control Loop generally increased during the demonstration (see **Section 5.7.4**). Transient increases (followed by decreases) in VC were observed in 5 of the 6 test loop performance wells, with 2 of the wells (BMW-1 and MW-2) below detection at the end of the demonstration (**Table 5-8**). VC was not observed in the control loop monitoring wells.

Ethene data collected during the demonstration clearly indicated that complete degradation was occurring within the 3 test loops that were bioaugmented with SDC-9, and not within the control loop that received only electron donor, buffer and nutrients. Reductions in TCE concentrations, VC and ethene concentration trends, and increased DHC concentrations (**Section 5.7.4**) in test loop extraction wells indicated that degradation was occurring through the entire length of the test loops. VC and Ethene were not observed in the control loop (with the exception of three detections of ethene below 1 µg/L at BMW-7) during the demonstration, indicating that degradation of TCE had “stalled” at DCE in the absence of bioaugmentation.

6.3 ELECTRON DONOR DISTRIBUTION

The third performance objective was to effectively distribute electron donor throughout all four demonstration recirculation loops (3 test loops and 1 control loop). The effective distribution of electron donor was critical to create anaerobic conditions within the aquifer, and to provide a source of carbon for microbial growth and electron donor for dehalogenation of the target contaminants. In order to determine if this goal was achieved, VFA concentration data were collected at performance monitoring, injection, and extraction wells throughout the demonstration. Success criteria were established as total VFA concentrations >5 mg/L at downgradient performance monitoring wells.

VFA data collected during the demonstration indicated that lactate injection and groundwater recirculation rates used during the demonstration provided effective distribution of electron donor throughout all 4 recirculation loops. VFA concentrations were observed in performance monitoring wells throughout most of the demonstration, with total VFA concentrations generally ranging from 50 mg/L to 2,000 mg/L. VFAs were observed at well BMW-9 (located 7.5 feet side-gradient of the Loop 1 transect; **Figure 5-5**), but not at BMW-10 (located 15 feet side-gradient of the Loop 1 transect) and BMW-11 (located between, and ~12.5 feet side-gradient of Loops 1 and 2) (**Figure 5-5**). These data were consistent with results from the tracer test, indicating that the primary treatment zone for each loop was approximately 20 feet wide and at least 30 feet long.

The addition of lactate created the desired reducing conditions within the aquifer. ORP decreased from generally greater than +50 mV to between -127 and -300 mV, and dissolved oxygen decreased from baseline concentrations (typically < 1.0 mg/L) as a result of electron donor addition and biological activity. Sulfate concentrations in performance monitoring wells located within the treatment zone declined between 88 and 100 percent during the demonstration (**Table 5-8**), indicating that sulfate-reducing conditions existed in all 4 recirculation loops during the demonstration.

6.4 pH ADJUSTMENT

The fourth performance objective of the demonstration, which was specific to the Ft. Dix site, was to increase and maintain groundwater pH levels within an acceptable range required for biological reductive dechlorination. This objective was critical for success at the Ft. Dix site because of its naturally low pH (pH ~4.5), and because preliminary testing revealed that DHC in the SDC-9 culture are sensitive to pH and that they do not dechlorinate well below pH ~5.5 (Vainberg et al., 2009). Therefore, the demonstration site groundwater pH levels needed to be

increased from approximately 4.5 to above 5.5-6.0 standard units for this demonstration to be successful.

As discussed throughout this document, increasing and maintaining pH levels within the recirculation loops was challenging. pH was increased from generally below 5.0 to between 6.0 and 7.1 standard units, except at injection wells where pH levels were often greater than 9.0 standard units due to the injection of sodium carbonate. The pH levels often dropped below 5.5 (the level at which dechlorination rates drop significantly) in some of the wells during periods of the demonstration. Despite preliminary laboratory testing, sodium bicarbonate was determined to be too weak to increase aquifer pH. Therefore, the buffer used was changed to sodium carbonate (a stronger buffer) to more effectively increase pH within the aquifer. Additionally, two bulk injections of sodium carbonate were needed (a total of 250 lbs. per well) to further elevate groundwater pH values that still largely remained below 5.5 standard units after several weeks of system operation. A total of 7,000 lbs. of sodium bicarbonate and 9,600 lbs. of sodium carbonate (including the bulk injections) were injected into the four Loops during the 12 months of system operation.

6.5 REMEDIAL EFFECTIVENESS

The final performance objective was to determine remedial effectiveness of bioaugmentation with SDC-9. Groundwater monitoring was performed at the three test loops bioaugmented with SDC-9 to evaluate DHC growth and transport, dechlorination kinetics, and aquifer geochemistry. Success criteria were established as; 1) >90% reduction of TCE and cDCE, and 2) complete dechlorination of TCE and cDCE to ethene.

The results of this project demonstrated that CVOCs in the Ft. Dix MAG-1 aquifer can be effectively remediated by using bioaugmentation with the SDC-9 consortium and pH adjustment. TCE concentrations in the test area decreased by 90 to 100%, and cDCE concentrations decreased by 73 to 99% and were trending downward at the termination of the demonstration project. The production of ethene confirmed complete dehalogenation of the target contaminants and demonstrated the effectiveness of the applied bioaugmentation culture (**Table 5-8, Figures I-1 through I-6, Appendix I**). The CVOC and ethene data indicate that conversion of TCE and cDCE to ethene can exceed 95 percent in the treatment zones.

7.0 COST ASSESSMENT

This section describes the cost performance criteria that were evaluated in completing the economic analysis of the bioaugmentation technology for *in situ* remediation of chlorinated solvents.

7.1 COST MODEL

In order to evaluate the cost of a potential full-scale bioaugmentation remediation program, and compare it against traditional remedial approaches, costs associated with various aspects of the demonstration were tracked throughout the course of the project. **Table 7-1** summarizes the various cost elements and total cost of the demonstration project. The costs have been grouped by categories as recommended in the Federal Remediation Technologies Roundtable Guide to Documenting Cost and Performance for Remediation Projects (FRTR, 1998). Many of the costs shown on this table are a product of the innovative and technology demonstration/validation aspects of this project, and would not be applicable to a full-scale site application. Therefore, as described in subsequent sections, these costs have been excluded or appropriately discounted from the subsequent remedial technology cost analysis and comparison.

Costs associated with the bioaugmentation demonstration at Fort Dix were tracked from July 2006 (site selection) until July 2009 (preparation of the final report and cost and performance report). The total cost of the demonstration was \$786,700, resulting in treatment (>90% reduction of TCE and cDCE) of approximately 900 cubic yards of contaminated aquifer (note: this estimate assumes that treatment would have occurred in the control loop, had 1 liter of SDC-9 culture been added to the loop). This corresponds to a unit cost of approximately \$875 per cubic yard of contaminated aquifer. However, as discussed below, actual remedial costs would be much less for non research/demonstration-oriented projects and/or for sites where significant pH adjustment is not required.

Capital Costs

Capital costs (primarily system design and installation) accounted for \$385,400 (or 49 percent) of the demonstration costs. These costs far exceed what would be expected during a typical remediation project due partially to the following unique cost elements:

- The large number of performance monitoring wells (eleven) installed within the relatively small (30' x 100') demonstration area.
- The installation of extensive data collection processes (such as injection well pressure transducers and the SCADA system) built into the groundwater recirculation and amendment delivery systems.
- The need for design and installation of a buffer injection system that would not be required at most sites. In addition to the system itself (which included 8 tanks and 4 metering pumps), a 40-foot Conex box was required to house the system to prevent freezing during winter months. The Conex box was insulated and included a heating system, ceiling lights, and an electrical panel and outlets. Additionally, each of the four buffer metering pumps had to be tied into the process controls (PLC and SCADA) system located in the neighboring 20-foot Conex.

**Table 7-1
Demonstration Cost Components**

Cost Element	Details	Cost
CAPITAL COSTS		
Groundwater Modeling	Labor	\$18,000
System Design	Labor	\$32,000
Well Installation, Development & Surveying	Labor	\$25,000
	Materials	\$3,800
	Subcontracts (driller/surveyor)	\$63,000
System Installation	Labor	\$42,000
	Equipment & Materials	\$176,000
	Subcontracts (PLC/SCADA)	\$24,000
Travel		\$1,600
Subtotal		\$385,400
OPERATION AND MAINTENANCE COSTS		
Groundwater Sampling (2 baseline & 12 performance monitoring events)	Labor	\$47,700
	Materials	\$5,600
Analytical	In-House Labor	\$48,400
	Outside Lab	\$3,900
System O&M (including testing & start-up)	Labor	\$31,900
	Materials (lactate, buffer, nutrients, consumables)	\$21,000
Bioaugmentation	Labor (fermentation & injection)	\$5,700
Utilities	Electric	\$7,800
Reporting & Data Management	Labor	\$68,000
Travel		\$2,400
Subtotal		\$242,400
OTHER TECHNOLOGY-SPECIFIC COSTS		
Site Selection	Labor & Travel	\$36,800
Site Characterization (direct push investigation, piezometer installations, slug tests, pump tests)	Labor (including in-house analytical)	\$19,500
	Materials	\$2,200
	Subcontractor (driller)	\$13,200
Laboratory Microcosm and Column Testing	Labor (including in-house analytical)	\$44,100
Tracer Testing	Labor (including in-house analytical)	\$13,500
	Materials	\$2,000
IPR Meeting & Reporting	Labor & Travel	\$12,000
Cost and Performance Report	Labor	\$5,500
Guidance Document Sections	Labor	\$10,100
Subtotal		\$158,900
TOTAL COSTS		\$786,700

O&M Costs

Operation and maintenance and reporting costs accounted for \$242,400 (or 31 percent) of the demonstrations cost. These costs consisted primarily of groundwater monitoring (including analytical), systems operation and maintenance, amendments (lactate, buffer, and nutrients), the SDC-9 culture, and reporting costs. Operation and maintenance cost elements unique to this demonstration included:

- Extensive performance monitoring activities, including 15 groundwater sampling events and over 1,200 samples being collected and analyzed over a 15 month period (this does not include tracer testing sampling discussed below).

- Operation and maintenance of the buffer injection system, which included the mixing and injection of 16,600 lbs. of solid buffer (sodium bicarbonate and sodium carbonate).
- The need to redevelop the four injection wells on two separate occasions because the addition of the buffering agents caused fouling of the wells.
- The need to add an additional 108 liters of SDC-9 culture to test loops 2 and 3 because of a severe pH spike that affected microbial activity. Demonstration results indicated that 1 liter of SDC-9 culture, with $\sim 10^{11}$ DHC/L, was sufficient for remedial success in the recirculation loop with the greatest level of contamination because of extensive *in situ* growth of the culture.

Demonstration-Specific Costs

Other demonstration-specific costs (those cost not expected to be incurred during non research/demonstration-oriented remediation projects) accounted for \$158,900 (or 20 percent) of the demonstration cost. These costs included site selection, laboratory and tracer testing, additional demonstration reporting and meeting (IPR) requirements, preparation of a cost and performance report, and preparation of three chapters for publication in an upcoming SERDP/ESTCP-sponsored volume on bioaugmentation for remediation of chlorinated solvents.

7.2 COST DRIVERS

The expected cost drivers for installation and operation of a bioaugmentation groundwater recirculation system for the remediation of chlorinated ethenes, and those that will determine the cost/selection of this technology over other options include the following:

- Depth of the CVOC plume below ground surface
- Width of the CVOC plume
- Thickness of the CVOC plume
- Aquifer lithology and hydrogeology
- Regulations/acceptance of groundwater extraction and re-injection
- Regulatory considerations concerning secondary groundwater contaminants
- Length of time for clean-up (e.g., necessity for accelerated clean-up)
- Concentrations of CVOCs and alternate electron acceptor (e.g., NO_3^- , SO_4^{2-} and O_2)
- Presence of co-contaminants, such as chloroform or chlorinated ethanes
- O&M costs and issues (particularly injection well fouling)

A thorough cost analysis of various *in situ* treatment approaches, including active-pumping systems, passive systems, and active-passive designs is provided in a recent book chapter by Krug et al. (2008). These approaches are compared technically and economically with each other and with *ex situ* treatment under a variety of different contamination scenarios. The reader

is referred to this chapter and others in this volume by Stroo and Ward (2008) for descriptions and economic comparisons of different *in situ* technologies.

The plume characteristics and those of the local aquifer will play an important role in the cost and applicability of a bioaugmentation for groundwater CVOC remediation. For shallow groundwater plumes (< 50 ft bgs) passive *in situ* options, such as installation of a PRB consisting of either injection well or direct-push applied slow-release substrates, is likely to be the most cost effective option. These systems require little O&M after installation, and are not subject to the biofouling issues that impact active pumping designs. However, passive approaches may be less suitable at sites where significant pH adjustment is required, or where secondary reaction concerns (e.g. metals mobilization, sulfate reduction, etc.) exist. Passive approaches utilizing direct-push technologies can also be limited to sites where the target treatment zones are greater than 50 to 100 feet bgs, due to depth restrictions associated with this injection technology. Additionally, effective distribution of bioaugmentation cultures within the subsurface can be considerably slower with passive *in situ* treatment options.

For deeper plumes (e.g. >50 ft. bgs) or those that are very thick, passive approaches are often not technically feasible (e.g., for direct-push injection of passive substrates >100 ft bgs) and/or are cost-prohibitive (e.g., injecting passive substrates at closely spaced intervals to > 50 ft bgs). Active treatment systems may be technically and economically more attractive under these conditions. Active treatment approaches may also be better suited for layered lithologic units or sites where significant pH adjustment is required (such as the MAG-1 Area), as groundwater recirculation improves mixing and distribution of injected amendments within the subsurface. Longer treatment time frames, high contaminant concentrations, and secondary reaction concerns may also present conditions favorable for utilizing an active approach, since electron donor addition and mixing rates can be adjusted more easily than with passive approaches (which often utilize less frequent injection of electron donors at high concentrations). However, active approaches may be limited where re-injection of contaminated water (e.g., extracted groundwater with electron donor added) is either prohibited due to water usage/rights concerns or subject to regulatory injection permits.

Factors such as required clean-up time, contaminant concentrations, and presence of select co-contaminants can also affect costs and technology selection. However, perhaps the most significant long-term O&M cost and obstacle for any active *in situ* pumping systems is well fouling control. During this active treatment project, as well as others that have recently been completed (e.g., Hatzinger and Lippincott, 2009; Hatzinger et al., 2008), control of injection well fouling is a key component of system design and operation. This issue remains a critical technical and economic constraint to active pumping designs for CVOC treatment. Injecting an anti-biofouling agent on a regular basis during this field demonstration could have potentially impacted the results by killing some of the injected SDC-9 culture. Therefore, biofouling mitigation was limited to redevelopment of the injection wells during the demonstration.

Another cost associated with this technology, and a major focus of this demonstration, is the amount of microorganisms required to effectively treat a site. The amount of microorganisms needed depends upon contaminant concentrations, site hydrogeochemical conditions, competition by indigenous microorganisms, the relative concentration of DHC in the

bioaugmentation culture, *in situ* growth, transport, and decay of the bioaugmented culture, and various other site-specific factors including access and shipping costs. In addition, the cost of the bioaugmentation culture is based on vendor selection as commercially available cultures vary in price and DHC concentration and activity. Overall, the results of this demonstration show that several factors affect the amount of DHC-containing bacterial culture needed to facilitate successful *in situ* bioremediation of chlorinated solvents. Most notably, the amount of culture needed is dependant largely on the contaminant concentration and soil properties that affect the attachment and detachment of the added DHC cells. ***Consequently, the impact of DHC dosage on bioaugmentation performance likely will need to be evaluated on a site-by-site basis, and the model developed during this project (Schaefer et al., 2009) can assist in predicting the affect of different cell dosages on in situ performance of the cultures. Efforts are underway to incorporate the model in to widely-used groundwater models so that it is readily accessible to remediation practitioners.***

7.3 COST ANALYSIS

Bioaugmentation for *in situ* treatment of groundwater contaminated with chlorinated ethenes can be used to replace traditional groundwater extraction with above-ground treatment, and discharge or re-injection approaches (pump and treat [P&T]). Bioaugmentation is most often used in situations where biostimulation alone is not a viable alternative because DHC are not present in the aquifer. However, bioaugmentation can also be utilized in situations where biostimulation alone is a viable alternative (because DHC are already present the aquifer), but accelerated clean-up times are preferred/required.

As discussed above, bioaugmentation remedial approaches can be either “Active”, where distribution of amendments and bioaugmented culture is achieved using groundwater recirculation, or “Passive”, where distribution is accomplished via ambient groundwater flow. Active groundwater treatment approaches often involve pairs or groups of injection and extraction wells to recirculate groundwater and effectively distribute injected amendments and culture within the subsurface. Passive treatment approaches generally involve injection of amendments and culture via closely-spaced injection wells or direct-push technology. A carbon source is typically added prior to bioaugmentation or with the bioaugmentation culture in order to promote and maintain the highly reducing, anaerobic conditions and supply carbon needed for *in situ* growth of DHC and degradation of target contaminants. A slow-release carbon source, such as emulsified vegetable oil (EVO) is often utilized with passive treatment approaches to reduce injection frequency.

Cost analyses comparing active bioaugmentation to active biostimulation and pump and treat, and passive bioaugmentation to passive biostimulation are presented in the following subsections.

7.3.1 Active Bioaugmentation, Active Biostimulation and Pump & Treat Comparison

For the purpose of this cost analysis, an active bioaugmentation treatment system (similar to that used in this demonstration) is compared to an active biostimulation system, and to a traditional P&T system. The cost analysis is presented for a typical site, assuming full-scale application.

7.3.1.1 Site Description

Following is the basic site description used for the cost analysis:

- Depth to groundwater is approximately 30 feet bgs
- Depth to base of impacted zone is approximately 50 feet bgs
- Contaminant source area has either been removed, or is no longer a continuing source of contamination to the plume
- Plume dimensions: 160 feet at the point of treatment or capture, and 250 feet long (total treatment volume = 29,629 cubic yards)
- Total CVOC concentrations in treatment area range from ~100 to 3,000 µg/L Lithology consists of fine to medium silty sands from 30-50 feet bgs, underlain by a clay confining unit
- Average hydraulic conductivity value of 1.0×10^{-3} cm/s in silty sand unit
- DHC are present at low concentrations ($<1.0 \times 10^3$ cells.liter)
- Average electron acceptor concentrations:
 - Dissolved Oxygen: 1.5 mg/L
 - Nitrate (as N): 2.5 mg/L
 - Sulfate: 50 mg/L
- Neutral pH: ~ 6.5-7.0 standard units

7.3.1.2 Assumptions: Active Bioaugmentation and Active Biostimulation

Following are the assumptions used for analyzing costs associated with treatment utilizing bioaugmentation with groundwater recirculation:

- 9 extraction wells:
 - 3 rows, 100 feet apart and perpendicular to groundwater flow
 - 3 wells per row at 40-foot centers
 - Each 4-inch well to be completed at a depth of 50 feet bgs, with screen interval from 30 to 50 feet bgs. Well screens to be continuously-wrapped and constructed of stainless steel. Well casing to be constructed of PVC
- 12 injection wells:
 - 3 rows 100 feet apart and perpendicular to groundwater flow
 - 4 wells per row at 40-foot centers
 - Each 4-inch well to be completed at a depth of 50 feet bgs, with screen interval from 30 to 50 feet bgs. Well screens to be continuously-wrapped and constructed of stainless steel. Well casing to be constructed of PVC
- 6 monitoring wells
 - Each 2-inch well to be completed at a depth of 50 feet bgs, with screen interval from 35 to 45 feet bgs. Well screens and casing to be constructed of PVC
- The average pumping rate per well is between 3 and 5 gpm
- Electron donor agent will be sodium lactate
- Recirculation system to consist of the following major components:
 - 9 submersible groundwater extraction pumps and controls
 - Filtration system
 - 1,000-gallon equilibration tank

- Transfer/re-injection pump
- Biofouling mitigation system (chlorine dioxide)
- PLC/SCADA unit with flow and level control for each extraction well
- System controls and amendment delivery system to be housed in Conex box or small temporary structure
- Lactate and nutrient injections to be performed manually once per month
- Groundwater sampling of 6 wells quarterly for the first 5 years, and annually thereafter

Active Bioaugmentation

- System to be operated continuously for 6 months, followed by 12 months of “active/passive operation”
- One bioaugmentation event with 680 liters of SDC-9, obtaining an average aquifer DHC concentration of 1.0×10^7 cells/liter
- Site closure at 15 years

Active Biostimulation

- System to be operated continuously for 6 months, followed by 30 months of “active/passive operation”
- No bioaugmentation performed
- Site closure at 16 years

7.3.1.3 Pump & Treat Assumptions

Following are the assumptions used for analyzing costs associated with treatment utilizing P&T:

- 6 extraction wells:
 - 1 row perpendicular to groundwater flow
 - Wells at 30-foot centers
 - Each 4-inch well to be completed at a depth of 50 feet bgs, with screen interval from 30 to 50 feet bgs. Well screens to be continuously-wrapped and constructed of stainless steel. Well casing to be constructed of PVC
- 6 monitoring wells
 - Each 2-inch well to be completed at a depth of 50 feet bgs, with screen interval from 35 to 45 feet bgs. Well screens and casing to be constructed of PVC
- The average pumping rate per well is between 8 and 12 gpm
- P&T system to consist of the following major components:
 - 6 submersible groundwater extraction pumps and controls
 - Filtration system
 - Two 1,000-gallon equilibration tanks
 - 3 Transfer pumps
 - Air Stripper
 - 2 liquid-phase granular-activated carbon vessels (1,000 lbs. each)
 - PLC/SCADA unit with flow and level control for each extraction well
- Permanent structure to be constructed to house system
- Carbon change-outs to be performed every 6 months
- Discharge to sanitary sewer
- System to be operated continuously for 30 years
- Groundwater sampling of 6 wells quarterly for the first 5 years, and annually thereafter

- Monthly effluent sampling/reporting
- Site closure at 30 years

7.3.1.4 Active Bioaugmentation Cost Analysis

Table 7-2 shows the estimated capital costs, operations and maintenance (O&M) costs and long-term monitoring costs for implementation of bioaugmentation with active groundwater recirculation under the base case. The net present value (NPV) of 2.7 percent (Whitehouse Office of Management & Budget, 2009) for O&M and monitoring costs was utilized in the cost estimates. The capital costs and NPV of the other O&M and monitoring costs provides the respective life-cycle costs adjusted to take into account the time value of money.

The costing has been developed for the base case conditions using assumptions described previously, and is based on operating the groundwater recirculation system continuously for 6 months, followed by 12 months of “active/ passive operation” (groundwater recirculation approximately 50 percent of the time), and adding electron donor manually once per month. The estimated 18 months of operation in the estimate is conservative, considering remedial objectives were largely achieved during the demonstration with less than 1 year of system operation. The estimate for this alternative also assumes that site closer can be attained within 15 years.

The capital cost including design, installation of wells, installation of the downhole and above grade equipment and controls, and system start up and testing is approximately \$683,500 and the NPV of the O&M totals an additional \$422,714 of costs over 18 months of operation. The O&M costs include the costs for labor for system O&M, costs for equipment repair and replacement and cost for electron donor. O&M costs also include \$51,000 for 680 liters of SDC-9 culture (cell density = 1.0×10^{11} cells/liter) at the GSA-approved price of \$75.00 per liter. The NPV of the long term monitoring costs is estimated to be \$492,552 resulting in a total lifecycle cost for this alternative of \$1,598,765 (**Table 7-2**).

7.3.1.5 Active Biostimulation Cost Analysis

Table 7-3 shows the estimated capital costs, operations and maintenance (O&M) costs and long-term monitoring costs for implementation of biostimulation only with active groundwater recirculation under the base case. The net present value (NPV) of the O&M and monitoring costs is also included.

The costing has been developed for the base case conditions using assumptions described previously, and is based on operating the groundwater recirculation system continuously for 6 months, followed by 24 months of “active/passive operation”, and adding electron donor manually once per month. The costing assumes an additional 12 months of active/passive operation (over the 18 months used in the bioaugmentation cost estimate) to obtain the same DHC cell density and degradation kinetics observed in the bioaugmentation case study. The estimate for this alternative also assumes that site closer can be attained within 16 years.

The capital cost including design, installation of wells, installation of the downhole and above grade equipment and controls, and system start up and testing is approximately \$683,500 and the NPV of the O&M totals an additional \$611,941 of costs over 30 months of operation. The O&M costs include the costs for labor for system O&M, costs for equipment repair and replacement and cost for electron donor. The NPV of the long term monitoring costs is estimated to be \$505,963 resulting in a total lifecycle cost for this alternative of \$1,801,404 (**Table 7-3**).

**Table 7-2
Cost Components for In Situ Bioaugmentation with Groundwater Recirculation**

	Year Cost is Incurred										NPV of Costs*	
	1	2	3	4	5	6	7	8	9	10 - 16		
CAPITAL COSTS												
System Design	95,000	-	-	-	-	-	-	-	-	-	-	95,000
Well Installation	234,000	-	-	-	-	-	-	-	-	-	-	234,000
System Installation	344,500	-	-	-	-	-	-	-	-	-	-	344,500
Start-up and Testing	10,000	-	-	-	-	-	-	-	-	-	-	10,000
SUBCOST (\$)	683,500	-	-	-	-	-	-	-	-	-	-	683,500
OPERATION AND MAINTENANCE COSTS												
System Operation and Maintenance	301,000	125,000	-	-	-	-	-	-	-	-	-	422,714
SUBCOST (\$)	301,000	125,000	0	0	0	0	0	0	0	0	0	422,714
LONG TERM MONITORING COSTS												
Sampling/Analysis/Reporting	71,000	71,000	71,000	71,000	71,000	20,000	20,000	20,000	20,000	Years 10 - 16 costs same as year 9		492,552
(Quarterly through 5 years then Annually)												
SUBCOST (\$)	71,000	71,000	71,000	71,000	71,000	20,000	20,000	20,000	20,000	Same		492,552
TOTAL COST (\$)	1,055,500	196,000	71,000	71,000	71,000	20,000	20,000	20,000	20,000	Repeat 9		1,598,765

Notes:

NPV - Net Present Value

* - NPV calculated based on a 2.7% discount rate

**Table 7-3
Cost Components for In Situ Biostimulation with Groundwater Recirculation**

	Year Cost is Incurred										NPV of Costs*	
	1	2	3	4	5	6	7	8	9	10 - 15		
CAPITAL COSTS												
System Design	95,000	-	-	-	-	-	-	-	-	-	-	95,000
Well Installation	234,000	-	-	-	-	-	-	-	-	-	-	234,000
System Installation	344,500	-	-	-	-	-	-	-	-	-	-	344,500
Start-up and Testing	10,000	-	-	-	-	-	-	-	-	-	-	10,000
SUBCOST (\$)	683,500	-	-	-	-	-	-	-	-	-	-	683,500
OPERATION AND MAINTENANCE COSTS												
System Operation and Maintenance	250,000	250,000	125,000	-	-	-	-	-	-	-	-	611,941
SUBCOST (\$)	250,000	250,000	125,000	0	0	0	0	0	0	0	0	611,941
LONG TERM MONITORING COSTS												
Sampling/Analysis/Reporting	71,000	71,000	71,000	71,000	71,000	20,000	20,000	20,000	20,000	Years 10 - 15 costs same as year 9		505,963
(Quarterly through 5 years then Annually)												
SUBCOST (\$)	71,000	71,000	71,000	71,000	71,000	20,000	20,000	20,000	20,000	Same		505,963
TOTAL COST (\$)	1,004,500	321,000	196,000	71,000	71,000	20,000	20,000	20,000	20,000	Repeat 9		1,801,404

Notes:

NPV - Net Present Value

* - NPV calculated based on a 2.7% discount rate

7.3.1.6 Pump & Treat Cost Analysis

Table 7-4 shows the estimated capital costs, operations and maintenance (O&M) costs and long-term monitoring costs for implementation of the P&T under the base case. The net present value (NPV) of the O&M and monitoring costs is also included. The costing has been developed for the base case conditions using assumptions described previously, and is based on operating the groundwater recirculation system and performing long term monitoring for 30 years.

The capital cost including design, installation of wells, installation of the downhole and above grade equipment and controls, and system start up and testing is approximately \$686,500 and the NPV of the O&M totals an additional \$4,369,539 of costs over 30 years of operation. The O&M costs include the costs for labor for system O&M, costs for equipment repair and replacement and carbon change-outs. The NPV of the long term monitoring costs is estimated to be \$705,821 resulting in a total lifecycle cost for this alternative of \$5,761,860 (**Table 7-4**).

7.3.1.7 Active Treatment Cost Comparison

The comparison of the cost analysis for the three remedial scenarios provided above indicates that bioaugmentation with active groundwater recirculation is the least costly and fastest remedial approach for the base case. Even with the estimated \$51,000 additional cost of the bioaugmentation culture, bioaugmentation provides an estimated cost savings of approximately \$203,000 over the biostimulation-only approach. The higher cost of the biostimulation-only approach is due to the need to operate the groundwater recirculation system and add amendments for an additional 12 month period. This additional treatment time would be required because of the reduced biodegradation kinetics associated with this approach.

The bioaugmentation approach provides a cost saving of approximately \$4,163,000 over that of the pump and treat approach (approximately one-third of the cost). In addition to the cost savings, the bioaugmentation approach provides treatment of the entire contaminated zone within three years, while the P&T approach only provides capture of contaminants at the downgradient edge of the plume over a 30 year period. Therefore, the bioaugmentation option provides both faster and more complete remediation of the target zone.

The capital costs associated with all three technologies are almost identical (**Tables 7-2 through 7-4**). However, because the P&T system requires 30 years of continuous operation, the O&M costs and long term monitoring costs are significantly higher than that of the bioaugmentation option (which requires only 3 years of operation). Additionally, the P&T option requires 30 years of long term monitoring (including monitoring of system effluent for compliance with discharge permits) compared to 15 years of monitoring for the bioaugmentation option. It should be noted that even if the bioaugmentation option required 30 years of long term monitoring, the additional NPV of these costs would total less than \$270,000, which would still make the cost of the bioaugmentation approach considerably less than the P&T approach.

7.3.2 Passive Bioaugmentation and Passive Biostimulation Comparison

For the purpose of this cost analysis, a passive bioaugmentation treatment approach is compared to a passive biostimulation approach at three different scales; ¼-acre, 1-acre, and 3-acres. Two SDC-9 dosages (obtaining average aquifer DHC concentrations of 1.0×10^6 and 1.0×10^7

**Table 7-4
Cost Components for Pump and Treat**

	Year Cost is Incurred									NPV of Costs*	
	1	2	3	4	5	6	7	7 - 30	10, 15, 20, 25, 30		
CAPITAL COSTS											
System Design	105,000	-	-	-	-	-	-	-	-	-	105,000
Well Installation	103,500	-	-	-	-	-	-	-	-	-	103,500
System Installation	468,000	-	-	-	-	-	-	-	-	-	468,000
Start-up and Testing	10,000	-	-	-	-	-	-	-	-	-	10,000
SUBCOST (\$)	686,500	-	-	-	-	-	-	-	-	-	686,500
OPERATION AND MAINTENANCE COSTS											
System Operation and Maintenance	204,000	204,000	204,000	204,000	229,000	204,000	204,000	Repeat \$204,000 annually through year 30	Add \$25,000 for non-routine O&M and well rehab in each yr listed above		4,369,539
SUBCOST (\$)	204,000	204,000	204,000	204,000	229,000	204,000	204,000				4,369,539
LONG TERM MONITORING COSTS											
Sampling/Analysis/Reporting (Quarterly through 5 years then Annually)	72,000	72,000	72,000	72,000	72,000	22,500	22,500	Years 8 - 30 costs same as year 7			705,821
SUBCOST (\$)	72,000	72,000	72,000	72,000	72,000	22,500	22,500	Same	Same		705,821
TOTAL COST (\$)	962,500	276,000	276,000	276,000	301,000	226,500	226,500				5,761,860

Notes:

NPV - Net Present Value

* - NPV calculated based on a 2.7% discount rate

cells/liter) for the bioaugmentation approach and two biostimulation injection strategies are also compared at each scale. The cost analysis is presented for a typical site, assuming full-scale application.

7.3.2.1 Site Description

Following is the basic site description used for the cost analysis:

- Depth to groundwater is approximately 15 feet bgs
- Depth to base of impacted zone is approximately 25 feet bgs
- Contaminant source area has either been removed, or is no longer a continuing source of contamination to the plume
- Treatment areas: ¼-acre, 1-acre, and 3-acres (total treatment volumes = 4,033, 16,133, and 48,400 cubic yards, respectively)
- Total CVOC concentrations in treatment area range from ~100 to 3,000 µg/L (“DCE stall” observed)
- Lithology consists of fine to medium silty sands from 15-25 feet bgs, underlain by a clay confining unit
- Average hydraulic conductivity value of 1.0×10^{-3} cm/s in silty sand unit
- DHC are present at low concentrations ($<1.0 \times 10^3$ cells.liter)
- Average electron acceptor concentrations:
 - Dissolved Oxygen: 1.5 mg/L
 - Nitrate (as N): 2.5 mg/L
 - Sulfate: 50 mg/L
- Neutral pH: ~ 6.5-7.0 standard units

7.3.2.2 Assumptions

Following are the assumptions used for analyzing costs associated with treatment utilizing passive bioaugmentation and biostimulation:

- Effective injection radius of influence = 10 feet
- Direct-push points used for injection of emulsified vegetable oil (EVO), nutrients, and SDC-9 culture (with the bioaugmentation approach):
 - Three 3-foot injection intervals per point
 - Simultaneous injection at 6-8 points at a time
 - Average injection rate = 3 gpm per point
- 3 monitoring wells for the ¼-acre scenario, 4 monitoring wells for the 1-acre scenario, and 6 monitoring wells for the 3-acre scenario
 - Each 2-inch well to be completed at a depth of 25 feet bgs, with screen interval from 15 to 25 feet bgs. Well screens and casing to be constructed of PVC
- Groundwater sampling of all wells quarterly for the first 5 years, and annually thereafter

Passive Bioaugmentation

- One initial injection of EVO and nutrients required to establish reducing conditions
 - 15% of treatment pore volume injected
- A second injection consisting of SDC-9 culture and additional nutrients:
 - 3% of treatment zone pore volume injected (“seeding” with SDC-9 culture)
- Site closure at 15 years with the higher DHC dosage, and 16 years with the lower dosage

Case #1

- One direct-push bioaugmentation event with SDC-9, obtaining average aquifer DHC concentrations of 1.0×10^7

Case #2

- One direct-push bioaugmentation event with SDC-9, obtaining average aquifer DHC concentrations of 1.0×10^6

Passive Biostimulation

- No bioaugmentation performed
- Site closure at 18 years

Case #1

- Two direct-push injections of EVO and nutrients:
 - 15% of treatment zone pore volume injected
 - Second injection required at beginning of year 3

Case #2

- One direct-push injections of EVO and nutrients:
 - 15% of treatment zone pore volume injected
 - 50% more EVO and nutrients injected to extend active treatment to 4 years

7.3.2.3 Passive Bioaugmentation Cost Analysis

Table 7-5 shows the estimated capital costs, injection costs and long-term monitoring costs for implementation of passive bioaugmentation utilizing direct-push injections under the three scenarios discussed above. It was assumed that capital costs and injection costs were incurred during the first year of the project. The net present value (NPV) of 2.7 percent (Whitehouse Office of Management & Budget, 2009) for monitoring costs was utilized in the cost estimates. The costing has been developed for the base case conditions using assumptions described previously, and is based on one round of amendment injections (EVO and nutrients) and one round of bioaugmentation injections.

The capital costs include design, work plan preparation, groundwater modeling, and installation of monitoring wells. Capital costs are the same for both DHC dosage cases under each of the three treatment scenarios (e.g., ¼-acre, 1 acre, and 3 acres), respectively. The injection costs include the costs for injection labor, the direct-push injection subcontractor, rental equipment, and EVO, nutrients and the SDC-9 culture. The difference in injection costs between the two DHC dosage cases is the cost associated with the SDC-9 bioaugmentation culture (at the GSA-approved price of \$75.00 per liter). The NPV of the long term monitoring costs was estimated based on a 15-year lifecycle for the higher DHC dosage case and a 16-year lifecycle for the lower DHC dosage case (**Table 7-5**). Faster degradation kinetics, and thus faster site closure, were assumed with the higher DHC dosage because the contaminant concentration is the same in each scenario.

7.3.2.4 Passive Biostimulation Cost Analysis

Table 7-5 shows the estimated capital costs, injection costs and long-term monitoring costs for implementation of passive biostimulation utilizing direct-push injections under the three scenarios discussed above. It was assumed that capital costs were incurred during the first year

Table 7-5
Summary of Passive Bioremediation Cost Comparison

Treatment Area	1/4 Acre				1 Acre				3 Acres			
	Bioaug. DHC=10E7	Bioaug. DHC=10E6	Biostim. 2 Injections	Biostim. 1 Injection	Bioaug. DHC=10E7	Bioaug. DHC=10E6	Biostim. 2 Injections	Biostim. 1 Injection	Bioaug. DHC=10E7	Bioaug. DHC=10E6	Biostim. 2 Injections	Biostim. 1 Injection
Capital Costs (\$)	111,500	111,500	111,500	111,500	128,100	128,100	128,100	128,100	154,200	154,200	154,200	154,200
Injection Costs (\$)	104,100	97,900	164,200	97,500	303,400	278,300	474,400	280,500	804,700	729,400	1,230,000	725,000
Long Term Monitoring Costs (\$)	392,600	403,300	424,000	424,000	457,800	470,300	494,400	494,400	579,100	594,900	625,100	625,100
Total Cost (\$)	608,200	612,700	699,700	633,000	889,300	876,700	1,096,900	903,000	1,538,000	1,478,500	2,009,300	1,504,300

Notes:

-Cost estimates rounded to nearest hundred dollars.

-Shaded totals are lowest cost approach for each size treatment area.

of the project. Costing for two injection scenarios (2 rounds of amendment injections, and one round of amendment injections at higher concentrations) have been developed for the base case conditions using assumptions described previously. Injection costs were incurred during the first year of the project for the single-injection scenario, and during years 1 and 3 during the two-injection scenario. The net present value (NPV) of 2.7 percent (Whitehouse Office of Management & Budget, 2009) for monitoring costs and the second injection was utilized in the cost estimates.

The capital costs include design, work plan preparation, groundwater modeling, and installation of monitoring wells. Capital costs are the same for both injection cases under each of the three treatment scenarios (e.g., ¼-acre, 1 acre, and 3 acres), respectively. The injection costs include the costs for injection labor, the direct-push injection subcontractor, rental equipment, and EVO and nutrients. The difference in injection costs between the two injection scenarios is the cost associated with a second direct-push injection (at the beginning of year 3) and additional amendments. The NPV of the long term monitoring costs was estimated based on a 18-year lifecycle for both injection cases (**Table 7-5**). The same degradation kinetics were assumed with both cases.

7.3.2.5 Passive Treatment Cost Comparison

The comparison of the cost analysis for the three passive remedial scenarios provided above indicates that bioaugmentation is the fastest remedial approach for the three base cases (**Table 7-5**). However, the most cost effective bioaugmentation approach (i.e., which DHC dosage to use) depends on the scale of the project. The higher DHC dosage approach provides a lower cost alternative to the lower DHC dosage approach (and both biostimulation approaches) for the ¼-acre treatment scenario. However, the lower DHC dosage approach provides a lower cost alternative to the higher DHC dosage approach for the larger 1-acre and 3-acre treatment scenarios. This is largely due to the fact that the cost associated with the addition bioaugmentation culture for the larger treatment areas outweigh the cost of 1 year of additional long term monitoring for the larger scale projects discussed above. Therefore, treatment times should be weighed against the costs associated with the different dosages when evaluating treatment approaches.

For the ¼-acre treatment scenario, the higher DHC dosage approach provides a cost savings of approximately \$4,500 over the lower dosage approach, \$91,500 over the 2-injection biostimulation approach, and \$24,800 over the 1-injection biostimulation approach. For the 1-acre treatment scenario, the lower DHC dosage approach provides a cost savings of approximately \$12,600 over the higher dosage approach, \$220,200 over the 2-injection biostimulation approach, and \$26,300 over the 1-injection biostimulation approach. Finally, for the 3-acre treatment scenario, the lower DHC dosage approach provides a cost savings of approximately \$59,500 over the higher dosage approach, \$530,800 over the 2-injection biostimulation approach, and \$25,800 over the 1-injection biostimulation approach. Based on these estimates, a biostimulation-only approach utilizing one injection could potentially be more cost effective at treatment scales greater than 3 acres. It should be noted that the biostimulation-only approach assumes that DHC are present at the site, and capable of being stimulated *in situ* to a cell density high enough (approximately 10^7 cells/liter) for effective dechlorination of target CVOCs. Additionally, the single injection biostimulation approach assumes that the injected

amendments last and don't migrate from the treatment zone before remediation is complete. The need for a second biostimulation injection would make the cost of biostimulation significantly higher than that of either of the bioaugmentation approaches.

It should be noted that the conclusions discussed above were derived from the base case scenarios, and should not be extrapolated to all sites without first performing adequate pre-design activities and cost comparisons. Treatability testing, pilot testing, and groundwater modeling should be used to determine the optimal approach for each site. The approach should take into account remedial goals (such as treatment duration) and cost effectiveness. The cost drivers discussed in **Section 7.2** also need to be considered. ***Consequently, the impact of DHC dosage on bioaugmentation performance likely will need to be evaluated on a site-by-site basis, and the model developed during this project (Schaefer et al., 2009) can assist in predicting the affect of different cell dosages on in situ performance and expected treatment times.***

The Cost of Not Bioaugmenting

To estimate a typical cost for bioaugmentation, we analyzed 40 bioaugmentation applications performed by Shaw Environmental, Inc. with the SDC-9 culture at DoD sites throughout the United States. The treated sites varied widely in the dimension and thickness of the treated area, contaminant concentration, hydrogeology, and remedial goals. The average volume of aquifer treated was 28,667 m³. The average volume of culture applied was 115 L. Using Shaw's 2009 GSA-approved price for SDC-9 of \$75/L, the average cost for bioaugmentation culture at these sites was \$8,625 or \$0.30/m³ of treated aquifer. Assuming an average commercial culture cost of \$150 to \$300 per liter, the average cost of culture for these projects on a commercial site would have been \$17,250 to \$34,500, or an equivalent of \$0.60 to \$1.20/m³ of treated aquifer.

The cost of bioaugmentation should be compared to the potential cost of not bioaugmenting. It is often assumed that bioaugmentation is costly, and that the time saved by bioaugmentation may not be significant in the absence of a regulatory driver forcing the early clean up of the site. That is, a typical response is, "If we don't bioaugment the site, we just have to monitor for a little longer". It is worthwhile then to evaluate the cost of the additional monitoring relative to the cost of bioaugmentation and an expected more rapid site closure. If you factor in the cost of re-injecting electron donor, permit renewals, system O&M, meetings with regulators, and other typical consulting costs, the real cost of additional years of treatment and monitoring are likely to be much greater than the cost of bioaugmentation.

8.0 IMPLEMENTATION ISSUES

The primary end-users of this technology are expected to be DoD site managers and contractors, environmental engineers and consultants, as well as other stakeholders. The general concerns of these end users include technology applicability under local site conditions, technology performance, technology scale-up, and technology cost. The expected cost drivers for installation and operation of a bioaugmentation groundwater recirculation system for the remediation of chlorinated ethenes, and those that will determine the cost/selection of this technology over other options are provided in **Section 7**. Scale-up of this technology has been performed at several hundred sites, and follows standard design practices, with required equipment generally being commercially available off-the-shelf. DHC-containing bacterial cultures are readily available from Shaw Environmental, Inc. (609-895-5350) and several other vendors.

The results of this project demonstrated that CVOCs in a low pH aquifer can be effectively remediated by using active groundwater recirculation, bioaugmentation with the SDC-9 consortium, and pH adjustment. The CVOC and ethene data indicate that conversion of TCE and cDCE to ethene can exceed 95 percent in the treatment zones. Results of this field demonstration have provided a detailed evaluation of the use of a groundwater recirculation design for the distribution of groundwater amendments (including a TCE-degrading microbial culture), use of buffering agents to control in situ pH, and an application model to allow practitioners to plan bioaugmentation applications and predict their performance. As such, critical design and implementation issues regarding microbial dosage requirements, remedial timeframes, and system optimization have been addressed and are being made available to environmental professionals and stakeholders.

The results of the demonstration were used to develop, evaluate and refine a one-dimensional bioaugmentation fate and transport screening model (Schaefer et al., 2009; **Appendix C**). The model developed during this project provided a reasonable prediction of the data generated during the field demonstration. The ability to predict results suggests that modeling potentially can serve as an effective tool for determining bioaugmentation dosage and predicting overall remedial timeframes, thus providing the more efficient and less expensive approaches for treating CVOC contaminated groundwater.

While the results of this demonstration showed that (for the range of DHC dosages tested) bioaugmentation performance was not substantially impacted by DHC dosage, these results should not be readily extrapolated to diverse field scale bioaugmentation scenarios. Groundwater flow velocity, contaminant concentration and longevity, and heterogeneity of subsurface conditions can impact the relevant importance of DHC dosage on bioaugmentation effectiveness. In addition, as observed during performance of model simulations, a DHC attachment-detachment factor plays a significant role in determining the relative importance of DHC dosage on bioaugmentation kinetics (Schaefer et al., 2009). Thus, the impact of DHC dosage on bioaugmentation performance likely will need to be evaluated on a site-by-site basis, but the model developed during this project can assist in predicting the affect of different cell dosages on in situ performance of the cultures.

The two major challenges encountered during the demonstration were pH adjustment of the aquifer, and injection well fouling.

pH Adjustment

Increasing and maintaining pH levels within the recirculation loops was challenging. pH was increased from generally below 5.0 to between 6.0 and 7.1 standard units, except at injection wells where pH levels were often greater than 9.0 standard units due to the injection of sodium carbonate. The pH levels sometimes dropped below 5.5 (the level at which dechlorination rates drop significantly) in some of the wells during periods of the demonstration. Despite preliminary laboratory testing, sodium bicarbonate was determined to be too weak to increase aquifer pH. Therefore, the buffer used was changed to sodium carbonate (a stronger buffer) to more effectively increase pH within the aquifer. Additionally, two bulk injections of sodium carbonate were needed (a total of 250 lbs. per well) to further elevate groundwater pH values that still largely remained below 5.5 standard units after several weeks of system operation. A total of 7,000 lbs. of sodium bicarbonate and 9,600 lbs. of sodium carbonate (including the bulk injections) were injected into the four Loops during the 12 months of system operation. When pH levels were maintained above 5.5 standard units and the bioaugmentation injections were performed at wells with a neutral pH (i.e. monitoring wells downgradient of the amendment injection wells), complete dechlorination of TCE to ethene was observed.

Well Fouling

As with many *in situ* treatment approaches, both biological and non-biological, fouling and plugging of the injection well screens can be a significant concern. During this demonstration, well fouling appeared to be occurring from an accumulation of carbonate and insoluble complexes (most likely iron sulfides and iron carbonates, as discussed in **Section 5.6.4**) within the well screen, sandpack and the immediate surrounding formation. While the buffer used for pH adjustment was in solution during injection, the cumulative effect of continuous injections, high pH at the injection wells, and interactions with metals likely lead to this precipitation. Precipitated metals were observed during well redevelopment, and on system piping, components, and filter cartridges during the demonstration.

The accumulation of biomass did not appear to be a major cause of well fouling. This is most likely due to the fact that injection well pH levels were often too high (generally >9 standard units) because of our buffering efforts for significant biological growth to occur. However, for sites with more neutral pH levels, biofouling of active recirculation systems can become a significant O&M issue and cost.

The most effective and economical solution for biofouling control with active systems involves multiple approaches, including selection of electron donor, dosing regimen of electron donor, biocide application, water filtration, and system pumping operation. Based on experience from this demonstration and others, the best operational approach to control fouling and minimize O&M costs associated with this issue includes the following:

- “Active-passive” rather than continuous operation
- Infrequent, high concentration dosing of electron donor during active phase

- Selection of an acidic electron donor to assist in biofouling control. Citric acid is optimal as it serves as an acid and a metal chelating agent
- Daily application of chlorine dioxide or other fouling control chemicals
- Installation of a filtration system to remove biomass from between the extraction wells and the injection wells

These approaches were proven to be effective in a recent demonstration for bioremediation of perchlorate at the former Whitaker-Bermite facility in California (Hatzinger and Lippincott, 2009). Biofouling was significantly controlled in the groundwater extraction-reinjection system throughout the 6-month demonstration period by implementing the approaches described above. However, because the primary goals of this field demonstration were to evaluate the amount of culture needed to effectively remediate a CVOC-contaminated plume, and to determine the effect of inoculum dose on remedial time, the injection of an anti-biofouling agent on a regular basis could have potentially impacted the results by killing some of the injected SDC-9 culture. Therefore, biofouling mitigation was limited to installation of a filtration system, “active-passive” operation, and the redevelopment of the injection wells during the demonstration. Additionally, the use of an acidic electron donor to assist in biofouling control was not an option because of the low pH of aquifer and the need for upward pH adjustment.

9.0 REFERENCES

- ABB-ES. 1997. Final Remedial Investigation Report MAG-1 Area. April 1997.
- Bouwer, E. J., 1994, "Bioremediation of Chlorinated Solvents using Alternative Electron Acceptors," Handbook of Bioremediation, Norris, R. D., R. E. Hincbee, R. Brown, P. L. McCarty, L. Semprini, J. T. Wilson, D. H. Kampbell, M. Reinhard, E. J. Bouwer, R. C. Borden, T. M. Vogel, J. M. Thomas, and C. H. Ward, eds., Lewis Publishers, Boca Raton.
- Clement, T.P., 1997. A Modular Computer Code for Simulating Reactive Multispecies Transport in 3-Dimensional Groundwater Systems (RT3D). Prepared for U.S. Department of Energy, Pacific Northwest National Laboratory, Richland, Washington. PNNL-SA-11720.
- Dames & Moore. 1992. Interim Phase I Remedial Investigation Report, Fort Dix, NJ. January 1993.
- Dames & Moore. 1993. Interim Phase II Remedial Investigation Report, Fort Dix, NJ. Volume II and III. April 1993.
- Dragun, J., 1998. The Soil Chemistry of Hazardous Materials-2nd Edition. Amherst Scientific Publishers.
- Duhamel, M., S. Wehr, L. Yu, H. Rizvi, D. Seepersad, S. Dworatzek, E. E. Cox, and E. A. Edwards. 2002. Comparison of anaerobic dechlorinating enrichment cultures maintained on tetrachloroethene, trichloroethene, *cis*-dichloroethene and vinyl chloride. *Water Res.* 36:4193-4202.
- Ellis, D.E., E.J. Lutz, J.M. Odom, R.J. Buchanan, C.L. Bartlett, M.D. Lee, M.R. Harkness, and K.A. Deweerdt, 2000, "Bioaugmentation for Accelerated *In Situ* Anaerobic Bioremediation," *Environmental Science and Technology*, Vol. 34:2254-2260.
- Grosterm, A., and E. A. Edwards. 2006. A 1,1,1-trichloroethane-degrading anaerobic mixed microbial culture enhances biotransformation of mixtures of chlorinated ethenes and ethanes. *Appl. Environ. Microbiol.* 72:7849-7856.
- Hatzinger, P.B. and D. Lippincott. 2009. Technology Demonstration Summary Report: In Situ Bioremediation of Perchlorate in Area 11 Alluvium Groundwater. US Army Corps of Engineers Final Project Report. 121 pp.
- Hatzinger, P.B., C. E. Schaefer, and E.E. Cox. 2008. Active Bioremediation. *In In Situ Bioremediation of Perchlorate*. H Stroo and C.H. Ward. (Ed.). Springer, New York. pp. 91-131.
- He, J., K.M. Ritalahti, K.L. Yang, S.S. Koenigsberg, and F.E. Loeffler, 2003, "Detoxification of Vinyl Chloride to Ethene Coupled to Growth of an Anaerobic Bacterium," *Nature*, 424:62-65).

- Hendrickson, E.R., J.A. Payne, R.M. Young, M.G. Starr, M.P. Perry, S. Fahnestock, D.E. Ellis, and R.C. Ebersole, 2002, "Molecular Analysis of Dehalococcoides 16S Ribosomal DNA from Chloroethene-Contaminated Sites throughout North America and Europe," *Applied and Environmental Microbiology*, Vol. 68:485-495.
- Krug, T.A., and E.E. Cox. 2008. Semi-Passive In situ Bioremediation. *In In Situ Bioremediation of Perchlorate*. H.F. Stroo and C. H. Ward. (Ed.). Springer, New York. pp. 135-154.
- Lendvay, J.M., F.E. Löffler, M. Dollhopf, M.R. Aiello, G. Daniels, B.Z. Fathepure, M. Gebhard, R. Heine, R. Helton, J. Shi, R. Krajmalnik-Brown, C.L. Major, Jr., M.J. Barcelona, E. Petrovskis, R. Hickey, J.M. Tiedje, and P. Adriaens, 2003, "Bioreactive Barriers: A Comparison of Bioaugmentation and Biostimulation for Chlorinated Solvent Remediation," *Environmental Science and Technology*, Vol. 37:1422-1431.
- Lu X, JT Wilson, DH Kampbell. 2006. Relationship between *Dehalococcoides* DNA in ground water and rates of reductive dechlorination at field scale. *Water Res* 40:3131-3140.
- Major, D.W., M.L. McMaster, E.E. Cox, E.A. Edwards, S.M. Dworatzek, E.R. Hendrickson, M.G. Starr, J.A. Payne, and L.W. Buonamici, 2002, "Field Demonstration of Successful Bioaugmentation to Achieve Dechlorination of Tetrachloroethene to Ethene," *Environmental Science and Technology*, Vol. 36:5106-5116.
- Maymo-Gatell, E., Nijenhuis, I., and Zinder, S., 2001, "Reductive Dechlorination of cis-1,2-dichloroethene and Vinyl Chloride by *Dehalococcoides ethenogenes*." *Environmental Science and Technology*, 35(3): 516:521.
- Maymo-Gatell, X., Y. Chien, J.M. Gossett, and S.H. Zinder, 1997, "Isolation of a Bacterium That Reductively Dechlorinates Tetrachloroethene to Ethene." *Science*, Volume 276, 1568-1571.
- McCarty, P. L. 1997. Breathing with chlorinated solvents. *Science* 276:1521-1522.
- Mohn, W. W., and J. M. Tiedje, 1992, "Microbial Reductive Dehalogenation," *Microbiological Reviews*, 56(3): 482-507.
- New Jersey Department of Environmental Protection (NJDEP). 2008. Ground Water Quality Standards. N.J.A.C. 7:9C.
- New Jersey Department of Environmental Protection (NJDEP). 2005. Field Sampling Procedures Manual.
- Schaefer, S.E., C.W. Condee, S. Vainberg, R.J Steffan. 2009. "Bioaugmentation for Chlorinated Ethenes Using *Dehalococcoides* sp.: Comparison Between Batch and Column Experiments." *Chemosphere*.
- Stroo, H., and C.H. Ward (Eds). 2008. *In Situ Bioremediation of Perchlorate in Groundwater*. Springer, New York. 248 pp.

- United States Environmental Protection Agency (USEPA). 2009. National Primary Drinking Water Regulations. 816-F-09-004. www.epa.gov/safewater.
- United States Environmental Protection Agency (USEPA). 1991. Management of Investigation-Derived Wastes During Site Inspections.
- United States Geological Survey. (USGS). 1996. MODFLOW Version 2.6, Open-File Report 96-364.
- Vainberg, S., C.W. Condee, R.J Steffan. "Large-Scale Production of Bacterial Consortia for Remediation of Chlorinated Solvent-Contaminated Groundwater". *Journal of Industrial Microbiology and Biotechnology*, in press.
- Westrick, J.J., Mello, J.W., Thomas, R.F. 1984. The groundwater supply survey. *J. Am. Water Works Assoc.* 76: 52-59.
- Whitehouse Office of Management & Budget. 2009. www.whitehouse.gov/omb/circulars/a094/a94_appx-c.html.

APPENDICES

APPENDIX A
Points of Contact

Points of Contact

POINT OF CONTACT Name	ORGANIZATION Name Address	Phone Fax E-mail	Role in Project
Robert Steffan, Ph.D.	Shaw Environmental 17 Princess Rd. Lawrenceville, NJ 08648	609-895-5350 809-895-1885 rob.steffan@shawgrp.com	Principal Investigator
David Lippincott, P.G.	Shaw Environmental 17 Princess Rd. Lawrenceville, NJ 08648	609-895-5380 609-895-1858 david.lippincott@shawgrp.com	Project Geologist
Charles Schaefer, Ph.D.	Shaw Environmental 17 Princess Rd. Lawrenceville, NJ 08648	609-895-5372 609-895-1858 charles.schaefer@shawgrp.com	Project Engineer
Nancy Ruiz, Ph.D.	Naval Facilities Command Engineering Service Center (NAVFAC ESC), Restoration Development Branch, ESC 411, 1100 23 rd Avenue, Port Hueneme, CA 93043	805-982-1155; 805-982-4304, nancy.ruiz@navy.mil	COR

APPENDIX B
ESTCP/SERDP Chapter

Chapter 3. Culturing and Handling Bioaugmentation Cultures

Robert J. Steffan and Simon Vainberg

Shaw Environmental, Inc., Lawrenceville, NJ.

3.1 Introduction

Chlorinated ethenes have been used extensively as industrial solvents and cleaning agents, and improper disposal practices and accidental spills have led to them becoming common groundwater contaminants throughout the United States and the world (Moran and Zogorski, 2007; Westrick et al., 1984). Treatment of chlorinated solvent contamination has involved the use of a wide range of technologies including soil vapor extraction, air sparging, chemical oxidation, 6-phase heating, and biological oxidation or reduction. Currently, the most common treatment alternative for these compounds is biological degradation facilitated by either stimulating indigenous dechlorinating organisms or adding cultures of exogenous microorganisms enriched especially for this task. Adding exogenous organisms is commonly referred to as bioaugmentation.

Although the use of bioaugmentation has a long history for treating challenging pollutants, overselling of the technology as a panacea for pollutant remediation and

under-performance of some commercial products led to a period of low acceptability of this technology for remedial activities. In many cases the lack of acceptance of the technology was justified because the addition of microbes to contaminated environments did not improve remediation beyond what could be achieved by stimulating indigenous microbial populations (DeFlaun and Steffan, 2002; Unterman et al., 2000). In the case of remediating chlorinated solvent contaminated aquifers, the technology was challenged by poor transport of the biocatalysts, an inability of the microbes to use the contaminant as a growth substrate, the need to maintain aerobic conditions, the production of toxic intermediates, and the inability to degrade some important solvents (most notably PCE) (Steffan et al. 1999). The early application of *Dehalococcoides spp.*-containing consortia for in situ remediation of chlorinated solvent-contaminated aquifers has led to a renewed interest in bioaugmentation because the added cultures reproduced in situ and were transported well through the treated aquifer (Ellis et al., 2000; Major et al., 2002). The fact that the cultures did not require oxygen to degrade the contaminants made them easy to transport and apply, and only a fermentable carbon source was needed to support their growth and degradative activity. To date, several hundred bioaugmentation applications have been performed to remediate chlorinated solvent contaminated aquifers.

3.1.1 Microbial Cultures used for Bioaugmentation

The predominant biodegradation pathway used for chlorinated ethene remediation in contaminated aquifers is anaerobic reductive dehalogenation. During reductive dechlorination, chlorinated ethenes are used as electron acceptors by naturally adapted

bacteria, and during the process a chlorine atom on the compound is removed and replaced with a hydrogen atom. Sequential dechlorination of perchloroethene (PCE) most commonly proceeds to trichloroethene (TCE), *cis*-1,2-dichloroethene (cDCE), vinyl chloride (VC), and finally the desired end product, ethene. In some bacteria *trans*-1,2-DCE or 1,1-DCE (Zhang et al., 2006) are the predominant TCE dechlorination products. Although biodegradation of chlorinated ethenes can often be performed by naturally occurring microorganisms that use endogenous resources to support contaminant degradation (i.e., intrinsic bioremediation), or nutrients that are purposefully added to support their activity (i.e., biostimulation), some aquifers lack an indigenous microbial population capable of completely dechlorinating the contaminants. This lack of an adequate microbial population capable of completely dechlorinating PCE and TCE to ethene can sometimes lead to the accumulation of cDCE and VC (Hendrickson et al., 2002) which are more toxic than the parent compounds. Consequently, the addition of exogenous organisms (i.e., bioaugmentation) is sometimes used to supplement the indigenous microbial population.

While many dechlorinating microorganisms have been identified, only bacteria of the genus *Dehalococcoides* (DHC) have been shown to completely reduce PCE and TCE to ethene (Maymó-Gatell et al., 1997; He et al., 2003a,b). These organisms use molecular hydrogen as an obligate electron donor and halogenated compounds as obligate respiratory electron acceptors. Acetate is typically used as a carbon source. Studies of field sites have strongly correlated the presence of DHC strains with complete dehalogenation of chlorinated ethenes in situ (Hendrickson et al., 2002). Therefore, microbial cultures used to augment chlorinated solvent contaminated groundwater

contain at least one strain of *Dehalococcoides* sp. A list of some known suppliers of bioaugmentation cultures for chlorinated solvents is presented in Table 1.

Because of the difficulty of growing DHC-type organisms in pure culture (Maymó-Gatell et al., 1999; He et al., 2003a,b), consortia containing DHC, fermentative, and other microbes that support the growth and activity of the DHC strains are used for remedial applications (Ellis et al., 2000; Lendvay et al., 2003; Major et al., 2002). The consortia, and the DHC therein, can be grown (i.e., “fermented”) on a wide range of fermentable carbon sources as a source of H₂ and a chlorinated ethene (typically PCE or TCE) as an electron acceptor.

3.1.2 Why high density fermentation is important

One of the significant challenges of performing bioaugmentation at a commercial scale is the large size of contaminant plumes and the large amount of culture that is potentially needed to facilitate timely and successful remediation. This can be best illustrated by a simple hypothetical example. One acre of land (0.4 ha; 43560 ft²; 4047 m²) is slightly smaller than the size of an American football field including the end zones (57,600 ft²; 5,353 m²). If we assumed that a groundwater plume extended throughout this 1 acre area (300 ft. x 145 ft) and was maintained within a 10 ft saturated thickness, the total volume of the contaminated media would be ~435,000 ft³ (123,000 m³). If the aquifer had an effective porosity of 25%, the total volume of contaminated water in the plume would be 109,000 ft³ (3087 m³; ~3 x 10⁶ L). If our goal was to achieve a final DHC concentration of 10⁷ DHC/L to effectively remediate the site (Lu et al., 2006), we would need 3 x 10¹³ DHC cells. If the fermentation process produced 10⁹ DHC/L (Major

et al., 2002), ~30,000 L of DHC culture would be required. At an arbitrary cost of \$300/L, the culture cost for this moderately-sized plume would be \$9,000,000. Of course, several factors come into play in actual remediation scenarios (Lee et al., 1998). For example, it may be unrealistic to expect even distribution of the DHC across a contaminated aquifer, so we would expect locally higher concentrations of culture, and degradative activity, near injection points. We also may consider constructing a series of in situ flow-through barriers or recirculation systems, depending on the remedial goals, to reduce the amount of culture needed. In addition, if conditions are correct some growth of the culture can be expected in situ. None-the-less, it is apparent that large volumes of culture may be needed to treat some plumes, and production of high cell density cultures can greatly reduce the volume of culture needed for, and the cost of, bioaugmentation treatment. If in situ growth is anticipated, the actual cost of growing these organisms in situ under sub-optimal growth conditions also should be considered.

3.2 Growing inocula

Fermentation options – Batch vs. Continuous

Bacterial fermentation is a mature science, but in practice it is often as much art as science. Ljungdahl and Wiegel (1986) have provided excellent general guidance for fermenting anaerobic bacteria. The production of consistent bioaugmentation cultures for chlorinated solvent remediation, however, presents many unique challenges to practitioners. First, the cultures are consortia, meaning that the success of the fermentation process relies on the maintenance of many different bacterial strains, even some that may not be identified. Likewise, growth of the most essential dehalogenating

populations (e.g., *Dehalococcoides sp.*) requires sufficient performance of other consortia members that provide electron donor (H_2) and other growth nutrients (e.g., corrinoids) for the dehalogenating microbes.

Fermentation can be performed in continuous mode where the culture is continually grown and harvested, in fed batch mode where a culture is grown in a vessel and harvested and then another culture begun, or in a hybrid of the two whereby the culture is maintained in a fermentor until a volume of culture is harvested and then replaced with fresh medium.

The primary advantage of continuous fermentation is that the culture remains at a relatively high cell density and specific activity through the fermentation process (Stafford, 1986). This technique is typified by the operation of a chemostat where media continuously flow into and out of the fermentor and the feed rate is balanced against the growth rate of the culture. Theoretically, continuous fermentation allows the cell population to grow indefinitely in an unchanging environment. This technique is likely rare for the production of bioaugmentation cultures because of the sporadic demand for cultures and because of the need to maintain anaerobic conditions. Use of this method would require that the produced cultures be continuously collected and stored until use and media fed into the reactor would have to be made anaerobic. In addition, continuous fermentation requires a more complicated control system (to balance growth rate and dilution rate) and installation of additional equipment (e.g., tanks and pumps) that can hold and continuously supply anaerobic media to the fermentor and to collect and handle the produced culture

This technique may be useful for some on-site applications where the culture is grown with contaminated groundwater fed into the fermentor and the effluent of the reactor is used as an aquifer inoculum (Fam et al., 2004). The approach would require sufficiently high groundwater contamination to maintain growth of the organism because adding chlorinated solvents for growth could result in further contamination of the aquifer.

A more likely approach for producing cultures for bioaugmentation is a semi-continuous process whereby the culture is maintained in the fermentor until needed and then harvested. The harvested volume would then be replaced with fresh medium. This approach is common in research laboratories that maintain cultures for study. The primary advantage of this technique is that cell growth must only replace the volume of culture removed. For example, if one half of the culture is harvested, a single doubling of the remaining culture will replace the cells removed. This process may be most suitable for cases where demand for the culture is high and media is regularly removed from the culture and replaced with fresh medium. The primary disadvantages of this method is that the cultures are typically maintained in a stationary growth phase in the fermentor and specific activity of the culture can be reduced relative to that of actively growing and reproducing cells. In addition, long term continuous fermentation or prolonged maintenance of a culture in the fermentation vessel can lead to the accumulation of toxic metabolites that affect culture activity, survival, or performance. In fact, many continuous fermentation processes are designed to produce the accumulating toxic product, for example, ethanol. Extended maintenance of cultures in fermentors, during either continuous or semi-continuous fermentations, are rare in industrial applications

because they commonly lead to the accumulation of mutations that ultimately result in strain degeneration (Dykhuizen and Hartl 1983; Harder et al., 1977; Heiken and O’Conner, 1972). Furthermore, long term maintenance of a mixed culture in a fermentor could result in population changes that might affect the performance of the consortium during environmental applications if an important member of the population were lost during fermentation.

During fed batch fermentation, cultures are grown from a low cell density to a high cell density by controlling substrate addition and reactor conditions. This process allows harvesting of cultures during their most active growth states, and it minimizes the risk of population changes that can occur during long term culture maintenance. Likewise, the build up of recalcitrant toxic fermentation product in the medium is minimized. The primary limitation of this approach is that cells may have to be harvested before they are needed for field application. As such, the cultures must be able to be stored until needed. The storage of large culture volumes, especially anaerobic cultures that can not be dried because of oxygen toxicity, can require a large space or even a large refrigerated space. Concentrating the cultures under strict anaerobic conditions before storage, however, can reduce storage space requirements (see below).

For production of DHC-containing bioaugmentation cultures we have chosen to employ a fed batch fermentation process. This allows us to harvest cells in late log phase or early stationary phase to ensure the highest possible activity in the applied cultures, and to maintain culture consistency between batches. Fed batch fermentation also prevents the accumulation of fermentation products, for example acetate and propionate, which ultimately could affect culture activity. Experimentation has demonstrated that the

cultures can be concentrated by membrane filtration and that they can be stored refrigerated for more than 30 days without considerable loss of activity (Vainberg et al., 2009). The fermentation, cell concentration processes and storage studies are presented below.

3.2.1 Fermentation protocol

Fermentation of bacterial cultures is typically performed in a series of vessels that increase culture volume in a step-wise fashion. That is, an initial starter culture is grown in a vessel, and that culture is used as a seed culture for a larger culture. For example, for growth of DHC-containing cultures, small serum vial enrichment cultures can be used to inoculate 2 to 7L flasks or fermentors. Once high DHC levels are achieved, the 2 to 7 L culture is used to inoculate 10 to 20 L of fermentation media, and so on. In our experience, it is usually desirable to start a DHC fermentation culture at an optical density at 550 nm (OD_{550}) of approximately 0.1, or approximately 10^8 DHC/L. Thus, it is important to plan seed culture steps to ensure a sufficient inoculum size at each scale-up step. Examples of this step-wise fermentation process are presented below.

3.2.1.1 Seed cultures

Bench-scale fermentation experiments and seed culture production were performed in 3-L or 7-L Applicon fermentors (Cole Parmer, Vernon Hills, IL.) equipped with pH, DO and mixer controls. Substrate and NaOH feeds were controlled by using syringe pumps (Harvard Apparatus, Holliston, MA) and low flow peristaltic pumps (Cole Parmer, Chicago, IL). Larger seed cultures were produced in a similarly-equipped 20-L

Biolafitte fermentor (Pierre Guerin, Inc., Spring Lake Park, MN). Still-larger cultures were produced in a 750-L ABEC fermentor (Bethlehem, PA) or a custom built 4000-L stainless steel fermentor. In each case anaerobic conditions were maintained by pressurizing the vessels with nitrogen. At the end of the fermentation, cells in the fermentation broth were concentrated by passing the broth over a custom-built cell concentrator constructed with 6 KerasepTM tubular ceramic membranes (Novasep, Inc., Boothwyn, PA) contained within stainless steel piping to prevent oxygen intrusion. Concentrated cells were stored at 4 °C in 18.5-L stainless steel soda kegs (see below) that were pressurized with nitrogen.

For seed culture production RAMM medium (Shelton and Tiedje, 1984) without NaHCO₃ and Na₂S was added to the 20-L fermentor and steam sterilized at 121 °C and 15 psi for 45 min. After sterilization the fermentor was connected to a nitrogen tank to maintain a positive pressure of nitrogen in the vessel during cooling to 30°C. After the temperature in the fermentor reached the set point temperature of fermentation (28-30 °C) and anaerobic condition were achieved (measured DO = 0 mg/l), nitrogen flow was stopped and NaHCO₃ solution was added aseptically to the medium. The fermentor was then inoculated with 2 L of SDC-9TM or other culture. The final volume of medium in the fermentor was 16-18 liters.

After inoculation of the fermentor, sterile 10% yeast extract (YE) solution was added to a final concentration of 0.1% YE (w/v) and PCE or TCE was added to a final concentration of 10 mg/l. The fermentor was operated at 28-30 °C with an agitator speed of 100 rpm. pH was maintained at 6.4 to 7.2 by the addition of an anoxic solution of NaOH (2N). Alternatively, to increase pH during fermentation the fermentor was

sparged with nitrogen to remove dissolved CO₂. After one day of fermentation sodium lactate (60% solution) was added continuously to the fermentor at a flow rate 0.02-0.04 ml/h x liter of media. A second addition PCE or TCE (10 mg/l) was added to the fermentor only after complete dechlorination of PCE/ TCE but before complete dechlorination of *c*DCE. Typically, PCE/TCE was added to the medium when the concentration of *c*DCE in the medium was reduced to 1-3 mg/l. When the culture reached an optical density at 550 nm (OD₅₅₀) of approximately 1.0 it was transferred anaerobically to the 750-liter fermentor.

3.2.1.2 550-L scale

Intermediate size batches (to 550 L) of DHC cultures were prepared in a 750-L stainless steel fermentor. The 750-L fermentor was prepared with 540 liters of RAMM medium containing 0.1-0.2 % (w/v) YE, but without NaHCO₃, and sterilized as previously described. After sterilization and cooling NaHCO₃ (660 g) dissolved in 10 liter of DI water was added to the fermentor through a sterile filter, and neat PCE/TCE was added to a final concentration of 10 mg/l. The fermentor was connected to a nitrogen tank to maintain anoxic conditions, and it was operated under the same conditions as described for the 20-L fermentor except the agitator speed was set at 60 rpm. The automatic pH control system on the fermentor was inactivated to avoid addition of excess sodium ion (as NaOH). Once the appropriate temperature (28 °C) was reached in the fermentor, the seed culture was aseptically transferred to the larger fermentor while maintaining strict anaerobic conditions. After one day of fermentation a continuous feed of sodium lactate (60% solution) was initiated with a flow rate of 0.02-

0.04 ml/h x liter. Periodically, samples were taken from the fermentor and analyzed for the presence of chlorinated products, volatile fatty acids (VFAs) and DHC concentration. After complete dechlorination of the first addition of PCE/TCE, it was again added to a final concentration of 10 mg/l. Subsamples (25 mL) of the culture were periodically removed from the reactor to measure cell density and to perform bottle assays to determine specific activity. When the specific PCE and *c*DCE dechlorination activity reached 1.3-1.7 mg/h x gram of dry weight, a continuous feed of neat PCE/TCE was initiated at a rate of 0.18-0.25 μ l/h x L. This rate was increased to 0.9-1.2 μ l/h x L as the culture cell density and dechlorination activity increased. The culture was grown for 13-15 days until an $OD_{550} \approx 0.7-1.1$ or $10^{10}-10^{11}$ DHC/L was achieved. Higher DCH concentrations could be obtained by extending the fermentation for up to 35 days.

3.2.1.3 4000-L scale

Growth of the cultures in the 4000-liter fermentor (working volume 3200 liters) was performed essentially as described for the 750-L fermentor, but because the 4000-L fermentor did not have an impeller cells were continuously suspended by using a centrifugal pump that circulated the culture medium. To provide effective distribution of relatively high amount of added PCE/TCE (up to 40 ml initially and then continuously up to 6 ml/h) in the fermentor medium, these chemicals were added directly to the centrifugal pump where they were mixed with a high flow of recirculating medium from the fermentor. The PCE feed was supplied by using either a ISMATEC high precision multichannel pump (Model C.P 78023-02, Cole Parmer, Vernon Hills, IL.) or a syringe pump and a set of 2 100-ml gas tight glass syringes. To supply the TCE feed, which has

4 times higher vapor pressure than PCE (57.9 mm Hg and 17.8 mm Hg , respectively) and can not accurately be added by using a syringe pump, we used the ISMATEC high precision multichannel pump. The 4000-L fermentor was chemically sterilized by using NaOH and a clean in place system. The culture medium in the 4000-L fermentor was not sterilized. Substrate feeding and other parameters were as described for the 750-L fermentor. The fermentor was inoculated with either culture from the 750-L fermentor or refrigerated concentrated cell stocks, but in each case under strict anaerobic conditions.

During the initial growth phase with continuous or periodic PCE feed the cDCE and VC degradation was much lower than rate of PCE degradation, and this resulted in a rapid accumulation of cDCE and VC in the fermentor (Fig. 1C). After 1-2 days of growth, however, even with continuous PCE feed, the concentration of cDCE and VC began to decline rapidly and a continuous feeding of PCE could resume. This may suggest that it takes longer to induce cDCE and VC degradation genes than PCE degradation genes, that organisms in the consortium that degrade PCE to cDCE initially grow faster than organisms that degrade cDCE and VC, or that a combination of both of these factors created this affect.

3.3 Fermentation Results

Results of several fermentation experiments are reported elsewhere (Vainberg et al., 2009), and Monod kinetics parameters for SDC-9TM also have been reported (Schaefer et al., 2009) In our production-scale and research applications, DHC-containing consortia are typically grown with lactate as an electron donor and PCE as an electron acceptor. Other electron donors or electron donor mixtures, however, have been

used successfully, at least for small-scale production. For example, early studies with the KB-1 culture suggested a growth benefit if the culture was grown with a mixture of methanol, ethanol, acetate, and lactate (Duhamel et al., 2002) presumably because the electron donors are utilized at different rates or because they support different groups of microbes in the culture. Our analysis of different substrates including lactate, ethanol, methanol and citrate revealed that the SDC-9 consortium was able to utilize all of these substrates, but the greatest degradation activity and bacterial growth rate was achieved with lactate as the electron donor substrate (data not shown). In addition, we determined that it would be easier to control substrate feeding rates by using a single primary electron donor such as sodium lactate. Even with the single electron donor like lactate, utilization of the substrate by the consortium leads to the production of a complex mixture of daughter products, primarily volatile fatty acids, which can themselves act as electron donors for the culture (see below). Balancing the concentration of a mixture of electron donors and mixtures of electron acceptors (i.e., PCE and PCE daughter products) during large scale fermentation adds increased complexity to fermentation optimization. Although PCE was used as a primary electron acceptor, similar results, in terms of specific activity and final cell densities, were obtained when TCE was used as an electron acceptor to grow SDC-9 by special request.

Examples of large scale production of the SDC-9 consortium in a 4000-L fermentor (culture volumes of 2500 liters and 3200 liters, respectively) are presented in Fig. 1A, and 1B Fig. 1A shows the growth of a culture inoculated with a concentrated culture transferred directly from the 750-L fermentor, and Fig.1B shows the growth of a culture inoculated with a similar concentrated culture that had been stored for 19 days at

4-6°C. The data show a slight difference in the lag phase observed before the start of log phase growth. The lag phase varied from 2 days for the culture directly inoculated from 750-liter fermentor to about 5 days for stored culture. For routine fermentation monitoring we measured the optical density of fermentor samples. During the initial lag phase the OD of consortium increased about three-fold due primarily to the rapid growth of non-DHC organisms in the consortium on the added yeast extract. A similar rapid increase in non-DHC organisms, and OD, also was observed if a high concentration of lactate (5-12mM) was added to the medium at the beginning of the fermentation (data not shown), despite the lag in DHC growth. These results demonstrate that, at least during the early stages of fermentation, optical density measurements are not a good indicator of DHC concentration in the culture, and more advanced measurements like qPCR are needed to effectively estimate DHC numbers in the culture (Löffler et al., 2000; Ritalahti et al., 2006).

Following the lag phase and after lactate was fed continuously at a low rate to generate low levels of hydrogen (< 20 nM), DHC concentration began to increase exponentially and reached about 10^9 - 10^{10} cells/L. During this period of growth the culture OD was correlated with the growth of DHC culture. These results suggest that during certain periods of the fermentation process measurements of OD may be useful for estimating DHC levels in the fermentor and to automate the control of the fermentation process.

The optical density of the cultures typically stabilized after approximately 10 d, but exponential growth of DHC continued until approximately day 24 (Fig. 1A,B). These results suggest that non-DHC microorganisms in the consortium initially grow much

faster than DHC. During this early fermentation period, DHC represent a relatively low proportion of the total bacterial population of the culture, but during extended growth the relative abundance of DHC in the culture increases (Fig. 2).

During the initial stages of 3200-L fermentation (to day 25) a maximum DHC concentration of $\sim 10^{11}$ DHC/L was achieved in the fermentor, even though growth substrates are still present in the culture broth (Fig. 1C). DHC concentrations in the fermentor, however, could be increased ~ 10 -fold by the addition of YE as a nutrient source. The exact role of the YE is not known, but its addition also appeared to revive the growth of non-DHC organisms in the consortium as reflected in a rapid increase in culture OD (Fig 1B). Because the RAMM medium used in our work does not contain sodium sulfide or other sulfur-containing salts, it is possible that the yeast extract provides a needed source of sulfur for the cultures. One g/L of YE provides ~ 5 mg/L sulfur and 0.48 mg/L iron. YE also could provide a needed source of amino acids and/or precursors for the production of corrinoid co-factors that are necessary for dehaologenation by DHC strains (Maymó-Gatell et al., 1997). Genome sequencing of *D. ethenogenes* strain 195 (Seshadri et al., 2005) has revealed that this strain does not have all the genes necessary for de novo corrinoid synthesis, but it does contain several genes for corrinoid salvage, and He and colleagues (2007) demonstrated that the addition of vitamin B12 allowed for increased growth of DHC.

Analysis of growth parameters from 5 fermentation batches (550-L and 3200-L) has shown that the average DHC specific growth rate for the SDC-9 culture under the conditions described here was 0.036 h^{-1} with a range of 0.027 to 0.043 h^{-1} . DHC doubling time averaged 19.3 ± 2.7 hr (Vainberg et al., 2009). The described protocol

produced similar results with all three cultures tested (SDC-9, PJKS and Hawaii-05), and in each case the final DHC concentration in the resulting culture was $>10^{11}$ DHC/L (Table 2)

Only one other study has reported relatively large scale production of DHC for bioaugmentation (Ellis et al., 2000), but the study was performed before the widespread use of qPCR methods for specific monitoring of DHC. In that study, batch culturing on lactate and TCE was used to produce about 180 L of the Pinellas Culture. The resulting culture contained about 2×10^8 total bacteria/ml, a relatively low abundance of DHC, and about 35 g DWT of cells were produced in the fermentation. The culture had a doubling time of 30-40 h under optimum laboratory conditions. Other studies have reported DHC cell concentration comparable to those achieved in our work, but in small laboratory-scale batches.

The results of this study demonstrate that culture volumes and DHC cell densities sufficient to treat even relatively large contaminated aquifers can be obtained. Assuming that 10^7 DHC/L of contaminated groundwater are needed to obtain effective and timely remediation (Lu et al., 2006), 3200 L of culture with 10^{11} DHC/L could potentially support remediation of 3.2×10^7 L of groundwater, even without further in situ growth of the organisms.

3.3.1 Factors affecting fermentation.

Several factors could affect the results obtained during growth of the test cultures, including substrate type and feed rates, pH, and volatile fatty acid (VFA) accumulation. Growth of DHC requires the presence of a chlorinated substrate as an electron acceptor,

H₂ as an electron donor, and a carbon growth source such as acetate (He et al., 2003b; Löffler et al., 2003; Maymó-Gatell et al., 1997). In consortia such as those used in this study, the primary growth substrate (i.e., lactate) is fermented by non-DHC members of the consortia to H₂ and acetate that can be utilized by DHC. The presence of excess H₂, however, can lead to substrate competition with methanogenic bacteria in the consortia that also can use H₂, albeit at a higher substrate threshold than DHC (Löffler et al., 1999; Lu et al., 2001; Yang and McCarty; 1998). Therefore, in developing a fermentation protocol for the described cultures, attempts were made to maintain consistent low H₂ concentrations within the reactor. The sodium lactate feed rate used during the fermentation process resulted in sustained dissolved hydrogen concentration in the reactor of <20 nM. During utilization of the initial batch feeding of lactate and YE added prior to inoculation, H₂ concentrations sometimes exceeded 100 nM, but during the extended fermentation process H₂ concentrations were typically 3 to 5 nM which was similar to the calculated half velocity coefficient for hydrogen calculated for the VS culture (7 ± 2 nM; Cupples et al., 2004b).

Fermentation of lactate also led to an accumulation of VFAs (e.g., propionate and acetate; Fig 3)) that could potentially inhibit dechlorinating organisms in the consortia. Studies with SDC-9TM, demonstrated that dehalogenation of chlorinated ethenes by the culture was not inhibited by propionate and acetate concentrations to 6000 mg/L (82.1 mM and 101.6 mM respectively) (data not shown). Figures 3A and 3B show the formation of VFAs during growth of SDC-9TM and PJKSTM, respectively. In both cases, the VFA concentrations did not reach inhibitory levels with the fermentation protocol described here. Notably, the SDC-9TM culture accumulated much less propionate than

the PJKSTM culture grown under the same conditions. Although the reason for this lower accumulation of propionate is not certain, it is likely due to evolution of the SDC-9TM culture to more efficiently ferment propionate during several years of maintenance on lactate as a primary growth substrate.

To optimize the growth of the SDC-9TM consortium it was necessary to determine a relationship between PCE feed rate and DHC cell concentration. The fermentation process was complicated by the fact that the cultures used were mixtures and likely contained multiple populations of dehalogenating microbes. We were most concerned about maintaining the VC-reducing population(s) in the consortia because VC reduction is less energetically favorable than the other dehalogenating reactions, so it was possible that PCE and TCE dehalogenating populations could out-compete the VC reducers if the higher chlorinated substrates were maintained in excess. Furthermore, Cupples and colleagues (2004b) observed that net decay in dechlorinating microorganisms could occur in the VS culture if DCE plus VC concentrations were below 0.7 μM . In addition, with SDC-9, based on many bottle assays, the VC dechlorination rate is 28-35% of the PCE dechlorination rate. Therefore, there was a tendency for VC to accumulate in the fermentor during high rate PCE feeding. Consequently, PCE feed rates were adjusted to prevent accumulation of PCE, TCE or cis-DCE while maintaining a residual VC concentration in the medium of ~ 1 mg/L (16 μM). Evaluating the PCE feed rates during multiple fermentation runs, the results of the bottle assays, and the analyses of PCE, TCE, cDCE and VC concentrations during fermentation allowed us to optimize PCE feed rates for the growth of SDC-9 consortium. The relationship between DHC cell numbers and

PCE feed rate could be described by the following equation: DHC concentration (cells/L) = $-6.77 \times 10^{11} + [8.40 \times 10^{11} \times \text{PCE feed rate (mg/h} \times \text{L)}]$ (R= 0.999).

Dehalogenation of chloroethenes by SDC-9TM also was affected by culture pH, with little or no dehalogenation below pH 5.6 and above pH 9.0 (Fig. 4). In another experiment the effect of elevated pH on TCE dechlorination activity was studied by incubating SDC-9 culture in groundwater at pH 9.9 for one day at 15 °C , and then reducing the pH to 7.0 before measuring TCE degradation activity. This short incubation at pH 9.9 resulted in the loss of 99% of TCE degradation activity of the SDC-9 consortium. Both reductive dehalogenation and fermentation of the growth substrates used to grow the cells consumes considerable amounts of alkalinity (McCarty et al., 2007). The pH of the medium in our 4000-L fermentor decreased from an initial pH of 7.4 to approximately 6.1 during the first 30 days of cell growth (Fig. 5). Because the culture was fed sodium lactate, however, the addition of NaOH to control pH could have led to an excess of sodium ions in the reactor that could affect cell growth. Analysis of PCE dechlorination with added NaCl to RAMM medium to a final total dissolved solid (TDS) concentration 1000 mg/L has shown that elevated level of TDS reduced dechlorination rates especially for cis-DCE and VC (Fig. 6). Therefore, instead of adding NaOH to control pH, the fermentors were sparged periodically with N₂ to remove dissolved CO₂ from the culture medium. This approach sufficiently regulated the medium pH to allow completion of the culture production (Fig. 7). The duration of sparging affected the extent of pH increase and typically sparging for 10-15 min allowed the pH to increase 0.3-0.4 SU (Fig. 8). Sufficiently high rates of growth and substrate

dehalogenation were sustainable in the fermentors provided the pH was maintained above 6 SU.

3.4 QA/QC considerations

Quality assurance/quality control (QA/QC) play several important roles in the practice of bacterial fermentation: they ensure that the fermentation process is functionally efficiency, they confirm the integrity of the produced culture, and they provide customers with assurance that the purchased culture is active, safe and as promised. They also are sometimes necessary to assure regulatory authorities that a culture added to an environment is safe and meets local regulatory requirements. Although no industry standards exist for the production of cultures used for bioremediation, most producers adopt their own procedures to meet their own requirements and those of their clients. Below are some considerations for the development of a QA/QC program for producing bacterial cultures for remediation of chlorinated solvent-contaminated aquifers.

3.4.1 Pathogen Analysis.

Pathogen analysis is commonly performed to assess the safety of bacterial cultures. Such analyses are sometimes required by regulatory authorities to evaluate the suitability of a culture for injection into an aquifer. Pathogen analysis is available through a number of commercial vendors. A common readily available battery of pathogen tests includes assays for the following: 1) *Salmonella* (enteric pathogen); 2) *Listeria monocytogenes* (food borne pathogen); 3) *Vibrio* (enteric pathogen, causative agent of cholera and other infections); 4) *Clostridium perfringens* (causative agent of gas gangrene; food poisoning and flesh-eating infections); 5) *Pseudomonas* (many plant and

animal infections); 6) yeast (multiple infections); 7) *E. coli* (enteric pathogen; indicator of fecal contamination); total coliforms (indicators of fecal contamination or enteric pathogens); 8) *Bacillus* (causative agent of anthrax and some food poisonings); 9) *Yersinia* (causative agent of plague); 10) Streptococci (multiple infections); 11) *Campylobacter jejuni* (food poisoning agent usually associated with poultry); and mold (multiple infections).

The cost of such a battery of tests is reasonable, but the actual utility of these tests for assessing the safety of a bioaugmentation culture is questionable. For example, many of the organisms analyzed for are members of diverse bacterial families that contain multiple species, strains, or pathovars; many of which are non-pathogenic. Also, many strains in these families are common soil bacteria that could reasonably be expected to test positively in a culture isolated from an environmental sample (e.g., *Pseudomonas*, *Bacillus*, *Yersinia*, mold and yeast). Thus, a positive test for one of these potential pathogens could raise unnecessary concerns about the safety of a culture. Likewise, because the bioaugmentation cultures all are grown under strict anaerobic conditions, a greater focus on potential anaerobic pathogens may be more suitable for assessing culture safety, but assays for such infective agents appear less readily available.

3.4.2 DHC concentrations.

Knowledge of the DHC concentrations in bioaugmentation cultures is critical for planning, and for determining the relative value of commercially available cultures. Because the DHC-containing cultures are consortia and DHC are difficult to grow in pure culture, enumeration of the DHC in the cultures typically requires the use of quantitative

PCR (qPCR) methods. Several DHC-specific qPCR assays and PCR primer sequences have been described (Hendrickson et al., 2002; Ritalahti et al., 2006). qPCR assays should be performed on each batch of culture produced, but for routine fermentation monitoring measurements of optical density can sometimes be used provided enough preliminary work is performed to understand the relationship between total cell density and DHC concentration at different stages of culture growth (Vainberg et al, 2009). Typical final DHC concentrations in some cultures produced by us are shown in Table 2.

3.4.3 Specific Activity.

Specific activity is a measure of the amount of target contaminant that can be degraded per unit of culture within a given time. For our QA/QC monitoring, we measure specific activity of both PCE (Fig. 9A) and *c*DCE (Fig. 9B) degradation because most cultures have multiple dechlorinator populations, some of which can degrade DCE to ethene and others that likely degrade PCE to only TCE or *c*DCE. Furthermore, qPCR analysis does not allow differentiation between live and dead DHC cells, so even with high DHC numbers the degradative activity of a culture could be low. Specific activity can be measured in terms of DHC numbers or protein concentration, but for our applications we use total dry weight of washed cells as a standard. Because the cultures are mixtures, dry weight measurements also allow us to assess whether the produced cultures have an expected or desired ratio of DHC to non-DHC organisms. For example, low DHC numbers with high dry weight can indicate that fermentation has led to an imbalance in the relative amount of DHC to non-DHC organisms in the culture. Likewise, high dry weight-based specific activity indicates that the culture has a high DHC concentration relative to non-DHC organisms. Finally, dry weight measurements

eliminate variability in qPCR results that can occur when the culture is diluted several orders of magnitude to have the DHC concentration range suitable for qPCR analysis. Results of typical PCE and cDCE bottle assays used for evaluating specific activity are shown on Fig 9 and 10.

The timing of specific activity measurements is an important consideration for QA/QC assessment. These measurements can be made before harvesting culture, before or after packaging, or after they arrive at a site for injection. In our experience, removing a small quantity of the packaged culture prior to shipping provides an adequate assessment of specific activity of the delivered culture. Our cultures, however, are typically delivered by overnight courier. If the cultures are shipped by other methods that require several days of transport, or if they are stored at a site for a few or several days prior to injection, it may be prudent to collect samples for specific activity measurements just prior to injection.

3.4.4 Other QA/QC Considerations.

An often overlooked aspect of QA/QC is the presence of potential groundwater pollutants in injected cultures. As shown in Figures 2A and 2B, the finished fermentation broth can contain relatively high concentrations of volatile fatty acids that can be co-injected with the bacterial culture. Although these components may not realistically affect water quality in an aquifer, especially an aquifer undergoing biological treatment facilitated by electron donor injection, injection of this material may violate groundwater injection regulations. As such, QA/QC monitoring of culture broth composition may be prudent for addressing such concerns or to allow full disclosure of the solution

characteristics for injection permit applications. More importantly, some fermentation broths may contain residual levels of chlorinated solvents or daughter products such as cDCE and VC, the injection of which would certainly violate groundwater injection regulations. This is of particular concern if PCE or TCE are added to shipping containers to maintain activity during shipment. Again, careful analysis for these compounds prior to culture injection may be warranted. Concentrating cultures (see below) can reduce the amount of fermentation by-products remaining in the culture and allow for overnight shipment of large culture volumes, thereby minimizing some of the above concerns.

3.5 Concentrating and Storing Inocula

The use of relatively large volumes of bioaugmentation cultures presents several challenges for culture producers and users. For example, timing of bioaugmentation injection events are usually controlled by other field activities including the availability of field staff, drilling crews and weather events. As a result, culture injection schedules can be uncertain and delays are commonplace. This often requires culture producers to unexpectedly extend fermentation activities or delay culture shipments. Such delays can disrupt scheduling of upcoming deliveries, or force producers to keep a fermenting culture in the fermentor beyond its optimal growth and activity period. Likewise, the production of large DHC cultures requires considerable time (Fig 1), and shipping delays can reduce the amount of time available to produce consistent cultures, especially for short-lead orders. In addition, injection of large culture volumes may take several days in the field depending on the injection method and site conditions. As a result of these

challenges, the ability to store cultures, or at least understanding the stability of stored cultures, becomes an important consideration.

Another significant cost consideration for use of large culture volumes is transportation to the treatment location. Ground based shipping of cultures to distant areas can require several days and likely would require refrigeration to maintain the stability of large cultures. Similarly, overnight shipment of large culture volumes can be costly and/or impractical. There also exists a concern that injecting large volumes of culture that may be contaminated with fermentation by-products (e.g., VFAs; Fig. 3) or residual growth substrates (e.g., PCE, TCE, DCE or VC) could lead to further contamination of the site or, at the very least, legal implications (see above).

One approach for addressing the issues of culture storage and shipping is to concentrate the cells for storage and shipping. Cell concentration reduces shipping and storage volumes, and it removes the bulk of the fermentation broth and its potential by-products or contamination. The suitability of cell concentration depends on the robustness of the cultured cells, however, and the loss of an important member of a consortium during the concentration process requires consideration.

3.5.1 Concentrating cultures. Several techniques including vacuum evaporation, spray evaporation, continuous centrifugation and ultra or cross-flow filtration have been used in biotechnological applications for concentrating bacterial cells. Many of these, however, are difficult to apply while maintaining strict anaerobic conditions to ensure viability of anaerobic bacteria like DHC (Ljungdahl and Wiegel, 1986). For our testing and applications consortia cells in fermentation broths were concentrated by cross flow

filtration over a custom-built concentrator constructed with 6 Kerasep™ KBX tubular ceramic membrane units (Novasep, Inc., Boothwyn, PA) operated in series (Fig. 10). Each filter unit contained 7 BX-7c ceramic elements containing 7 flow channels each all of which were contained within stainless steel shells. The filters represented 72 ft² (6.6 m²) of membrane surface area with an effective pore size of 0.2 μm. The ceramic membranes were chemically cleaned by circulating a solution of 0.5% NaOH through the system for 8 hr prior to cell concentration activities. All manipulations were performed under strict anaerobic conditions facilitated by charging the entire system with N₂ prior to introducing the cells, and by connecting the concentrator directly to the fermentors so that liquid did not have to be removed from the system for concentration activities. The culture from the 4000-L fermentor was passed over the membranes at a pressure of 50-55 psi and returned to the fermentor by using a 2 pump system. The first pump was the reactor circulation pump (G&L SSH-S 2 x 2.5-8; A Gould Pump Co., Seneca, NY) that was capable of transferring 100 gal/min, and the second was a high pressure pump (G&L NPE 1-1/4 x 1 – 1/2-6; A Gould Pump Co., Seneca, NY) with a capacity of 50 gal/min. The culture from the 750-L fermentor was concentrated by using a separate lower capacity (24 gal/min) pump (Model CHI-4-50; Grundfos Pump Corp. USA, Olathe, KS). The system was designed to remove ~400 to 500 L of liquid/h at an initial cell concentration 1.0-1.2 g/L of biomass (DWT), or in the case of the 750-L fermentor, to remove 80-85 L/hr. The culture from the 4000-L fermentor could be concentrated to ~120 L within the large fermentor vessel (i.e., ~26 fold), or subsequently transferred to the 750-L vessel and concentrated to ~50 L (i.e., 64-fold). The culture in the 750-L fermentor (550-L of broth) could be concentrated to ~50 L (i.e., ~10-fold). The

concentration process also could be stopped at any time during the process to generate a culture with a desired DHC concentration. Concentrated cells were transferred to N₂-charged 18.5-L stainless steel soda kegs (Fig 11), pressurized to 15 psi with N₂, and stored at 4 °C.

Fig. 10 shows a photo of the cell concentration system connected to the 4000-L fermentor, and Fig. 12 and Z show the results of SDC-9TM cell concentration from 750-L and 4000-L fermentors respectively in the ceramic membrane concentrator system. The cell culture was chilled during concentration to ensure maintenance of cell viability. Analysis of the specific activity of the cells before and after concentration demonstrated only small changes in activity during concentration. For example, specific activity of two cultures tested were 24 and 16 mg PCE/h x gDWT before concentration and 23 and 15 mg PCE/h x gDWT after concentration, respectively. Because the concentration process resulted in approximately 90% reduction in culture volume, it also removed ~90% of any fermentation by-products remaining in the culture broth. Cell concentration also allows standardization of DHC concentrations and activity of culture batches. That is, the concentrated cultures can be diluted to a pre-determined DHC concentration, thereby allowing producers to deliver consistent cultures and allowing users to more reliably estimate the volume of culture needed for field applications. In our work it was likely, however, that some culture biomass was unrecoverable from the ceramic membranes either in trapped liquid or by adhesion to the membranes, but given the large volumes and high DHC concentrations obtained during our fermentation processes, this loss was considered insignificant relative to the benefits of cell concentration.

3.5.2 Culture stability/storage.

Storage of bacterial cultures is critical for allowing timely delivery of cultures to contaminated sites to coordinate culture injection with the availability of field personnel and equipment (e.g., drilling rigs), and also to allow cultures to be injected over several days of field-scale injection. To evaluate storage longevity, 10X-concentrated SDC-9™ cultures were incubated for up to 82 days at either 4 °C, 13 °C, or 28 °C in stainless steel containers. Periodically, samples of the stored cultures were removed and assayed for their ability to degrade PCE and cDCE. Activity of the culture decreased rapidly if stored at 13 or 28 °C, but SDC-9™ could be stored at 4 °C for >35 d without loss of activity (Table 3). Cultures stored in this manner should be suitable for field application. In fact, a concentrated SDC-9 culture stored for 7 months at 4 °C still retained 58% of its original PCE degradation activity and 68% of its cDCE degradation activity. Initial PCE and cDCE degradation activities were 22.2 and 14.4 mg/h x gDW, respectively, and after storage of the culture PCE and cDCE degradation activity were 12.9 and 9.8 mg/h x gDW), suggesting that cultures stored for very long periods, although perhaps not optimum for field application, should still be suitable for seeding reactors for further culture production.

The storage results presented also demonstrate that care must be taken to keep cultures refrigerated during shipment to sites and storage during injection events, but that cultures can be stored refrigerated for several days during application in the field. Cultures that are not adequately refrigerated could lose considerable activity during overland shipment to sites or during on-site storage.

3.6 Shipping cultures. Shipping cultures to treatment sites requires consideration of the need to maintain strict anaerobic conditions to ensure DHC viability, and also to maintain refrigeration temperatures if the culture will not be applied until several days after production. It also is important to ensure that the culture to be injected into aquifers is free of chlorinated contaminants that could cause additional site contamination. We have chosen to employ the use of 5 gal (18.5 L) stainless steel soda kegs. An example of the kegs is presented in Fig. X. These kegs are readily available (e.g., from home brewing suppliers), inexpensive and durable. They also can be chemically or steam cleaned and autoclaved. Furthermore, they fit well within coolers that can be readily shipped with included cold packs via overnight carrier, and they can be modified as needed to suit specialized culture injection requirements. Each keg contains an internal drop tube that extends to near the bottom of the keg. Liquid is removed from the kegs by attaching quick connect ball lock (or pin lock depending on the manufacturer) devices to “gas in” and “liquid out” (drop tube port) ports on the top of the kegs. As gas (nitrogen or argon) is added through the gas in port the culture is expelled from the liquid out port. Flow of the culture from the keg can be controlled by simple valves.

3.7 On-site handling

Dehalogenating bacteria are strict anaerobes (He et al., 2003b; Löffler et al., 2003; Maymó-Gatell et al., 1997), and as such they must be handled so as to prevent exposure to oxygen. Most culture distributors now deliver cultures in containers, like those described above, that allow the cultures to be anaerobically injected into aquifers with no exposure to oxygen.

3.7.1 Direct Injection. Bioaugmentation cultures can be injected directly into aquifers using direct push technologies, by adding them to injection wells, or by adding them to re-circulation systems. Prior to injecting the cells aquifers are often preconditioned to remove oxygen and reduce the redox potential. This is typically accomplished by injecting the planned electron donor into the aquifer several days, weeks or months prior to injecting the culture. The amount of time required to achieve suitable conditions and the amount of electron donor needed depends on conditions at the site including oxygen levels and the presence of other bacterial electron acceptors (e.g., nitrate, sulfate, Fe^{3+}). Some bioaugmentation treatments, however, have been performed without extensive aquifer pretreatment. Because the consortia used for augmentation contain fermentors and other organisms able to use oxygen, it is likely that these organisms rapidly use low levels of dissolved oxygen, thereby protecting the oxygen sensitive DHC organisms. In most cases of direct injection, in situ distribution of the culture is aided by injecting anaerobic water following culture injection

3.7.2 Dilution. An alternative to directly injecting bacterial cultures into aquifer is to dilute them first and inject over a long period of time or into many injection wells. In most cases ground water or potable water is made anaerobic by adding electron donor to the water in a closed container and incubating it until the bacteria in the water consume the dissolved oxygen. In the case of groundwater the number of bacteria present is sufficient to remove the oxygen in a few days. Potable water, however, because of its low bacterial numbers can take quite long to become anaerobic. The process can be accelerated by adding an inoculum of oxygen consuming bacteria. The inoculum can be a commercially available culture, but also be accomplished by adding soil, compost, or

other readily available material. In our experience, free residual chlorine or chloramine in most potable waters is not inhibitory to DHC cultures.

An alternative to using bacteria to remove residual dissolved oxygen from dilution water is to sparge the containerized dilution water with nitrogen or argon. In our experience, this approach can remove dissolved oxygen to below 1 mg/L, but the ease of using this method depends on the size of the water being treated. Argon may have an advantage over nitrogen because it is lighter than air and forms an anaerobic gas blanket on top of the treated water, thereby preventing further dissolution of oxygen into the water. This approach also reduces levels of free chlorine in potable water.

3.7.3 Mixing with carbon source, reducing chemicals prior to injection. Field personnel often desire to mix bioaugmentation cultures directly with electron donor and/or reducing agents such as L-cysteine so that both can be injected simultaneously. The compatibility of the bioaugmentation culture with the high concentration electron donor and reducing agents must be evaluated before using this approach. We analyzed the use of L-cysteine at concentration up to 0.69 g/L and did not find any negative effect on SDC-9 consortium.

The pH of some electron donors are extreme to avoid spoilage, and high concentrations of some electron donors may be directly toxic to DHC.

We have tested several commercially available electron donors, even after pH adjustment, and have observed that even moderate concentrations can be inhibitory. Sodium lactate was not inhibitory to SDC-9 at concentrations up to 6000 mg/L were not inhibitory, but higher concentrations were not tested. Other electron donor formulations

were inhibitory at concentrations as low as 200 mg/L (Figure Y). In addition to direct inhibition, rapid fermentation of some electron donor substrates can result in the production of metabolic acids and CO₂ that reduce the pH of the mixture or recipient groundwater to levels that can inhibit DHC (McCarty et al., 2006).

4 Summary

Large-scale production of DHC-containing cultures for in situ bioaugmentation of chlorinated ethene-contaminated aquifers can be performed economically and results in reproducible high specific activity and high cell density cultures. Success of the fermentation process is dependant on electron donor (i.e., lactate) and acceptor (PCE) feed rate, and the addition of YE greatly improves cell yield. The initial stages of fermentation are characterized by rapid growth of non-DHC organisms in the culture, while the growth of DHC exhibits a short lag period and then is relatively constant to final DHC concentrations of >10¹¹/L. The fermentation protocol presented here was scalable to 550 L and 3200 L and it produced comparable results with consortia enriched from 3 different sites. The cultures were able to dehalogenate PCE to ethene suggesting that the described protocol retains organisms capable of degrading all of the chlorinated PCE daughter products including VC that yields less energy than higher chlorinated products.

Our results also demonstrate that DHC-containing cultures designed for bioaugmentation can be concentrated by cross-flow filtration to reduce shipping volumes, and that the concentrated cultures can be stored under refrigeration for >40 days to allow

for injection schedule flexibility. The use of inexpensive soda kegs provides a simple method for delivering and injecting the concentrated cultures.

With the increased use of bioaugmentation to treat challenging chlorinated ethene contaminated sites, the ability to produce large volumes of high density cultures is becoming increasingly important. This study provides useful information to aid in the production of cultures for bioaugmentation, even at scales suitable for treating large contaminant plumes.

References

Cupples AM, Spormann AM, McCarty PL (2003) Growth of a *Dehalococcoides*-like microorganism on vinyl chloride and *cis*-dichloroethene as electron acceptors as determined by competitive PCR. *Appl Environ Microbiol* 69:953-959

Cupples AM, Spormann AM, McCarty PL (2004a) Comparative evaluation of chloroethene dechlorination to ethane by *Dehalococcoides*-like microorganisms. *Environ Sci Technol* 38:4768-4774

Cupples AM, Spormann AM, McCarty PL (2004b) Vinyl chloride and *cis*-dichloroethene dechlorination kinetics and microorganism growth under substrate limiting conditions. *Environ Sci Technol* 38:1102-1107

DeFlaun, M.F. and R.J. Steffan. 2002. Bioaugmentation. pp 434-442 in: *Encyclopedia of Environmental Microbiology*, G. Bitton (ed.), John Wiley & Sons, New York, NY.

Duhamel M., K Mo, EA Edwards. 2004.Characterization of a highly enriched *Dehalococcoides*-containing culture that grows on vinyl chloride and trichloroethene. *Appl Environ Microbiol* 70:5538-5545

Duhamel, M., S. Wehr, L. Yu, H. Rizvi, D. Seepersad, S. Dworatzek, E. E. Cox, and E. A. Edwards. 2002. Comparison of anaerobic dechlorinating enrichment cultures maintained on tetrachloroethene, trichloroethene, *cis*-dichloroethene and vinyl chloride. *Water Res.* 36:4193-4202.

Dykhuizen, D. E., and D. L Hartl. 1983. Selection in chemostats. *Microbiol. Rev.* 47:150-168.

Ellis DE, EJ Lutz, JM Odom, J Ronald, J Buchanan, C Bartlett MD, Lee MR Harkness, KA Deweerd (2000) Bioaugmentation for accelerated in situ anaerobic bioremediation. *Environ Sci Technol* 34:2254-2260

Griffin, BM, JM Tiedje, FE Löffler. 2004. Anaerobic microbial reductive dechlorination of tetrachloroethene (PCE) to predominately trans-1,2 dichloroethene. *Environ Sci Technol* 38:4300-4303

Fam, S.A., M. Findlay, S. Fogel, T. Pirelli, and T. Sullivan. 2004. Full-scale enhanced anaerobic dechlorination with bioaugmentation. Paper 2D-02 in: A.R. Gavaskar and A.S.C. Chen (eds.) Remediation of Chlorinated and Recalcitrant Compounds - 2004. Proceedings of the Fourth International Conference on Remediation of Chlorinated and Recalcitrant Compounds. Battelle Press, Columbus, OH.

Harder, W., J. G. Kuenen, and A. Martin. 1977. Microbial selection in continuous culture. J. Appl. Bacteriol. 43:1-24.

He J, KM Ritalahti, MR Aiello, FE Löffler (2003) Complete detoxification of vinyl chloride by an anaerobic enrichment culture and identification of the reductively dechlorinating population as *Dehalococcoides* species. Appl Environ Microbiol 69:996-1003

He J, KM Ritalahti, KL, Yang SS Koenigsberg, FE Löffler (2003) Detoxification of vinyl chloride to ethene coupled to growth of an anaerobic bacterium. Nature 424:62-65

He J., V Holmes, P K H Lee, L Alvarez-Cohen (2007) Influence of vitamin B₁₂ and cocultures on the growth of *Dehalococcoides* isolates in defined medium. Appl Environ Microbiol 73:2847-2853

He J, Y Sung, R Krajmalnik-Brown, KM Ritalahti, FE Löffler (2005) Isolation and characterization of *Dehalococcoides* sp. Strain FL2, a trichloroethene (TCE)- and 1,2-dichloroethene-respiring anaerobe. Environ Microbiol 7:1442-1450

Heineken, F. G., and R. J. O'Conner. 1972. Continuous culture studies on the biosynthesis of alkaline protease, neutral protease, and α -amylase by *Bacillus subtilis* NRRL-B3411. J. Gen. Microbiol. 73:35-45.

Hendrickson ER, JA Payne, RM Young, MG Starr, MP Perry, S Fahnestock, DE Ellis, RC Ebersole (2002) Molecular analysis of *Dehalococcoides* 16S ribosomal DNA from chloroethene-contaminated sites throughout North America and Europe Appl Microbiol 68:485-495

Holliger C, Wohlfarth G, Diekert G (1999) Reductive dechlorination in the energy metabolism of anaerobic bacteria. FEMS Microbiol Rev 22:383-398

Holliger C, Schumacher, W (1994) Reductive dehalogenation as a respiratory process. Antonie van Leeuwenhoek 66:239-246

Lee MD, JM Odom, RJ Buchanan, Jr. (1998) New perspectives on microbial dehalogenation of chlorinated solvents: Insights from the field. Ann Rev Microbiol 52:423-452

Lendvay JM., FE Löffler, M Dollhopf, MR Aiello, G Daniels, BZ Fathepure, M Gebhard, R Heine, R Helton, J Shi, R Krajmalnik-Brown, CL Major Jr, MJ Barcelona, E Petrovskis, JM Tiedje, P Adriaens (2002) Bioreactive barriers: bioaugmentation and biostimulation for chlorinated solvent remediation. *Environ Sci Technol* 37:1422-1431

Ljungdahl, L.G. and J. Wiegel. 1986. Working with anaerobic bacteria. pp. 84-96 in A. L. Demain and N. A. Solomon (eds) *Manual of Microbiology and Biotechnology*. American Society for Microbiology, Washington, D.C.

Löffler FE, JR, Cole, KM Ritalahti, JM Tiedje (2003) Diversity of dechlorinating bacteria, p. 53-87. *In* M.M. Häggblom and I.D. Bossert (ed.) *Dehalogenation: microbial processes and environmental applications*. Kluwer Academic Press, New York, New York

Löffler FE, Q Sun, J Li, JM Tiedje (2000) 16S rRNA gene-based detection of tetrachloroethene-dechlorinating *Desulfuromonas* and *Dehalococcoides* species. *Appl Environ Microbiol* 66:1369-1374

Löffler FE, JM Tiedje, RA Sanford (1999) Fraction of electrons consumed in electron acceptor reduction and hydrogen thresholds as indicators of halorespiratory physiology. *Appl Environ Microbiol* 65:4049-4056

Lu X, JT Wilson, DH Kampbell (2006) Relationship between *Dehalococcoides* DNA in ground water and rates of reductive dechlorination at field scale. *Water Res* 40:3131-3140

Lu, X-X, S Tao, T Bosma, J Gerritse (2001) Characteristic hydrogen concentrations for various redox processes in batch study. *J Environ Sci Health, Part A* 36:1725-1734

Major DW, ML McMaster, EE Cox, EA Edwards, SM Dworatzek, ER.Hendrickson, MG Starr, JA Payne, LW Buonamici (2002) Field demonstration of successful bioaugmentation to achieve dechlorination of tetrachloroethene to ethene. *Environ Sci Technol* 36:5106-5116

Maymó-Gatell X, T Anguish, SH Zinder (1999) Reductive dechlorination of chlorinated ethenes and 1,2-dichloroethane by "*Dehalococcoides ethenogenes*" 195. *Appl Environ Microbiol* 65:3108-3113

Maymó-Gatell X, YT Chien, JM Gossett, SH Zinder (1997) Isolation of a bacterium that reductively dechlorinates tetrachloroethene to ethene. *Science* 276:1568-1571

McCarty, PL., M-Y. Chu, PK Kitanidis. 2006 Electron donor and pH relationships for biologically enhanced dissolution of chlorinated solvent DNAPL in groundwater. *European J Soil Biol.* 43: 276-282

Moran MJ, Zogorski, S (2007) Chlorinated solvents in groundwater of the United States. *Environ Sci Technol* 41:74-81

Müller JA, BM Rosner, G von Abendroth, G Meshulam-Simon, PL McCarty, AM Spormann (2004) Molecular identification of the catabolic vinyl chloride reductase from *Dehalococcoides* sp. strain VS and its environmental distribution. *Appl Environ Microbiol* 70:4880-4888

Ritalahti KM, BK Amos, Y Sung, Q Wu, SS Koenigsberg, FE Löffler (2006) Quantitative PCR targeting 16S rRNA and reductive dehalogenase genes simultaneously monitors multiple *Dehalococcoides* strains. *Appl Environ Microbiol* 72:2765-2774

Schaefer CE, CW Condee, S Vainberg, RJ. Steffan (2009) Transport, growth, and activity of *Dehalococcoides* sp. in saturated soil during bioaugmentation of chlorinated ethenes. Submitted

Seshadri, R. L. Adrian, D. E. Fouts, J. A. Eisen, A. M. Phillippy, B. A. Methe, N. L. Ward, W. C. Nelson, R. T. Deboy, H.M. Khouri, J. F. Kolonay, R. J. Dodson, S. C. Daugherty, L. M. Brinkac, S. A. Sullivan, R. Madupu, K. E. Nelson, K. H. Kang, M. Impraim, K. Tran, J. M. Robinson, H.A. Forberger, C.M. Fraser, S. H. Zinder, J. F.

Heidelberg. 2005. Genome Sequence of the PCE-Dechlorinating Bacterium
Dehalococcoides ethenogenes . Science 307:105-108.

Shelton, D.R. and J.M. Tiedje. 1984. General method for determining anaerobic
biodegradation potential. Appl. Environ. Microbiol. 47: 850-857.

Smidt H, WM de Vos (2004) Anaerobic microbiol dehalogenation. Ann Rev
Microbiol 58:43-73

Stafford, K. 1986. Continuous fermentation. pp 137-151 in A. L. Demain and N. A.
Solomon (eds) Manual of Microbiology and Biotechnology. American Society for
Microbiology, Washington, D.C.

Steffan, R. J., K. L. Sperry, M. T. Walsh, S. Vainberg, and C. W. Condee. 1999.
Field-scale evaluation of in situ bioaugmentation for remediation of chlorinated
solvents in groundwater. Environ. Sci. Technol. 33:2771-2781.

Sung Y, Ritalahti KM, Apkarian RP, Löffler (2006) Quantitative PCR confirms
purity of strain GT, a novel trichloroethene-to-ethene-respiring *Dehalococcoides*
isolate. Appl Environ Microbiol 72:1980-1987

Unterman, R., M. F. DeFlaun, and R. J. Steffan. 2000. Advanced in situ bioremediation- a hierarchy of technology choices. pp. 399-414 in, J. Klein, ed., Biotechnology Vol. 11b, Environmental Processes II, , Wiley –VCH, New York.

Vainberg, S., C. W. Condee, R. J. Steffan. 2009. Large scale production of *Dehalococcoides sp.*-containing cultures for bioaugmentation. In Review.

Westrick JJ, JW Mello, RF Thomas (1984) The groundwater supply survey. J Am Water Works Assoc 76:52-59

Yang, Y, PL McCarty (1998) Competition for Hydrogen within a Chlorinated Solvent Dehalogenating Anaerobic Mixed Culture. Environ. Sci. Technol., 32:3591 - 3597

Zhang J, J Andrew P, Chiu, PC (2006) 1,1-Dichloroethene as a predominant intermediate of microbial trichloroethene reduction. Environ Sci Technol 40:1830-1836

Table 1. List of leading vendors of bioaugmentation cultures.

Vendor	Culture Name	Contact Information
Adventus America, Inc.	Dechlorination culture	815-235-3503; http://www.adventusgroup.com/
BCI, Inc.	BCI-e	617-923-0976; http://www.bcilabs.com
EOS Remediation, LLC	BAC-9 TM	888-873-2204; http://www.eosremediation.com/
Redox Tech, LLC	RBC-1	919-678-0140; http://www.redox-tech.com/
Regenesis	Bio-Dechlor INOCULUM® PLUS(+)	949-366-8000; http://www.regenesis.com
Shaw Environmental, Inc	SDC-9 TM , Hawaii-05 TM	609-895-5350; http://www.shawgrp.com/bioaugmentation
SiREM Labs	KB-1 [®]	519-822-2265; http://www.siremlab.com
Terra Systems, Inc.	TSI DC Bioaugmentation Culture TM	302-798-9553; http://www.terrasystems.net

Table 2. Results of multiple fermentation runs with the tested chlorinated solvent dechlorinating consortia.

Culture	Date M/Y	Volume (L)	Final OD₅₅₀	Final DHC (cells/L)*	DWT (mg/L)	PCE Activity (mg/h/g dwt)	cDCE Activity (mg/h/g dwt)
SDC-9	01/2006	550	1.3	1.4 E11	0.51	16	13
SDC-9	02/2008	550	1.7	2.8 E11	0.66	22	14
SDC-9	03/2008	3200	1.6	1.4 E11	0.65	41	37
SDC-9	05/2008	2500	1.6	2.4 E12	0.59	42	39
SDC-9	08/2008	2000	1.4	1.0 E12	0.51	80	69
PJKS	01/2008	2500	1.1	9.4 E11	0.41	32	14
PJKS	02/2008	1700	1.3	1.0 E11	0.50	64	45
Hawaii-05	11/2007	550	1.2	1.5 E11	0.50	23	16

* based on qPCR assuming 1 16S rRNA gene copy/cell

Table 3. Effect storage temperature on PCE degradation activity of SDC-9™.

Time (d)	PCE dechlorination rate (mg/L x h)*			
	4 °C	13 °C	22 °C	28 °C
0	6.45 ± 0.29	6.45 ± 0.29	6.45 ± 0.29	6.45 ± 0.29
7	ND	ND	1.20 ± 0.11	0.33 ± 0.10
14	7.30 ± 0.13	4.10 ± 0.57	ND	ND
35	8.20 ± 0.70	2.28 ± 0.10	0.70 ± 0.03	0.23 ± 0.05
82	4.20 ± 0.19	0.57 ± 0.38	ND	ND

* values represent mean ± SE of triplicate samples; ND – not determined

Figure Legends

Figure 1. Growth of SDC-9 consortium in a 4000-L fermentor. Panel A: Fermentor inoculated with fresh concentrated culture directly from a 750-L fermentor. Yeast extract (0.2% w/w) was added at the beginning to the fermentation. Panel B: Fermentor inoculated with concentrated culture that had been stored for 19 days at 4-6 °C. Yeast extract (0.1% w/w) was at the beginning of the fermentation and on day 22 of fermentation. In each case sodium lactate and PCE were used as electron donor and electron acceptor substrates, respectively. Open columns (□) represent DHC cells (by qPCR) and filled columns (■) represents total cells as measured by optical density at 550 nm (OD₅₅₀). Panel C: Changes of concentration of PCE, cis-DCE and VC during the fermentation of SDC-9 in 4000-liter fermentor. Initially PCE and Yeast Extract were added to medium to a final concentrations 20 mg/L and 0.1%, respectively. Sodium lactate feeding (0.03 ml/h x L) was initiated after one day of fermentation.

Figure 2. DHC concentration relative to total Eubacteria in the SDC-9 consortium during the growth in a 750-L fermentor.

Figure 3. Accumulation of volatile fatty acids (VFAs) during growth of SDC-9TM (Panel A) or PJKSTM (Panel B) in a 750-L fermentor. Yeast extract (0.1%) was added at the beginning of the fermentation.

Figure 4. Effect of pH on PCE dehalogenation by SDC-9. Values represent the mean of triplicate samples, and error bars represent one standard error of the mean.

Figure 5. Change of pH during growth of SDC-9 in a 4000 L fermentor.

Yeast extract (0.1%) was added at the beginning of the fermentation and again on day 22. Nitrogen sparging was conducted on days 25, 31, 32 and 33.

Figure 6. Effect of elevated concentration of total dissolved solid (TDS) on SDC-9 dechlorination rates. NaCl was added to RAMM medium to a final TDS concentration of 1000 mg/L. The control samples were prepared with only RAMM medium.

Figure 7. Effect of nitrogen sparging on pH during fermentation of the PJKS culture. Yeast extract (0.1%) was added at the beginning of the fermentation, and again on day 16 (0.05%). Sodium lactate (60% solution) feeding began on day two at a rate of 21.6 $\mu\text{l/h} \times \text{L}$, and it was increased to 24 $\mu\text{l/h} \times \text{L}$ on day three and 28.8 $\mu\text{l/h} \times \text{L}$ day 11.

Figure 8. Effect of nitrogen sparging on the pH of an SDC-9 culture in a 750-L fermentor at 28 °C. The OD_{550} of the culture at the time of sparging was 1.1.

Figure 9. Dechlorination assay to monitor the specific activity of a fermented SDC-9 culture. The degradation of PCE (Panel A) and cDCE (Panel B) was measured. The incubation temperature was 28°C the DHC concentration was 1.4×10^{12} , the $\text{OD}_{(550)}$ was 1.6, and the dry weight was 0.65 g/L.

Figure 10. Stainless steel cross flow membrane cell concentration system. The steel shells contain tubular ceramic membranes.

Figure 11. Membrane concentration of a 3500-L SDC-9 culture by using in a ceramic membrane cell concentration system.

Figure 12. 5-gal. (18.5-L) stainless steel soda keg used to deliver and inject DHC-containing cultures (see Fig. 15).

Figure 1A. Growth of SDC-9 in 4000-L fermentor

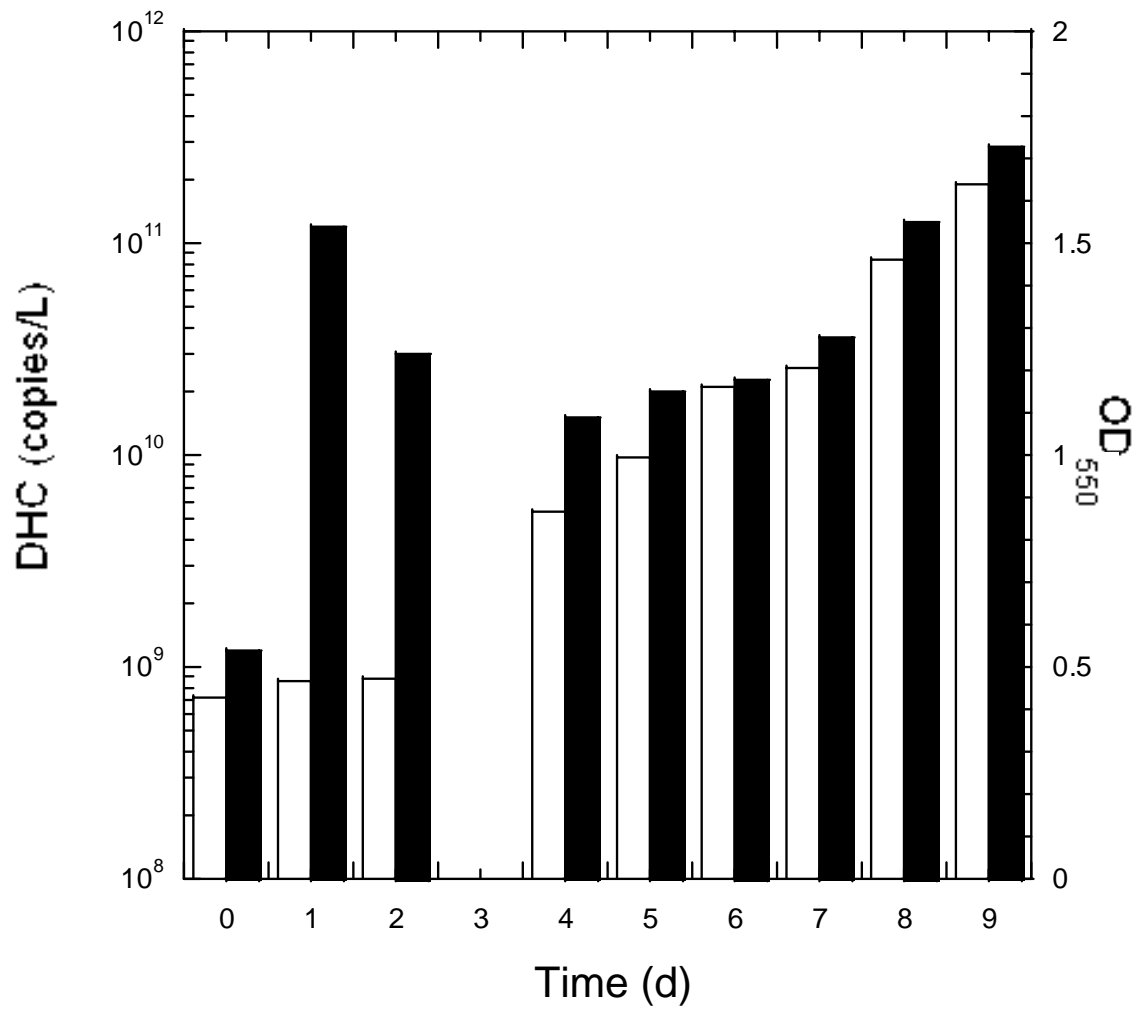

Figure 1B. Growth of SDC-9 in 4000-L fermentor

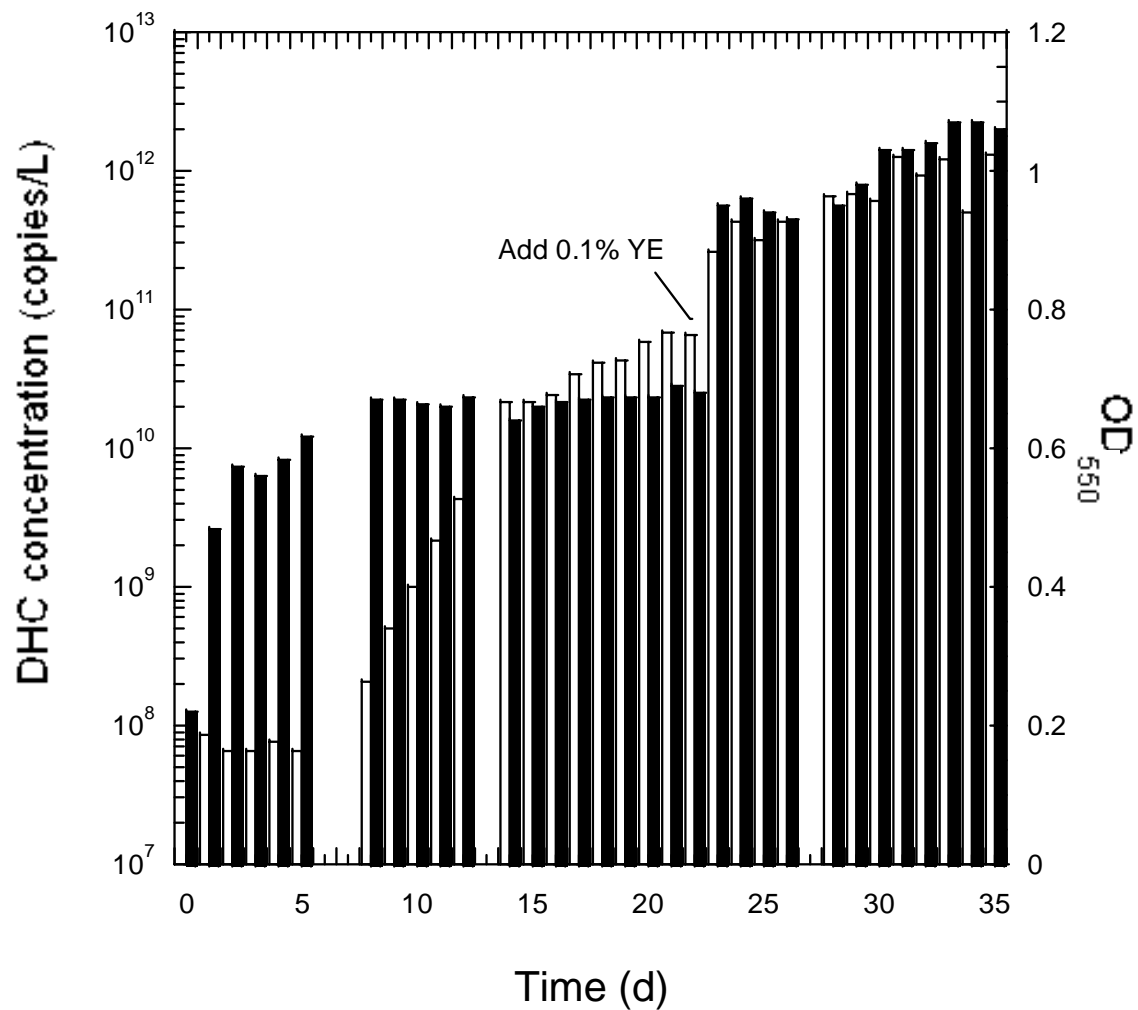

Figure 1c.

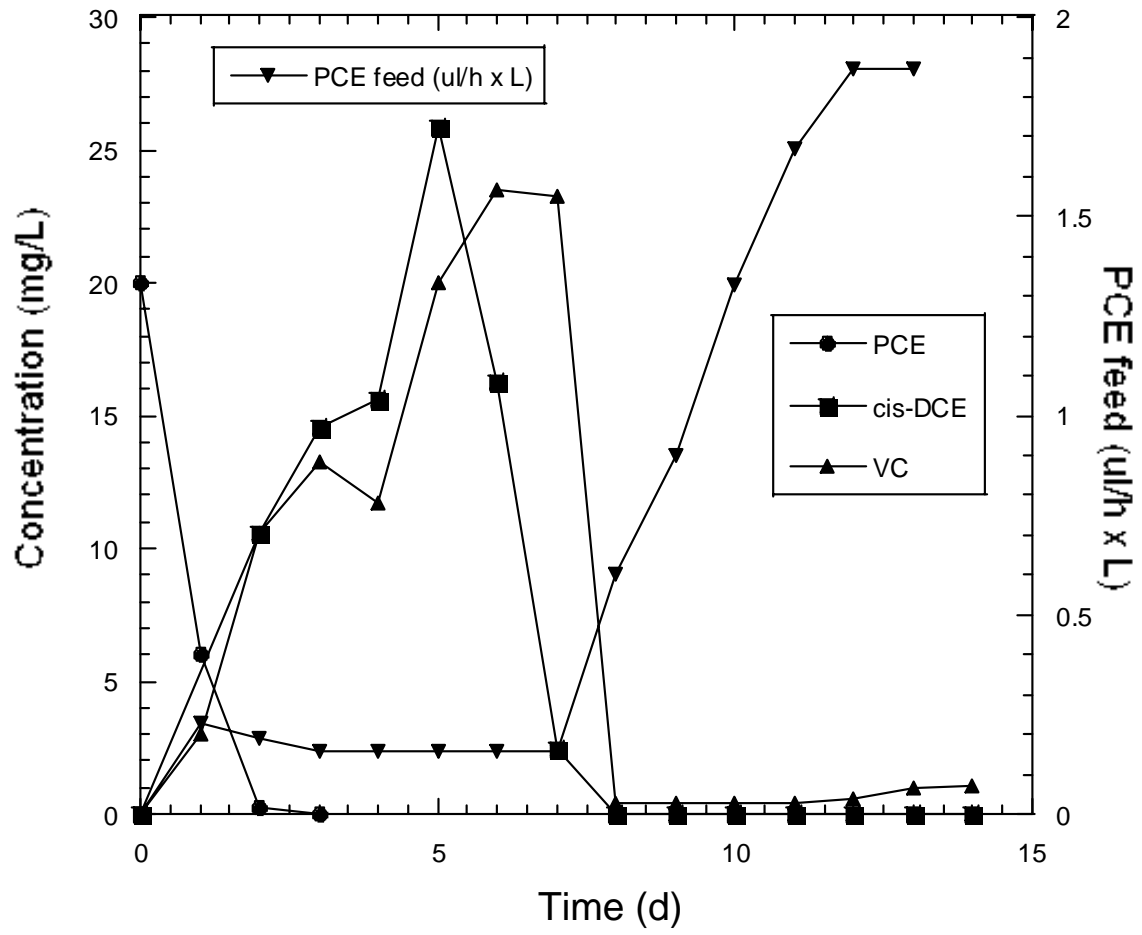

Figure 2.

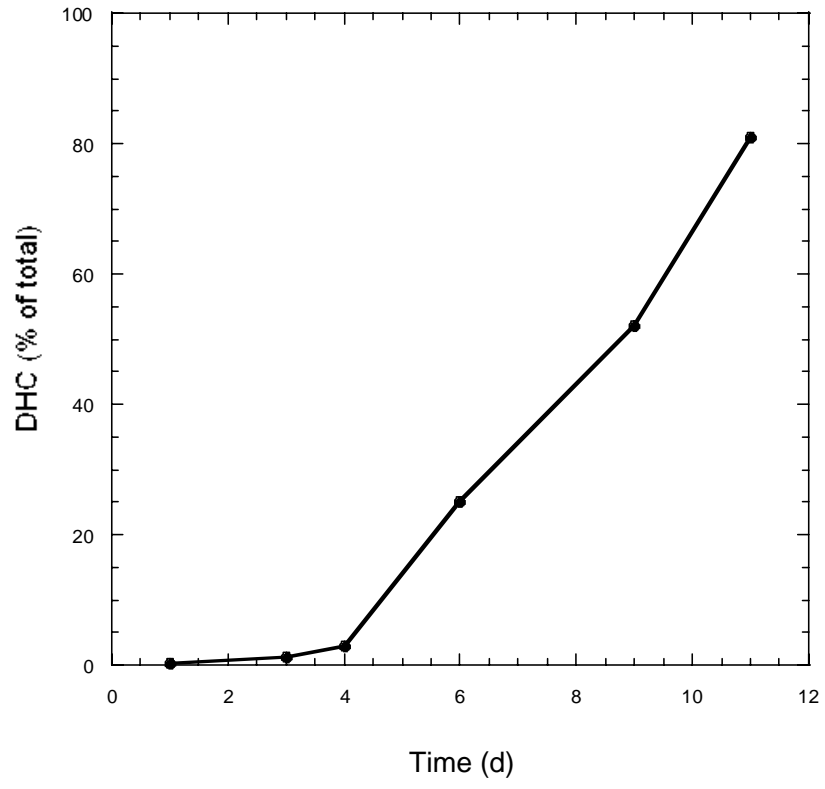

Figure 3A. SDC-9 VFAs

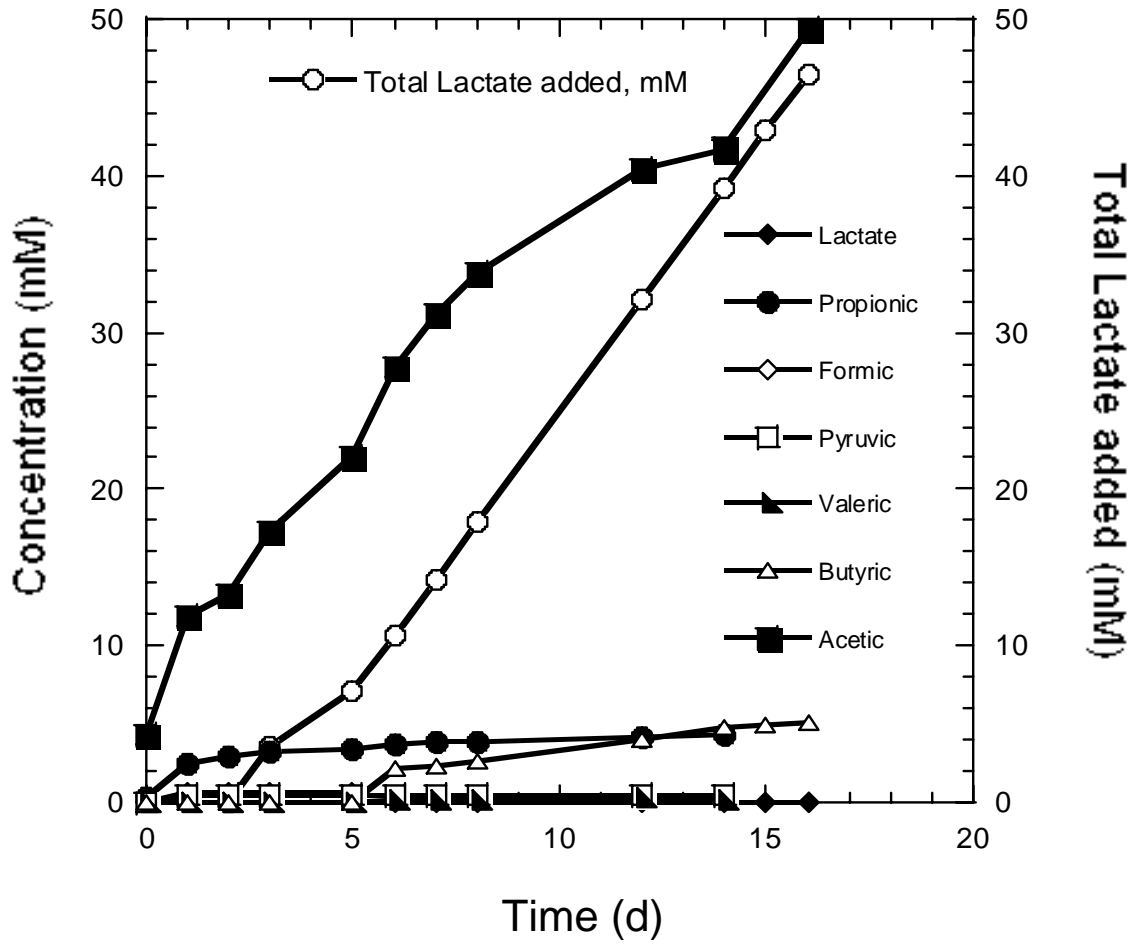

Figure 3B. PJKS VFAs

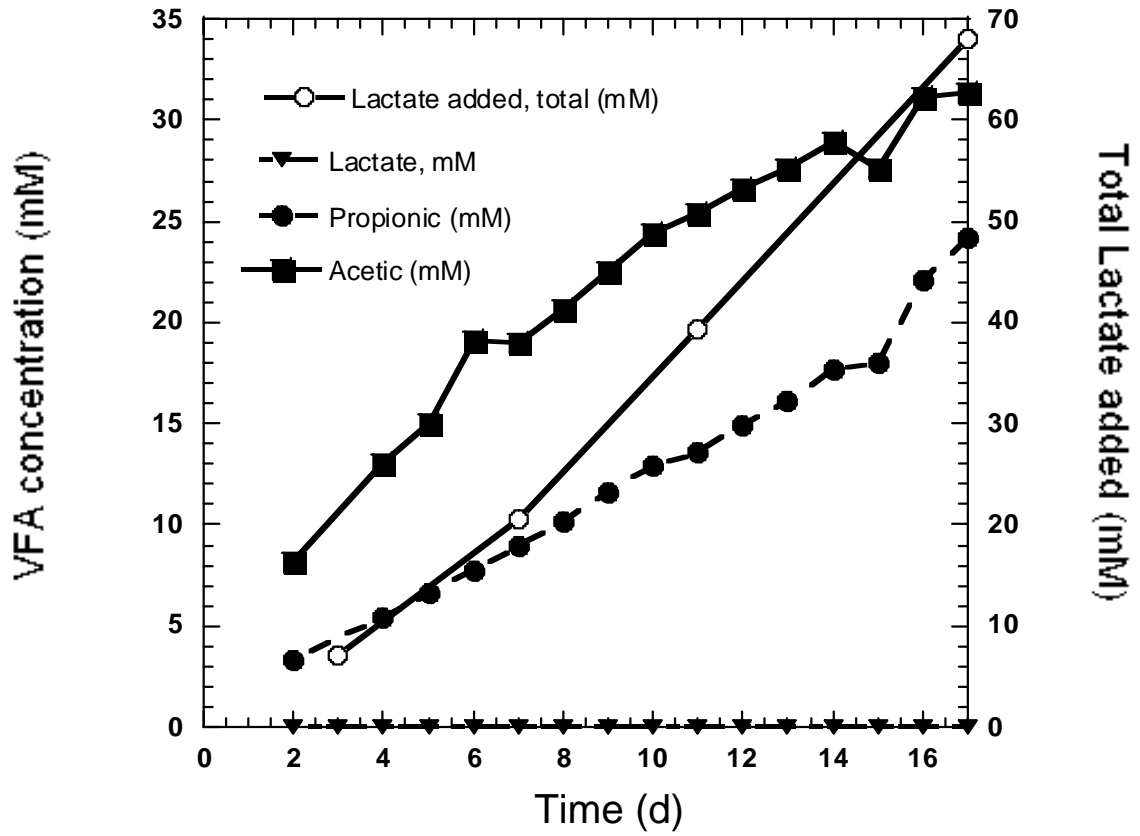

Figure 4

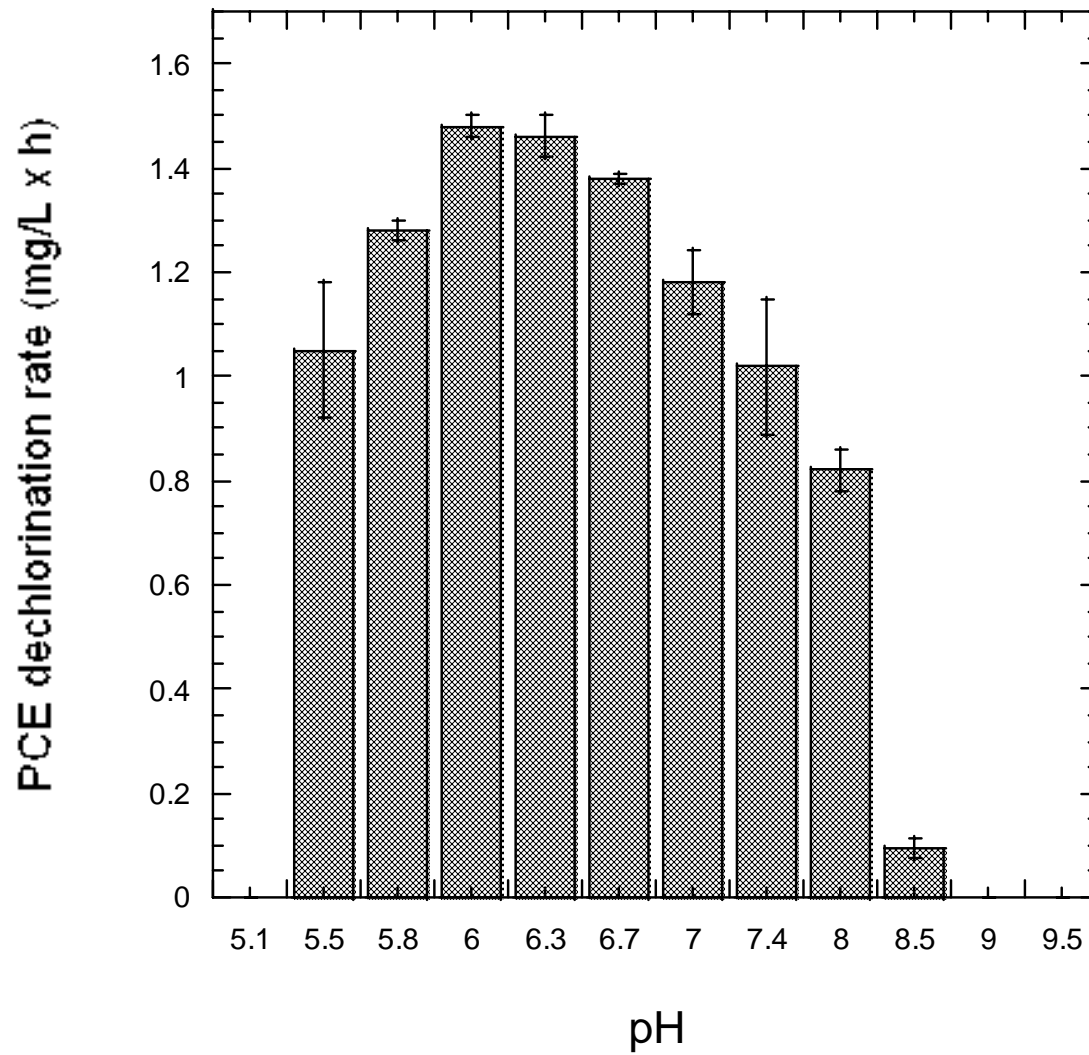

Figure 5. pH of SDC-9 consortium in 4000 L

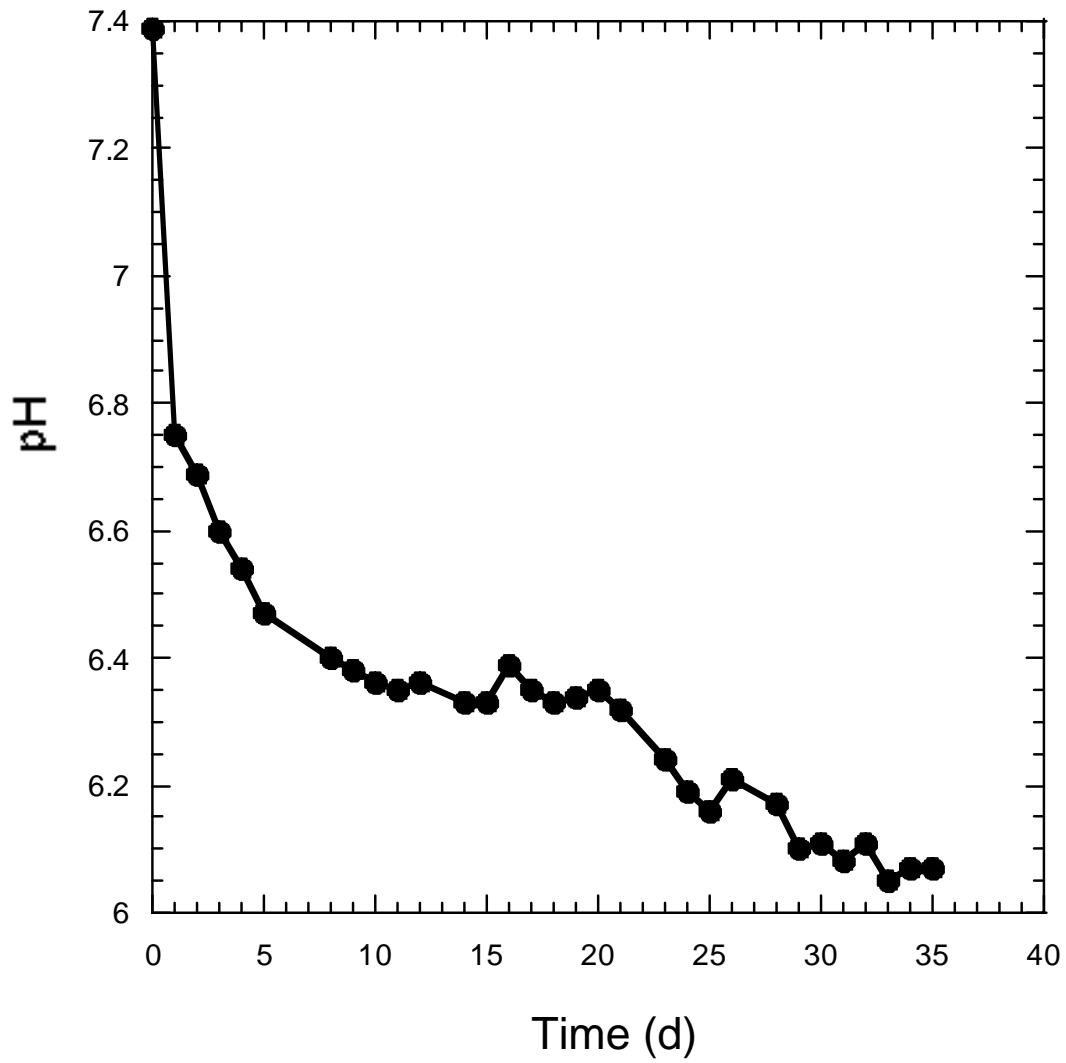

Figure 6. Effect of TDS.

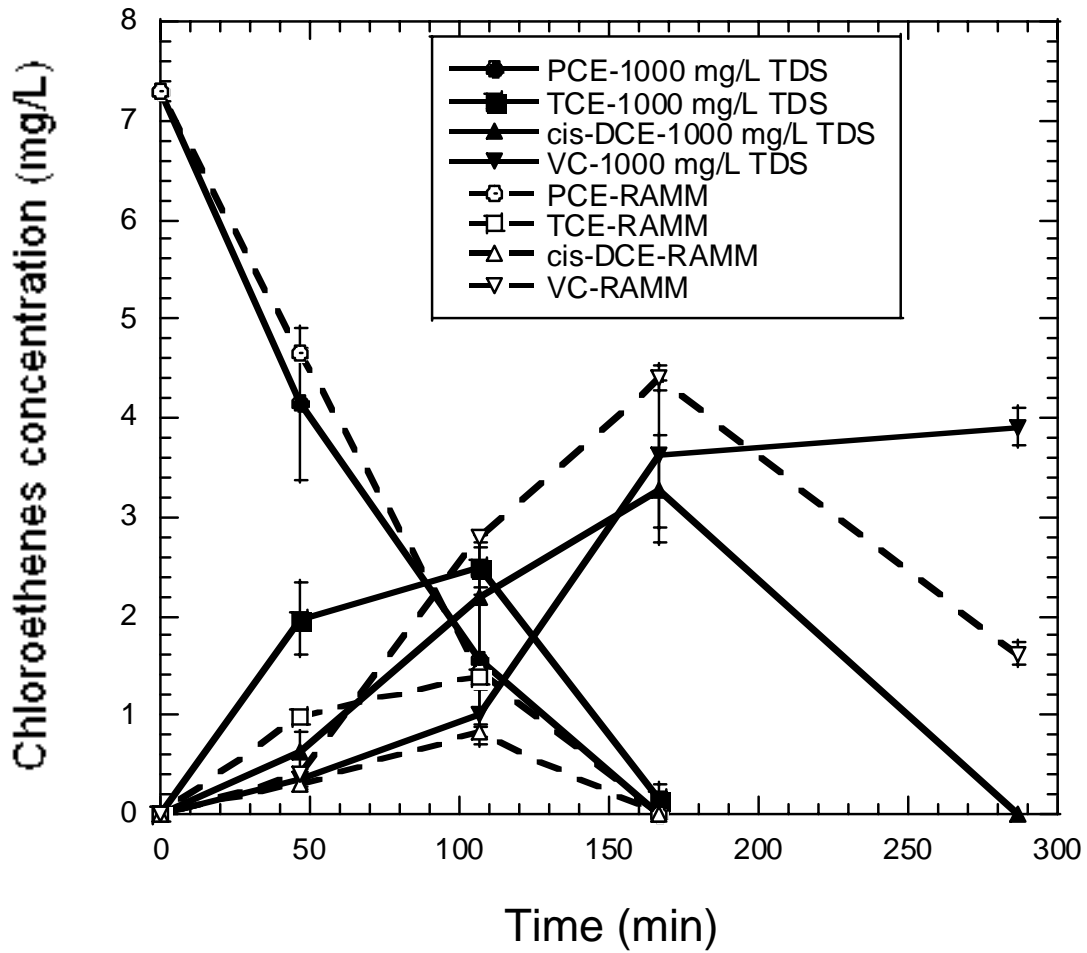

Figure 7. Nitrogen sparging of PJKS culture

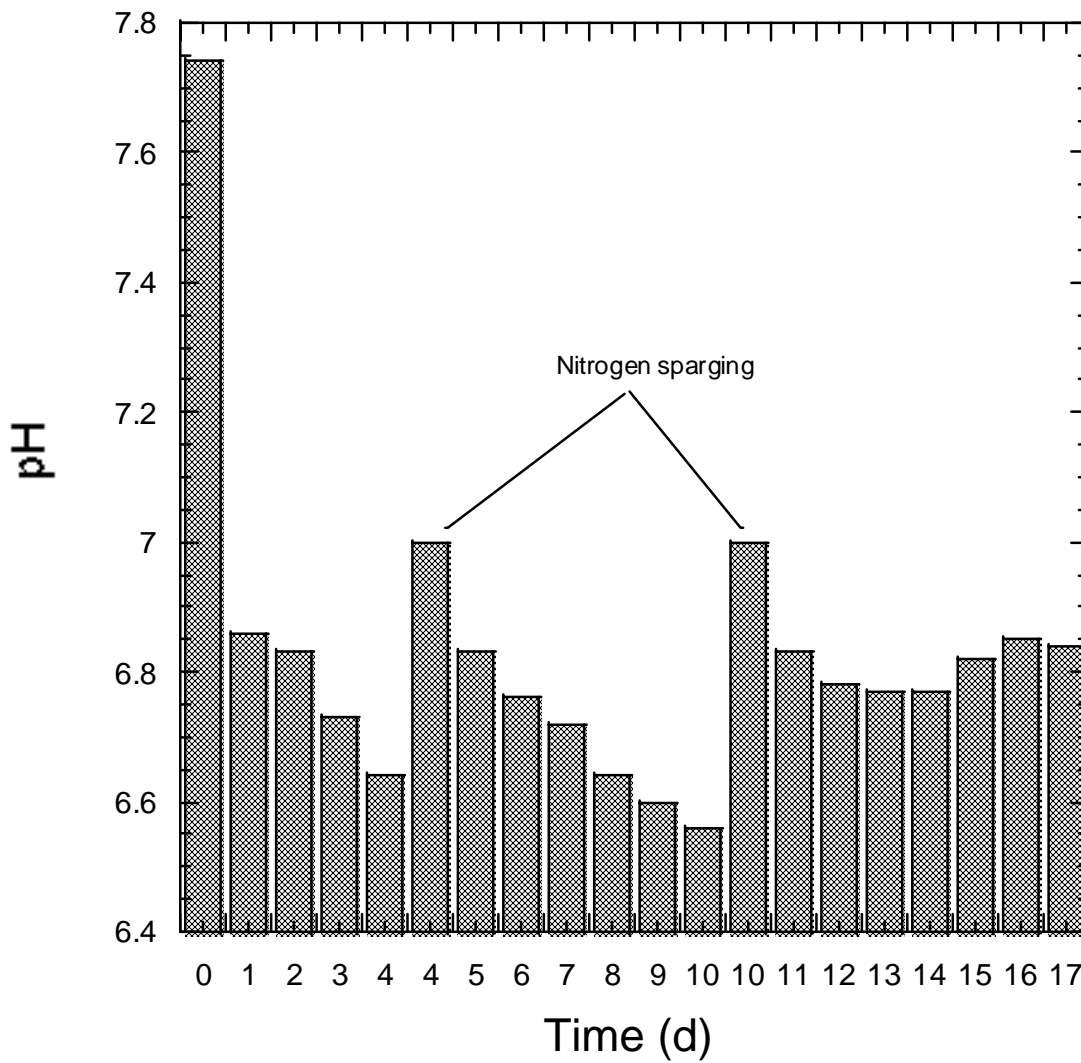

Figure 8. Effect of Nitrogen sparging.

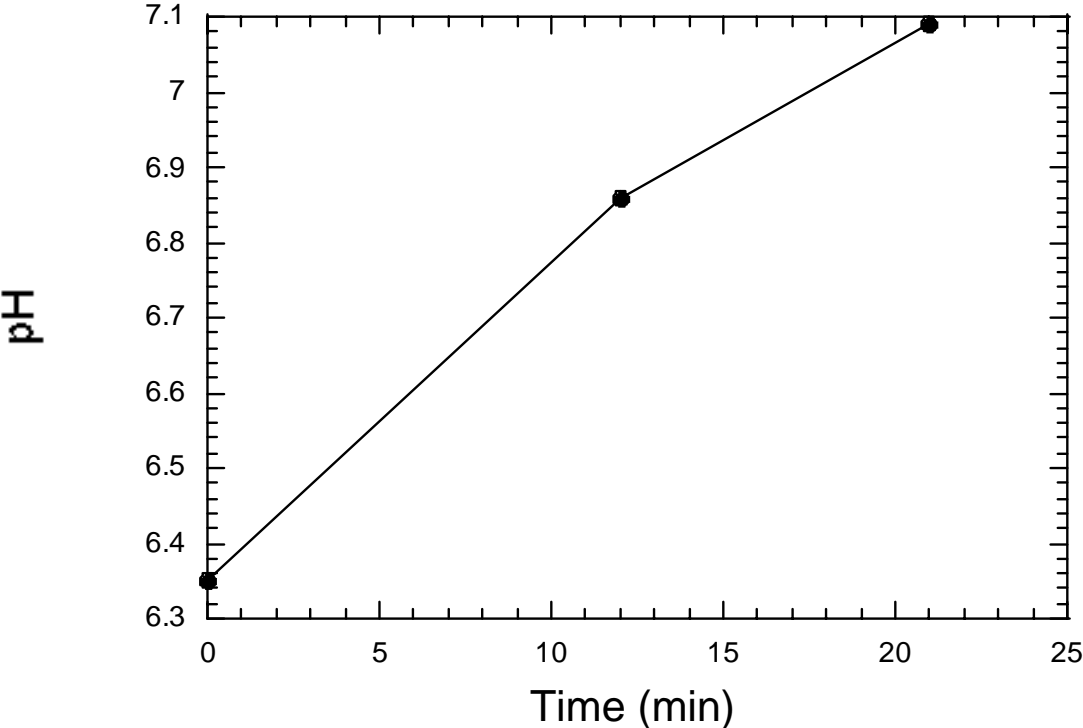

Figure 9A PCE Degradation

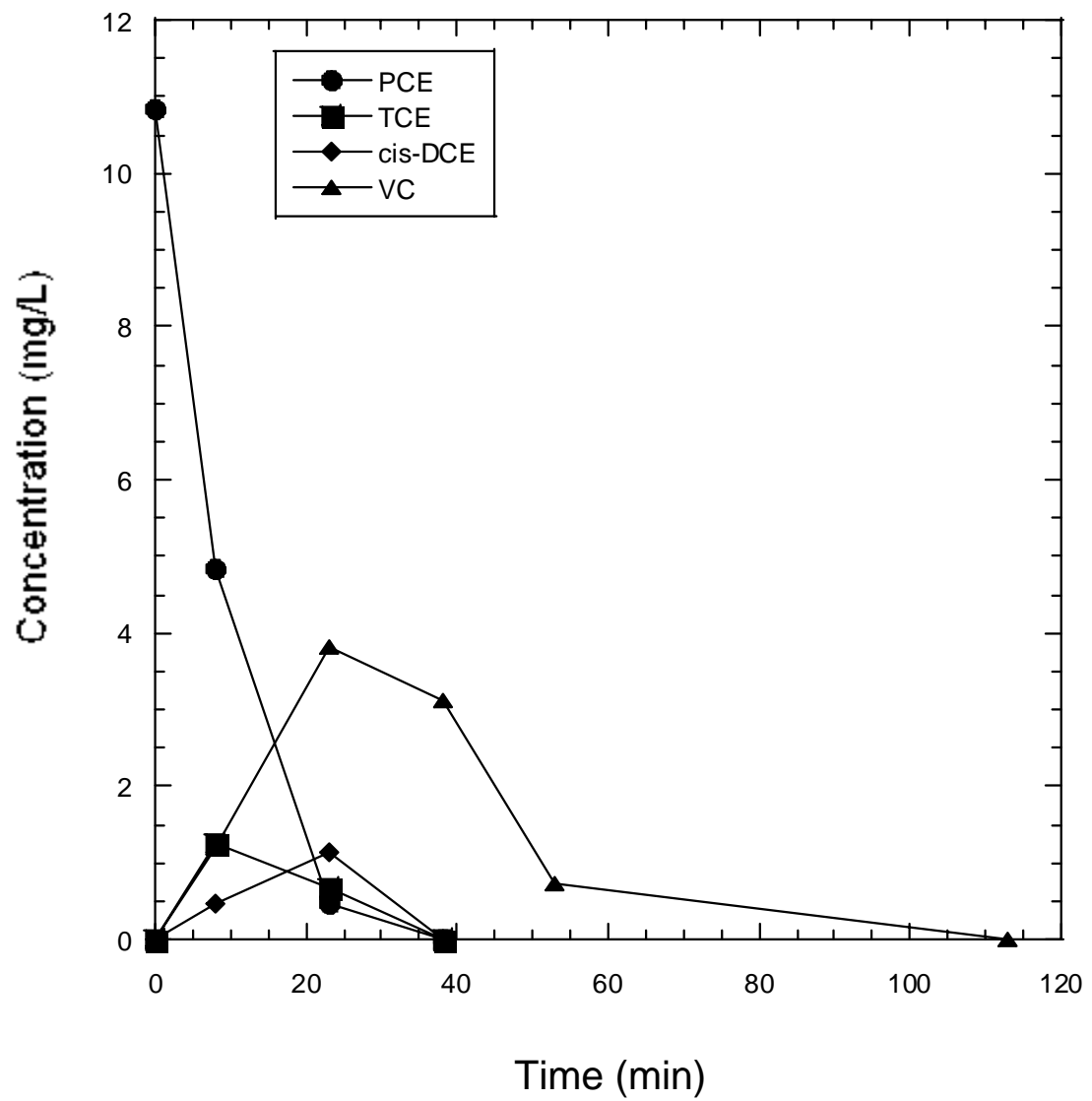

Figure 9B.

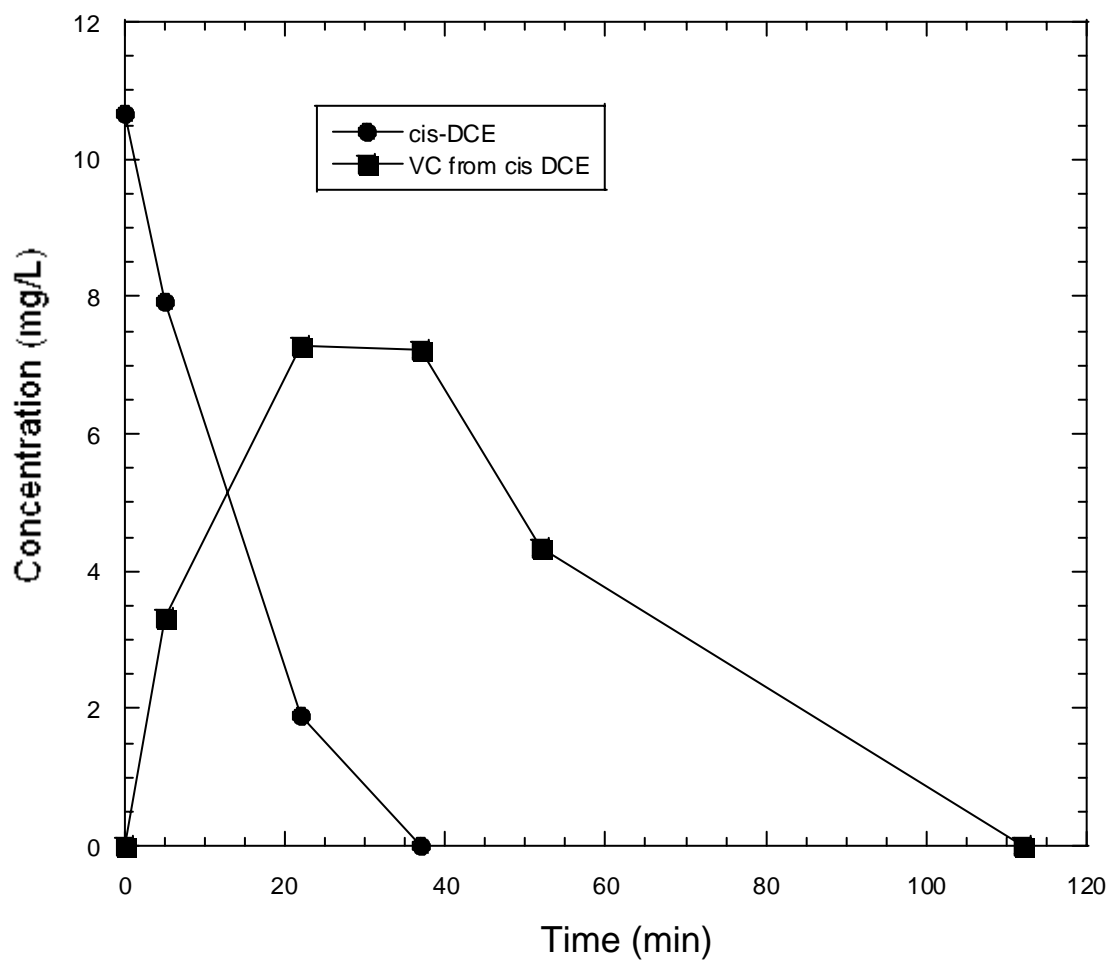

Figure 10. Concentration of a 4000-L SDC-9 culture.

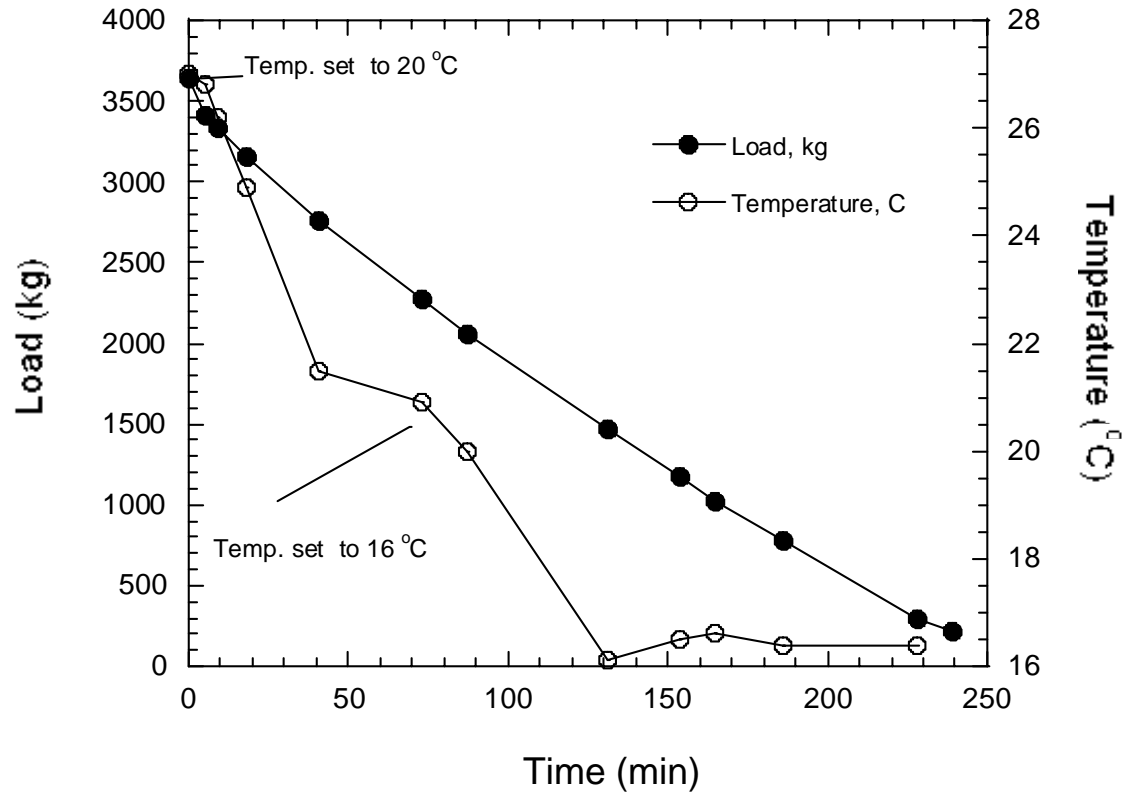

Fig. 11



Fig. 12



185 L of SDC-9 Culture Concentrated to 18.5 L



Culture Keg with Quick Disconnects Pressurized with N₂



Injection Accessories



Culture Keg in Cooler



185 L of SDC-9 Culture Ready to Ship via O/N Courier

APPENDIX C

Publication: “Bioaugmentation for chlorinated ethenes using *Dehalococcoides* sp.: Comparison between batch and column experiments”.



Bioaugmentation for chlorinated ethenes using *Dehalococcoides* sp.: Comparison between batch and column experiments

Charles E. Schaefer*, Charles W. Condee, Simon Vainberg, Robert J. Steffan

Shaw Environmental, Inc., 17 Princess Road, Lawrenceville, NJ 08648, United States

ARTICLE INFO

Article history:

Received 23 June 2008

Received in revised form 15 December 2008

Accepted 16 December 2008

Available online 25 January 2009

Keywords:

Dehalococcoides

Kinetics

Transport

TCE

DCE

Bioaugmentation

ABSTRACT

Batch and column experiments were performed to evaluate the transport, growth and dechlorination activity of *Dehalococcoides* sp. (DHC) during bioaugmentation for chlorinated ethenes. Batch experiments showed that the reductive dechlorination of trichloroethene (TCE), *cis*-1,2-dichloroethene (DCE), and vinyl chloride (VC), as well as growth of the DHC, were well described by the Monod kinetic model. The measured maximum utilization rate coefficients for TCE, DCE, and VC were 1.3×10^{-12} , 5.2×10^{-13} , and 1.4×10^{-12} mmol Cl⁻ (cell h)⁻¹, respectively. Results of the column experiments showed that dechlorination occurred throughout the length of the column, and that extractable DHC concentrations associated with the soil phase throughout the column were negligible relative to the aqueous phase concentrations. Dechlorination rates relative to aqueous DHC concentrations in the column were approximately 200-times greater than in the batch experiments. Additional batch experiments performed using column effluent water confirmed this result. Incorporation of these enhanced dechlorination kinetics in the transport model provided a reasonable prediction of the column data. Overall results of this study suggest that aqueous phase (as opposed to soil phase) DHC concentrations can be used to estimate dechlorination activity in saturated soils, and DHC dechlorination activity in porous media may be substantially greater than DHC dechlorination activity measured in batch experiments.

© 2008 Elsevier Ltd. All rights reserved.

1. Introduction

Groundwater contamination by chlorinated ethenes is a widespread environmental concern. Several laboratory studies (Yu and Semprini, 2004; Becker, 2006) and field demonstrations (Major et al., 2002; Adamson et al., 2003; Ritalahti et al., 2005) have shown that bioaugmentation using *Dehalococcoides* sp. (DHC), which are the only microbial genus known to completely dechlorinate tetrachloroethene (PCE) and trichloroethene (TCE) (Maymó-Gatell et al., 1997), can be an effective *in situ* groundwater treatment technology for chlorinated ethenes.

Several batch studies to evaluate DHC kinetics and chlorinated ethene reductive dechlorination have been performed (Cupples et al., 2003, 2004; Lee et al., 2004). These studies demonstrated that DHC growth and reductive dechlorination of *cis*-1,2-dichloroethene (DCE) and vinyl chloride (VC), which are intermediate products for PCE and TCE biotransformation, can be described using Monod kinetics and by incorporating a competition term between the electron acceptors. Lee et al. (2004) showed that two separate groups of dehalogenators were responsible for completely dechlorinating PCE in their consortium, where one group was responsible for PCE and TCE degradation, and the other group was responsible

for DCE and VC degradation; competitive inhibition was assumed within each group. He et al. (2003) had findings that were consistent with this two dehalogenator group model, demonstrating the presence of DHC that utilized DCE and VC, but not PCE or TCE. In contrast, Yu et al. (2005) showed that two DHC-containing cultures exhibited competitive behavior among TCE, DCE, and VC, and developed a Monod kinetic model that described DHC growth utilizing these compounds.

Several column studies have been performed to evaluate microbial transport through saturated soils. Straining and filtration processes, as well as the presence of biofilms, often control microbial transport in soils (Ginn et al., 2002). Fuller et al. (2000) also have shown that sub-populations of a microbial consortium may exhibit a range of adhesion properties, resulting in variable transport distances of a specific inoculum in soil.

While there have been several studies evaluating microbial transport in saturated porous media, far fewer studies have examined the combined processes of microbial growth, transport, and dechlorination activity in saturated soil. Using salicylate as the model degraded organic compound, Brusseau et al. (2006) demonstrated that degradation kinetics were similar in both batch and column studies; bacterial transport through sand was modeled using a cell loss function. Others (Clement et al., 1997; Kim and Corapcioglu, 1997) showed that biofilm growth, followed by microbial detachment and downstream re-attachment, described

* Corresponding author. Tel.: +1 609 895 5372; fax: +1 609 895 1858.

E-mail address: charles.schaefer@shawgrp.com (C.E. Schaefer).

contaminant and bacterial transport. Some studies (Yolcubal et al., 2002; Walker et al., 2005) have shown that actively growing bacteria are more mobile and less adhesive than bacteria existing under low-growth conditions, while others (Sanin et al., 2003; Gargiulo et al., 2007) have shown that actively growing bacteria are less mobile and more adhesive.

Currently, we are unaware of any published studies that evaluate and directly measure the growth, dechlorination activity, and transport of DHC in saturated soil. As such, the processes controlling DHC distribution and overall remedial effectiveness during *in situ* bioaugmentation are poorly understood, resulting in uncertainties about the dosage of DHC needed to treat sites, and the expected remedial timeframes. To address some of these uncertainties, we evaluated and directly measured DHC transport, growth, and chlorinated ethene dechlorination activity in saturated soil columns. Measurements obtained during batch and column studies were compared, providing qualitative and quantitative insight into bioaugmentation processes in porous media.

2. Experimental

2.1. Materials

Natural groundwater used for the column experiments was collected from a TCE- and DCE-contaminated US Air Force facility in Ft. Worth, Texas. Geochemical characterization of the groundwater showed that the alkalinity was moderately elevated (220 mg L⁻¹ as calcium carbonate), with a pH of approximately 7.1. Groundwater nitrate and sulfate levels were 30 and 70 mg L⁻¹, respectively; total organic carbon levels in the groundwater ranged between 2.7 and 4.6 mg L⁻¹. Soil was collected from the same facility, and was characterized as a clayey sand. All soil was homogenized and passed through a 6.4-mm screen prior to use.

The DHC-containing consortium used in this study was the commercially available SDC-9 (Shaw Environmental, Inc., Lawrenceville, NJ). The culture was isolated by enrichment culturing of aquifer samples from a southern California site. For use in the study, the culture was grown on lactate and yeast extract with PCE as an electron acceptor (except where noted). The culture contains at least two DHC-type organisms as determined by denaturing gradient gel electrophoresis (Microbial Insights, Knoxville, TN) (data not presented), and it is able to respire PCE, TCE, DCE and VC. The role of the individual DHC strains in dehalorespiration of these compounds, and the identity of lactate fermenting strains in the culture, have not been determined.

Sodium-(L)-lactate (60% solution) was purchased from Purac America (Lincolnshire, IL). DCE and VC were purchased from Supelco (Bellefonte, PA) as 2000 µg mL⁻¹ in methanol. TCE, stabilized ACS reagent, was purchased from J.T. Baker Inc. (Phillipsburg, NJ).

2.2. Batch experiments

Batch experiments were performed to determine the Monod kinetic and microbial growth parameters for the DHC consortia. Initial batch experiments were performed in 60-mL glass serum bottles with Teflon-lined rubber septa to regress the Monod parameters. All bottle preparation was performed in an anaerobic glove box under a 100% nitrogen atmosphere. Each bottle was amended with 30 mL of reduced anaerobic mineral medium (RAMM) (Shelton and Tiedje, 1984), sodium lactate (final concentration of 1000 mg L⁻¹), and an initial inoculum of DHC. Experiments were performed with different contaminant mixtures: VC-only, DCE-only, VC + DCE, TCE-only, and TCE + DCE + VC. This experimental approach, similar to that performed by others (Cupples et al., 2004), facilitated regression of the kinetic param-

eters (discussed in Section 3). Controls, containing no DHC or lactate, also were prepared. All experiments were prepared in duplicate. Bottles were incubated on an orbital shaker (Lab-Line Instruments, Melrose Park, IL) at 120 rpm at room temperature (approximately 21 °C). Bottle headspace was sampled as a function of time to determine dechlorination rates. Henry's law was used to calculate aqueous concentrations.

Additional batch experiments (prepared in duplicate) were performed similarly to those described above, except that 8.5 g of soil was added to each bottle and sodium lactate was re-amended to the bottles every 3 d. In one set of experiments, the DHC used as inoculum was grown with DCE as the electron acceptor. In another set of experiments, bottles were amended with lactate, DCE, and VC, but no DHC. These data were used to evaluate the model, and determine potential impacts of soil on observed dechlorination kinetics.

To validate the model and regressed parameters, as well to observe and evaluate DHC growth rates, a third set of batch experiments was performed in two 7-L autoclavable bioreactors (Applicon, Inc., Foster City, CA), with one reactor employed as a control and the other "active" reactor used to monitor chlorinated ethene reductive dechlorination and DHC growth. Approximately 100 g of autoclaved soil and 6 L of RAMM medium were added to each reactor. Soil was autoclaved to limit activity of indigenous TCE-degrading microorganisms potentially present in the soil. Reactors were sterilized at 121 °C for 30 min, and then sparged with nitrogen to remove oxygen. The actively growing DHC consortium, sodium lactate, and TCE were then added to the active reactor so that final concentrations of 9.5×10^7 DHC cell L⁻¹, 1300 mg L⁻¹, and 15 mg L⁻¹ (respectively) were attained. For the control, no DHC or lactate was added.

The reactors were operated at room temperature (~21 °C) and mixed at 250 rpm. Sodium lactate was continuously fed to the active reactor so that excess lactate was constantly present. The reactors were operated for 19 d, with periodic sampling for chlorinated ethenes, DHC, reduced gases, and volatile fatty acids.

2.3. Growth experiment

An additional reactor experiment was performed, in duplicate, to measure the DHC growth rate on DCE. These growth experiments were performed identically to the previously described reactor experiments, except that no soil was added, and DCE was continuously fed to the reactor.

2.4. Soil columns

Column experiments were performed to simultaneously evaluate DHC transport, growth, and DCE and VC reductive dechlorination kinetics in soil. Columns were prepared using a 7.2 cm diameter × 20 cm long section of aluminum tubing sealed with Teflon end caps, and packed with approximately 1.3 kg of soil for a bulk density of approximately 1.7 kg L⁻¹. The center of the end caps were drilled and tapped to attach stainless steel fittings for influent and effluent lines and sampling ports. Two additional sampling ports were equally spaced along the length of the column with 16 gauge stainless steel needles extending to the column's center and controlled by stop cocks.

Influent groundwater was amended with DCE and lactate at concentrations of 12 and 750 mg L⁻¹, respectively; the DCE influent concentration was reduced to 10 mg L⁻¹ immediately after injection of the DHC. Influent groundwater also was amended with RAMM medium at 0.1-times the concentration used in the batch experiments. DCE was selected as the model contaminant because the soil contained native TCE-degrading bacteria, but did not contain bacteria that could degrade DCE (as observed during parallel

microcosm experiments containing lactate, soil, and groundwater); thus, reductive dechlorination of the DCE within the soil columns was expected to be by the DHC-containing consortium only.

Groundwater was pumped from a Tedlar bag upward through the column at 5 mL h⁻¹ using a peristaltic pump. Injection of the DCE-contaminated groundwater continued until equilibrium conditions were established across the length of the column, such that the effluent and influent DCE concentrations were approximately equal. A bromide tracer test was performed during this equilibration period to facilitate calculation of the porosity, groundwater velocity, and dispersivity in the soil column.

After the DCE equilibration and bromide tracer testing was completed, 28 mL (equivalent to 0.1 column pore volumes) of the DHC-containing microbial consortia (4×10^8 DHC cell L⁻¹) was then injected. Injection (5 mL h⁻¹) of the DCE contaminated (10 mg L⁻¹) and lactate amended groundwater was resumed immediately after the DHC was delivered.

Groundwater was sampled at each of the three sampling ports as a function of time during the 8-week experiment. Samples were analyzed for DCE, VC, DHC (via quantitative polymerase chain reaction (qPCR) analysis), volatile fatty acids, and ethane/ethene. The column experiment was performed in duplicate, although most of the aqueous phase DHC sampling was performed on the first column. A third column was prepared for additional aqueous phase DHC analysis. At the end of the experiment, six soil samples were analyzed for DHC across the length of the column for each of the first two replicate columns.

To evaluate the dechlorination kinetics of the DHC eluting from the column, a batch experiment was performed using the aqueous phase DHC and groundwater that eluted from the soil column. The effluent sample was collected in a serum bottle under nitrogen headspace to maintain anaerobic conditions. The batch test was performed similarly to the previous batch experiments, except that it was performed in a 25-mL serum bottle and spiked with DCE-only; lactate was added periodically to the serum bottle to maintain excess electron donor. A corresponding control experiment was performed with an acidified sample to verify that abiotic losses were negligible.

2.5. Analytical

Chlorinated ethenes in the reactor and column experiments were analyzed via gas chromatography (GC) with mass spectrometry (MS) detection (Agilent GC-5890/MS-5971). Ethane and ethene, and the chlorinated ethenes in the batch serum bottle experiments, were analyzed using a GC equipped with a flame ionization detector (Varian 3900) equipped with Rt-Alumina Rustek column with ID 0.53 mm and length 50 m. Volatile fatty acids (consisting of lactate and its fermentation daughter products) were analyzed using an ion chromatograph (Dionex DX600).

DHC concentrations in the cultures and samples were determined by quantitative “real-time” PCR with primers (5'-gaagtagt-gaacccgaaagg and 5'-tctgtccattgtagcgtc) that amplified a 235 bp fragment of the 16S rRNA gene of DHC-type organisms. The PCR primers used were not able to distinguish between the individual DHC-like sequences in the SDC-9 consortium. A cloned DHC 16S rRNA gene from the SDC-9 culture was used as a standard, and the reactions were performed on an Idaho Technologies Light-cycler instrument (Salt Lake City, UT). DNA was extracted from the cultures and soils by using an Idaho Technologies 1-2-3 DNA Isolation Kit or a MO BIO Laboratories, Inc. Soil DNA Isolation Kit (Carlsbad, CA), respectively, according to the manufacturers' recommendations (additional details on soil extraction provided in Supplemental materials). The detection limit of this method was determined to be approximately 80 DHC-like sequences per gram of soil (based on the liquid:solid extraction

ratio and the liquid detection limit) and 4×10^4 DHC-like sequences per liter of water.

3. Model development

3.1. Microbial kinetics

Sequential dechlorination of TCE, DCE, and VC (with ethene as the end product), along with DHC growth, were modeled using Monod kinetics. Consistent with the modeling approach of Yu et al. (2005), an “aggregate” DHC biomass was considered; this DHC was assumed to participate in each step of the dechlorination process. Competitive inhibition was assumed among all three compounds, but inhibition of the less chlorinated ethenes on the more chlorinated ethenes was assumed negligible (Yu et al., 2005). Electron donor was assumed present in excess. Based on these assumptions, the following Monod-based equations are derived (Cupples et al., 2004; Yu et al., 2005):

$$-R_{\text{TCE}} \frac{dC_{\text{TCE}}}{dt} = \frac{q_{\text{TCE}}XC_{\text{TCE}}}{C_{\text{TCE}} + K_{\text{TCE}}} \quad (1)$$

$$-R_{\text{DCE}} \frac{dC_{\text{DCE}}}{dt} = \frac{q_{\text{DCE}}XC_{\text{DCE}}}{C_{\text{DCE}} + K_{\text{DCE}} \left(1 + \frac{C_{\text{TCE}}}{I_{\text{TCE}}}\right)} - \frac{q_{\text{TCE}}XC_{\text{TCE}}}{C_{\text{TCE}} + K_{\text{TCE}}} \quad (2)$$

$$-R_{\text{VC}} \frac{dC_{\text{VC}}}{dt} = \frac{q_{\text{VC}}XC_{\text{VC}}}{C_{\text{VC}} + K_{\text{VC}} \left(1 + \frac{C_{\text{TCE}}}{I_{\text{TCE}}} + \frac{C_{\text{DCE}}}{I_{\text{DCE}}}\right)} - \frac{q_{\text{DCE}}XC_{\text{DCE}}}{C_{\text{DCE}} + K_{\text{DCE}} \left(1 + \frac{C_{\text{TCE}}}{I_{\text{TCE}}}\right)} \quad (3)$$

$$\frac{dX}{dt} = YX \left[\frac{q_{\text{TCE}}C_{\text{TCE}}}{C_{\text{TCE}} + K_{\text{TCE}}} + \frac{q_{\text{DCE}}C_{\text{DCE}}}{C_{\text{DCE}} + K_{\text{DCE}} \left(1 + \frac{C_{\text{TCE}}}{I_{\text{TCE}}}\right)} + \frac{q_{\text{VC}}C_{\text{VC}}}{C_{\text{VC}} + K_{\text{VC}} \left(1 + \frac{C_{\text{TCE}}}{I_{\text{TCE}}} + \frac{C_{\text{DCE}}}{I_{\text{DCE}}}\right)} \right] - bX \quad (4)$$

$$R_i = 1 + \frac{\theta_v H_i}{\theta_w} \quad (5)$$

where C_i is the aqueous concentration of compound i (where i is either TCE, DCE, or VC) (mM), t is time (h), K_i is the half velocity coefficient of compound i (mM), I_i is the competition coefficient of compound i (mM), q_i is the DHC maximum utilization rate coefficient for compound i [mmol Cl⁻ (cell h)⁻¹], X is the DHC cell concentration (cell L⁻¹), Y is the DHC growth yield [cell (mmol Cl⁻)⁻¹], b is the DHC decay constant (h⁻¹), R_i is the retardation factor for compound i , θ_v is the volume fraction of the vapor phase in the experimental system, θ_w is the volume fraction of the water phase in the experimental batch system, and H_i is the dimensionless Henry's Law coefficient for compound i .

The parameters in Eqs. (1)–(5) were systematically regressed to the batch experimental data so that no more than two parameters were simultaneously regressed. The parameters q_{VC} and K_{VC} were determined from the VC-only batch test, q_{DCE} and K_{DCE} were determined from the DCE-only experiment, I_{DCE} was determined from the DCE + VC batch experiment, q_{TCE} and K_{TCE} were determined from the TCE-only experiment, and I_{TCE} was determined from the TCE + DCE + VC experiment. Regressions to the experimental data were performed using the Microsoft Excel[®] Solver function and a nonlinear least-squares analysis similar to that described by Smith et al. (1998). Y was determined independently in parallel batch reactor experiments containing RAMM (performed in duplicate), under conditions where lactate and DCE were continuously fed to the reactor. The growth rate was calculated by measuring DHC concentrations as a function of time, then regressing this growth curve to Eq. (4).

All experiments were performed under growth conditions, and measured DHC concentrations increased during the duration of the experiments (discussed in Section 4). Thus, the decay constant (b) was assumed negligible.

3.2. Transport model

Based on our experimental results, it is assumed that the DHC inoculum migrated only a very short distance (<2 cm) into the column and became immobilized. Furthermore, we assumed that this immobilized DHC subsequently grew so that a fraction of this new growth detached and migrated (without subsequent re-attachment) through the column. Considering these assumptions, and applying a modeling approach similar to Clement et al. (1997) and Phanikumar et al. (2005), DHC growth and migration within the first 2 cm of the column was modeled in one-dimension as follows:

$$\frac{dX_{im}}{dt} = fYX_{im} \left[\frac{q_{DCE}C_{DCE}}{C_{DCE} + K_{DCE}} + \frac{q_{VC}C_{VC}}{C_{VC} + K_{VC} \left(1 + \frac{C_{DCE}}{I_{DCE}}\right)} \right] \quad (6)$$

$$\begin{aligned} \frac{dX_m}{dt} = (1-f) \frac{dX_{im}}{dt} + YX_m \left[\frac{q_{DCE}C_{DCE}}{C_{DCE} + K_{DCE}} + \frac{q_{VC}C_{VC}}{C_{VC} + K_{VC} \left(1 + \frac{C_{DCE}}{I_{DCE}}\right)} \right] \\ + D \frac{\partial^2 X_m}{\partial x^2} - v \frac{\partial X_m}{\partial x} \end{aligned} \quad (7)$$

where X_m and X_{im} are the mobile and immobile DHC (respectively), D is the dispersion coefficient ($\text{cm}^2 \text{h}^{-1}$), v is the groundwater velocity (cm h^{-1}), x is the distance from the column influent (cm), and f is the fraction of DHC that grows and remains immobilized; $(1-f)$ represents the fraction that detaches and migrates (without re-attachment) through the column. For mobile DHC growth and migration beyond $x = 2$ cm, Eq. (7) is used with omission of the first term on the right-hand side of the equation because X_{im} is assumed equal to zero beyond $x = 2$ cm.

Combining this DHC growth and transport model with solute fate and transport in the soil columns, the following one-dimensional equation for compound i is derived:

$$\left(1 + \frac{\rho K_{d,i}}{\theta}\right) \frac{\partial C_i}{\partial t} = D \frac{\partial^2 C_i}{\partial x^2} - v \frac{\partial C_i}{\partial x} + \beta_i \quad (8)$$

where ρ is the soil bulk density (kg L^{-1}), θ is the porosity, $K_{d,i}$ is the linear sorption coefficient for compound i (L kg^{-1}), D is the dispersion coefficient ($\text{cm}^2 \text{h}^{-1}$), v is the flow velocity (cm h^{-1}), and β_i is the reductive dechlorination function for compound i that incorporates Monod kinetics (Eqs. (1)–(5), assuming $X = X_m + X_{im}$). The parameters ρ and θ were estimated at 1.7 kg L^{-1} and 0.35 , respectively. A bromide tracer test was employed to determine D and V (0.36 and 0.31 cm h^{-1} , respectively). For the bromide tracer test, the analytical solution developed by Schnoor (1996) was used to solve Eq. (8). The K_d value for DCE was determined by performing a column experiment under non-dechlorinating conditions (i.e. no DHC added to the column) and regressing the value for K_d (0.07 L kg^{-1}). The K_d value for VC was estimated at 0.016 L kg^{-1} , which was based on its K_{oc} value relative to DCE (USEPA, 1996). Sorption of ethene was assumed to be equal to that of VC.

Eqs. (6)–(8) were solved using a finite difference numerical model with $\Delta t = 2 \text{ h}$ and $\Delta x = 2 \text{ cm}$ (Charbeneau, 2000). The numerical model gave similar results to the analytical solution for the bromide tracer, thus validating the finite difference numerical transport model. Monod kinetic parameters obtained from the batch experiment were used in the column model. The value for f (0.55) was used as the sole fitting parameter in the column experiments (regressed to the DHC column data).

4. Results and discussion

4.1. Batch experiments

Batch testing was performed to regress and verify Monod kinetic parameters. The regressed model and experimental data for

the initial four batch experiments are shown in Fig. 1a through Fig. 1d (data for the VC-only experiment not shown). Results of the reactor DCE growth experiment are shown in Fig. 2. The model provides a reasonable description of the data. The total contaminant molar balances were generally greater than 90%. Losses of chlorinated ethenes in the controls were negligible.

The regressed Monod kinetic parameters, along with comparison to previously reported parameters, are provided in Table 1. The half velocity coefficients and competition coefficients are on a similar order of magnitude as those determined by others, although TCE demonstrated no competitive inhibition on DCE or VC in our study (based on DCE degradation rates with and without TCE present). However, the maximum rates of substrate utilization of SDC-9 are several orders of magnitude greater than the other cultures listed in Table 1. For the EV culture, this discrepancy is likely due to the fact that the maximum rate of substrate utilization coefficient was based on total cell biomass for the EV culture, rather than DHC biomass only. The reason for this large difference compared to the VS bacterium is unclear, but may be due to the fact that the VS bacterium consists of a single DHC strain, while the SDC-9 consortia consists of multiple DHC strains. Similar explanations likely apply for the discrepancy between the yield coefficient attained for SDC-9 and the other cultures listed in Table 1.

Results of the additional batch testing are shown in Fig. 3. Model simulations shown in Fig. 3 are based on the regressed parameters provided in Table 1. Results verify that (1) the data are reasonably described by the model, (2) the presence of soil does not cause any measurable impact on kinetics, and (3) growth of the initial inoculum on PCE versus DCE does not have a substantial impact on the observed dechlorination kinetics. The data in Fig. 3c demonstrate that the native microbial population is unable to dechlorinate DCE or VC. Additional testing on non-DHC-inoculated samples showed that hydrogen was produced from lactate fermentation (approximately 0.003 mM), thus it was concluded that bacteria capable of fermenting lactate were present in the native soils and that the absence of DCE and VC dechlorination was likely due to the absence of indigenous DHC that are able to reductively dechlorinate these compounds.

Results of the batch reactor experiment, used to further validate the dechlorination and DHC growth model, are provided in Fig. 4. The total contaminant molar balance at the end of the experiment is approximately 108%. TCE losses in the control reactor were approximately 17%, with no measurable accumulation of TCE reductive dechlorination products. Comparison of the model simulation to the experimental results indicates that the data are reasonably predicted by the kinetic model.

4.2. Column experiments

Column experiments were performed to evaluate the applicability of Monod kinetic model under saturated flow conditions. The total contaminant molar balance in each of the columns was generally greater than 80% for each sampling event. Lactate and/or intermediate fermentation products were consistently observed in the column effluent, indicating that electron donor was present in excess. Effluent acetate concentrations typically ranged between 300 and 400 mg L^{-1} . In addition, results between the two replicate soil columns were similar in both magnitude and trend for the chlorinated ethene data. No dechlorination was observed in the columns prior to DHC inoculation.

Measured DHC concentrations at the three column sampling locations are shown in Fig. 5. The variability in the DHC data likely reflects variability in both the qPCR analysis and aqueous sampling. The DHC concentration within the column prior to inoculation (but after approximately 3-wks of feeding the column with lactate and DCE) was below the analytical detection limit of

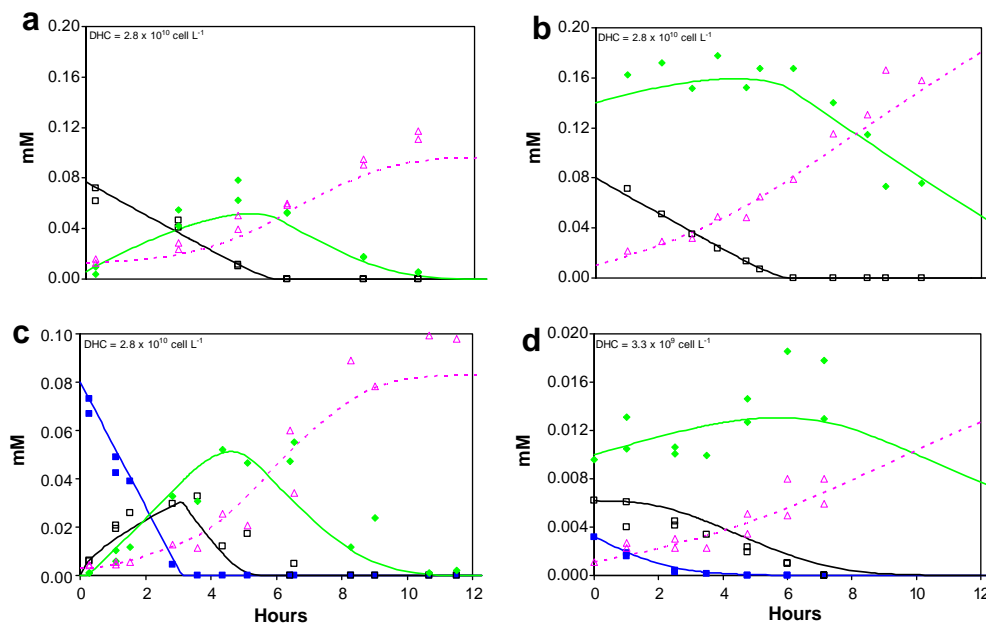

Fig. 1. Batch experiments used for regression of kinetic model (Eqs. (1)–(5)) parameters. (a) DCE-only, (b) DCE + VC, (c) TCE-only, and (d) TCE + DCE + VC. All experiments were performed in RAMM media. TCE - ■, DCE - □, VC - ◆, ethene - △. Solid and dashed lines represent the corresponding model simulations. The initial DHC concentration for each experiment is shown in the figures. Data and regression for VC-only experiment not shown.

approximately $4 \times 10^4 \text{ cell L}^{-1}$. DHC concentrations after inoculation were generally two to three orders of magnitude below the injection concentration of $4 \times 10^8 \text{ cell L}^{-1}$, indicating that most (>99%) of the injected DHC were not able to pass through the column and were likely retained near the column influent via straining/filtration mechanisms. Aggregation of bacterial cells could have enhanced the overall retention of the DHC cells. However, during the duration of the experiment, aqueous phase DHC concentrations increased uniformly across the column by approximately two orders of magnitude. In addition, the DHC data do not show any substantial (i.e. order of magnitude) gradient in aqueous DHC concentrations across the length of the column, as scatter in the DHC data (standard deviation of approximately one-half order of magnitude) was greater than any statistical spatial trend that may have been present. It is also noted that the estimated quantity of DHC that was initially injected and retained near the column influent is small (less than 20%) compared to the total DHC mass that eluted from the columns during the duration of the experiment, confirming that subsequent growth and release of DHC were responsible for the observed DHC elution through the column.

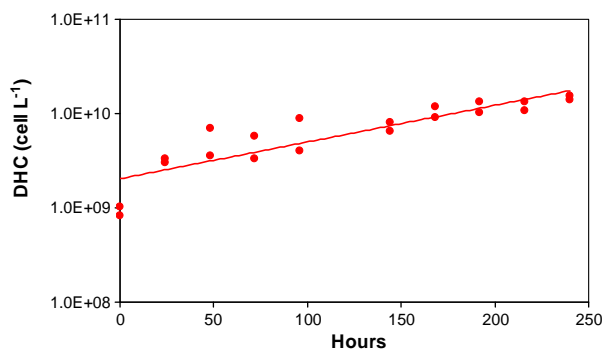

Fig. 2. DHC growth kinetics in continuously DCE-fed reactor. The experiment was performed in duplicate. These data, combined with the data in Fig. 1, were used to determine the yield coefficient. The solid line represents the regressed model.

DHC concentrations in the soil phase measured at the end of the column experiments showed that, after accounting for DHC present in the water phase, no measurable DHC was attached to the soil. The relatively large fraction of DHC in the aqueous phase relative to the soil phase is consistent with the results of Yolcubal et al. (2002), who showed that actively growing bacteria have a greater fraction present in the aqueous phase than associated with the solid phase. Increased biomass levels were visually observed near the influent Teflon cap (i.e. between the cap and the soil face). However, this immobilized biomass material, which was presumably unable to appreciably elute through the column, was not sampled for qPCR analysis. Based on these results and observations, it is likely that the bulk of the immobile DHC resided within this biomass at/near the influent soil face, rather than on the soil along the length of the column.

Fig. 6 shows DCE, VC, ethene, and DHC concentrations measured at $x = 6.7$ and 20 cm from the column influent. Results show that dechlorination was occurring throughout the column, and that the rate and extent of dechlorination increased with time at each monitoring location. While immobile DHC retained near the column influent likely contributed to the overall dechlorination observed in the column, the observed increases in the extent of dechlorination between $x = 6.7$ and 20 cm indicate that the aqueous phase mobile DHC also were contributing significantly to the overall contaminant dechlorination. However, the model (Eqs. (1)–(8)) substantially underpredicted the rates of dechlorination in the column, as the substantial dechlorination occurring between $x = 6.7$ and 20 cm could not be predicted by the model.

To explain this discrepancy, several possibilities were considered. One possibility is that soil phase DHC were contributing to the observed dechlorination rate throughout the column. Despite the fact that soil phase analyses indicated that no measurable soil phase DHC were present, it is possible that the soil-bound DHC was not readily extractable and contributing to contaminant dechlorination. However, if soil phase DHC were responsible for the apparent increased column kinetics, soil DHC concentrations three orders of magnitude greater than what was extracted using the MO BIO DNA kit would have been needed (calculated by applying

Table 1
Regressed Monod parameters from batch experiments. 95% confidence intervals are provided. Model parameters were regressed to the data shown in Figs. 1 and 2. The death rate constant (b) is assumed equal to zero for SDC-9. Calculation of q for the EV culture assumes 0.6 g protein (g cells)⁻¹, and 1.6 × 10⁻¹⁴ g cell copy⁻¹ (Cupples et al., 2003).

Parameter	TCE	DCE	VC
SDC-9			
K (mM)	3.2 ± 0.50 × 10 ⁻³	2.0 ± 1.4 × 10 ⁻³	1.4 ± 0.04 × 10 ⁻²
I (mM)	NC	5.2 ± 0.69 × 10 ⁻³	NC
q (mmol Cl ⁻ (cell h) ⁻¹)	1.3 ± 0.15 × 10 ⁻¹²	5.2 ± 0.15 × 10 ⁻¹³	1.4 ± 0.29 × 10 ⁻¹²
Y (cell (mmol Cl ⁻) ⁻¹)		4.4 ± 0.51 × 10 ⁹	
b (h ⁻¹)		0.0	
VS (Cupples et al. (2004))			
K (mM)	NC	3.3 ± 2.2 × 10 ⁻³	2.6 ± 1.9 × 10 ⁻³
I (mM)	NC	3.6 ± 1.1 × 10 ⁻³	7.8 ± 1.5 × 10 ⁻³
q (mmol Cl ⁻ (cell h) ⁻¹)	NC	3.2 × 10 ⁻¹⁴	
Y (cell (mmol Cl ⁻) ⁻¹)	NC	5.2 × 10 ¹¹	
b (h ⁻¹)	NC	4 × 10 ⁻³	
EV culture (Yu et al. (2005))			
K (mM)	125 ± 14 × 10 ⁻³	13.8 ± 1.1 × 10 ⁻³	8.1 ± 0.9 × 10 ⁻³
I (mM)	125 ± 14 × 10 ⁻³	13.8 ± 1.1 × 10 ⁻³	8.1 ± 0.9 × 10 ⁻³
q (mmol Cl ⁻ (cell h) ⁻¹)	5.0 ± 0.60 × 10 ⁻¹⁴	5.5 ± 0.44 × 10 ⁻¹⁵	3.2 ± 0.36 × 10 ⁻¹⁵
Y (cell (mmol Cl ⁻) ⁻¹)		6.2 × 10 ¹¹	
b (h ⁻¹)		0.024	

NC = not calculated.

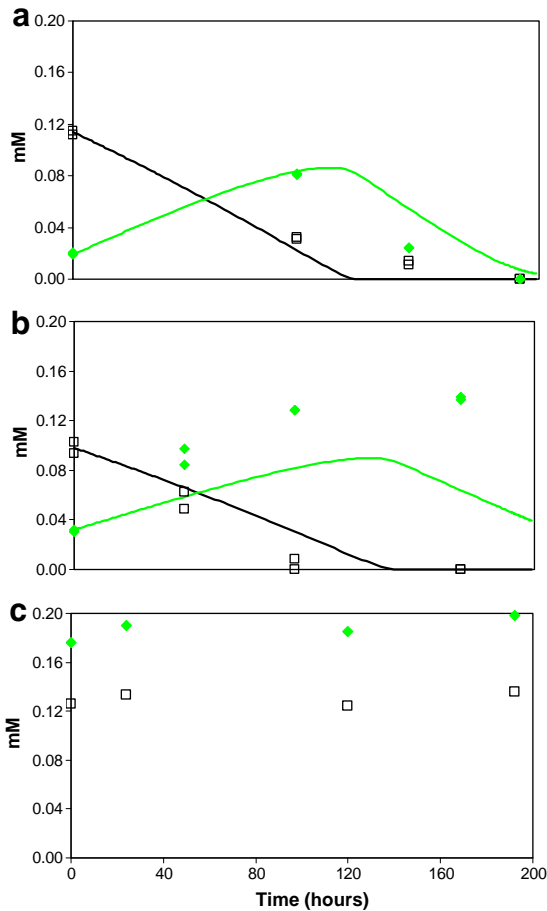

Fig. 3. Batch experiments used to validate kinetic model. DCE - □, VC - ◆. Solid lines represent the corresponding model simulations based on the regressed parameters shown in Table 1. (a) Experiment prepared with RAMM and soil and an initial DHC concentration of 1.9 × 10⁹ cell L⁻¹. A final ethene concentration of 0.15 mM was measured. (b) Experiment prepared with RAMM and soil, and inoculated with DHC (initial concentration of 1.4 × 10⁹ cell L⁻¹) that was grown on DCE. A final ethene concentration of 0.003 mM was measured. (c) Experiment prepared with RAMM and soil without addition of DHC.

Eqs. (6) and (7) across the length of the column). Another potential explanation is that DHC activity within the flow-through column is greater than in a batch slurry system, possibly due to elution of

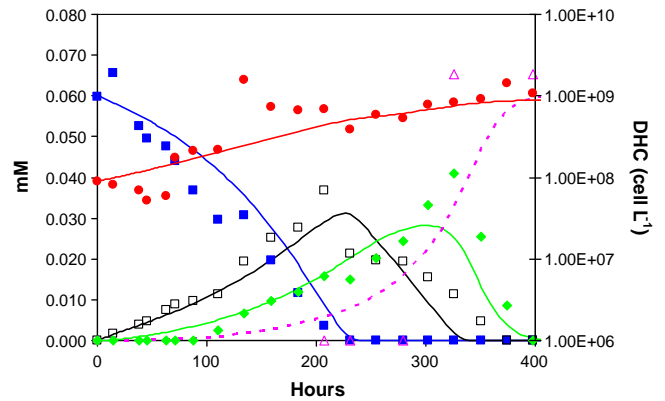

Fig. 4. Changes in chlorinated ethene and ethene concentrations (mM) and DHC concentration (cell L⁻¹) with respect to time during the batch reactor experiment. Regressed model parameters listed in Table 1 were used to predict the experimental results. TCE - ■, DCE - □, VC - ◆, ethene - △, DHC - ●. Solid and dashed lines represent the corresponding model simulations.

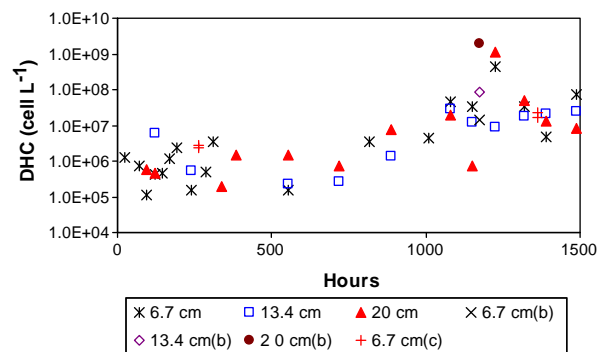

Fig. 5. Measured aqueous phase DHC concentrations at each sampling location (6.7, 13.4, and 20 cm from the column influent). Data for each column replicate experiment are shown, where (b) and (c) denote replicate column experiments.

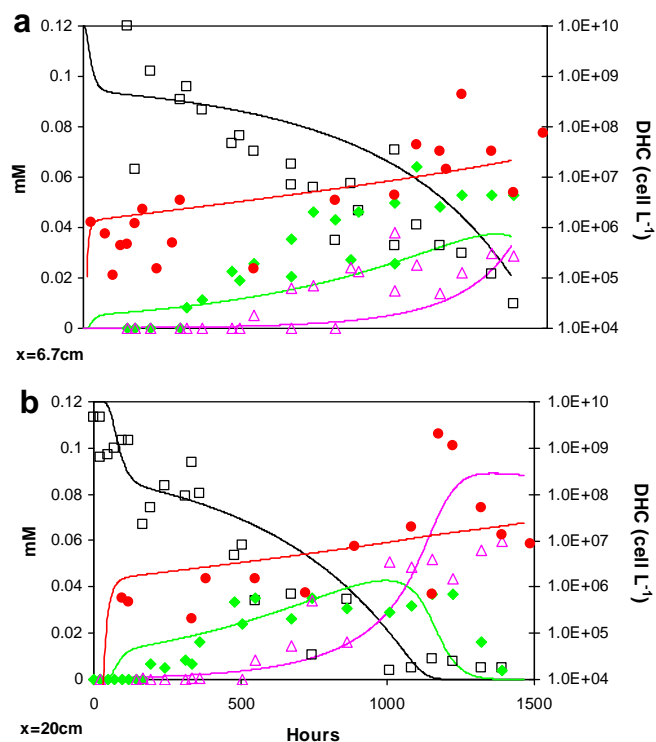

Fig. 6. Changes in chlorinated ethene and ethene concentrations (mM) and DHC concentration (cell L^{-1}) with respect to time during the column experiments at (a) 6.7 cm and (b) 20 cm from the influent. DCE - \square , VC - \blacklozenge , Ethene - \triangle , DHC - \bullet . Results from replicate columns are plotted. The corresponding lines represent model predictions using the dechlorination enhancement factor of 200 that was measured in the batch experiments performed on the column effluent.

inhibitory (and un-detected) intermediate products. A third possibility is that the nature of the mobile aqueous phase DHC consortium is different than the initial (inoculated) DHC consortia.

To evaluate these potential explanations, two additional batch kinetic experiments were performed on the column effluent. Results of the batch kinetic tests on column effluent water are shown in [Supplementary material \(Fig. S1\)](#). Consistent with results in the soil column, the previously regressed kinetic model substantially underpredicts the rate of chlorinated ethene reductive dechlorination. However, multiplying the DCE and VC dechlorination rates (right-hand-side of Eqs. (2) and (3)) by a factor of 100–300 resulted in a reasonable model prediction of the column effluent batch data ([Fig. S2](#)). Thus, mobile DHC eluting from the column exhibited an enhanced dechlorinating activity relative to the initial inoculum, which likely explains the enhanced (relative to model predictions) dechlorination observed in the column. Applying the same average “dechlorination enhancement” factor to the column transport model (i.e. right-hand-side of Eqs. (2) and (3)) multiplied by 200, the simulations shown in [Fig. 6](#) provide a reasonable prediction of the experimental data.

It is unclear why the DHC eluting from the column had a greater apparent dechlorination activity for DCE and VC compared to the original consortium. As shown in [Fig. 3](#), growth on DCE rather than PCE is likely not responsible. One explanation is that the mobile DHC that are able to detach and migrate through the column are more active (with respect to dechlorination of DCE and VC) than the initial DHC inoculum. The initial DHC inoculum may consist of multiple sub-populations of DHC cells, some of which are adhesive and less active. Similar observations, where different activities were measured for mobile and immobile members of a contaminant-degrading culture, have been reported for other types of

bacteria ([Streger et al., 2002](#)). Attached bacteria near the column influent also may have released growth factors (e.g. corrinoids) to enhance activity. Additional evaluation of molecular microbial properties, and changes in these properties during transport and growth in soils, is needed to provide improved insight into these bioaugmentation processes.

Assuming a simple first-order degradation model and an average DHC concentration of $1 \times 10^7 \text{ cell L}^{-1}$, the regressed first-order biotransformation rate constant for DCE in [Fig. 6](#) is approximately 0.002 h^{-1} . Laboratory and field data reported by [Lu et al. \(2006\)](#) indicate that an observed first-order DCE biotransformation rate constant of approximately 0.0002 h^{-1} would be expected for a DHC concentration of $1 \times 10^7 \text{ cell L}^{-1}$. The reason for the greater observed rate constant measured in our study is likely due to the optimal growth conditions used in the current study (i.e. excess electron donor and nutrients), differences in temperature between the two studies, and/or the intrinsic activity (i.e. growth rate, utilization rate) of the DHC cultures utilized.

5. Conclusions

For *in situ* bioaugmentation applications, results of this study suggest that migration of injected DHC cultures, and subsequent treatment of dissolved chlorinated ethenes, is highly dependent upon mobile DHC in the aqueous phase. However, apparent dechlorination activity in the soil column was on the order of 200-times greater than measured in the initial batch experiments; this enhanced dechlorination activity was confirmed by performing batch kinetic testing on the column effluent. Incorporating these enhanced dechlorination kinetics in the transport model resulted in a reasonable prediction of the experimental data. Potential implication of these results to field scale bioaugmentation applications suggest that measurements of aqueous phase DHC concentrations are useful for evaluating dechlorination activity, and *in situ* dechlorination activity relative to measured aqueous DHC concentrations may be substantially greater than that measured in laboratory batch experiments.

Acknowledgments

Support for this research was provided in part by the Environmental Security Technology Certification Program (ESTCP) under Project ER-0515.

Appendix A. Supplementary material

Supplementary data associated with this article can be found, in the online version, at [doi:10.1016/j.chemosphere.2008.12.041](https://doi.org/10.1016/j.chemosphere.2008.12.041).

References

- Adamson, D.T., McDade, J.M., Hughes, J.B., 2003. Inoculation of a DNAPL source zone to initiate reductive dechlorination of PCE. *Environ. Sci. Technol.* 37, 2525–2533.
- Becker, J.G., 2006. A modeling study and implications of competition between *Dehalococcoides ethenogenes* and other tetrachloroethene-respiring bacteria. *Environ. Sci. Technol.* 40, 4473–4480.
- Brusseau, M.L., Sandrin, S.K., Li, L., Yolcubal, I., Jordan, F.L., Maier, R.M., 2006. Biodegradation during contaminant transport in porous media: 8. The influence of microbial system variability on transport behavior and parameter determination. *Water Resour. Res.* 42, 4406–4420.
- Charbeneau, R., 2000. *Groundwater Hydraulics and Pollutant Transport*. Prentice Hall, Upper Saddle River, NJ.
- Clement, T.P., Peyton, B.M., Skeen, R.S., Jennings, D.A., Petersen, J.N., 1997. Microbial growth and transport in porous media under denitrification conditions: experiments and simulations. *J. Contam. Hydrol.* 24, 269–285.
- Cupples, A.M., Spormann, A.M., McCarty, P.L., 2003. Growth of a *Dehalococcoides*-like microorganism on vinyl chloride and *cis*-dichloroethene as electron acceptors as determined by competitive PCR. *Appl. Environ. Microb.* 69, 953–959.

- Cupples, A.M., Spormann, A.M., McCarty, P.L., 2004. Vinyl chloride and *cis*-dichloroethene dechlorination kinetics and microorganism growth under substrate limiting conditions. *Environ. Sci. Technol.* 38, 1102–1107.
- Fuller, M.E., Dong, H., Mailloux, B.J., Onstott, T.C., DeFlaun, M.F., 2000. Examining bacterial transport in intact cores from Oyster, Virginia: effect of sedimentary facies type on bacterial breakthrough and retention. *Water Resour. Res.* 36, 2417–2431.
- Gargiulo, G., Bradford, S.A., Simunek, J., Ustohal, P., Vereecken, H., Klumpp, E., 2007. Transport and deposition of metabolically active and stationary phase *Deinococcus radiodurans* in unsaturated porous media. *Environ. Sci. Technol.* 41, 1265–1271.
- Ginn, T.R., Wood, B.D., Nelson, K.E., Scheibe, T.D., Murphy, E.M., Clement, T.P., 2002. Processes in microbial transport in the natural subsurface. *Adv. Water Resour.* 25, 1017–1042.
- He, J., Ritalahti, K.M., Aiello, M.R., Löffler, F.E., 2003. Complete detoxification of vinyl chloride by an anaerobic enrichment culture and identification of the reductively dechlorinating population as a *Dehalococcoides* species. *Appl. Environ. Microb.* 69, 996–1003.
- Kim, S., Corapcioglu, M.Y., 1997. The role of biofilm growth in bacteria-facilitated contaminant transport in porous media. *Transport Porous Med.* 26, 1573–1634.
- Lee, I., Bae, J., Yang, Y., McCarty, P.L., 2004. Simulated and experimental evaluation of factors affecting the rate and extent of reductive dehalogenation of chloroethenes with glucose. *J. Contam. Hydrol.* 74, 313–331.
- Lu, X., Wilson, J.T., Kampbell, D.H., 2006. Relationship between *Dehalococcoides* DNA in ground water and rates of reductive dechlorination at field scale. *Water Res.* 40, 3131–3140.
- Major, D.W., McMaster, M.L., Cox, E.E., Edwards, E.A., Dworatzek, S.M., Hendrickson, E.R., Starr, M.G., Payne, J.A., Buonamici, L.W., 2002. Field demonstration of a successful bioaugmentation to achieve dechlorination of tetrachloroethene to ethene. *Environ. Sci. Technol.* 36, 5106–5116.
- Maymó-Gatell, X., Chien, Y., Gossett, J.M., Zinder, S.H., 1997. Isolation of a bacterium that reductively dechlorinates tetrachloroethene to ethene. *Science* 276, 1568–1571.
- Phanikumar, M.S., Hyndman, D.W., Zhao, X., Dybas, M.J., 2005. A three-dimensional model of microbial transport and biodegradation at the Schoolcraft, Michigan, site. *Water Resour. Res.* 41, W05011.
- Ritalahti, K.M., Löffler, F.E., Rasch, E.E., Koenigsberg, S.S., 2005. Bioaugmentation for chlorinated ethene detoxification: bioaugmentation and molecular diagnostics in the bioremediation of chlorinated ethene-contaminated sites. *Ind. Biotechnol.* 1, 114–118.
- Sanin, S.L., Sanin, F.D., Bryers, J.D., 2003. Effect of starvation on the adhesive properties of xenobiotic degrading bacteria. *Process Biochem.* 38, 909–914.
- Schnoor, J., 1996. *Environmental Modeling: Fate and Transport of Pollutants in Water, Air and Soil*. John Wiley & Sons, NY.
- Shelton, D.R., Tiedje, J.M., 1984. Isolation and partial characterization of bacteria in an anaerobic consortium that mineralized 3-chlorobenzoic acid. *Appl. Environ. Microb.* 48, 840–848.
- Smith, L.H., McCarty, P.L., Kitanidis, P., 1998. Spreadsheet method for evaluation of biochemical reaction rate coefficients and their uncertainties by weighted nonlinear least-squares analysis of the integrated Monod equation. *Appl. Environ. Microb.* 64, 2044–2050.
- Streger, S.H., Vainberg, S., Dong, H., Hatzinger, P.B., 2002. Enhancing transport of *Hydrogenophaga flava* ENV735 for bioaugmentation of aquifers contaminated with methyl tert-butyl ether. *Appl. Environ. Microb.* 68, 5571–5579.
- United States Environmental Protection Agency (USEPA), 1996. *Soil Screening Guidance: User's Guide*. Publication 9355.4-23.
- Walker, S.L., Redman, J.A., Elimelech, M., 2005. Influence and growth phase on bacterial deposition: interaction mechanisms in packed-bed column and radial stagnation point flow systems. *Environ. Sci. Technol.* 39, 6405–6411.
- Yolcubal, I., Pierce, S.A., Maier, R.M., Brusseau, M.L., 2002. Biodegradation during contaminant transport in porous media: V. The influence of growth and cell elution on microbial distribution. *J. Environ. Qual.* 31, 1824–1830.
- Yu, S., Dolan, M.E., Semprini, L., 2005. Kinetics and inhibition of reductive dechlorination of chlorinated ethylenes by two different mixed cultures. *Environ. Sci. Technol.* 39, 195–205.
- Yu, S., Semprini, L., 2004. Kinetics and modeling of reductive dechlorination at high PCE and TCE concentrations. *Biotechnol. Bioeng.* 88, 451–464.

APPENDIX D

Publication: “Large-scale production of bacterial consortia for remediation of chlorinated solvent-contaminated groundwater”.

Large-scale production of bacterial consortia for remediation of chlorinated solvent-contaminated groundwater

Simon Vainberg · Charles W. Condee · Robert J. Steffan

Received: 22 October 2008 / Accepted: 21 May 2009
© Society for Industrial Microbiology 2009

Abstract Chlorinated solvents such as perchloroethylene (PCE) and trichloroethylene (TCE) continue to be significant groundwater contaminants throughout the USA. In many cases efficient bioremediation of aquifers contaminated with these chemicals requires the addition of exogenous microorganisms, specifically members of the genus *Dehalococcoides* (DHC). This process is referred to as bioaugmentation. In this study a fed-batch fermentation process was developed for producing large volumes (to 3,200 L) of DHC-containing consortia suitable for treating contaminated aquifers. Three consortia enriched from three different sites were grown anaerobically with sodium lactate as an electron donor and PCE or TCE as an electron acceptor. DHC titers in excess of 10^{11} DHC/L could be reproducibly obtained at all scales tested and with all three of the enrichment cultures. The mean specific DHC growth rate for culture SDC-9TM was 0.036 ± 0.005 (standard error, SE)/h with a calculated mean doubling time of 19.3 ± 2.7 (SE) h. Finished cultures could be concentrated approximately tenfold by membrane filtration and stored refrigerated (4°C) for more than 40 days without measurable loss of activity. Dehalogenation of PCE by the fermented cultures was affected by pH with no measurable activity at pH <5.0.

Keywords Bioremediation · Bioaugmentation · PCE · TCE · Fermentation · *Dehalococcoides* · Dechlorination · SDC-9 · Groundwater

Introduction

Chlorinated ethenes have been used extensively as industrial solvents and cleaning agents, and their widespread use and improper disposal practices have led to them becoming common groundwater contaminants throughout the USA and the world [25, 33]. Because of the widespread occurrence of chlorinated solvent contamination, a number of treatment technologies have emerged and evolved. Currently, the most common treatment alternative involves biological degradation of the solvents.

The predominant biodegradation pathway for chlorinated ethenes under anaerobic conditions is reductive dechlorination. During reductive dechlorination, chlorinated ethenes are used as electron acceptors by specialized microorganisms, and during the process a chlorine atom is removed and replaced with a hydrogen atom [12, 13, 16, 30]. Sequential dechlorination of perchloroethylene (PCE) most commonly proceeds to trichloroethene (TCE), *cis*-1,2-dichloroethene (*c*DCE), vinyl chloride (VC), and finally the desired end product, ethene. In some cultures *trans*-1,2-DCE and 1,1-DCE also can be produced through the reductive dechlorination of TCE [6, 35]. In situ biodegradation of chlorinated ethenes can be performed by indigenous microorganisms at contaminated sites that use endogenous resources to support contaminant degradation (i.e., intrinsic bioremediation), or nutrients that are purposefully added to support their activity (i.e., biostimulation). The lack of an adequate microbial population capable of completely dechlorinating PCE and TCE to ethene at some sites,

S. Vainberg · C. W. Condee · R. J. Steffan (✉)
Shaw Environmental, Inc., 17 Princess Road,
Lawrenceville, NJ 08648, USA
e-mail: rob.steffan@shawgrp.com

S. Vainberg
e-mail: simon.vainberg@shawgrp.com

C. W. Condee
e-mail: charles.condee@shawgrp.com

however, may lead to the accumulation of *cis*-DCE and VC [11]. Consequently, the addition of exogenous organisms (i.e., bioaugmentation) is sometimes used to supplement the indigenous microbial population [5, 15, 21].

While many dechlorinating microorganisms have been identified [30], bacteria of only one microbial genus, *Dehalococcoides* (DHC), have been shown to completely reduce *c*DCE and VC to ethene [7, 8, 22, 23, 26, 31]. These organisms use molecular hydrogen as an obligate electron donor and halogenated compounds as obligate respiratory electron acceptors. Acetate (e.g., from lactate fermentation) is used as a carbon source. Studies of field sites have strongly correlated the presence of DHC strains with complete dehalogenation of chlorinated ethenes in situ [11]. Therefore, microbial cultures used to remediate chlorinated solvent-contaminated groundwaters contain at least one strain of *Dehalococcoides* sp. Because of the difficulty of growing DHC-type organisms in pure culture [7, 8, 10, 23], however, cultures used for bioaugmentation applications are consortia that contain DHC as well as fermentative and other microbes that support the growth and activity of the DHC strains [4, 5, 15, 21]. The consortia, and the DHC therein, can be grown on a wide range of carbon sources provided the substrate is fermented to hydrogen.

One of the significant challenges of performing bioaugmentation at a commercial scale is the large size of contaminant plumes and the large amount of culture needed to facilitate timely and successful remediation. Contaminant plumes can range from less than an acre (0.4 ha) in size to several kilometers long and hundreds of meters wide. Recent studies of in situ chlorinated ethene degradation have suggested that DHC concentrations in the range of 10^7 DHC/L of groundwater are needed to support acceptable degradation rates [19, 28]. To illustrate the challenge of applying bioaugmentation in the field, a 0.4-ha (one-acre) aquifer with a saturated zone 3 m (10 ft) thick and porosity of 25% would contain $\sim 3 \times 10^6$ L of groundwater and require 3×10^{13} DHC based on the findings of Lu et al. At the reported DHC concentrations of early bioaugmentation cultures (10^9 DHC/L; [21]), as much as 10^4 L of culture could be required to treat a one-acre site. Of course other factors affect the amount of culture applied at a site [14, 28], but it is clear that large-scale production of high-density cultures is necessary to apply bioaugmentation economically, especially at large sites.

The objective of this study is to evaluate large-scale production of a DHC-containing consortium, SDC-9TM, for full-scale remedial applications. The culture was grown in small (3-L) to large (4,000-L) fermentors by using sodium lactate as a carbon and electron donor source and PCE as an electron acceptor. DHC concentrations of $>10^{11}$ /L could be achieved, and the culture could be concentrated and stored prior to field application. The fermentation procedure

produced similar results with two other DHC cultures enriched from different sites.

Materials and methods

Chemicals

Sodium-(L)-lactate (60% solution) was purchased from Purac America (Lincolnshire, IL), yeast extract (bacteriological grade) was purchased from Marcor Development Corp. (Carlstadt, NJ), and PCE (99.9%) was from Sigma/Aldrich (Milwaukee, WI). Unless otherwise stated, all other chemicals were of the highest purity available and purchased from either Aldrich Chemical Co. (Milwaukee, WI), Mallinckrodt Specialty Chemical Co. (Paris, KY), J.T. Baker Inc. (Phillipsburg, NJ), Spectrum Chemical Manufacturing Corp. (Garden, CA) or Sigma Chemical Co. (St. Louis, MO).

Bacterial cultures

An anaerobic dechlorinating consortium designated SDC-9TM was isolated by enrichment culturing of samples from a chlorinated solvent-contaminated aquifer in southern California with lactate as an electron donor and PCE as an electron acceptor. The culture has been maintained on sodium lactate and PCE in reduced anaerobic mineral medium (RAMM) [29], but without sodium sulfide and rezasurin, for more than 4 years. Hawaii-05TM was enriched in 2005 by enrichment culturing of aquifer samples from Hickam Air Force Base, Hawaii on sodium lactate and TCE, and PJKSTM was enriched in 2005 from aquifer samples from Air Force Plant PJKS in Colorado on sodium lactate and TCE. The latter cultures are maintained as described for SDC-9TM. All three cultures are marketed commercially by Shaw Environmental, Inc. (Lawrenceville, NJ).

Fermentation equipment

Bench-scale fermentation experiments and seed culture production were performed in a 3-L or 7-L Applicon fermentor (Cole Palmer, Vernon Hills, IL.) equipped with pH and mixer controls. Substrate and NaOH feeds were controlled by using syringe pumps (Harvard Apparatus, Holliston, MA). Larger seed cultures were produced in a similarly equipped 20-L Biolafitte fermentor (Pierre Guerin, Inc., Spring Lake Park, MN). Larger cultures were produced in a 750-L ABEC fermentor (Bethlehem, PA) or a custom-built 4,000-L stainless-steel fermentor. In each case anaerobic conditions were maintained by pressurizing the vessels with nitrogen. Cells in the fermentation broth were concentrated by passing the broth over a custom-built concentrator

constructed with six Kerasep™ tubular ceramic membranes (Novasep, Inc., Boothwyn, PA). Concentrated cells were stored at 4°C in 18.5-L stainless-steel soda kegs that were pressurized with nitrogen.

Fermentation protocol

For seed culture production RAMM medium [29] without NaHCO₃ and Na₂S was added to the 20-L fermentor and steam sterilized at 121°C and 15 psi pressure for 45 min. After sterilization the fermentor was connected to a nitrogen tank to maintain a positive pressure of nitrogen in the fermentor during cooling to 30°C. After the temperature in the fermentor reached the set-point temperature of fermentation (28–30°C) and anaerobic condition were achieved [measured dissolved oxygen (DO) = 0 mg/L], nitrogen flow was stopped and NaHCO₃ solution was added aseptically to the medium. The fermentor was then inoculated with 2 L of SDC-9™, PJKS™ or Hawaii-05™. The final volume of medium in the fermentor was 16–18 L.

After inoculation of the fermentor, sterile 10% yeast extract (YE) solution was added to a final concentration of 0.1% YE (w/v) and PCE or TCE was added to a final concentration of 10 mg/L. SDC-9™ was grown on PCE, but PJKS™ and Hawaii-05™ were grown on either PCE or TCE. The fermentor was operated at 28–30°C with an agitator speed of 100 rpm. pH was maintained at 6.4–7.2 by addition NaOH (2 N). Alternatively, to increase pH during fermentation, the fermentor was sparged with nitrogen to remove dissolved CO₂. To control foam in the fermentor Antifoam 289 or 204 (Sigma) was applied automatically. After 1 day of fermentation, sodium lactate (60% solution) was added continuously to the fermentor at flow rate of 0.02–0.04 mL/h × liter of media. Subsequent additions of PCE or TCE (10 mg/L) were made to the fermentor only after complete dechlorination of PCE/TCE but before complete dechlorination of cDCE. Typically, PCE/TCE was added to the medium when the concentration of cDCE in the medium was reduced to 1–3 mg/L. When the culture reached an optical density (OD) at 550 nm (OD₅₅₀) of approximately 1.0 it was transferred anaerobically to the 750-L fermentor.

The 750-L fermentor was prepared with 550 L RAMM medium and sampled and monitored essentially as described above. The fermentor was connected to a nitrogen tank to maintain anoxic conditions, and it was operated under the same conditions as described for the 20-L fermentor except the agitator speed was set at 60 rpm. The automatic pH control system on the fermentor was inactivated to avoid addition of excess sodium. After 1 day of fermentation a continuous feed of sodium lactate (60% solution) was initiated with flow rate of 0.02–0.04 mL/h × L. When the specific PCE and cDCE dechlorination activity

reached 1.3–1.7 mg/h × gram of dry weight, a continuous feed of neat PCE/TCE was initiated at rate of 0.18–0.25 μL/h × L. This rate was increased to 0.9–1.2 μL/h × L as the culture cell density and dechlorination activity increased. The culture was grown for 13–15 days until an OD₅₅₀ ≈ 0.7–1.1 or 10¹⁰–10¹¹ DHC/L was achieved. Higher DHC concentrations could be obtained by extending the fermentation for up to 35 days.

Growth of the cultures in the 4,000-L fermentor (working volume 3,200 L) was performed essentially as described for the 750-L fermentor, but because the 4,000-L fermentor did not have an impeller, cells were continuously suspended by using a centrifugal pump that circulated the culture medium. The 4,000-L fermentor was chemically sterilized by using NaOH and a clean-in-place system. The culture medium in the 4,000-L fermentor was not sterilized. Substrate feeding and other parameters were as described for the 750-L fermentor. The fermentor was inoculated with either culture from the 750-L fermentor or refrigerated concentrated cell stocks.

Degradation assays and analytical procedures

Whenever possible, analytical methods performed during this project followed US Environmental Protection Agency (USEPA) SW-846 methods [32] that are available online at <http://www.epa.gov/epawaste/hazard/testmethods/sw846/index.htm>. Biodegradation assays were incubated at 28 ± 1°C in the dark in serum vials essentially as described by Schaefer et al. [28]. Chlorinated ethene analyses were performed by gas chromatography using USEPA method 8260 [gas chromatography/mass spectrometry (GC/MS) with purge and trap injection]. Methane and ethene were monitored by GC/flare ionization detection (FID) according to USEPA SW846 method 8015b. Lactate and volatile fatty acids (VFAs) were measured by ion chromatography using USEPA method 300.0-modified on a Dionex DX600 ion chromatograph (Dionex Corp., Bannockburn, IL). Hydrogen concentration in the fermentors was measured by analyzing the headspace of 100-mL samples in 120-mL vials on a Varian 3800 gas chromatograph (Varian, Inc., Walnut Creek, CA) equipped with a Valco pulsed discharge helium ionization detector (PDHID), a helium gas purifier to achieve helium carrier and makeup gas of 99.999% purity, and Varian Pora Bond Q (10 m, 0.32 inner diameter, 5 μm df) and Varian Molsieve 5A (10 m, 0.32 inner diameter, 5 μm df) columns operated in series. Concentration of hydrogen was determined by comparison to a standard curve. Dry weight (Dwt) was determined by concentrating 15–30 mL culture in a RC5C centrifuge (10,000 × g; Sorval Instruments, Newtown, CT), removing the supernatant, suspending the pellet in deionized (DI) water, and repeating the procedure twice. The washed cell pellet was suspended

in DI water, transferred to an aluminum weighing dish, and dried at 105°C.

DHC quantification

DHC-like organisms were quantified by using real-time quantitative polymerase chain reaction (qPCR). Following collection of fermentor samples, the OD₅₅₀ of the sample was measured and the cells were either concentrated by centrifugation or diluted with water to an OD₅₅₀ of approximately 0.5. OD was then remeasured for verification. One milliliter of the OD₅₅₀ = 0.5 cells were then concentrated by centrifugation (16,000×g for 2 min) and resuspended in 100 μL distilled water. The cells were then processed using an Idaho Technologies 1-2-3 RAPID DNA purification kit (Idaho Technology Inc. Salt Lake City, UT) as per manufacturer instructions and using a Bead Beater (BioSpec Products Inc., Tulsa, OK). DNA was eluted from columns in a final volume of 100 μL buffer rather than the prescribed 400 μL.

Quantitative real-time PCR was performed with a RAPID PCR machine (Idaho Technologies Inc.) and a Lightcycler FastStart DNA Master Hyprobe probe kit (Roche Diagnostics GmbH, Mannheim, Germany) and primers developed by us with the assistance of Idaho Technologies, Inc. to amplify and quantify 16S ribosomal RNA (rRNA) gene DNA. DNA amplification used a forward primer (5'-GAAGTAGTGAACCGAAAGG-3') and a reverse primer (5'-TCTGTCCATTGTAGCGTG-3'), and the amplified DNA was quantified using a fluorescence resonance energy transfer (FRET) probe system that employed a Light Cycler Red 640 fluorophore (5'-AGCGAGAC TGCCCC-3') and an fluorescein isothiocyanate (FITC)-labeled probe (5'-CCCACCTTCCTCCCCGTTTC-3'). The amplification conditions were as follows: denaturation at 95°C for 10 min, followed by 40 cycles of melting at 94°C for 20 s, annealing at 53°C for 10 s, and extension at 72°C for 20 s. *Dehalococcoides* sp. chromosomal DNA was quantified by comparison to a standard curve generated by amplifying serial dilutions of a known concentration of plasmid (pSC-A vector; Stratagene Inc. La Jolla, CA) containing a cloned 16S rRNA gene from the SDC-9TM culture.

Results and discussion

Culture growth

A typical growth curve of large-scale (3,200-L) production of SDC-9TM is shown in Fig. 1a. Monod kinetics parameters for SDC-9TM are reported elsewhere [28]. The cells were grown with lactate as an electron donor and PCE as an electron acceptor, and yeast extract was added periodically

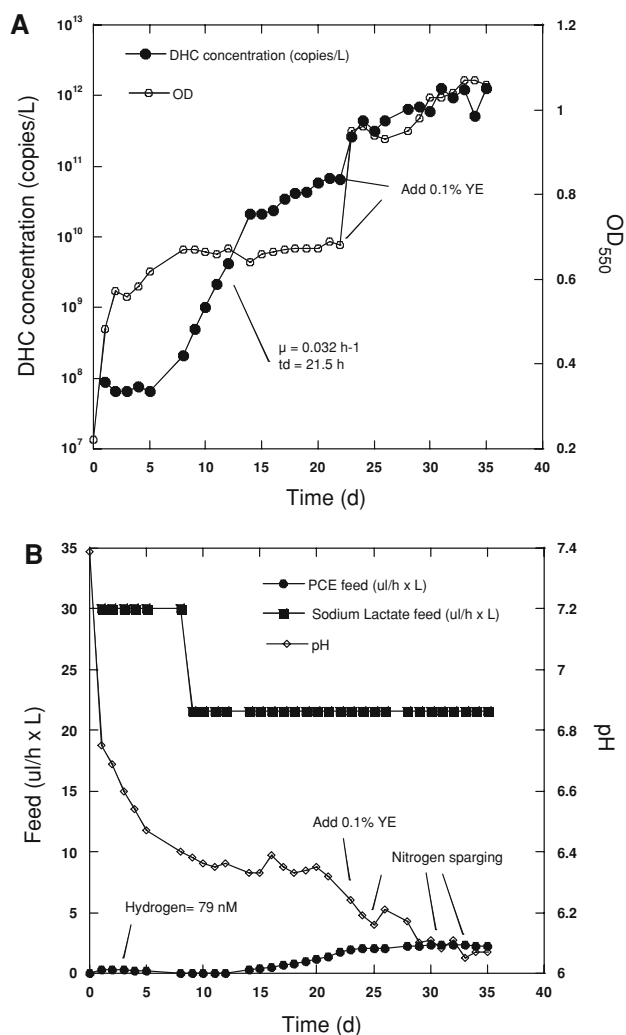

Fig. 1 Growth of SDC-9TM in a 4,000-L fermentor. **a** Concentration of DHC as measured by qPCR (filled circle) and total cell concentration as estimated by OD at 550 nm (open circle). DHC first-order growth rate (μ) and doubling time (t_d) are indicated on the graph. **b** Feed rate of neat PCE (filled circle) and 60% sodium lactate (filled square), and the pH of the culture medium (open diamond) are indicated. Yeast extract (YE) solution was added at the beginning of the fermentation and as indicated. The fermentor was sparged with N₂ as indicated to control pH

as indicated. Although the OD₅₅₀ of the culture increased rapidly in the fermentor, DHC concentrations remained constant for 5 days before the initiation of the exponential growth phase. This DHC lag phase, however, did not occur in all fermentation runs and it could be the result of variability in the qPCR quantification method. During the exponential growth phase when both cDCE and VC were present in excess the specific growth rate (m) reached 0.032/h with a cell doubling time of 21.5 h. During multiple fermentation runs at both the 550-L and 3,200-L scale ($n = 5$) (data not shown), specific DHC growth rates ranged from 0.027 to 0.043/h with mean rate of 0.036/h (19.3 ± 2.7 h doubling time).

Although the OD of the culture stabilized after approximately 10 days, exponential growth of DHC continued until approximately day 24. These results suggest that non-DHC microorganisms in the consortium initially grew much faster than DHC. During this early fermentation period, DHC represented a relatively low proportion of the total bacterial population of the culture, but during extended growth the relative abundance of DHC in the culture increased. The results also demonstrate that, at least during the early stages of fermentation, OD measurements are not a good indicator of DHC concentration in the culture, and more advanced measurements such as qPCR are needed to estimate DHC numbers in the culture effectively [17, 27].

During the initial stages of 3,200-L fermentation (to day 25) a maximum DHC concentration of $\sim 10^{11}$ DHC/L was achieved in the fermentor, even though growth substrates were still present in the culture broth (Fig. 1a). DHC concentrations in the fermentor, however, could be increased approximately tenfold by the addition of YE as a nutrient source. The exact role of the YE is not known, but its addition also revived the growth of non-DHC organisms in the consortium (Fig. 1a). Because the RAMM medium used in this study did not contain sodium sulfide or other sulfur-containing salts, it is possible that the yeast extract provided a needed source of sulfur for the cultures. Based on our analysis (data not shown) 1 g/L YE was estimated to provide 5 mg/L sulfur and 0.48 mg/L iron. YE also could provide a needed source of amino acids and/or precursors for the production of corrinoid cofactors that are necessary for dehalogenation by DHC strains [23]. During this extended growth of the culture there was a correlation between culture OD₅₅₀ and DHC concentrations, suggesting that during this period of the fermentation process measurements of OD may be useful for estimating DHC levels in the fermentor and to automate the control of the fermentation process.

Similar fermentation results were obtained with two other chloroethene dechlorinating bacterial consortia, PJKSTM and Hawaii-05TM, at both the 550-L and 3,200-L scale (Table 1), by using the described procedures. Both

cultures could be grown to high DHC concentration ($>10^{11}$ cells/L), and both the final OD₅₅₀ and total cell mass obtained were similar to the results obtained with SDC-9TM.

No other studies have evaluated or reported large-scale production of DHC-containing consortia, but the DHC cell concentration achieved in our studies were similar to those obtained by others in small-scale laboratory tests. For example, Couples et al. [1] calculated final DHC concentrations of up to 4×10^{11} /L during growth of the VS culture in TCE-fed 60-mL batch cultures, and He et al. [9], achieved up to 1.8×10^{11} copies/L of the *tceA* gene in 100-mL batch cultures of *D. ethenogenes* strain 195 containing a coculture of a sulfate-reducing bacterium. Similarly, whereas we observed DHC doubling times of 19.3 h during large-scale fermentation, DHC doubling times from small laboratory studies of 19.5 h to 2 days have been reported [2, 9, 10, 22].

The results of this study demonstrate that culture volumes and DHC cell densities sufficient to treat even relatively large contaminated aquifers can be obtained. Assuming that 10^7 DHC/L of contaminated groundwater are needed to obtain effective and timely remediation [19], 3,200 L of culture with 10^{11} DHC/L could potentially support remediation of 3.2×10^7 L of groundwater, even without further in situ growth of the organisms.

Factors affecting fermentation

Several factors could affect the results obtained during growth of the test cultures, including substrate type and feed rates, pH, and VFA accumulation. Growth of DHC requires the presence of a chlorinated substrate as an electron acceptor, H₂ as an electron donor, and a carbon growth source such as acetate [8, 16, 23]. In consortia such as those used in this study, the primary growth substrate (i.e., lactate) is fermented by non-DHC members of the consortia to H₂ and acetate that can be utilized by DHC. The presence of excess H₂, however, can lead to substrate competition with methanogenic bacteria in the consortia that also can use H₂, albeit at a higher substrate threshold than DHC [18, 20, 34]. Therefore, in developing a fermentation protocol for the described cultures, attempts were made to maintain

Table 1 Results of multiple fermentation runs with the tested chlorinated solvent-dechlorinating consortia

Culture	Date (M/Y)	Volume (L)	Final OD ₅₅₀	Final DHC (cells/L) ^a	Dwt (mg/L)	PCE activity (mg/h/g Dwt)	cDCE activity (mg/h/g Dwt)
SDC-9	01/2006	550	1.3	1.4 E11	0.51	16	13
SDC-9	02/2008	550	1.7	2.8 E11	0.66	22	14
SDC-9	03/2008	3,200	1.6	1.4 E11	0.65	41	37
SDC-9	05/2008	2,500	1.6	2.4 E12	0.59	42	39
SDC-9	08/2008	2,000	1.4	1.0 E12	0.51	80	69
PJKS	01/2008	2,500	1.1	9.4 E11	0.41	32	14
PJKS	02/2008	1,700	1.3	1.0 E11	0.50	64	45
Hawaii-05	11/2007	550	1.2	1.5 E11	0.50	23	16

^a Based on qPCR assuming 1 16S rRNA gene copy/cell

consistent low H_2 concentrations within the reactor. The sodium lactate feed rate used during the fermentation process resulted in sustained dissolved hydrogen concentration in the reactor of <20 nM. During utilization of the initial batch feeding of lactate and YE added prior to inoculation, H_2 concentrations sometimes exceeded 100 nM, but during the extended fermentation process H_2 concentrations were typically 3–5 nM, which was similar to the half-velocity coefficient for hydrogen calculated for the VS culture (7 ± 2 nM; [3]).

Fermentation of lactate also led to an accumulation of VFAs (e.g., propionate and acetate) that could potentially inhibit dechlorinating organisms in the consortia. Studies with SDC-9TM demonstrated that dehalogenation of chlorinated ethenes by the culture was not inhibited by propionate and acetate concentrations to 6,000 mg/L (data not shown). Figure 2a, b shows the formation of VFAs during growth of SDC-9TM and PJKSTM, respectively. In both cases, the VFA concentrations did not reach inhibitory levels with the fermentation protocol described here. Notably, the SDC-9TM culture accumulated much less propionate and acetate than the PJKSTM culture grown under the same conditions. Although the reason for this lower accumulation of VFAs is not certain, it is likely due to evolution of the SDC-9TM consortium during several years of maintenance on lactate as a primary growth substrate, either in activity or member composition, to utilize VFAs more efficiently.

To optimize the growth of the SDC-9TM consortium it was necessary to determine a relationship between PCE feed rate and DHC cell concentration. We were most concerned about maintaining the VC-reducing population(s) in the consortia because VC reduction is less energetically favorable than the other dehalogenating reactions, so it was possible that PCE and TCE dehalogenating populations could outcompete the VC reducers if the higher chlorinated substrates were maintained in excess. Furthermore, Cupples et al. [3] observed that net decay in dechlorinating microorganisms could occur in the VS culture if DCE plus VC concentrations were below 0.7 μ M. In addition, with SDC-9TM, based on many biodegradation assays, the VC dechlorination rate is 28–35% of the PCE dechlorination rate. Therefore, there was a tendency for VC to accumulate in the fermentor during high-rate PCE feeding. Consequently, PCE feed rates were adjusted to prevent accumulation of PCE, TCE or *cis*-DCE while maintaining a residual VC concentration in the medium of ~ 1 mg/L (16 μ M). Evaluating the PCE feed rates during multiple fermentation runs, the results of the biodegradation assays, and the analyses of PCE, TCE *c*DCE, and VC concentrations during fermentation allowed us to optimize PCE feed rates for the growth of SDC-9TM consortium. The relationship between DHC yield and PCE feed rate could be described by the

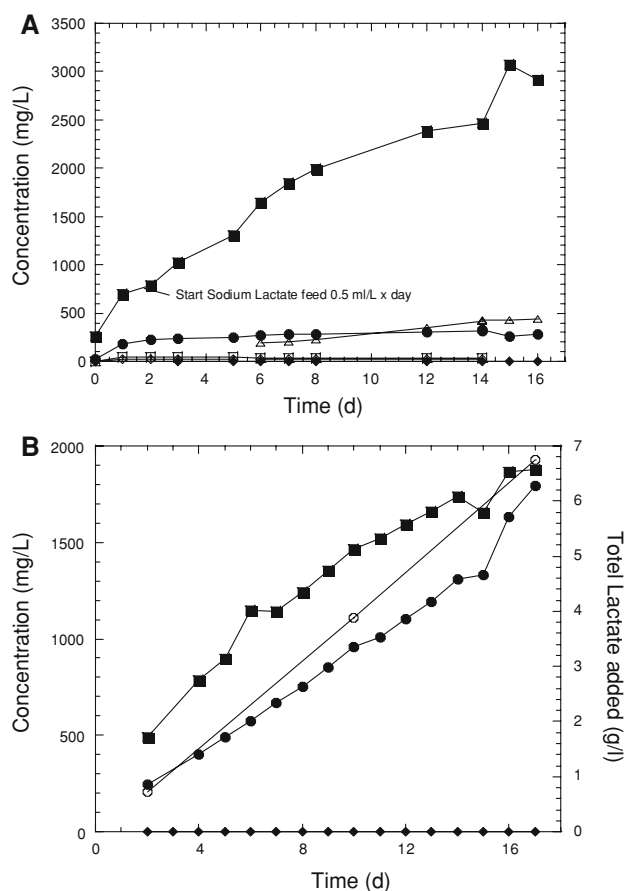

Fig. 2 Accumulation of VFAs during growth of SDC-9TM (a) or PJKSTM (b) in a 750-L fermentor. Symbols indicate lactic acid (filled diamond), propionic acid (filled circle), formic acid (open diamond), pyruvic acid (open square), butyric acid (open triangle), and acetic acid (filled square), or the total amount of sodium lactate added to the fermentor (open circle; b)

following equation: DHC concentration (cells/L) = $-6.77 \times 10^{11} + [8.40 \times 10^{11} \times \text{PCE feed rate (mg/h} \times \text{L)}]$ ($R = 0.999$).

Dehalogenation of chloroethenes by SDC-9TM also was affected by culture pH, with little or no dehalogenation below pH 5.0 (Fig. 3). Both reductive dehalogenation and fermentation of the growth substrates used to grow the cells consumes considerable amounts of alkalinity [24]. The pH of the medium in the 4,000-L fermentor decreased from an initial pH of 7.4 to approximately 6.1 during the first 30 days of cell growth (Fig. 1b). Because the culture was fed sodium lactate, however, the addition of NaOH to control pH could have led to an excess of sodium ions in the reactor that could affect cell growth. Therefore, instead of adding NaOH, the fermentors were sparged periodically with N_2 to remove dissolved CO_2 from the culture medium. This approach sufficiently regulated the medium pH to allow completion of the culture production (Fig. 1b), even though this may have been below the optimum pH for dehalogenation by the cultures.

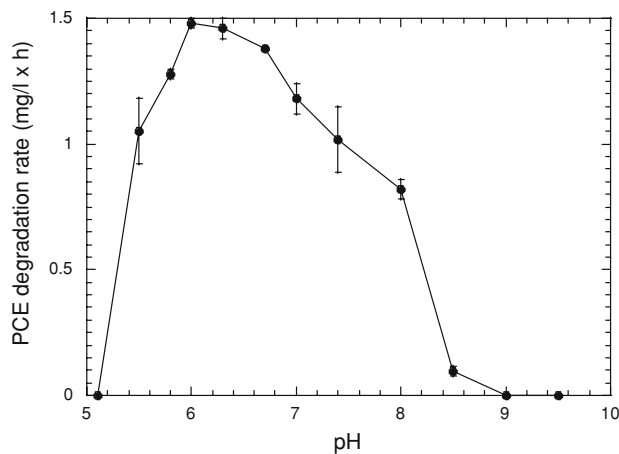

Fig. 3 Effect of culture pH on PCE dehalogenation by SDC-9™. Values represent the mean of triplicate samples, and *error bars* represent one standard error of the mean

Culture activity

The relative degradative activity of the grown dehalogenating cultures was evaluated by performing serum bottle biodegradation assays with the grown culture. The biodegradation assays evaluated the ability of the grown cultures to dehalogenate PCE and *c*DCE by incubating the cells in individual serum vials with either PCE or *c*DCE. An example of a PCE degradation activity assay is presented in Fig. 4. A summary of results from several assays with the three test cultures evaluated here is presented in Table 1. In each case, the specific activities of the resulting cultures were of a similar order of magnitude, but some variation was observed. Several factors could cause the

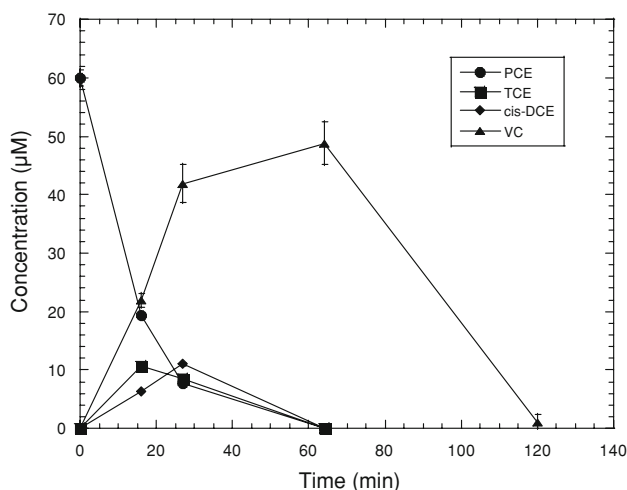

Fig. 4 Results of a PCE degradation assay with samples from a 550-L fermentation batch of the SDC-9™ culture. The assay was performed in 60-mL serum vials containing 60 mL SDC-9™ culture (0.52 g/L Dwt), 6 mM sodium lactate, and 10 mg/L PCE. Values represent means of triplicate samples and *error bars* represent one standard error of the mean

observed differences, including variability in the concentration of nondehalogenating organisms produced. That is, because the cultures were mixtures of dehalogenating and nondehalogenating microbes, even relatively small differences in the total concentration of nondehalogenating microbes could greatly affect the measured specific, dry-weight-based, activity measurements. Repetitive fermentation of SDC-9™ culture over the last 4 years has resulted in development of the current fermentation protocol that has resulted in a general increase in the specific activity of the produced cultures.

Related issues

The use of bioaugmentation to remediate chlorinated solvent-contaminated sites requires the shipment of cultures throughout the USA and elsewhere. Shipping a large volume of culture is costly, and ground transportation can require that the culture spend several days in shipping, which could affect culture activity. An alternate approach is to concentrate the culture to allow overnight shipping of a reduced culture volume. We used a tubular ceramic membrane system to concentrate consortia. The cell culture was chilled during concentration to ensure maintenance of cell viability. Analysis of the specific activity of the cells before and after concentration demonstrated only slight changes in activity during concentration. For example, specific activity of two cultures tested were 24.5 and 16.5 mg PCE/h × g Dwt before concentration and 22.6 and 15.1 mg PCE/h × g Dwt after concentration, respectively. Concentration resulted in approximately 90% reduction in culture volume, and it also removed ~90% of any fermentation byproducts remaining in the culture broth. It also allowed us to standardize the DHC concentration and activity of culture batches, thereby allowing users to more accurately estimate the volume of culture needed for field applications.

Storage of bacterial cultures also is critical for allowing timely delivery of cultures to contaminated sites to coordinate culture injection with the availability of field personnel and equipment (e.g., drilling rigs). To evaluate storage longevity, tenfold-concentrated SDC-9™ cultures were incubated for up to 90 days at either 4°C, 13°C, 22°C, or 28°C in stainless-steel containers. Periodically, samples of the stored cultures were removed and assayed for their ability to degrade PCE and *c*DCE. Activity of the culture decreased rapidly if stored at 13°C or 28°C, but SDC-9™ could be stored at 4°C for >40 day without measurable loss of activity (Fig. 5).

Conclusions

A fermentation protocol was developed for large-scale production of DHC-containing cultures for in situ

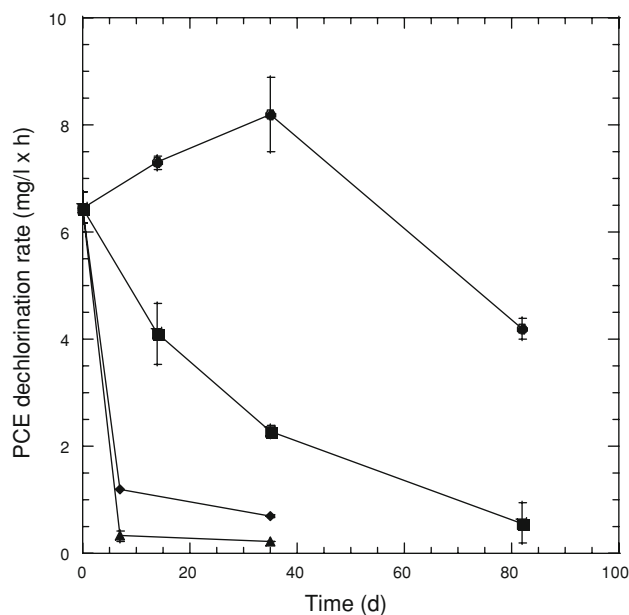

Fig. 5 Effect of storage conditions on the activity of concentrated SDC-9TM culture. Tenfold-concentrated SDC-9TM culture was stored anaerobically and without substrate at either 4°C (filled circle), 13°C (filled square), 22°C (filled diamond) or 28°C (filled triangle). Values represent means of triplicate samples, and error bars are one standard error of the mean

bioaugmentation of chlorinated ethene-contaminated aquifers. The performance of the SDC-9TM culture in contaminated aquifer material is described elsewhere [28]. Success of the fermentation process was dependant on electron donor (i.e., lactate) and acceptor (PCE) feed rate, and the addition of YE greatly improved cell yield. The initial stages of fermentation were characterized by a rapid growth of non-DHC organisms in the culture, while the growth rate of DHC within the consortia tested exhibited a short lag and then was relatively constant to final DHC concentrations of $>10^{11}$ /L. The fermentation protocol was scalable to 550 L and 3,200 L and produced comparable results for consortia enriched from three different sites.

Based on 16S RNA gene sequencing the SDC-9TM culture contains multiple DHC strains (data not shown), and it is possible that growth of the individual dehalogenating strains within the culture might be different during the fermentation process. Although this could not be monitored during this study, our results demonstrated that both PCE and *c*DCE dehalogenation activities were high in the final cultures, and the culture degraded VC well, albeit at a lower rate than PCE and *c*DCE dehalogenation. This suggests that the described procedure supports the growth of DHC that are able to completely dehalogenate chlorinated ethenes, including vinyl chloride. Our results also demonstrate that DHC-containing cultures designed for bioaugmentation can be concentrated by cross-flow filtration to reduce shipping

volumes, and that the concentrated cultures can be stored under refrigeration for >40 days to allow for injection schedule flexibility.

With the increased use of bioaugmentation to treat challenging chlorinated ethene-contaminated sites, the ability to produce large volumes of high-density cultures is becoming increasingly important. This study provides useful information to aid in the production of cultures for bioaugmentation, even at scales suitable for treating large contaminant plumes.

Acknowledgments The authors thank Randi Rothmel, Antonio Soto, Kevin McClay, and Paul Hedman for excellent analytical support. This project was supported by the Environmental Security Technology Certification Program (ESTCP) project number CU-0515. Any opinions, findings, and conclusions or recommendations expressed in this material are those of the authors and do not necessarily reflect those of the US Army Corp. of Engineers, Humphreys Engineer Center Support Activity.

References

- Cupples AM, Spormann AM, McCarty PL (2003) Growth of a *Dehalococcoides*-like microorganism on vinyl chloride and *cis*-dichloroethene as electron acceptors as determined by competitive PCR. *Appl Environ Microbiol* 69:953–959. doi:10.1128/AEM.69.2.953-959.2003
- Cupples AM, Spormann AM, McCarty PL (2004) Comparative evaluation of chloroethene dechlorination to ethane by *Dehalococcoides*-like microorganisms. *Environ Sci Technol* 38:4768–4774. doi:10.1021/es049965z
- Cupples AM, Spormann AM, McCarty PL (2004) Vinyl chloride and *cis*-dichloroethene dechlorination kinetics and microorganism growth under substrate limiting conditions. *Environ Sci Technol* 38:1102–1107. doi:10.1021/es0348647
- Duhamel M, Mo K, Edwards EA (2004) Characterization of a highly enriched *Dehalococcoides*-containing culture that grows on vinyl chloride and trichloroethene. *Appl Environ Microbiol* 70:5538–5545. doi:10.1128/AEM.70.9.5538-5545.2004
- Ellis DE, Lutz EJ, Odom JM, Ronald J, Buchanan J, Bartlett C, Lee MD, Harkness MR, Deweerdt KA (2000) Bioaugmentation for accelerated in situ anaerobic bioremediation. *Environ Sci Technol* 34:2254–2260. doi:10.1021/es990638e
- Griffin BM, Tiedje JM, Löffler FE (2004) Anaerobic microbial reductive dechlorination of tetrachloroethene (PCE) to predominantly *trans*-1, 2 dichloroethene. *Environ Sci Technol* 38:4300–4303. doi:10.102/es035439g
- He J, Ritalahti KM, Aiello MR, Löffler FE (2003) Complete detoxification of vinyl chloride by an anaerobic enrichment culture and identification of the reductively dechlorinating population as *Dehalococcoides* species. *Appl Environ Microbiol* 69:996–1003. doi:10.1128/AEM.69.2.996-1003.2003
- He J, Ritalahti KM, Yang KL, Koenigsberg SS, Löffler FE (2003) Detoxification of vinyl chloride to ethene coupled to growth of an anaerobic bacterium. *Nature* 424:62–65. doi:10.1038/nature01717
- He J, Holmes V, Lee PKH, Alvarez-Cohen L (2007) Influence of vitamin B₁₂ and co-cultures on the growth of *Dehalococcoides* isolates in defined medium. *Appl Environ Microbiol* 73:2847–2853. doi:10.1128/AEM.02574-06
- He J, Sung Y, Krajmalnik-Brown R, Ritalahti KM, Löffler FE (2005) Isolation and characterization of *Dehalococcoides* sp.

- Strain FL2, a trichloroethene (TCE) and 1,2-dichloroethene-respiring anaerobe. *Environ Microbiol* 7:1442–1450. doi:[10.1111/j.1462-2920.2005.00830.x](https://doi.org/10.1111/j.1462-2920.2005.00830.x)
11. Hendrickson ER, Payne JA, Young RM, Starr MG, Perry MP, Fahnestock S, Ellis DE, Ebersole RC (2002) Molecular analysis of *Dehalococcoides* 16S ribosomal DNA from chloroethene-contaminated sites throughout North America and Europe. *Appl Microbiol* 68:485–495. doi:[10.1128/AEM.68.2.485-495.2002](https://doi.org/10.1128/AEM.68.2.485-495.2002)
 12. Holliger C, Wohlfarth G, Diekert G (1999) Reductive dechlorination in the energy metabolism of anaerobic bacteria. *FEMS Microbiol Rev* 22:383–398. doi:[10.1111/j.1574-6976.1998.tb00377.x](https://doi.org/10.1111/j.1574-6976.1998.tb00377.x)
 13. Holliger C, Schumacher W (1994) Reductive dehalogenation as a respiratory process. *Antonie Van Leeuwenhoek* 66:239–246. doi:[10.1007/BF00871642](https://doi.org/10.1007/BF00871642)
 14. Lee MD, Odum JM, Buchanan RJ Jr (1998) New perspectives on microbial dehalogenation of chlorinated solvents: insights from the field. *Annu Rev Microbiol* 52:423–452. doi:[10.1146/annurev.micro.52.1.423](https://doi.org/10.1146/annurev.micro.52.1.423)
 15. Lendvay JM, Löffler FE, Dollhopf M, Aiello MR, Daniels G, Fathepure BZ, Gebhard M, Heine R, Helton R, Shi J, Krajmalnik-Brown R, Major CL Jr, Barcelona MJ, Petrovskis E, Tiedje JM, Adriaens P (2002) Bioreactive barriers: bioaugmentation and biostimulation for chlorinated solvent remediation. *Environ Sci Technol* 37:1422–1431. doi:[10.102/es025985u](https://doi.org/10.102/es025985u)
 16. Löffler FE, Cole JR, Ritalahti KM, Tiedje JM (2003) Diversity of dechlorinating bacteria. In: Häggblom MM, Bossert ID (eds) *Dehalogenation: microbial processes and environmental applications*. Kluwer Academic Press, New York, pp 53–87. doi:[10.1007/0-306-48011-5_3](https://doi.org/10.1007/0-306-48011-5_3)
 17. Löffler FE, Sun Q, Li J, Tiedje JM (2000) 16S rRNA gene-based detection of tetrachloroethene-dechlorinating *Desulfuromonas* and *Dehalococcoides* species. *Appl Environ Microbiol* 66:1369–1374. doi:[10.1128/AEM.66.4.1369-1374.2000](https://doi.org/10.1128/AEM.66.4.1369-1374.2000)
 18. Löffler FE, Tiedje JM, Sanford RA (1999) Fraction of electrons consumed in electron acceptor reduction and hydrogen thresholds as indicators of halo-respiratory physiology. *Appl Environ Microbiol* 65:4049–4056
 19. Lu X, Wilson JT, Kampbell DH (2006) Relationship between *Dehalococcoides* DNA in ground water and rates of reductive dechlorination at field scale. *Water Res* 40:3131–3140. doi:[10.1016/j.watres.2006.05.030](https://doi.org/10.1016/j.watres.2006.05.030)
 20. Lu X-X, Tao S, Bosma T, Gerritse J (2001) Characteristic hydrogen concentrations for various redox processes in batch study. *J Environ Sci Health A* 36:1725–1734. doi:[10.1081/ESE-100106254](https://doi.org/10.1081/ESE-100106254)
 21. Major DW, McMaster ML, Cox EE, Edwards EA, Dworatzek SM, Hendrickson ER, Starr MG, Payne JA, Buonamici LW (2002) Field demonstration of successful bioaugmentation to achieve dechlorination of tetrachloroethene to ethene. *Environ Sci Technol* 36:5106–5116. doi:[10.1021/es0255711](https://doi.org/10.1021/es0255711)
 22. Maymó-Gatell X, Anguish T, Zinder SH (1999) Reductive dechlorination of chlorinated ethenes and 1, 2-dichloroethane by “*Dehalococcoides ethenogenes*” 195. *Appl Environ Microbiol* 65:3108–3113
 23. Maymó-Gatell X, Chien YT, Gossett JM, Zinder SH (1997) Isolation of a bacterium that reductively dechlorinates tetrachloroethene to ethene. *Science* 276:1568–1571. doi:[10.1126/science.276.5318.1568](https://doi.org/10.1126/science.276.5318.1568)
 24. McCarty PL, Chu M-Y, Kitanidis PK (2006) Electron donor and pH relationships for biologically enhanced dissolution of chlorinated solvent DNAPL in groundwater. *Eur J Soil Biol* 43:276–282. doi:[10.1016/j.ejsobi.2007.03.004](https://doi.org/10.1016/j.ejsobi.2007.03.004)
 25. Moran MJ, Zogorski S (2007) Chlorinated solvents in groundwater of the United States. *Environ Sci Technol* 41:74–81. doi:[10.1021/es061553y](https://doi.org/10.1021/es061553y)
 26. Müller JA, Rosner BM, von Abendroth G, Meshulam-Simon G, McCarty PL, Spormann AM (2004) Molecular identification of the catabolic vinyl chloride reductase from *Dehalococcoides* sp. strain VS and its environmental distribution. *Appl Environ Microbiol* 70:4880–4888. doi:[10.1128/AEM.70.8.4880-4888.2004](https://doi.org/10.1128/AEM.70.8.4880-4888.2004)
 27. Ritalahti KM, Amos BK, Sung Y, Wu Q, Koenigsberg SS, Löffler FE (2006) Quantitative PCR targeting 16S rRNA and reductive dehalogenase genes simultaneously monitors multiple *Dehalococcoides* strains. *Appl Environ Microbiol* 72:2765–2774. doi:[10.1128/AEM.72.4.2765-2774.2006](https://doi.org/10.1128/AEM.72.4.2765-2774.2006)
 28. Schaefer CE, Condee CW, Vainberg S, Steffan RJ (2009) Bioaugmentation for chlorinated ethenes using *Dehalococcoides* sp.: comparison between batch and column experiments. *Chemosphere* 75:141–148. doi:[10.1016/j.chemosphere.2008.12.041](https://doi.org/10.1016/j.chemosphere.2008.12.041)
 29. Shelton DR, Tiedje JM (1984) General method for determining anaerobic biodegradation potential. *Appl Environ Microbiol* 47:850–857
 30. Smidt H, de Vos WM (2004) Anaerobic microbial dehalogenation. *Annu Rev Microbiol* 58:43–73. doi:[10.1146/annurev.micro.58.030603.123600](https://doi.org/10.1146/annurev.micro.58.030603.123600)
 31. Sung Y, Ritalahti KM, Apkarian RP, Löffler (2006) Quantitative PCR confirms purity of strain GT, a novel trichloroethene-to-ethene-respiring *Dehalococcoides* isolate. *Appl Environ Microbiol* 72:1980–1987. doi:[10.1128/AEM.72.3.1980-1987.2006](https://doi.org/10.1128/AEM.72.3.1980-1987.2006)
 32. U.S. EPA (1998) U.S. EPA test methods for evaluating solid waste, physical/chemical methods SW846, 3rd edn. Revision 5, 1998
 33. Westrick JJ, Mello JW, Thomas RF (2004) The groundwater supply survey. *J Am Water Works Assoc* 76:52–59
 34. Yang Y, McCarty PL (1998) Competition for hydrogen within a chlorinated solvent dehalogenating anaerobic mixed culture. *Environ Sci Technol* 32:3591–3597. doi:[10.1021/es991410u](https://doi.org/10.1021/es991410u)
 35. Zhang J, Andrew AP, Chiu PC (2006) 1,1-Dichloroethene as a predominant intermediate of microbial trichloroethene reduction. *Environ Sci Technol* 40:1830–1836

APPENDIX E

**Submitted for Publication: “Field-Scale Evaluation of
Bioaugmentation Dosage for Treating Chlorinated Ethenes”.**

Field Scale Evaluation of Bioaugmentation Dosage for Treating Chlorinated Ethenes

Charles E. Schaefer*, David R. Lippincott, Robert J. Steffan

Shaw Environmental, Inc.

Lawrenceville, NJ 08648

* Corresponding Author: Charles.schaefer@shawgrp.com

Originally submitted to Ground Water Monitoring & Remediation on July 28, 2009. Re-submitted on February 23, 2010

Abstract

A field demonstration was performed to evaluate the impacts of bioaugmentation dosage for treatment of chlorinated ethenes in a sandy to silty shallow aquifer. Specifically, bioaugmentation using a commercially available *Dehalococcoides*-containing culture was performed in three separate groundwater re-circulation loops, with one loop bioaugmented with 3.9×10^{11} *Dehalococcoides* (DHC), the second loop bioaugmented with 3.9×10^{12} DHC, and the third loop bioaugmented with 3.9×10^{13} DHC. Groundwater monitoring was performed to evaluate DHC growth and migration, dechlorination rates, and aquifer geochemistry. The loop inoculated with 3.9×10^{12} DHC showed slower dechlorination rates and DHC migration/growth compared to the other loops. This relatively poor performance was attributed to low pH conditions. Results for the loops inoculated with 3.9×10^{11} DHC and 3.9×10^{13} DHC showed similar timeframes for dechlorination, as evaluated at a monitoring well approximately 10 feet downgradient of the DHC injection well. Application of a recently developed one-dimensional bioaugmentation fate and transport screening model provided a reasonable prediction of the data in these two loops. Overall, these results suggest that increasing bioaugmentation dosage does not necessarily result in decreased dechlorination timeframes in the field. The ability to predict results suggests that modeling potentially can serve as an effective tool for determining bioaugmentation dosage and predicting overall remedial timeframes.

Introduction

Chlorinated ethenes, such as tetrachloroethene (PCE) and trichloroethene (TCE) have been used extensively as industrial solvents and cleaning agents at several government and private sector facilities. This widespread use, in addition to improper disposal practices and the stability of chlorinated ethenes, have led to them becoming common groundwater contaminants. One *in situ* technology that has proven to be effective at treating chlorinated ethenes is bioaugmentation (USEPA 2004; ITRC 2005, 2007). Bioaugmentation for chlorinated ethenes involves delivery of electron donor, bacteria, and (if needed) nutrients to the subsurface for the purpose of facilitating microbially-enhanced reductive dechlorination. The most accepted form of bioaugmentation for chlorinated ethenes involves the use of mixed anaerobic cultures that contain *Dehalococcoides* sp. (DHC), or closely related strains, that can reductively dechlorinate the chlorinated ethenes; DHC are the only bacteria known to completely dechlorinate PCE and TCE (Maymó-Gatell et al. 1997).

Several studies have been performed using model or real aquifers to evaluate bioaugmentation for treating chlorinated ethenes, and for evaluating the relationship between measured DHC concentration and observed dechlorination rates. Using laboratory silica sand columns, Amos et al. (2009) showed that bioaugmented DHC responsible for dechlorination were primarily associated with the solid phase. In contrast, Schaefer et al. (2009) showed that the bioaugmented DHC were primarily associated with the aqueous phase (with the exception of a localized region near the column influent), and Lu et al. (2006) showed that there was a relationship between DHC in groundwater and observed dechlorination rates.

While the studies referenced above have provided substantial insight into the processes that control DHC growth, distribution, and dechlorination kinetics during bioaugmentation, there currently exists considerable uncertainty when designing and implementing bioaugmentation at the field scale. These uncertainties can have substantial ramifications on the technical and economic success of *in situ* bioaugmentation. Key unknowns include uncertainty related to the inoculated DHC dosage needed to treat a contaminated site, the transport and distribution of DHC in the aquifer, and DHC activity with respect to growth and dechlorination rates (ESTCP 2005). In particular, the relationship between DHC injection dosage and aquifer response with respect to DHC distribution and observed dechlorination rates is poorly understood. No generally accepted conceptual model exists and (to the best of our knowledge) no published field studies exist that can sufficiently address these uncertainties.

The purpose of this study was to quantitatively evaluate bioaugmentation performance at the field scale by measuring DHC distribution, DHC growth, and dechlorination of TCE, *cis*-1,2-dichloroethene (DCE), and vinyl chloride as a function of bioaugmentation dosage. Field results were evaluated by using a previously developed bioaugmentation model. The model was used to provide additional insights into the mechanisms controlling the observed behavior.

Methods

Generalized Approach

The bioaugmentation evaluation was performed by delivering DHC to three groundwater re-circulation loops for treating TCE and DCE; each groundwater re-circulation loop was inoculated with a different DHC dosage. A fourth groundwater re-circulation loop, which

received no DHC inoculation, served as a control. Groundwater was monitored within each re-circulation loop to evaluate the extent of TCE and DCE dechlorination over time, and to determine DHC growth and migration. Results among the re-circulation loops were compared to assess the impact of bioaugmentation dosage on observed treatment timeframes and overall effectiveness.

Demonstration Location and Description

The bioaugmentation demonstration was performed at Fort Dix, which is located in Burlington and Ocean counties, New Jersey, approximately 25 miles southeast of Trenton. The actual demonstration plot was located within the MAG-1 Area, which is located in the northern part of the Cantonment Area at Fort Dix. The geology underlying the field demonstration site consisted of unconsolidated materials from the Kirkwood and Manasquan formations. Results of the pre-demonstration testing to evaluate the hydrogeology and contaminant distribution in the test area are summarized in Figure 1. Soils from the targeted bioaugmentation zone (approximately 104 to 90 feet MSL) consisted of saturated, light gray silty fine sands (Kirkwood Formation). A 4- to 8-inch thick interface zone, consisting of fine to coarse sands and fine gravel, is present at the base of this unit. The interface zone appears to exhibit significantly higher permeability than the formations above and below. Dissolved contaminants consisted primarily of TCE and DCE at concentrations up to $2,900 \mu\text{g L}^{-1}$, as measured via discrete Geoprobe® sampling points. Baseline sampling events showed that no vinyl chloride or ethene were present in the test area groundwater. Hydraulic conductivities estimated using slug test

data ranged from 0.6 m day^{-1} to 1.8 m day^{-1} in the targeted zone of the Kirkwood formation. Ambient groundwater velocity through the demonstration zone was approximately $0.0018 \text{ m day}^{-1}$. Measurement of TCE and DCE concentrations in soil samples collected adjacent to the Geoprobe® groundwater sampling points allowed for estimation of a linear adsorption coefficient; the estimated values for TCE and DCE were 2.1 and 1.1 L kg^{-1} , respectively.

Recirculation System Design and Amendment Addition

A groundwater recirculation system was installed and implemented for the bioaugmentation demonstration. The system design consisted of four pairs of injection/extraction wells (IW-1 through IW-4, and EX-1 through EX-4) operating at approximately 1.9 L min^{-1} per pair; this system was located in the center of the TCE/DCE groundwater plume. The actual surveyed system layout, including performance monitoring wells (BMW-1 through BMW-8) within each recirculation loop is shown in Figure 2. These monitoring wells were spaced approximately 10 feet and 20 feet downgradient of the groundwater injection well. Three additional performance monitoring wells (BMW-9 through BMW-11) were located between or side-gradient of select loops. Loop 4 was used as a control loop. Well construction details are summarized in Table 1.

Amendment metering pumps for delivery of electron donor (sodium lactate), tracer (sodium bromide) and buffer (sodium bicarbonate and/or sodium carbonate) solutions were installed within a Conex box. A 836 L polyethylene tank containing a 50:50 volume mix of 60% liquid sodium lactate solution and de-ionized water was used to deliver electron donor to each of the recirculation loops. The lactate solution was metered into each of the four injection wells (operating at approximately 1.9 L min^{-1}) at $0.0025 \text{ L min}^{-1}$, thereby attaining a final sodium

lactate injection concentration of 400 mg L^{-1} . An additional eight 836 L polyethylene tanks were used to deliver buffer, and nutrients (diammonium phosphate and yeast extract). The solution was metered into each of the injection wells between 0.048 L min^{-1} and 0.12 L min^{-1} , thereby attaining a final buffer injection concentration of between approximately $1,700 \text{ mg L}^{-1}$ and $4,300 \text{ mg L}^{-1}$. Sodium bicarbonate buffer was used from Start-up (November 16, 2007) until December 11, 2007, at which time the buffer used was changed to sodium carbonate to more effectively increase pH within the aquifer. Additionally, diammonium phosphate was mixed into the buffer solution tanks, attaining a final injection concentration of approximately 75 mg L^{-1} . The final injection concentration for the yeast extract was approximately 50 mg L^{-1} . Individual feed lines were run from the tanks to the corresponding metering pump and from the metering pump to injection racks installed within a second Conex box. The injection racks contained filter housings, flow meters, pressure gauges, and injection ports for the amendments.

Bulk injections of sodium carbonate were performed on December 27, 2007 (45 kg per well) and January 15, 2008 (68 kg per well) at each of the four groundwater injection wells. Sodium carbonate powder was mixed in drums with groundwater extracted from each of the injections wells, then re-injected into the wells. These bulk injections were performed to further elevate groundwater pH values that still largely remained below 5.5 standard units after several weeks of system operation.

Tracer Testing

Amendment delivery and re-circulation, as described in the previous section, were performed for a 10-week start-up period. During this start-up period, a tracer test was performed

concurrently using sodium bromide in loops 1 and 3. Forty-five kilograms of sodium bromide were mixed into the buffer tanks with Site groundwater. A total of 1938 L of solution (three 646 L batches), with an average bromide concentration of approximately $9,100 \text{ mg L}^{-1}$, was prepared in the buffer tanks for Loops 1 and 3. Tracer injections began on November 16, 2006, and were completed on December 14, 2007. The buffer metering pumps were used to inject the tracer solution continuously into the injection wells during active groundwater recirculation periods. The bromide solution was metered into the injection wells at 0.048 L min^{-1} at an average injection well concentration of approximately 225 mg L^{-1} .

Groundwater sampling was performed at select monitoring locations within the demonstration area to monitor migration of tracer, lactate and carbonate, determine the appropriate changes in aquifer geochemical conditions (i.e., decreases in dissolved oxygen and other electron acceptors, decreases in oxidation-reduction potential (ORP)), to evaluate changes in dissolved chlorinated ethene concentrations due to system mixing, and to determine baseline conditions prior to bioaugmentation.

Bioaugmentation

Bioaugmentation was performed on May 1, 2008 (approximately 150 days after recirculating amendments) using the commercially available SDC-9 culture (Shaw Environmental, Inc., Lawrenceville, New Jersey). The dechlorination and growth kinetics of this DHC-containing culture have been described previously (Schaefer et al., 2009). Bioaugmentation implementation consisted of first pumping approximately 190 L of groundwater from wells BMW-1, BMW-3, and BMW-5 into individual 55-gallon drums. Drums

were amended with lactate, diammonium phosphate, and yeast extract for final concentrations of 16,000 mg L⁻¹, 1,000 mg L⁻¹, and 1,000 mg L⁻¹, respectively. The SDC-9 culture, which was delivered to the site under nitrogen pressure in three individual soda kegs, was injected into wells BMW-1, BMW-3, and BMW-5 through Tygon tubing that was lowered into the water column within each well to the approximate middle of the screened interval. The groundwater injection wells (IW1 through IW4) were not used for delivery of the SDC-9 culture because of locally elevated pH (~ 10) measured in these wells. The concentration of DHC in the soda kegs, as measured via quantitative polymerase chain reaction (qPCR), was 3.9 x 10¹¹ DHC L⁻¹. The tubing was connected to a valve on the outlet port of each soda keg containing the bacteria. A nitrogen cylinder was connected to the inlet port of the soda keg. The soda keg was pressurized to approximately 10 psi using the nitrogen, and the outlet valve was opened allowing the culture to be injected into each well.

A total of 100 liters (10 L of culture concentrated 10-times; 3.9 x 10¹³ DHC), 10 liters (3.9 x 10¹² DHC), and 1 liter (3.9 x 10¹¹ DHC) of culture were injected into wells BMW-1, BMW-3, and BMW-5, respectively. Bioaugmentation was not performed at well BMW-7 in recirculation loop 4, as this was used as the control loop. Each bioaugmentation injection took approximately 20 minutes to perform. Once the injection of the culture was complete, the 190 L of groundwater extracted from each of the injection wells was pumped back into the respective wells to further distribute the culture within the surrounding formation.

System Operation and Monitoring

After bioaugmentation was performed, the recirculation system was operated in an intermittent mode (approximately 10 days “on”, and 10 days “off”). In addition, groundwater recirculation flowrates were decreased to approximately 0.57 L min^{-1} due to increasing pressures at the injection wells, and to limit cross-flow between the loops.

Groundwater samples were collected by utilizing low-flow purging in accordance with NJDEP Low Flow Purging and Sampling Guidance, with the exception of purge times being limited to 60 minutes at each well before samples are collected. Samples were obtained using dedicated submersible bladder pumps and Teflon tubing. A YSI field meter with a flow-through cell was used to collect measurement of field geochemical parameters (pH, ORP, temperature, specific conductivity, and dissolved oxygen). Analyses of groundwater collected during the performance monitoring sampling events included VOCs, reduced gases, volatile fatty acids (VFAs), anions, and qPCR to measure DHC concentrations in groundwater.

Analytical Methods

Analysis of chloride, bromide, nitrate, nitrite, and sulfate by EPA Method 300.0, volatile fatty acids (VFAs) by EPA Method 300m, chlorinated ethenes by EPA Method 8260, and reduced gases by EPA Method 8015 were performed by Shaw’s New Jersey certified analytical laboratory in Lawrenceville, NJ. DHC concentrations in the groundwater samples were determined by quantitative real-time PCR with primers (5’- gaagtagtgaaccgaaagg and 5’- tctgtccattgtagcgtc) that amplified a 235bp fragment of the 16s rRNA gene of DHC-type organisms.

Results and Discussion

Tracer and Amendment Distribution

The bromide tracer was distributed through Loops 1 and 3 quickly, with detectable concentrations of bromide observed at extraction wells EX-1 and EX-3 within 10 and 18 days, respectively. Analysis of the tracer test data indicated that the estimated travel time of the bromide tracer through Loops 1 and 3 (from the injection to the extraction well) was approximately 30 to 40 days, with an average groundwater velocity of 0.23 to 0.30 m day⁻¹. These estimates were based on groundwater extraction/reinjection rates of 1.9 L min⁻¹ per loop. However, because groundwater extraction rates were reduced to 0.57 L min⁻¹ and were operated in an intermittent mode after bioaugmentation was performed, the average groundwater velocity was significantly decreased (to approximately 0.025 m day⁻¹) during the bioaugmentation portion of the demonstration. Tracer results for BMW-1 are provided in the Supplemental Materials.

Limited cross flow occurred between Loops 1 and 2 and Loops 3 and 4 during the tracer test. Bromide concentrations observed within Loops 2 and 4 were generally 1 to 2 orders of magnitude below those observed in Loops 1 and 3. As previously discussed, groundwater extraction rates were 1.9 L min⁻¹ for each of the 4 extraction wells during the tracer testing. These pumping rates were reduced after the tracer test was completed, which resulted in a decrease in bromide concentration in Loops 2 and 4 to approximately 1 mg L⁻¹ (bromide concentrations remained above 20 mg L⁻¹ in Loops 1 and 3 throughout the demonstration). Additionally, as discussed in subsequent sections, vinyl chloride, ethene, and elevated DHC concentrations were not observed in the control loop (Loop 4), indicating that significant cross

flow between Loops 3 and 4 likely was not occurring at the reduced (0.57 L min^{-1}) flow rates during the bioaugmentation portion of the demonstration.

Sidegradient monitoring well BMW-9 showed elevated VFA and bromide concentrations throughout the demonstration. However, sidegradient monitoring wells BMW-10 and BMW-11 did not show any impacts of the recirculation system (i.e., no measureable bromide or VFAs). Based on these data, amendment distribution in each loop subsequent to bioaugmentation was estimated at 15 to 25 ft. perpendicular to recirculation flow (as indicated by the dashed outline for each loop in Figure 2).

During amendment delivery, but prior to bioaugmentation, several changes in aquifer geochemical and contaminant conditions were observed. Monitoring wells BMW-1 through BMW-8 showed that addition of the buffer solutions resulted in a gradual increase in aquifer pH from approximately 4.5 to 6.5. Distribution of lactate was evidenced by volatile fatty acid concentrations (predominantly lactate fermentation products acetate and propionate) ranging from 50 to $2,000 \text{ mg L}^{-1}$ at the monitoring wells. ORP values decreased from baseline levels of approximately +100mV to approximately -200mV in the monitoring wells in each of the four loops, and sulfate concentrations decreased from approximately 50 mg L^{-1} to 3 mg L^{-1} .

Pre-bioaugmentation amendment delivery also resulted in substantial decreases in TCE at BMW-5, and small to moderate decreases in TCE at BMW-7 and BMW-8 (Figures 3 through 6). Results of preliminary laboratory column experiments using site soil and groundwater showed that addition of electron donor without bioaugmentation resulted in dechlorination of TCE, but no subsequent dechlorination of DCE and vinyl chloride. The observed decreases in TCE concentrations in the field results are consistent with this laboratory result. However, as shown

in Figures 3 through 6, a stoichiometric increase in DCE (or any other ethene) was not observed in the field prior to bioaugmentation. This is particularly evident at BMW-5. Thus, the decreases in TCE observed prior to bioaugmentation may be partially due to *in situ* mixing effects rather than to reductive dechlorination.

No generation of vinyl chloride or ethene occurred prior to bioaugmentation in any of the monitoring locations. Measured DHC concentrations at monitoring wells in all four loops increased from baseline concentrations (prior to amendment addition) of approximately 10^3 DHC L^{-1} to 10^4 to 10^5 DHC L^{-1} (after approximately 140 days of amendment addition, and just prior to bioaugmentation) (Figures 3 through 6). The lack of measureable DCE dechlorination despite these increasing DHC levels likely is the result of slow dechlorination kinetics and/or the inability of native DHC to dechlorinate DCE.

Bioaugmentation

As shown in Figures 3 through 5, bioaugmentation at BMW-1, BMW-3, and BMW-5 resulted in a substantial increase in DHC concentrations; DHC concentrations in these wells measured 18 days after bioaugmentation showed increases that were approximately proportional to the DHC injection dosage. Bioaugmentation also resulted in dechlorination of TCE and DCE, as evidenced by vinyl chloride and ethene generation measured in the bioaugmentation injection locations. With the exception of BMW-1, DHC concentrations increased in the monitoring wells following the initial bioaugmentation (the reason for this lack of observed growth in BMW-1 is discussed in the modeling results section). DHC concentrations in the control loop show a gradual increase to 10^6 DHC L^{-1} over the course of the demonstration. This increase could be

due to a slow migration of DHC from Loop 3, and/or the slow growth of indigenous DHC. However, no measureable DCE dechlorination (as evidenced by vinyl chloride or ethene generation) was observed in the control loop during the duration of the demonstration (Figure 6).

Comparison among BMW-1, BMW-3, and BMW-5 shows that DHC dosage impacts the timeframe for DCE dechlorination. DCE conversion to ethene was most rapid in BMW-1 (highest DHC dosage, with conversion occurring within 14 days) and slowest in BMW-5 (lowest DHC dosage, with substantial conversion occurring in 50 to 100 days). These data also suggest that DHC groundwater concentrations were (approximately) proportional to the observed dechlorination timeframes.

Results at the downgradient monitoring well in each treatment loop (i.e., BMW-2, BMW-4, and BMW-6) also were compared. Evidence of DCE dechlorination and increases in DHC concentration were delayed in BMW-2 and BMW-6 by several weeks (relative to the bioaugmentation injection wells). This delay is presumably due to the travel time required for DHC and treated groundwater to migrate downgradient. Interestingly, both BMW-2 and BMW-6 show removal of DCE in approximately 250 days, despite a 100-fold difference in DHC dosage in the treatment loop.

In contrast, results at BMW-4 show limited DCE dechlorination and DHC concentrations remained below 10^7 DHC L⁻¹. One explanation for the relatively poor treatment at this monitoring location is that pH levels ranged from 4.9 to 5.8 during at least a 64 day period (days 116 to 180) in this well. At these pH levels, DHC dechlorination of DCE is severely inhibited (Vainberg et al. 2009). Increasing the buffer concentration ultimately resulted in an increase in pH within this loop. The decrease in DCE, accompanied by the increase in DHC and vinyl

chloride, at day 150 suggests that treatment was beginning to occur in this well by the end of the demonstration period.

Increases in DHC levels ($\sim 10^7$ DHC L⁻¹) were measured in EX-1 by day 193. Increases in DHC levels at EX-2 and EX3 (10^7 and 10^8 DHC L⁻¹, respectively) were measured by day 248. Ethene concentrations at EX-1 through EX-3 by day 248 were 0.5 μ M, 0.06 μ M, and 1.3 μ M, respectively. These data suggest that DHC and treated groundwater were migrating towards the extraction wells. However, no measureable decrease in DCE concentrations were measured at the extraction wells, suggesting that the extraction wells were still capturing untreated groundwater from the sidegradient and/or downgradient aquifer.

Screening Level Model

To provide a first level evaluation of *in situ* dechlorination rates and DHC growth, and to further evaluate the mechanisms responsible for the observed microbial growth and dechlorination rates, the 1-dimensional screening level bioaugmentation model developed by Schaefer et al. (2009) for the SDC-9 culture was applied to demonstration loops 1 and 3. This model employs Monod kinetics to describe DHC growth and dechlorination rates (determined for the SDC-9 culture in batch kinetic studies), and applies an attachment-detachment type mechanism to describe DHC migration through soil. The model assumes that both immobile and mobile DHC near the bioaugmentation injection well, and mobile DHC migrating downgradient from the bioaugmentation injection well, contribute to contaminant dechlorination. This finite difference model ($\Delta x=1$ ft, $\Delta t=0.4$ days) was applied to describe DHC growth and dechlorination from BMW-1 to BMW-2, and from BMW-5 to BMW-6. Because of the low pH issue at BMW-

4, which likely resulted in inhibition of DCE dechlorination, the model was not applied to loop 2. The simulated porosity was assumed to be 0.35, and the superficial velocity for loops 1 and 3 were estimated (based on the bromide tracer data, and adjusted based on the reduction in recirculation flow rate after bioaugmentation in each loop) at 0.021 m day^{-1} and 0.029 m day^{-1} , respectively. The dispersivity was estimated based on the bromide tracer data at 0.15 m. The linear sorption coefficient for vinyl chloride was estimated at 3.8 L kg^{-1} , which was calculated based on the DCE sorption coefficient and the organic carbon partition coefficient of vinyl chloride relative to that of DCE (USEPA 1996). The linear sorption coefficient for ethene was assumed equal to that of vinyl chloride. The lone fitting parameter in the model was the attachment-detachment ratio of growing DHC in the soil. The best fit of this parameter (f) was approximately 0.9, indicating that 10% of the DHC growing in the soil detach and subsequently migrate through the aquifer. Model details are provided in the Supplemental Materials.

Model predictions for loops 1 and 3 are shown in Figures 3 and 5. While intended to serve as only a semi-quantitative tool, the model provided a reasonable prediction of the timeframe for DCE treatment at each of the monitoring wells in these treatment loops. In addition, the model provided a reasonable prediction of the DHC concentrations in groundwater, although the elevated DHC levels at BMW-2 at 40 to 50 days after bioaugmentation are not readily explained. Most importantly, the model showed that treatment timeframes at BMW-2 and BMW-6 were similar despite a 100-fold difference in DHC bioaugmentation dosage at BMW-1 and BMW-5. The model also showed that *in situ* DHC growth in loop 3 was greater than the DHC growth in loop 1. The rapid decrease in chlorinated ethene concentrations in BMW-1, which resulted from the large DHC inoculation dosage in this well, limits the subsequent rate of DHC growth within this treatment loop. Thus, *in situ* growth in loop 3 acted to compensate for the decreased DHC

inoculation dosage, and explains why results for these two treatment loops are similar despite the 100-fold difference in bioaugmentation dosage. Thus, the model provides a reasonable explanation for the observed similarity between Loops 1 and 3. Simulation of the Loop 3 bioaugmentation dosage using the flow rate and chlorinated ethene concentrations in Loop 1 did not substantially impact the simulated remedial timeframe or DHC levels obtained for Loop 3. Thus, the similarity in the observed experimental results between Loops 1 and 3 were not due to any artifacts caused by differences in chlorinated ethene or groundwater velocity between the recirculation loops.

Both the experimental data and model simulations show that DHC concentrations at BMW-5 and BMW-6 are similar (within about an order of magnitude). This level of agreement is reasonable considering the variability associated with aqueous phase DHC sampling (Schaefer et al., 2009). The agreement between model simulations and the experimental data confirm our qualitative and quantitative interpretation of the processes controlling DHC migration and DCE dechlorination at both high and low bioaugmentation dosages.

The question then arises as to whether continuing to decrease the bioaugmentation dosage would result in any substantial increases in remedial timeframe. Performance of a simulation using a DHC inoculation of 01.-times that used in Loop 3 resulted in an additional 50 days of treatment required for DCE removal at the downgradient well (BMW-6). Thus, based on the combination of field and simulation results, the dosage used in Loop 3 appears to be near optimal for the conditions of this study, balancing the benefits of high dosage and rapid treatment near the injection well to sustained growth and detachment of DHC to facilitate treatment downgradient.

Conclusions

Results of this field demonstration were used to evaluate the impacts of DHC dosage on bioaugmentation effectiveness and rates. For the conditions of this demonstration, a 100-fold difference in bioaugmentation dosage using a commercially available DHC-containing culture did not result in an apparent difference in bioaugmentation performance, as measured at a monitoring well 10 feet downgradient of the bioaugmentation injection well. A 1-dimensional screening level model provided a reasonable prediction of the dechlorination kinetics, and was able to predict the impacts of DHC dosage on bioaugmentation performance. Thus, this type of model potentially can serve as a tool for estimating DHC dosage in some field applications. The successful application of the model to the field results also verifies that the dechlorination and microbial processes observed at the bench scale (Schaefer et al., 2009) are applicable at the field scale, at least for the conditions of our study. Low pH conditions likely were responsible for inhibition of DCE dechlorination and DHC growth and migration in loop 2.

Results of this demonstration and others show that many factors including groundwater flow velocity, contaminant concentration, groundwater chemistry, and heterogeneity of the subsurface can affect the amount of culture needed to effectively treat chlorinated solvent-contaminated aquifers. As a result, precisely determining the amount of culture needed for a given site still requires a site-by-site evaluation. Importantly, the 1-dimensional model used to predict and evaluate growth of DHC and treatment effectiveness (Schaefer et al., 2009) reasonably described the results of the demonstration. Consequently, the model appears suitable for evaluating the

affect of different DHC dosages on treatment times and effectiveness, and may serve a useful design tool for planning bioaugmentation applications. Validation of the model under a wider-range of bioaugmentation field conditions would be useful in more fully demonstrating the robustness of this model.

A significant component of its use, however, is the need to determine the attachment-detachment factor (f) which varies based on aquifer geochemistry and soil texture. Work is ongoing to allow up-front estimates of this factor based on analysis of site samples, and efforts are in progress to incorporate the 1-dimensional model into existing groundwater flow and bioremediation models to make it more accessible to remediation practitioners.

Acknowledgments

Funding for this project was attained through the U.S. DoD Environmental Security Technology Certification Program (ESTCP) project ER-0515.

References

Amos, B.K., E.J. Suchomel, K.D. Pennell, and F.E. Löffler. 2009. Spatial and temporal distributions of *Geobacter lovleyi* and *Dehalococcoides* spp. during bioenhanced PCE-DNAPL dissolution. 2009. *Environmental Science & Technology*, no. 43: 1977-1985.

Environmental Security Technology Certification Program (ESTCP). 2005. Bioaugmentation for remediation of chlorinated solvents: technology development, status, and research needs.

<http://docs.serdp-estcp.org/viewfile.cfm?Doc=BioaugmentationWhitePaper.pdf>

ITRC (Interstate Technology & Regulatory Council). 2005. Overview of in situ bioremediation of chlorinated ethene DNAPL source zones. BioDNAPL-1. Washington, D.C.

ITRC (Interstate Technology & Regulatory Council). 2007. In situ bioremediation of chlorinated ethene DNAPL source zones: case studies. BioDNAPL-2. Washington, D.C.

Lu, X., J.T. Wilson, and D.H. Campbell. 2006. Relationship between *Dehalococcoides* DNA in groundwater and rates of reductive dechlorination at field scale. *Water Research*, no. 40: 3131-3140.

Maymó-Gatell, X., Y. Chien, J.M. Gossett, and S.H. Zinder. 1997. Isolation of a bacterium that reductively dechlorinates tetrachloroethene to ethene. *Science*, no. 276: 1568-1571.

Schaefer, C.E., C.W. Condee, S. Vainberg, and R.J. Steffan. 2009. Bioaugmentation for chlorinated ethenes using *Dehalococcoides* sp.: comparison between batch and column experiments. *Chemosphere*, no. 75: 141-148.

United States Environmental Protection Agency (USEPA). 2004. Demonstration of bioaugmentation of DNAPL through biostimulation and bioaugmentation at Launch Complex 34 Cape Canaveral Air Force station, Florida. EPA/540/R-07/007.

United States Environmental Protection Agency (USEPA). 1996. Soil Screening Guidance: User's Guide. Publication 9355.4-23.

Vainberg, S., C.W. Condee, and R.J. Steffan. 2009. Large-scale production of bacterial consortia for remediation of chlorinated solvent-contaminated groundwater. *Journal of Industrial Microbiology and Biotechnology*

Tables

Table 1. Well construction details.

Well ID	Ground Surface Elevation (feet MSL)	Top of Casing Elevation (feet MSL)	Well Diameter (inches)	Depth to Top of Screen (feet bgs)	Depth to Bottom of Screen (feet bgs)	Screen Length (feet)	Top of Screen Elevation (feet MSL)	Bottom of Screen Elevation (feet MSL)
Injection Wells								
IW-1	109.27	111.44	6.0	8.0	18.0	10.0	101.3	91.3
IW-2	110.93	113.54	6.0	9.5	19.5	10.0	101.4	91.4
IW-3	112.38	115.28	6.0	11.5	21.5	10.0	100.9	90.9
IW-4	114.87	118.70	6.0	13.5	23.5	10.0	101.4	91.4
Extraction Wells								
EX-1	110.15	113.85	6.0	8.5	18.5	10.0	101.7	91.7
EX-2	111.90	115.06	6.0	10.5	20.5	10.0	101.4	91.4
EX-3	113.46	116.54	6.0	12.0	22.0	10.0	101.5	91.5
EX-4	116.25	118.91	6.0	15.0	25.0	10.0	101.3	91.3
Monitoring Wells								
BMW-1	109.76	112.10	2.0	8.0	18.0	10.0	101.8	91.8
BMW-2	110.10	112.44	2.0	8.5	18.5	10.0	101.6	91.6
BMW-3	111.43	111.14	2.0	10.0	20.0	10.0	101.4	91.4
BMW-4	110.70	111.28	2.0	10.5	20.5	10.0	100.2	90.2
BMW-5	112.98	115.38	2.0	11.5	21.5	10.0	101.5	91.5
BMW-6	113.25	112.88	2.0	11.5	21.5	10.0	101.8	91.8
BMW-7	115.50	117.77	2.0	14.0	24.0	10.0	101.5	91.5
BMW-8	116.31	118.31	2.0	14.5	24.5	10.0	101.8	91.8
BMW-9	109.66	111.96	2.0	8.0	18.0	10.0	101.7	91.7
BMW-10	109.24	111.72	2.0	8.0	18.0	10.0	101.2	91.2
BMW-11	110.27	109.92	2.0	9.0	19.0	10.0	101.3	91.3

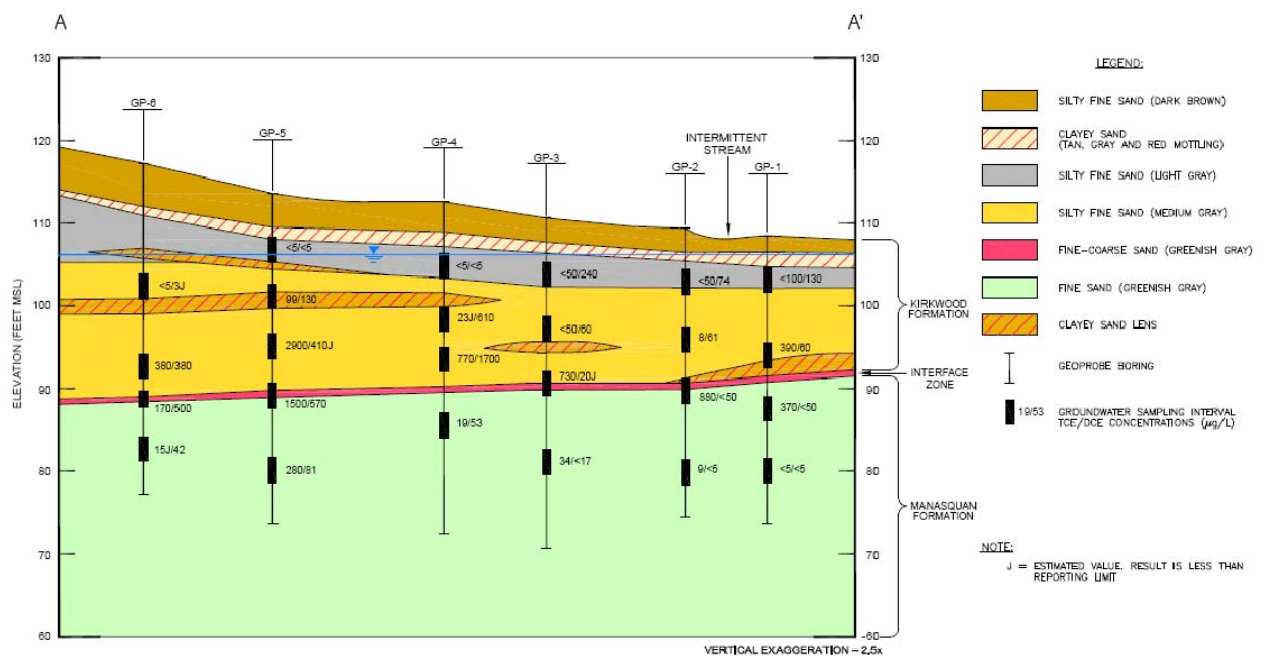
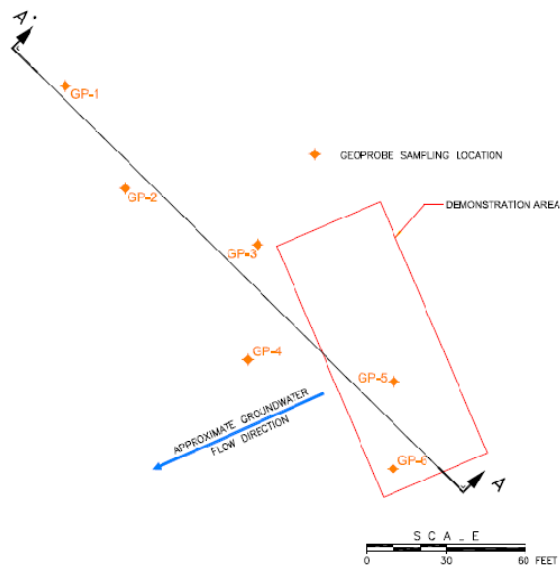

Figure 1. Demonstration area geologic cross-section and contaminant distribution.

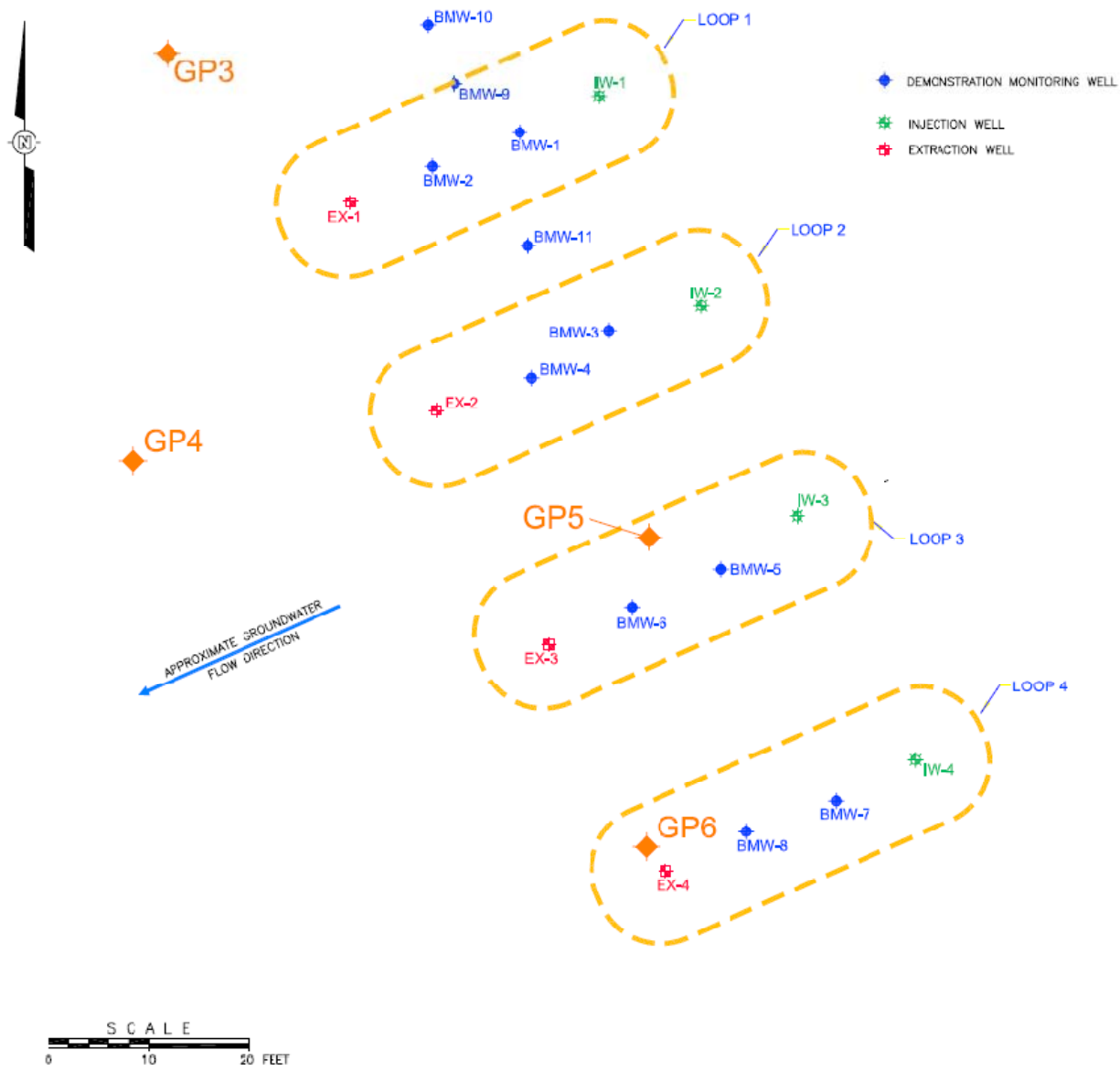

Figure 2. Demonstration layout.

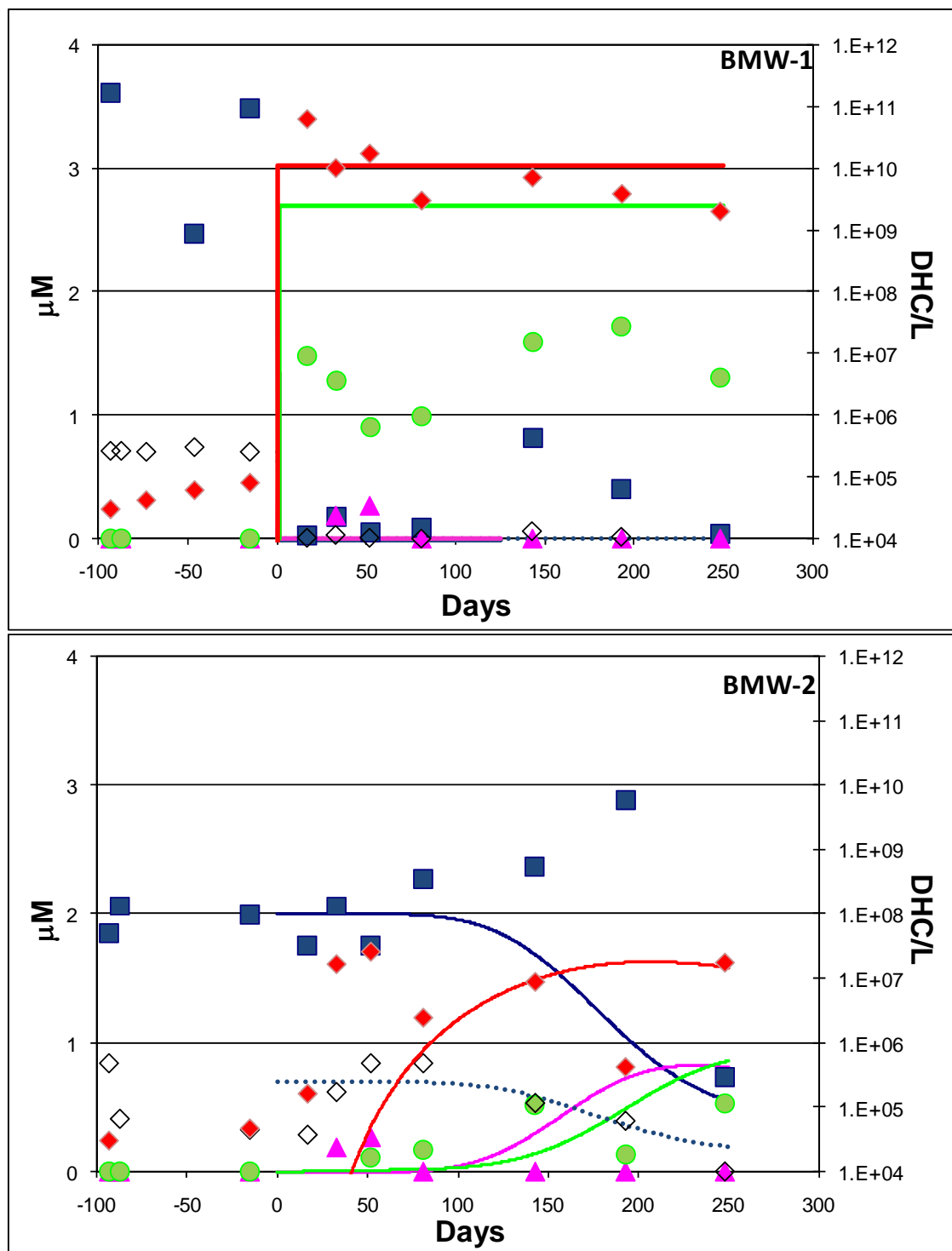

Figure 3. Ethenes and DHC concentrations plotted as a function of time for loop 1. Bioaugmentation was performed at 0 days. \diamond - TCE, \blacksquare - DCE, \blacktriangle - vinyl chloride, \bullet - ethene, \blacklozenge - DHC. Solid and dotted lines represent corresponding model simulations. Simulated DHC concentrations in the bioaugmentation injection well (BMW-1) includes the total (mobile and immobile) DHC.

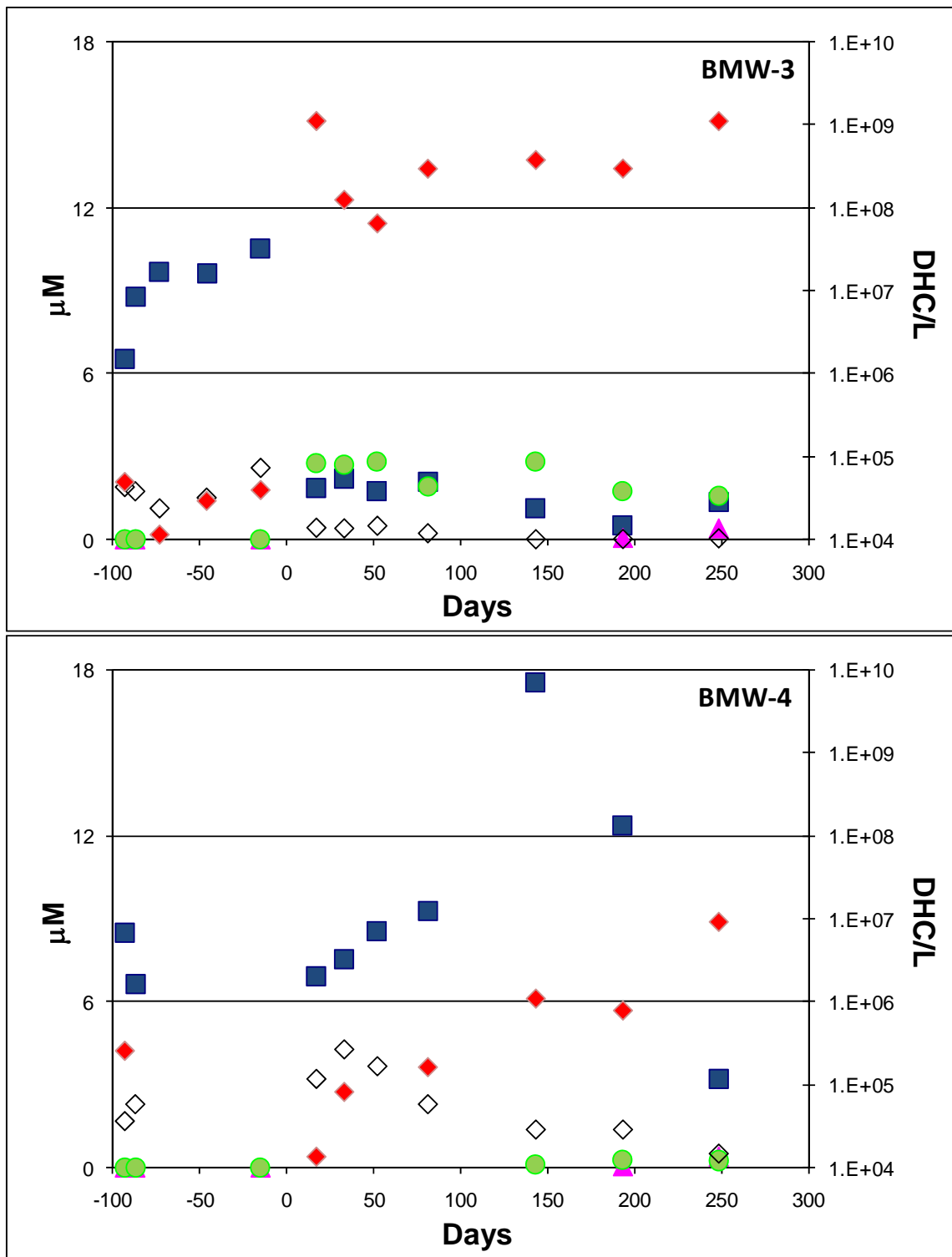

Figure 4. Ethenes and DHC concentrations plotted as a function of time for loop 2. Bioaugmentation was performed at 0 days. \diamond - TCE, \blacksquare - DCE, \blacktriangle - vinyl chloride, \bullet - ethene, \blacklozenge - DHC.

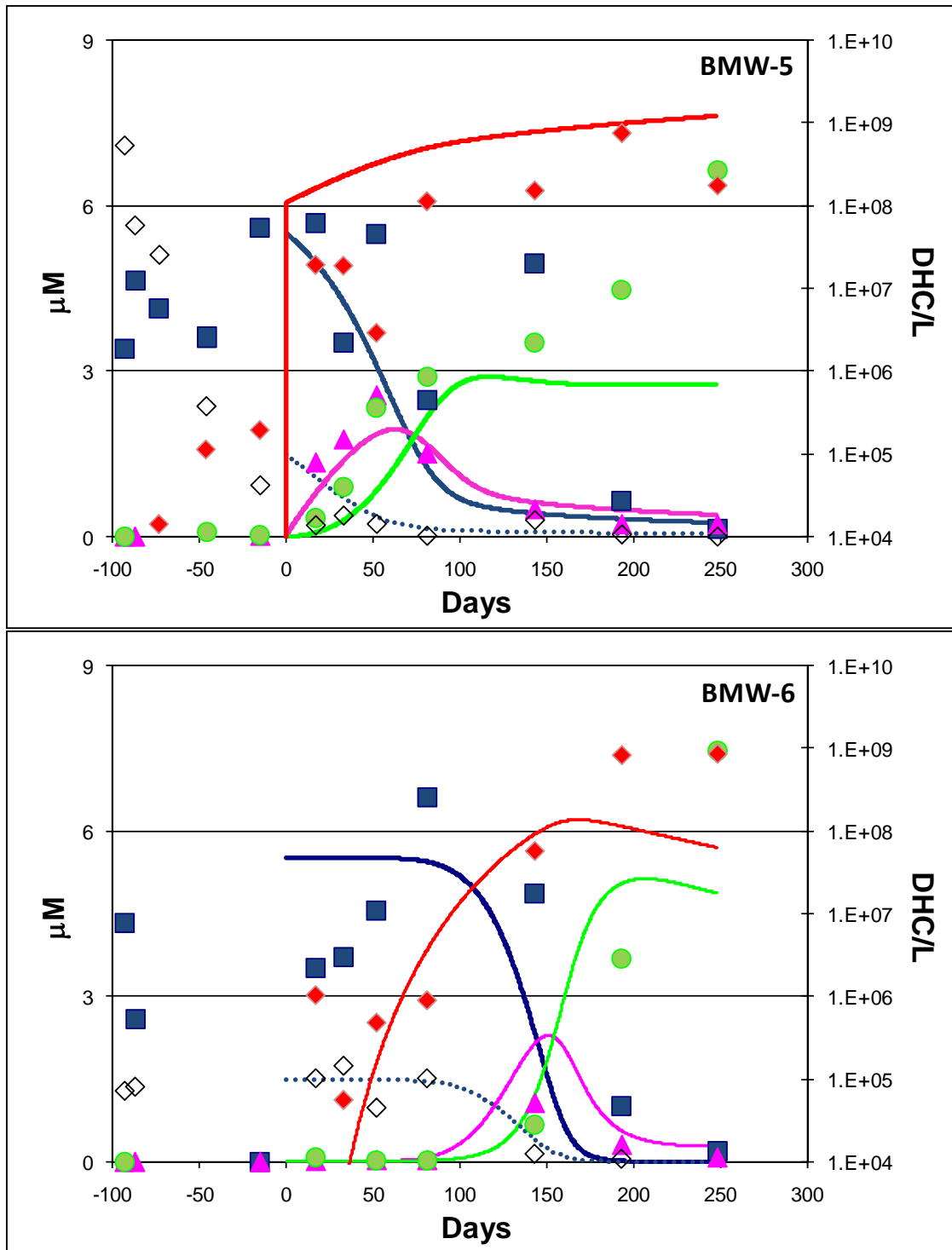

Figure 5. Ethenes and DHC concentrations plotted as a function of time for loop 3. Bioaugmentation was performed at 0 days. \diamond - TCE, \blacksquare - DCE, \blacktriangle - vinyl chloride, \bullet - ethene, \blacklozenge - DHC. Solid and dotted lines represent corresponding model simulations. Simulated DHC concentrations in the bioaugmentation injection well (BMW-5) includes the total (mobile and immobile) DHC.

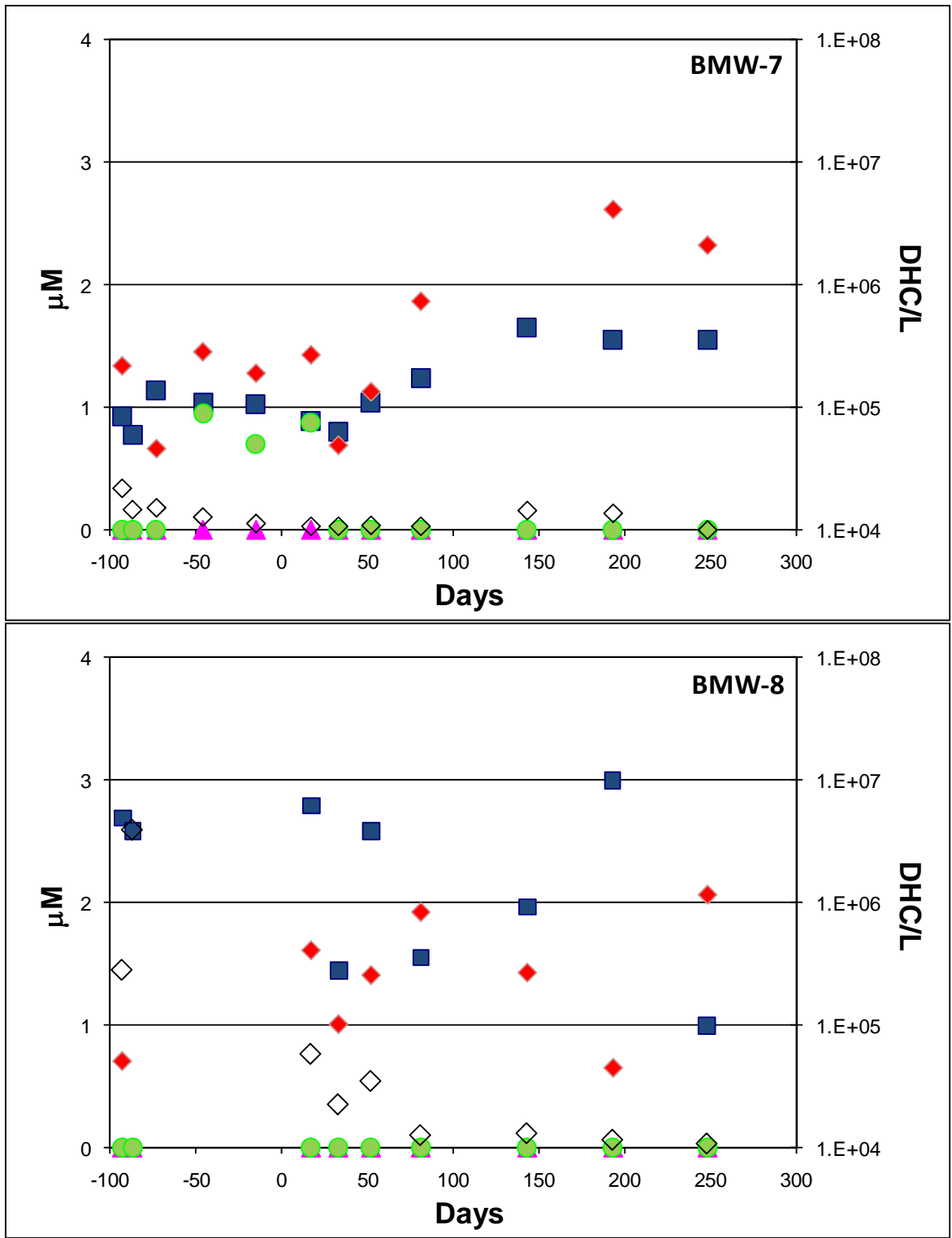

Figure 6. Ethenes and DHC concentrations plotted as a function of time for loop 4 (control loop). Bioaugmentation was performed at 0 days. \diamond - TCE, \blacksquare - DCE, \blacktriangle - vinyl chloride, \bullet - ethene, \blacklozenge - DHC. No detections of vinyl chloride or ethene were observed.

Supplemental Materials

DHC growth and migration (based on Schaefer et al., 2009)

$$\frac{dX_{im}}{dt} = fYX_{im} \left[\frac{q_{TCE}C_{TCE}}{C_{TCE} + K_{TCE}} + \frac{q_{DCE}C_{DCE}}{C_{DCE} + K_{DCE} \left(1 + \frac{C_{TCE}}{I_{TCE}} \right)} + \frac{q_{VC}C_{VC}}{C_{VC} + K_{VC} \left(1 + \frac{C_{TCE}}{I_{TCE}} + \frac{C_{DCE}}{I_{DCE}} \right)} \right]$$

$$\frac{dX_m}{dt} = (1-f)f^{-1} \frac{dX_{im}}{dt} + YX_m \left[\frac{q_{TCE}C_{TCE}}{C_{TCE} + K_{TCE}} + \frac{q_{DCE}C_{DCE}}{C_{DCE} + K_{DCE} \left(1 + \frac{C_{TCE}}{I_{TCE}} \right)} + \frac{q_{VC}C_{VC}}{C_{VC} + K_{VC} \left(1 + \frac{C_{TCE}}{I_{TCE}} + \frac{C_{DCE}}{I_{DCE}} \right)} \right] + D \frac{\partial^2 X_m}{\partial x^2} - v \frac{\partial X_m}{\partial x}$$

where C_i is the aqueous concentration of compound i (where i is either TCE, DCE, or VC) [mM]; t is time [h], K_i is the half velocity coefficient of compound i [mM], I_i is the competition coefficient of compound i [mM], q_i is the DHC maximum utilization rate coefficient for compound i [mmol Cl^- (cell h) $^{-1}$], X_m and X_{im} are the mobile and immobile DHC (respectively), D is the dispersion coefficient [cm 2 h $^{-1}$], v is the groundwater velocity [cm h $^{-1}$], x is the distance from the DHC injection point [cm], and f is the fraction of DHC that grows and remains immobilized; $(1-f)$ represents the fraction that detaches and migrates (without re-attachment) through the aquifer. It is assumed that electron donor is present in excess, and that microbial decay is negligible during implementation of bioaugmentation in our study. For mobile DHC growth and migration beyond $x = 30$ cm, Eq. 7 is used with omission of the first term on the right-hand side of the equation because X_{im} is assumed equal to zero beyond $x = 30$ cm. The above equations are coupled with the 1-dimensional advection-dispersion equation, along with the Monod kinetic expression for each chlorinated ethene, to describe contaminant fate and transport in the aquifer.

Bromide Tracer Results for BMW-1

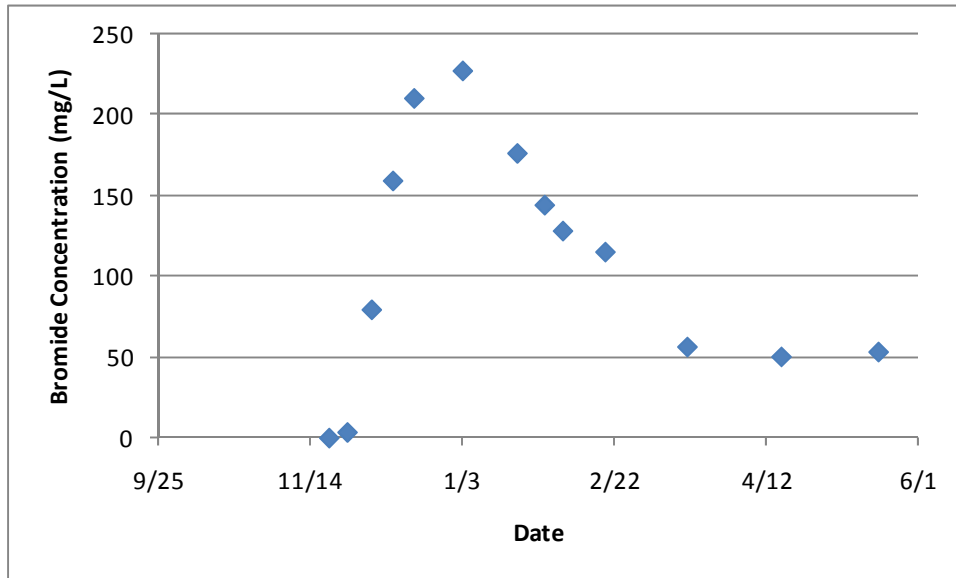

APPENDIX F
Slug Testing and Pump Testing Analysis

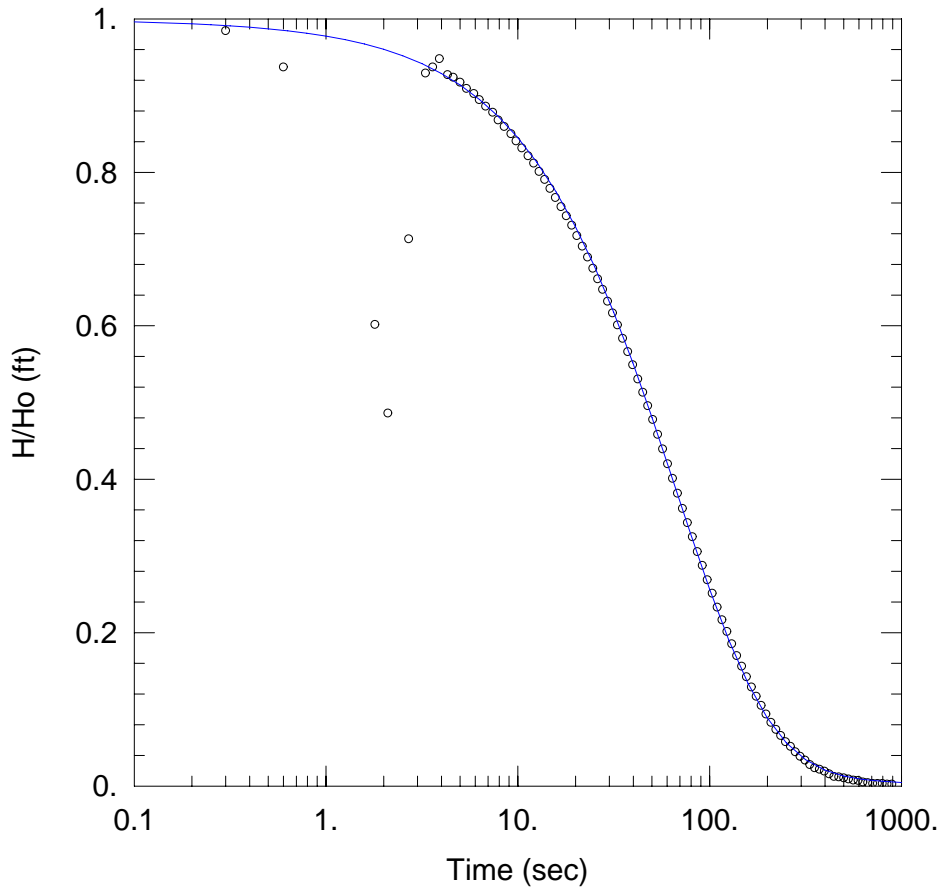

PZ-1 FALLING HEAD TEST

Data Set: N:\Projects Active\Ft DIX\Slug Tests\PZ-1FHT.aqt
 Date: 04/11/07 Time: 10:48:17

PROJECT INFORMATION

Company: Ft Dix
 Test Well: PZ-1

AQUIFER DATA

Saturated Thickness: 15. ft

WELL DATA (PZ-1)

Initial Displacement: <u>2.68 ft</u>	Casing Radius: <u>0.083 ft</u>
Wellbore Radius: <u>0.25 ft</u>	Well Skin Radius: <u>0.25 ft</u>
Screen Length: <u>5. ft</u>	Total Well Penetration Depth: <u>10.39 ft</u>
Gravel Pack Porosity: <u>0.35</u>	

SOLUTION

Aquifer Model: <u>Confined</u>	Solution Method: <u>KGS Model</u>
Kr = <u>2.37 ft/day</u>	Ss = <u>9.943E-06 ft⁻¹</u>
Kz/Kr = <u>1.</u>	

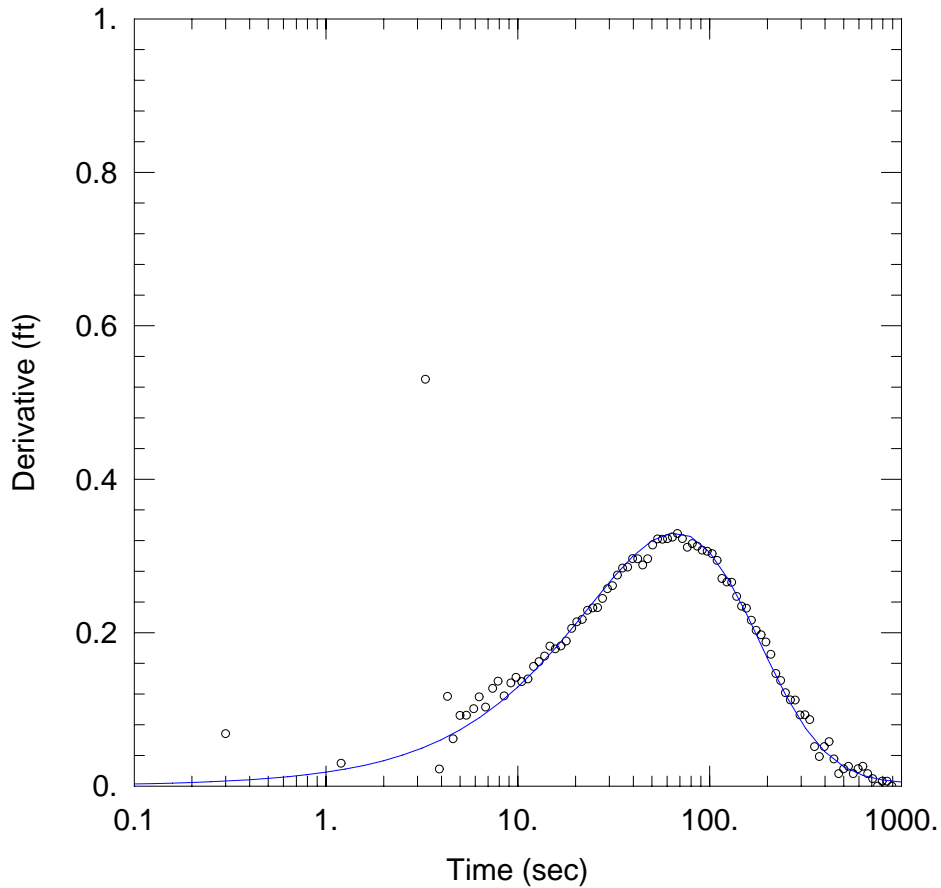

PZ-1 FALLING HEAD TEST

Data Set: N:\Projects Active\Ft DIX\Slug Tests\PZ-1FHT.aqt

Date: 04/11/07

Time: 10:48:52

PROJECT INFORMATION

Company: Ft Dix

Test Well: PZ-1

AQUIFER DATA

Saturated Thickness: 15. ft

WELL DATA (PZ-1)

Initial Displacement: 2.68 ft

Wellbore Radius: 0.25 ft

Screen Length: 5. ft

Gravel Pack Porosity: 0.35

Casing Radius: 0.083 ft

Well Skin Radius: 0.25 ft

Total Well Penetration Depth: 10.39 ft

SOLUTION

Aquifer Model: Confined

Solution Method: KGS Model

Kr = 2.37 ft/day

Ss = 9.943E-06 ft⁻¹

Kz/Kr = 1.

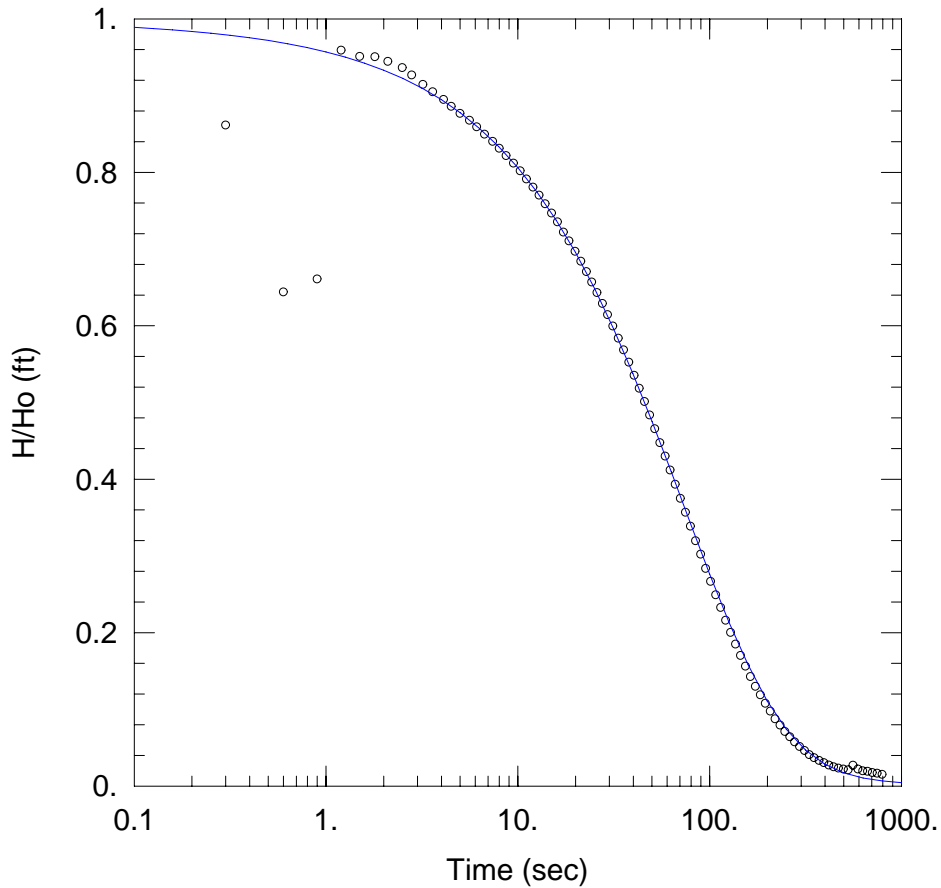

PZ-1 RISING HEAD TEST

Data Set: N:\Projects Active\Ft DIX\Slug Tests\PZ-1RHT.aqt
 Date: 04/11/07 Time: 10:47:15

PROJECT INFORMATION

Company: Ft Dix
 Test Well: PZ-1

AQUIFER DATA

Saturated Thickness: 50. ft

WELL DATA (PZ-1)

Initial Displacement: <u>3.02 ft</u>	Casing Radius: <u>0.083 ft</u>
Wellbore Radius: <u>0.25 ft</u>	Well Skin Radius: <u>0.25 ft</u>
Screen Length: <u>5. ft</u>	Total Well Penetration Depth: <u>10.39 ft</u>
Gravel Pack Porosity: <u>0.35</u>	

SOLUTION

Aquifer Model: <u>Confined</u>	Solution Method: <u>KGS Model</u>
Kr = <u>1.791 ft/day</u>	Ss = <u>0.0002566 ft⁻¹</u>
Kz/Kr = <u>1.</u>	

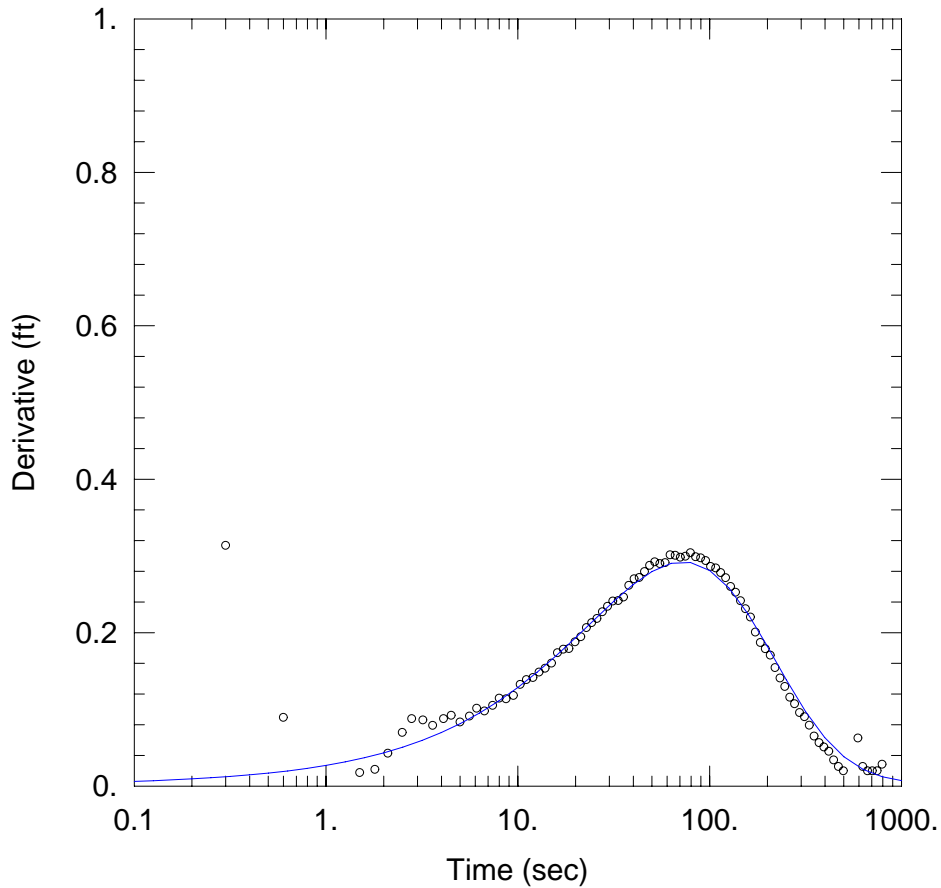

PZ-1 RISING HEAD TEST

Data Set: N:\Projects Active\Ft DIX\Slug Tests\PZ-1RHT.aqt
 Date: 04/11/07 Time: 10:47:55

PROJECT INFORMATION

Company: Ft Dix
 Test Well: PZ-1

AQUIFER DATA

Saturated Thickness: 50. ft

WELL DATA (PZ-1)

Initial Displacement: <u>3.02 ft</u>	Casing Radius: <u>0.083 ft</u>
Wellbore Radius: <u>0.25 ft</u>	Well Skin Radius: <u>0.25 ft</u>
Screen Length: <u>5. ft</u>	Total Well Penetration Depth: <u>10.39 ft</u>
Gravel Pack Porosity: <u>0.35</u>	

SOLUTION

Aquifer Model: <u>Confined</u>	Solution Method: <u>KGS Model</u>
Kr = <u>1.791 ft/day</u>	Ss = <u>0.0002566 ft⁻¹</u>
Kz/Kr = <u>1.</u>	

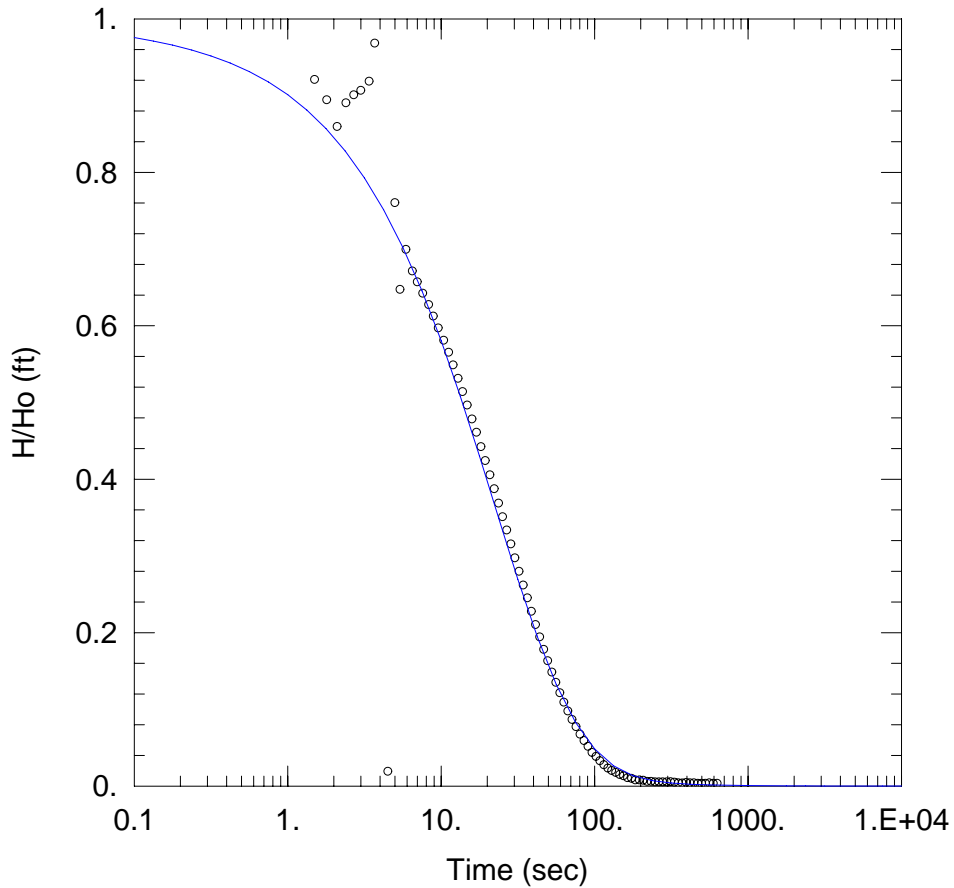

PZ-2 FALLING HEAD TEST

Data Set: N:\Projects Active\Ft DIX\Slug Tests\PZ-2FHT.aqt
 Date: 04/11/07 Time: 10:44:27

PROJECT INFORMATION

Company: Ft Dix
 Test Well: PZ-2

AQUIFER DATA

Saturated Thickness: 50. ft

WELL DATA (PZ-2)

Initial Displacement: <u>2.76 ft</u>	Casing Radius: <u>0.083 ft</u>
Wellbore Radius: <u>0.25 ft</u>	Well Skin Radius: <u>0.25 ft</u>
Screen Length: <u>5. ft</u>	Total Well Penetration Depth: <u>20.97 ft</u>
Gravel Pack Porosity: <u>0.35</u>	

SOLUTION

Aquifer Model: <u>Confined</u>	Solution Method: <u>KGS Model</u>
Kr = <u>5.609 ft/day</u>	Ss = <u>0.0003623 ft⁻¹</u>
Kz/Kr = <u>1.</u>	

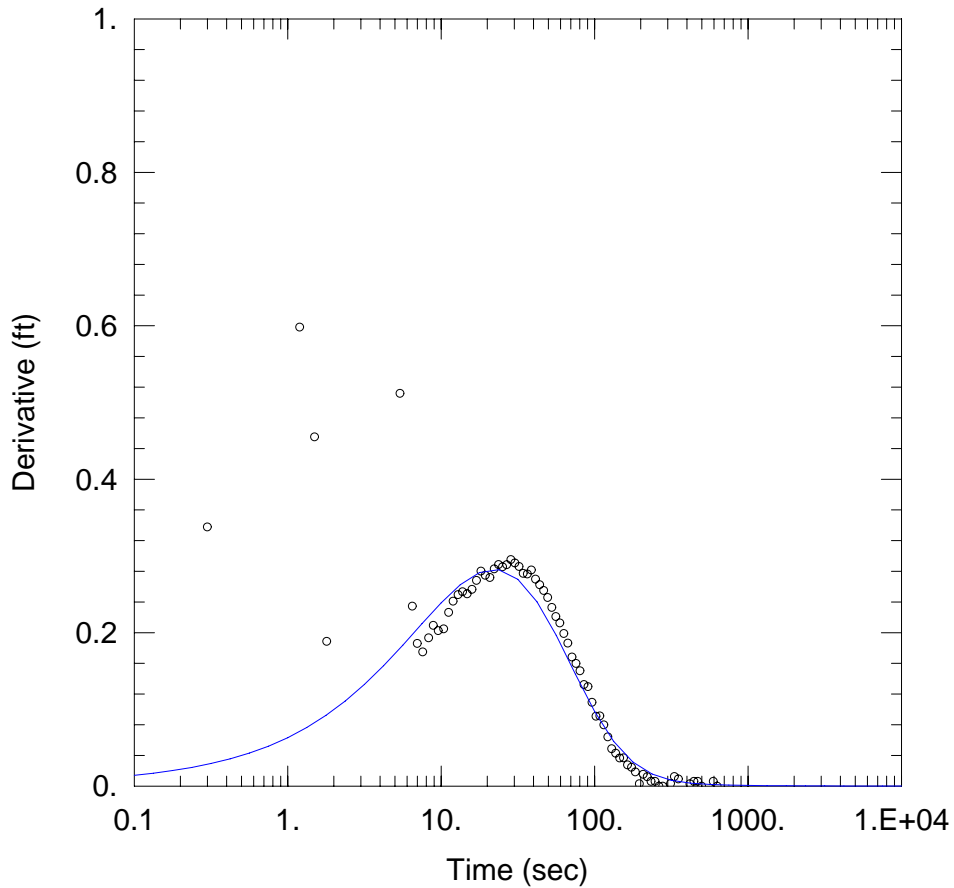

PZ-2 FALLING HEAD TEST

Data Set: N:\Projects Active\Ft DIX\Slug Tests\PZ-2FHT.aqt
 Date: 04/11/07 Time: 10:46:49

PROJECT INFORMATION

Company: Ft Dix
 Test Well: PZ-2

AQUIFER DATA

Saturated Thickness: 50. ft

WELL DATA (PZ-2)

Initial Displacement: <u>2.76 ft</u>	Casing Radius: <u>0.083 ft</u>
Wellbore Radius: <u>0.25 ft</u>	Well Skin Radius: <u>0.25 ft</u>
Screen Length: <u>5. ft</u>	Total Well Penetration Depth: <u>20.97 ft</u>
Gravel Pack Porosity: <u>0.35</u>	

SOLUTION

Aquifer Model: <u>Confined</u>	Solution Method: <u>KGS Model</u>
Kr = <u>5.609 ft/day</u>	Ss = <u>0.0003623 ft⁻¹</u>
Kz/Kr = <u>1.</u>	

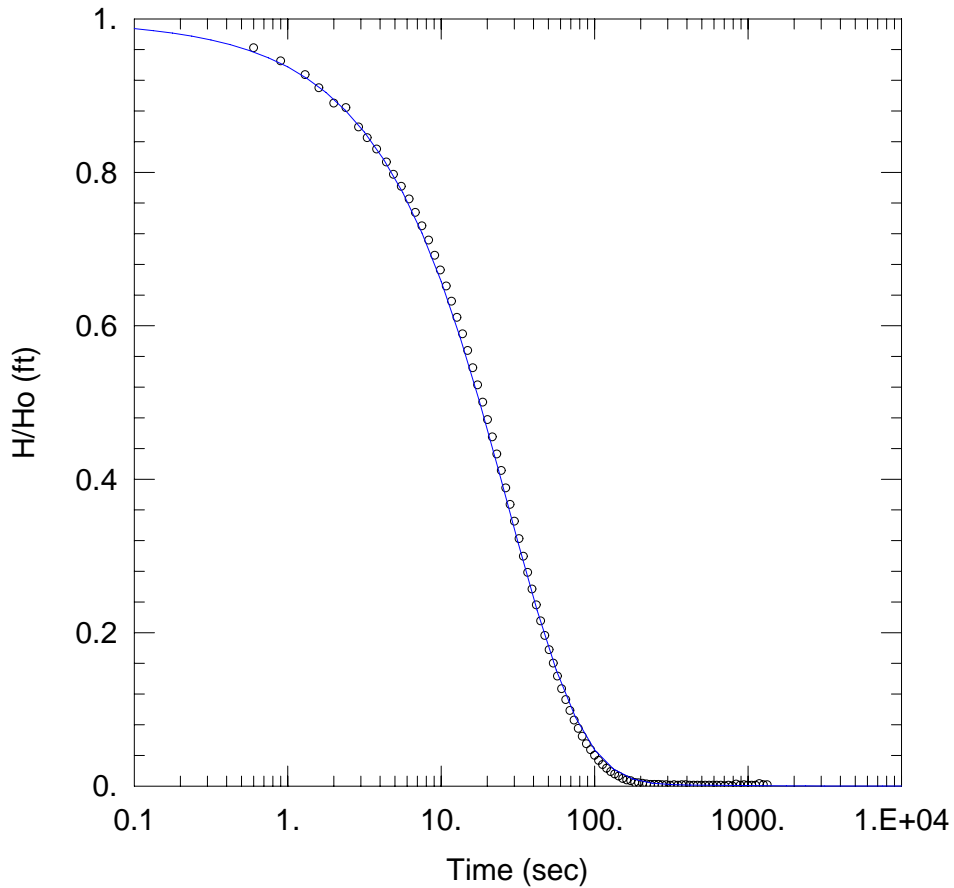

PZ-2 RISING HEAD TEST

Data Set: N:\Projects Active\Ft DIX\Slug Tests\PZ-2RHT.aqt
 Date: 04/11/07 Time: 10:45:09

PROJECT INFORMATION

Company: Ft Dix
 Test Well: PZ-2

AQUIFER DATA

Saturated Thickness: 50. ft

WELL DATA (PZ-2)

Initial Displacement: <u>2.74 ft</u>	Casing Radius: <u>0.083 ft</u>
Wellbore Radius: <u>0.25 ft</u>	Well Skin Radius: <u>0.25 ft</u>
Screen Length: <u>5. ft</u>	Total Well Penetration Depth: <u>20.97 ft</u>
Gravel Pack Porosity: <u>0.35</u>	

SOLUTION

Aquifer Model: <u>Confined</u>	Solution Method: <u>KGS Model</u>
Kr = <u>5.402 ft/day</u>	Ss = <u>6.782E-05 ft⁻¹</u>
Kz/Kr = <u>1.</u>	

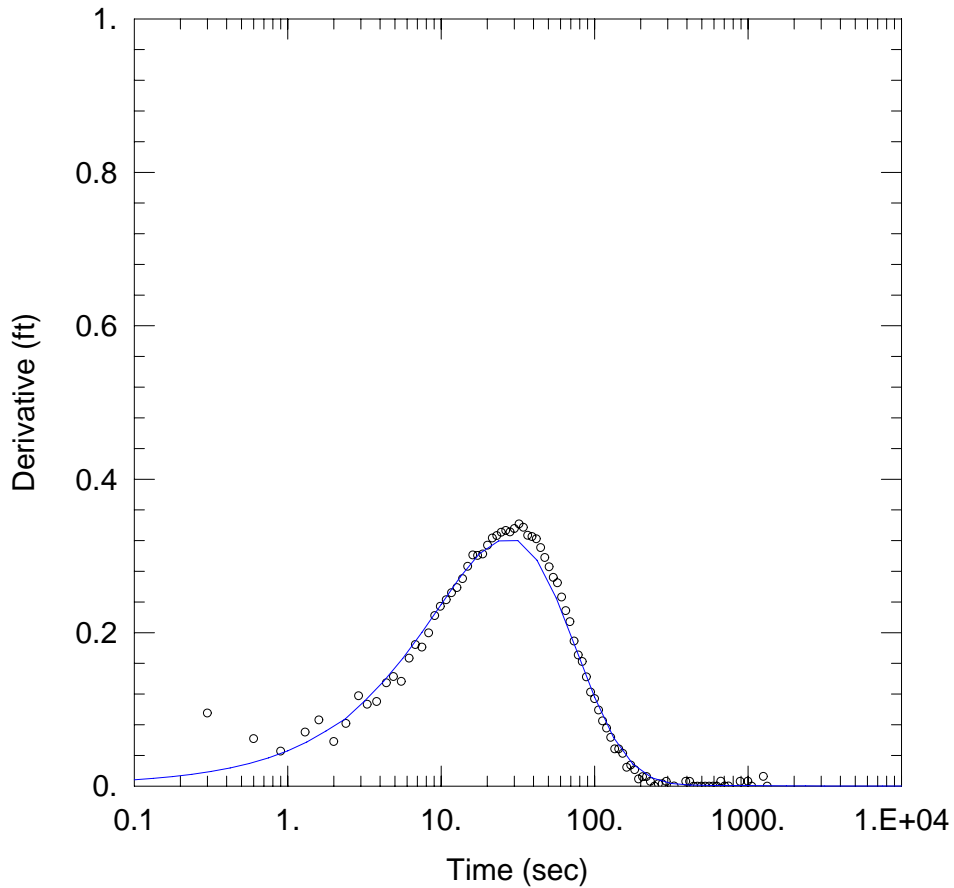

PZ-2 RISING HEAD TEST

Data Set: N:\Projects Active\Ft DIX\Slug Tests\PZ-2RHT.aqt
 Date: 04/11/07 Time: 10:45:58

PROJECT INFORMATION

Company: Ft Dix
 Test Well: PZ-2

AQUIFER DATA

Saturated Thickness: 50. ft

WELL DATA (PZ-2)

Initial Displacement: <u>2.74 ft</u>	Casing Radius: <u>0.083 ft</u>
Wellbore Radius: <u>0.25 ft</u>	Well Skin Radius: <u>0.25 ft</u>
Screen Length: <u>5. ft</u>	Total Well Penetration Depth: <u>20.97 ft</u>
Gravel Pack Porosity: <u>0.35</u>	

SOLUTION

Aquifer Model: <u>Confined</u>	Solution Method: <u>KGS Model</u>
Kr = <u>5.402 ft/day</u>	Ss = <u>6.782E-05 ft⁻¹</u>
Kz/Kr = <u>1.</u>	

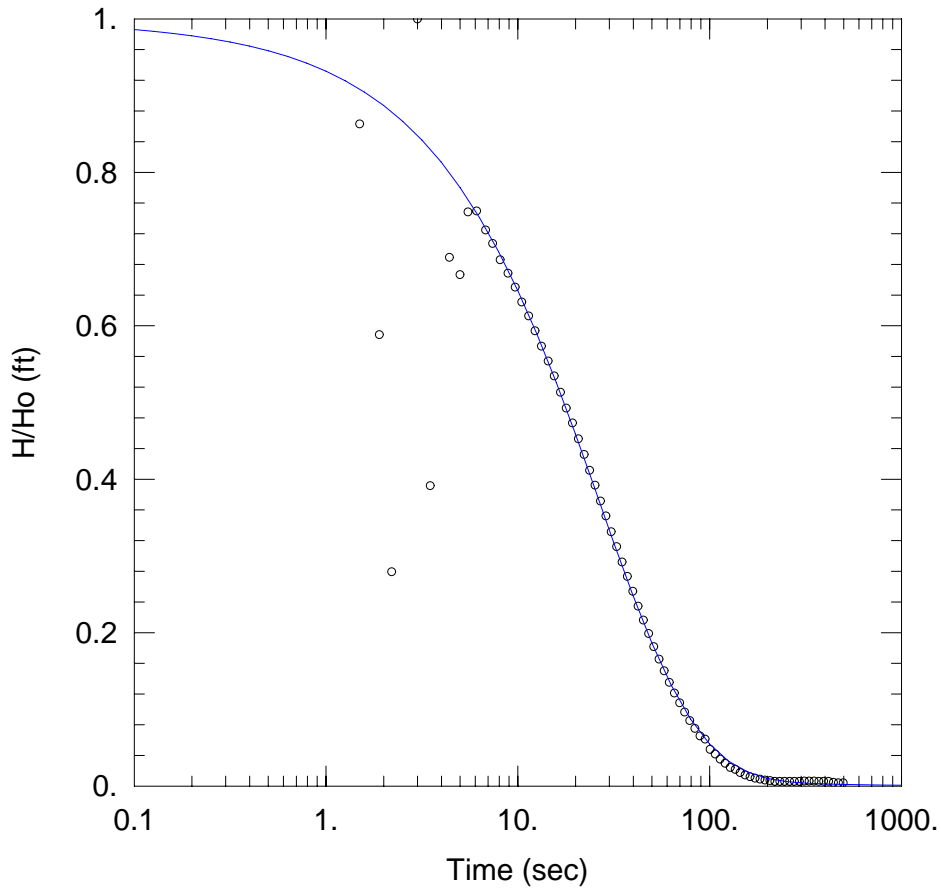

MAG-66 FALLING HEAD TEST

Data Set: N:\Projects Active\Ft DIX\Slug Tests\66FHT.aqt

Date: 04/11/07

Time: 11:08:54

PROJECT INFORMATION

Company: Ft Dix

Test Well: MAG-66

AQUIFER DATA

Saturated Thickness: 50. ft

WELL DATA (MAG-66)

Initial Displacement: 1.65 ft

Casing Radius: 0.083 ft

Wellbore Radius: 0.25 ft

Well Skin Radius: 0.25 ft

Screen Length: 10. ft

Total Well Penetration Depth: 37.09 ft

Gravel Pack Porosity: 0.35

SOLUTION

Aquifer Model: Confined

Solution Method: KGS Model

Kr = 3.173 ft/day

Ss = 3.486E-05 ft⁻¹

Kz/Kr = 1.

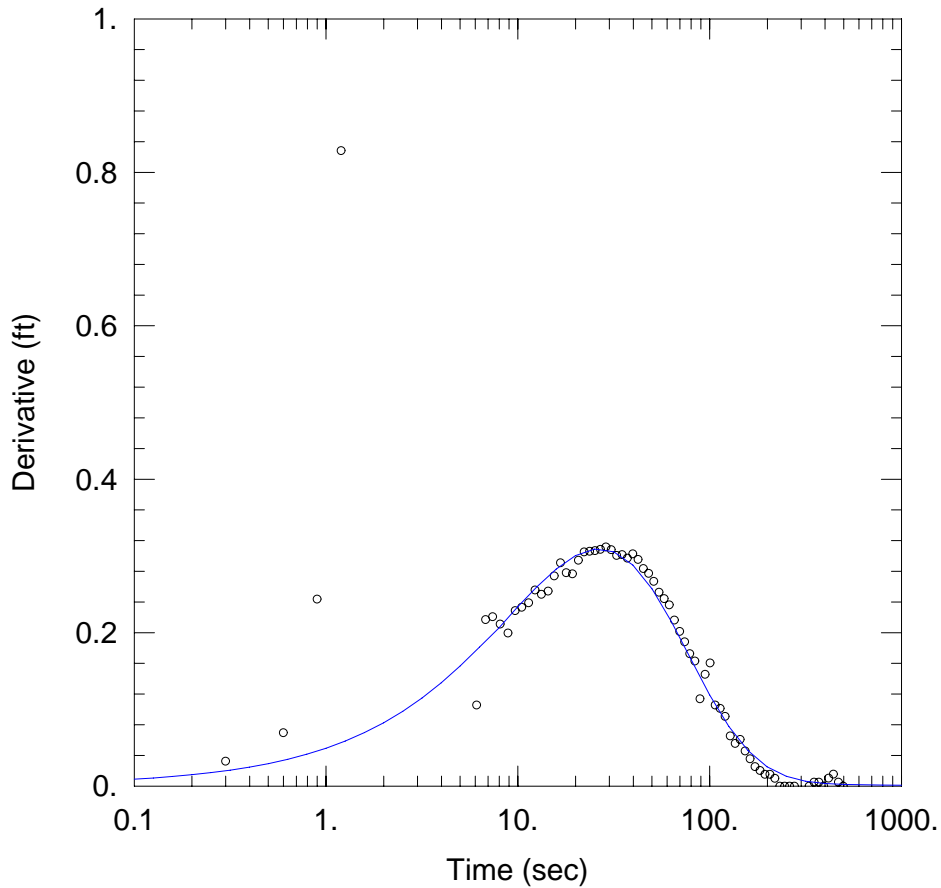

MAG-66 FALLING HEAD TEST

Data Set: N:\Projects Active\Ft DIX\Slug Tests\66FHT.aqt

Date: 04/11/07

Time: 11:09:45

PROJECT INFORMATION

Company: Ft Dix

Test Well: MAG-66

AQUIFER DATA

Saturated Thickness: 50. ft

WELL DATA (MAG-66)

Initial Displacement: 1.65 ft

Wellbore Radius: 0.25 ft

Screen Length: 10. ft

Gravel Pack Porosity: 0.35

Casing Radius: 0.083 ft

Well Skin Radius: 0.25 ft

Total Well Penetration Depth: 37.09 ft

SOLUTION

Aquifer Model: Confined

Solution Method: KGS Model

Kr = 3.173 ft/day

Kz/Kr = 1.

Ss = 3.486E-05 ft⁻¹

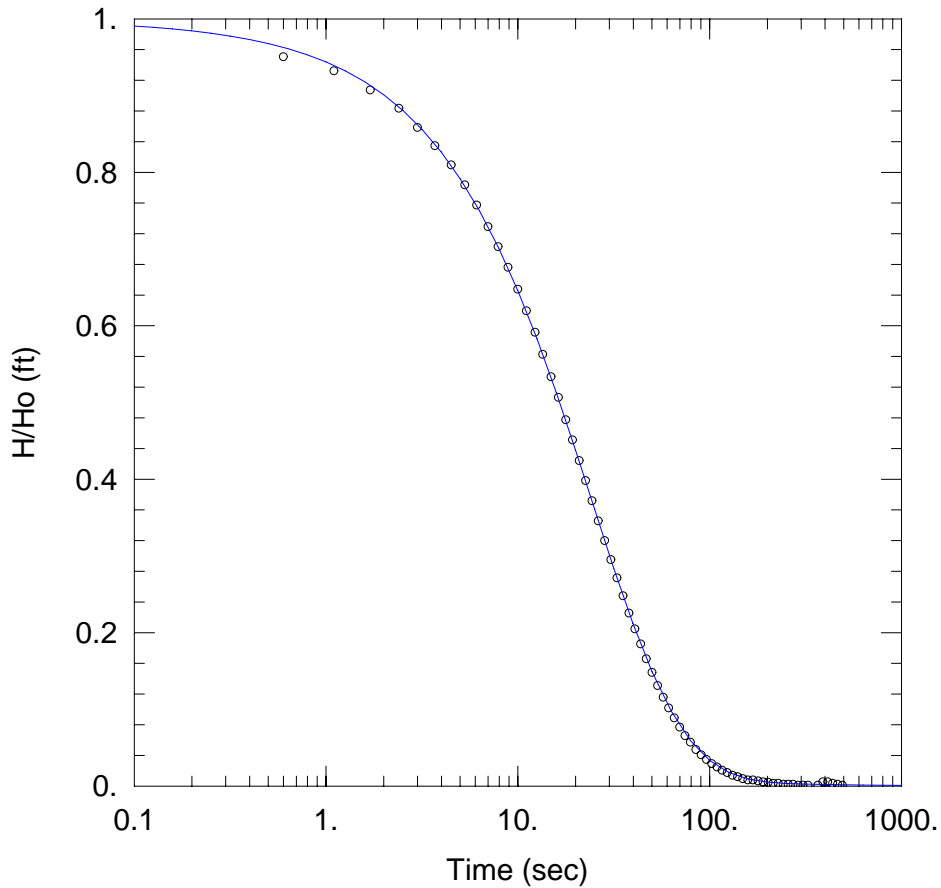

MAG-66 RISING HEAD TEST

Data Set: N:\Projects Active\Ft DIX\Slug Tests\66RHT.aqt

Date: 04/11/07

Time: 11:07:23

PROJECT INFORMATION

Company: Ft Dix

Test Well: MAG-66

AQUIFER DATA

Saturated Thickness: 50. ft

WELL DATA (MAG-66)

Initial Displacement: 1.64 ft

Casing Radius: 0.083 ft

Wellbore Radius: 0.25 ft

Well Skin Radius: 0.25 ft

Screen Length: 10. ft

Total Well Penetration Depth: 37.09 ft

Gravel Pack Porosity: 0.35

SOLUTION

Aquifer Model: Confined

Solution Method: KGS Model

Kr = 3.867 ft/day

Ss = 5.652E-06 ft⁻¹

Kz/Kr = 1.

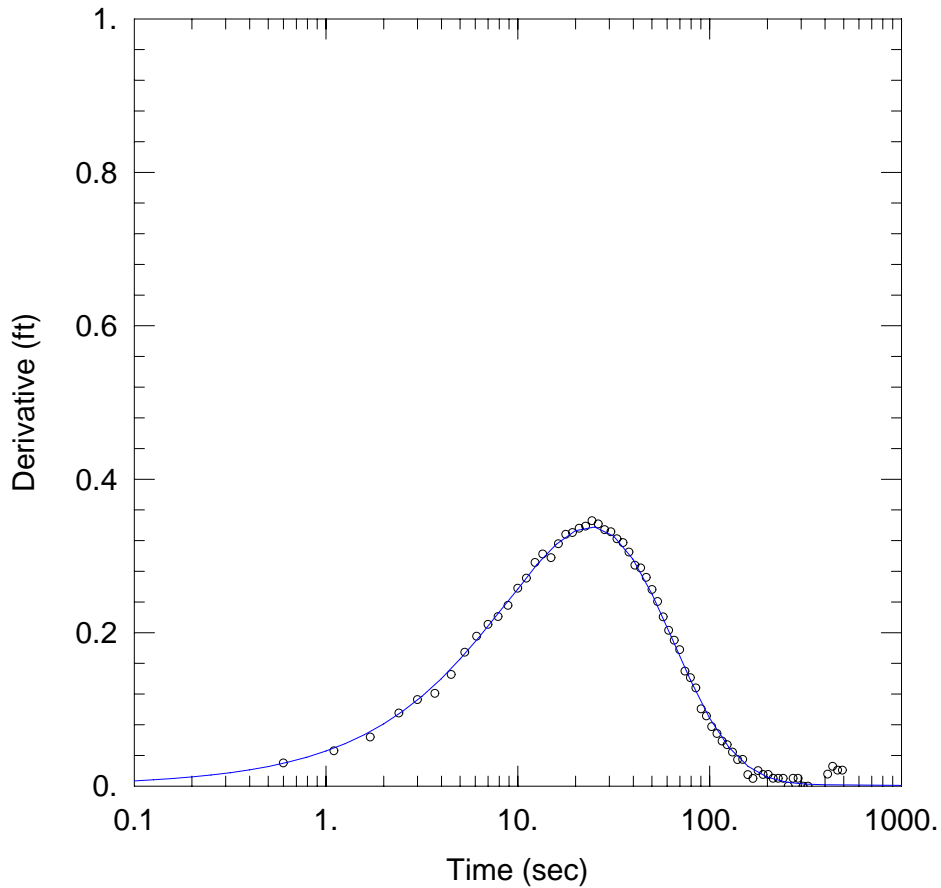

MAG-66 RISING HEAD TEST

Data Set: N:\Projects Active\Ft DIX\Slug Tests\66RHT.aqt

Date: 04/11/07

Time: 11:08:27

PROJECT INFORMATION

Company: Ft Dix

Test Well: MAG-66

AQUIFER DATA

Saturated Thickness: 50. ft

WELL DATA (MAG-66)

Initial Displacement: 1.64 ft

Wellbore Radius: 0.25 ft

Screen Length: 10. ft

Gravel Pack Porosity: 0.35

Casing Radius: 0.083 ft

Well Skin Radius: 0.25 ft

Total Well Penetration Depth: 37.09 ft

SOLUTION

Aquifer Model: Confined

Solution Method: KGS Model

Kr = 3.867 ft/day

Ss = 5.652E-06 ft⁻¹

Kz/Kr = 1.

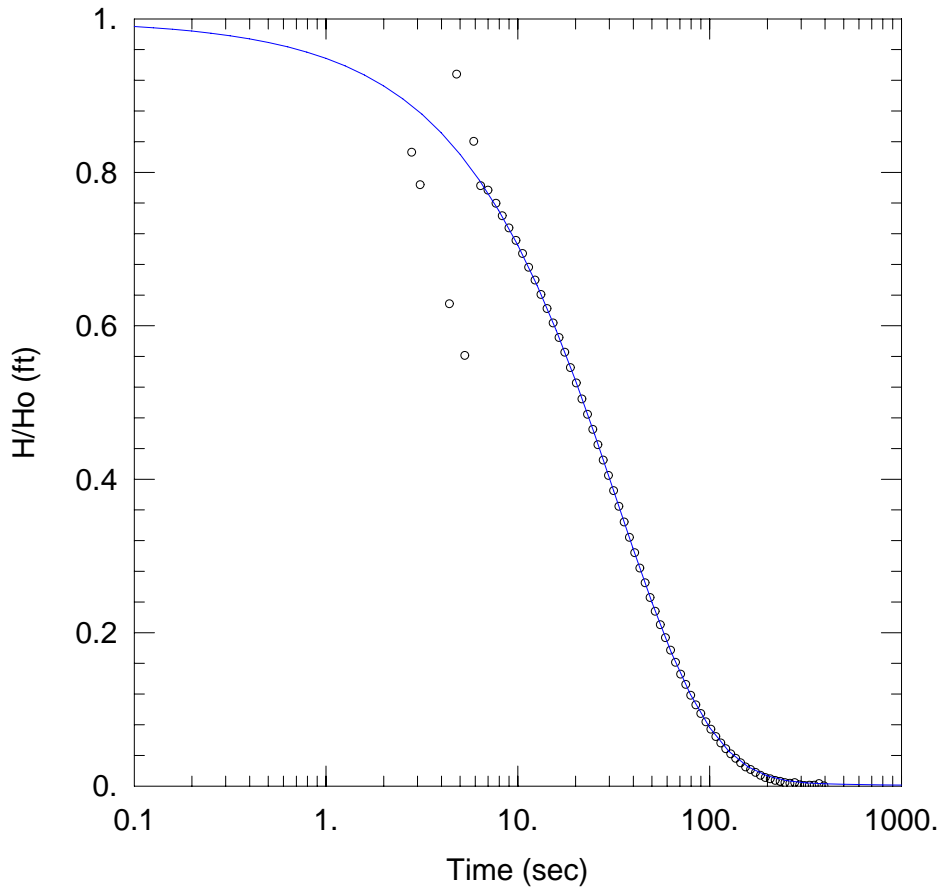

MAG-112P FALLING HEAD TEST

Data Set: N:\Projects Active\Ft DIX\Slug Tests\112pFHT.aqt

Date: 04/11/07

Time: 11:05:21

PROJECT INFORMATION

Company: Ft Dix

Test Well: MAG-112P

AQUIFER DATA

Saturated Thickness: 50. ft

WELL DATA (MAG-112P)

Initial Displacement: 2.4 ft

Wellbore Radius: 0.25 ft

Screen Length: 10. ft

Gravel Pack Porosity: 0.35

Casing Radius: 0.083 ft

Well Skin Radius: 0.25 ft

Total Well Penetration Depth: 33.78 ft

SOLUTION

Aquifer Model: Confined

Solution Method: KGS Model

Kr = 2.704 ft/day

Ss = 1.669E-05 ft⁻¹

Kz/Kr = 1.

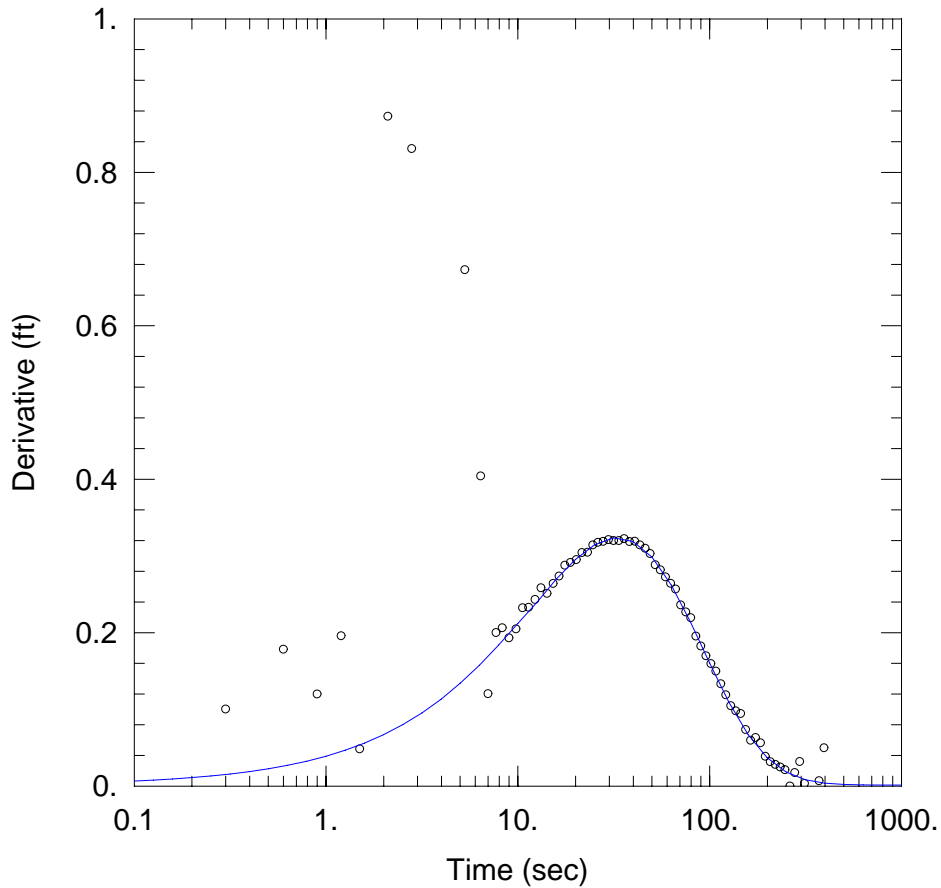

MAG-112P FALLING HEAD TEST

Data Set: N:\Projects Active\Ft DIX\Slug Tests\112pFHT.aqt

Date: 04/11/07

Time: 11:06:59

PROJECT INFORMATION

Company: Ft Dix

Test Well: MAG-112P

AQUIFER DATA

Saturated Thickness: 50. ft

WELL DATA (MAG-112P)

Initial Displacement: 2.4 ft

Wellbore Radius: 0.25 ft

Screen Length: 10. ft

Gravel Pack Porosity: 0.35

Casing Radius: 0.083 ft

Well Skin Radius: 0.25 ft

Total Well Penetration Depth: 33.78 ft

SOLUTION

Aquifer Model: Confined

Solution Method: KGS Model

Kr = 2.704 ft/day

Ss = 1.669E-05 ft⁻¹

Kz/Kr = 1.

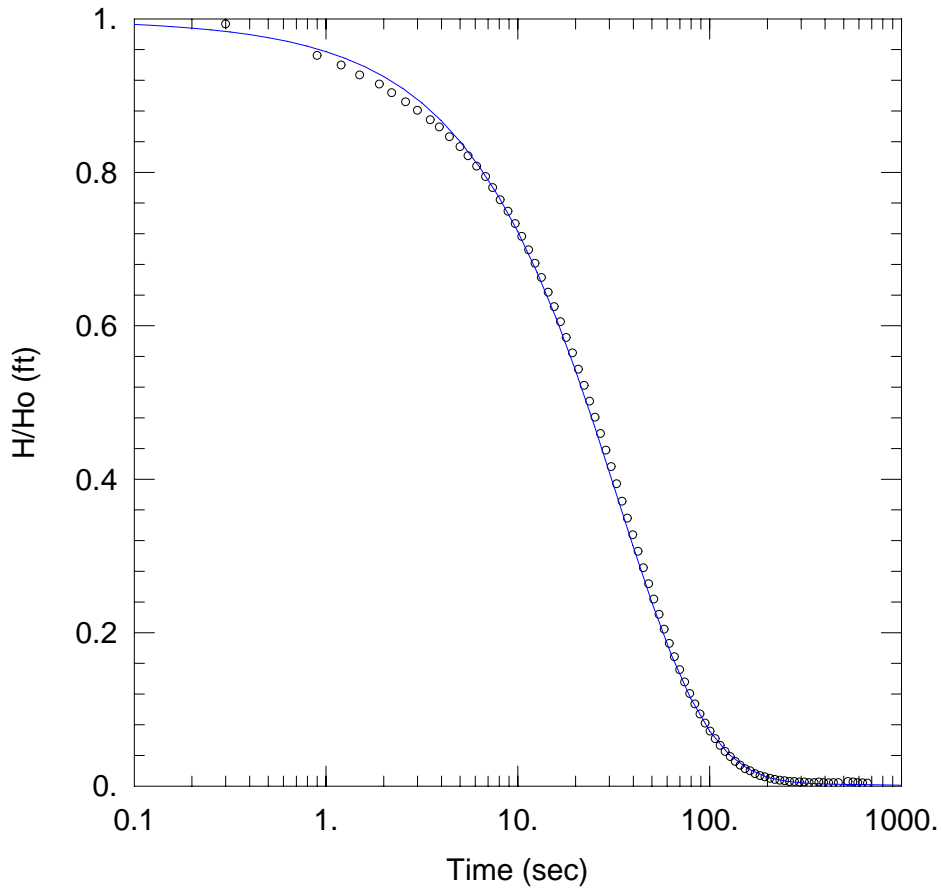

MAG-112P RISING HEAD TEST

Data Set: N:\Projects Active\Ft DIX\Slug Tests\112pRHT.aqt
 Date: 04/11/07 Time: 11:04:18

PROJECT INFORMATION

Company: Ft Dix
 Test Well: MAG-112P

AQUIFER DATA

Saturated Thickness: 50. ft

WELL DATA (MAG-112P)

Initial Displacement: <u>2.86 ft</u>	Casing Radius: <u>0.083 ft</u>
Wellbore Radius: <u>0.25 ft</u>	Well Skin Radius: <u>0.25 ft</u>
Screen Length: <u>10. ft</u>	Total Well Penetration Depth: <u>33.78 ft</u>
Gravel Pack Porosity: <u>0.35</u>	

SOLUTION

Aquifer Model: <u>Confined</u>	Solution Method: <u>KGS Model</u>
Kr = <u>2.813 ft/day</u>	Ss = <u>5.081E-06 ft⁻¹</u>
Kz/Kr = <u>1.</u>	

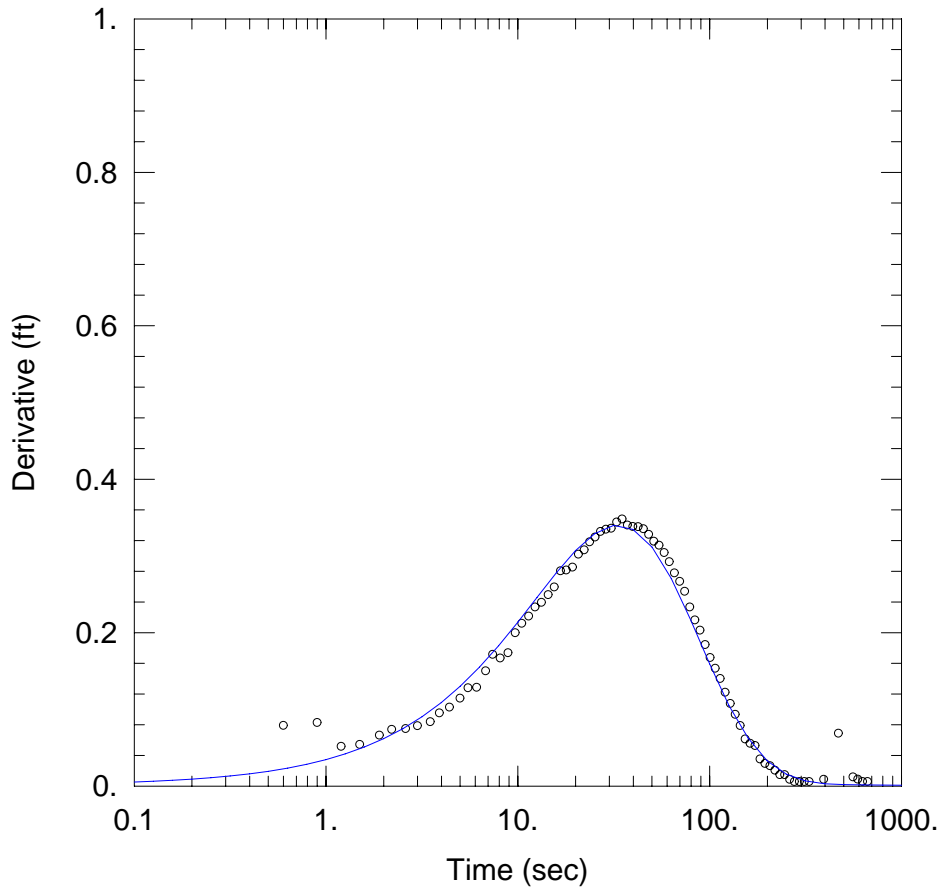

MAG-112P RISING HEAD TEST

Data Set: N:\Projects Active\Ft DIX\Slug Tests\112pRHT.aqt
 Date: 04/11/07 Time: 11:05:00

PROJECT INFORMATION

Company: Ft Dix
 Test Well: MAG-112P

AQUIFER DATA

Saturated Thickness: 50. ft

WELL DATA (MAG-112P)

Initial Displacement: <u>2.86 ft</u>	Casing Radius: <u>0.083 ft</u>
Wellbore Radius: <u>0.25 ft</u>	Well Skin Radius: <u>0.25 ft</u>
Screen Length: <u>10. ft</u>	Total Well Penetration Depth: <u>33.78 ft</u>
Gravel Pack Porosity: <u>0.35</u>	

SOLUTION

Aquifer Model: <u>Confined</u>	Solution Method: <u>KGS Model</u>
Kr = <u>2.813 ft/day</u>	Ss = <u>5.081E-06 ft⁻¹</u>
Kz/Kr = <u>1.</u>	

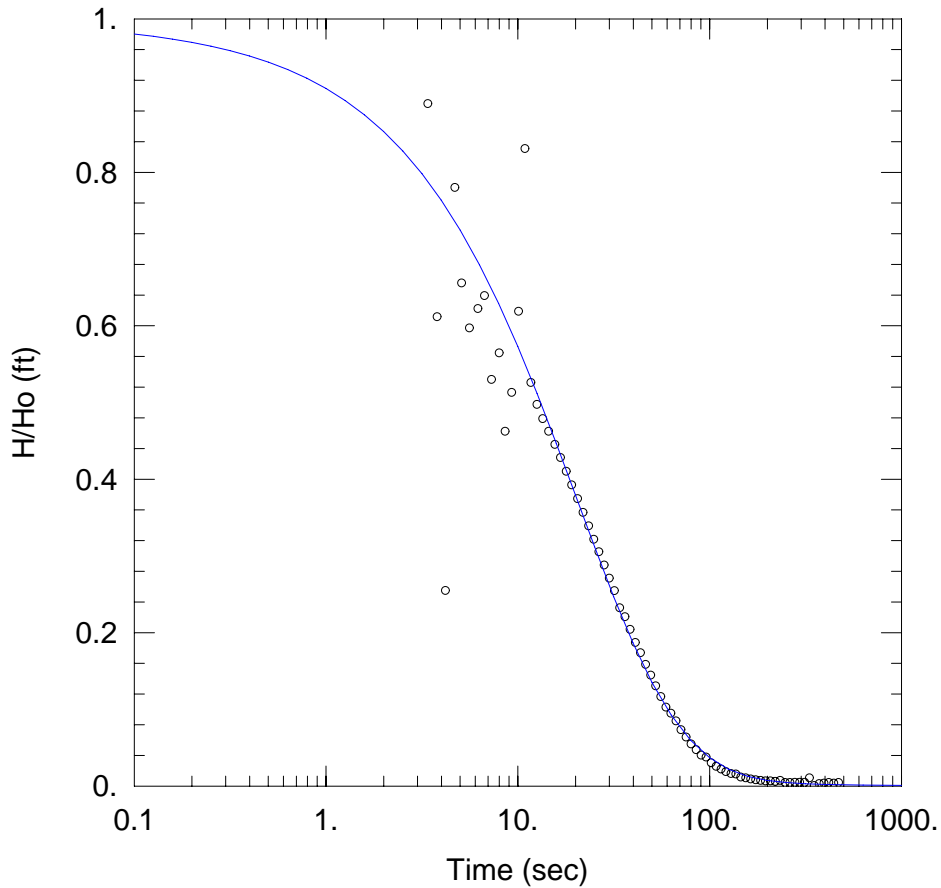

MAG-113P FALLING HEAD TEST

Data Set: N:\Projects Active\Ft DIX\Slug Tests\113pFHT.aqt

Date: 04/11/07

Time: 11:02:57

PROJECT INFORMATION

Company: Ft Dix

Test Well: MAG-113P

AQUIFER DATA

Saturated Thickness: 50. ft

WELL DATA (MAG-113P)

Initial Displacement: 2.8 ft

Wellbore Radius: 0.25 ft

Screen Length: 10. ft

Gravel Pack Porosity: 0.35

Casing Radius: 0.083 ft

Well Skin Radius: 0.25 ft

Total Well Penetration Depth: 26.58 ft

SOLUTION

Aquifer Model: Confined

Solution Method: KGS Model

Kr = 3.851 ft/day

Ss = 6.497E-05 ft⁻¹

Kz/Kr = 1.

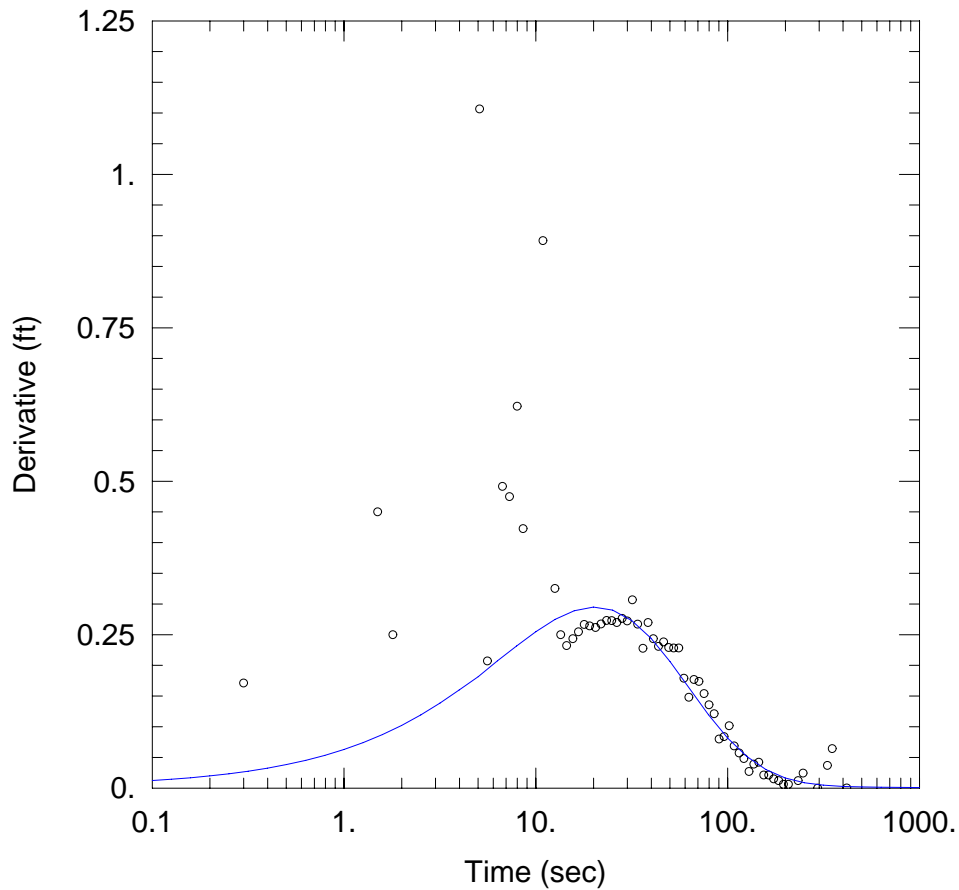

MAG-113P FALLING HEAD TEST

Data Set: N:\Projects Active\Ft DIX\Slug Tests\113pFHT.aqt

Date: 04/11/07

Time: 11:03:56

PROJECT INFORMATION

Company: Ft Dix

Test Well: MAG-113P

AQUIFER DATA

Saturated Thickness: 50. ft

WELL DATA (MAG-113P)

Initial Displacement: 2.8 ft

Wellbore Radius: 0.25 ft

Screen Length: 10. ft

Gravel Pack Porosity: 0.35

Casing Radius: 0.083 ft

Well Skin Radius: 0.25 ft

Total Well Penetration Depth: 26.58 ft

SOLUTION

Aquifer Model: Confined

Solution Method: KGS Model

Kr = 3.851 ft/day

Ss = 6.497E-05 ft⁻¹

Kz/Kr = 1.

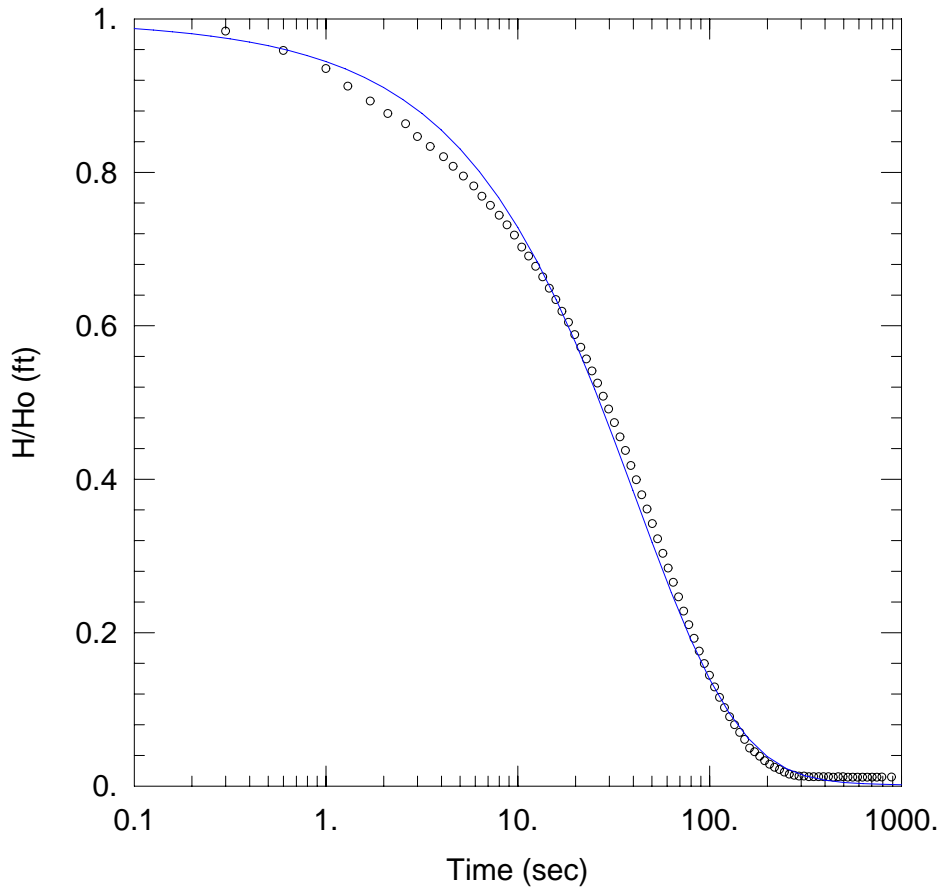

MAG-113P RISING HEAD TEST

Data Set: N:\Projects Active\Ft DIX\Slug Tests\113pRHT.aqt
 Date: 04/11/07 Time: 10:49:18

PROJECT INFORMATION

Company: Ft Dix
 Test Well: MAG-113P

AQUIFER DATA

Saturated Thickness: 50. ft

WELL DATA (MAG-113P)

Initial Displacement: <u>2.7 ft</u>	Casing Radius: <u>0.083 ft</u>
Wellbore Radius: <u>0.25 ft</u>	Well Skin Radius: <u>0.25 ft</u>
Screen Length: <u>10. ft</u>	Total Well Penetration Depth: <u>26.58 ft</u>
Gravel Pack Porosity: <u>0.35</u>	

SOLUTION

Aquifer Model: <u>Confined</u>	Solution Method: <u>KGS Model</u>
Kr = <u>1.891 ft/day</u>	Ss = <u>6.497E-05 ft⁻¹</u>
Kz/Kr = <u>1.</u>	

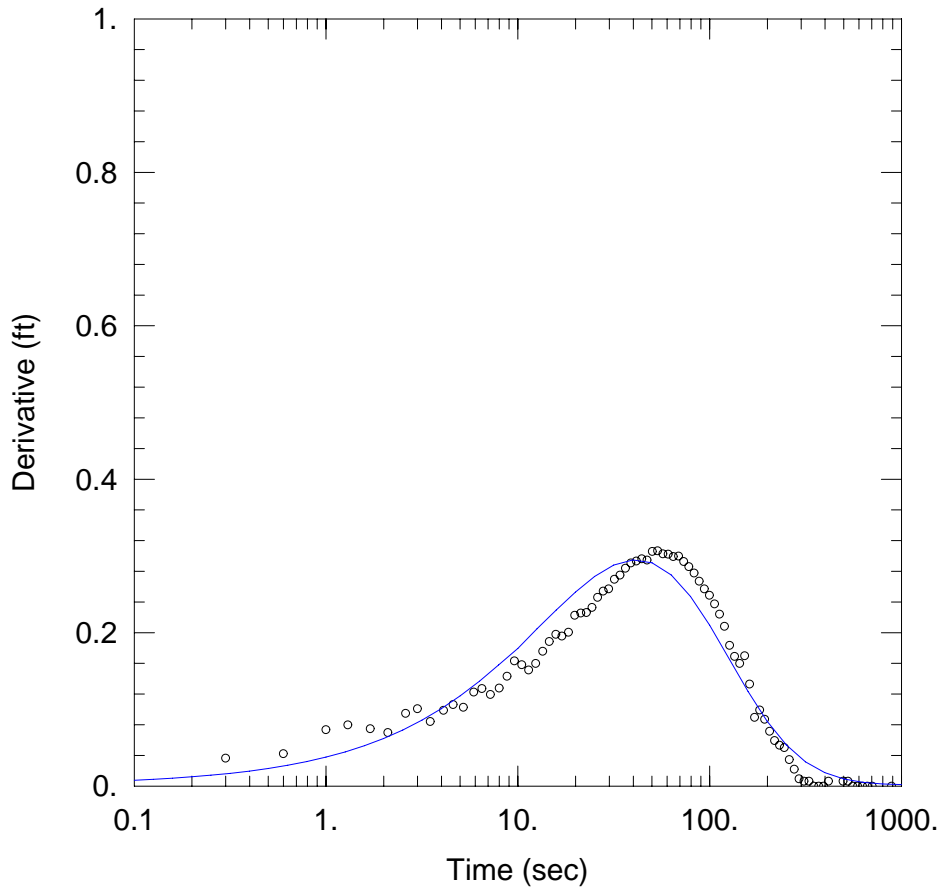

MAG-113P RISING HEAD TEST

Data Set: N:\Projects Active\Ft DIX\Slug Tests\113pRHT.aqt

Date: 04/11/07

Time: 10:50:01

PROJECT INFORMATION

Company: Ft Dix

Test Well: MAG-113P

AQUIFER DATA

Saturated Thickness: 50. ft

WELL DATA (MAG-113P)

Initial Displacement: 2.7 ft

Wellbore Radius: 0.25 ft

Screen Length: 10. ft

Gravel Pack Porosity: 0.35

Casing Radius: 0.083 ft

Well Skin Radius: 0.25 ft

Total Well Penetration Depth: 26.58 ft

SOLUTION

Aquifer Model: Confined

Solution Method: KGS Model

Kr = 1.891 ft/day

Ss = 6.497E-05 ft⁻¹

Kz/Kr = 1.

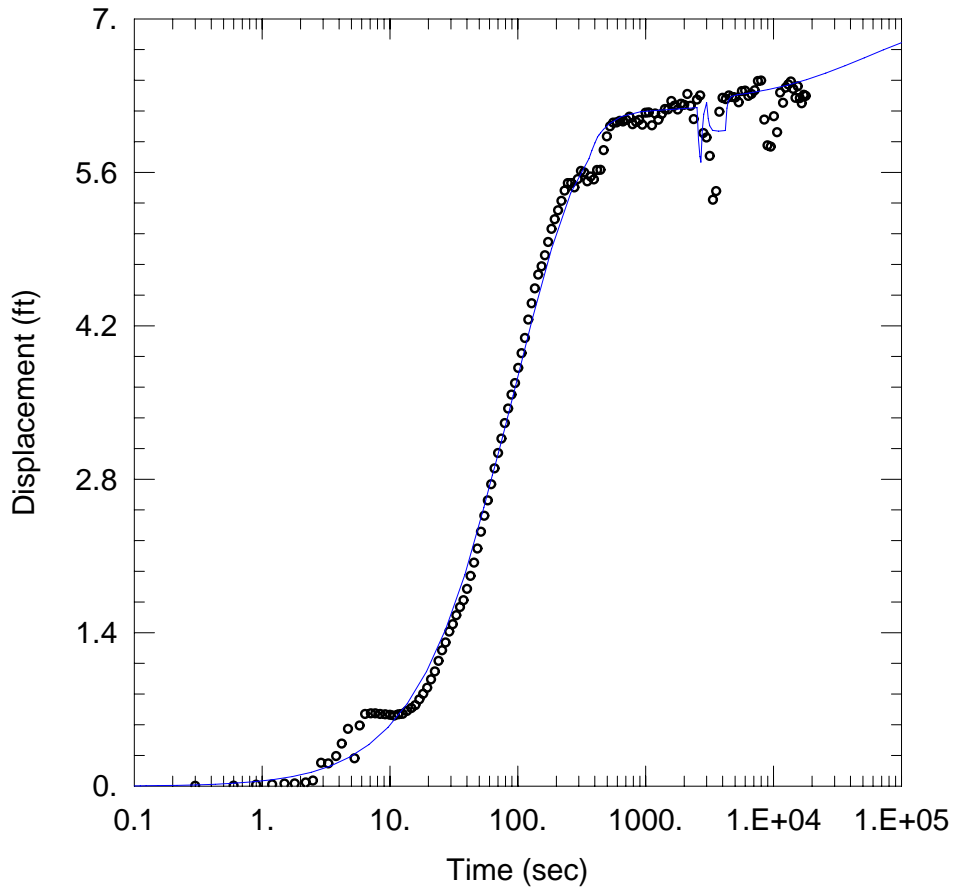

DRAWDOWNS AT PZ-1 FROM PUMPING AT PZ-1

Data Set: N:\Projects Active\Ft DIX\Pump Test\PZ-1-Pump-Moench.aqt
 Date: 04/25/07 Time: 10:13:02

PROJECT INFORMATION

Company: Ft Dix
 Test Well: MAG PZ-1

AQUIFER DATA

Saturated Thickness: 50. ft Anisotropy Ratio (Kz/Kr): 0.445

WELL DATA

Pumping Wells			Observation Wells		
Well Name	X (ft)	Y (ft)	Well Name	X (ft)	Y (ft)
PW 1	0	0	o PZ-1	0.5	0

SOLUTION

Aquifer Model: <u>Unconfined</u>	Solution Method: <u>Moench</u>
T = <u>93. ft²/day</u>	S = <u>0.001024</u>
Sy = <u>0.021</u>	β = <u>4.45E-05</u>
Sw = <u>0.</u>	Rw = <u>0.25 ft</u>
alpha = <u>0.0001585 sec⁻¹</u>	

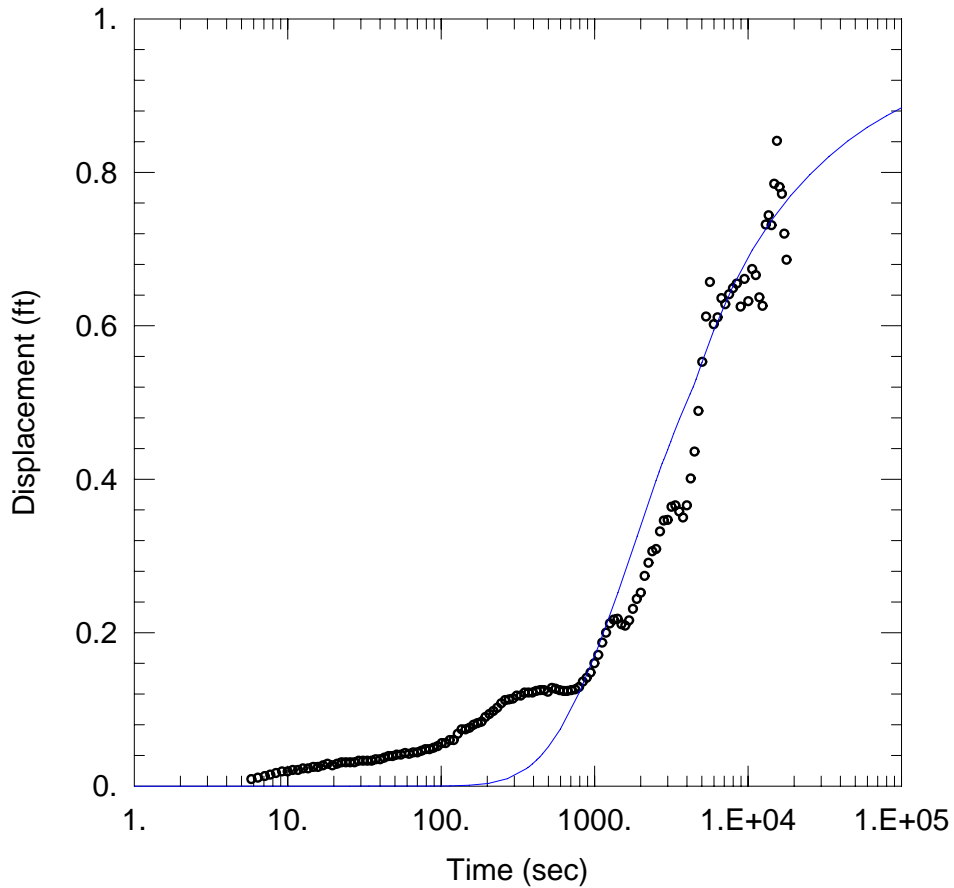

DRAWDOWNS AT PZ-2 FROM PUMPING AT PZ-1

Data Set: N:\Projects Active\Ft DIX\Pump Test\PZ-2-Pump-Moench.aqt
 Date: 04/25/07 Time: 09:20:29

PROJECT INFORMATION

Company: Ft Dix
 Test Well: MAG PZ-1

AQUIFER DATA

Saturated Thickness: 50. ft Anisotropy Ratio (Kz/Kr): 0.0454

WELL DATA

Pumping Wells

Observation Wells

Well Name	X (ft)	Y (ft)	Well Name	X (ft)	Y (ft)
PW 1	0	0	o PZ-2	-3	0

SOLUTION

Aquifer Model: Unconfined

Solution Method: Moench

T = 63.57 ft²/day

S = 0.001003

Sy = 0.02101

β = 0.0001634

Sw = 0.

Rw = 0.25 ft

alpha = 1.585E-06 sec⁻¹

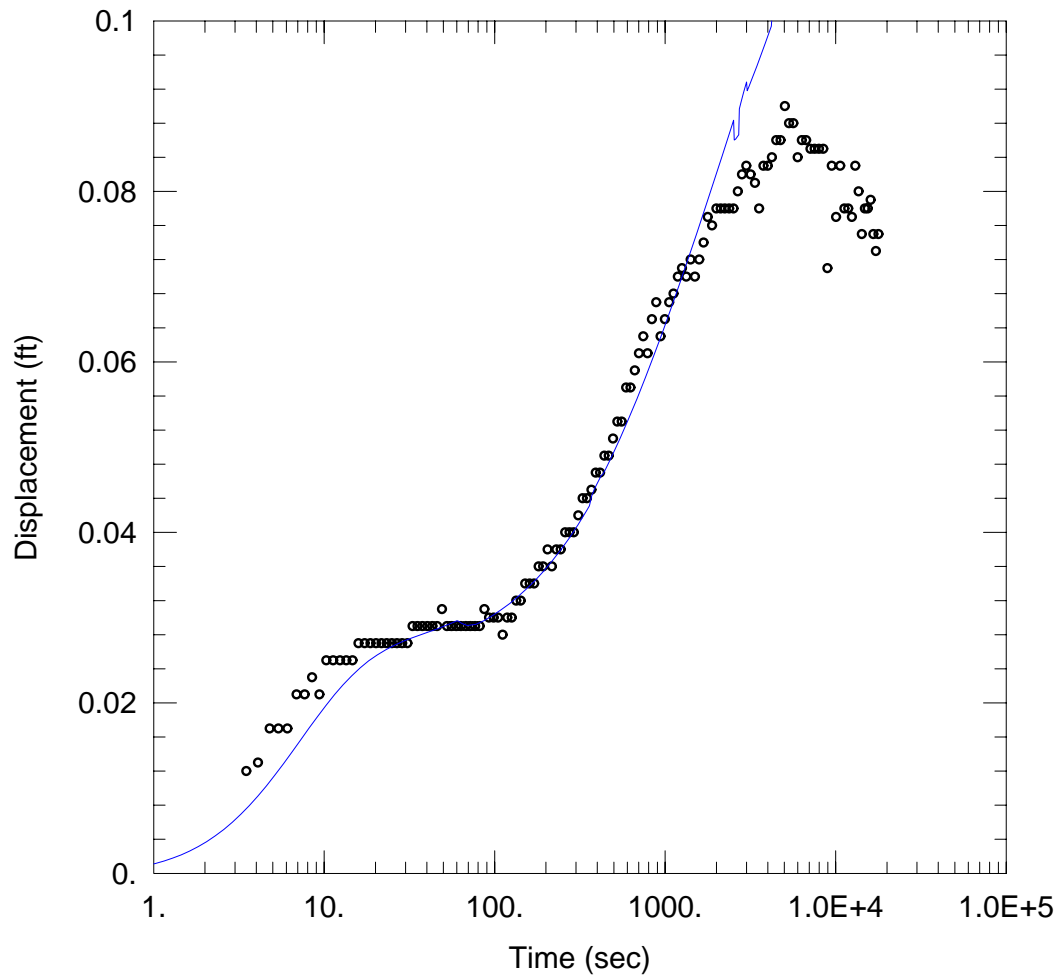

DRAWDOWNS AT MAG-66 FROM PUMPING AT PZ-1

Data Set: N:\Projects Active\Ft DIX\Pump Test\66-pump-Moench.aqt
 Date: 03/05/09 Time: 09:39:13

PROJECT INFORMATION

Company: Ft Dix
 Test Well: MAG PZ-1

AQUIFER DATA

Saturated Thickness: 50. ft Anisotropy Ratio (Kz/Kr): 1.

WELL DATA

Pumping Wells			Observation Wells		
Well Name	X (ft)	Y (ft)	Well Name	X (ft)	Y (ft)
PW 1	0	0	o MAG-66	4.75	0

SOLUTION

Aquifer Model: <u>Unconfined</u>	Solution Method: <u>Moench</u>
T = <u>452.4 ft²/day</u>	S = <u>2.091E-5</u>
Sy = <u>0.002819</u>	β = <u>0.009025</u>
Sw = <u>-2.275</u>	r(w) = <u>0.25 ft</u>
r(c) = <u>0.083 ft</u>	alpha = <u>0.04777 sec⁻¹</u>

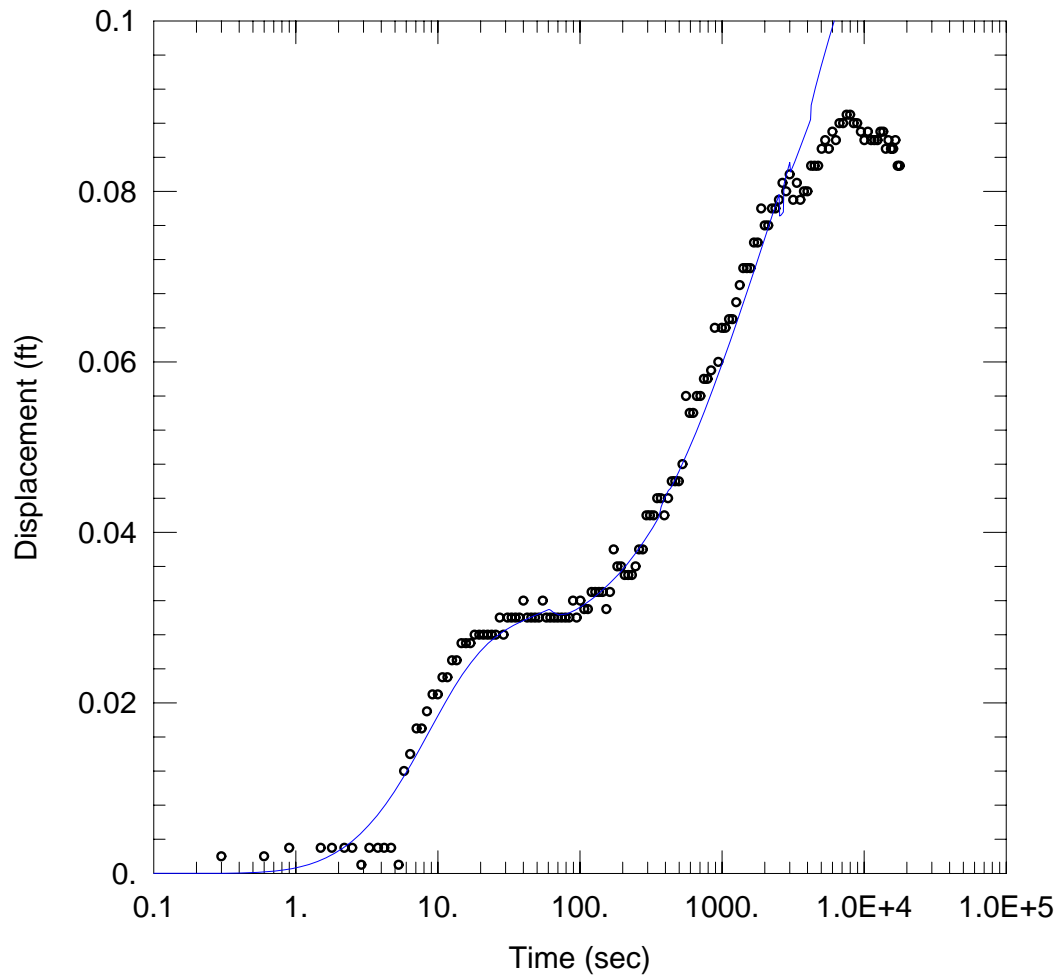

DRAWDOWNS AT MAG-112P FROM PUMPING AT PZ-1

Data Set: N:\Projects Active\Ft DIX\Pump Test\112P-pump-Moench-a.aqt
 Date: 03/05/09 Time: 09:28:10

PROJECT INFORMATION

Company: Ft Dix
 Test Well: MAG PZ-1

AQUIFER DATA

Saturated Thickness: 50. ft Anisotropy Ratio (Kz/Kr): 1.

WELL DATA

Pumping Wells			Observation Wells		
Well Name	X (ft)	Y (ft)	Well Name	X (ft)	Y (ft)
PW 1	0	0	• MAG-112P	5.75	0

SOLUTION

Aquifer Model: Unconfined

Solution Method: Moench

T = 559.6 ft²/day
 Sy = 0.00336
 Sw = -1.938
 r(c) = 0.083 ft

S = 5.496E-5
 β = 0.01323
 r(w) = 0.25 ft
 alpha = 0.01502 sec⁻¹

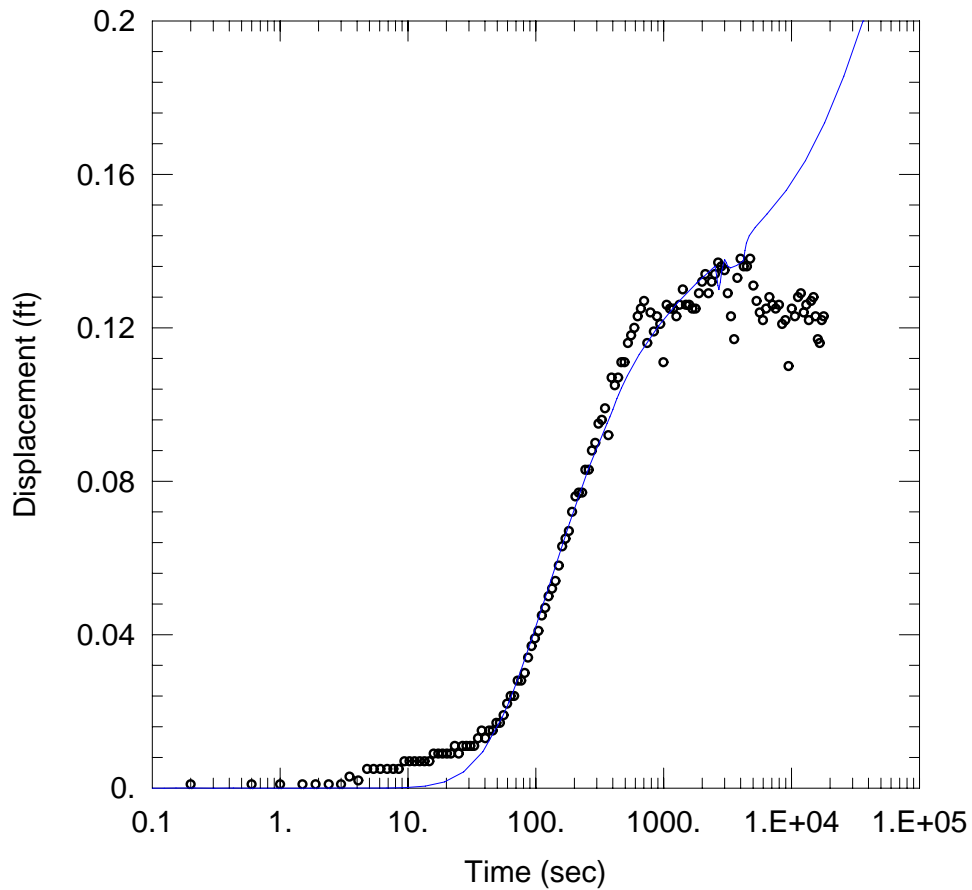

DRAWDOWNS AT MAG-113P FROM PUMPING AT PZ-1

Data Set: N:\Projects Active\Ft DIX\Pump Test\113p-pump-Moench.aqt
 Date: 04/25/07 Time: 10:51:45

PROJECT INFORMATION

Company: Ft Dix
 Test Well: MAG PZ-1

AQUIFER DATA

Saturated Thickness: 50. ft Anisotropy Ratio (Kz/Kr): 0.4834

WELL DATA

Pumping Wells			Observation Wells		
Well Name	X (ft)	Y (ft)	Well Name	X (ft)	Y (ft)
PW 1	0	0	◦ MAG-113P	5.2	0

SOLUTION

Aquifer Model: <u>Unconfined</u>	Solution Method: <u>Moench</u>
T = <u>254.2 ft²/day</u>	S = <u>0.00195</u>
Sy = <u>0.03049</u>	β = <u>0.005228</u>
Sw = <u>-0.7</u>	Rw = <u>0.5 ft</u>
alpha = <u>1.E-04 sec⁻¹</u>	

APPENDIX G
NJDEP Permit-by-Rule Application and Approval Letters



Shaw Environmental, Inc.
200 Horizon Center Boulevard
Trenton, NJ 08691-1904
609-584-8900
FAX: 609-588-6300

March 28, 2007

Mr Haiyesh Shah
NJDEP Bureau of Case Management
Floor 5 West, P O Box 028
401 East State Street
Trenton, NJ 08625-0028

**Subject: Request for NJPDES-DGW Permit-by-Rule
Bioaugmentation for Groundwater Remediation Field Demonstration
Environmental Security Technology Certification Program (ESTCP)
MAG-1 Area - Fort Dix, New Jersey**

Dear Mr Shah:

The following includes information to demonstrate compliance with the substantive requirements of the New Jersey Pollutant Discharge Elimination System (NJPDES) Discharge to Groundwater (DGW) Permit-by-Rule. This document is submitted to the NJDEP for addition of lactate as a microbial growth substrate, Shaw Dechlorinating Consortium (SDC-9) *Dehalococcoides* sp. (*DHC*) *bacteria*, diammonium phosphate (a nutrient) and carbonate buffer at the referenced site, as allowed by N.J.A.C. 7:14A-7.5(b) 3. The Fort Dix MAG-1 Area is located in New Hanover Township, New Jersey, Lot 1 Block 18.

Bioaugmentation, which consists of the addition of microorganisms to enhance degradation of contaminants, has been utilized as a treatment technology in various settings over the past five years. In the case of chlorinated ethene remediation, the most accepted form of bioaugmentation involves the use of mixed anaerobic cultures that contain DHC, or closely related strains, that can reductively dechlorinate the chlorinated ethenes. The SDC-9, enriched by Shaw, utilizes PCE, TCE, cis-1, 2-DCE, and VC as growth substrates. SDC-9 and has been successfully used to bioaugment multiple Shaw sites, including inoculation of a full-scale fluidized bed bioreactor used to treat contaminated groundwater at Naval Air Station North Island in San Diego, California, and multiple full-scale sites at Moody Air Force Base in Valdosta, Georgia. SDC-9 has also been used at Vandenberg AFB in California, Naval Station Treasure Island in California and at two commercial sites in Florida. DHC had successfully been used in bioaugmentation pilot studies at Kelly Air Force Base, Texas and Dover Air Force Base, Delaware.

The Environmental Security Technology Certification Program (ESTCP) Project ER-0515 proposes the addition of lactate and various concentrations of SDC-9, to groundwater in a demonstration (pilot-scale) study to assess the optimum concentration of circulating SDC-9 in groundwater to reduce concentrations of the volatile organic compounds (VOCs). The demonstration project will be conducted at the Fort Dix MAG-1 Area (see Figure 1). VOCs including trichloroethene (TCE) and cis-1, 2-dichloroethene (cis-1, 2-DCE) are the primary contaminants of concern in the groundwater at the MAG-1 Area. Figure 2 presents the location of the demonstration project at the MAG-1 Area and existing monitoring wells in the area.

Laboratory microcosm studies successfully promoted the degradation of the VOCs with the addition of lactate and SDC-9 to soil and groundwater collected from the site. Degradation was found to be more complete in the presence of lactate with the addition of SDC-9. Evaluation of the effectiveness

of lactate and SDC-9 at reducing chlorinated compounds will be based on a program of groundwater quality monitoring performed during operation of the groundwater re-circulation system used to amend site groundwater with lactate and SDC-9 and distribute it into the VOC contaminated aquifer.

Based on the results of the demonstration study, Fort Dix will implement a scaled up application of the bioaugmentation technology as the selected remedial action for the MAG-1 Area chlorinated solvent plume.

The proposed scope of work and schedule for the activities related to the addition and monitoring for the ESTCP project, as well an evaluation of local receptors and potential for impact are outlined below:

1.0 RECEPTOR EVALUATION

1.1 POTABLE WELLS AND SURFACE WATER BODIES

Fort Dix is served by its own water distribution system. Withdrawal wells are located on base for the purpose of water supply. The primary production wells for potable water are designated WW#1, WW#2, WW#3, WW#4 and WW #5. The water supply wells are screened in the Magothy-Raritan Aquifer at depths ranging from 900 to 1,100 feet below the ground surface (bgs). Two Fort Dix wells (WW#14 and Pemberton Road well) are located on training ranges for use during training exercises. The primary wells supply 20 percent of the bases need with the remaining 80 percent coming from an intake on the Greenwood Branch. Fort Dix does not lie in the drainage of Greenwood Branch. McGuire Air Force Base is severed in part by a municipal water system. Pemberton Township, located approximately 2-2.5 miles downgradient from the MAG-1 Area, is severed in part by water supply wells.

An unnamed intermittent stream that originates in a swampy area at the MAG-1 Area is part of the headwaters of Indian Run. Approximately 4 miles downstream, Indian Run flows into Rancocas Creek which in turn flows into the Delaware River 12 miles west of Fort Dix.

1.2 ONE MILE RADIUS WELL SEARCH

A one-mile radius well search was conducted through the NJDEP Bureau of Water Allocation (NJDEP BWA) to determine the number of wells within one mile of the proposed injection area and their designated uses.

One well record within a one-mile radius of the proposed injection area was found in the computer database. The well located upgradient from the MAG-1 Area is one of the Fort Dix water supply wells (WW#5).

It should be noted that the one-mile radius well search (performed by Shaw with the assistance of NJDEP BWA staff) returned records for several known NJDEP-permitted monitoring wells at the MAG-1 Area, as well as other environmental sites in the vicinity of the demonstration project. However, potential impact to any wells outside of the treatment area is negligible, and the only wells located in the vicinity of MAG-1 are Fort Dix monitoring wells.

1.3 FIVE MILE RADIUS WELL SEARCH (WELLS PRODUCING >70 GPM)

A five-mile radius well search was conducted through the NJDEP Bureau of Water Allocation to determine the number of wells within a five mile radius of the proposed injection area.

Well records for a total of 62 wells and 25 surface water intakes within a five mile radius of the proposed injection area were found in the computer database. Some of these wells include four wells owned by McGuire AFB; eight wells owned by Fort Dix; two wells owned by Wrightstown Boro; ten wells owned by Sybron Chemical Inc.; two wells owned by Pemberton Township; two wells owned by Pemberton Boro; three wells owned by Brookrest Sod Farm; four wells owned by Millcrest Apartments; six wells owned by the Pemberton HS Athletic Fields; and, three wells by Burlington City Industries. Twenty one of the surface water intakes are associated with farms, florists or nurseries. One intake on Greenwood Branch is the Fort Dix surface water intake. Three surface water intakes are associated with the Robson Land Company.

Potential impact to any supply wells, identified in the well search, is negligible based on the groundwater gradient at the MAG-1 Area demonstration site and the anticipated longevity of the lactate amendment and SDC-9 in the groundwater.

The following sections detail the methods to be used to inject and circulate the lactate and SDC-9, the quantity to be injected, and an evaluation of the potential for receptors to be impacted by the injected material.

2.0 SCOPE OF WORK

The objective of this project is to generate the data necessary to produce a guidance document for applying anaerobic bioaugmentation for the remediation chlorinated solvent contaminated aquifers. Results from the pilot-study demonstration will be used to design and operate an expanded application of the technology to remediate the MAG-1 Area chlorinated solvent plume.

The demonstration project will consist of 4 injection/extraction re-circulation loops and associated surface equipment to add and re-circulate the lactate and SDC-9 amendments. The loops will be spaced approximately 35 ft apart (see Figure 3). Each loop will consist of one injection and one extraction well spaced approximately 50 ft apart with two additional monitoring wells located equidistant between the injection/extraction well pair. Diammonium phosphate, a nutrient, and sodium carbonate, a pH buffer, will be added to the amendments, if needed. The demonstration project is to be performed at the Fort Dix MAG-1 Area identified on Figure 2. The groundwater re-circulation system will provide hydraulic control of the demonstration area and facilitate *in situ* biodegradation. This treatment approach and field application is mature and is anticipated to be applicable to the MAG-1 Area remediation and site closure agreements. Results of the demonstration project will be documented in an ESTCP report that will have wide application to DOD and commercial facility remediation projects.

2.1 PROCUREMENT AND DEPLOYMENT

SDC-9 has been selected as the *DHC* to evaluate the optimum concentration for bioaugmentation. SDC-9 will be added in re-circulation loops 1 through 3. The fourth loop will only have injected and re-circulated lactate and buffer. Figure 3 presents the layout of the MAG-1 Area injection and extraction well loops and additional monitoring wells.

The bioaugmentation culture, SDC-9, will be injected in bioaugmentation loops 1 through 3 at the desired dosages. At this time, the injection wells in Loops 1, 2, and 3 will be inoculated with the appropriate volume of SDC-9 culture (2.2, 22, and 220 L, respectively). The culture will be delivered directly into the injection well from sealed canisters of culture and under a nitrogen headspace. It is anticipated that microbial injection will take approximately 1 to 2 days to complete. Extracted groundwater will be amended with sodium lactate (final injection concentration of 500 mg/L during the Period of Operation); and diammonium phosphate and sodium carbonate (final injection concentration of 105 mg/L), then re-injected into the subsurface via the injection well at a flow rate of 1.7 gpm. The bioaugmentation re-circulation loops are currently designed to re-circulate amended groundwater at a rate of 1.7 gpm, operating on continuous basis. Thus, during the 4-month operating period, approximately 1.4×10^6 gallons of contaminated groundwater are expected to be re-circulated. Conservatively assuming an average effective biodegradation rate constant of 0.001/day over the four loops (which assumes that no substantial biodegradation will occur in the lactate + buffer only control loop), model simulations predict that average TCE concentrations of 1,800 µg/l in the demonstration test area will be reduced to less than 300 µg/l within 4 months. Based on this rate and extent of TCE reduction, and assuming continuous operation of the injection/extraction well system, an estimated 17.6 lbs. of TCE will be treated. The corresponding rate of contaminant treatment is expected to be approximately 0.15 lbs/day. These contaminant treatment estimates are conservative.

The anticipated duration for operating the pilot-study re-circulation loops is five months. The anticipated duration for the entire demonstration (including system installation) is eight to nine months. During system testing and inoculation, system operating parameters will be monitored by field personnel on a daily basis. Once active re-circulation is established, system operating parameters will be monitored by field personnel approximately 2 to 3 times per week. Parameters include injection/extraction well flow rates, injection well pressures, extraction well water levels, and amendment delivery rates. Data will be reviewed and evaluated to ensure the system is operating properly.

Initial operating parameters have been selected based on site-specific historic hydraulic data. Slug tests and a short term aquifer test will be performed to verify the historic data. Site-specific information has been utilized to update the current groundwater model and to simulate the injection and extraction loop flow rates and capture zones.

During the 4-week start-up period of lactate, diammonium phosphate and carbonate injection, a bromide/fluoride (in the forms of sodium bromide and sodium fluoride) tracer test will be performed to verify local hydrogeologic characteristics and accurately determine the extent of the capture zone and radius of influence of the system extraction wells. Tracer solution, mixed in a 55-gallon drum, will be injected at a concentration of 20 mg/L to provide detectable tracer concentrations (> 0.2 mg/L) in demonstration area loop monitoring wells.

If biofouling is determined to be a potential problem, or if biofouling becomes an issue in the field (as evidenced by increasing drawdown in the extraction wells or injection pressures in the injection wells), design and construction of a biofouling control system will be performed for the injection-extraction system. Based on Shaw's past experience, the system will most likely involve treatment of injection and/or extraction wells with Tetrakis (hydroxymethyl)phosphonium sulfate (THPS), a biodegradable anti-fouling agent, or chlorine dioxide. Depending on the degree of biofouling, biofouling treatments will either be automated for daily operation (if moderate to severe biofouling is anticipated or observed), or performed manually (if minimal biofouling is anticipated or observed). Shaw has designed, constructed and operated biofouling mitigation systems for several remediation projects.

2.2 PERFORMANCE MONITORING

In addition to project design sampling conducted during January 2007 a total of 19 sampling events are planned during the seven-month demonstration; two background monitoring events performed prior to system start-up; five sampling events following system start-up (prior to the DHC injection), and 10 sampling events after the DHC injection. The sampling schedule may be adjusted based on system performance. Groundwater samples will be collected from the test plot monitoring wells in accordance with USEPA Region 9 "Standard Operating Procedure for Low Stress (Low Flow)/Minimal Draw-down Ground-Water Sample Collection". Groundwater samples will be analyzed at the Shaw Environmental Analytical Laboratory in Lawrenceville, NJ. The groundwater samples will be analyzed for VOCs using EPA Method 8260B, anions, volatile fatty acids and reduced gases. Total iron and manganese will be analyzed by ChemTech in Mountainside, New Jersey or another Shaw approved laboratory. qPCR analysis (DHC bacteria counts) will be performed by the Shaw laboratory in Knoxville, Tennessee. Geochemical parameters, including pH, dissolved oxygen, conductivity, and oxidation-reduction potential (ORP) will be measured during sample collection using a field instrument.

Following the five-month period of operation, contaminant rebound will be evaluated over a two-month period. Two sampling events will be conducted. Groundwater monitoring during the rebound evaluation will be used to determine the rate at which aquifer geochemical parameters return to baseline conditions. Specifically, changes in dissolved iron and manganese concentrations, ORP, and TOC (used as a surrogate for cosubstrate concentration) will be monitored as a function of time.

2.3 POTENTIAL FOR RECEPTOR IMPACT

Groundwater in the shallow unconfined aquifer at the MAG-1 Area discharges to an unnamed, intermittent stream in the area and flows to the southwest. Based on previous slug test results and historic groundwater level measurements, the MAG-1 Area groundwater velocity was calculated to be 0.8 to 1.5 feet/day. Particle track models using 35 foot injection and extraction well spacing with a flow rate of 1.7 gpm indicated a capture zone that would keep the injected amendments within the demonstration area and will not discharge to the intermittent stream.

2.4 REPORT PREPARATION

A Cost and Performance Report detailing the procedures and results of the technology demonstration will be prepared following completion of field activities. The report will evaluate the following:

- Amendment distribution – including any modifications to system operating parameters made in order to attain sufficient cosubstrate delivery
- *DHC growth rate.* The rate of DHC growth, as measured by qPCR analyses, will be used calculated by measuring the rate of increase in DHC levels in monitoring wells. Measured rates will be compared to rates measured in the laboratory, as well as those simulated in the model.
- Electron donor (lactate) decay rate – calculation of the cosubstrate decay rate in order to optimize amendment dosage and delivery rates

- Contaminant biodegradation rates – in order to determine the overall reduction in dissolved contaminant concentrations as a result of implementing the proposed treatment technology
- Biofouling mitigation – based on changes in system pressures and flow rates measured during system operation
- Cost – analysis will be presented for a typical site as compared to competing technologies

3.0 SCHEDULE

Injection, extraction and monitoring well installation is scheduled to begin in April 2006, system installation will be performed during May and June 2006 and system operation will start in July or August 2006.

4.0 FULL-SCALE TECHNOLOGY APPLICATION

Results from the ESTCP MAG-1 Area bioaugmentation field demonstration project will be used as inputs for the final design of a full-scale technology application. Currently it is not anticipated that the full-scale application will be much different from the field demonstration. The area covered by the injection and recirculation loops will be larger than the demonstration project. The full-scale technology application would also be in compliance with the substantive requirements of the New Jersey Pollutant Discharge Elimination System (NJPDES) Discharge to Groundwater (DGW) Permit-by-Rule. Shaw is requesting that this permit-by-rule be allowed to cover the full scale application. Once the final design is in place, a letter update to the NJDEP can be provided with proposed full-scale application layout, injection concentrations and sample program changes as an update to this application.

If you have any further questions or comments, please do not hesitate to contact me at (609) 588-6311.

Sincerely,



Frederick M. Poli, PE
Project Manager

Attached: Figures

Cc: Ken Smith, Fort Dix Environmental
James Richman, Shaw
Rick Wice, Shaw
Charles Schaeffer, Shaw
Dave Lippincott, Shaw



State of New Jersey

Department of Environmental Protection

Jon S. Corzine
Governor

Lisa P. Jackson
Commissioner

Bureau of Case Management
Floor 5 West, PO Box 028, 401 East State Street
Trenton, NJ 08625-0028

Phone: (609) 633-0718/Fax: (609) 633-1439/Email: Haiyesh.Shah@dep.state.nj.us

21September2007

CERTIFIED MAIL
RETURN RECEIPT REQUESTED
NO.

Mr. David Peckham, Regional Director of Public Works
Department of the Army-Environmental Division
Building 5317, Delaware Avenue--ATTN: AFRC-FA-PWN
Fort Dix, NJ 08640-5501

Dear Mr. Peckham:

Re: **APPROVAL—12Apr07 Request for New Jersey Pollutant Discharge Elimination System – Discharge to Groundwater (NJPDES – DGW) Permit-by-Rule Application for MAG-1 Area**
Fort Dix Guaranteed Fixed Price Remediation (GFPR) Sites
New Hanover & Pemberton Townships, Burlington County
NJDEP Preferred Identification: 007195

The New Jersey Department of Environmental Protection (NJDEP) has reviewed your letter dated 12Apr07 (received 17Apr07) requesting issuance of a New Jersey Pollution Discharge Elimination System/Discharge to Groundwater (NJPDES/DGW) Permit Equivalent by Rule for the proposed Bioaugmentation for Groundwater Remediation Field Demonstration Environmental Security Technology Certification Program (ESTCP) at MAG-1 Area.

The ESTCP project proposes the addition of lactate and various concentrations of SDC-9, to groundwater in a demonstration (pilot-scale) study to assess the optimum concentration of circulating SDC-9 in groundwater to reduce concentrations of the volatile organic compounds.

The NJPDES regulations, specifically N.J.A.C. 7:14A-7.5, allow NJDEP to issue permit-by-rule authorizations for discharges that occur during the course of a site remediation that is being conducted in accordance with the Technical Requirements for Site Remediation, N.J.A.C. 7:26E, including the requirements of N.J.A.C. 7:26E-6.1 and 6.3(c). Therefore, NJDEP hereby authorizes the discharge associated with the treatment technology, as described above, to the groundwater at the site. Also, in accordance with the Comprehensive

Environmental Response, Compensation, and Liability Act, permits are not required for remedial actions taken entirely on federal facilities, only the substantive requirements need be met. NJDEP provides those requirements to the federal facility in the form of a permit “equivalent.” This approval is valid only when all of the following conditions are met.

1. The treatment process/discharge will not result in a discharge to surface water or affect surface water supplies. In addition, surface runoff will be controlled.
2. All technical details (including monitoring program) provided in your application must be followed and fulfilled.
3. A Summary Report shall be submitted to NJDEP within three hundred and sixty five (365) days upon receipt of this correspondence. This report shall include the exact dates when the treatment occurred, along with the data required herein.
4. All necessary permits and approvals (i.e., Water Allocation Permits, local approvals, etc.) shall be obtained by the applicant prior to discharging under the permit-by-rule.
5. Fort Dix shall initiate the injection procedure, as conditioned above, within ninety (90) days of the date of this approval, and begin implementation according to the proposed time schedule. If any current or anticipated delay is caused by events beyond the control of Fort Dix, then Fort Dix shall notify NJDEP in writing within ten (10) calendar days of such event. Fort Dix shall precisely describe the cause of the delay and request an extension. Increases in the costs or expenses incurred in fulfilling the requirements outlined herein shall not be considered a basis for an extension and such extension requests will not be granted.
6. Provide a copy of this letter to all Restoration Advisory Board members as well as local government officials.

The above approval does not reflect the review of the New Jersey Pinelands Commission.

Sincerely,

Haiyesh Shah

C: Burlington County Health Department (Also CEHA)
Municipal Clerk, New Hanover Township
Municipal Clerk, Pemberton Township
Mr. John DeMurley, USEPA-Federal Facility Section
Ms. Donna McBride, NJ Pinelands Commission

APPENDIX H
Quality Assurance Project Plan (QAPP)
From “Draft Field Demonstration Plan for Bioaugmentation for
Groundwater Remediation (Demonstration Plan): January, 2007.

Appendix C: Quality Assurance Project Plan (QAPP)

C.1 Purpose and Scope

This section presents the project-specific Quality Assurance Project Plan (QAPP) for the bio-augmentation demonstration at the MAG-1 Area at Fort Dix, New Jersey. This QAPP specifies the procedures the demonstration will follow to ensure it generates analytical data of known quality. These procedures are integral to the demonstration and complement the sampling procedures presented in Section 3. Tables and figures accompanying this document are located immediately after the document text.

Both laboratory analytical and field screening methods will be used to measure parameters indicative of the electron donor biostimulation demonstration's performance. The purpose of this QAPP is to outline steps to ensure that: (1) data generated during the course of the demonstration are of an acceptable and verifiable quality (*i.e.*, quality assurance); and (2) a sufficient number of control measurements are taken for proper data evaluation (*i.e.*, quality control).

C.2 Quality Assurance Responsibilities

Key QA personnel for the project and their responsibilities are outlined below.

Rob Steffan, Ph.D. is the Principal Investigator for the demonstration, and has overall project QA responsibility.

David Lippincott, P.G. is the Project Coordinator for the demonstration. Mr. Lippincott will insure that all field sampling is completed in accordance with the demonstration plan requirements to insure that reliable data can be derived from the samples.

Randi Rothmel, Ph.D. is the Manager of Shaw's Analytical and Treatability Laboratory, and will have laboratory QA responsibility for anion and TOC analytical data during the project. Dr. Rothmel will perform external audits of the independent laboratories conducting Fe and Mn analysis. Dr. Rothmel will report directly to Dr. Steffan.

C.3 Data Quality Parameters

This section describes all of the measurements that will be made to achieve the project's objectives.

The laboratory program for the bioaugmentation demonstration will include measuring the concentrations of chlorinated volatile organic carbons (TCE, cis-1,2-DCE, VC), reduced gases (ethene, ethane), anions (bromide, nitrate, sulfate, and chloride), selected metals (iron and manganese), and other performance-related parameters (DO, redox, DHC) in groundwater. These measurements are outlined in Table 3.4. Shaw's Analytical and Treatability Laboratory (New Jersey-certified, non-CLP) in Lawrenceville, NJ, will be used for routine off-site analyses of all parameters, with metals samples being subcontracted to Chemtech in Mountainside, NJ, or another outside analytical laboratory approved by Shaw. qPCR analyses for DHC will be analyzed at Shaw's laboratory in Knoxville, TN. For all groundwater analyses, standard U.S. EPA methods will be used (where available) as outlined in: (1) *U.S. EPA Test Methods for Evaluating Solid Waste, Physical/Chemical Methods SW846*, Third Edition, revised November 1986, Update II, September 1994, Update IIB, January 1995, and Update III, June 1997; (2) *Methods for Organic Chemical Analysis of Municipal and Industrial Wastewater* (EPA-600/4-85 054); (3) *U.S. EPA Methods for Analysis of Water and Wastes* (EPA-600/4-79-020, 1979); and (4) *Methods for Determination of Organic Compounds in Drinking Water* (EPA-600/4-88/039).

Additional groundwater parameters may be screened in the field using electronic meters. These parameters will be measured using methods approved or accepted by the U.S. EPA for reporting purposes. Groundwater field-measured parameters will include oxidation-reduction potential (ORP), pH, specific conductivity, dissolved oxygen (DO) and temperature.

C.4 Calibration Procedures, Quality Control Checks, and Corrective Action

C4.1 Quality Control Objectives

The goal of the bioaugmentation demonstration is to accomplish the following: 1) Evaluate the efficacy of the bioaugmentation technology with respect to chlorinated ethene (TCE, cis-1,2-DCE, VC) degradation; 2) Develop the design criteria and protocol necessary for full-scale application of the technology; and 3) Evaluate the cost-effectiveness of the technology. As such, the project data quality objectives (Project DQOs) are as follows:

- (1) collect data of sufficient quantity and quality to determine destruction efficiencies and biodegradation rates of chlorinated ethenes as a function of bioaugmentation dosage;

- (2) collect data of sufficient quantity and quality to assess the growth, activity, and distribution of DHC I groundwater;
- (3) collect data suitable for use in designing a full-scale bioaugmentation system; and
- (4) collect data suitable for preparing a cost comparison analysis.

To meet the Project DQOs stated above, individual measurements must meet particular quantitative QA objectives for precision, accuracy, method detection limits, and completeness, as well as qualitative QA objectives for comparability and representativeness. This section describes the quality assurance objectives for the electron donor biostimulation demonstration in order to meet the specific Project DQOs stated above.

The specific data QA objectives are as follows:

- ◆ establish sample collection and preparation techniques that will yield results representative of the media and conditions analyzed;
- ◆ collect and analyze a sufficient number of field blanks to evaluate the potential for contamination from ambient conditions or sample collection techniques;
- ◆ collect and analyze a sufficient number of field duplicates to assess the homogeneity of samples received by the laboratory as well as the homogeneity of contaminants in the matrix; and
- ◆ analyze method blanks, laboratory duplicates, matrix spikes, matrix spike duplicates, and surrogate spikes as required by the specific analytical methodology to determine if QA goals established for precision and accuracy are met for off-site laboratory analyses.

The data generated during the demonstration will be used primarily for determining the DHC dosage needed to effectively treat the chlorinated ethene-contaminated groundwater, as well as the distribution and growth rate of the inoculated microorganisms. In an effort to produce data that will be useful for this assessment, definitions of data usage, data types, data acquisition, and data quality level have been made for each medium. These defined data parameters are collectively defined as DQOs. Table C.1 presents the DQOs for this technology demonstration. Table C.1 correlates data use with the required degree of analytical sophistication. This approach is based on the generalized DQOs presented by the U.S. EPA (1987). Five levels of data quality are used, ranging from Level I (field screening) to Level V (CLP special analytical services). Due to the variation in the types of monitoring throughout the demonstration, data quality objective Levels I and III will be used. Several geochemical parameters, such as pH, temperature, and DO, will be determined in the field with immediate response required for process control (Level I). All off-site analytical laboratory measurements will be performed using Level III criteria for production of validated data.

Quality assurance objectives have been established to evaluate the criteria of precision, accuracy, and completeness. The evaluation of these criteria for validated (Level III) off-site laboratory analyses will be based upon sample duplicates, matrix spikes, matrix spike duplicates, and surrogates, as described in Section C.4.3. The criteria for precision, accuracy, and completeness for all validated data will follow the guidelines established in Section C.6.1. Evaluation of method detection limits (MDLs) will be in accordance with the procedures outlined in Appendix A to Part 136 “Definition and Procedures for the Determination of Method Detection Limit - Revision 1.1,” 40 Code of Federal Regulations (CFR) 136, 1984.

C.4.2 Analytical Procedures and Calibration

Analytical Procedures. All laboratory analyses will be performed according to the established SW-846 and U.S. EPA Methods (see Table 3.4 and Appendix B) found at <http://www.epa.gov/epaoswer/hazwaste/test/main.htm>.

qPCR Analytical Technique. DHC concentrations in the cultures and samples will be determined by quantitative “real-time” PCR with primers (5'- gaagtagtgaaccgaaagg and 5'- tctgtccattgtagcgtc) that amplify a 235bp fragment of 16s rDNA of DHC-type organisms. Cloned DHC 16S rDNA from the SDC-9 culture will be used as a standard, and the reactions will be performed on an Idaho Technologies Lightcycler instrument (Salt Lake City, UT). DNA will be extracted from the cultures and soils by using an Idaho Technologies 1-2-3 DNA Isolation Kit or a MO BIO Laboratories, Inc. Soil DNA Isolation Kit (Carlsbad, CA), respectively, according to the manufactures’ recommendations.

Calibration Procedures and Frequency. Calibration refers to the checking of physical measurements of both field and laboratory instruments against accepted standards. It also refers to determining the response function for an analytical instrument, which is the measured net signal as a function of the given analyte concentration. These determinations have a significant impact on data quality and will be performed regularly. In addition, preventative maintenance is important to the efficient collection of data. The calibration policies and procedures set forth will apply to all test and measuring equipment. For preventative maintenance purposes, critical spare parts will be obtained from the instrument manufacturer.

All field and laboratory instruments will be calibrated according to manufacturers’ specifications. All laboratory instruments will be calibrated in accordance with established Standard Operating Procedures. Calibration will be performed prior to initial use and after periods of non-use. A record of calibration will be made in the field logbook each time a field instrument is calibrated. A separate logbook will be maintained by laboratory QA personnel similarly for laboratory instrumentation.

Process and Field Measurements. The portable instruments used to measure field parameters (*e.g.*, temperature, pH, etc.) will be calibrated in accordance with manufacturer’s instructions.

Flow measuring devices will not be calibrated if calibration requires the instruments to be sent back to the manufacturer. All other manufacturer-recommended checks of the flow instruments will be performed. The instruments will be calibrated at the start and completion of the demonstration. The pH, DO, and ORP probes will be calibrated prior to every site check during the demonstration.

Field Measurements: Groundwater. Groundwater will be assessed for dissolved oxygen and oxidation/reduction potential. Depth to groundwater measurements will be taken using a water interface probe.

Dissolved Oxygen, Temperature, pH, Conductivity and Oxidation/Reduction Potential

Groundwater samples will be collected using a low-flow bladder pump. Samples will be measured for dissolved oxygen, temperature, pH, conductivity and redox potential under continuous flow using a multi-probe water quality meter (Horiba Model U-22, YSI probe, or similar). In order to minimize aeration of the sample, a continuous flow-through cell will be used to provide a sampling chamber for the meter. A sufficient volume of water from the well or groundwater sampling point will be purged before sample collection to ensure that a sample representative of the formation is obtained.

Depth to Groundwater

The depth to groundwater in site wells will be measured with a water interface probe (ORS Model #1068013 or equivalent). The probe lead is a 50- to 200-ft measuring tape with 0.01-ft increments. The probe gives a constant beep when it encounters the water table. The water-level measurement will be recorded in the field logbook and the probe decontaminated between measurements.

Groundwater Sampling

Prior to sampling, the well or sampling point identification will be checked and recorded along with the date and time in the field logbook. Groundwater samples will be collected using a low-flow bladder pump and flow-through cell and collected in 40-mL amber glass VOA vials with teflon septa-lined caps. Samples will be analyzed for the target compounds TCE, cis-1,2-DCE, and VC.

Laboratory Measurements. The calibration procedures for all off-site analyses will follow the established SW-846 and U.S. EPA guidelines for the specific method (see Appendix B). Certified standards will be used for all calibrations and calibration check measurements. The frequency and acceptance criteria for all off-site analyses will follow the guidelines outlined below.

Initial Calibration. During initial calibration, a minimum of one blank and five calibration standards that bracket the validated testing range will be analyzed singularly on one day. The concentration of the calibration standards will be prepared in the matrix that results from all the preparation steps of the method, taking into account any steps that are part of the method. Con-

centrations in the matrix will correspond to those in the environmental matrix as if the method preparation steps had been performed.

In addition to the initial calibration standards, the analysis of a calibration check standard is required prior to analysis of any samples. If the method requires what could be an initial calibration each day an analysis is performed, then the calibration check standards will be analyzed once each week rather than each day.

If the results of the calibration check standard are not acceptable, immediate re-analysis of the calibration check standard will be performed. If the results of the re-analysis still exceed the limits of acceptability, the system will be considered to have failed calibration. Sample analysis will be halted and will not resume until successful completion of initial calibration. Corrective actions taken to restore initial calibration will be documented in the analyst's notebook.

Daily Calibration. Calibration standards will be analyzed each day analyses are performed to verify that instrument response has not changed from previous calibration. Each day before sample analysis, a mid-range concentration standard will be analyzed. The response must fall within the required percentage or two standard deviations of the mean response for the same concentration, as determined from prior initial/daily calibrations (see below). If the response fails this test, the daily standard will be re-analyzed. If the response from the second analysis fails this range, initial calibration will be performed before analyzing samples.

Each day after sample analyses are completed, a second standard will be analyzed. If the response is not within the required percentage or two standard deviations of the mean response from prior initial/daily calibrations, the daily standard will be re-analyzed. If the response from the second analysis fails this range, the system will be considered to have failed calibration. Initial calibration will then be performed and all samples re-analyzed since the last acceptable calibration will be re-analyzed.

For non-linear or non-zero-intercept calibration curves, daily calibration will consist of analysis of the low, middle, and high standards at the beginning of the day. When sample analyses are completed at the end of the day, the low and high standards will be analyzed. Instrument responses for each concentration determination must fall within two standard deviations of the mean response, as described previously, for the appropriate standard. For calibrations fitted by the quadratic equation, a minimum of four standards over the validated range are required, along with the highest level standard analyzed at the end of the day. For all other equations, one more standard than needed to meet the degrees of freedom for any lack-of-fit is required, as a minimum.

Calibration Check Standards. Calibration check standards will be analyzed during each initial calibration. The calibration check standard will contain all analytes of interest for the method in question at a concentration as required by the method. Results of the calibration check standards must fall within the limits of acceptability as described below:

Case 1 - A certified check standard is available from the U.S. EPA or some other source with both the true value and limits of acceptability specified by the supplier. The results must fall within the limits specified by the supplier, or $\pm 20\%$ for inorganics and $\pm 15\%$ for organics, whichever is less.

Case 2 - A certified check standard is available from the U.S. EPA or some other source with a true value specified but without limits of acceptability. The results must fall within $\pm 20\%$ for inorganics and within $\pm 15\%$ for organics.

Case 3 - If no certified check standard is available, the laboratory shall prepare a check standard using a second source of reference material. This standard shall be prepared by a different analyst than the one who prepared the calibration standard. If weighing of the material is required, a different balance will be used, if possible. The results must fall within $\pm 20\%$ for inorganics and within $\pm 15\%$ for organics.

Case 4 - If there is only one source of reference material available, then the calibration and calibration check standards must be prepared from the same source. The standards shall be prepared by different analysts. If weighing is required, different balances will be used, if possible. The results must fall within $\pm 20\%$ for inorganics and within $\pm 15\%$ for organics.

For all cases listed above, after the seventh acceptable check standard, the limits of acceptability will be \pm two standard deviations, as determined from the first seven points.

For multi-analyte methods, the calibration check standard will contain all analytes of interest (target analytes). For the check standard to be deemed acceptable, at least two-thirds of the analytes must meet the limits of acceptability as defined above. In addition, if a single target analyte falls outside the limits of acceptability for two consecutive times, then the calibration check standard will be deemed unacceptable. If a calibration check standard is not acceptable, the procedures detailed above will be followed.

C.4.3 Internal Quality Control Checks

Quality Control Samples. Internal QC data provides information for identifying and defining qualitative and quantitative limitations associated with measurement data. Analysis of the following types of QC samples will provide the primary basis for quantitative evaluation of analytical measurement data quality:

Field QC Samples

- ◆ equipment blanks to evaluate the potential for contamination from ambient conditions, sampling equipment, or sample collection techniques;
- ◆ trip blanks to evaluate the presence of contamination from handling errors or cross-contamination during transport; and
- ◆ field/collection duplicates to assess the homogeneity of samples received by the laboratory as well as the homogeneity of contaminants in the matrix, respectively.

Laboratory QC Samples

- ◆ method blanks, laboratory duplicates, matrix spikes, and matrix spike duplicates to determine if QA goals established for precision and accuracy are met by the analytical laboratory.

The number, type, and frequency of laboratory QC samples will be dictated by the validated SW-846 or U.S. EPA Methods used by the Shaw E&I laboratory and by the off-site laboratories. The SW-846 and U.S. EPA Methods shown in Table 3.4 and Appendix B specify the number and types of laboratory QC samples required during routine analysis. This information will be supplied with the data package provided by the laboratory.

In addition to the internal QC samples described above, the off-site laboratories will provide, at a minimum, additional internal QC checks as follows:

- ◆ use of standard analytical reference materials for traceability of independent stock solutions prepared for calibration stocks, control spike stocks, and reference stock solutions;
- ◆ verification of initial calibration curves with independent reference stock solutions according to Section C.4.2;
- ◆ verification of initial calibration curves with daily calibration standards according to Section C.4.2;
- ◆ verification of continued calibration control by analysis of calibration standards to document calibration drift;
- ◆ analysis of control spikes to document method performance and control with respect to recent performance.

An attempt will be made to analyze all samples within the calibrated range of the analytical method. Dilution of a sample extract with extracting solvent, or of the original sample matrix with distilled/de-ionized water, will be performed if the concentration of an analyte is greater than the calibrated range of the method.

Blank Samples

Blanks are artificial samples designed to detect the introduction of contamination or other artifacts into the sampling, handling, and analytical process. Blanks are the primary QC check of measurements for trace-level concentrations.

Equipment Blanks. Equipment blanks are used to assess the level of contamination of sampling devices. Groundwater samples will be collected using a bladder pump with dedicated polyethylene tubing. Purified-water will be run through the tubing and collected into 1 L sample jars for explosives analysis. Equipment blanks will be prepared at a minimum of 5% of all samples.

Method Blanks. Method blanks will be prepared by the off-site laboratories to evaluate the impact of the analytical process on detected concentrations of contaminants. Method blanks will be prepared for each batch of samples run for a given method of analysis. The method blanks will be processed through the entire preparation and analytical procedure in the same manner as field samples. The method blanks will provide data to assess potential systematic contamination of the measurement system.

Field Duplicate Samples. Duplicate samples will be analyzed to evaluate the accuracy of the analytical process. Duplicate samples will be analyzed as described below. Each duplicate will be run at a frequency of at least 5 percent of the total number of environmental samples. A comparison of the detected concentrations in the duplicate samples will be performed to evaluate precision. The evaluation will be conducted using Equation C.2 for Relative Percent Difference (RPD) as described in Section C.6.1.

Collection Duplicate. This duplicate is obtained by collecting a second discrete sample from the same sample location and submitting the collections as discrete samples to the laboratory. The purpose of the collection duplicate is to assess the homogeneity of the contaminants in the matrix.

Blind Samples. At least 20 percent of the duplicate samples will be submitted to the laboratory as “blind samples,” so that the laboratory does not know the location from which the sample was taken. Blind samples will be labeled “BLIND#-Date”. For example, the second blind sample taken on 02/02/07 will be labeled BLIND2-02/02/07. The actual well location from which the blind sample is taken will be recorded in the field notebook.

Laboratory Control Samples. Laboratory control samples will be used by the laboratory to assess analytical performance under a given set of standard conditions. These samples will be specifically prepared to contain some or all of the analytes of interest at known concentrations. The samples will be prepared independently of the calibration standards. Types of laboratory control samples that may be used are laboratory duplicates, matrix spikes, matrix spike duplicates, and surrogate spikes. Analysis of laboratory control samples will be used to estimate the analytical

bias and accuracy by comparing measured results obtained during analysis to theoretical concentrations. This comparison will be measured using Equation C.1 as presented in Section C.6. The matrix spike/matrix spike duplicate samples will be used to evaluate precision according to Equation C.2. The accepted range of RPD values for *matrix spike/matrix spike duplicate* samples for each laboratory analysis will be in accordance with the Methods presented in Appendix B. Stock solutions used to spike QC samples will be prepared independently of stocks used for calibration as required by appropriate EPA methods. Validation of spiked solutions will be performed on a regular basis before the solution is used.

C.4.4 Sample Documentation

The on-site Field Engineer will coordinate with the off-site laboratories for shipment and receipt of sample bottle, coolers, icepacks, chain-of-custody (COC) forms, and Custody Seals. Upon completion of sampling, the COC will be filled out and shipped with the samples to the laboratory. An important consideration for the collection of environmental data is the ability to demonstrate that the analytical samples have been obtained from predetermined locations and that they have reached the laboratory without alteration. Evidence of collection, shipment, laboratory receipt, and laboratory custody until disposal must be documented to accomplish this. Documentation will be accomplished through a COC Record that records each sample and the names of the individuals responsible for sample collection, transport, and receipt. A sample is considered in custody if it is:

- ◆ in a person's actual possession;
- ◆ in view after being in physical possession;
- ◆ sealed so that no one can tamper with it after having been in physical custody; or
- ◆ in a secured area, restricted to authorized personnel.

Sample custody will be initiated by field personnel upon collection of samples. As discussed in Section 3, samples will be packaged to prevent breakage or leakage during transport, and will be shipped to the laboratory via commercial carrier, or transported via car or truck.

Sample Identification. A discrete sample identification number will be assigned to each sample. These discrete sample numbers will be placed on each bottle and will be recorded, along with other pertinent data in a field notebook dedicated to the project. For blind samples, the sample location will be recorded in the field notebook along with a note indicating that the sample was submitted to the laboratory as a blind sample. The sample identification number will designate the sample location ("MW-" for specific monitoring well, and "B" for blind samples) and date collected. For example, a sample collected from the MW-4 groundwater sample port collected February 2, 2007 would be identified as follows:

MW-4-02/02/07

Chain-of Custody Forms. The COC Record used by Shaw’s laboratory is shown in Figure C.1. All samples collected for off-site analysis will be physically inspected by the Field Engineer prior to shipment.

Each individual who has the sample in their possession will sign the COC Record. Preparation of the COC Record will be as follows:

- ◆ The COC Record will be initiated in the field by the person collecting the sample, for every sample. Every sample shall be assigned a unique identification number that is entered on the COC Record.
- ◆ The record will be completed in the field to indicate project, sampling person, etc.
- ◆ If the person collecting the samples does not transport the samples to the laboratory or ship the samples directly, the first block for “Relinquished By _____, Received By _____” will be completed in the field.
- ◆ The person transporting the samples to the laboratory or delivering them for shipment will sign the record for as “Relinquished By _____”.
- ◆ The original COC Record will be sealed in a watertight container, taped to the top (inside) of the shipping container, and the shipping container sealed prior to being given to the commercial carrier. A copy of the COC Record will be kept on-site.
- ◆ If shipping by commercial carrier, the waybill will serve as an extension of the COC Record between the final field custodian and receipt by the off-site laboratory.
- ◆ Upon receipt by the off-site laboratory, the laboratory QC Coordinator, or designated representative, shall open the shipping container(s), compare the contents with the COC Record, and sign and date the record. Any discrepancies shall be noted on the COC Record.
- ◆ The COC Record is completed after sample disposal.
- ◆ COC Records will be maintained with the records for the project, and become part of the data package.

Laboratory Sample Receipt. Following sample receipt, the Laboratory Manager will:

- ◆ Examine all samples and determine if proper temperature has been maintained during transport. If samples have been damaged during transport, the remaining samples will be carefully examined to determine whether they were affected. Any samples affected shall be considered damaged. It will be noted on the COC Record that specific samples were damaged and that the samples were removed from the sampling program. Field personnel will be instructed to re-sample, if appropriate.

- ◆ Compare samples received against those listed on the COC Record.
- ◆ Verify that sample holding times have not been exceeded.
- ◆ Sign and date the COC Record, attaching the waybill if samples were shipped for off-site analysis.
- ◆ Denote the samples in the laboratory sample log-in book which will contain, at a minimum, the following information:
 - Project Identification Number
 - Sample numbers
 - Type of samples
 - Date and time received
- ◆ Place the completed COC Record in the project file.

The date and time the samples are logged in by the Sample Custodian or designee should agree with the date and time recorded by the person relinquishing the samples. Any nonconformance to the stated procedures that may affect the cost or data quality should be reported to the Principal Investigator.

Other Documentation. Following sample receipt at the laboratory, the Laboratory Manager or sample custodian will clearly document the processing steps that are applied to the sample. The analytical data from laboratory QC samples will be identified with each batch of related samples. The laboratory log book will include the time, date, and name of the person who logged each sample into the laboratory system. This documentation will be thorough enough to allow tracking of the sample analytical history without aid from the analyst. At a minimum, laboratory documentation procedures will provide the following:

- ◆ Recording in a clear, comprehensive manner using indelible ink;
- ◆ Corrections to data and logbooks made by drawing a single line through the error and initialing and dating the correction;
- ◆ Consistency before release of analytical results by assembling and cross-checking the information on the sample tags, custody records, bench sheets, personal and instrument logs, and other relevant data to verify that data pertaining to each sample are consistent throughout the record;
- ◆ Observations and results identified with the project number, date, and analyst and reviewer signatures on each line, page, or book as appropriate;
- ◆ Data recorded in bound books or sheaf of numbered pages, instrument tracings or hard copy, or computer hard copy; and,

- ◆ Data tracking through document consolidation and project inventory of accountable documents: sample logbook, analysis data book, daily journal, instrument logbook, narrative and numerical final reports, etc.

C.4.5 Data Reduction, Validation, and Reporting

This section describes procedures for reducing, validating, and reporting data. All validated analytical data generated within the off-site laboratories will be extensively checked for accuracy and completeness by laboratory and project personnel. Records will be kept throughout the analytical process, during data generation, and during reporting so that adequate documentation to support all measurements is available. Recordkeeping, data reduction, validation, and reporting procedures are discussed in this section.

Data Reduction. Data reduction will follow the requirements contained in the SW-846 and U.S. EPA analytical methods cited previously. Reduction involves the reformatting of data to present the desired end-product, *i.e.*, the concentrations of the contaminants. Reformatting will involve the process of performing calculations on the raw data and presenting all values in appropriate units. The information generated by the data reduction step will be used in the interpretation of the data qualifiers.

The responsibility for data acquisition and reduction of raw data resides with the analysts who perform the analysis. Raw data for the quantitative VOC analysis procedures used during this project will consist of peak areas for surrogates, standards, and target compounds. Analytical results will be reduced to concentration units appropriate for the medium being analyzed, *i.e.* micrograms per liter ($\mu\text{g/L}$) for aqueous samples.

Data Validation. Data validation involves a review of the QC data and the raw data in order to identify any qualitative, unreliable, or invalid measurements. As a result, it will be possible to determine which samples, if any, are related to out-of-control QC samples. Laboratory data will be screened for inclusion of and frequency of the necessary QC supporting information, such as detection limit verification, initial calibration, continuing calibration, duplicates, matrix spikes, surrogate spikes, and the method and preparation blanks. QC supporting information will be screened to determine whether any datum is outside established control limits. If out-of-control data are discovered, appropriate corrective action will be determined based upon QC criteria for precision, accuracy, and completeness. Any out-of-control data without appropriate corrective action will be cause to qualify the affected measurement data.

Levels of data validation for the demonstration are defined below:

- ◆ **Level I.** For Level I field screening data quality, a data “package” including the results from sample blanks, method blanks, and supporting calibration information, will be recorded in the field logbook and on log sheets maintained within a folder on-site. The ex-

tent of contamination and the achievement of detection limits can be determined from this information. The sample results and QC parameters will be routinely evaluated by site personnel, and 10% of the analytical raw data results will be reviewed by the Project Manager to verify sample identity, instrument calibration, quantification limits, numerical computation, accuracy of transcriptions, and calculations.

- ◆ **Level III.** For Level III validated data quality, a CLP-like data package will be provided. For the 8260 VOC analyses, this includes CLP-like summary forms 1 through 10 and all raw data associated with the samples, without the chromatograms of calibration standards, matrix spikes, or matrix spike duplicates. The laboratory deliverable format for the New Jersey-certified laboratories will follow the guidelines in Appendix B “Laboratory Data Deliverables Formats - Section III (Reduced Laboratory Data Deliverables - USEPA/CLP Methods)” CITE 25 of the New Jersey Register (NJR), February 3, 2003. Sample results will be evaluated according to the current version of the U.S. EPA functional guidelines for organic and inorganic analyses for selected QA/QC parameters, and 10% of the analytical raw data results will be reviewed to verify sample identity, instrument calibration, detection limits, numerical computation, accuracy of transcriptions, and calculations.

At a minimum, the following data validation procedures will be followed.

Each data package will be reviewed and the data validated prior to submission. Checklists will be used to demonstrate that the data review was accomplished. The Laboratory Manager or designee will perform the data review and validation.

The data review will include, but not be limited to, the following subjects:

- ◆ Completeness of laboratory data;
- ◆ Evaluation of data with respect to reporting limits;
- ◆ Evaluation of data with respect to control limits;
- ◆ Review of holding time data;
- ◆ Review of sample handling;
- ◆ Correlation of laboratory data from related laboratory tests;
- ◆ Comparison of the quality of the data generated with DQOs as stated in this Work Plan (on a daily basis, during routine analyses, and during internal laboratory audits); and
- ◆ QC chart review, performed weekly, following receipt of control charts for analyses performed the previous week. Review shall consist of assessing trends, cycles, patterns, etc. This review shall also assess whether control corrective actions have been implemented.

The elements of data validation shall include, but not be limited to, the following items:

- ◆ Examination of COC records to assess whether custody was properly maintained;
- ◆ Comparison of data on instrument printouts with data recorded on worksheets or in notebooks;
- ◆ Comparison of calibration and analysis dates and assessment of whether the same calibration was used for all samples within a lot;
- ◆ Examination of chromatographic outputs for manual integrations, and documentation of the reasons for any manual integrations;
- ◆ Comparison of standard, sample preparation, and injection records with instrument output to assess whether each output is associated with the correct sample;
- ◆ Examination of calibration requirements, as specified in the methods;
- ◆ Use of a hand-held calculator to perform all calculations on selected samples to assess the correctness of results; and
- ◆ Examination of all papers and notebooks to ensure that all pages are signed and dated, that all changes are initialed, dated, have sufficient explanation for the change, and that all items are legible.

Required record-keeping following a laboratory audit shall document that all lots were reviewed in the audit report. The audit report shall also identify any deficiencies that were noted. A copy of the audit report shall be placed in the applicable installation audit folder.

Data Reporting. Data and information generated during the demonstration will be summarized in a Technology Application Analysis Report, to be submitted at the completion of the project. QA/QC analysis reports will be generated by laboratory personnel as a product of validation procedures described above. All off-site Level III analyses will be accompanied by QA/QC data packages as described in the previous section. The summary QA/QC reports will not be included in the Technology Application Analysis Report, but will be made available upon request. The ultimate data set produced for project use will consist of all values reported in appropriate units flagged with respective data qualifiers for entry into the project database as described below. Analytical results will be reduced to concentration units appropriate for the medium being analyzed:

- ◆ “ $\mu\text{g/L}$ ” or “ mg/L ”, depending on analyte and method, for aqueous samples.

The laboratory will retain all samples and sample extracts for 6 weeks following data package submittal.

The results for each analyte in spiked QC samples will be determined using the same acceptable calibration curve that is used for environmental samples in the lot. Values above the practical quantitation limit (PQL) shall be reported as the found value. Raw values that fall below the method detection limit (MDL) will be reported as “less than” the PQL. Values above the method detection limit (MDL) and less than the PQL will be reported and flagged with a “J”. Results for QC samples will not be corrected, except as described below. Because all spike levels must be within the calibrated range, no dilutions should be required. Data will be reported using the correct number of significant figures.

Each day of analysis, the analyst will quantify each analyte in the method blank and spiked QC samples. A new lot of samples will not be introduced into the analytical instrument until results for QC samples in the previous lot have been calculated, plotted on control charts as necessary, and the entire analytical method shown to be in control. If time is a constraint, the calculation of associated environmental sample results may be postponed until a later date. The analyst will maintain control charts by the instrument so that the results of QC samples can be hand-plotted, in order to have an early indication of problems.

Data from the method blank will be reported, usually as less than the MDL for each analyte. Any values above the MDL shall be reported as the found value. Corrections to the QC samples, necessitated by background levels in the method blank, will be performed using instrument response values and not the found values calculated from the linear calibration curve. Reported entries will be in terms of concentration. The importance attached to finding measurable concentrations in the method blank is dependent on analyte and method. Identification of measurable concentrations in the method blanks will be reported in writing to the Principal Investigator for possible corrective actions.

The following additional data reporting procedures will be followed.

All data will be reported, and numerical results will be reported in terms of concentration in the environmental sample. Resultant found concentrations will be adjusted for dilution, etc. before being reported, and both the raw data and correction factors (*e.g.*, percent moisture, and dilution factor) will be recorded in the data package submitted. Laboratory comments on the usability of the data will also be included.

In reporting results, rounding to the correct number of significant figures will occur only after all calculations and manipulations have been completed. As many figures as are warranted by each analytical technique will be used in pre-reporting calculations. Rounding will be accomplished using the following rules:

Rule 1 - In expressing an experimental quantity, retain no digits beyond the second uncertain one.

Rule 2 - In rounding numbers (*i.e.*, in dropping superfluous digits):

- ◆ Increase the last retained digit by one if the first uncertain digit is larger than 5;
- ◆ Retain the last digit unchanged if the first uncertain digit is less than 5;
- ◆ Retain the last digit unchanged if even, or increase it by one if odd, if the first uncertain digit is 5 and the second uncertain digit is 0;
- ◆ Increase the last retained digit by one if the first uncertain digit is 5 and the second uncertain digit is greater than 0.

The correct number of reported significant figures, by validation type, is 3 significant figures. The number of allowable significant figures is reduced when added uncertainties are included in the analysis, *i.e.*, the results for samples diluted into the validated range allow one less significant figure due to the uncertainty added by the dilution process.

C.4.6 Corrective Action Plan

If routine procedures (*e.g.*, equipment calibration), QC sample analysis, or performance and system audits indicate that sampling or analysis systems are unsatisfactory, a corrective action shall be implemented. During performance audits, if performance evaluation (PE) samples do not meet the QA criteria for accuracy and precision specified in Section C.6, analytical work will stop until the problems are identified and resolved. Before work resumes, another blind PE sample must be analyzed, and results must meet the acceptance criteria. Results of all PE samples will be included in the Application Analysis Report. If previously reported data are effected by the situation requiring correction or if the corrective action will impact the project budget or schedule, the action will directly involve the Principal Investigator. ESTCP will be informed of all major performance problems, and will be included in corrective action planning.

Corrective actions are of two kinds:

1. Immediate, to correct or repair non-conforming equipment and systems. The need for such an action will most frequently be identified by the analyst or technician as a result of calibration checks and QC sample analyses. Immediate corrective actions address problems peculiar to a single measurement or lot of samples. Immediate corrective action may include:
 - ◆ Re-run of analyses if sample holding times have not been exceeded;
 - ◆ Instrument re-calibration using freshly prepared standards;
 - ◆ Replacement of reagents or solvents that give unacceptable blank values;
 - ◆ Examination of data calculation errors; and

- ◆ Replacement of reference standards that have been degraded.

If corrective action indicates that non-conformance is due to problems with laboratory equipment, procedures, and/or calibration, once the problem is resolved, the non-conforming samples will be re-analyzed if holding times have not been exceeded. If holding times have been exceeded, new samples will be collected if the completeness criteria specified in Section C.6 require that these samples be collected. If corrective action indicates that non-conformance of duplicate samples is due to sampling technique, once the problem is corrected, new samples will be collected if the completeness criteria specified in Section C.6 requires that these samples be collected.

2. Long-term, to eliminate causes of non-conformance. The need for such actions will probably be identified by audits. Long-term corrective actions may address procedural deficiencies or unsatisfactory trends or cycles in data that affect multiple lots of samples. Examples of long-term corrective action may include:

- ◆ Staff training in technical skills or in implementing the QAPP;
- ◆ Rescheduling of laboratory routine to ensure analysis within allowed holding times;
- ◆ Identifying alternate vendors to supply reagents of sufficient purity; and
- ◆ Revision of the QAPP.

For either immediate or long-term corrective action, steps comprising a closed-loop corrective action system will be implemented as follows:

- ◆ Define the problem;
- ◆ Assign responsibility for investigating the problem;
- ◆ Investigate and determine the cause of the problem;
- ◆ Determine a corrective action to eliminate the problem;
- ◆ Assign responsibility for implementing the corrective action; and
- ◆ Verify that the corrective action has eliminated the problem.

Unsatisfactory items or situations may be identified by anyone involved with the project, particularly the analysts, field engineers, technicians, or QA personnel. Depending on the nature of the problem, the corrective action employed may be formal or informal.

To enhance the timeliness of corrective action and thereby reduce the generation of unacceptable data, problems identified by assessment procedures will be resolved at the lowest possible management level. Problems that cannot be resolved at this level will be reported to the Project Manager. The Project Manager will determine the management level at which the problem can best be resolved, and will notify the appropriate manager. Monthly progress reports from the on-site Field Engineer will detail all problems and subsequent resolutions.

In all cases, the occurrence of the problem, the corrective action(s) employed, and verification that the problem has been eliminated will be documented. In addition, if the corrective action results in the preparation of a new standard or calibration solution(s), then a comparison of the new versus the old standard or solution will be performed, and the results supplied with a full QC report as verification that the problem has been eliminated. Corrective action reports that relate to a particular lot analysis will be included in the data package for that lot.

C.5 Demonstration Procedures

C.5.1 Technology Startup

Detailed site designs will be used to purchase appropriate supplies and initiate installation of the test plot. The test plot will be constructed by Shaw's experienced field personnel. To the extent possible, above ground piping and vaults will be used to install the system.

Once constructed, system start-up and operation will commence, as described in Section 3.6.1 and 3.6.2. System operation, including start-up and rebound evaluation, will last approximately 7 months.

C.5.2 Technology Maintenance

Preventive maintenance such as lubrication, source cleaning, detector cleaning, and the frequency of such maintenance are performed according to the procedures delineated in the manufacturer's instrument manual. This will be done for both field equipment, including but not limited to pumps and meters, and laboratory equipment. Chromatographic carrier gas purification traps, injector liners, and injector septa are cleaned or replaced on a regular basis. Precision and accuracy data are examined for trends and excursions beyond control limits to determine evidence of instrument malfunction. Maintenance must be performed when instrument performance begins to degrade as evidenced by the degradation of peak resolution, shift in calibration curves, decreased ion sensitivity, or failure to meet one or more of the quality control criteria.

Instrument maintenance logbooks are maintained at Shaw at all times. The logbook contains a schedule of maintenance, as well as a complete history of past maintenance, both routine and

non-routine. The listing and maintenance frequency of routine maintenance should be provided on a schedule. The record of non-routine maintenance is documented in the maintenance log.

Instrument downtime is minimized by keeping adequate supplies of all expendable items, where expendable means an expected lifetime of less than one year. A list of these items includes: gas tanks, gas line filters, syringes, septa, GC columns and packing, ferrules, printer paper, pump oil, jet separators, open split interfaces, and MS filaments.

C.5.3 Corrective Action Plan

If routine procedures (*e.g.*, equipment calibration), QC sample analysis, or performance and system audits indicate that sampling or analysis systems are unsatisfactory, a corrective action shall be implemented. During performance audits, if performance evaluation (PE) samples do not meet the QA criteria for accuracy and precision specified in Section C.6, analytical work will stop until the problems are identified and resolved. Before work resumes, another blind PE sample must be analyzed, and results must meet the acceptance criteria. Results of all PE samples will be included in the Application Analysis Report. If previously reported data are affected by the situation requiring correction or if the corrective action will impact the project budget or schedule, the action will directly involve the Principal Investigator. ESTCP will be informed of all major performance problems, and will be included in corrective action planning.

Corrective actions are of two kinds:

1. Immediate, to correct or repair non-conforming equipment and systems. The need for such an action will most frequently be identified by the analyst or technician as a result of calibration checks and QC sample analyses. Immediate corrective actions address problems peculiar to a single measurement or lot of samples. Immediate corrective action may include:
 - ◆ Re-run of analyses if sample holding times have not been exceeded;
 - ◆ Instrument re-calibration using freshly prepared standards;
 - ◆ Replacement of reagents or solvents that give unacceptable blank values;
 - ◆ Examination of data calculation errors; and
 - ◆ Replacement of reference standards that have been degraded.

If corrective action indicates that non-conformance is due to problems with laboratory equipment, procedures, and/or calibration, once the problem is resolved, the non-conforming samples will be re-analyzed if holding times have not been exceeded. If holding times have been exceeded, new samples will be collected if the completeness criteria specified in Section C.6 require that these samples be collected. If corrective action indicates that non-conformance of duplicate samples is due to sampling technique, once the problem is corrected, new samples will be

collected if the completeness criteria specified in Section C.6 requires that these samples be collected.

2. Long-term, to eliminate causes of non-conformance. The need for such actions will probably be identified by audits. Long-term corrective actions may address procedural deficiencies or unsatisfactory trends or cycles in data that affect multiple lots of samples. Examples of long-term corrective action may include:

- ◆ Staff training in technical skills or in implementing the QAPP;
- ◆ Rescheduling of laboratory routine to ensure analysis within allowed holding times;
- ◆ Identifying alternate vendors to supply reagents of sufficient purity; and
- ◆ Revision of the QAPP.

For either immediate or long-term corrective action, steps comprising a closed-loop corrective action system will be implemented as follows:

- ◆ Define the problem;
- ◆ Assign responsibility for investigating the problem;
- ◆ Investigate and determine the cause of the problem;
- ◆ Determine a corrective action to eliminate the problem;
- ◆ Assign responsibility for implementing the corrective action; and
- ◆ Verify that the corrective action has eliminated the problem.

Unsatisfactory items or situations may be identified by anyone involved with the project, particularly the analysts, field engineers, technicians, or QA personnel. Depending on the nature of the problem, the corrective action employed may be formal or informal.

To enhance the timeliness of corrective action and thereby reduce the generation of unacceptable data, problems identified by assessment procedures will be resolved at the lowest possible management level. Problems that cannot be resolved at this level will be reported to the Project Manager. The Project Manager will determine the management level at which the problem can best be resolved, and will notify the appropriate manager. Monthly progress reports from the on-site Field Engineer will detail all problems and subsequent resolutions.

In all cases, the occurrence of the problem, the corrective action(s) employed, and verification that the problem has been eliminated will be documented. In addition, if the corrective action results in the preparation of a new standard or calibration solution(s), then a comparison of the

new versus the old standard or solution will be performed, and the results supplied with a full QC report as verification that the problem has been eliminated. Corrective action reports that relate to a particular lot analysis will be included in the data package for that lot.

C.6 Calculation of Data Quality Indicators

C.6.1 Quantitative QA Objectives: Accuracy, Precision, Completeness, and Method-Detection Limit

Accuracy: Accuracy indicates the degree of bias in a measurement system, and is the degree of agreement of a measurement with an accepted reference value. Sample measurement uses laboratory equipment. The percent recovery of matrix spike/matrix spike duplicate samples measures the accuracy of the laboratory equipment, calculated according to the following equation:

$$\%R = (C_1 - C_o) / C_t * 100 \quad \text{(Equation C.1)}$$

Where: %R = percent recovery

C_1 = measured concentration; spiked sample aliquot

C_o = measured concentration, unspiked sample aliquot

C_t = actual concentration of spike added

Precision: Precision is the reproducibility of measurements under a given set of conditions. For large data sets, precision is expressed as the variability of a group of measurements compared to their average value. Variability may be attributable to field practices or chemical analyses. Precision is expressed as relative percentage difference, determined using Equation D.2 below.

Precision is measured by calculating the Relative Percent Difference (RPD) of laboratory duplicates, matrix spike/matrix spike duplicate sample pairs, surrogate spikes, and field duplicate samples.

$$RPD = (C_1 - C_2) * 100 / ((C_1 + C_2) / 2) \quad \text{(Equation C.2)}$$

Where: RPD = relative percent difference

C_1 = the larger of the two observed values

C_2 = the smaller of the two observed values

Completeness: Completeness is defined as the qualified and estimated results, and represents the results usable for data interpretation and decision making. Results qualified as rejected or unusable, or that were not reported because of sample loss, breakage, or analytical error, negatively influence

completeness and are subtracted from the total number of results to calculate completeness. Percent completeness is determined by using the following equation:

$$\% \text{ Completeness} = (\text{VDP} / \text{TDP}) * 100 \quad (\text{Equation C.3})$$

Where: VDP = number of valid data points
TDP = number of total samples obtained

Completeness will be calculated for each method and matrix during the demonstration. The completeness objective for all validated data is 95 percent.

Method-Detection Limits. Method detection limits (MDLs) and practical quantitation limits (PQLs) must be distinguished for proper understanding and data use. The MDL is the minimum analyte concentration that can be measured and reported with a 99% confidence that the concentration is greater than zero. The PQL represents the concentration of an analyte that can be routinely measured in the sampled matrix with “reasonable” confidence in both identification and quantitation. PQLs are often based on analytical judgement and experience, and should be verifiable by having the lowest non-zero calibration standard or calibration check sample concentration at or near the PQL. Table C.2 presents the MDL range and PQLs for the analytical methods to be used during the demonstration. The limits shown in Table C.2 assume optimal conditions. MDLs may be higher, particularly in contaminant mixtures, due to dilution limits required for analysis. Concentrations detected below the PQL will be appropriately flagged. These flagged concentrations will be considered below the practical quantification limits of the analytical method used, but will not negatively impact completeness.

The evaluation of method detection limits (MDLs) will be in accordance with the procedures outlined in Appendix B to Part 136 “Definition and Procedures for the Determination of Method Detection Limit - Revision 1.1,” 40 Code of Federal Regulations (CFR) 136, 1984. Method quantification limits and detection limits will be reported for each sample set of validated data. The calculated MDL shall be equal to or less than the Required Detection Level (RDL). If the calculated MDL is lower than the level the laboratory deems practical, the calculated MDL may be raised to a higher level. In no instance shall the reported MDL be below the calculated level. The method documentation shall include both the calculated MDL and the request for an increased reportable MDL. Raising the reportable MDL to a higher level will be contingent upon approval by Shaw’s Principal Investigator and ESTCP.

C.6.2 Qualitative QA Objectives: Comparability and Representativeness

Comparability refers to the confidence with which one data set can be compared to another. Comparability is essential for the evaluation of technology performance compared to that of similar technologies. Comparable data will be generated by following standard SW-846 and

U.S. EPA protocols for all laboratory analyses, and manufacturers' instructions for all on-site test kits and meters.

Representativeness is a measure of the degree to which data accurately and precisely represent the conditions of the parameter represented by the data. Collected samples must be representative of the matrix characteristics and contamination concentrations. Representativeness is affected by errors introduced through the sampling process, field contamination, preservation, handling, sample preparation, and analysis.

Representativeness will be ensured through the following practices:

- ◆ selecting the necessary number of samples, sample locations, and sampling procedures that will depict as accurately and precisely as possible the matrix and conditions measured;
- ◆ developing protocols for storage, preservation, and transport that preserve the representativeness of the collected samples;
- ◆ using documentation methods to ensure that protocols have been followed and that samples are properly identified to maintain integrity and traceability; and
- ◆ using standard, well-documented analytical procedures to ensure consistent, representative data.

While none of these practices can be quantified as a measure of representativeness, QC samples will be collected to indicate factors that may affect representativeness. The QC samples to be used for this purpose are as follows:

- ◆ field duplicates (field split samples and collection duplicates) to indicate variations caused by sampling techniques; and
- ◆ field blanks to indicate contamination introduced through ambient conditions.

C.7 Performance and System Audits

Two types of audits will be conducted during the electron donor biostimulation demonstration; (1) external audits of the independent laboratory (for water analyses) conducted periodically by Shaw personnel, and (2) internal audits of Shaw's laboratory and field activities conducted by Shaw personnel not directly associated with the project. During auditing visits by Shaw personnel, the independent laboratory will make available whatever records and personnel are necessary to assess the effective implementation of this QAPP. The individuals responsible for performing QA audits are listed in Section C.2.

The internal audit program will be conducted monthly during the demonstration, and will include both performance and system audits as independent checks of the quality of data obtained from the New Jersey-based laboratory analyses in addition to field audits conducted during sampling and field screening (analytical kit analyses) activities. Every effort will be made to have the audit assess the measurement process in normal operation. The Shaw external performance and system audit program will include checks of the quality of data obtained from the independent laboratory. The external audits will be conducted every six weeks.

Performance Audits. The analysis and data-gathering segments of the electron donor biostimulation demonstration will be checked during performance audits, which may include submitting blind performance evaluation (PE) samples to the laboratories, as necessary throughout the course of the project, in order to evaluate the effectiveness of each laboratory's QC program. Results of the PE samples will be recorded and compared with routinely-obtained data. Reference standards may be randomly dispersed among samples awaiting analysis to check the analytical procedures. At a minimum, each audit will include an analysis of the data handling and reporting procedures of the laboratories by performing a complete check of one of the data packages submitted by each laboratory by using the original raw data and performing all necessary calculations by hand. In addition, the audit will include a review of all QA/QC data attained up through the date of the audit. Formal Performance Audit Reports, performed by the Shaw QA Manager and/or Project Manager, will be distributed to the Shaw Principal Investigator.

System Audits. An on-site system audit is a qualitative review that checks that the QC measures outlined in the QAPP are in use; it is a general overview of the whole quality system for the project. The Shaw QA Manager and/or Project Manager will conduct a system audit on site at the start of the project and periodically throughout the program. As with the Performance Audits, a formal System Audit Report will be submitted to the Principal Investigator.

C.8 Quality Assurance Reports

To provide information to the client project manager and Shaw project manager on the performance of the QA program for this project, the QA officer will meet with the project manager and laboratory manager on a monthly basis to review quality control data summary, documentation, and other pertinent information.

A QA report on project performance will be presented to the laboratory manager. Facts will be presented in summary forms and charts, where applicable. The quality facts to be reported are:

- ◆ percentage duplication or replication of determinations
- ◆ results of intralaboratory precision and accuracy
- ◆ results of performance and system audits

- ◆ data quality assessments
- ◆ significant QA problems and recommended solutions.

In addition to the internal QA reports to Shaw management, the results of the QA/QC activities will also be reported to the Fort Dix site project manager for the project.

C.9 Data Format

All data generated during the performance of the demonstration will be recorded daily, promptly and legibly in ink in field notebooks. All date entries will include the date of entry and name of person completing the log. All changes will be struck-through with a single line so as not to obscure the original entry. The reason for the change will be noted, dated and initialed by the person making the log.

While this document attempts to provide a comprehensive plan for completing the tasks associated with the demonstration, it is noted that unanticipated changes or deviations may occur. Any changes or deviations will be noted in the field logbook and included in the final report. All data will be accurately verified and recorded according to the provisions of the Sampling and Quality Assurance Plans. All paper and electronic files will be maintained and stored at the Shaw facilities in Lawrenceville, New Jersey until project completion.

C.10 Data Storage and Archiving Procedures

All raw data, documentation, records, test plans, analyses, reports and correspondence generated as a result of this demonstration will be properly stored and archived in paper and electronic file formats as appropriate. Project data and analyses will be stored in an organized fashion to facilitate retrieval in an expedient fashion. Paper files will be maintained and stored so as to minimize deterioration during and after the project is complete. Electronic files associated with the project will be automatically backed-up on a monthly basis during the active phase of the project. Electronic files will be archived on CD-ROM upon completion of the project to ensure data integrity.

APPENDIX I
Chlorinated Ethenes, Ethene and DHC Trend Graphs

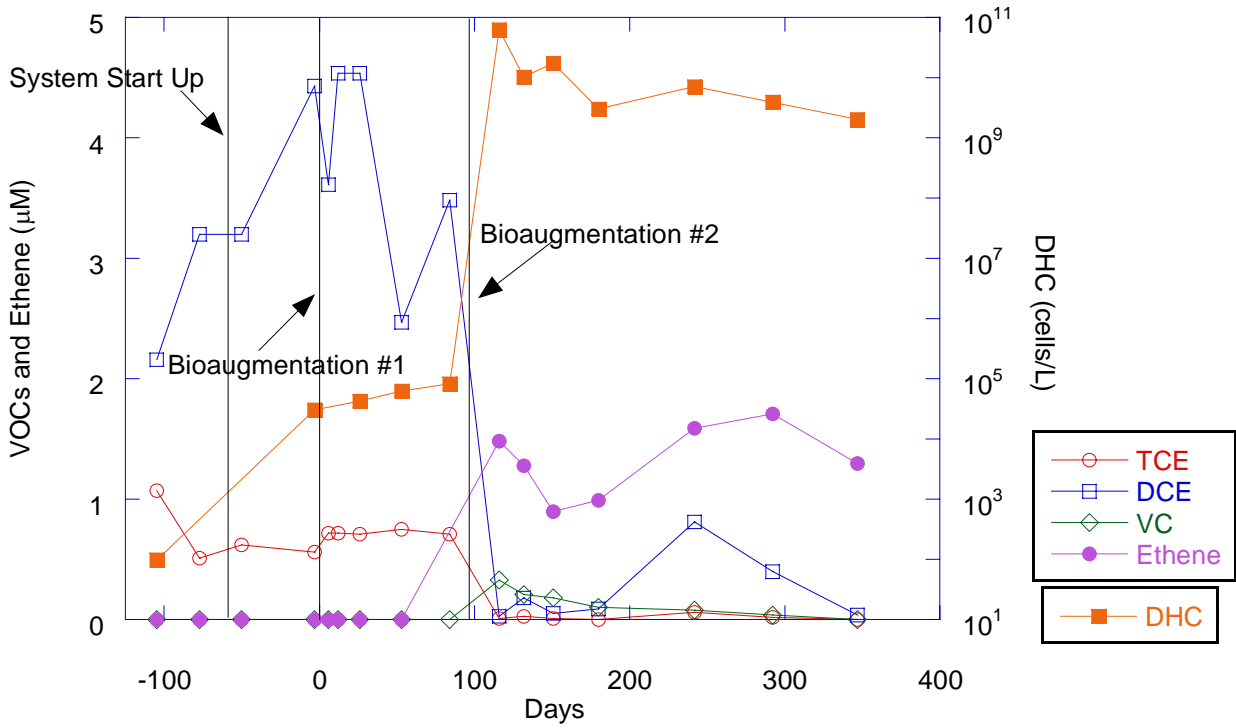

Figure I-1. Chlorinated Ethenes, Ethene, and DHC: Monitoring Well BMW-1 (Loop 1)

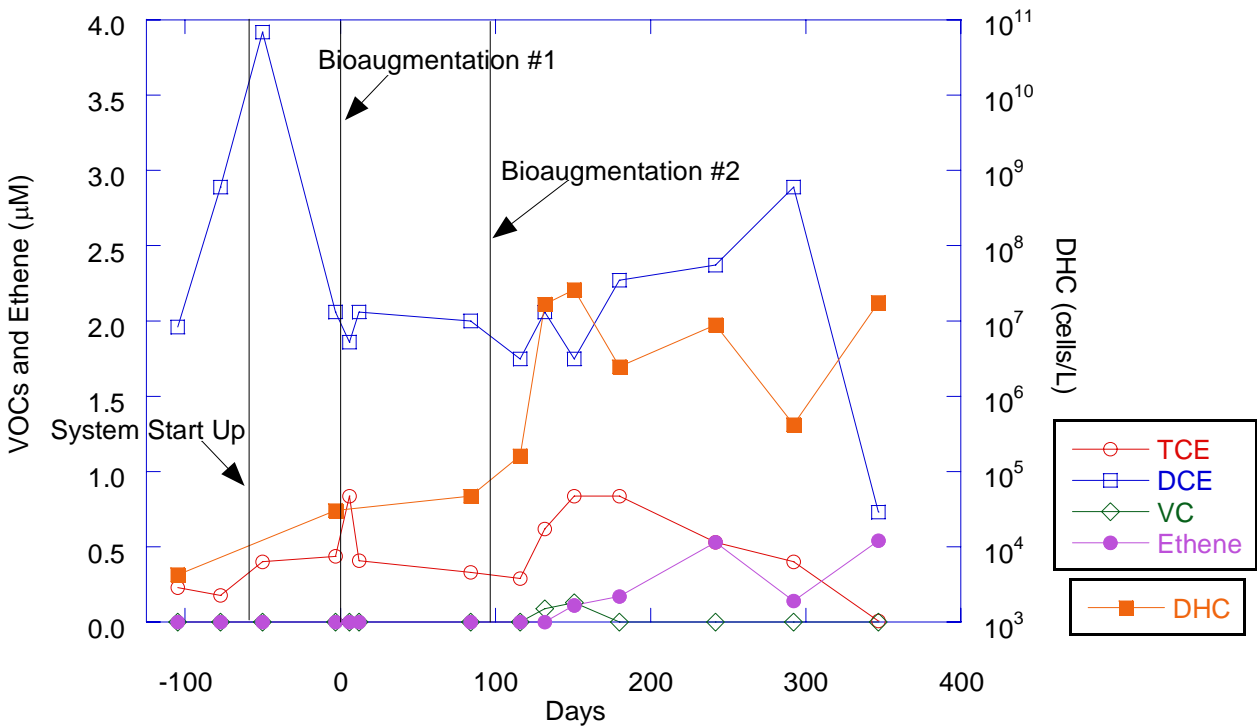

Figure I-2. Chlorinated Ethenes, Ethene, and DHC: Monitoring Well BMW-2 (Loop 1)

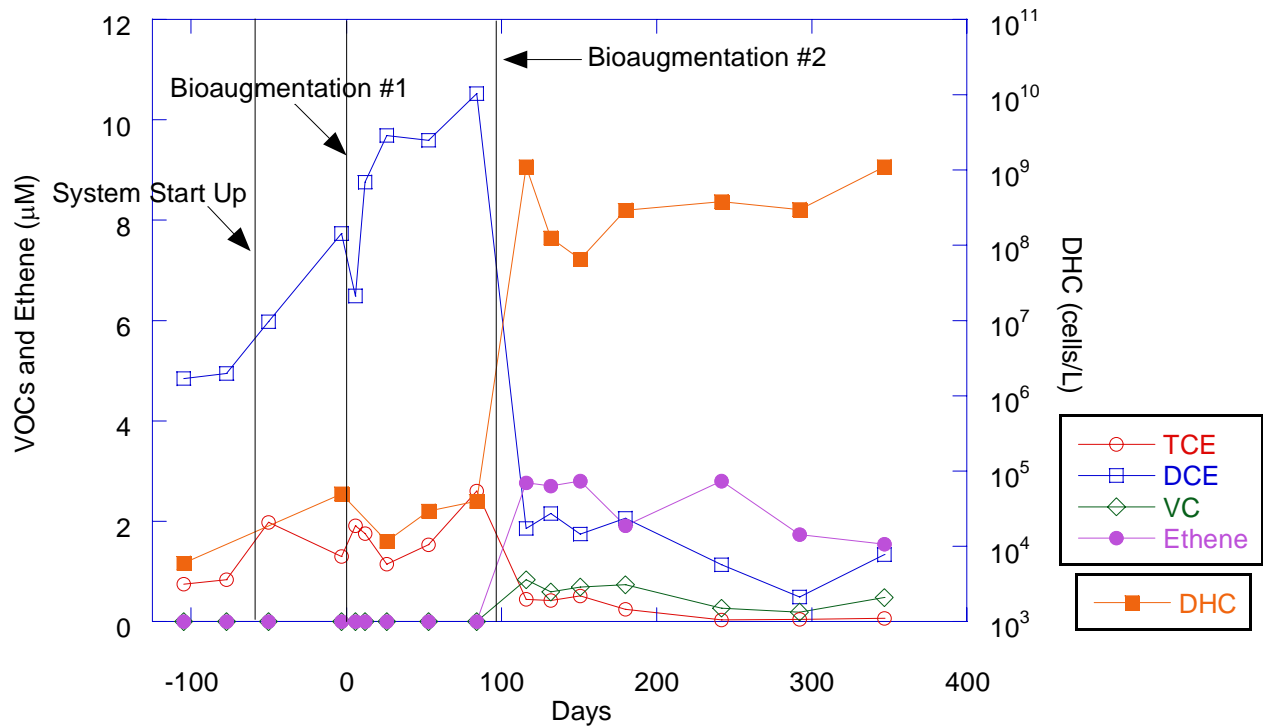

Figure I-3. Chlorinated Ethenes, Ethene, and DHC: Monitoring Well BMW-3 (Loop 2)

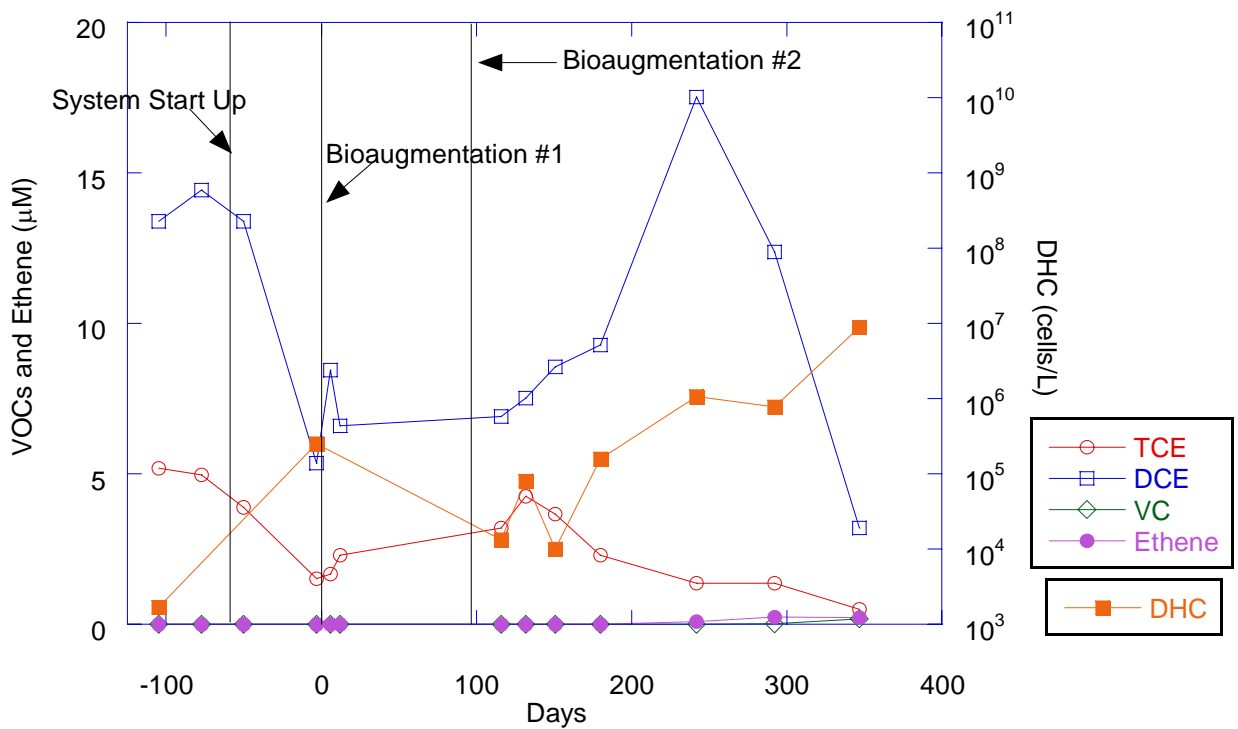

Figure I-4. Chlorinated Ethenes, Ethene, and DHC: Monitoring Well BMW-4 (Loop 2)

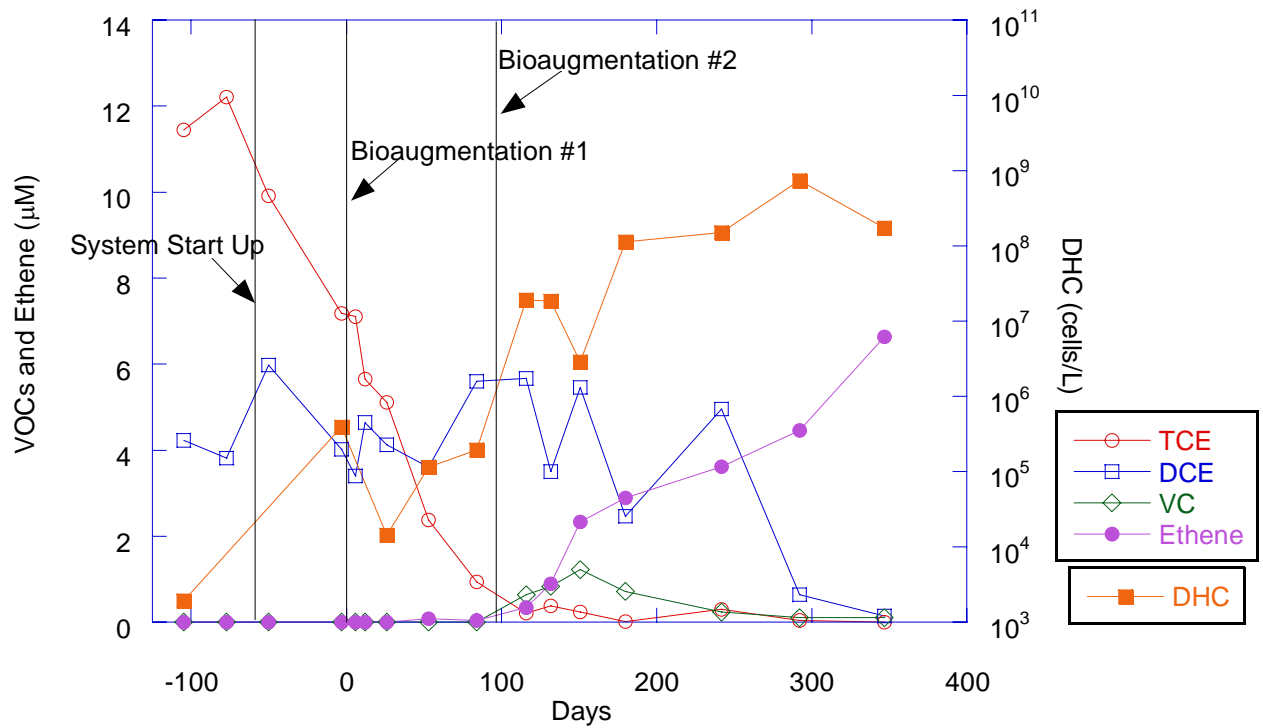

Figure I-5. Chlorinated Ethenes, Ethene, and DHC: Monitoring Well BMW-5 (Loop 3)

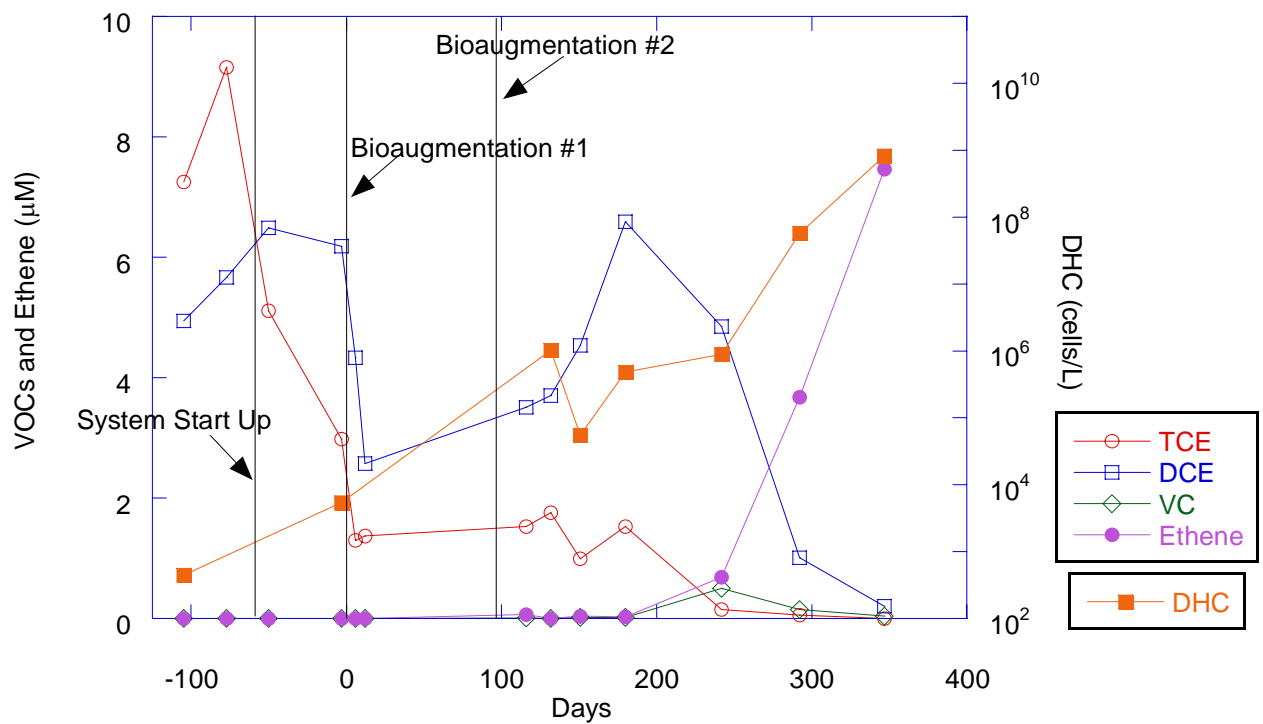

Figure I-6. Chlorinated Ethenes, Ethene, and DHC: Monitoring Well BMW-6 (Loop 3)

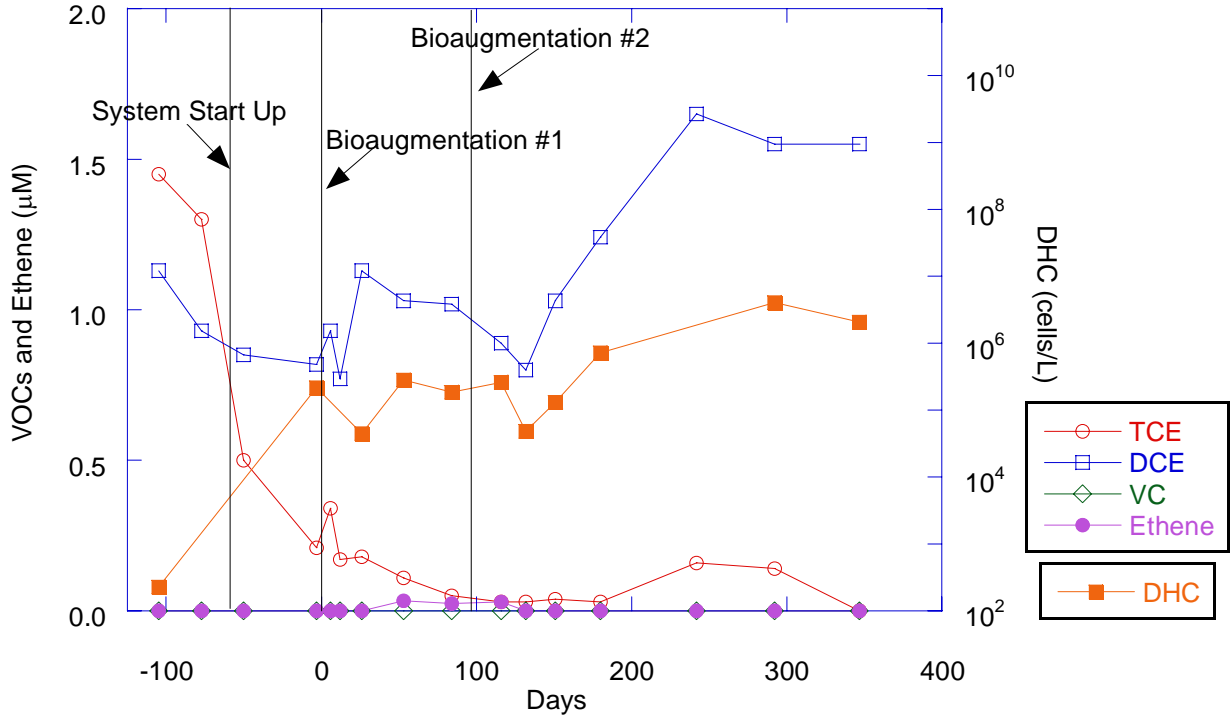

Figure I-7. Chlorinated Ethenes, Ethene, and DHC: Monitoring Well BMW-7 (Loop 4)

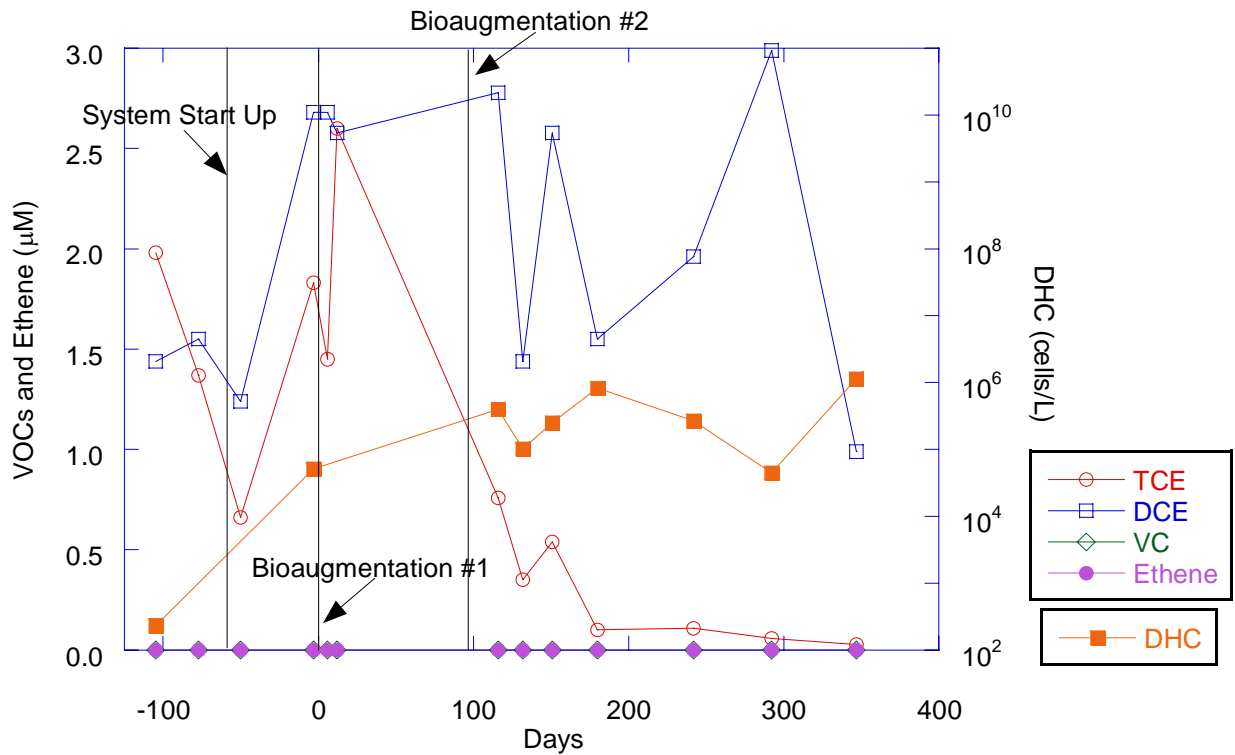

Figure I-8. Chlorinated Ethenes, Ethene, and DHC: Monitoring Well BMW-8 (Loop 4)

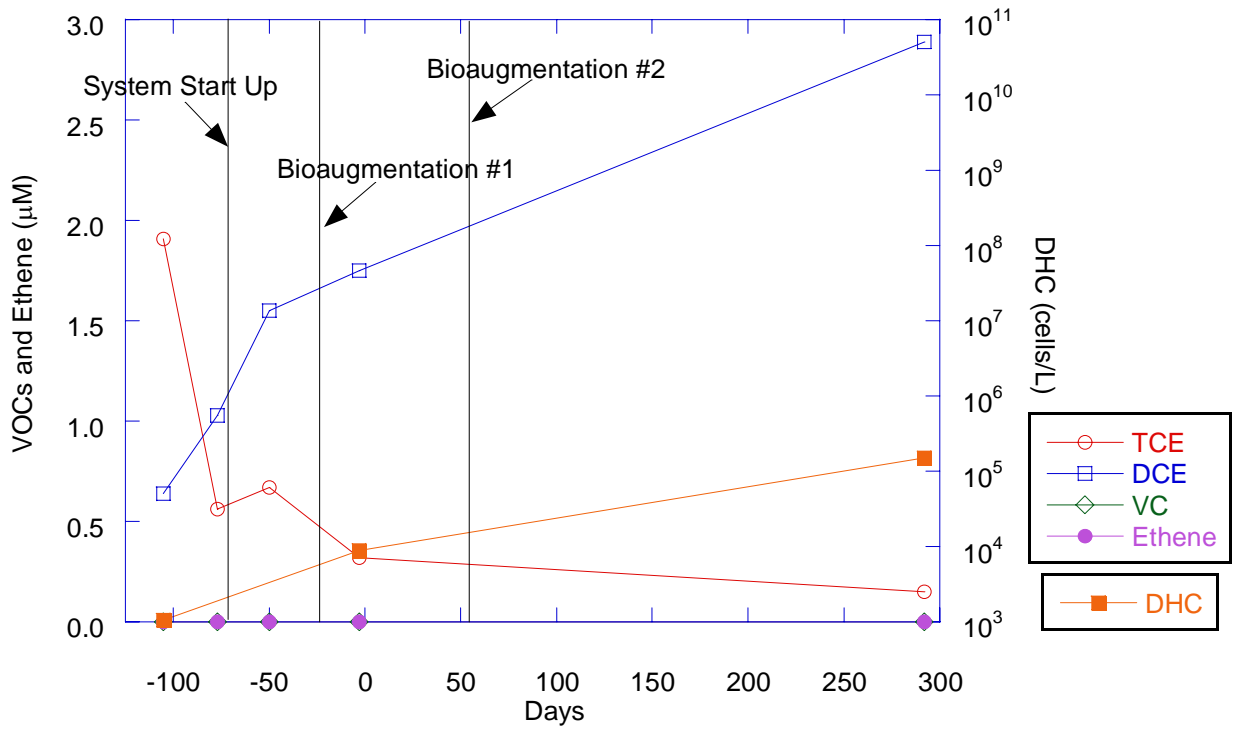

Figure I-9. Chlorinated Ethenes, Ethene, and DHC: Monitoring Well BMW-9 (Loop 1)

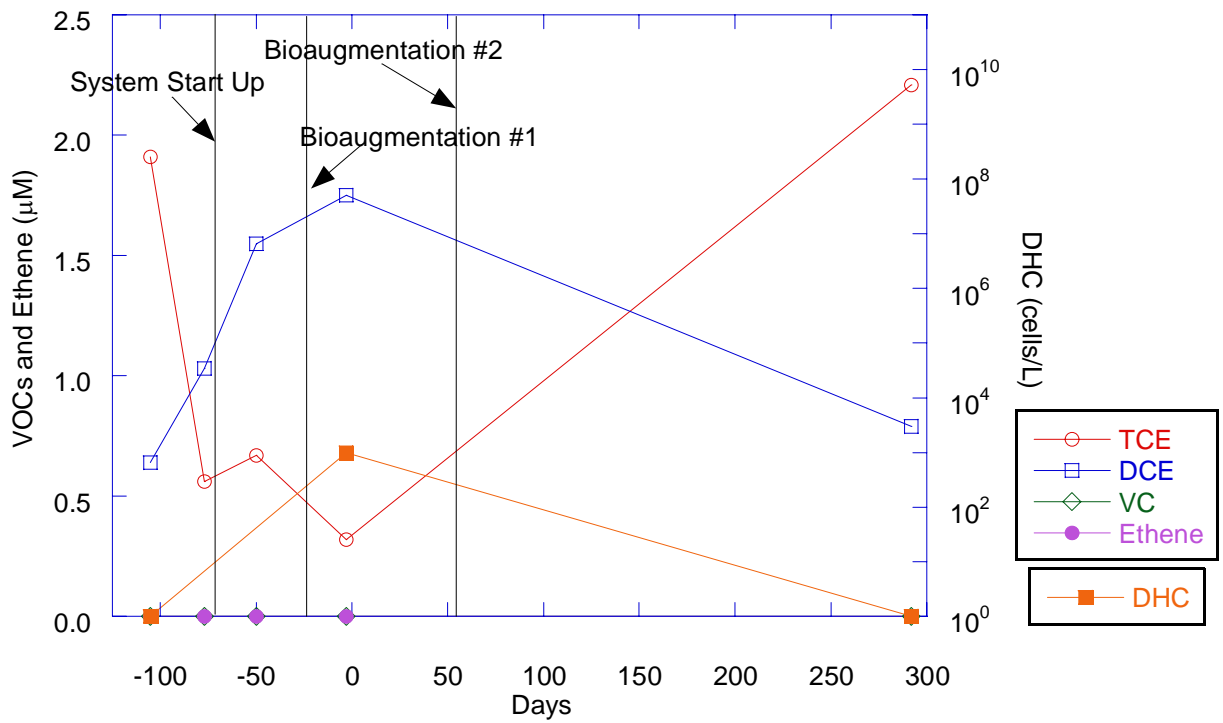

Figure I-10. Chlorinated Ethenes, Ethene, and DHC: Monitoring Well BMW-10 (Loop 1)

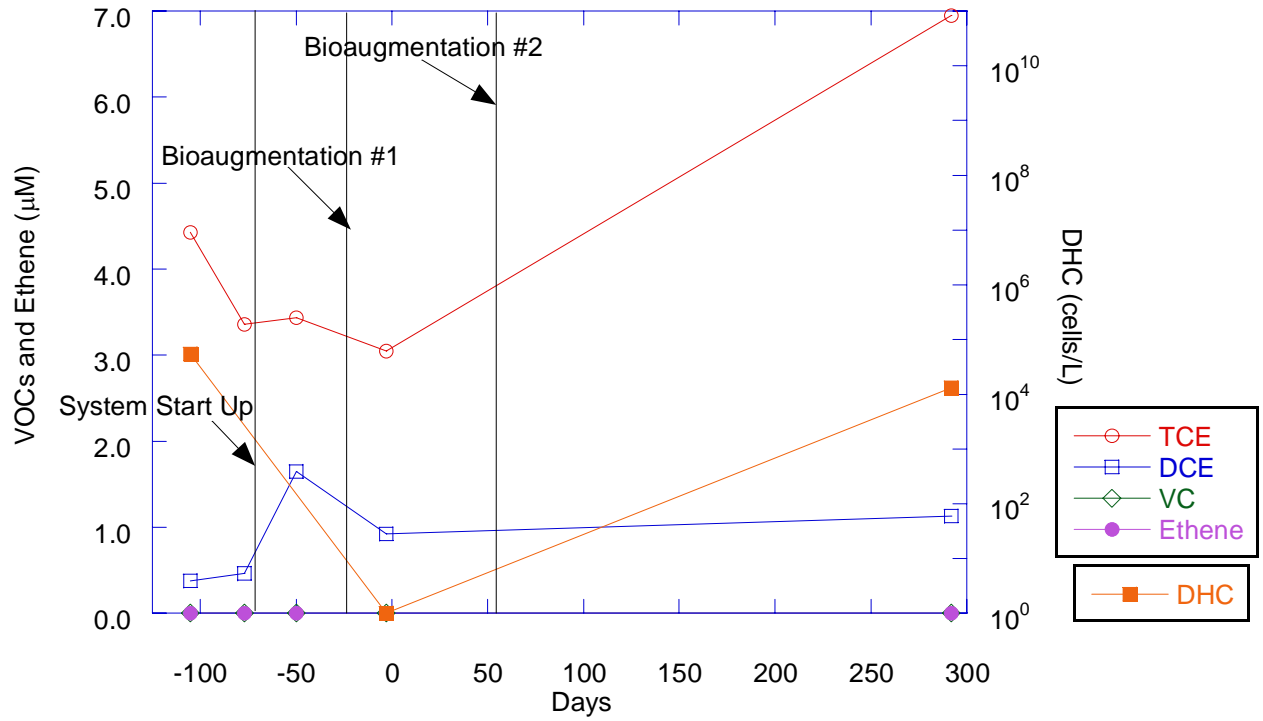

Figure I-11. Chlorinated Ethenes, Ethene, and DHC: Monitoring Well BMW-11 (Loops 1 & 2)

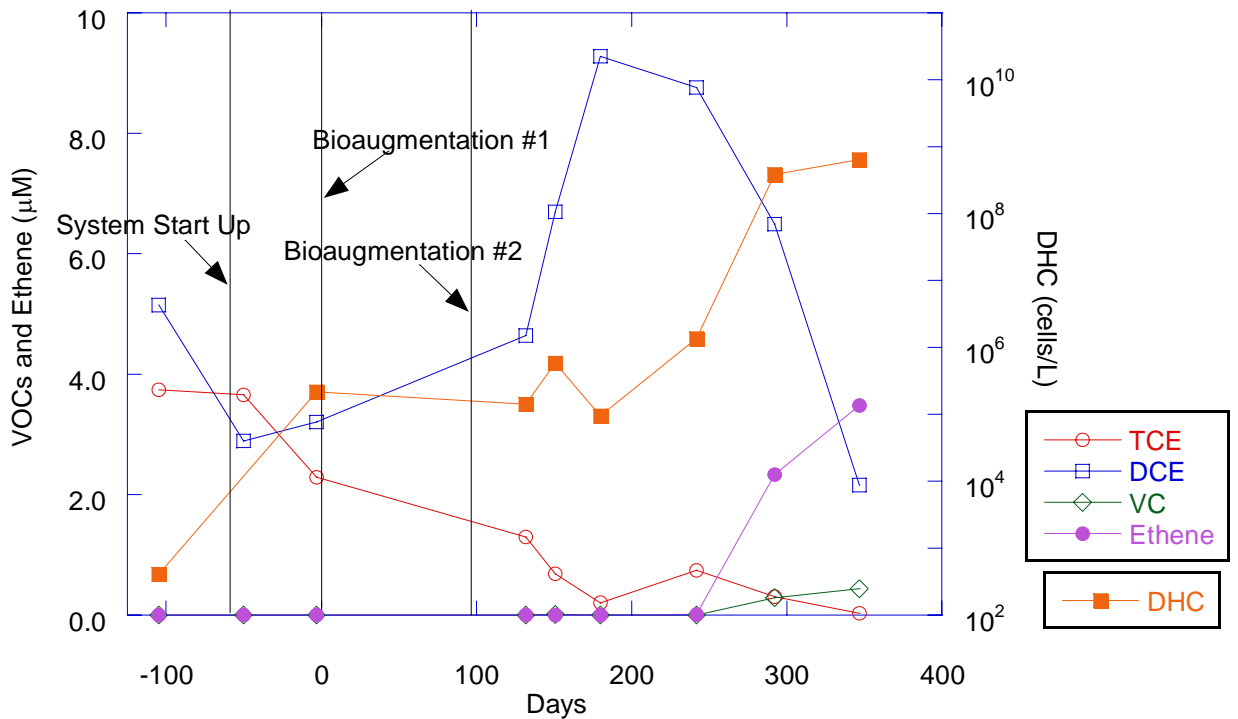

Figure I-12. Chlorinated Ethenes, Ethene, and DHC: Monitoring Well PZ-1 (Loop 3)

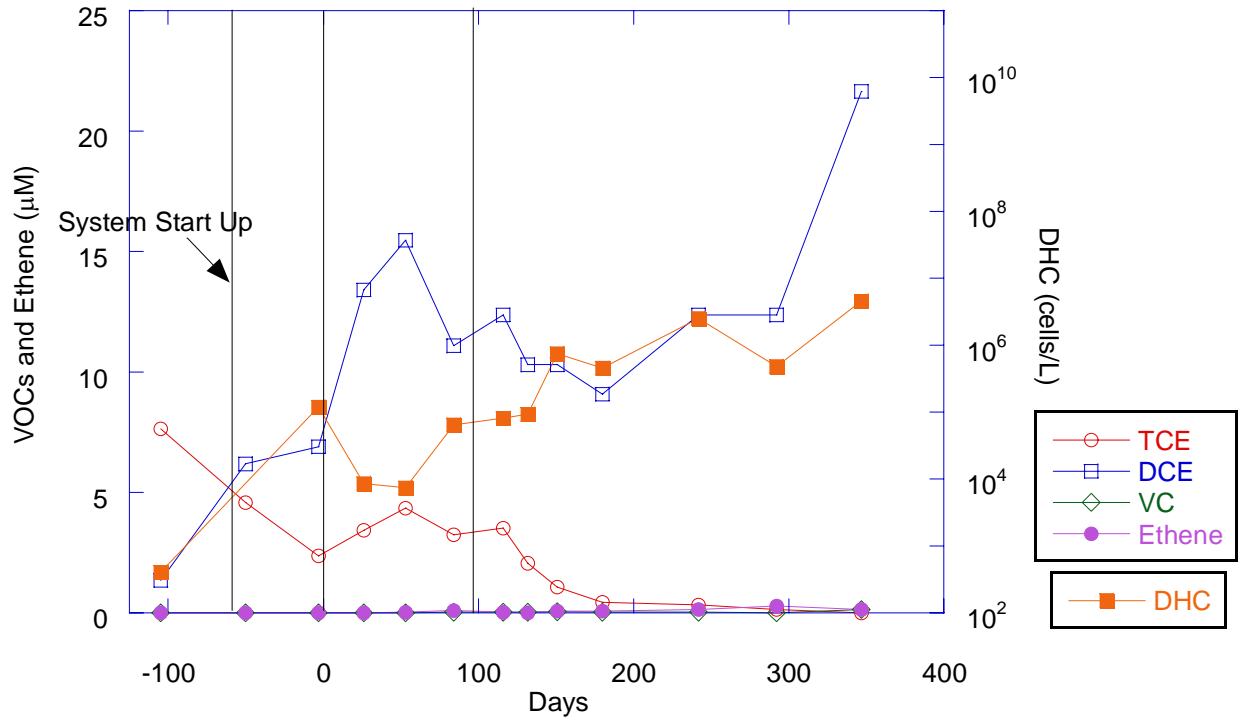

Figure I-13. Chlorinated Ethenes, Ethene, and DHC: Monitoring Well PZ-2 (Loop 3)

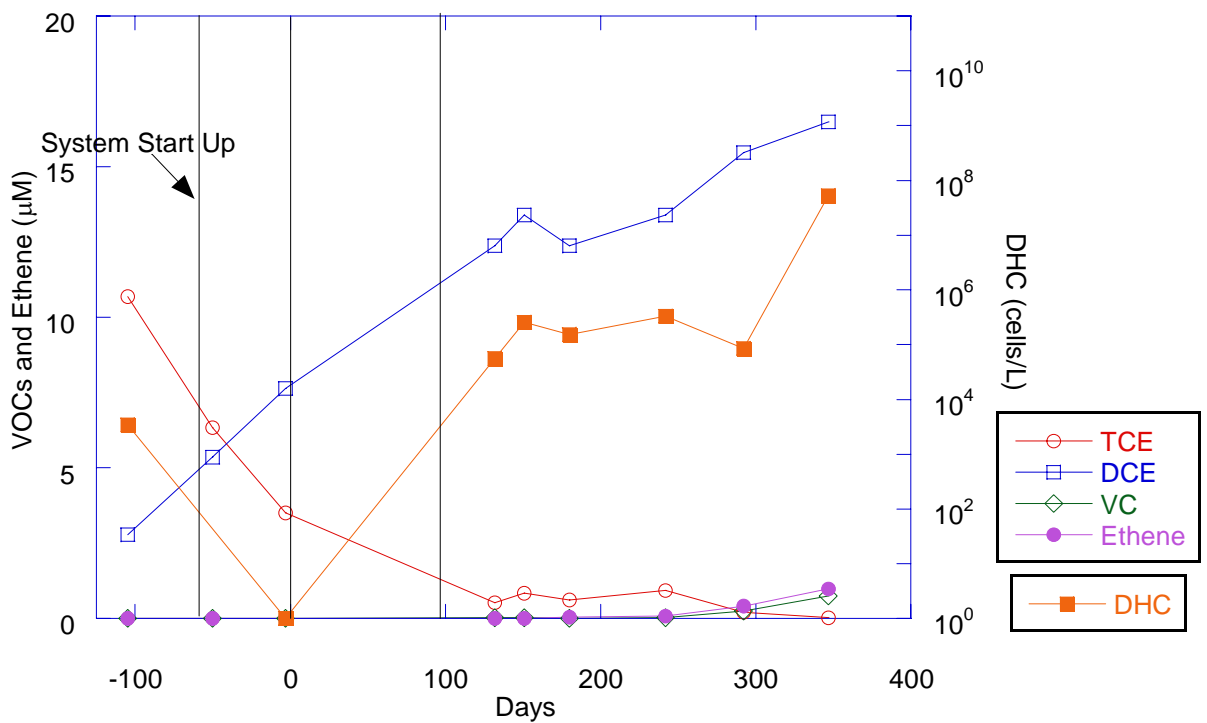

Figure I-14. Chlorinated Ethenes and Ethene: Monitoring Well MAG-113P (Loop 3)

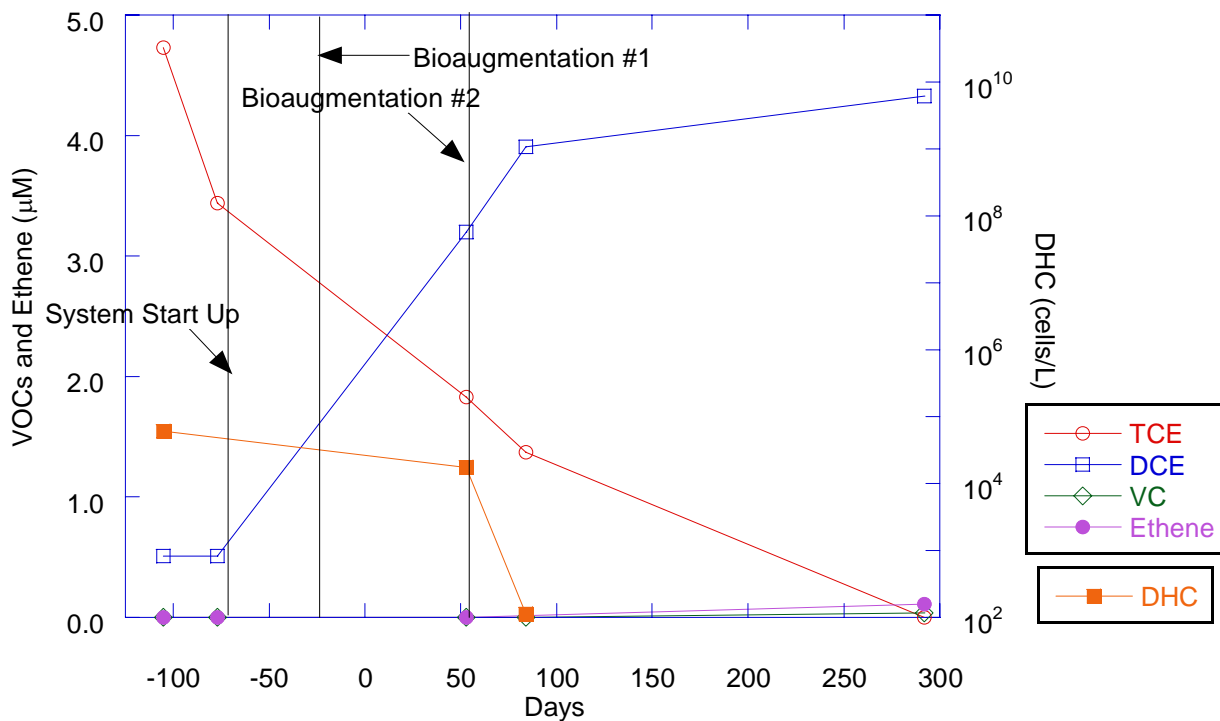

Figure I-15. Chlorinated Ethenes, Ethene, and DHC: Injection Well IW-1 (Loop 1)

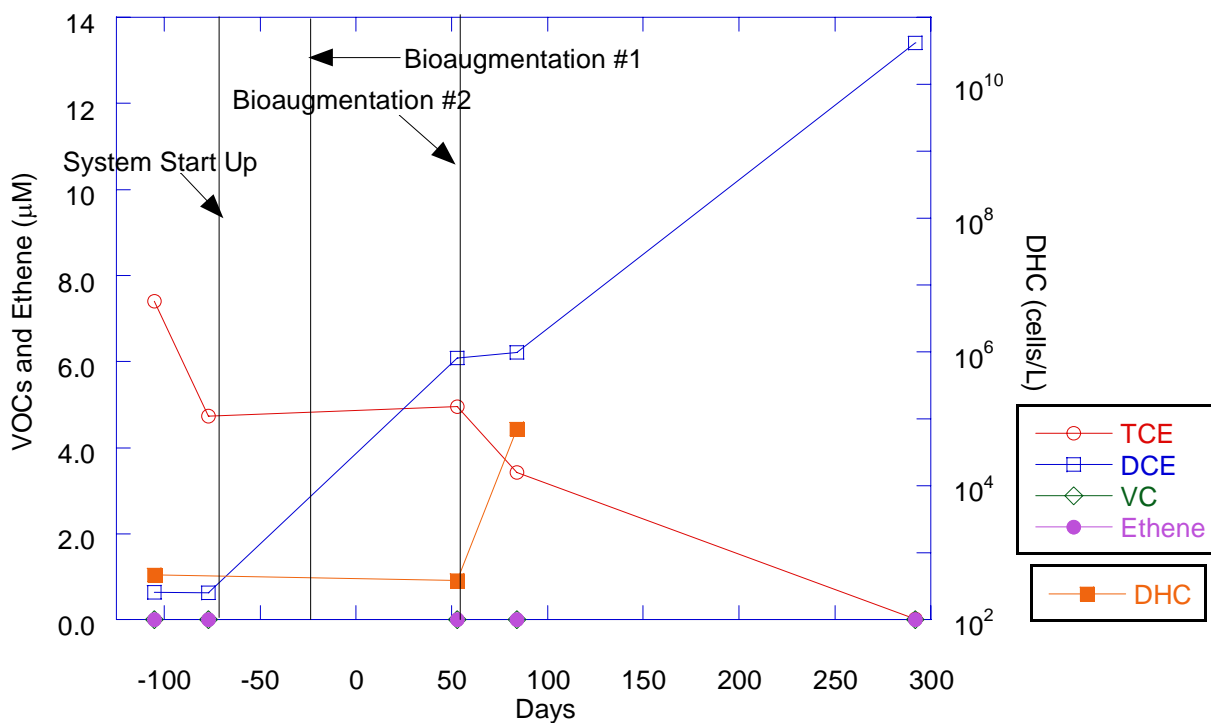

Figure I-16. Chlorinated Ethenes, Ethene, and DHC: Injection Well IW-2 (Loop 2)

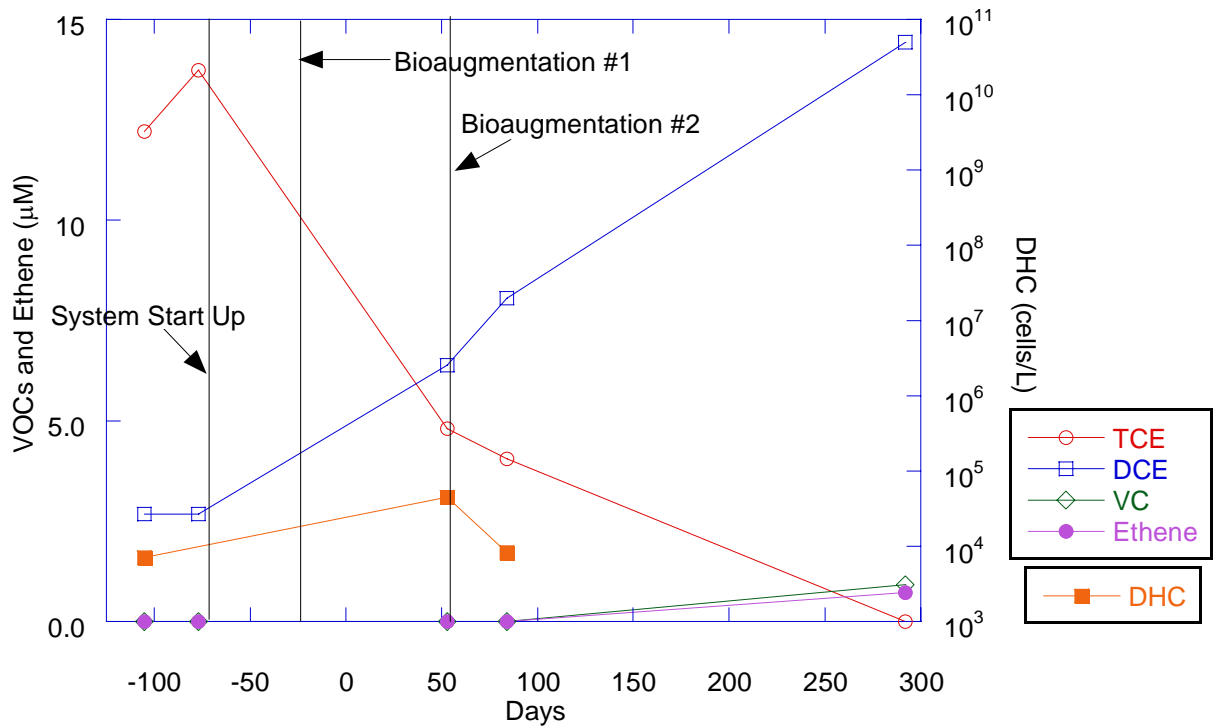

Figure I-17. Chlorinated Ethenes, Ethene, and DHC: Injection Well IW-3 (Loop 3)

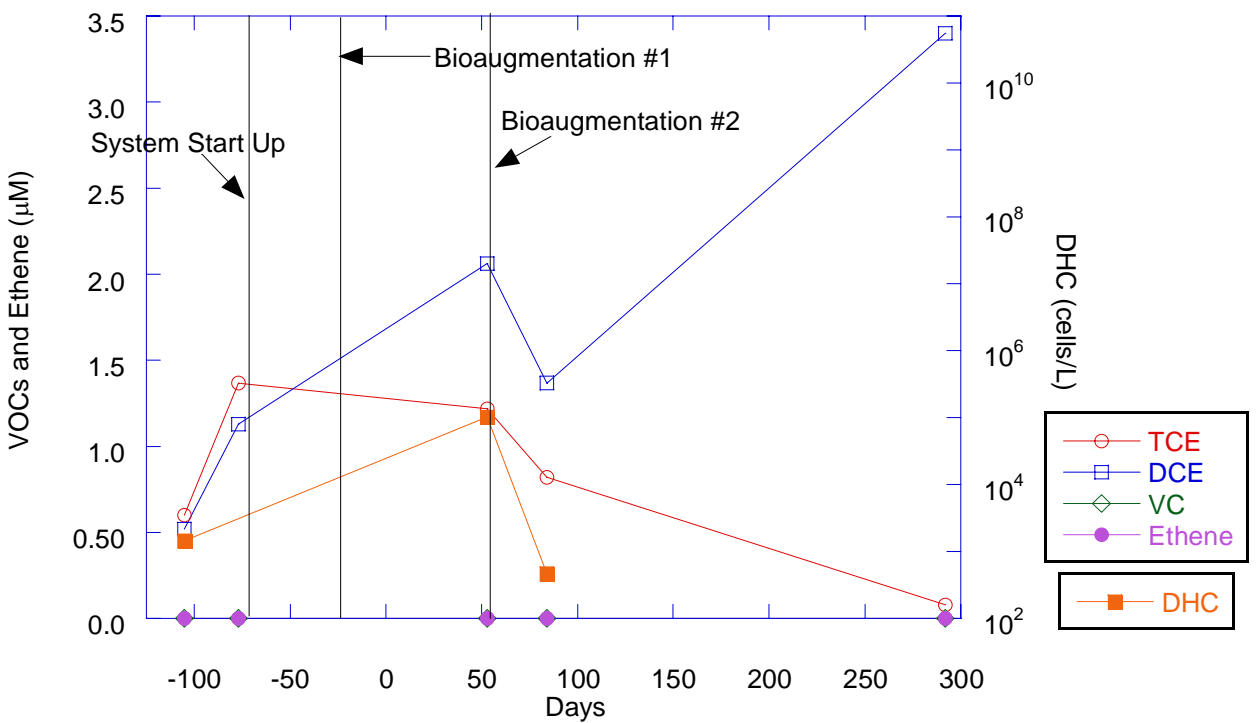

Figure I-18. Chlorinated Ethenes, Ethene, and DHC: Injection Well IW-4 (Loop 4)

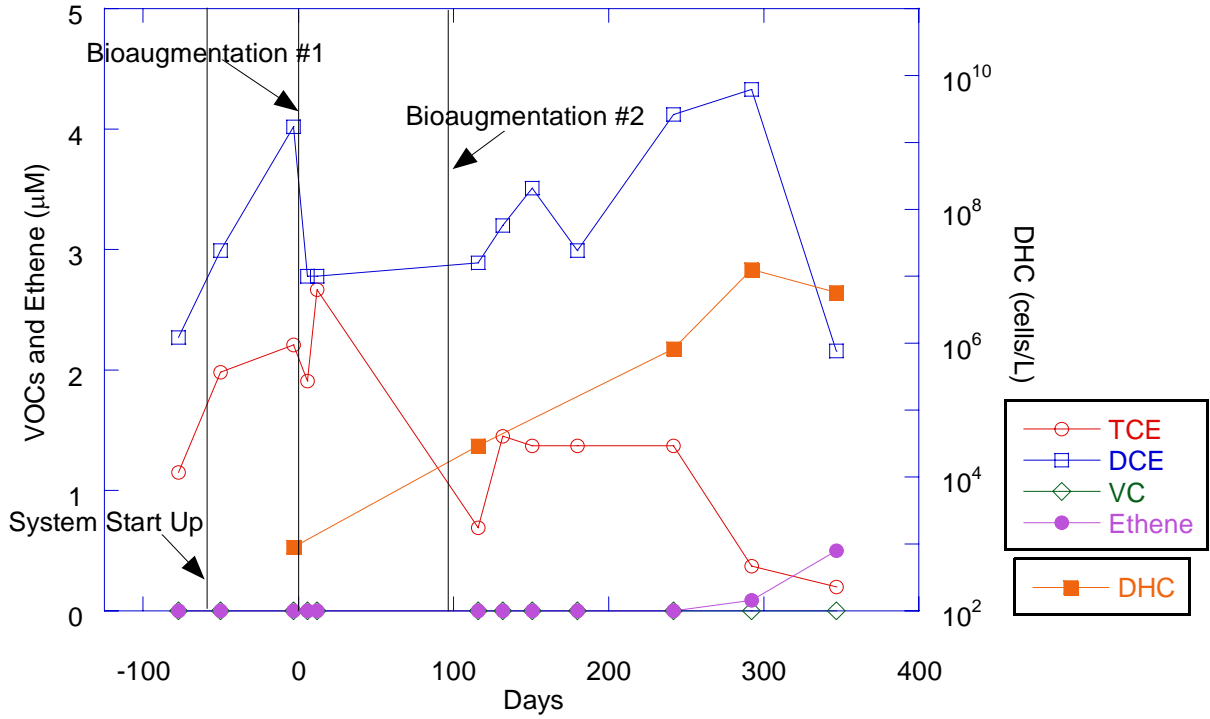

Figure I-19. Chlorinated Ethenes and Ethene: Extraction Well EX-1 (Loop 1)

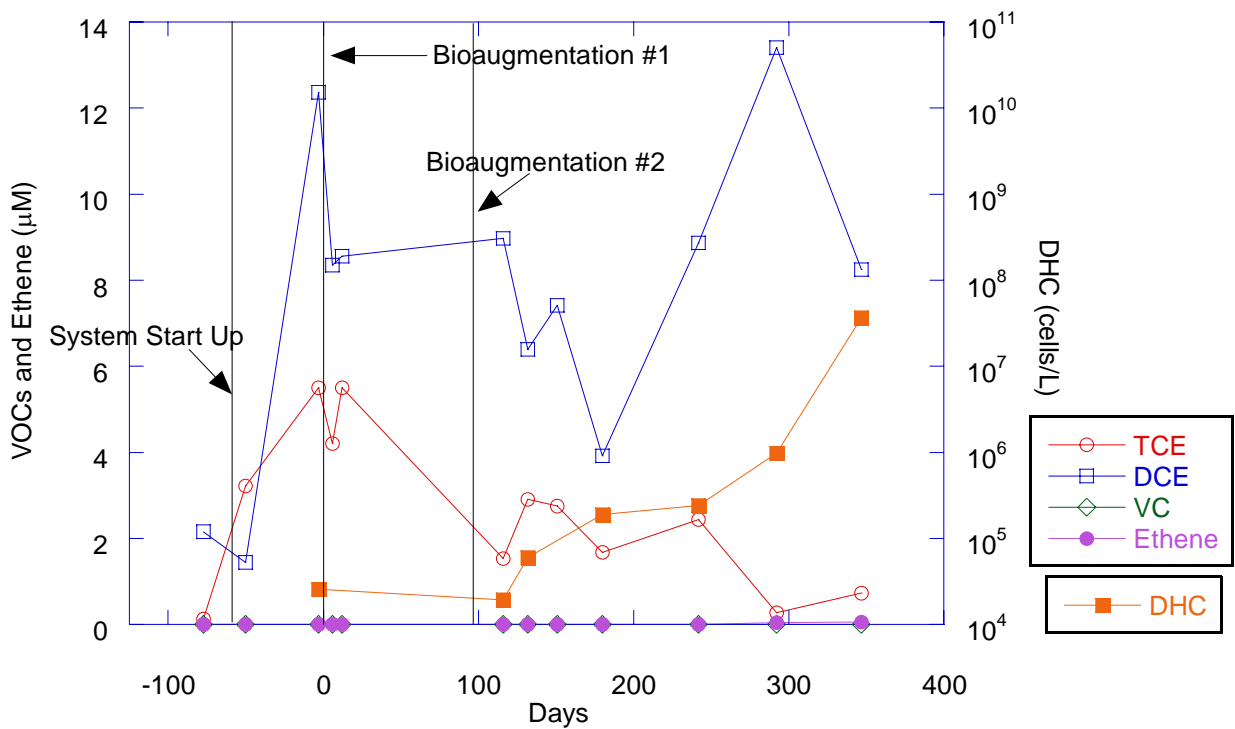

Figure I-20. Chlorinated Ethenes, Ethene, and DHC: Extraction Well EX-2 (Loop 2)

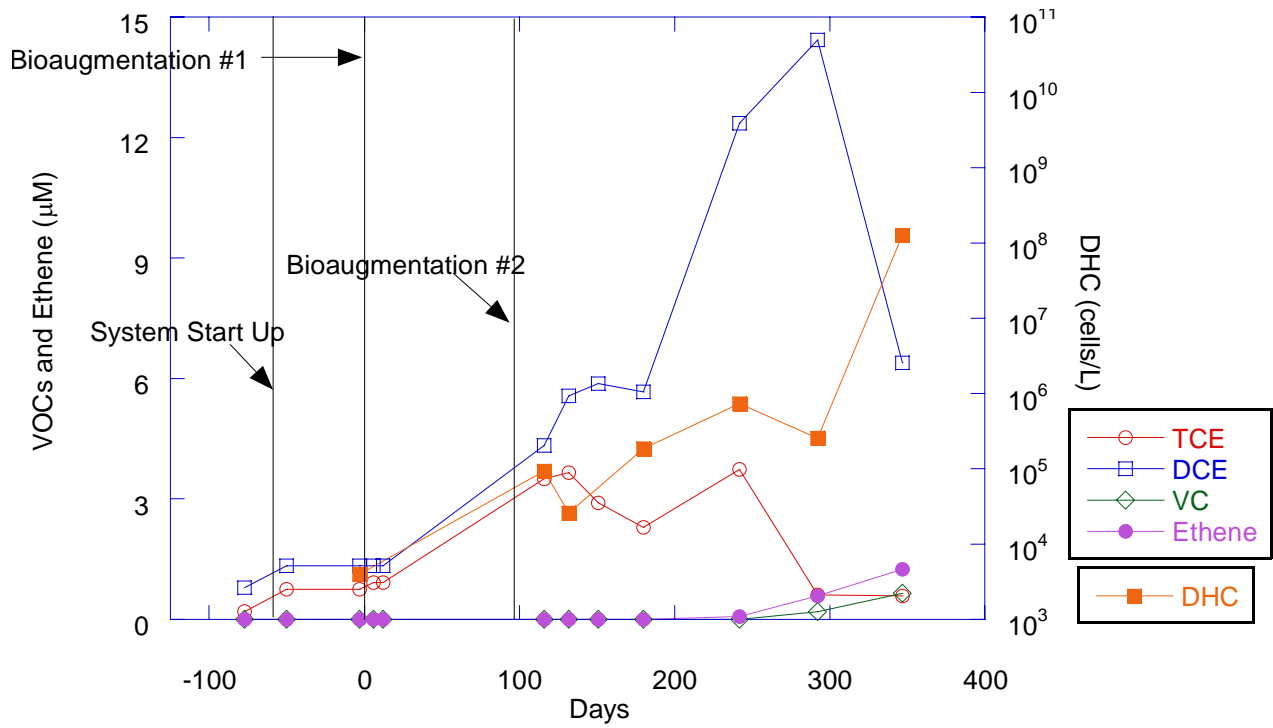

Figure I-21. Chlorinated Ethenes, Ethene, and DHC: Extraction Well EX-3 (Loop 3)

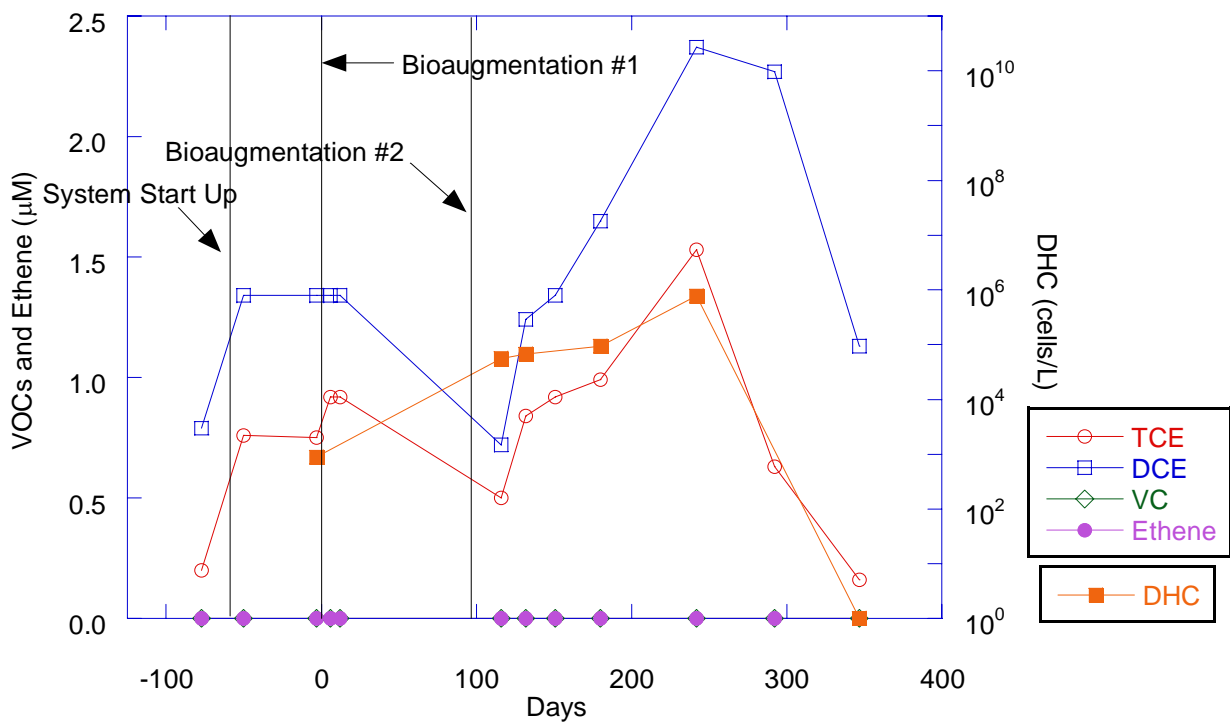

Figure I-22. Chlorinated Ethenes, Ethene, and DHC: Extraction Well EX-4 (Loop 4)

APPENDIX J
Summary of DHC Replicate Sample Data:
Georgia Institute of Technology

Data Summary Fort Dix Jan 2008
Gene copies per liter of GW

		Bac		Dhc		BvcA		VcrA		TceA		DNA conc (ng/l Vol. filtered)	
		average/L	stdev/L	average/L	stdev/L	average/L	stdev/L	average/L	stdev/L	average/L	stdev/L		
21-Jan & 22-Jan samples	BMW-1	2.68E+09	3.56E+08	6.32E+03	3.37E+03			2.98E+03	1.24E+03	3.81E+03	2.98E+03	4.9	100
	BMW-3	6.27E+08	8.31E+07	2.13E+04	3.66E+03			9.66E+03	3.54E+03	1.90E+04	2.97E+03	4.5	35
	BMW-5	9.52E+09	1.72E+09	1.73E+05	8.54E+04			3.73E+04	2.47E+03	1.15E+05	6.87E+04	4.9	10
	BMW-5X	6.74E+09	6.31E+08	1.13E+05	3.52E+04			6.56E+04	1.05E+04	1.06E+05	2.17E+04	5.0	10
	MAG4	1.52E+09	1.17E+08	6.60E+02	1.77E+02			4.22E+02	2.80E+01	1.25E+03	6.42E+02	10.7	1100
30-Jan & 31-Jan samples	BMW-1	4.38E+09	4.16E+08	2.06E+04	3.42E+03			9.69E+03	6.18E+02	1.48E+04	5.28E+03	4.3	50
	BMW-3	5.30E+08	3.39E+07	2.91E+04	7.86E+03			3.83E+03	2.44E+03	1.62E+03	7.64E+02	6.1	35
	BMW-5	1.91E+09	2.79E+08	7.37E+04	1.13E+04			2.66E+04	1.08E+04	4.56E+04	1.38E+04	4.9	15
	BMW-5X	1.43E+09	7.05E+07	1.24E+05	8.12E+03			2.61E+04	3.70E+03	4.60E+04	1.27E+04	5.0	15
	BMW-7	4.70E+08	5.29E+07	4.90E+04	9.25E+03			1.22E+04	4.42E+03	2.99E+04	5.19E+03	5.4	22
19 Feb samples	BMW-1	5.44E+08	9.20E+07	8.33E+04	1.07E+04			1.30E+05	1.26E+04	8.74E+04	3.93E+04	5.9	100 Lactate, buffer & 220L SDC-9
	BMW-3	1.03E+08	2.75E+07	4.34E+03	1.23E+03			3.83E+03	2.44E+03	1.62E+03	7.64E+02	3.5	50 Lactate, buffer & 22L SDC-9
	BMW-5	6.61E+08	5.87E+08	9.97E+03	9.68E+02			1.10E+04	4.72E+03	5.39E+03	7.40E+02	4.2	12.5 Lactate, buffer & 2.2L SDC-9
	BMW-5X	1.36E+09	3.44E+08	1.51E+04	5.19E+03			6.99E+03	3.27E+03	7.24E+03	1.58E+03	2.6	12.5 Lactate, buffer & 2.2L SDC-9
	BMW-7	5.91E+08	2.57E+08	4.56E+03	3.95E+03							6.6	15 Lactate & buffer only
17 Mar samples	BMW-1	1.39E+09	3.96E+08	8.89E+03	1.09E+03			1.63E+04	4.21E+03	2.91E+04	1.56E+03	9.9	100 Lactate, buffer & 220L SDC-9
	BMW-3	1.35E+08	4.59E+07									3.6	50 Lactate, buffer & 22L SDC-9
	BMW-5	2.08E+09	7.75E+08									4.3	20 Lactate, buffer & 2.2L SDC-9
Edge of detection	BMW-5X	1.54E+09	1.93E+08									5.3	20 Lactate, buffer & 2.2L SDC-9
	BMW-7	1.04E+09	2.23E+08									4.6	40 Lactate & buffer only
	IW-1	1.40E+09	8.62E+07	8.42E+03	1.32E+03			1.74E+04	1.73E+03	9.50E+03	1.70E+03	9.5	900
	IW-2	2.78E+09	6.38E+08	5.50E+04	9.12E+03			1.27E+05	1.69E+04	7.10E+04	1.51E+04	14.0	550
	IW-3	2.91E+09	5.08E+08	3.51E+03	2.99E+02			1.01E+04	3.54E+03	5.37E+03	1.22E+03	7.9	440
	IW-4	1.34E+09	1.48E+08									11.1	300
19 Apr samples	BMW-1	5.00E+08	2.26E+08	1.64E+04	1.57E+03			1.39E+04	3.20E+03	3.18E+04	8.37E+03	5.5	75 Lactate, buffer & 220L SDC-9
	BMW-3	3.02E+08	1.78E+08	9.36E+03	2.35E+03			8.81E+03	1.34E+03	9.70E+03	9.67E+01	5.0	115 Lactate, buffer & 22L SDC-9
	BMW-5	3.46E+08	2.05E+08									4.4	40 Lactate, buffer & 2.2L SDC-9
	BMW-5X	7.53E+08	1.21E+08									5.2	40 Lactate, buffer & 2.2L SDC-9
	BMW-7	2.75E+08	1.55E+08									4.8	50 Lactate & buffer only
	IW-1	2.52E+07	7.40E+06	2.24E+04	3.84E+03			1.52E+04	6.06E+03	1.41E+04	5.27E+03	4.6	860
	IW-2	1.42E+09	5.05E+08	1.56E+04	4.28E+03			1.37E+04	1.29E+03	9.91E+03	3.63E+03	24.5	700
	IW-3	1.06E+08	2.35E+07	1.53E+03	9.69E+01			1.26E+03	1.66E+02	1.49E+03	4.41E+02	8.8	1730
	IW-4	4.39E+09	9.87E+08									29.4	720
19 May samples	BMW-1	2.26E+11	5.68E+10	2.27E+11	3.09E+10			1.08E+11	2.76E+10	1.46E+11	2.05E+10	51.5	15 Lactate, buffer & 220L SDC-9
	BMW-3	2.36E+10	7.12E+09	2.29E+09	1.49E+08			1.69E+09	1.80E+08	2.30E+09	1.49E+08	8.3	20 Lactate, buffer & 22L SDC-9
	BMW-5	5.37E+10	3.89E+09	3.98E+07	7.47E+06			3.37E+07	1.81E+06	6.38E+07	1.26E+07	18.6	20 Lactate, buffer & 2.2L SDC-9
	BMW-5X	3.03E+10	2.76E+10	2.24E+07	1.04E+06			1.85E+07	2.13E+06	3.15E+07	4.02E+06	19.0	20 Lactate, buffer & 2.2L SDC-9
	BMW-7	7.64E+08	4.59E+07	3.79E+04	1.13E+04			3.41E+04	1.29E+04			5.9	20 Lactate & buffer only

Bac uses the average of both 1:10 and 1:100 dilutions. For the others, used an average value for the undiluted sample because either the values are more robust (I don't trust the 1:10 numbers since they are on the detection limit) or there was an undetectable amount in the 1:10 dilution.

Not detected
DNQ Detectable but not quantifiable
gene numbe. in parentheses= detected in one dilution, otherwise DNQ
For Bac-The values are an average of both the 1:10 and 1:100 dilutions.
For Dhc, VcrA and TceA-BMW-1 is an average of both the undiluted and 1:10 diluted sample the rest are averages of just the undiluted samples.
For BvcA- BMW-1 gave a positive result for the undiluted sample however it is so low that I have very little confidence in this result (marked by purple fill)
Note: BMW-7 only gave sporadic amplification. Gene copies were deemed undetectable if it was not positive in at least 2 of 3 qPCR wells.
Note: on the map it says SC-9 for the 22L and 2.2L treatments. Is this a typo?

For Bac all values are an avg of both 1:10 and 1:100 dil
For Dhc and TceA IW 1 and 2 are an avg of both dilutions. For BMW-1, 3, 5, 5X use the undiluted results (diluted samples are undetectable or DNQ) and BMW-7 is from the diluted sample (inhibition).
For BvcA- BMW-5X is going values for undiluted but it is right on the edge of detection.
For VcrA All IW wells are avg of both dilutions. BMW-1 and 3 are values from undiluted samples (diluted samples are undetectable or DNQ) and BMW-7 is from the diluted sample (inhibition).
For TceA All IW wells are avg of both dilutions. BMW-1, 3 and 5 are values from undiluted samples (diluted samples are undetectable or DNQ).

For Bac all values are an avg of both 1:10 and 1:100 dil
For Dhc and TceA IW 1 and 2 are an avg of both dilutions. For BMW-1, 3, and IW-3 use the undiluted results (diluted samples are DNQ) and I had a bit of background with the Dhc qPCR and these values look like NTC but are mostly found only in the undiluted so it could be DNQ.
For VcrA IW 1, 2 and 3 are an avg of both dilutions. For BMW-1 and 3 I used the undiluted results (diluted samples are DNQ) and BMW-5 is from the undiluted sample (dilute sample is undetectable).
For TceA All IW wells are avg of both dilutions. BMW-1, 3 and 5 are values from undiluted samples (diluted samples are undetectable or DNQ).

Notes: For all genes assayed: Values for the first 4 wells are avg of 2 dilutions.
For BMW-7 Bac is the avg of both dil, Dhc and VcrA is the avg of the undil and TceA is DNQ in undil sample

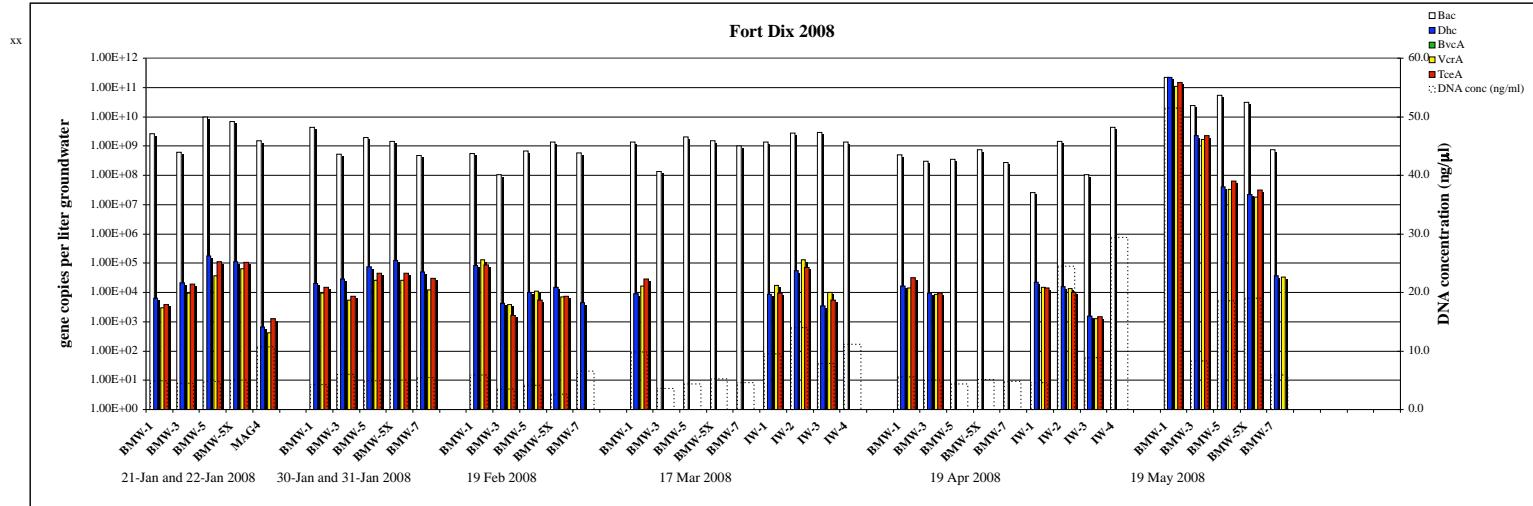

Cumulative Summary Since May 08 (New round of bioaugmentation)

		<i>Bac</i>		<i>Dhc</i>		<i>BvcA</i>		<i>VcrA</i>		<i>TceA</i>		DNA conc (ng/μl)
		average/L	stdev/L	average/L	stdev/L	average/L	stdev/L	average/L	stdev/L	average/L	stdev/L	
May 08	BMW-1	2.26E+11	5.68E+10	2.27E+11	3.09E+10			1.08E+11	2.76E+10	1.46E+11	2.05E+10	51.5
	BMW-3	2.36E+10	7.12E+09	2.29E+09	1.49E+08			1.69E+09	1.80E+08	2.30E+09	1.49E+08	8.3
	BMW-5	5.37E+10	3.89E+09	3.98E+07	7.47E+06			3.37E+07	1.81E+06	6.38E+07	1.26E+07	18.6
	BMW-5X	3.03E+10	2.76E+10	2.24E+07	1.04E+06			1.85E+07	2.13E+06	3.15E+07	4.02E+06	19.0
	BMW-7	7.64E+08	4.59E+07	3.79E+04	1.13E+04			3.41E+04	1.29E+04			5.9
June 08	BMW-1	1.74E+11	4.42E+10	4.11E+10	1.90E+09	2.09E+04	6.51E+03	1.78E+10	3.51E+09	2.08E+10	6.42E+09	18.2
	BMW-3	8.43E+10	1.06E+10	7.32E+08	7.79E+07			4.48E+08	5.60E+07	6.15E+08	1.24E+08	29.2
	BMW-5	2.38E+10	2.10E+09	7.50E+07	3.92E+06			3.56E+07	2.10E+06	8.42E+07	5.71E+06	24.6
	BMW-5X	3.98E+10	6.91E+09	5.10E+07	4.12E+06			2.19E+07	1.23E+07	5.24E+07	1.57E+07	23.9
	BMW-7	7.44E+09	1.21E+09									4.8
June 23, 08	BMW-2	3.67E+08	6.38E+07	1.47E+06	1.96E+04			1.19E+06	4.25E+04	2.61E+06	7.83E+04	3.2
	BMW-2x	2.87E+08	4.99E+07	5.84E+05	3.84E+04			5.73E+05	3.09E+04	1.25E+06	1.27E+05	1.3
	BMW-4	7.22E+08	6.77E+07									6.5
	BMW-6	2.11E+08	2.52E+07									8.7
	BMW-8	1.23E+08	1.18E+07									4.1
	EW-1	1.28E+08	2.97E+07									1.8
	EW-2	3.24E+08	2.33E+07									14.4
	EW-3	1.85E+08	1.83E+07									2.4
July 08	BMW-2	5.19E+08	2.41E+07	3.00E+06	3.47E+05			3.85E+05	7.14E+04	8.19E+05	3.69E+05	8.8
	BMW-2x	1.13E+09	7.23E+07	6.35E+06	1.46E+05			2.50E+06	1.27E+05	5.32E+06	2.65E+05	8.0
	BMW-4	3.26E+10	2.00E+09									11.3
	BMW-6	9.75E+08	2.00E+07									9.2
	BMW-8	7.08E+08	8.62E+07									3.7
	EW-1	1.73E+08	4.89E+06	2.49E+05	9.87E+04			6.89E+04	7.78E+03	2.99E+05	4.42E+04	6.0
	EW-2	1.09E+09	1.05E+08									8.6
	EW-3	3.52E+08	1.28E+07							6.11E+04	1.67E+04	5.8
	EW-4	6.64E+08	6.97E+07									11.4

= Undetected
 = DNQ
 = Did not assay due to lack of Dhc
gene copies = only detectable in one dilution otherwise DNQ

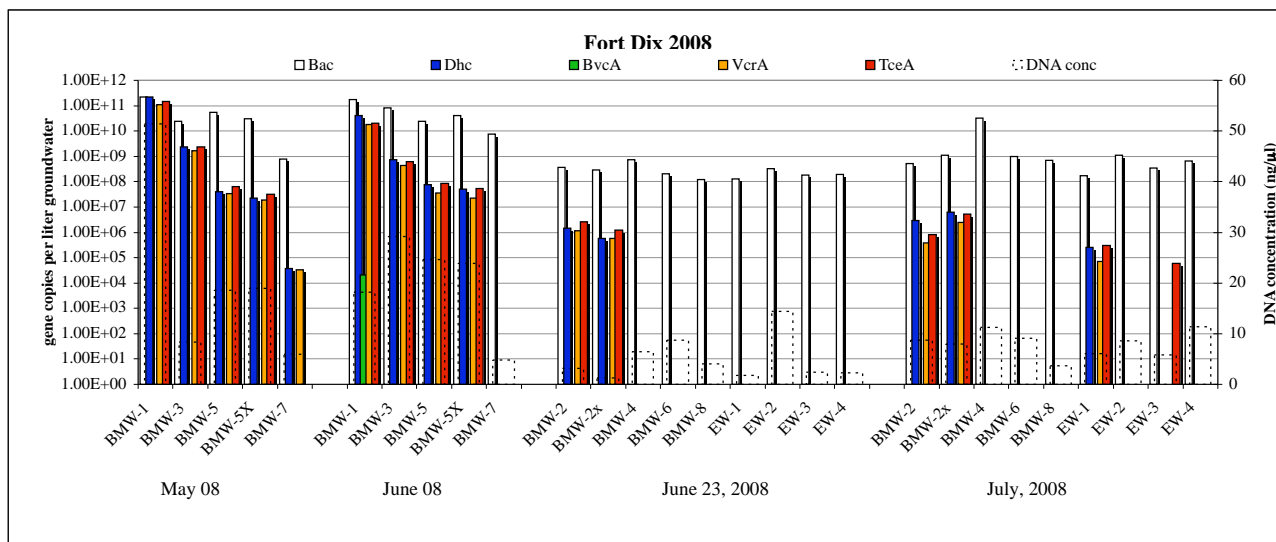

Note: New wells sampled from June 23, 2008