

TECHNOLOGY DEMONSTRATION FINAL REPORT

IN-SITU REMEDIATION OF MTBE CONTAMINATED AQUIFERS USING PROPANE BIOSPARGING

Revision 1

National Environmental Technology Test Site
Port Hueneme, CA

Prepared for:



Prepared by:

ENVIROGEN, INC.
4100 Quakerbridge Road
Lawrenceville, NJ 08648
609-936-9300
ENVIROGEN Project No. 92132

January 3, 2003

Report Documentation Page

Form Approved
OMB No. 0704-0188

Public reporting burden for the collection of information is estimated to average 1 hour per response, including the time for reviewing instructions, searching existing data sources, gathering and maintaining the data needed, and completing and reviewing the collection of information. Send comments regarding this burden estimate or any other aspect of this collection of information, including suggestions for reducing this burden, to Washington Headquarters Services, Directorate for Information Operations and Reports, 1215 Jefferson Davis Highway, Suite 1204, Arlington VA 22202-4302. Respondents should be aware that notwithstanding any other provision of law, no person shall be subject to a penalty for failing to comply with a collection of information if it does not display a currently valid OMB control number.

1. REPORT DATE 03 JAN 2003		2. REPORT TYPE		3. DATES COVERED 00-00-2003 to 00-00-2003	
4. TITLE AND SUBTITLE In-Situ Remediation of MTBE Contaminated Aquifers Using Propane Biosparging				5a. CONTRACT NUMBER	
				5b. GRANT NUMBER	
				5c. PROGRAM ELEMENT NUMBER	
6. AUTHOR(S)				5d. PROJECT NUMBER	
				5e. TASK NUMBER	
				5f. WORK UNIT NUMBER	
7. PERFORMING ORGANIZATION NAME(S) AND ADDRESS(ES) Envirogen Inc,4100 Quakerbridge Road,Lawrenceville,NJ,08648				8. PERFORMING ORGANIZATION REPORT NUMBER	
9. SPONSORING/MONITORING AGENCY NAME(S) AND ADDRESS(ES)				10. SPONSOR/MONITOR'S ACRONYM(S)	
				11. SPONSOR/MONITOR'S REPORT NUMBER(S)	
12. DISTRIBUTION/AVAILABILITY STATEMENT Approved for public release; distribution unlimited					
13. SUPPLEMENTARY NOTES					
14. ABSTRACT					
15. SUBJECT TERMS					
16. SECURITY CLASSIFICATION OF:			17. LIMITATION OF ABSTRACT	18. NUMBER OF PAGES	19a. NAME OF RESPONSIBLE PERSON
a. REPORT unclassified	b. ABSTRACT unclassified	c. THIS PAGE unclassified			

TABLE OF CONTENTS

LIST OF TABLES.....	iv
LIST OF FIGURES.....	v
LIST OF APPENDICES.....	vi
ACRONYM LIST.....	vii
ACRONYM LIST CONTINUED	viii
ACKNOWLEDGEMENTS.....	ix
EXECUTIVE SUMMARY	x
OBJECTIVE.....	x
BACKGROUND.....	x
DEMONSTRATION.....	xii
MICROCOSM STUDY RESULTS	xii
DEMONSTRATION RESULTS.....	xiii
CONCLUSIONS AND RECOMMENDATIONS	xv
1.0 INTRODUCTION	1
1.1 BACKGROUND	1
1.2 OBJECTIVES OF THE DEMONSTRATION	5
1.3 REGULATORY DRIVERS	8
2.0 TECHNOLOGY DESCRIPTION.....	9
2.1 TECHNOLOGY DEVELOPMENT AND APPLICATION	9
2.2 PREVIOUS TESTING OF THE TECHNOLOGY	9
2.3 FACTORS AFFECTING COST AND PERFORMANCE.....	10
2.4 ADVANTAGES AND LIMITATIONS OF THE TECHNOLOGY.....	11
3.0 DEMONSTRATION DESIGN.....	13
3.1 PERFORMANCE OBJECTIVES	13
3.2 SELECTING TEST SITE.....	14
3.3 TEST SITE DESCRIPTION	14
3.4 PRE-DEMONSTRATION ACTIVITIES.....	16
3.4.1 <i>Site Characterization Confirmation Sampling</i>	16
3.4.2 <i>Microcosm Studies</i>	16
3.5 TESTING AND EVALUATION PLAN	24
3.5.1 <i>Demonstration Installation</i>	24
3.5.2 <i>Demonstration Start-Up</i>	33
3.5.3 <i>Period of Operation</i>	42
3.5.4 <i>Operating Parameters</i>	42
3.5.5 <i>Amount of Material to be Treated</i>	43
3.5.6 <i>Residuals Handling</i>	43
3.5.7 <i>Experimental Design</i>	44
3.5.8 <i>Sampling Plan</i>	44

3.5.9	<i>Demobilization</i>	48
3.6	SELECTION OF ANALYTICAL METHODS.....	48
PERFORMANCE ASSESSMENT		49
4.1	PERFORMANCE CRITERIA	49
4.2	DATA ANALYSIS, INTERPRETATION, AND EVALUATION.....	51
4.2.1	<i>Hydrogeology</i>	52
4.2.2	<i>Geochemistry</i>	52
4.2.3	<i>MTBE/TBA</i>	53
4.2.4	<i>Biological parameters</i>	61
4.2.5	<i>MTBE Biodegradation Rates</i>	64
4.2.6	<i>Summary and Conclusion</i>	69
5.0 COST ASSESSMENT		74
5.1	COST REPORTING	74
5.1.1	<i>Reported Demonstration</i>	74
5.2	COST ANALYSIS	77
5.2.1	<i>Cost Estimate for Propane Biosparging</i>	78
5.2.2	<i>Cost Estimate for Pump and Treat</i>	81
5.2.3	<i>Cost Estimate for Combined Air Sparging/Soil vapor Extraction</i>	84
5.2.4	<i>Cost Comparison of Technologies</i>	85
6. IMPLEMENTATION ISSUES		87
6.1	ENVIRONMENTAL CHECKLIST	87
6.2	OTHER REGULATORY ISSUES	87
6.3	END-USER ISSUES	88
7.0 REFERENCES		90
8.0 POINTS OF CONTACT		95

LIST OF TABLES

- 1 Summary of MTBE Concentrations ($\mu\text{g/L}$) in Control and Test Plot
- 2 Performance Objectives
- 3 MTBE Concentrations in Test and Control Plot
- 4 TBA Concentrations in Test and Control Plot
- 5 Total Heterotroph Population in Test and Control Plots
- 6 Propanotroph Population in Test and Control Plot
- 7 Geochemical Data from Test and Control Plot
- 8 Analytical Methods
- 9 Schedule of Activities
- 10 Performance Criteria
- 11 Expected Performance and Performance Confirmation
- 12 Biodegradation Rate Calculations
- 13 Actual Demonstration Costs
- 14 Cost Data Table for MTBE Remediation with Biosparging
- 15 Cost Data Table for MTBE Remediation with Pump and Treat
- 16 Cost Data Table for MTBE Remediation with AS/SVE

LIST OF FIGURES

- 1 In-Situ Application of Propane Biosparging
- 2 Port Hueneme Plume Map
- 3 Location of Test Plot
- 4 MTBE Concentration in Microcosms from Air Sparging Site
- 5 MTBE Concentration in Microcosms Amended with O₂ or Propane and O₂
- 6 Biodegradation of Propane in Aquifer Microcosms
- 7 MTBE Biodegradation in Microcosms Amended with ENV425
- 8 Demonstration Area Layout
- 9 Test Plot Layout
- 10 Control Plot Layout
- 11 Well Construction Specifications
- 12 Propane Biosparging System - Piping and Instrumentation Diagram
- 13A - 13O Control Plot Groundwater Contour Maps (in Appendix E)
- 14A - 14O Test Plot Groundwater Contour Maps (in Appendix F)
- 15 Dissolved Oxygen Concentrations in Test Plot Monitoring Wells
- 16 Dissolved Oxygen Concentrations in Control Plot Monitoring Wells
- 17 MTBE Concentrations in Test Plot Monitoring Wells
- 18 MTBE Concentrations in Control Plot Monitoring Wells
- 19 Average Heterotroph Population
- 20 Average Propanotroph Population
- 21 Biodegradation Rates in the Test Plot
- 22 Biodegradation Rates in the Control Plot

LIST OF APPENDICES

- A SOP for Pressure/Air Sparge Testing
- B Bacterial Injection Protocol
- C Health and Safety Plan (HASP)
- D Quality Assurance Plan (QAP)
- E Figures 13A - 13 O Control Plot Groundwater Contour Maps
- F Figures 14A - 14 O Test Plot Groundwater Contour Maps

ACRONYM LIST

AL	Action level
AspS	Air sparging site
AS/SVE	Air sparging/ soil vapor extraction
BBL	R2A agar
bg	below grade
BIPs	Bacteria injection points
BSM	Basal Salt Media
BTEX	Benzene, toluene, ethylbenzene and xylenes
CBC	Naval construction battalion center
CCL	Contaminant candidate list
cfm	Cubic feet per minute
CFU	Colony forming units
cBOD ₅	Carbonaceous biological oxygen demand
COD	Carbon oxygen demand
CPT	Cone penetrometer
DHS	California Department of Environmental Health Services
DO	Dissolved oxygen
DOE	Department of Energy
dMTBE	Deuterated-MTBE
DTW	Depth to water
Eh	Redox potential
ETBE	Ethyl <i>tert</i> -butyl ether
ESTCP	Environmental Security Technology Certification Program
FBRs	Fluid bed bioreactors
FID	Flame ionization detector
LEL	Lower explosive limit
LNAPL	Light nonaqueous phase liquids
LPGAC	Liquid phase granular activated carbon
MCL	Maximum contaminant level
MTBE	Methyl- <i>tert</i> -butyl-ether
mg/L	milligrams per liter
µg/L	micrograms per liter
NETTS	National Environmental Technology Test Site
NEX	Naval exchange
NOAEL	No-Observable-Adverse-Effect-Level
OIPs	Oxygen injection points
ORP	Oxidation reduction potential
PIPs	Propane injection points
PMO	Propane monooxygenase

ACRONYM LIST CONTINUED

POB	Propane oxidizing bacteria
ppb	parts per billion
ppm	parts per million
SC	Specific conductance
SOP	Standard operating procedure
TAME	<i>tert</i> -amyl methyl ether
TBA	<i>tertiary</i> butyl alcohol
TCE	trichloroethylene
TDS	Total dissolved solids
TOC	Top of casing
TSS	Total suspended solids
U.C. Davis	University of California at Davis
UCMR	Unregulated Contaminant Monitoring Rule
USEPA	U.S. Environmental Protection Agency
VMPs	Vapor monitoring points
VOCs	Volatile organic compounds

ACKNOWLEDGEMENTS

We are grateful to the Environmental Security Technology Certification Program for providing funding and support for this project. The Base and NFESC personnel at Port Hueneme performed operation and maintenance activities during the demonstration, and provided assistance and support when needed during sampling events, sometimes on short notice. Their assistance is truly appreciated. They also were the primary contact with the California Water Quality Control Board, and included ENVIROGEN's demonstration activities and results in their monthly reports to the Board as required by the Monitoring and Reporting Program. These personnel include, among others, Ernie Lory, Dorothy Cannon, Kathy Greene, Thomas Strassburger, Dale Lorenzana, Gail Pringle, and Bill Major. We appreciate the collaboration and efforts of USEPA, including Dr.s Ann Keeley and Carl Enfield and others, in carrying out their work as part of EPA's Technology Verification Program.

EXECUTIVE SUMMARY

OBJECTIVE

The primary objectives of this ESTCP-funded project were 1) to demonstrate the safe application of propane biosparging (i.e., biostimulation) for in situ remediation of MTBE; and 2) evaluate the ability of propane biosparging to reduce MTBE concentrations in a contaminated aquifers to below regulatory limits (i.e., 5 µg/L). To meet this objective, several secondary objectives were identified as follows: 1) perform microcosm testing to evaluate the ability of indigenous propane oxidizing bacteria and/or other microorganisms to degrade MTBE; 2) select and characterize a field demonstration site; 3) use field characterization and microcosm study data to design, construct and operate a field demonstration system; 4) evaluate performance of the treatment system during a 10-month treatment period; and 5) evaluate the cost of applying the technology at full scale.

BACKGROUND

Methyl *tert*-butyl ether (MTBE) has been used as a high-octane additive in mid- and high-grade gasoline since 1979, and to replace lead and other gasoline additives such as benzene, toluene, ethylbenzene and xylenes (BTEX). The 1990 Clean Air Act Amendments required that in high pollution areas of the country, oxygenates be used in all grades of gasoline to encourage complete fuel combustion, thereby reducing vehicle emissions such as air toxics, carbon monoxide and volatile organic compounds. The goal of gasoline reformulation is to reduce gasoline's benzene content by 33% and the other organics by at least 15%. MTBE was selected as the oxygenate of choice to meet the new standards. In 1992, more than 1.8 billion gallons of MTBE went into gasoline, and its use has increased each year since. It accounts for up to 11% by volume of the reformulated gasoline product used by consumers, and now is added to > 30% of the gasoline sold in the US. In 1995, 17.62 billion pounds of MTBE was produced primarily for use in gasoline, and its production and use has continued to increase.

The discharge of gasoline from leaky underground storage tanks into soils and groundwater has resulted in the contamination of these media with MTBE. Because MTBE is highly soluble in water (~43,000 mg/L), it is often found as plumes in groundwater near service stations, storage facilities, and filling terminals throughout the United States. More than 300,000 releases from leaking underground tanks have been reported to state regulatory agencies. Thus, human exposure to MTBE is a clear and present concern in the United States. As little as four liters of reformulated gasoline can contaminate more than 1,000,000 liters of groundwater to above MTBE's odor and taste threshold of 40 µg/L.

Compared to other gasoline constituents, relatively few studies have been conducted to address the biodegradability of MTBE in soils, sediments, or groundwaters. The studies that have been published have generally shown that the compound is resistant to biodegradation or

degraded only slowly through the combined actions of several microorganisms (i.e., by a consortia rather than a single strain). Work at ENVIROGEN, revealed that MTBE can be degraded by propane-oxidizing bacteria (Steffan et al., Appl. Environ. Microbiol. 63:4216-4222, 1997). The propane-oxidizing strains, however, do not grow on MTBE as a sole source of carbon and energy, but rather require propane for growth, and cometabolize MTBE when supplied with this substrate. These findings became the basis for a new treatment technology that relies on the addition of propane and oxygen to contaminated media to stimulate MTBE degradation by indigenous or added propane oxidizing bacteria (US Patent 5,814,514; Sept. 29, 1998).

Historically, the most common treatment technology for groundwater contamination has been a pump-and-treat approach. With this technology contaminated groundwater is pumped from the subsurface, the contaminant is removed through volatilization (air-stripping), sorption to a matrix (carbon adsorption), chemical (e.g., ultraviolet irradiation, peroxide oxidation) or biological (bioreactor) destruction, and the groundwater is discharged above ground or to the subsurface. Because of its high aqueous solubility, low Henry's Law Constant (low volatility from water), and poor adsorption to carbon, the usual *ex situ* treatment techniques designed for contaminants such as benzene and trichloroethylene have proven to be ineffective or expensive for removal of MTBE from groundwater. The use of air stripping and carbon adsorption is even less useful in regions of the country where *tert*-butyl alcohol (TBA) levels in groundwater also are regulated. TBA strips more poorly than MTBE, and it has an even lower affinity for activated carbon.

In situ approaches to groundwater remediation include air or nutrient supplementation to stimulate contaminant degradation (e.g., biosparging), addition of compounds such as zero-valent iron for chemical dechlorination, and addition of bacteria capable of contaminant destruction (bioaugmentation). For many contaminants, including most petroleum constituents (BTEX, alkanes, etc), subsurface aeration effectively promotes aerobic contaminant destruction by stimulating the natural microflora in the region to degrade the polluting compounds. However, the recalcitrance of MTBE relative to other gasoline components generally makes it resistant to *in situ* biostimulation approaches such as air sparging and/or nutrient-amendment. Thus, unlike many groundwater contaminants, a novel approach is often required for *in situ* remediation of MTBE in contaminated groundwater.

There are several potential advantages to using a biostimulation approach for degrading MTBE *in situ*. Biostimulation uncouples biodegradation of the contaminant from growth of the organisms. That is, the microbes can be supplied sufficient co-substrate (e.g., propane) to support growth, so they do not have to rely on the utilization of low levels of contaminants to maintain their survival. Also, the technology can be applied in a number of configurations depending on site characteristics and treatment needs. Possible application scenarios include: 1) re-engineered or modified multi-point air sparging/soil vapor extraction (AS/SVE) systems that deliver propane and air throughout a contaminated site (suitable for use with existing AS/SVE systems or specially designed systems); 2) a series of air/propane delivery points arranged to

form a permeable treatment wall to prevent off site migration of MTBE; 3) permeable treatment trenches fitted with air and propane injection systems; 4) *in situ* recirculating treatment cells that rely on pumping and reinjection to capture and treat a migrating contaminant plume; and 5) propane and oxygen injection through bubble-free gas injection devices to minimize off-gas release and contaminant stripping. Furthermore, propane is widely available, transportable even to remote sites, already present at many gasoline stations, and relatively inexpensive. Thus, propane biostimulation has the potential to be an attractive remediation option at a wide variety of MTBE-contaminated sites.

DEMONSTRATION

This ESTCP-funded demonstration project was designed to evaluate the application of *in situ* propane biosparging for remediating MTBE contaminated aquifers. The project compared MTBE biodegradation in a Test Plot that was amended with propane oxidizing bacteria and treated with oxygen and propane to a Control Plot that received only oxygen. The project also allowed evaluation of the cost and safety of propane biosparging for MTBE remediation at the field scale. The ultimate goal of the demonstration was reduce MTBE concentrations in the Test Plot to 5 µg/L, but this goal was not met during the demonstration period.

MICROCOSM STUDY RESULTS

In this study, microcosms prepared from Site soil and groundwater were used to select the appropriate treatment approach for the Port Hueneme site. Our microcosm data, and that of others, indicated that indigenous MTBE degrading microorganisms occurred in the aquifer and that their activity could be enhanced by oxygen addition. Even though this activity exists at the site and the aquifer is shallow and sandy and likely supplied with oxygen through rain events, the MTBE plume is very large and apparently expanding. Thus, we elected to evaluate enhancing the natural activity at the site by inoculating the aquifer with a small amount of a propane oxidizing bacterium and supporting their degradative activity by adding propane and oxygen.

Microcosm studies revealed that the addition of $\sim 10^8$ CFU/mL of ENV421 provided rapid activity in the Port Hueneme samples. Based on our experience with bioaugmentation, we anticipated that wild-type organisms because of their adhesive properties would not be widely distributed in the aquifer after injection. Thus, even a relatively small amount of organisms would create a high cell density biobarrier around the injection points. As the organisms grew on the added propane and oxygen, the biobarrier was expected to expand with the groundwater movement. In earlier demonstrations at the site as much as 6000 L of culture was injected into a similarly-sized Test Plot. We, however, elected to inject only ~ 16 L (i.e., 5 gal.) of seed culture (equivalent to 5 L of concentrated culture at $\sim 10^{11}$ CFU/mL) into the aquifer. This amount of culture can be produced inexpensively and shipped inexpensively via overnight courier even to remote sites.

DEMONSTRATION RESULTS

A summary of the demonstration results is presented in Table 1. As expected based on microcosm studies and previous demonstrations at the site, MTBE concentrations decreased in both the Test and Control Plots during the demonstration. MTBE concentrations at individual wells are presented in Table 3. Test Plot and Control Plot well locations are illustrated in Figures 8, 9, and 10. MTBE concentrations in deep monitoring wells located directly downgradient of the propane and oxygen injection systems rapidly decreased during the first two months following bioaugmentation. MTBE levels decreased in GWT-3D from 2,100 µg/L (May 20, 2001) to 280 µg/L (July 10 2001) and 73 µg/L by the end of the demonstration. Similarly, MTBE concentrations in wells GWT-6D, GWT-9D, and GWT-12D (center column of deep monitoring wells) decreased dramatically over the course of the demonstration. For example, the concentration at GWT-6D decreased from 1,700 µg/L in May 2001 to 110 µg/L by the end of the demonstration (March, 2002).

MTBE concentrations also decreased by a factor of 20 in the other deep monitoring wells in the Test Plot. The maximum MTBE concentrations in the deep Test Plot wells immediately prior to bioaugmentation was 3,400 µg/L at GWT-10D and GWT-15D, with most wells having a concentration above 1,300 µg/L. At the conclusion of the demonstration, the maximum MTBE concentration in the deep Test Plot wells was 440 µg/L, with most wells having a concentration below 150 µg/L.

In the shallow monitoring well network, MTBE concentrations in the well upgradient of the Test Plot (GWT-1S) decreased from 1,700 µg/L to 5 µg/L by the end of the demonstration. Thus, groundwater entering the shallow aquifer in the Test Plot generally contained less than 250 µg/L after July 2001. This result suggests that either the groundwater upgradient of the demonstration area contains low concentrations of MTBE or, more likely, that propane and oxygen spread upgradient into the shallow aquifer and promoted MTBE biodegradation at GWT-1S. Dissolved oxygen in the background well was generally lower than in the rest of the Test Plot, but dissolved oxygen increases were observed in this well during the course of the demonstration. MTBE concentrations in the other shallow monitoring wells in the Test Plot were typically less than 1,000 µg/L during the demonstration. Concentrations of MTBE in the line of wells GWT-2S, GWT-5S, GWT-8S, and GWT-11S was generally less than 200 µg/L and, in fact, approached 5 µg/L by the end of the demonstration. A similar trend in MTBE concentrations was observed in most of the shallow monitoring wells in the Test Plot.

Some of the wells in the Control Plot also had relatively rapid decreases in MTBE concentrations after oxygen injection began. For example, MTBE concentrations in the first deep monitoring well in the center of the Control Plot, GWC-3D, decreased from 4300 µg/l on May 21, 2001 to 690 µg/L on June 26, 2001. This apparent microbial response to oxygen injection appeared much more rapid than the lag period observed during previous field studies at the site. In the shallow wells of the Control Plot MTBE concentrations in groundwater entering the plot were

approximately 2 mg/L at the beginning of the study (May 1, 2001), but by June 25, 2001 they had declined to approximately 350 µg/L. They continued to decline to only 3 µg/L by the end of the study (March, 11, 2002). Some decreases in the upgradient wells of the Control Plot also occurred, but the extent of the decline was not as great as in the Test Plot. The greatest decreases in the deep upgradient monitoring well of the Control Plot occurred in January 2002, and this closely followed a period of the greatest oxygen levels measured at this well.

TABLE 1
SUMMARY OF MTBE CONCENTRATIONS (µg/L) IN CONTROL AND TEST PLOTS
 ESTCP Propane Biosparging Demonstration
 Port Hueneme, CA
 Envirogen Project No. 92132

Test Plot	5/20/01 – 5/22/01		3/11/02 – 3/12/02		Percent Removal 5/01 through 3/02
	Average	Std. Dev.	Average	Std. Dev.	
Test Row 1 Shallow	473	290	105	57	77.9
Test Row 2 Shallow	513	376	64	48	87.5
Test Row 3 Shallow	230	89	86	71	62.5
Test Row 4 Shallow	180	89	40	33	77.6
Test Row 5 Shallow	110	100	15	18	86.3
Test Row 1 Deep	1,800	436	168	236	90.6
Test Row 2 Deep	2,067	723	148	108	92.8
Test Row 3 Deep	2,400	917	95	34	96.0
Test Row 4 Deep	1,360	1,080	187	81	86.3
Test Row 5 Deep	2,550	1,202	82	83	96.8

Control Plot	5/20/01 – 5/22/01		3/11/02 – 3/12/02		Percent Removal 5/01 through 3/02
	Average	Std. Dev.	Average	Std. Dev.	
Control Row 1 Shallow	1,187	1,150	256	303	86.4
Control Row 2 Shallow	766	839	22	15	97.1
Control Row 3 Shallow	610	285	27	36	95.6
Control Row 1 Deep	4,667	814	502	617	89.2
Control Row 2 Deep	4,633	777	558	732	87.9
Control Row 3 Deep	5,333	1,380	527	670	90.1

NOTES: Test Row 5 has only 2 wells. All other “Average” concentrations are the average of 3 wells.

CONCLUSIONS AND RECOMMENDATIONS

One potential advantage of applying alkane oxidizing bacteria for remediation rather than cultures that grow on MTBE, is that their growth can be maintained by adding sufficient amounts of high-yield substrate. Biomass yields on MTBE are generally very low (~10% to 20%), and the mass of substrate (i.e., MTBE) reaching the organisms in an aquifer is determined by groundwater flow. Thus, organisms that grow on MTBE could starve in an aquifer if groundwater flow is slow and MTBE concentrations are low. Because addition of propane can be regulated easily to maintain a continuous food source, and because bacterial yields on propane are great (>50%), biomass levels and MTBE degradation activity should be less dependent on MTBE concentrations and groundwater flow rates. Unfortunately, active MTBE degradation in our Control Plot during this demonstration prevents a thorough evaluation of the effectiveness of the MTBE degrading propanotrophs stimulated in this aquifer. At the end of the study, however, we were able to isolate several MTBE-degrading propanotrophs from the Test Plot, but none from the Control Plot. This suggests that propanotrophs did play a role in MTBE degradation in the Test Plot. Interestingly, the isolated propanotrophs did not have the same colony morphology as ENV425, suggesting that native propanotrophs increased in abundance and/or dominance in the aquifer during the course of the demonstration. Some of data collected near the end of the demonstration suggested that MTBE degradation activity in the Control Plot was declining. A longer demonstration may have allowed a better assessment of the stability and activity of the indigenous MTBE degrading population relative to the stimulated propanotrophs.

In summary, we have demonstrated that propane biosparging can be safely and economically applied at the field scale to promote in situ degradation of MTBE. Application of the technology resulted in no measurable fugitive emissions of propane, and in situ biodegradation maintained propane levels near or below its detection limit in groundwater. Propane costs for the 10-month demonstration were only about \$50/month, indicating that application of this technology costs little more than a traditional air sparging system. Thus, it may be cost effective to incorporate propane biosparging equipment into MTBE remediation designs, even at sites where MTBE biodegradation by indigenous organisms is suspected. If indigenous bacteria prove to be inefficient or ineffective at remediating the site, propane can be injected to enhance activity.

Results of this study also demonstrated that most of the active MTBE degradation that occurred in both plots occurred near the oxygen injection points. This limit of degradation activity was probably caused by consumption of the oxygen added to the plots. Oxygen was likely consumed by both geochemical oxygen sinks and biological activity. Because of the process monitoring and technology validation procedures of both Envirogen and the USEPA, we elected not to increase gas flows into the site during this demonstration. To reach even lower MTBE levels, however, either additional rows of oxygen injection points should be used, or oxygen loading rates should be increased.

1.0 INTRODUCTION

1.1 BACKGROUND

Methyl *tert*-butyl ether (MTBE) has been used as a high-octane additive in mid- and high-grade gasoline since 1979, to replace lead and other gasoline additives such as benzene, toluene, ethylbenzene and xylenes (BTEX). The 1990 Clean Air Act Amendments required that in high pollution areas of the country, oxygenates be used in all grades of gasoline to encourage complete fuel combustion, thereby reducing vehicle emissions such as air toxics, carbon monoxide and volatile organic compounds. The goal of gasoline reformulation is to reduce gasoline's benzene content by 33% and the other organics by at least 15%. MTBE was selected by most gasoline producers as the oxygenate of choice. In 1992, more than 1.8 billion gallons of MTBE went into gasoline, and its use has increased each year since (Anderson, 1993). It accounts for up to 11% by volume of the reformulated gasoline product used by consumers. It is now added to almost 30% of the gasoline sold in the US, and this is expected to increase to over 70%. In 1995, 17.62 billion pounds of MTBE was produced primarily for use in gasoline (Johnson et al., 2000). The remediation of MTBE-contaminated sites is of concern to DOD, as fuel is stored, transported, and/or dispensed at many military installations. MTBE has been found at DOD facilities in at least 15 states. This number is expected to greatly increase when specific testing for MTBE is required.

The discharge of gasoline from leaky underground storage tanks into soils and groundwater has resulted in the contamination of these media with MTBE. Because MTBE is highly soluble in water (~43,000 mg/L), it is often found as plumes in groundwater near service stations, storage facilities, and filling terminals throughout the United States (American Petroleum Institute, 1991). More than 300,000 releases from leaking underground tanks have been reported to state regulatory agencies (USEPA, 1995). Thus, human exposure to MTBE is a clear and present concern in the United States. As little as four liters of reformulated gasoline can contaminate more than 1,000,000 liters of groundwater to above its odor and taste threshold of 40 µg/L.

The full extent of MTBE contamination in US groundwaters was assessed in the early 1990s as part of the US Geological Survey's National Water-Quality Assessment Program (Squillace et al., 1996). These assessments showed that MTBE is in fact the second most commonly detected contaminant in urban groundwaters. As part of the Assessment Program, groundwater samples from 211 wells from 8 urban areas and 524 wells from 20 agricultural areas were tested. Twenty-seven percent (27%) of the urban wells tested and 1.3% of the agricultural wells tested showed MTBE at concentrations above the detection level of 0.2 µg/L (ppb). Concentrations as high as 23,600 ppb were detected, and the median concentration of MTBE was 0.6 ppb. In Denver, Colorado 79% of shallow urban wells tested contained MTBE, and 37% of the tested wells in New England showed detectable levels of MTBE. Beckenbach and Happel (1998) reported that MTBE has been detected at approximately 80% of California's LUST sites, and that 62% of these sites exhibit MTBE concentrations in excess of the EPA's advisory level of 70

ppb. Buscheck et al. (1998) reviewed data from 700 service station sites in the US and observed that greater than 80% of the active sites and 74% of the inactive sites had MTBE contamination. In fact, 96%, 98%, and 86% of the service station sites in Texas, Maryland, and California, respectively, that analyzed their groundwater for MTBE had significant MTBE contamination. Of these sites, 63%, 82% and 47%, respectively, had MTBE concentrations greater than 1 mg/L. This widespread contamination has led to increased public and regulatory scrutiny and a need to better understand the toxicology of MTBE, and to identify remediation technologies.

The health and environmental effects of MTBE are currently under intensive investigation. The greatest human exposure routes of the oxygenate are through drinking contaminated water, use of the water in cooking, and through inhalation during bathing. Based on rat model studies, the No-Observable-Adverse-Effect-Level (NOAEL) for MTBE is 100 mg/kg/day. The carcinogenicity of MTBE in groundwater is still under review. However, several studies have suggested that MTBE causes cancer and other tumor-related diseases in animals exposed by oral or respiratory routes (MacDonald, 1996; Belpoggi et al., 1995; Burleigh-Flayer et al., 1992). Similarly, MTBE metabolites such as *tertiary* butyl alcohol (TBA) have been implicated in causing urinary tract lesions and chrySTALLURIA (Lindamood et al., 1992), histological alterations in the liver including centrilobular necrosis, vacuolation of hepatocytes and loss of hepatic architecture (Acharya et al., 1997), and carcinoma of the thyroid (Cirvello et al., 1995).

The technology demonstrated in this project was propane biosparging. This technology is an extension of conventional biosparging methods. The approach involved the addition of oxygen (for aerobic respiration) and propane (as a cosubstrate) to the subsurface to stimulate propane-oxidizing bacteria (POB) in the production of the enzyme propane monooxygenase (PMO) that catalyzes the degradation of MTBE and its primary degradation product, TBA, to carbon dioxide and water (Figure 1). The project utilized a Test Plot that was amended with propane oxidizing bacteria and treated with oxygen and propane and a Control Plot that received only oxygen. Exogenous POB *Rhodococcus ruber* strain ENV425 was used to seed the Test Plot aquifer at the onset of the demonstration to insure activity and to speed initiation of the treatment process.

ENVIROGEN has observed that propane-oxidizing microorganisms mineralize MTBE to CO₂ and H₂O after growth on propane (Steffan et al., 1997). Other hydrocarbon gases, such as methane and butane, have been used to stimulate co-metabolic biodegradation processes *in situ*. In the most publicized application of this "biostimulation" approach, methane and oxygen were injected into a trichloroethylene (TCE)-contaminated aquifer at the DOE's Savannah River Site (Hazen et al., 1994). This procedure successfully stimulated *in situ* biodegradation of the chlorinated solvent. Therefore, it is likely that a similar application of biostimulation, whereby propane and oxygen are injected to stimulate MTBE degradation by indigenous organisms or seed cultures, is feasible (US Patent # 5,814,514, Sept. 29, 1998).

FIGURE 1. Schematic representation of in-situ propane biosparging for MTBE remediation

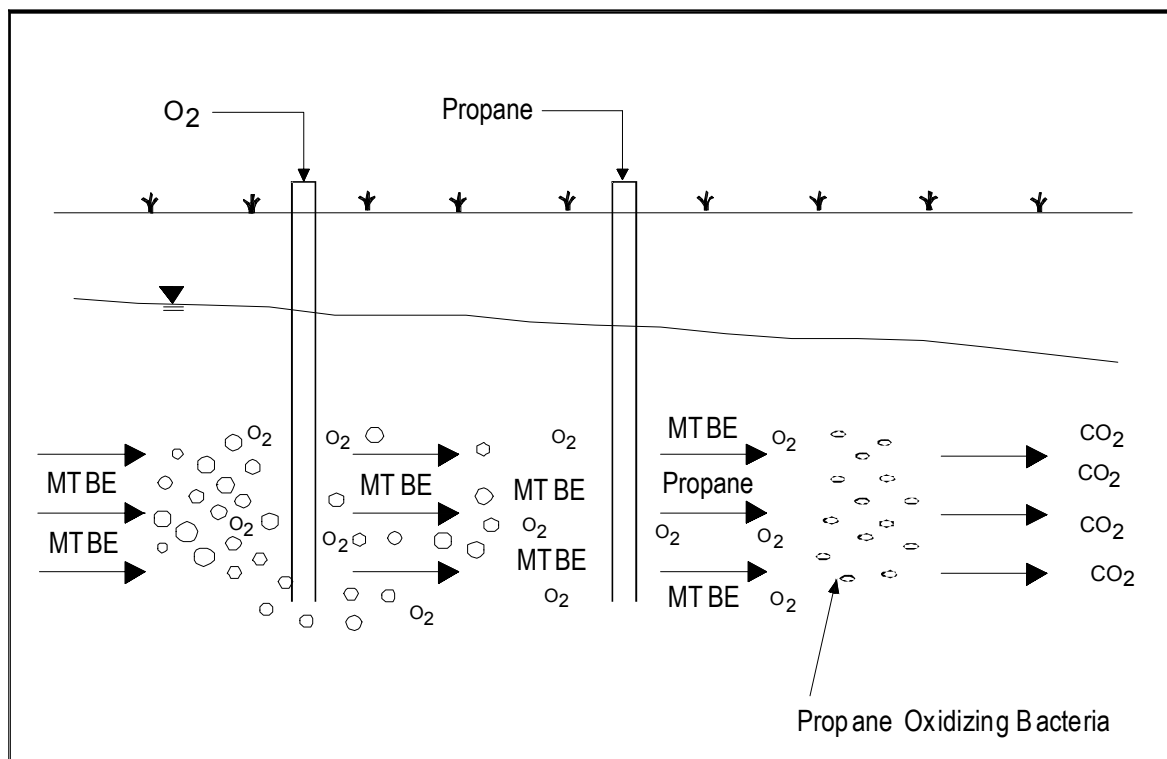

There are several potential advantages to using a biostimulation approach for degrading MTBE *in situ*. Biostimulation uncouples biodegradation of the contaminant from growth of the organisms. That is, the microbes can be supplied sufficient co-substrate (e.g., propane) to support growth, so they do not have to rely on the utilization of low levels of contaminants to maintain their survival. Also, the technology can be applied in a number of configurations depending on site characteristics and treatment needs. Possible application scenarios include: 1) re-engineered or modified multi-point AS/SVE systems that deliver propane and air throughout a contaminated site (suitable for use with existing AS/SVE systems or specially designed systems); 2) a series of air/propane delivery points arranged to form a permeable treatment wall to prevent off site migration of MTBE; 3) permeable treatment trenches fitted with air and propane injection systems; 4) *in situ* recirculating treatment cells that rely on pumping and reinjection to capture and treat a migrating contaminant plume; and 5) propane and oxygen injection through bubble-free gas injection devices to minimize off-gas release and contaminant stripping. Furthermore, propane is widely available, transportable even to remote sites, already present at

many gasoline stations, and relatively inexpensive. Thus, propane biosparging has the potential to be an attractive remediation option at a wide variety of MTBE-contaminated sites.

Historically, the most common treatment technology for groundwater contamination has been a pump-and-treat approach. With this technology contaminated groundwater is pumped from the subsurface, the contaminant is removed through volatilization (air-stripping), sorption to a matrix (carbon adsorption), chemical (e.g., ultraviolet irradiation, peroxide oxidation) or biological (bioreactor) destruction, and the groundwater is discharged above ground or to the subsurface. Because of its high aqueous solubility, low Henry's Law Constant (low volatility from water), and poor adsorption to carbon, the usual *ex situ* treatment techniques designed for contaminants such as benzene and trichloroethylene have proven to be ineffective or expensive for removal of MTBE from groundwater. For example, in a study of MTBE treatment at 15 contaminated sites, air-stripping of MTBE from water was found to remove as little as 56 % of contaminant mass (i.e., 44 % remained in the water after stripping) (American Petroleum Institute, 1991). Despite this poor removal, air stripping is often considered to be the most effective and economical method for remediating MTBE-contaminated groundwater (Keller et al., 1998). The use of air stripping and carbon adsorption is even less useful in regions of the country where TBA levels in groundwater also are regulated. TBA strips more poorly than MTBE, and it has an even lower affinity for activated carbon.

In situ approaches to groundwater remediation include air or nutrient supplementation to stimulate contaminant degradation (e.g., biosparging), addition of compounds such as zero-valent iron for chemical dechlorination, and addition of bacteria capable of contaminant destruction (bioaugmentation). For many contaminants, including most petroleum constituents (BTEX, alkanes, etc), subsurface aeration effectively promotes aerobic contaminant destruction by stimulating the natural microflora in the region to degrade the polluting compounds. However, the recalcitrance of MTBE relative to other gasoline components generally makes it resistant to commercial *in situ* biostimulation approaches such as air sparging and/or nutrient-amendment. In addition, *in situ* "iron walls" are expected to be ineffective for degrading MTBE, because the molecule is not subject to chemical reduction and/or dechlorination. Thus, unlike many groundwater contaminants, a novel approach is often required for *in situ* remediation of MTBE in contaminated groundwater.

Although significant progress has been made toward the development of *in situ* treatment technologies for remediating MTBE-contaminated aquifers (Salinatro et al., 2000), *ex situ* treatment is still needed for sites where groundwater extraction is required to halt the migration of contaminant plumes towards neighboring receptors. Although MTBE-contaminated water has been treated in simple stirred tank reactor systems (Cowan and Park, 1996; Park and Cowan, 1997; Sun et al., 1997), degradation rates are slow, requiring long hydraulic retention times, and thus large reactors. Such reactors may be unsuitable for application at service station sites that typically have limited available space. MTBE also has been treated in laboratory-scale reactors that incorporate either a porous pot (Wilson et al., 1999) or membrane (Steffan et al., 2000;

Morrison et al., 2001) to retain high biomass levels for improved volumetric performance. These reactors allow the use of long solids retention times that are apparently needed to ensure degradation of MTBE to regulatory levels (Wilson et al., 1999; Morrison et al., 2001). Likewise, initial results of laboratory-scale testing of fluid bed bioreactors (FBRs) for treatment of MTBE-contaminated groundwater have been described (Steffan et al., 2000; Vainberg et al., 2002).

1.2 OBJECTIVES OF THE DEMONSTRATION

This ESTCP-funded demonstration project was designed to evaluate the application of in situ propane biosparging for remediating MTBE contaminated aquifers. The primary objectives of this ESTCP-funded project were 1) to demonstrate the safe application of propane biosparging (i.e., biostimulation) for in situ remediation of MTBE; and 2) evaluate the ability of propane biosparging to reduce MTBE concentrations in a contaminated aquifers to below regulatory limits (i.e., 5 µg/L). To meet this objective, several secondary objectives were identified as follows: 1) perform microcosm testing to evaluate the ability of indigenous propane oxidizing bacteria and/or other microorganisms to degrade MTBE; 2) select and characterize a field demonstration site; 3) use field characterization and microcosm study data to design, construct and operate a field demonstration system; 4) evaluate performance of the treatment system during a 10-month treatment period; and 5) evaluate the cost of applying the technology at full scale. The project compared MTBE biodegradation in a Test Plot that was amended with propane oxidizing bacteria and treated with oxygen and propane to a Control Plot that received only oxygen. The technology also was evaluated under the USEPA SITE Program as part of the USEPA's MTBE Treatment Technology Verification Program. The demonstration was conducted from May of 2001 to March of 2002.

The National Environmental Technology Test Site (NETTS) at the Naval Construction Battalion Center (CBC), Port Hueneme, California, was chosen to host the propane biosparging technology demonstration. The Port Hueneme NETTS facility is located approximately 70 miles northwest of Los Angeles. The Naval Exchange (NEX) service station is the source of the petroleum plume that occurs on the Port Hueneme CBC facility. According to NEX inventory records, approximately 4,000 gallons of leaded and 6,800 gallons of unleaded premium gasoline were released from the distribution lines between September 1984 and March 1985. The resulting groundwater plume consists of approximately 9 acres of BTEX, extending 1,200 feet from the NEX service station, and approximately 36 additional acres of MTBE contamination, extending approximately 4,500 feet from the NEX service station. A map of the contaminant plume is presented in Figure 2. The plume area situated approximately 2,400 feet southwest of the NEX station was chosen for the demonstration. The location of ENVIROGEN's demonstration plot is shown in Figures 2 and 3. It is located adjacent to the existing University of California at Davis (U.C. Davis) and Equilon, Inc. demonstration plots. The ENVIROGEN plot is approximately 90 feet by 60 feet and includes a Test Plot and a Control Plot.

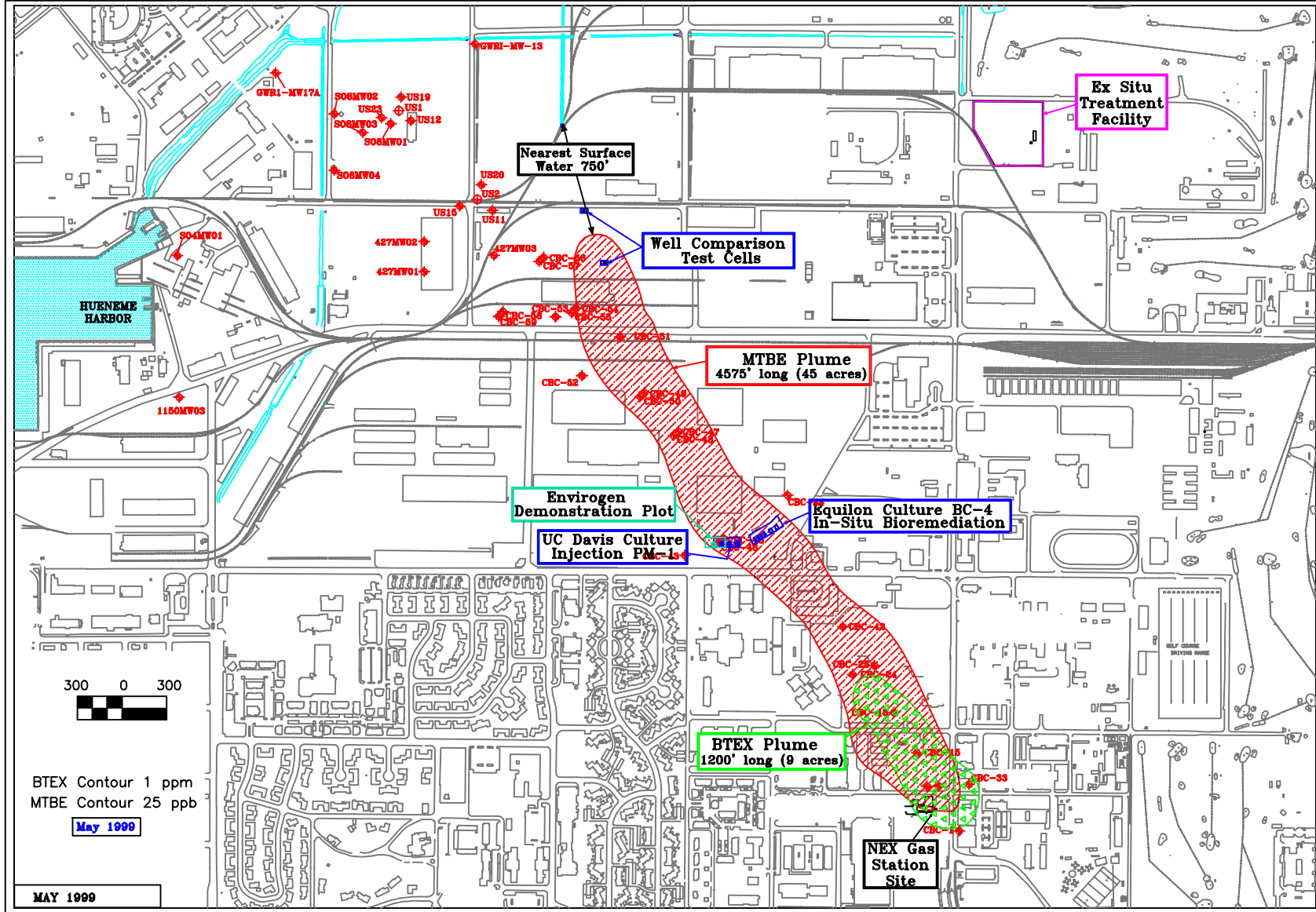

Princeton Research Center, 4100 Quakerbridge Road
Lawrenceville, New Jersey 08648



ESTCP – PROPANE BIOSTIMULATION WORKPLAN
PORT HUENEME, CALIFORNIA

FIGURE 2
PORT HUENEME PLUME MAP

SCALE
AS SHOWN

DESIGNED BY/DATE

DRAWN BY/DATE
JAS/06-30-00

CHECKED BY/DATE

SHEET SIZE
A

FILE #
base map

FIGURE #

2
OF

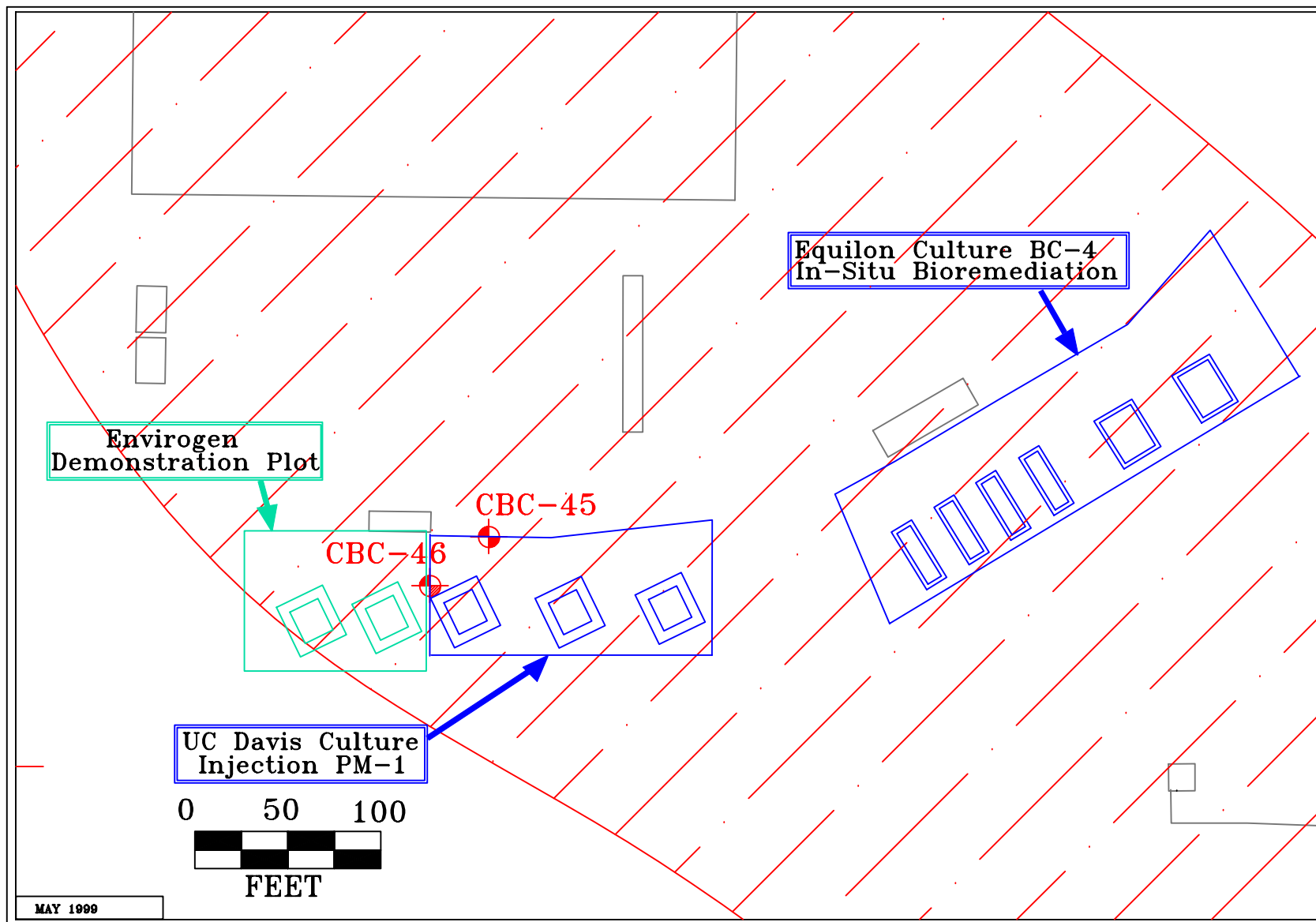

Princeton Research Center, 4100 Quakerbridge Road
Lawrenceville, New Jersey 08648



ESTCP – PROPANE BIOSTIMULATION WORKPLAN
PORT HUENEME, CALIFORNIA

FIGURE 3
LOCATION OF TEST PLOT

SCALE	AS SHOWN	SHEET SIZE	REVISION
DESIGNED BY/DATE		A	
DRAWN BY/DATE		FILE #	
CHECKED BY/DATE		base map_closeup	
		FIGURE #	
		3	
		SHEET	OF

1.3 REGULATORY DRIVERS

There is currently no federal drinking water standard for MTBE. However, the oxygenate has been added to both the Unregulated Contaminant Monitoring Rule (UCMR) and the Contaminant Candidate List (CCL) by the U.S. Environmental Protection Agency (USEPA) based on provisions of the Safe Drinking Water Act. The chemicals on each of these lists are likely candidates for the establishment of National Primary Drinking Water Regulations in the near future. In December 1997, EPA issued a Drinking Water Advisory that states concentrations of MTBE in the range of 20 to 40 µg/L of water or below will probably not cause unpleasant taste and odor for most people. The advisory is a guidance document that recommends keeping concentrations below that range. EPA also reviewed the available information on health effects in the 1997 advisory and stated that there is little likelihood that MTBE concentrations between 20 and 40 µg/L in drinking water would cause negative health effects (USEPA, 2002).

The California Department of Environmental Health Services (DHS) has recently established a primary Maximum Contaminant Level (MCL) for MTBE of 13 µg/L to protect public health and a secondary MCL of 5 µg/L to prevent taste and odor problems in groundwater (California Department of Environmental Health Services, 2002). Several other states such as Pennsylvania, New Jersey, and New York have followed California in reducing their groundwater standards for MTBE. The treatment objective in this demonstration was to reduce MTBE concentrations to below California's secondary MCL of 5 µg/L. This is the standard to which the demonstration data are compared.

Tert-butyl alcohol (TBA) is a fuel oxygenate, a common co-contaminant in MTBE-contaminated groundwater, and a product of MTBE degradation. Although TBA is a known toxin and a possible carcinogen, it is not currently an EPA priority groundwater pollutant. The recent introduction of drinking water standards for TBA in a number of states suggests that future regulation of TBA is likely (Bradley, et. al, 2002). The California Department of Health Services (DHS) has established an Action Level for TBA in drinking water of 12 µg/L. An Action Level (AL) is a health-based advisory level established by DHS for chemicals in drinking water for which an MCL has not been established. An AL is the level of a contaminant in drinking water that is considered not to pose a significant health risk to people ingesting the water on a daily basis. It is calculated using standard risk assessment methods for cancer and non-cancer endpoints, using typical exposure assumptions (California Department of Health Services Website). TBA concentrations reached in this demonstration are compared to California's Action Level of 12 µg/L.

2.0 TECHNOLOGY DESCRIPTION

2.1 TECHNOLOGY DEVELOPMENT AND APPLICATION

Propane biosparging technology is an extension of conventional biosparging methods. In conventional biosparging, air or pure oxygen is introduced into the subsurface via injection wells or points. In propane biosparging, oxygen and propane are also sparged into the subsurface via injection wells or points. In the case of propane biosparging, sparging is most often done in a pulsed mode. In some cases, as in the case of this demonstration, a bacterial seed culture is also injected into the subsurface to overcome the potential lag period that may be experienced by indigenous microbes.

The demonstration system consisted of a Control Plot and a Test Plot. Installed in the Test Plot was a network of oxygen points, bacteria injection points, propane injection points, and groundwater and soil-gas monitoring points. The oxygen, bacteria, and propane injection points were oriented in three rows perpendicular to groundwater flow to act as a bioreactive zone or biobarrier, with one monitoring well upgradient and a series of groundwater monitoring wells downgradient. In a propane biosparging configuration of this type, a bioreactive zone or biobarrier is created by the oxygen, bacteria, and propane injection points. The contaminated water passes through the biobarrier, and biological activity within the biobarrier is expected to reduce contaminant concentrations. Installed in the Control Plot was a network of oxygen injection points and groundwater and soil-gas monitoring points in a similar configuration.

Oxygen and propane were supplied by pressurized oxygen and propane tanks equipped with standard regulators. The tanks were connected to a manifold consisting of seven flow meters and injection lines per tank per plot. From the flow meter manifold, PVC piping was run to each of the injection points. The injection points are described in Demonstration Design section. Gas delivery was controlled by timer actuated solenoid valves. Sparging was done in a pulsed mode for several reasons. Pulsed injection promotes the dissolution of the substrates rather than inducing stripping of the contaminants, and minimizes the volatilization of contaminants and potential fugitive propane emissions. Also, pulsed injection rather than continuous injection is used because the amount of propane and oxygen required is typically low and does not require continuous injection. In most cases, and in the case of this demonstration, a gas recovery system is not needed because very little propane and oxygen are being injected. Soil vapor monitoring points were installed on the perimeter of the well networks to monitor fugitive propane and VOC emissions.

2.2 PREVIOUS TESTING OF THE TECHNOLOGY

Two demonstrations of this technology have been performed by ENVIROGEN for a confidential client. Both demonstrations occurred at a gasoline service station in Blackwood, New Jersey. In the first demonstration (August 2000 through January 2001), an SVE system was used as a

precaution to control fugitive emissions. Monitoring of the inlet to the vapor treatment system indicated that no fugitive emissions of propane or VOCs was being produced. In the second demonstration at the same site (August 2001 through January 2002), the New Jersey Department of Environmental Protection (DEP) approved a second demonstration of the technology without the use of the SVE system. In both of these demonstrations, a seed culture of ENV425 was injected to stimulate degradation.

The results of the first demonstration indicated that biodegradation of MTBE occurred in down-gradient monitoring wells. Decreases in MTBE concentrations ranged from 40 to greater than 90 percent in three onsite monitoring wells, with the greatest MTBE concentration reductions measured in a well directly downgradient of the treatment system. Details and results of this demonstration were reported to the DEP on March 2, 2001 and are described in detail in a chapter of the MTBE Remediation Handbook (Steffan et al., 2003) and elsewhere (Steffan et al., 2000). Similar MTBE degradation was observed during the second demonstration, but severe drought conditions and apparent changes in groundwater flow patterns made it difficult to quantify the results of the demonstration. Details and results of this demonstration were reported to the DEP on October 1, 2002.

2.3 FACTORS AFFECTING COST AND PERFORMANCE

Several factors may affect biostimulation treatment performance, including hydrogeologic characteristics, biogeochemical characteristics and contaminant concentration. Important hydrogeologic characteristics of the treatment zone that affect cost and performance include depth to the saturated zone and the presence of low-permeability lenses or layers that may affect the vertical and lateral distribution of injected substrates. Depth to the saturated zone affects cost of installing propane and oxygen injection points and monitoring wells, but it also may make alternative application strategies, such as installation of a trench, more economically favorable than the use of injection wells. Irregular distribution of oxygen and propane caused by heterogeneities may result in zones where little or no treatment can occur. Biogeochemical factors include the presence of indigenous propane/MTBE oxidizing microbes, availability of nutrients and neutral pH conditions in the aquifer. The status of biogeochemical factors should be assessed during background sampling and/or microcosm testing to determine if limitations exist. Exogenous bacteria can be injected to seed the aquifer with active cultures, buffering solutions can be added to adjust pH, or nutrients can be added to optimize conditions for treatment. The concentration and composition of the contamination in the aquifer may affect treatment performance. In general, higher concentrations of contaminants will require addition of more oxygen to create aerobic conditions in the treatment zone. If high concentrations of BTEX compounds are present, MTBE degradation may be inhibited until BTEX compounds have been degraded, and/or additional oxygen may be required to satisfy the biological oxygen demand created by the additional substrate. The result may be a longer lag-time to establish MTBE degradation or reduced treatment efficiency.

2.4 ADVANTAGES AND LIMITATIONS OF THE TECHNOLOGY

There are several potential advantages to using a biostimulation approach for degrading MTBE *in situ*. Biostimulation uncouples biodegradation of the contaminant from growth of the organisms. That is, the microbes can be supplied sufficient co-substrate (e.g., propane) to support growth, so they do not have to rely on the utilization of low levels of contaminants to maintain their survival. Equally advantageous is the fact that POB degrade both MTBE and TBA. In many parts of the country states have enacted strict regulations on TBA in groundwater, and TBA may be more difficult to treat than MTBE by using traditional technologies like air sparging or carbon adsorption.

Another advantage of this technology is its flexibility. Propane biosparging technology can be applied in a number of configurations depending on site characteristics and treatment needs. Possible application scenarios include: 1) re-engineered or modified multi-point AS/SVE systems that deliver propane and air throughout a contaminated site (suitable for use with existing AS/SVE systems or specially designed systems); 2) a series of air/propane delivery points arranged to form a permeable treatment wall to prevent off site migration of MTBE; 3) permeable treatment trenches fitted with air and propane injection systems; 4) *in situ* recirculating treatment cells that rely on pumping and reinjection to capture and treat a migrating contaminant plume; and 5) propane and oxygen injection through bubble-free gas injection devices to minimize off-gas release and contaminant stripping. Furthermore, propane is widely available, transportable even to remote sites, already present at many gasoline stations, and relatively inexpensive.

Propane biosparging also may allow treatment of MTBE that is trapped in tight soils that are not amenable to treatment by traditional technologies like pump and treat and air sparging. In demonstrations of biosparging with methane at the Savanna River Site, measurable increases in methane oxidizing bacteria were observed even in heavy clay soils that contained trapped contaminants (Bowman et al., 1993).

In addition to its many advantages, the technology has some limitations. As with most MTBE treatment technologies, propane biosparging can be affected by high levels of co-contaminants such as BTEX. Although many POB can degrade BTEX, the presence of BTEX may increase the oxygen demand in the aquifer, making it difficult to supply sufficient oxygen for propane and MTBE degradation. Additionally, co-metabolic systems can be difficult to operate efficiently, and care must be taken to ensure that the co-substrate (e.g., propane) concentrations do not reach levels that result in competitive inhibition of MTBE degradation. Thus, increased operator attention may be needed to perform cometabolic biosparging relative to operating traditional air sparging or biosparging systems. This disadvantage should be most pronounced during the initial phase of operation, but it should diminish once the system performance stabilizes. Also, many target aquifers may have few indigenous MTBE-degrading POB, and system performance may be delayed or reduced until sufficient numbers of POB are generated in the subsurface. In

some cases aquifer seeding (i.e., bioaugmentation) may shorten the performance lag period, but bioaugmentation adds to the cost of treatment and it may not be effective at all sites.

3.0 DEMONSTRATION DESIGN

3.1 PERFORMANCE OBJECTIVES

The primary performance objective was to evaluate the capabilities of the propane biostimulation approach to treat MTBE contamination to acceptable end-point concentrations, based on State groundwater quality standards. Other specific performance objectives are included in Table 2. Because the performance of the treatment process is dependent upon site specific factors, the demonstration was designed to allow direct assessment of the following performance indicators:

- Distribution, population and growth of indigenous bacteria,
- Distribution and fate of oxygen and propane,
- Biogeochemical conditions,
- Hydrogeological characteristics including groundwater flow velocity and contaminant transport characteristics,
- Contaminant distribution and concentration trends.

These indicators were evaluated to assess the actual performance of the demonstration system.

TABLE 2
PERFORMANCE OBJECTIVES
 ESTCP Propane Biosparging Demonstration
 Port Hueneme, CA

Type of Objective	Primary Performance Criteria	Expected Performance (Metric)	Actual Performance
Qualitative	Faster Remediation	Reach endpoint in test plot before control plot	Objective not fully met
Qualitative	Safe Operation	No explosion hazard created by system operation	Objective met
Quantitative	Reduce MTBE to drinking water levels	MTBE concentrations reduced to < 5 µg/L in Test Plot	Objective not fully met
Quantitative	Reduce TBA to CA Action Level	TBA concentrations reduced to < 12 µg/L in Test plot	Objective not fully met
Quantitative	Reduce MTBE levels	[MTBE] reduction in Test Plot monitoring wells.	Objective met
Quantitative	Reduce TBA levels	[TBA] reduction in Test Plot monitoring wells	Objective met
Quantitative	Stimulate POB	Increased POB numbers in Test Plot	Objective met

3.2 SELECTING TEST SITE

Prior to designing the field demonstration system, a test area within the NETT Site was selected in conjunction with NETTS and Port Hueneme personnel based on a review of relevant site reports and results of previous field demonstrations at the Site. The following are the primary criteria that were used to select the ideal demonstration location:

- Investigation data describing subsurface soils, historical groundwater table elevations, and contaminant distribution (some pre-demonstration subsurface characterization is assumed),
- A relatively permeable ($\geq 10^{-4}$ cm/sec) and homogeneous vadose zone and saturated zone,
- A well characterized and simple groundwater flow regime,
- Groundwater concentrations of MTBE in the 1,000 to 10,000 $\mu\text{g/L}$ range,
- Groundwater total BTEX concentrations of less than 100 $\mu\text{g/L}$,
- No LNAPL, and
- Neutral pH.

These primary criteria were met at the chosen site. Additional secondary considerations for selecting the test area included:

- the availability and types of previously installed test wells,
- proximity to and types of previously installed test equipment (i.e., vacuum pumps, compressors, vapor treatment systems, etc.),
- the status of any previously required air permits,
- open area with sufficient clearing around the Test Plots, and
- potential for interference with or from normal day-to-day site activities.

Based on these primary and secondary criteria, the plume area at the NETTS site situated approximately 2,400 feet southwest of the NEX service station was chosen for the demonstration, as described in the Test Site Description below.

3.3 TEST SITE DESCRIPTION

The location of ENVIROGEN's demonstration plot is shown in Figures 2 and 3. The National Environmental Technology Test Site (NETTS) at the Naval Construction Battalion Center (CBC), Port Hueneme, California, was chosen to host the propane biosparging technology demonstration. The Port Hueneme NETTS facility is located approximately 70 miles northwest of Los Angeles. The Naval Exchange (NEX) service station is the source of the petroleum plume that occurs on the Port Hueneme CBC facility. According to NEX inventory records, approximately 4,000 gallons of leaded and 6,800 gallons of unleaded premium gasoline were released from the distribution lines between September 1984 and March 1985. The resulting groundwater plume consists of approximately 9 acres of BTEX, extending 1,200 feet from the NEX service station, and approximately 36 additional acres of MTBE contamination, extending

approximately 4,500 feet from the NEX service station. A map of the contaminant plume is presented in Figure 2. The plume area situated approximately 2,400 feet southwest of the NEX station was chosen for the demonstration. The location of ENVIROGEN's demonstration plot is shown in Figures 2 and 3. It is located adjacent to the existing University of California at Davis (U.C. Davis) and Equilon, Inc. demonstration plots. The ENVIROGEN plot is approximately 90 feet by 60 feet and includes a Test Plot and a Control Plot. As this is a NETTS Site, several other technology demonstrations are in progress on the plume by U.C. Davis, Equilon, and others. The plots were located such that activity in one demonstration plot did not affect demonstration activities on another plot. No p

The geology and contaminant concentrations in this area are well characterized, as several soil borings, cone penetrometer test soundings and monitoring wells have been performed and sampled. Prior site characterizations include installation of 4 monitoring wells (CBC-43, CBC-44, CBC-45 and CBC-46) and nine cone penetrometer (CPT) soundings. Groundwater contamination consists primarily of MTBE and low levels of BTEX. In addition, groundwater flow direction and velocity have been monitored at the U.C. Davis and Equilon plots and at surrounding monitoring wells in conjunction with ongoing bioaugmentation studies.

The geology at the site consists of unconsolidated sediments composed of sands, silts, clays and minor amounts of gravel and fill material. A shallow, semi-perched, unconfined aquifer is the uppermost water-bearing unit. The shallow aquifer is comprised of three depositional units: an upper silty-sand, an underlying fine- to coarse-grained sand and a basal clay layer. Based on CPT soundings, the upper silty-sand unit ranges between 8 to 10 feet thick and the underlying sand is approximately 12 to 15 feet thick. The water table is generally encountered at depths between 6 to 8 feet bgs, with seasonal fluctuations ranging between 1 and 2 feet, yielding a saturated aquifer thickness of 16 to 18 feet near the test area.

The following groundwater flow parameters were estimated from data available prior to the demonstration. Groundwater flow was estimated to be generally to the southwest under hydraulic gradients between 0.001 and 0.003 ft./ft. Transmissivity estimates for the shallow aquifer were derived based on pumping tests and slug tests, with results ranging between 2,500 and 6,500 ft²/day. Based on an average saturated thickness of 15 feet, hydraulic conductivity estimates range between 170 and 440 ft/day (6×10^{-2} to 2×10^{-2} cm/s). Estimated groundwater flow ranges between 177 and 480 feet/year, assuming an aquifer porosity of 0.35. However, tracer studies conducted by the U.S. EPA during pre-demonstration activities indicated that groundwater flow velocity was lower than estimated (See Section 2.4.2), at 0.2 to 0.3 feet/day, or approximately 75 to 110 feet/yr.

Groundwater contamination is limited to the semi-perched aquifer across the CBC facility. Monitoring wells CBC-45 and CBC-46 (see Figure 3) represent the groundwater quality conditions within the dissolved MTBE plume near the demonstration site. Historical groundwater sampling from these wells between September 1998 and September 1999 indicated

MTBE concentrations ranging between 6,300 to 3,500 $\mu\text{g/l}$ at CBC-45 and 4,000 to 1,100 $\mu\text{g/l}$ at CBC-46. Apart from a TBA detection of 470 $\mu\text{g/l}$ at CBC-45 in June 1999, none of the other samples exhibited TBA or BTEX compound concentrations above their respective practical quantitation limits.

3.4 PRE-DEMONSTRATION ACTIVITIES

Because the preferred demonstration location had been well characterized during site investigation and ongoing demonstration activities, a limited scope of testing was required prior to design and installation of the demonstration Test and Control Plots. The testing strategy consisted of the following elements:

- site characterization confirmation sampling to verify the design of the demonstration system,
- microcosm studies to evaluate capabilities of propane oxidizing bacteria at the demonstration location, and
- background monitoring to establish a baseline before initiating treatment.

In addition to the predemonstration activities described in Section 3.4, sparge testing, tracer studies, and baseline monitoring and vapor monitoring are discussed in Section 3.5.2. These activities are included in Section 3.5.2 because they occurred after system installation, which is described in Section 3.5.1.

3.4.1 SITE CHARACTERIZATION CONFIRMATION SAMPLING

Pre-demonstration soil and groundwater sampling was performed at the selected location to verify groundwater contaminant concentrations and to confirm the final biosparging system design. The results of anion and oxygen demand parameter analysis were used to confirm the use of sodium bromide as a tracer and to refine oxygen requirements for the demonstration. Four Geoprobe™ borings were installed in the test area, including two at each of the proposed Test and Control Plots, to allow collection of soil and groundwater samples. The Geoprobe™ borings were continuously sampled from the ground surface to a depth of approximately 20 feet.

Limited confirmation sampling and testing was conducted in June 2000, and baseline samples were taken in January, April and May 2001 to establish the baseline contaminant concentrations and distributions at the demonstration site.

3.4.2 MICROCOSM STUDIES

A biotreatability study was performed to evaluate biostimulation of propane oxidizing bacteria (POB) for *in situ* degradation of MTBE at the NETTS site. The study involved amending Port Hueneme site aquifer samples with oxygen and/or 1) propane; 2) propane and nutrients; and, 3) propane, nutrients, and bacterial strain ENV425, which grows on propane and degrades MTBE (Steffan et al., 1997). Propane concentrations and MTBE degradation were monitored by gas chromatography to evaluate POB response times, degradation rates, and expected treatment levels. The study also evaluated the effectiveness of seeding the aquifer materials with

degradative bacteria (i.e., ENV425) to speed the treatment process. Results were also used to identify the best locations at the site (i.e, upgradient near the source area, and down gradient near existing treatment demonstration plots) for the demonstration.

Microcosm Setup

Treatability samples (microcosms) consisted of Port Hueneme aquifer samples (soil and groundwater) incubated in glass 160-ml serum vials. Sediment and groundwater samples were collected from 2 areas within the resident MTBE plume. One area was adjacent to the existing Air Sparging Site 1, and the other was adjacent to the UC Davis Test Plot. The samples (approximately 1 L of sediment and 6 L groundwater) were collected using a Geoprobe™ rig, and were shipped overnight to ENVIROGEN. The soil was mixed and then screened to remove large stones that would not fit into the serum vials. Fifty grams of the soil was added to each serum vial, and 60 mL of groundwater was added to create a slurry.

Triplicate microcosms were then amended with 1) no additions; 2) nutrients (3 mg/L phosphorous, 5 mg/L nitrogen); 3) strain ENV425 (10^6 cells/ml); 4) strain ENV425 (10^7 cells/ml); 5) strain ENV425 (10^9 cells/ml); or 6) HgCl (1 ml of 7.4%) and sodium azide (1 ml of 15%). The vials were gassed with either oxygen or a 1:1 mixture of propane and oxygen, and the vials were sealed with Teflon®-lined septa and crimp seals. The microcosms were then placed on their sides and incubated with shaking (100 rpm) at 15 °C.

To sample the microcosms, the vials were removed from the shaker and allowed to warm to room temperature. Then, 10 µL of headspace gas removed from each microcosm and was injected onto a gas chromatograph equipped with a flame ionization detector (GC-FID) to measure propane in the head space. Next, 1 mL of microcosm slurry was removed from the vial and placed into a micro-centrifuge tube. The tube was centrifuged for 30 sec to remove the solids from the slurry, and the supernatant fraction was placed in a 2-ml auto sampler vial. One microliter of the sample was removed from the vial and injected onto the GC-FID. The GC-FID method had a detection limit of approximately 500 µg/L MTBE. If a lower detection limit was desired (i.e., to 5 µg/L) up to 5 mL of slurry was removed from the microcosms and analyzed by purge and trap/GC/mass spectrometry (USEPA Method 8260). The headspace of the microcosms was typically replaced with oxygen or oxygen and propane after each sampling event, as were the septa and crimp seals.

Treatability Study Results

Initial MTBE concentrations in samples from the Air Sparging Site (ASpS) were considerably higher than those taken near the UC Davis plot (UCD). The ASpS samples contained between 13 and 20 mg/L of MTBE, whereas MTBE in the UCD samples ranged from about 3 to 4 mg/L. Both of these concentration ranges are within the range of MTBE concentrations that can be degraded by strain ENV425 (Steffan et al., 1997). In addition to MTBE, samples from the ASpS appeared to contain other gasoline components, as indicated by a strong hydrocarbon odor.

MTBE concentration in the ASpS microcosm samples decreased with time under each treatment scenario tested; even in the poisoned control samples (Figure 4). In all cases, however, MTBE concentrations did not go as low as 1 mg/L during the 30 day treatment, even though propane

Figure 4. MTBE Concentrations in Microcosms from the Air Sparging Site

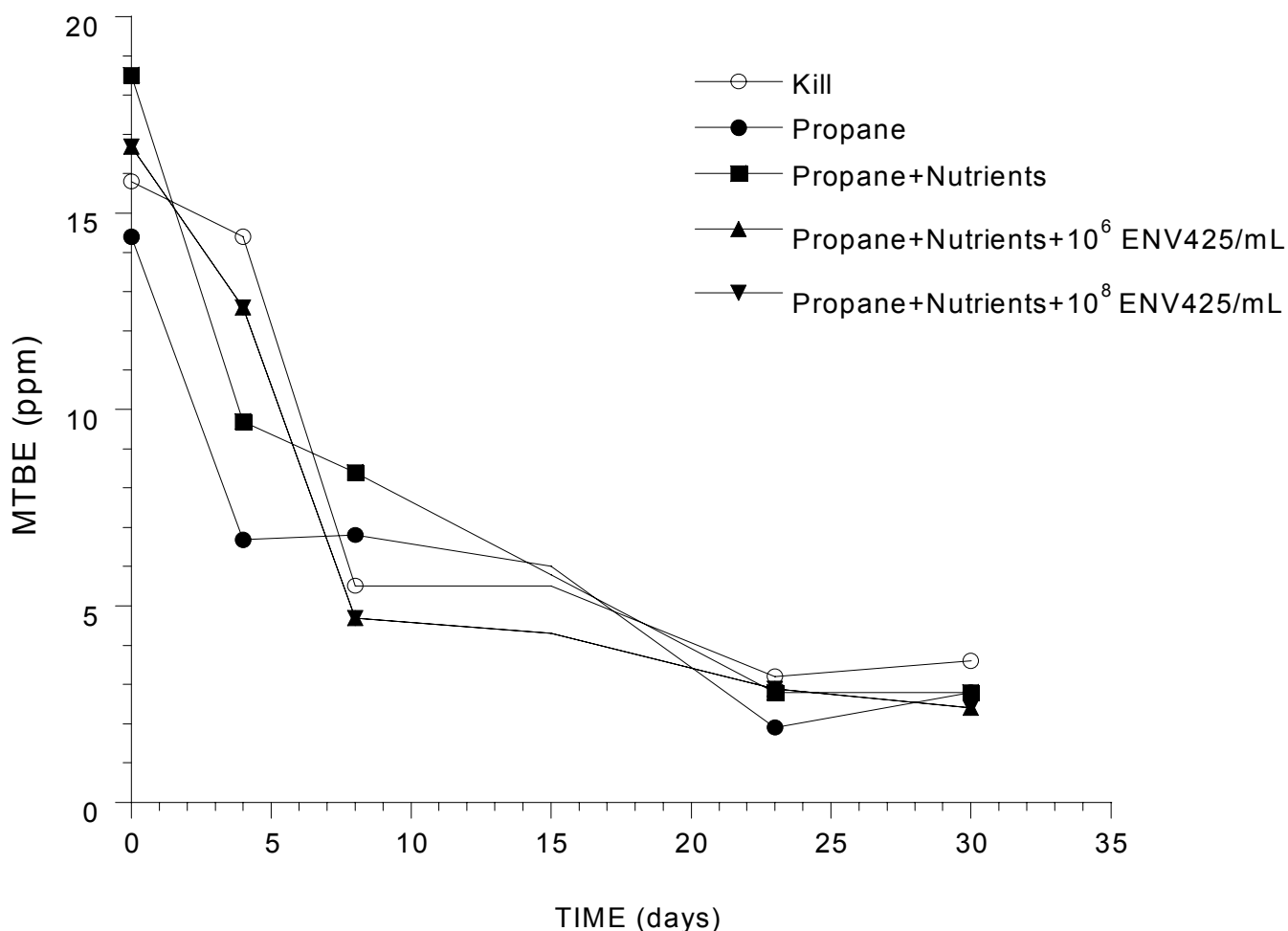

oxidizing bacteria can degrade high concentrations of MTBE (Steffan et al., 1997). This suggested that other factors, such as the presence of other gasoline components, might slow MTBE degradation in the ASpS location. The exact compounds causing the apparent inhibition are not known, but strain ENV425 can degrade both BTEX and MTBE. Typically, however, the strain degrades BTEX before degrading MTBE. Thus, the high levels of gasoline components in the ASpS samples may have inhibited MTBE degradation by delaying the onset of MTBE

degradation. Likewise, the high levels of gasoline compounds may have inhibited MTBE degradation by creating a high oxygen demand that depleted the available oxygen in the microcosm samples. It is unlikely that these other organic compounds caused acute toxicity.

In microcosms constructed using samples collected near the UCD plots, MTBE degradation occurred at about the same rate in both the samples that received oxygen only, and the samples receiving oxygen and propane (Figure 5). In each case, however, MTBE concentrations declined only from about 2.5 mg/L to 1.5 mg/L during a 70-day incubation. Likewise, little propane degradation was observed in the microcosms amended with propane (Figure 6). Conversely, MTBE degradation was rapid in samples seeded with 10^8 CFU/ml of propane-grown ENV425 (Figure 7), even before propane was added on day 82. The arrows at the top of Figure 7 indicate time points at which supplemental MTBE was added to the microcosms. The degradation of MTBE by ENV425 was accompanied by a transient accumulation of TBA. TBA did not accumulate to significant levels once the rate and frequency of MTBE addition was reduced to allow the cells to degrade accumulated TBA (approximately day 20 to 35). MTBE and TBA degradation in the ENV425-amended microcosms ceased at approximately day 70, but resumed when propane was added on day 82. The reason that strain ENV425 was able to degrade so much MTBE without the addition of propane is unclear, but it suggested that the strain was able to derive some energy from MTBE degradation, and that the genes remained induced in the strain for some time.

Figure 5. MTBE Biodegradation in Microcosms Amended with Oxygen or Propane and Oxygen

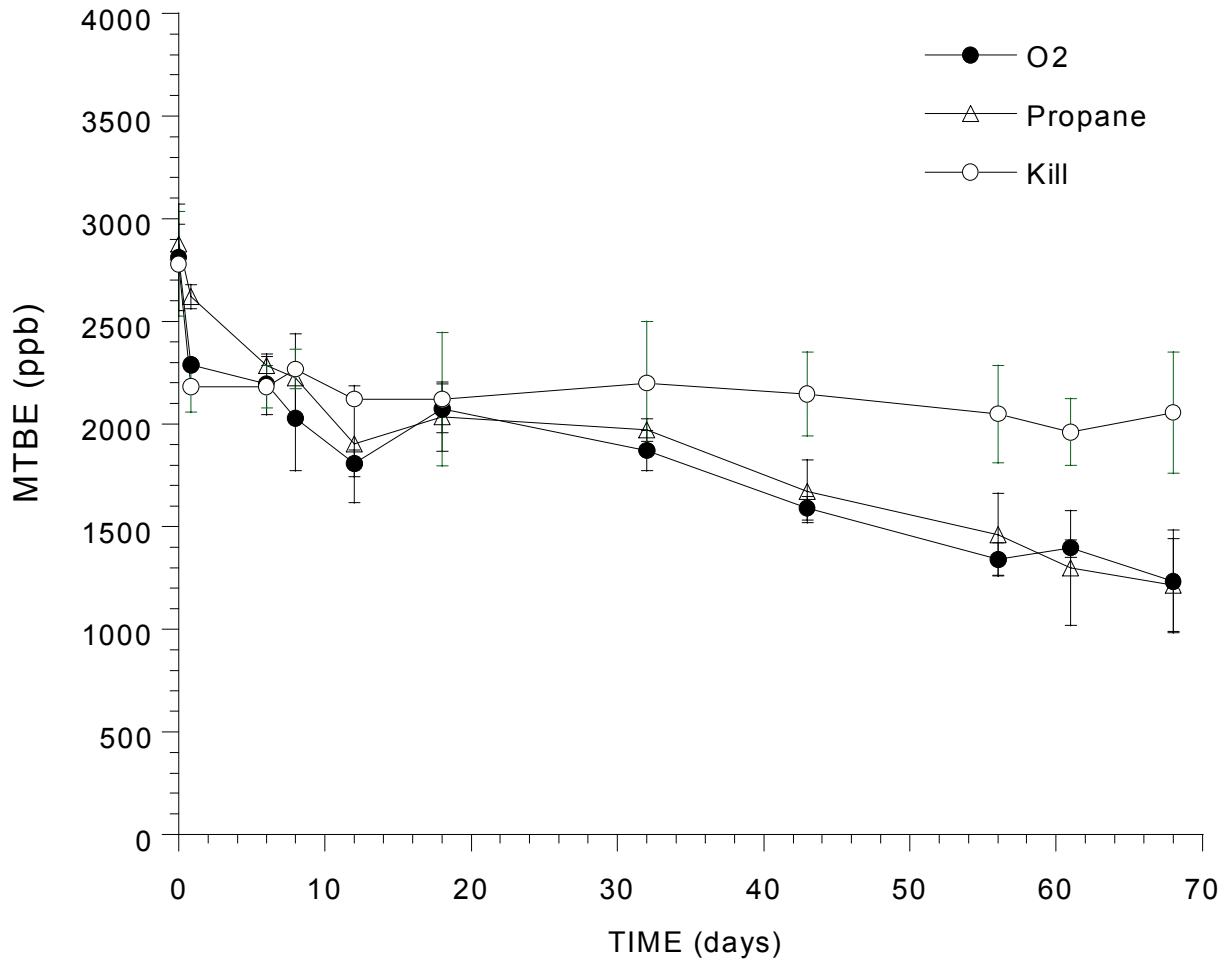

Figure 6. Biodegradation of Propane in Aquifer Microcosms

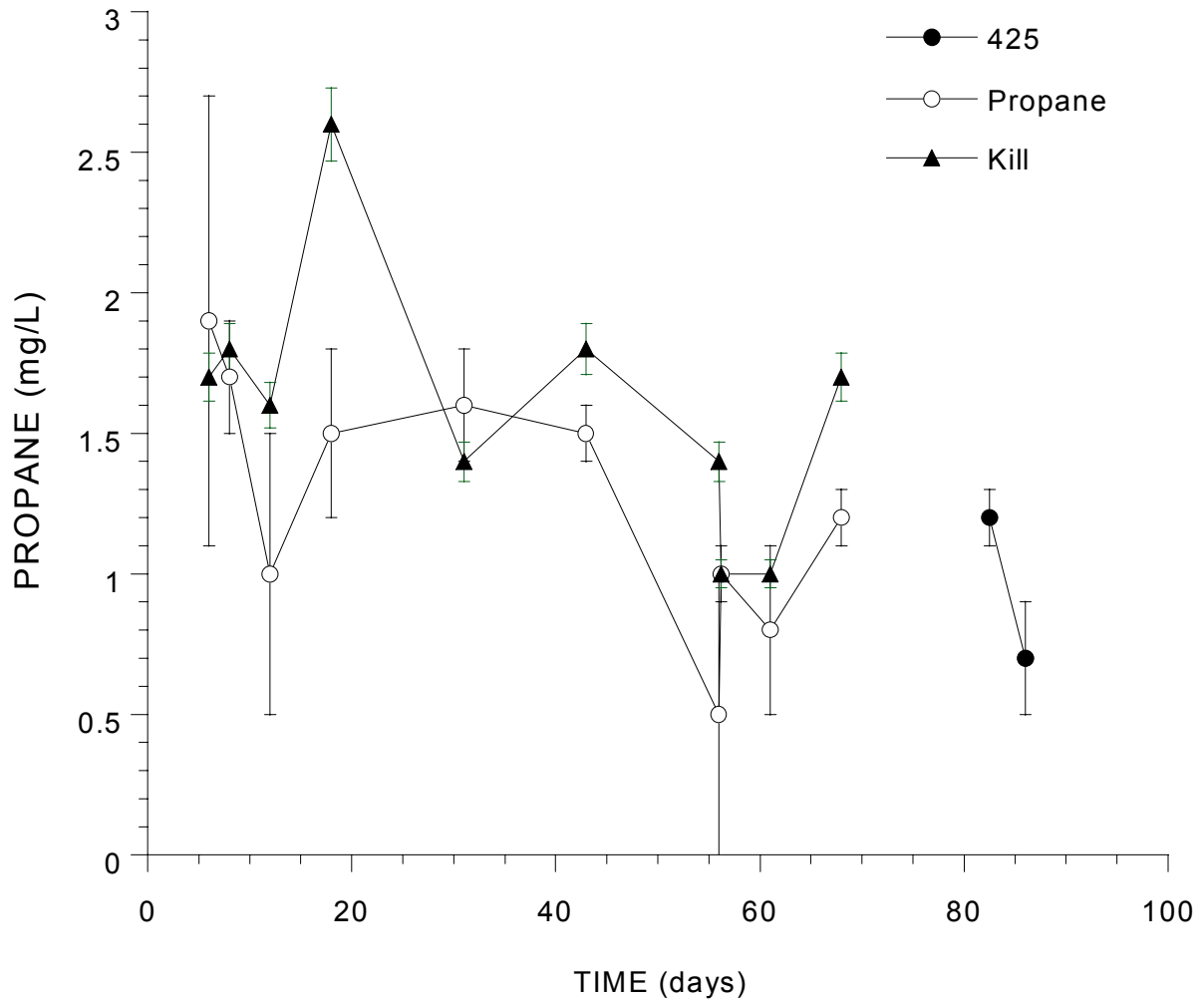
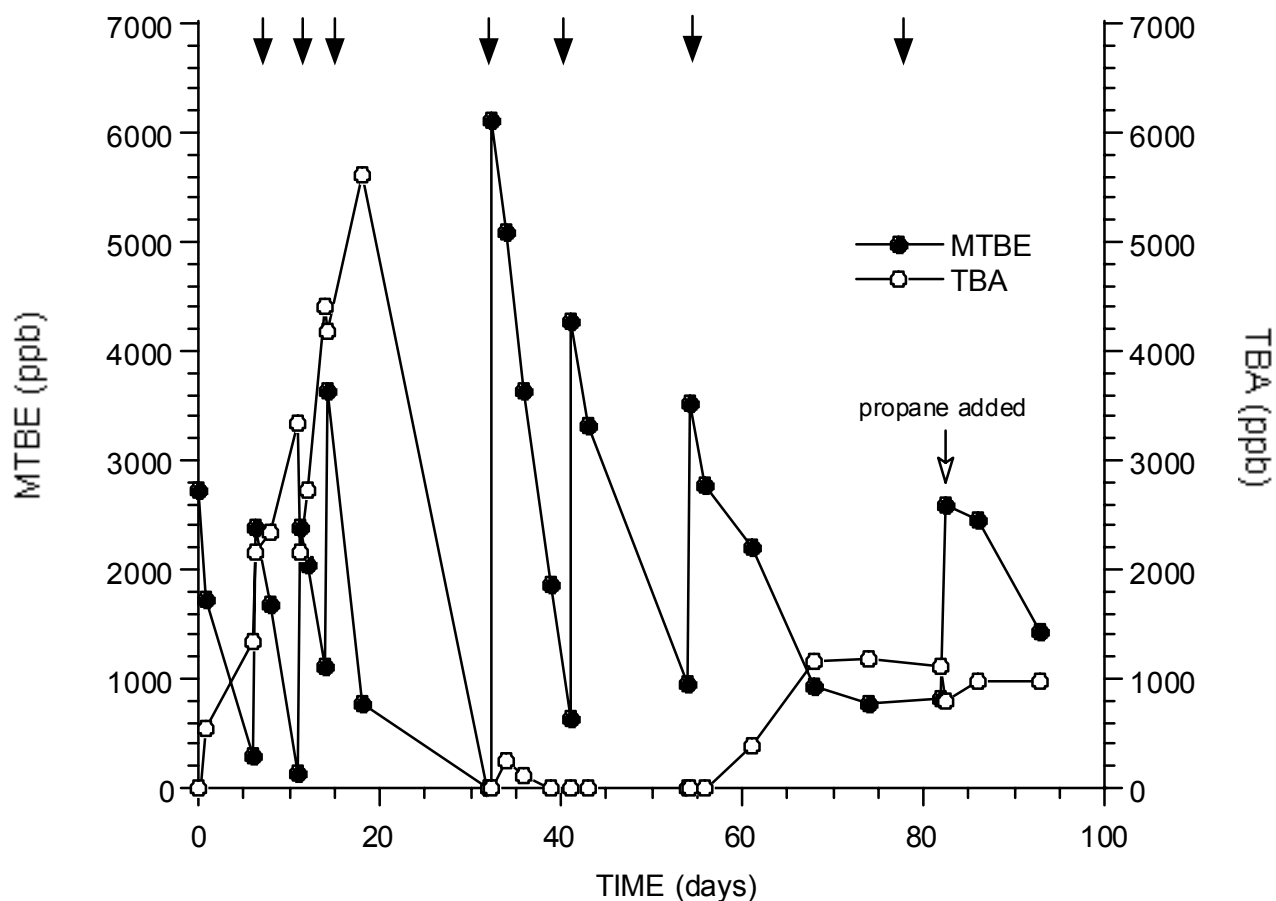

Figure 7. MTBE Biodegradation in Microcosms Amended with $\sim 10^8$ CFU/mL of ENV425



Treatability Study Conclusions

Results of the treatability testing suggested that the greatest likelihood of success with the field demonstration would be achieved by performing the demonstration in the UCD area. The results also indicated that MTBE would likely be degraded by indigenous organisms at the site, which was consistent with the results of Salanitro et al. (2000). Like the Salanitro study, this microcosm study suggested that MTBE degradation by indigenous microbes would require a significant lag period. In the case of the microcosms used in this study, the lag period was at least 30 days, but Salanitro and colleagues reported a lag period of more than 200 days under field conditions. Conversely, if the microcosms were seeded with 10^8 CFU/ml of ENV425, there was essentially no lag period. Furthermore, the added microbes could degrade repeated additions of MTBE, and TBA accumulation was transient and minimal, provided MTBE loading rates were not excessive. Thus, the microcosm data indicated that propane oxidizing bacteria could be successfully employed to degrade MTBE in the Port Hueneme aquifer. They also

suggested that degradation would be sufficiently faster in treatment plots seeded with ENV425 and fed propane than in plots fed only oxygen to measure the effect of the treatment relative to background levels of degradation by indigenous microbes.

Growth of Bacterial Strain ENV425

The strain ENV425 (ATCC55798) was isolated from uncontaminated turf soil by enrichment culturing with propane as the sole source of carbon and energy. The culture degrades MTBE and TBA rapidly (Steffan et al., 1997), and it forms yellow pigmented colonies that are distinguishable among a background of other microbe colonies on R2A agar (BBL) plates. The colonies become salmon color as they age.

For this project the culture was grown in three steps. Initially, the culture was grown in a 250-ml PYREX flask with 100 ml of sterile Basal Salt Media (BSM) containing 0.12 M lactate. The flask was placed in a shaker-incubator at 28 °C for two days until the optical density and 550 nm (OD_{550}) of suspension was 0.9.

The grown culture from the 250-ml flask was transferred aseptically to a 2-liter flask containing 800-ml of sterile BSM. Lactic acid was added to the flask to the same concentration noted above. Again, the culture was incubated in a shaker-incubator at 28 °C for one day ($OD_{550} = 1.6$). The 800 mL of culture was then aseptically transferred to a 20-L fermentor containing 16 liters of sterile BSM with 0.12M lactate. The initial OD_{550} of the culture was 0.08. The initial fermentor conditions were as follows: air flow rate 5- 5.5 l/min, agitator speed-200 rpm, pH-6.8-7.2, temperature-28-30 C. For pH control either 2M H_2SO_4 or 5N NaOH was added. For foam control, antifoam 289 (SIGMA) was applied automatically.

After all lactic acid was consumed during the first 23 hours and the OD_{550} reached 1.1, the fermentor was switched to a continuous feed of undiluted lactic acid sodium salt syrup (60% w/w) at a feed rate of 1.8 ml/h. During the following 5 days of growth the feed rate was gradually increased to 3.4 ml/h based on oxygen concentrations in the reactor. The final OD_{550} reached 16. To maintain the oxygen level in the fermentor at 1-2 mg/l without intensive foam formation, supplied air was enhanced with pure oxygen at a rate of 300 ml/min. On the final day of culturing, the lactate feed was switched to propane with a gradual increase in propane flow rate from 25 to 100 ml/min. To avoid formation of an explosive mixture of propane and oxygen, the oxygen feed was stopped and air flow was adjusted to prevent the propane from being in its flammable range in air (2.15-9.61 % by volume). The strain specific growth rate for ENV425 was 0.1 h^{-1} with a doubling time of 6.4 h. The final volume of bacterial suspension was 16.0 liters with $OD_{550}=16$. The strain was tested by performing an MTBE bottle assay (Steffan et al., 1997) to confirm that it had high MTBE degradation activity. The culture was then transferred to a 5-gallon plastic bottle and shipped overnight on ice to the Port Hueneme field site.

3.5 TESTING AND EVALUATION PLAN

3.5.1 DEMONSTRATION INSTALLATION

The demonstration system consisted of a network of oxygen and propane injection points, pressurized oxygen and propane gas delivery and control systems, and groundwater and soil-gas monitoring networks constructed by ENVIROGEN. Figure 8 illustrates the layout of the demonstration system. In addition to the Envirogen system, the U.S. EPA installed additional tracer injection wells, groundwater monitoring points and soil-gas monitoring points to facilitate performance monitoring. ENVIROGEN and NETTS personnel provided oversight during drilling, electrical and plumbing activities. The following sections describe the design and installation of the demonstration system components.

Test and Control Plot Configuration

The Test and Control Plot configurations were designed based on the range of groundwater flow velocities, MTBE concentrations, and estimated oxygen requirements arising from geochemical and biological demand. Data acquired during site characterization confirmation sampling (Section 2.1) were used to finalize the design and refine the operating characteristics of the system prior to equipment procurement and installation. The results of the microcosm studies indicated that injection of a bacterial seed culture was required to promote rapid degradation of MTBE from the onset of the demonstration.

The Test Plot included a network of oxygen, propane, tracer, and bacteria injection wells, and groundwater and vapor monitoring networks, as shown in Figure 9. Eight (8) oxygen injection points (OIPs), seven (7) propane injection points (PIPs) and seven (7) bacteria injection points (BIPs) were installed. The OIPs were spaced 3.28 feet apart on a line perpendicular to groundwater flow. The BIPs and PIPs were placed approximately 2.3 feet and 4.9 feet downgradient of the OIPs, respectively, and were off-set from the OIPs. The Test Plot groundwater performance monitoring network consisted of fifteen (15) dual-level, nested wells. This network included one background well placed along the centerline of the plot, approximately 12.1 feet upgradient of the OIPs. The remaining performance monitoring wells were placed in 4-rows of three nested wells each and 1 final row of 2 nested wells. The wells were placed at downgradient distances of 7.5, 10.8, 13.1, 16.7, and 21.7 feet from the OIPs. The center well in each row was aligned with the centerline of the OIPs, with a 5.7 feet off-set for each well on the end of the row. Each set of nested wells included a “shallow” well and a “deep” well. ENVIROGEN’s soil-gas monitoring network consisted of 6 vapor monitoring points (VMPs) distributed around the OIPs and PIPs.

In addition to ENVIROGEN’s monitoring network, the U.S. EPA installed a series of multilevel groundwater monitoring points (23), soil-gas monitoring points (8) and tracer injection points (19) to allow collection of performance monitoring data.

The Control Plot was similar in configuration to the Test Plot, except that no propane injection points nor bacteria injection points and fewer monitoring points were installed. The Control Plot configuration is illustrated in Figure 10. Eight (8) OIPs were installed at 1-meter (3.28 feet)

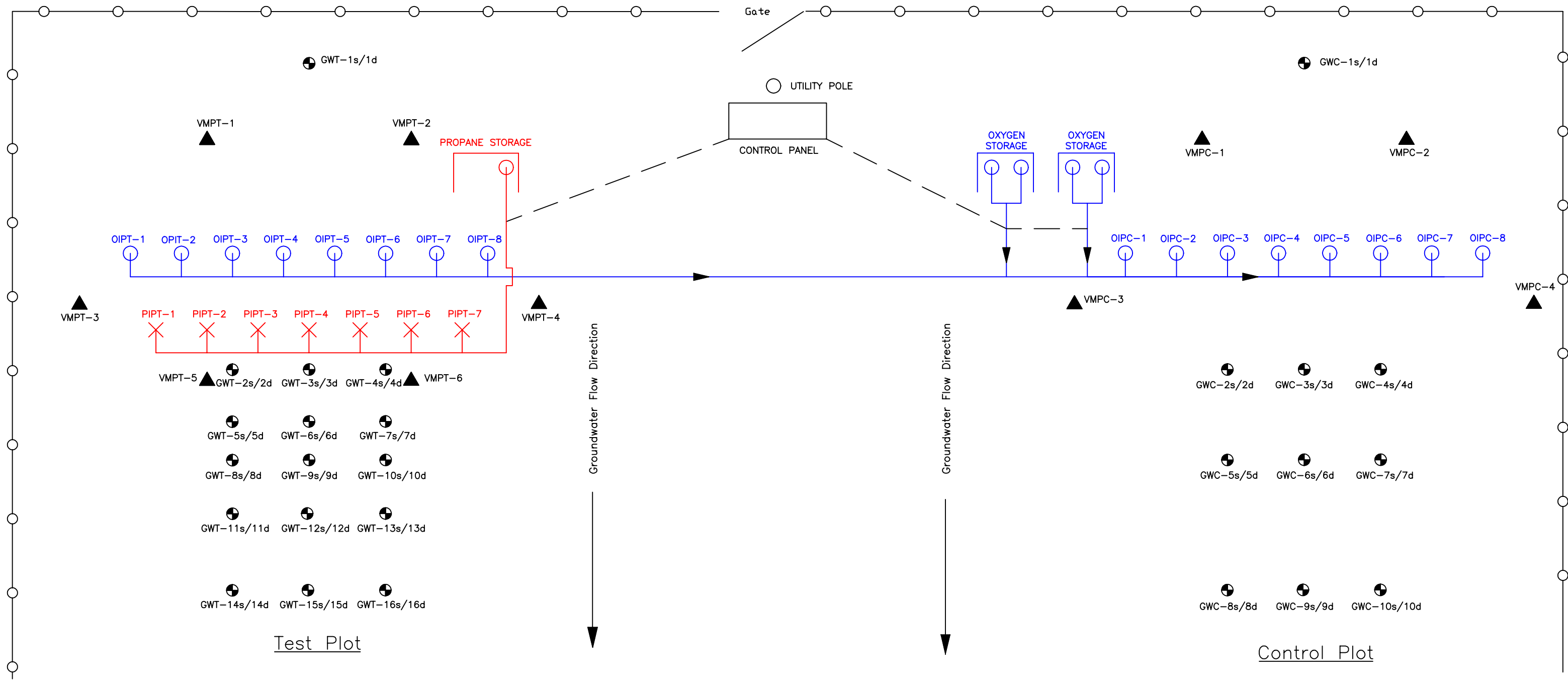

LEGEND

- ⊕ Groundwater Monitoring Well / Probe (GWT-1)
- ⊙ Oxygen Injection Point (OIPT-1)
- × Propane Injection Point (PIPT-1)
- ▲ Vapor Monitoring Probe (VMPT-1)
- Oxygen Distribution System
- Propane Distribution System
- - - 24 V Power For Solenoid Controls

NOTE: EPA monitoring network not shown.
See Figures 6 and 7 for details.

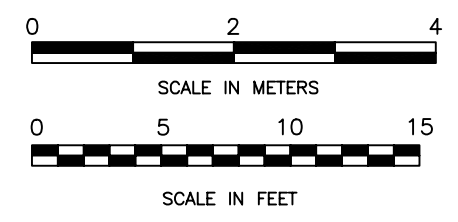

DRAWN BY	SC,JS
CHK'D BY	JQ
SCALE:	1" = 2 m
DATE	06/30/00
APP'D BY	ENGR'G.
APP'D BY	PROJ. MGR.
APP'D BY	

ENVIROGEN
PRINCETON RESEARCH CENTER
4100 QUAKERBRIDGE RD.
LAWRENCEVILLE, N.J. 08648



Figure 8
Demonstration Area Layout

ENVIROGEN PROJECT NO. 92132		
Port Hueneme		
SIZE B	DRAWING NO. demonstration area.dwg	REV. A

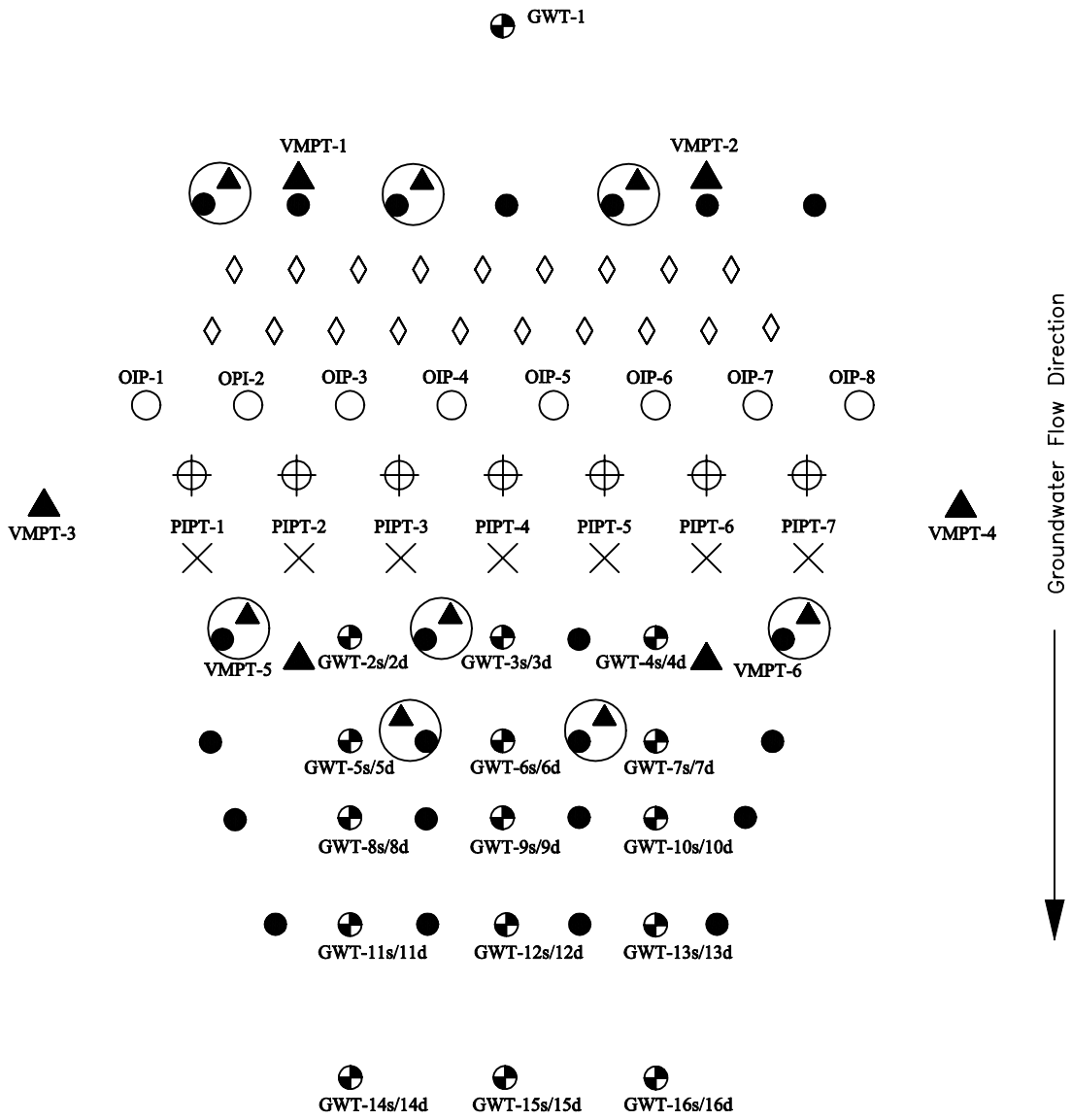

LEGEND

- ⊕ Dual-Level Groundwater Monitoring Well / Probe (GWT-1)
- Oxygen Injection Point (OIP-1)
- × Propane Injection Point (PIPT-1)
- ▲ Vapor Monitoring Probe (VMPT-1)
- ⊕ Bacteria Injection Point

EPA NETWORK

- Vapor Monitoring Probe
- 3 Level Groundwater Monitoring Point
- 3 Level Monitoring Point
- Tracer Injection Point

Note:
 Oxygen Injection Points are 1m on center.
 Propane Injection Points are 1m on center.
 Vapor Monitoring Probes are 4m on center.
 Groundwater Monitoring Wells are 1.75m on center.

Test Plot

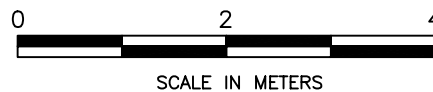

DRAWN BY	JS
CHK'D BY	JQ
SCALE:	1" = 2m
DATE	06/30/00
APP'D BY	ENGR'G.
APP'D BY	PROJ. MGR.
APP'D BY	

ENVIROGEN
 PRINCETON RESEARCH CENTER
 4100 QUAKERBRIDGE RD.
 LAWRENCEVILLE, N.J. 08648

FIGURE 9
 Demonstration Area
 Layout for the Test Plot



ENVIROGEN PROJECT NO.
 92132

Port Hueneme

SIZE	DRAWING NO.	REV.
A	Figure 8.dwg	A

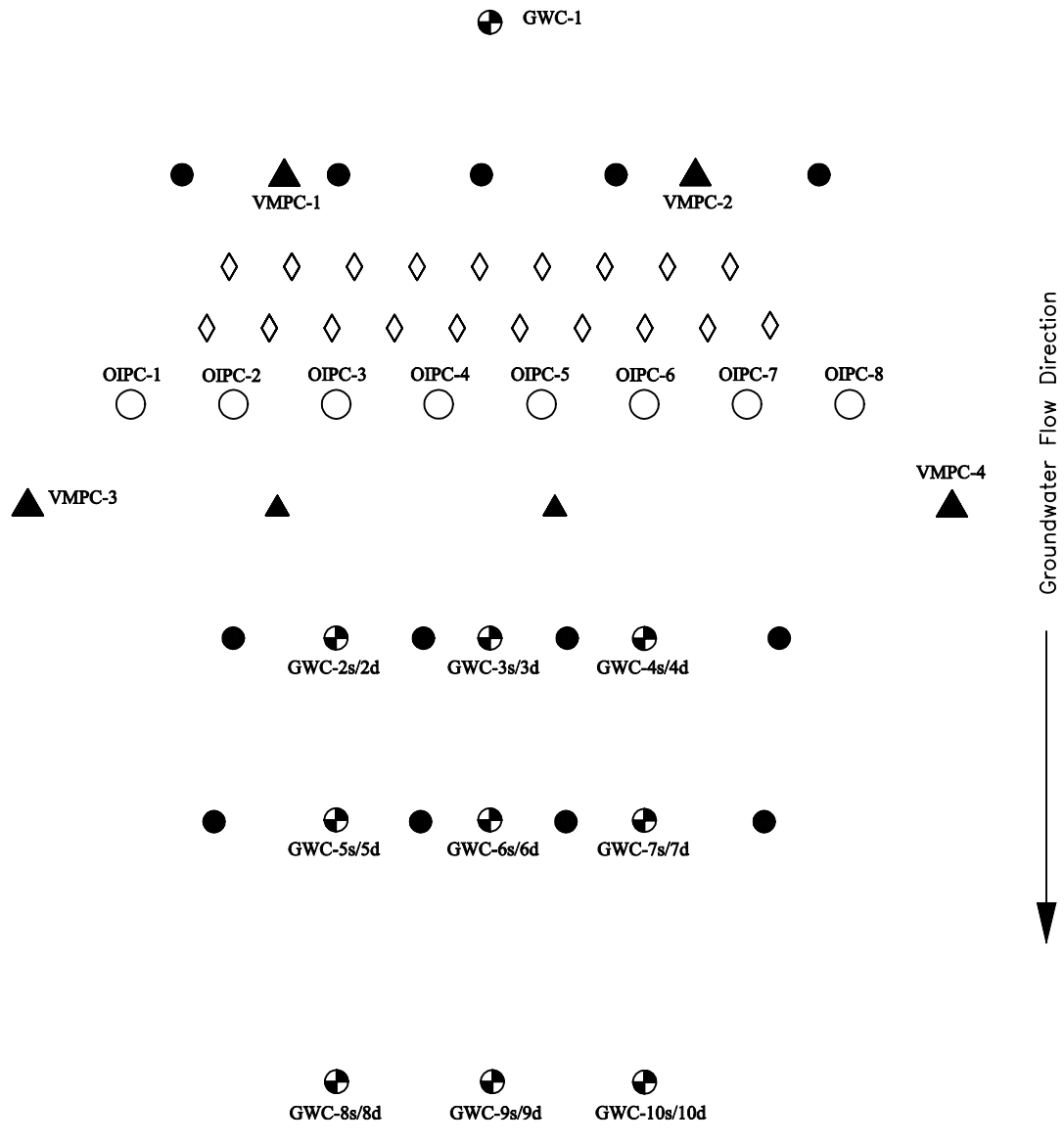

Control Plot

LEGEND

- Dual-Level Groundwater Monitoring Well / Probe (GWC-1)
- Oxygen Injection Point (OIPC-1)
- × Propane Injection Point (PIPC-1)
- ▲ Vapor Monitoring Probe (VMPC-1)

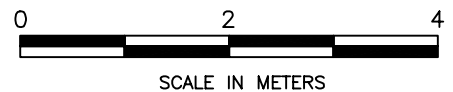

EPA NETWORK

- 3 Level Groundwater Monitoring Point
- ▲ Vapor Monitoring Probe
- ◇ Tracer Injection Point

Note:
 Oxygen Injection Points are 1m on center.
 Vapor Monitoring Probes are 4m on center.
 Groundwater Monitoring Wells are 1.75m on center.

DRAWN BY JS	 ENVIROGEN PRINCETON RESEARCH CENTER 4100 QUAKERBRIDGE RD. LAWRENCEVILLE, N.J. 08648	 ESTCP <small>ENVIRONMENTAL SECURITY TECHNOLOGY CENTER</small>	
CHK'D BY JQ			FIGURE 10
SCALE: 1" = 2m			Port Hueneme
DATE 06/30/00	Demonstration Area Layout for the Control Plot		control plot.dwg
APP'D BY ENGR'G.			REV. A
APP'D BY PROJ. MGR.			
APP'D BY			
		SIZE A	

spacings along a line oriented perpendicular to groundwater flow. The groundwater monitoring network consisted of 10 dual-level, nested wells: One (1) upgradient well nest was placed 12.1 feet upgradient of the OIPS. Three (3) rows of performance monitoring wells were placed at 7.5, 13.5, and 21.7 feet downgradient of the OIPs. The soil-gas monitoring network consisted of 4-VMPs placed around the OIPs. As in the Test Plot, the U.S. EPA installed multilevel groundwater monitoring points (13) and additional soil-gas monitoring points (2).

Oxygen, Bacteria and Propane Injection Point Installation

Oxygen, bacteria and propane injection points were installed using Geoprobe™ methods to minimize soil cuttings and waste disposal. The OIPs, BIPs and PIPs were installed through the push rods using an expendable tip to anchor the assembly in the formation at the design depth. Oxygen and propane injection points were constructed using 1-inch ID, Schedule 40 PVC casings from 2-feet above the ground surface to approximately 10-feet below the water table. The well screens were constructed using 1-foot length Schumaprobe™ screens composed of sintered polyethylene. The prefabricated screens were used to provide ideal performance characteristics for low-flow rate sparging of oxygen and propane. Bacteria injection points were constructed of 2-inch ID, Schedule 40 PVC casings from 2-feet above the ground surface to the water table. BIP well screens were constructed using 2-inch, 0.010-foot slots screens of 10-foot length. Because the injection points were installed via direct push methods, no filter pack or annular seal was required. The construction specifications for OIPs, BIPs, PIPs, monitoring wells and VMPs are presented in Figure 11.

Groundwater and Soil-Gas Monitoring Point Installation

Groundwater and soil-gas monitoring points were installed using the same techniques as described above. Shallow wells were designed to intersect the water table, with the top of the 5-foot screens placed approximately at the water table; deep wells were installed with 5-foot screens placed between 5 and 10 feet below the approximate water table elevation. Monitoring well screens were 0.5-inch ID, 0.010-foot slot, Schedule 40 PVC. Well casings were constructed of 0.5-inch ID Schedule 40 PVC from the top-of-screen to 2-feet above the ground surface. Because the groundwater monitoring points were installed via direct push methods, no filter pack or annular seal was required.

Soil-gas (vapor) monitoring points were constructed of 0.5-inch ID Schedule 40 PVC casings and 0.010-foot slot screens of 2.5-foot length. The screened section of the VMPs was placed approximately 2-feet below the ground surface and surrounded by a washed gravel filter pack and sealed above using bentonite chips to grade.

**TYPICAL
OXYGEN / PROPANE
INJECTION POINT**

**TYPICAL
BACTERIA
INJECTION POINT**

**TYPICAL
GROUNDWATER
MONITORING POINT**

**TYPICAL
VAPOR
MONITORING POINT**

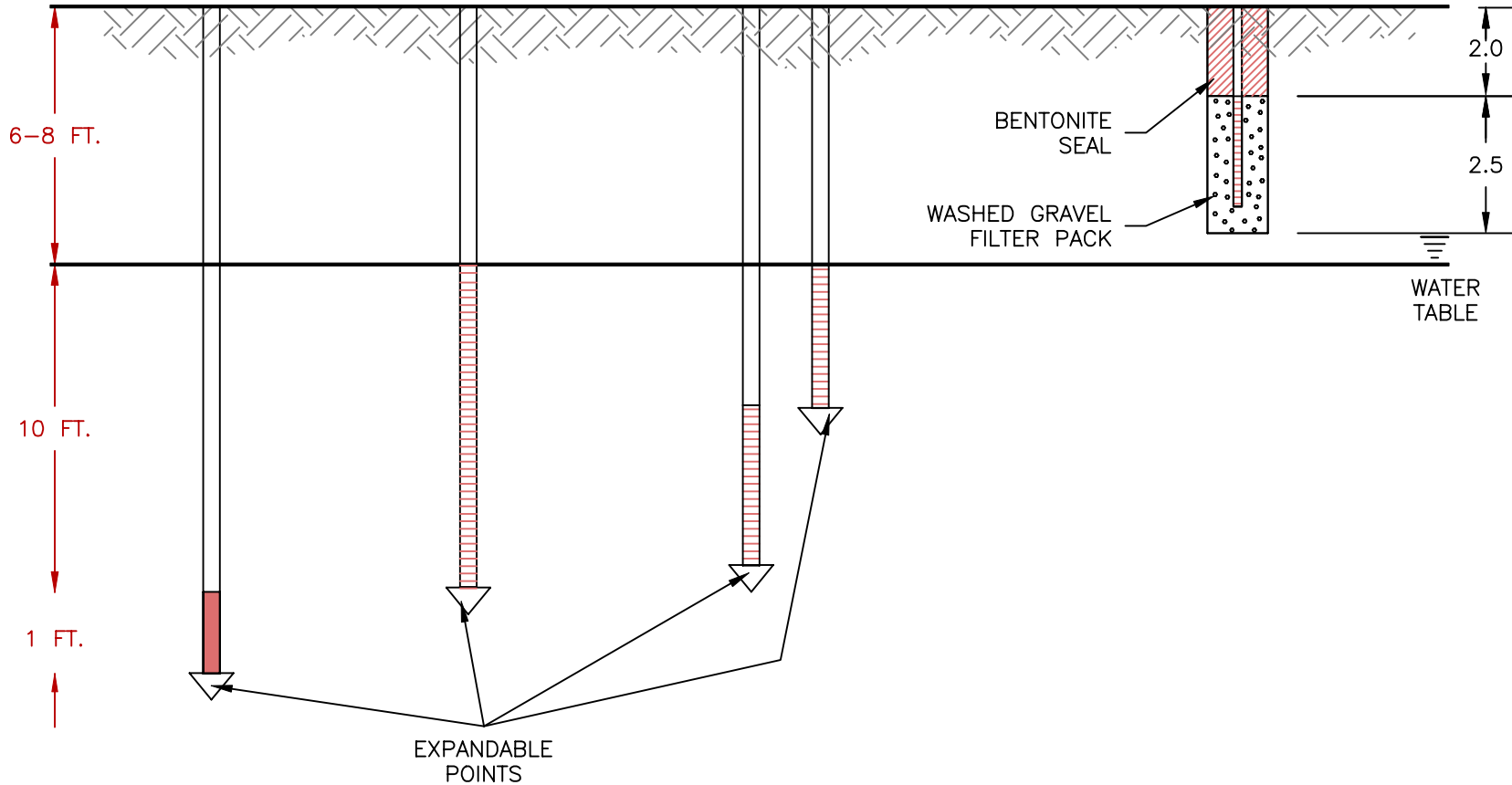

RISER: 1-INCH ID SCH.40 PVC
~ 16-18 FOOT LENGTH

2-INCH ID SCH.40 PVC
~ 6-8 FOOT LENGTH

1-INCH ID SCH.40 PVC
~ 6-13 FOOT LENGTH

0.5-INCH PVC RISER
W/ 10 SLOTS PER FOOT

SCREEN: 1-FOOT SCHUMA PROBE™
SINTERED POLYETHYLENE

2-INCH ID SCH.40 PVC
0.010 SLOT SCREEN
10 FOOT LENGTH

1-INCH ID SCH.40 PVC
0.010 SLOT SCREEN
5 FOOT LENGTH

0.5-INCH SCH.40 PVC
0.010 SLOT SCREEN
2.5 FOOT LENGTH



Princeton Research Center, 4100 Quakerbridge Road
Lawrenceville, New Jersey 08648



ESTCP – PROPANE BIOSTIMULATION WORKPLAN
PORT HUENEME, CALIFORNIA

FIGURE 11
WELL CONSTRUCTION SPECIFICATIONS

SCALE NOT TO SCALE	SHEET SIZE A	REVISION
DESIGNED BY/DATE JQ/05-19-00	FILE # mtbe_demo	
DRAWN BY/DATE LJ, JS/06-30-00	FIGURE # 11	
CHECKED BY/DATE	SHEET	OF

Oxygen and Propane Biosparging System Installation

The design for the propane and oxygen biosparging system was based on the anticipated requirements associated with a relatively small area. As such, the equipment required to provide and control adequate oxygen and propane supply were simple and portable. The system consisted of pressurized oxygen and propane tanks, individual oxygen and propane control manifold assemblies and a control panel equipped with timers to allow pulsed operation of the injection systems. Figure 12 illustrates the piping and instrumentation diagram for the biosparging system.

Separate oxygen distribution systems were set up for the Test and Control Plots. Each plot utilized two oxygen cylinders (approximately 310 cubic feet of gas per cylinder) piped in series with appropriate pressure regulators to allow oxygen delivery at 40 to 60 pounds per square inch gage (PSIG). Oxygen flow to the manifold was controlled using a timer actuated solenoid valve. Flow and operating pressure at each oxygen injection point well-head were controlled using individual needle valves, sized to allow oxygen flow rates of 1 to 60 standard cubic feet per hour (SCFH) at operating pressures of up to 12 PSIG. Each well head was equipped with a dedicated flow meter and pressure valve port to allow flow balancing and system performance monitoring. The primary distribution line from the oxygen tanks, manifold assembly and individual well-head distribution laterals were constructed of materials appropriate for oxygen duty. The oxygen tanks for the Control and Test Plots were housed in one cage located near the plots.

The Test Plot propane distribution system consisted of one 35-pound propane cylinder with appropriate pressure regulator to allow propane delivery at 20 to 30 PSIG. Propane flow to the manifold assembly was controlled using a timer actuated solenoid valve. Flow and operating pressure at each propane injection point well-head were controlled using individual needle valves, sized to allow propane flow rates of 0.5 to 5 SCFH at 12 PSIG. Each well head was equipped with a dedicated flow meter and pressure valve port to allow flow balancing and system performance monitoring. The primary distribution line from the propane tank, manifold assembly and individual well-head distribution laterals were constructed of materials appropriate for propane delivery. The propane tank was housed in a separate cage near the Test Plot, separated from the oxygen tanks by approximately 25 feet.

Electricity Specifications and Supply

The control panel was mounted on a portable, unistrut assembly placed near the plots and was properly anchored, grounded and protected from the elements. The demonstration system utilized 110V power supplied by NETTS. The propane solenoid valve was intrinsically safe, normally closed. The electric run from the timer switch to the propane solenoid valve was intrinsically safe, Class I, Division I.

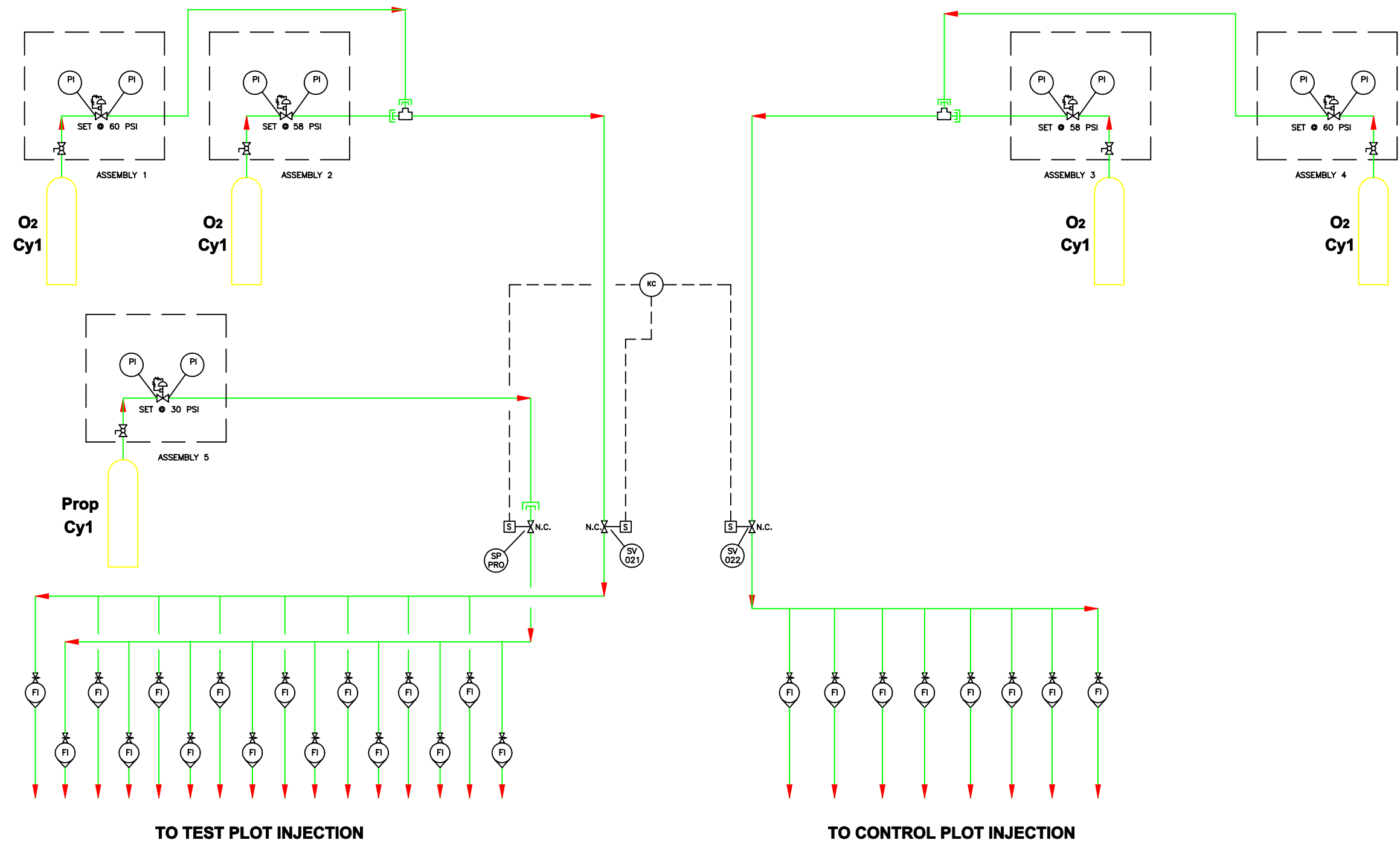

DRAWN BY	LJ,JS
CHK'D BY	JQ
SCALE:	Not to Scale
DATE	06/30/00
APP'D BY	
ENGR'G.	
PROJ. MGR.	
APP'D BY	



Figure 12
Propane Biostimulation System
Piping Instrumentation Diagram

ENVIROGEN PROJECT NO. 92132	
Port Hueneme	
SIZE	REV.
B	A
DRAWING NO. pro_biostim.dwg	

System Fabrication, Installation, and Testing

Monitoring wells, OIPs, PIPs, BIPs, and VMPs were installed at the Site in September and October of 2000. Well and injection point development and pressure testing were performed in October of 2000. Sparging manifolds were assembled and shipped to the Site in January 2001. Sparge testing was conducted in May 2001, as described below. Tracer studies were conducted by the U.S. EPA from January to March 2001. The system control panel was fabricated and shipped to the demonstration site in April 2001. The individual control panel components were pre-assembled in a modular fashion for ease of shipping and field-assembly. The control panel system was assembled on-site by NETTS and ENVIROGEN personnel in April 2001. Final system connections and installation were made in April 2001.

3.5.2 DEMONSTRATION START-UP

Sparge Testing

Initial pressure/sparge testing was conducted at the oxygen and propane injection points in October of 2000 following installation of the injection points. Breakout pressure and operating pressure were compared to the maximum system pressure and the overburden pressure at each injection point, as detailed in Appendix A. Breakout pressures measured at air flows of 2 to 3 cfm at all OIPs and PIPs met the test criteria. The operating pressures at airflows of 2, 5 and 10 cfm at all OIPs and PIPs met the test criteria. Pressure/sparge tests were repeated in May of 2001 shortly before demonstration start up. Again, recorded pressures at all OIPs and PIPs met the test criteria.

Tracer Studies

The U.S. EPA, as part of the MTBE Treatment and Technology Certification Program, conducted two tracer studies in conjunction with the demonstration. The first tracer study was performed under natural gradient conditions prior to commencing the propane biosparging. The second tracer study was conducted concurrently with the demonstration. Both tracer studies utilized the tracer injection well network shown in Figures 9 and 10. The tracer injection system consisted of nineteen 2-inch wells screened across the entire saturated zone in each plot. Each well was equipped with a tracer feed line and an in-well mixer. The U.S. EPA used both a conservative tracer (bromide) and a reactive tracer (uniformly-labeled, deuterated-MTBE [dMTBE]) in conducting the studies. The U.S. EPA will submit a report summarizing the findings of the tracer studies (Keeley, in press). Tracer concentrations were monitored to establish tracer breakthrough curves so that groundwater flow paths, velocity and aquifer dispersivity (under natural gradient and demonstration conditions) could be evaluated.

Preliminary results of the first tracer study were reported by the U.S. EPA to ENVIROGEN in February of 2001. These data indicated that the velocity of groundwater flow was approximately 75 to 110 feet/yr, lower than predicted based on previous data. The first demonstration Sampling Event was rescheduled from 2 weeks following bacterial injection to 4 weeks because of the reduced groundwater velocity.

Baseline Monitoring

Prior to initiating the propane biosparging demonstration, groundwater and vapor samples were collected to establish background (baseline) conditions of groundwater quality and biogeochemistry, soil-gas, and ambient air quality. Two baseline sampling events were originally scheduled to occur shortly before initiation of the demonstration. The first round of baseline sampling was conducted from January 9 to January 11, 2001, based on an expected March demonstration start up. However, permitting issues delayed start-up until May 2001. Because of the schedule delay, an additional round of baseline sampling was required. The second round of baseline sampling was conducted from April 30 to May 2, 2001, and the third round of sampling was conducted from May 21 to 23, 2001.

Groundwater sampling was conducted using peristaltic pumps with flow through cells to measure geochemical parameters. Wells were purged for approximately 5-10 minutes so that three sets of geochemical data could be collected. The amount of time spent purging was restricted to limit the amount of water removed from each well during purging and sampling.

During the January 2001 sampling event, groundwater samples were collected from all monitoring wells in the Test and Control Plots to establish baseline conditions. Samples from select wells in the Control Plot (GWC-1 and 6) and in the Test Plot (GWT-1, 3, 9, and 15) were analyzed for MTBE, TBA, heterotrophs and propanotrophs, and a set of geochemical parameters. The geochemical parameters included dissolved propane and carbon dioxide, anions (bromide, chloride, nitrate, nitrite, sulfate and phosphate), total phosphate, ammonia, alkalinity, and oxygen demand parameters (TOC, COD and cBOD₅). Samples from all remaining wells were analyzed for MTBE, TBA, and heterotrophs and propanotrophs only. Baseline monitoring results for all of these parameters are shown in the first data column of Tables 3, 4, 5, 6, and 7.

The second baseline sampling event was conducted from April 30 to May 2, 2001 prior to the start of sparging. During this sampling round, samples were collected from select wells in the Test and Control Plots for MTBE, TBA, and heterotroph and propanotroph analysis. GWC-1, 2, 4, 6, 8, and 10 were sampled at both depths, and GWT-1 through 4, 8-10, and 12-15 were sampled at both depths. These data are shown in the second data column of Tables 3, 4, 5, and 6. Pressure/sparge testing was conducted following this sampling event, as described in Section 3.5.2. Oxygen and propane sparging were initiated on May 4, 2001, and continued through May 21, 2001 to establish favorable subsurface conditions prior to bioaugmentation.

The third sampling event was conducted from May 21 to 23, 2001, prior to bioaugmentation, following two weeks of oxygen and propane sparging. Samples from select wells in the Control Plot (GWC-1 and 6) and in the Test Plot (GWT-1, 3, 9, and 15) were analyzed for MTBE, TBA, heterotrophs and propanotrophs, and the geochemical parameters measured in the first sampling event. Samples from all remaining wells were analyzed for MTBE, TBA, and heterotrophs and propanotrophs only. These monitoring results are shown in the third data column of Tables 3, 4,

5, 6, and 7. Analytical Methods are presented in Table 8. Bioaugmentation occurred on May 25, 2001 following the third sampling event.

TABLE 3
SUMMARY OF MTBE CONCENTRATIONS IN CONTROL AND TEST PLOTS
 ESTCP Propane Biosparging Demonstration
 Port Hueneme, CA
 Envirogen Project No. 92132

Control Plot MTBE Concentration (ug/L)

Well	1/9/01 - 1/11/01	4/30/01 - 5/2/01	5/21/01 - 5/23/01	6/12/01 - 6/14/01	6/25/01 - 6/27/01	7/10/01 - 7/12/01	7/23/01 - 7/25/01	8/20/01 - 8/22/01	9/24/01 - 9/26/01	10/22/01 - 10/24/01	11/27/01 - 11/29/01	12/17/01 - 12/19/01	1/14/02 - 1/15/02	2/19/02 - 2/21/02	3/11/02-3/12/02
GWC-1S	4100 D	2200 D	5900 D	4900 D	4000 D	3300 D	6100 D	4400 D	1700 D	1100 D	740 D	110 D	1700 D	4400 D	3400 D
GWC-1D	4800 D	3700 D	5900 D	5200 ED	6300 D	8400 D	7600 ED	5900 D	6600 D	9100 D	5900 D	6300 D	690 D	4000 D	4700 D
GWC-2S	1300 D	130 D	560 D	850 D	1600 D	1200 D	1300 D	460 JD	170	410 D	96 JD	64 D	61 D	25	28 D
GWC-2D	4200 D	2900 D	4100 D	2500 D	2600 D	2100 D	3500 D	2300 D	1200	1700 D	920 D	960 D	530 D	800 D	280 D
GWC-3S	2300 D	NS	2600 D	3100 D	2700 D	390 D	1100 D	910 D	900	860 D	260 D	340 D	330 D	450 D	600 D
GWC-3D	6700 D	NS	4300 D	1800 D	690 D	2200 D	750 D	580 D	450	700 D	820 D	1100 D	590 D	1100 D	1200 D
GWC-4S	2600 D	870 D	2500 D	2100 D	2300 D	2400 D	1500 D	1800 D	1700 D	170 D	20 D	3 J	10	160 D	140 D
GWC-4D	5600 D	6000 D	5600 D	4500 D	2900 D	1200 D	400 D	190 D	220 D	76 D	100 D	100 D	99 D	3 J	27
GWC-5S	1400 D	NS	520 D	560 D	640 D	750 D	530 D	2300 D	270	110 D	11 D	11	20	17 D	25
GWC-5D	4300 D	NS	4000 D	4400 D	3500 D	1900 D	2800 D	1500 D	1500	1200 D	460 D	880 D	430 D	180 D	75
GWC-6S	4500 D	84 JD	77 D	240 D	550 D	400 D	130 D	49 D	55 D	78 D	5 U	5 U	19	3 J	6
GWC-6D	6600 D	5500 D	4400 D	3300 D	1400 D	1000 D	920 D	270 D	180 D	190 D	440 D	5 U	370 D	1200 D	1400 D
GWC-7S	3600 D	NS	1700 D	1900 D	1900 D	1900 D	2900 D	1600 D	1900 D	1900 D	410 D	340 D	160 D	82 D	35 D
GWC-7D	7800 D	NS	5500 D	4500 D	2400 D	990 D	220 D	92 D	85 D	160 D	100 D	110 D	110 D	250 D	200 D
GWC-8S	1100 D	110 JD	320 D	220 D	250 D	510 D	190 D	140 D	78 D	49 D	5 J	7	27	4 J	7
GWC-8D	3800 D	3900 D	4800 D	4100 D	4200 D	3300 D	5000 D	1800 D	1700 D	1500 D	480 D	1000 D	450 D	120 D	110 D
GWC-9S	2900 D	NS	620 D	290 D	140 D	190 JD	190 D	170 D	110 D	130 D	3 J	14	47 D	7	6
GWC-9D	5900 D	NS	4300 D	4200 D	3000 D	1600 D	1500 D	1000 D	2000 D	3200 D	2100 D	2000 D	3600 D	1000 D	1300 D
GWC-10S	1300 D	340 D	890 D	2500 D	2100 D	2200 D	4000 D	1700 D	2800 D	3200 ED	1400 D	1600 D	820 D	100	68 D
GWC-10D	9500 D	6400 D	6900 D	6300 D	3600 D	3200 D	2400 D	370 D	310 D	330	120 D	190 D	170 D	240 D	170 D

Test Plot MTBE Concentration (ug/L)

Well	1/9/01 - 1/11/01	4/30/01 - 5/2/01	5/21/01 - 5/23/01	6/12/01 - 6/14/01	6/25/01 - 6/27/01	7/10/01 - 7/12/01	7/23/01 - 7/25/01	8/20/01 - 8/22/01	9/24/01 - 9/26/01	10/22/01 - 10/26/01	11/27/01 - 11/29/01*	12/17/01 - 12/19/01	1/14/02 - 1/15/02	2/19/02 - 2/21/02	3/11/02-3/12/02
GWT-1S	3100 D	1800 D	1700 D	1300 D	350 D	220 D	120 D	140 D	400 D	140 D	15	13	48	5 U	3 J
GWT-1D	4900 D	3600 D	2400 D	3000 D	2500 D	2400 D	2000 D	1800 D	2000 ED	1000 D	820 D	720 D	710 D	1400 D	750 D
GWT-2S	20	90 D	140 D	190 D	180 D	160 D	150 D	130 D	84 JD	110 D	110 D	140 D	72 D	24	62 D
GWT-2D	6600 D	1900 D	1300 D	830	540 D	430 D	390 D	460 D	340	340 D	380 D	470 JD	210 D	51 D	19 D
GWT-3S	4500 D	440 D	670 D	730 D	600 D	330 D	220 D	130 D	200 D	100 D	270 D	170 D	100 D	140 D	170 D
GWT-3D	5100 D	2000 D	2100 D	1400 D	970 D	280 D	200 D	190 D	340 D	280 D	130 D	150 D	90 JD	73	46 D
GWT-4S	3700 D	500 D	610 D	710 D	300 D	92 D	56 D	120 D	910 D	340 D	110 D	190 D	100 D	59 D	82 D
GWT-4D	7600 D	3700 D	2000 D	1400 D	1700 D	840 D	670 D	690 D	770 D	300 D	400 D	380 D	290 D	360 D	440 D
GWT-5S	170 D	NS	90 JD	110 D	110 D	140 D	120 D	69 D	63	150 D	55 D	39 JD	37 D	26	14
GWT-5D	8400 D	NS	1600 D	1200 D	550 D	500 D	500 D	650 D	250	350 D	230 D	410 D	230 D	160 D	64 D
GWT-6S	430 D	NS	810 D	1300 D	1400 D	1000 D	620 D	310 D	140 D	63 D	6	170 D	110 D	90	110 D
GWT-6D	5200 D	NS	1700 D	2200 D	1600 D	850 D	410 D	130 D	290 D	80 D	64 JD	110 D	92	88	110
GWT-7S	3200 D	NS	640 D	420 D	280 D	210 D	200 D	180 D	120 D	82 JD	260 D	170 D	150 D	59 D	68 D
GWT-7D	1600 D	NS	2900 D	2500 D	2300 D	1200 D	510 D	1200 D	1500 D	980 D	1000 D	440 D	600 D	340 D	270 D
GWT-8S	18	200 D	260 D	200 D	150 D	100 D	42 D	9 JD	26 D	150 D	3 J	20	6	4 J	19
GWT-8D	6600 D	1900 D	1600 D	430 D	100 D	59 D	120 D	99 D	77 D	120 D	56	43	66 D	47 D	56 D
GWT-9S	120 JD	110 D	300 D	530 D	740 D	860 D	840 D	780 D	880 D	320 D	18 JD	90 JD	240 D	150 D	160 D
GWT-9D	2500 D	2400 D	2200 D	3200 D	2500 D	1400 D	1200 D	600 D	410 D	280 D	190 D	200 D	140 D	100 D	110 D
GWT-10S	6600 D	86 D	130 D	3600 D	320 D	300 D	260 D	190 D	100 D	130 D	18	110 D	150 D	59 D	80 D
GWT-10D	3700 D	66	3400 D	310 D	2900 D	1500 D	580 D	760 D	970 D	840 D	660 D	720 D	520 D	220 D	120 D
GWT-11S	660 D	NS	110 JD	90 D	36 D	30 D	24 D	12	10	30 D	10 U	7	4 J	8	4 J
GWT-11D	8100 D	NS	1600 D	240 D	92 D	74 D	90 D	51 D	71 D	77 D	100 U	20	13	41	140 D
GWT-12S	430 D	NS	280 D	550 D	610 D	560 D	580 D	520 D	540 D	190 D	72 D	160 D	150 D	65	48 D
GWT-12D	4900 D	NS	2300 D	2100 D	2000 D	2000 D	2000 D	720 D	720 D	340 D	150 D	100 D	100 D	110 D	140 D
GWT-13S	5600 D	88 D	150 JD	190 D	310 D	440 D	420 D	380 D	300 D	270 D	100 U	240 D	170 D	61 D	69 D
GWT-13D	3200 D	3900 D	180 D	4600 D	2900 D	1900 D	1200 D	610 D	1200 D	1000 D	1000 D	1100 D	340 D	440 D	280 D
GWT-14S	48	74 D	180 D	100 D	96 D	190 D	140 D	43 D	12	17	100 U	5	5 U	5 U	2 J
GWT-14D	5600 D	2000 D	1700 D	540 D	510 D	350 D	170 D	220 D	130 D	180 D	100 U	150 D	280 D	230 D	140 D
GWT-15S	3 JD	18	39 D	150 D	270 D	460 D	690 D	820 D	800 D	550 D	100 U	200 D	96 D	26 D	28 D
GWT-15D	4700 D	3300 D	3400 D	2700 D	2200 D	1200 D	1300 D	700 D	460 D	300 D	200 D	97 D	59 D	32	23 JD

NOTES:

All concentrations are in ug/L

NS - Not Sampled

E - Value exceeded linear range of calibration curve. Due to laboratory error, analysis was not repeated at a greater dilution.

D - Result obtained as a result of laboratory dilution of sample.

J - Value detected at concentration below practical quantitation limit (PQL)

* Field Blank w/ detect for MTBE

TABLE 4
SUMMARY OF TBA CONCENTRATIONS IN CONTROL AND TEST PLOTS
 ESTCP Propane Biosparging Demonstration
 Port Hueneme, CA
 Envirogen Project No. 92132

Control Plot		TBA Concentration (ug/L)														
Well	1/9/01 - 1/11/01	4/30/01 - 5/2/01	5/21/01 - 5/23/01	6/12/01 - 6/14/01	6/25/01 - 6/27/01	7/10/01 - 7/12/01	7/23/01 - 7/25/01	8/20/01 - 8/22/01	9/24/01 - 9/26/01	10/22/01 - 10/24/01	11/27/01 - 11/29/01	12/17/01 - 12/19/01	1/14/02 - 1/15/02	2/19/02 - 2/21/02	3/11/02-3/12/02	
GWC-1S	25 U	25 U	13 J	82	66	54	12 J	16 J	25 U	35	31	25 U	32	18.5 J	20 J	
GWC-1D	25 U	25 U	25 U	64	29	52	27	38	25 U	29	30	19 J	21 J	26	22 J	
GWC-2S	25 U	25 U	25 U	25 UD	24 J	25 U	15 J	50	25 U	38	25 U	25 U	25 U	14 J	25 U	
GWC-2D	25 U	25 U	25 U	22 JD	16.8 J	25 U	15 J	25 U	25 U	23 J	10 J	12 J	25 U	11 J	25 U	
GWC-3S	25 U	NS	6.5 J	42	21.8 J	10.4 J	25 U	17 J	25 U	14 J	13 J	25 U	25 U	12 J	12 J	
GWC-3D	23 J	NS	25 U	15 J	25 U	25 U	25 U	17 J	25 U	26	13 J	25 U	11 J	25 U	18 J	
GWC-4S	25 U	25 U	25 U	29	33	25	15 J	12 J	25 U	25 U	13 J	25 U	25 U	25 U	12 J	
GWC-4D	25 U	10 J	13 J	110	23 J	25 U	11 J	62	25 U	25 U	25 U	25 U	25 U	19 J	25 U	
GWC-5S	25 U	NS	25 U	37 D	17 J	25 U	25 U	23 J	25 U	28	11 J	25 U	25 U	25 U	25 U	
GWC-5D	25 U	NS	19 J	12 JD	27	11 J	9.5 J	25 U	25	21 J	11 J	25 U	25 U	25 U	25 U	
GWC-6S	15 J	25 U	25 U	25 UD	25 U	25 U	10 J	25 U	25 U	25 U	25 U	25 U	25 U	25 U	25 U	
GWC-6D	34	25 U	19 J	29 D	50	16 J	10 J	25 U	25 U	11 J	25 U	25 U	25 U	25 U	11 J	
GWC-7S	21 J	NS	25 U	35 D	24 J	35	16 J	25 U	25 U	15 J	15 J	25 U	25 U	25 U	25 U	
GWC-7D	39	NS	34	25 D	19 J	11 J	16 J	33	25 U	20 J	25 U	25 U	25 U	18 J	25 U	
GWC-8S	25 U	25 U	25 U	15 JD	25 U	17 J	25 U	25 U	25 U	12 J	25 U	13 J	25 U	25 U	25 U	
GWC-8D	25 U	25 U	12 J	33 D	24 J	24 J	25 U	12 J	14 J	22 J	25 U	21 J	25 U	25 U	25 U	
GWC-9S	33	NS	25 U	39 D	25 U	38	25 U	25 U	25 U	9.6 J	25 U	25 U	17 J	25 U	25 U	
GWC-9D	40	NS	17 J	32 D	23 J	25	25 U	25 U	25 U	25 U	12 J	16 J	25 U	25 U	19 J	
GWC-10S	25 U	25 U	25 U	19 JD	20 J	34	30	23 J	28	72	12 J	34	25 U	25 U	25 U	
GWC-10D	29	25 U	25 U	89 D	35	57	10 J	25 U	25 U	25 U	40	25 U	13 J	25 U	25 U	

Test Plot		TBA Concentration (ug/L)														
Well	1/9/01 - 1/11/01	4/30/01 - 5/2/01	5/21/01 - 5/23/01	6/12/01 - 6/14/01	6/25/01 - 6/27/01	7/10/01 - 7/12/01	7/23/01 - 7/25/01	8/20/01 - 8/22/01	9/24/01 - 9/26/01	10/22/01 - 10/24/01	11/27/01 - 11/29/01	12/17/01 - 12/19/01	1/14/02 - 1/15/02	2/19/02 - 2/21/02	3/11/02-3/12/02	
GWT-1S	11 J	25 U	25 U	33 D	25 U	25 U	25 U	25 U	25 U	25 U	18 J	25 U	25 U	25 U	20 J	
GWT-1D	10 J	25 U	25 U	31 D	12 J	10 J	12 J	45	25 U	25 U	25 U	25 U	25 U	10 J	25 U	
GWT-2S	25 U	25 U	25 U	25 UD	14 J	27	40 J	25 U	25 U	20 J	33	21 J	14 J	31	55	
GWT-2D	17 J	25 U	25 U	22 JD	25 U	25 U	25 U	25 U	25 U	36	82	52	22 J	38	130	
GWT-3S	30	25 U	25 U	27 D	20 J	17 J	25 U	18 J	43	25 U	140	23 J	30	24 J	40	
GWT-3D	20 J	25 U	25 U	16 JD	20 J	25 U	25 U	25 U	25 U	25 U	42	37	44	25 U	10 J	
GWT-4S	25 U	25 U	25 U	25 UD	15 J	25 U	10 J	25 U	25 U	25 U	34	25 U	23 J	84	100	
GWT-4D	36	25 U	25 U	25 UD	13 J	25 U	25 U	25 U	25 U	25 U	25 U	25 U	25 U	32	32	
GWT-5S	25 U	NS	25 U	37 D	12 J	25 U	13 J	35	25 U	18 J	25 U	25 U	25 U	25 U	20 J	
GWT-5D	12 J	NS	25 U	12 JD	15 J	25 U	25 U	10 J	25 U	20 J	53	39	13 J	25 U	39	
GWT-6S	25 U	NS	25 U	25 UD	27	16 J	20 J	25 U	25 U	25 U	25 U	25 U	13 J	44	34	
GWT-6D	41	NS	27	25 UD	13 J	25 U	25 U	25 U	25 U	25 U	25 U	10 J	16 J	32	29	
GWT-7S	22 J	NS	25 U	25 UD	13 J	25 U	25 U	25 U	25 U	18 J	25	19 J	54	25	68	
GWT-7D	21 J	NS	32	25 UD	25 U	25 U	25 U	25 U	NA	22 J	12 J	25 U	29	25 U	25 U	
GWT-8S	25 U	25 U	25 U	15 JD	15 J	25 U	25 U	25 U	25 U	15 J	12 J	25 U	25 U	25 U	25 U	
GWT-8D	14 J	25 U	25 U	18 JD	13 J	25 U	25 U	15 J	25 U	25 U	25 U	25 U	10 J	29	25 U	
GWT-9S	25 U	25 U	25 U	25 UD	22 J	17 J	15 J	25 U	25 U	25 U	25 U	25 U	10 J	25 U	25	
GWT-9D	25 U	25 U	25 U	22 JD	25	10 J	25 U	11 J	13 J	25 U	13 J	25 U	25 U	29	260	
GWT-10S	25 U	25 U	25 U	32 D	23 J	23 J	25 U	17 J	17 J	37	25 U	29	61	27	86	
GWT-10D	31	25 U	53	15 JD	20 J	25 U	25 U	35	25 U	25 U	23 J	25 U	34	22 J	18	
GWT-11S	25 U	NS	25 U	25 UD	16 J	25 U	25 U	25 U	25 U	28	13 J	25 U	25 U	25 U	25 U	
GWT-11D	30	NS	25 U	25 UD	25 U	25 U	25 U	25 U	NA	25 U	12 J	25 U	25 U	25 U	25 U	
GWT-12S	30	NS	25 U	25 UD	13 J	15 J	25 U	25 U	25 U	35	39	25 U	25 U	25 U	25 U	
GWT-12D	25 U	NS	25 U	14 JD	19 J	19 J	12 J	12 J	25 U	42	67	25 U	25 U	22 J	26	
GWT-13S	25 U	25 U	25 U	25 UD	12 J	14 J	17 J	14 J	25 U	43	16 J	33	35	22 J	51	
GWT-13D	27	25 U	16 J	17 JD	22 J	14 J	25 U	25 U	25 U	25 U	110	10 J	25 U	12 J	21 J	
GWT-14S	25 U	25 U	25 U	14 JD	25	25 U	25 U	25 U	25 U	25 U	25 U	25 U	25 U	25 U	25 U	
GWT-14D	25 U	25 U	25 U	25 UD	25 U	10 J	25 U	25 U	25 U	25 U	25 U	25 U	25 U	25 U	25 U	
GWT-15S	17	25 U	25 U	25 UD	25 U	25 U	13 J	25 U	25 U	11 J	25 U	13 J	25 U	10 J	25 U	
GWT-15D	35	25 U	29	25 UD	20 J	25 U	25 U	25 U	25 U	25 U	25 U	25 U	25 U	25 U	25 U	

All concentrations are in ug/L
 D - Result obtained as a result of laboratory dilution of sample
 J - Value detected at concentration below practical quantitation limit (PQL)
 U - Undetected (No peaks were seen. The value 25 denotes the practical quantitation limit of 25 ug/L.)

TABLE 5
SUMMARY OF HETEROTROPH CONCENTRATIONS IN CONTROL AND TEST PLOTS
 ESTCP Propane Biosparging Demonstration
 Port Hueneme, CA
 Envirogen Project No. 92132

Control Plot		Total Heterotroph Concentration (CFU/mL)														
Well	1/9/01 - 1/11/01	4/30/01 - 5/2/01	5/21/01 - 5/23/01	6/12/01 - 6/14/01	6/25/01 - 6/27/01	7/10/01 - 7/12/01	7/23/01 - 7/25/01	8/20/01 - 8/22/01	9/24/01 - 9/26/01	10/22/01 - 10/24/01	11/27/01 - 11/29/01	12/17/01 - 12/19/01	1/14/02 - 1/15/02	2/19/02 - 2/21/02	3/11/02-3/12/02	
GWC-1S	13,400,000	2,800	22,000	3,100	12,400	1,100	1,900	2,500	3,400	2,000	11,000	NS	3,300	8,500	11,000	
GWC-1D	19,400	1,070	56,000	810	5,200	1,000	410	550	1,200	410	1,800	NS	150,000	870	3,600	
GWC-2S	231,000	600	4,300	7,900	18,000	1,000	6,000	62,000	37,000	18,000	36,000	NS	18,000	14,000	33,000	
GWC-2D	23,100	1,200	31,000	35,000	8,400	<300	300	740	4,600	14,000	33,000	NS	830	4,200	31,000	
GWC-3S	SC	NS	6,900	13,000	5,300	260 J	81,000	14,000	2,200	75,000	33,000	NS	4,100	34,000	46,000	
GWC-3D	47,000	NS	84,000	48,000	18,000	34,000	600	3,100	27,000	29,000	83,000	NS	740	34,000	35,000	
GWC-4S	154,000	3,400	3,200	7,600	10,000	2,900	3,000	3,100	15,000	27,000	120,000	NS	30,000	16,000	100,000	
GWC-4D	82,000	900	34,000	34,000	9,400	9,400	29,000	43,000	44,000	68,000	49,000	NS	6,900	110,000	34,000	
GWC-5S	13,100	NS	36,000	56,000	11,000	1,500	30,000	91,000	23,000	34,000	14,000	NS	33,000	14,000	20,000	
GWC-5D	8,900	NS	17,000	7,900	3,200	6,200	6,900	58,000	4,100	6,000	16,000	NS	7,000	2,500	6,400	
GWC-6S	8,800	610	4,200	3,200	1,000	1,900	3,000	3,100	1,100	1,500	48,000	NS	5,900	54,000	8,400	
GWC-6D	41,000	340	51,000	7,800	11,500	2,500	2,000	6,100	7,300	4,600	5,000	NS	1,000	1,000	9,000	
GWC-7S	40,000	NS	3,600	9,700	4,000	1,700	3,100	12,000	34,000	12,000	87,000	NS	20,000	90,000	14,000	
GWC-7D	39,000	NS	24,000	12,000	5,000	3,000	3,500	6,800	27,000	65,000	85,000	NS	11,000	27,000	30,000	
GWC-8S	66,000	1,600	4,600	2,900	5,300	1,100	12,000	4,500	3,200	4,400	5,200	36,000	83,000	35,000	38,000	
GWC-8D	55,000	310	4,500	2,500	3,000	830	1,700	3,200	1,800	170,000	2,200	3,200	77,000	3,800	7,700	
GWC-9S	13,300	NS	31,000	860	440	180 J	890	2,200	2,400	5,200	31,000	25,000	42,000	65,000	6,900	
GWC-9D	175,000	NS	7,200	5,600	3,900	680	5,100	2,500	1,400	1,800	670	1,500	7,100	810	1,400	
GWC-10S	5,500	1,100	3,300	1,200	390	510	3,300	11,000	12,000	12,000	7,700	2,200	8,800	8,600	7,700	
GWC-10D	460,000	620	15,000	1,200	700	340	860	2,400	3,200	4,900	11,000	2,700	33,000	1,000	3,200	

Test Plot		Total Heterotroph Concentration (CFU/mL)														
Well	1/9/01 - 1/11/01	4/30/01 - 5/2/01	5/21/01 - 5/23/01	6/12/01 - 6/14/01	6/25/01 - 6/27/01	7/10/01 - 7/12/01	7/23/01 - 7/25/01	8/20/01 - 8/22/01	9/24/01 - 9/26/01	10/22/01 - 10/24/01	11/27/01 - 11/29/01	12/17/01 - 12/19/01	1/14/02 - 1/15/02	2/19/02 - 2/21/02	3/11/02-3/12/02	
GWT-1S	115,000	800	2,200	100,000	32,000	37,000	12,000	7,900	13,000	30,000	69,000	13,000	6,700	3,900	18,000	
GWT-1D	46,000	1,300	21,000	1,200	1,150	3,000	950	4,200	130,000	8,300	8,700	5,400	13,000	2,600	2,000	
GWT-2S	201,000	360	15,000	5,000	3,600	4,900	6,300	5,600	44,000	7,500	370,000	160,000	21,000	2,800,000	120,000	
GWT-2D	155,000	730	54,000	150,000	510,000	110,000	36,000	1,300,000	45,000	5,600	34,000	25,000	41,000	80,000	68,000	
GWT-3S	12,800	4,200	100,000	30,000	37,000	13,000	14,000	6,500	15,000	110,000	30,000	18,000	4,100	19,000	18,000	
GWT-3D	50,000	920	9,400	460,000	79,000	30,000	96,000	43,000	40,000	4,600	57,000	110,000	31,000	44,000	16,000	
GWT-4S	221,000	1,800	48,000	31,000	29,000	9,100	12,000	39,000	85,000	510,000	57,000	1,300,000	12,000	70,000	85,000	
GWT-4D	65,000	2,000	32,000	24,000	30,000	61,000	660,000	97,000	83,000	430,000	12,000	330,000	58,000	87,000	150,000	
GWT-5S	234,000	1,200	11,000	820	3,300	20,000	8,400	14,000	39,000	17,000	290,000	30,000	37,000	3,000,000	350,000	
GWT-5D	11,800	NS	100,000	110,000	200,000	210,000	39,000	640,000	14,500	390,000	31,000	25,000	1,500	3,600	12,000	
GWT-6S	530,000	NS	310,000	99,000	32,000	12,000	820	5,000	9,700	13,000	350,000	35,000	220,000	73,000	56,000	
GWT-6D	8,200	NS	10,000	4,900	49,000	22,000	34,000	110,000	1,500	340,000	1,500	230,000	500,000	6,100	13,000	
GWT-7S	550,000	NS	52,000	91,000	110,000	31,000	47,000	45,000	8,300	33,000	14,000	4,600,000	2,100,000	37,000	45,000	
GWT-7D	191,000	NS	460,000	94,000	58,000	39,000	114,000	36,000	1,200	230 J	29,000	480,000	77,000	110,000	85,000	
GWT-8S	204,000	2,400	12,000	6,800	7,300	89,000	57,000	4,800	5,600	64,000	360,000	60,000	100,000	470,000	110,000	
GWT-8D	11,400	1,650	30,000	39,000	220,000	3,000	3,000,000	68,000	35,000	920,000	63,000	38,000	82,000	34,000	20,000	
GWT-9S	159,000	NS	1,800	3,400	700	2,900	1,900	14,000	3,700	35,000	7,900	NS	58,000	11,000	36,000	
GWT-9D	104,000	850	800	1,100	680	640	770	3,700	3,100	52,000	300 U	1,300	1,600	13,000	5,200	
GWT-10S	7,400,000	9,800	32,000	2,800	5,900	2,700	4,500	3,900	30,000	8,500	400,000	240,000	78,000	37,000	15,000	
GWT-10D	39,000	1,400	4,100	1,100	5,900	3,200	330,000	6,500	12,000	11,000	73,000	1,900,000	810,000	22,000	41,000	
GWT-11S	139,000	NS	17,000	10,000	33,000	10,000	36,000	8,900	9,400	40,000	12,000	4,300	87,000	11,000	6,500	
GWT-11D	9,800	NS	46,000	26,000	83,000	47,000	910,000	1,500,000	40,000	870,000	26,000	220,000	96,000	39,000	45,000	
GWT-12S	156,000	NS	9,800	5,500	4,400	4,400	810	1,100	74,000	34,000	54,000	57,000	58,000	24,000	13,000	
GWT-12D	240,000	NS	12,000	930	640	NA	88,000	38,000	1,800	170,000	8,800	49,000	75,000	13,000	6,400	
GWT-13S	740,000	5,900	5,300	12,000	7,200	5,700	4,000	5,100	6,200	45,000	250,000	4,100	490,000	110,000	62,000	
GWT-13D	47,000	790	3,500	5,700	17,000	49,000	260,000	26,000	5,900	450,000	9,300	32,000	580,000	450,000	110,000	
GWT-14S	119,000	1,600	44,000	85,000	76,000	88,000	51,000	81,000	40,000	100,000	160,000	330,000	290,000	83,000	88,000	
GWT-14D	147,000	500	45,000	32,000	88,000	47,000	3,800,000	56,000	43,000	1,100,000	38,000	62,000	110,000	8,900	16,000	
GWT-15S	201,000	700	1,700	540	500	3,100	3,600	5,300	3,400	54,000	530,000	170,000	160,000	49,000	110,000	
GWT-15D	7,100	4,700	39,000	1,000	430	3,300	59,000	32,000	5,700	NS	14,000	7,000	78,000	6,300	9,200	

NOTES:
 All results in CFU/mL (colony forming units/mL)
 NS - Not Sampled
 SC - Sample Contaminated

TABLE 6
SUMMARY OF PROPANOTROPH CONCENTRATIONS IN CONTROL AND TEST PLOTS
 ESTCP Propane Biosparging Demonstration
 Port Hueneme, CA
 Envirogen Project No. 92132

Control Plot		Total Propanotroph Concentration (CFU/mL)														
Well	1/9/01 - 1/11/01	4/30/01 - 5/2/01	5/21/01 - 5/23/01	6/12/01 - 6/14/01	6/25/01 - 6/27/01	7/10/01 - 7/12/01	7/23/01 - 7/25/01	8/20/01 - 8/22/01	9/24/01 - 9/26/01	10/22/01 - 10/24/01	11/27/01 - 11/29/01	12/17/01 - 12/19/01	1/14/02 - 1/15/02	2/19/02 - 2/21/02	3/11/02-3/12/02	
GWC-1S	350,000	290 J	490	290	1,200	300 U	120 J	370	250 J	130 J	1,900	NS	1,300	3,000	6,300	
GWC-1D	300 U	300 U	300	300 U	250	300 U	300 U	300 U	300 U	300 U	410	NS	26,000	1,200	2,000	
GWC-2S	17,200	300 U	900	300 U	1,300	300 U	300 U	870	230 J	13,000	2,900	NS	4,500	630	13,000	
GWC-2D	5,100	780	16,000	8,700	5,200	300 U	300 U	300 U	300 U	1,300	9,400	NS	300	300 U	3,400	
GWC-3S	SC	NS	1,200	370	12,000	300 U	230 J	490	140 J	8,700	8,200	NS	1,800	2,100	390	
GWC-3D	1,000	NS	9,400	300 U	3,400	300 U	300 U	300 U	20,000	18,000	26,000	NS	110	300 U	300 U	
GWC-4S	1,110	1,100	1,400	300 U	SC	300 U	3,000	410	120	3,700	46,000	NS	11,000	3,000	350	
GWC-4D	1,200	190 J	4,600	1,300	1,500	1,800	29,000	2,600	490	1,600	1,200	NS	3,300	200	9,200	
GWC-5S	1,100	NS	1,000	300 U	300 U	300 U	260 J	15,000	1,480	2,200	3,000	NS	14,000	10,000	16,000	
GWC-5D	400	NS	16,000	300 U	3,200	660	560	400	920	780	4,400	NS	3,700	410	1,400	
GWC-6S	300 U	220 J	160 J	210 JD	300 U	240 J	300 U	300 U	430	640	11,000	NS	3,100	11,000	1,300	
GWC-6D	300 U	300 U	4,600	300 U	260	180 J	180 J	370	650	1,300	3,000	NS	410	370	390	
GWC-7S	4,800	NS	220 J	300 U	300 U	300 U	300 U	300 U	660	1,500	70,000	NS	19,000	36,000	3,800	
GWC-7D	6,000	NS	1,300	300 U	4,800	300 U	300 U	290 J	1,400	4,600	14,000	NS	3,400	270 J	3,000	
GWC-8S	34,000	390	1,080	560	200	300 U	190 J	560	380	2,500	3,000	7,300	32,000	20,000	11,000	
GWC-8D	23,900	310	630	400	300 U	300 U	300 U	370	390	1,800	3,200	700	9,800	770	1,300	
GWC-9S	13,200	NS	1,000	280 J	300 U	300 U	300 U	290 J	520	1,800	17,000	12,000	27,000	15,000	3,800	
GWC-9D	161,000	NS	2,900	300 U	170	300 U	140 J	290 J	300 U	100 J	300 U	380	1,800	300 U	300 U	
GWC-10S	1,320	330	220 J	530	300 U	300 U	300 U	4,400	1,500	7,700	1,700	510	5,900	830	760	
GWC-10D	1,370	300 U	440	300 U	100 J	300 U	300 U	240 J	570	190 J	960	470	5,000	290 J	210 J	

Test Plot		Total Propanotroph Concentration (CFU/mL)														
Well	1/9/01 - 1/11/01	4/30/01 - 5/2/01	5/21/01 - 5/23/01	6/12/01 - 6/14/01	6/25/01 - 6/27/01	7/10/01 - 7/12/01	7/23/01 - 7/25/01	8/20/01 - 8/22/01	9/24/01 - 9/26/01	10/22/01 - 10/24/01	11/27/01 - 11/29/01	12/17/01 - 12/19/01	1/14/02 - 1/15/02	2/19/02 - 2/21/02	3/11/02-3/12/02	
GWT-1S	60,000	300 U	170 J	7,100	300 U	3,200 U	2,000	3,100	400	4,100	9,400	1,200	1,500	2,800	98,000	
GWT-1D	59,000	340	3,100	300 U	300 U	300 U	300 U	3,000	68,000	2,200	4,200	760	7,200	430	1,700	
GWT-2S	71,000	300 U	870	300 U	300 U	300 U	300 U	460	330	3,900	32,000	1,900	4,400	210,000	11,000	
GWT-2D	65,000	300 U	2,100	2,500	32,000	10,000	120 J	720,000	8,000	300 U	30,000	750	22,000	30,000	37,000	
GWT-3S	3,100	1,100	37,000	640	300	240	260 J	260 J	300 U	9,200	7,600	510	1,000	940	1,700	
GWT-3D	5,600	300 U	1,700	140,000	18,000	3,800	760	12,000	1,300	2,900	80,000	1,300	8,800	18,000	15,000	
GWT-4S	8,500	300 U	4,000	4,400	2,100	180	980	290,000	34,000	120,000	5,300	790	3,000	3,000	3,000	
GWT-4D	6,600	300 U	2,100	3,500	5,000	4,700	190 J	67,000	300 U	44,000	3,600	6,800	35,000	71,000	54,000	
GWT-5S	530,000	NS	620	300 U	300 U	300 U	170 J	6,400	300 U	740	61,000	5,600	6,800	310,000	30,000	
GWT-5D	490	NS	1,900	4,100	300 U	300 U	300 U	400,000	8,600	140,000	34,000	8,600	840	2,400	16,000	
GWT-6S	190,000	NS	3,500	300 U	300 U	450	200 J	2,600	3,300	3,000	19,000	1,700	4,600	6,800	3,100	
GWT-6D	870	NS	940	300 U	300 U	150	300 U	63,000	170	35,000	280	17,000	2,300	1,100	1,600	
GWT-7S	31,000	NS	5,400	750	11,000	440	250 J	11,000	840	33,000	2,300	3,000	15,000	1,800	2,400	
GWT-7D	10,300	NS	1,800	250 J	1,000	1,100	2,300	11,000	300 U	300 U	13,000	3,600	12,000	8,300	53,000	
GWT-8S	199,000	580	1,000	300 U	380	1,800	130 J	3,000	350	24,000	80,000	7,700	9,200	35,000	6,500	
GWT-8D	9,400	240	8,300	5,100	12,500	300 U	1,700	30,000	25,000	39,000	15,000	3,000	14,000	22,000	7,300	
GWT-9S	143,000	300 U	300	950	300 U	300 U	300	230 J	110 J	300 U	30,000	NS	6,800	1,700	1,100	
GWT-9D	12,500	300 U	800	300 U	300 U	300 U	300	2,600	3,900	30,000	120 J	300 U	920	140 J	300	
GWT-10S	920,000	2,000	470	300 U	290	480	300	3,000	560	1,000	38,000	11,000	32,000	3,200	870	
GWT-10D	990	300 U	170 J	300 U	300 U	500	280 J	46,000	440	3,000	30,000	8,400	22,000	11,000	23,000	
GWT-11S	78,000	NS	1,400	3,000	300 U	1,300	280 J	8,400	860	12,000	1,500	650	20,000	1,400	4,600	
GWT-11D	4,400	NS	2,300	1,200	300 U	660	120 J	1,200,000	25,000	150,000	6,300	6,500	15,000	33,000	13,000	
GWT-12S	54,000	NS	490	300 U	300	300 U	300	1,100	57,000	32,000	14,000	4,700	4,400	930	3,700	
GWT-12D	57,000	NS	480	300 U	300 U	NA	120 J	38,000	1,300	30,000	2,000	1,200	3,100	530	4,100	
GWT-13S	148,000	330	260 J	240	300 U	300 U	210 J	380	730	3,500	8,400	1,400	7,000	1,300	2,100	
GWT-13D	11,300	300	1,700	300 U	300 U	140 J	2,800	330,000	3,000	300,000	3,100	850	32,000	3,200	7,700	
GWT-14S	36,000	300 U	1,200	3,100	960	700	8,100	34,000	11,000	69,000	36,000	25,000	57,000	16,000	10,000	
GWT-14D	81,000	300 U	2,000	6,700	5,600	960	1,400	31,000	12,000	350,000	23,000	3,200	6,500	12,000	6,100	
GWT-15S	143,000	300 U	130 J	300 U	300 U	300 U	300	510	100 J	5,700	250,000	3,300	11,000	5,200	13,000	
GWT-15D	1,040	240	2,000	300 U	300 U	450	370	2,200,000	440	NS	400	260	5,200	180	3,000	

NOTES:
 All results in CFU/mL (colony forming units/mL)
 J - Value detected at concentration below practical quantitation limit (PQL)
 U - Undetected - The value 300 denotes the practical quantitation limit.
 NS - Not Sampled
 SC - Sample Contaminated

TABLE 7
SUMMARY OF GEOCHEMICAL DATA IN CONTROL AND TEST PLOTS
ESTCP Propane Biosparging Demonstration
Port Hueneme, CA
Envirogen Project No. 92132
Page 1 of 6

Date	GWC1S														
	1/9/01 - 1/11/01	4/30/01 - 5/2/01	5/21/01 - 5/23/01	6/12/01 - 6/14/01	6/25/01 - 6/27/01	7/10/01-7/12/01	7/23/01 - 7/25/01	8/20/01 - 8/22/01	9/24/01 - 9/26/01	10/22/01 - 10/24/01	11/27/01 - 11/29/01	12/17/01 - 12/19/01	1/14/02 - 1/15/02	2/19/02 - 2/21/02	3/11/2002 - 3/12/02
Chloride	65	NA	83	81	89	84	87	90	98	95	50	NA	84	82	92
Nitrite	0.15 J	NA	0.2 U	0.36	0.2 U	0.2 U	0.2 U	0.2 U	0.2 U	0.2 U	0.2 U	NA	0.2 U	0.2 U	0.2 U
Bromide	NA	NA	1.6	NA	NA	NA	NA	NA	NA	NA	NA	NA	NA	NA	NA
Nitrate	0.2	NA	0.43	0.2 U	0.3	0.32	0.3	0.25	0.3	0.2 U	0.34	NA	0.2 U	0.3	0.2 U
o-Phosphate	0.2 U	NA	0.2 U	2 U	0.2 U	0.2 U	0.2 U	0.2 U	0.2 U	0.2 U	0.2 U	NA	0.2 U	0.2 U	0.2 U
Sulfate	1350	NA	1400	1400	1300	1400	1300	1400	1,300	1250	600	NA	1120	860	1300
Ammonia	0.81	NA	1 U	0.3 J	0.5 U	0.7	0.5 U	1.3	0.4 J	0.5	0.5 U	NA	0.3 J	0.3 J	0.5 U
Alkalinity	430	NA	490	520	420	430	430	440	500	490	280	NA	480	460	500
CO2	50	NA	59	70	50	64	65	90	93	20	NA	NA	54	62	70
Methane	0.006	NA	0.002 U	0.004	0.0035	0.0027	0.002 U	0.002 U	0.002 U	0.003	0.002	NA	0.004	0.007	0.0069
Ethane	0.002 U	NA	0.002 U	0.002 U	0.002 U	0.002 U	0.002 U	0.002 U	0.002 U	0.002 U	0.002 U	NA	0.002 U	0.002 U	0.002 U
Ethene	0.002 U	NA	0.002 U	0.002 U	0.002 U	0.002 U	0.002 U	0.002 U	0.002 U	0.002 U	0.002 U	NA	0.002 U	0.002 U	0.002 U
Propane	NA	NA	0.002 U	0.002 U	0.002 U	0.002 U	0.002 U	0.004	0.002 U	0.002 U	0.002 U	NA	0.002 U	0.002 U	0.002 U
cBOD	3.9	NA	2.9	2 U	2 U	2 U	2 U	2 U	2 U	1.3 J	3.6	NA	3	2 U	20
COD	41	NA	23	34	11	10 U	45	28	5.7 J	25	61	NA	28	24	21
TOC	1 U	NA	6.8	7.6	6.8	4.9	6.8	5.9	6.5	4.9	15	NA	7.5	8.6	7.1
Total Suspended Sol	NA	NA	NA	1	NA	NA	1 J	NA	7	16	8	NA	26	8	15
Total Phosphate	0.27	NA	0.13 J	0.31	0.1 U	0.07 J	0.1 J	0.21	0.14	0.27	0.15	NA	0.11	0.1	0.18
Barium	NA	NA	NA	NA	NA	NA	10 U	NA	10 U	20 U	NA	NA	NA	NA	NA
Calcium	NA	NA	NA	460	NA	NA	410	NA	200	180	NA	NA	NA	160	NA
Magnesium	NA	NA	NA	350	NA	NA	110	NA	140	130	NA	NA	NA	98	NA
Manganese	NA	NA	NA	NA	NA	NA	1.13	NA	1.04	1.13	NA	NA	NA	NA	NA
Potassium	NA	NA	NA	3.6	NA	NA	7.8	NA	4.7	4	NA	NA	NA	2.9	NA
Sodium	NA	NA	NA	210	NA	NA	250	NA	150	100	NA	NA	NA	180	NA

Date	GWC1D														
	1/9/01 - 1/11/01	4/30/01 - 5/2/01	5/21/01 - 5/23/01	6/12/01 - 6/14/01	6/25/01 - 6/27/01	7/10/01-7/12/01	7/23/01 - 7/25/01	8/20/01 - 8/22/01	9/24/01 - 9/26/01	10/22/01 - 10/24/01	11/27/01 - 11/29/01	12/17/01 - 12/19/01	1/14/02 - 1/15/02	2/19/02 - 2/21/02	3/11/2002 - 3/12/02
Chloride	100	NA	85	100	120	120	110	110	110	100	93	NA	89	86	104
Nitrite	0.2 U	NA	0.2 U	0.2 U	0.2 U	0.2 U	0.2 U	0.2 U	0.2 U	0.2 U	0.2 U	NA	0.2 U	0.2 U	0.2 U
Bromide	NA	NA	1.3	NA	NA	NA	NA	NA	NA	NA	NA	NA	NA	NA	NA
Nitrate	0.2 U	NA	0.2 U	0.2 U	0.2 U	0.2 U	0.2 U	0.2 U	0.2 U	0.2 U	0.2 U	NA	0.2 U	0.2 U	0.2 U
o-Phosphate	0.2 U	NA	0.2 U	0.2 U	0.2 U	0.2 U	0.2 U	0.2 U	0.2 U	0.2 U	0.2 U	NA	0.2 U	0.2 U	0.2 U
Sulfate	1040	NA	1200	1300	1100	1100	1100	1100	1200	1100	1200	NA	1200	1100	1100
Ammonia	1.3	NA	1.1	1.1	0.5	2.5	0.9	6.8	0.5 U	0.8	0.9	NA	1.7	9.8	1.8
Alkalinity	590	NA	580	590	500	500	500	510	560	550	530	NA	520	510	520
CO2	49	NA	71	84	71	67	68	56	75	63	44	NA	74	70	63
Methane	0.012	NA	0.01	0.001 J	0.018	0.0097	0.018	0.013	0.009	0.012	0.005	NA	0.008	0.007	0.015
Ethane	0.002 U	NA	0.002 U	0.002 U	0.002 U	0.002 U	0.002 U	0.002 U	0.002 U	0.002 U	0.002 U	NA	0.002 U	0.002 U	0.002 U
Ethene	0.002 U	NA	0.002 U	0.002 U	0.002 U	0.002 U	0.002 U	0.002 U	0.002 U	0.002 U	0.002 U	NA	0.002 U	0.002 U	0.002 U
Propane	NA	NA	0.002 U	0.002 U	0.002 U	0.002 U	0.002 U	0.002 U	0.002 U	0.002 U	0.002 U	NA	0.002 U	0.002 U	0.002 U
cBOD	3.1	NA	2 U	2 U	2 U	2 U	2 U	2 U	2 U	1.1 J	3.6	NA	2 U	10	20
COD	28	NA	25	31	14	10 U	80	25	26	31	61	NA	18	29	21
TOC	1 U	NA	6.3	6.4	6.2	5.5	6.4	5.1	5	5	15	NA	6.6	5.1	6.3
Total Suspended Sol	NA	NA	NA	26	NA	NA	22	NA	54	39	8	NA	65	25	30
Total Phosphate	0.3	NA	0.26	0.29	0.47	0.5	0.3	0.32	0.44	0.36	0.15	NA	0.31	0.36	0.37
Barium	NA	NA	NA	NA	NA	NA	10 U	NA	10 U	20 U	NA	NA	NA	NA	NA
Calcium	NA	NA	NA	510	NA	NA	410	NA	240	200	NA	NA	NA	290	NA
Magnesium	NA	NA	NA	126	NA	NA	190	NA	75	110	NA	NA	NA	110	NA
Manganese	NA	NA	NA	NA	NA	NA	0.83	NA	1.3	1.94	NA	NA	NA	NA	NA
Potassium	NA	NA	NA	4.6	NA	NA	6.8	NA	5.2	4.1	NA	NA	NA	4.3	NA
Sodium	NA	NA	NA	280	NA	NA	180	NA	180	110	NA	NA	NA	240	NA

NOTES:
All units in mg/L
U - indicates that compound was not detected above Practical Quantitation Limit (PQL)
J - compound was detected at concentration below PQL

TABLE 7
SUMMARY OF GEOCHEMICAL DATA IN CONTROL AND TEST PLOTS
 ESTCP Propane Biosparging Demonstration
 Port Hueneme, CA
 Envirogen Project No. 92132
 Page 2 of 6

GWC6S															
Date	1/9/01 - 1/11/01	4/30/01 - 5/2/01	5/21/01 - 5/23/01	6/12/01 - 6/14/01	6/25/01 - 6/27/01	7/10/01-7/12/01	7/23/01 - 7/25/01	8/20/01 - 8/22/01	9/24/01 - 9/26/01	10/22/01 - 10/24/01	11/27/01 - 11/29/01	12/17/01 - 12/19/01	1/14/02 - 1/15/02	2/19/02 - 2/21/02	3/11/2002 - 3/12/02
Chloride	38	NA	11	16	31	45	55	72	87	100	11	NA	44	16	72
Nitrite	0.2 U	NA	0.2 U	0.2 U	0.2 U	0.2 U	0.2 U	0.2 U	0.2 U	0.2 U	0.2 U	NA	0.2 U	0.2 U	0.2 U
Bromide	NA	NA	0.38	NA	NA	NA	NA	NA	NA	NA	NA	NA	NA	NA	NA
Nitrate	0.3	NA	0.38	0.6 U	0.6	0.84	0.63	0.57	0.8	0.52	2.55	NA	1.3	1.8	1.1
o-Phosphate	0.2 U	NA	0.2 U	0.2 U	0.2 U	0.2 U	0.2 U	0.2 U	0.2 U	0.2 U	0.2 U	NA	0.2 U	0.2 U	0.2 U
Sulfate	1500	NA	1100	900	1000	1200	1500	1300	1400	1200	80	NA	570	190	920
Ammonia	0.39	NA	0.5 U	0.5 U	0.5 U	0.5	0.5 U	4	0.5 U	0.5 U	0.5 U	NA	0.3 J	0.5 U	0.5 U
Alkalinity	360	NA	250	7.8 J	260	290	330	370	440	490	130	NA	310	170	410
CO2	120	NA	32	130	28	30	40	53	70	75	0.6	NA	28	12	49
Methane	0.002 U	NA	0.002 U	0.0015 J	0.002 U	0.0027	0.017 J	0.002 U	0.003	0.003	0.002 U	NA	0.002	0.005	0.0018 J
Ethane	0.002 U	NA	0.002 U	0.002 U	0.002 U	0.002 U	0.002 U	0.002 U	0.002 U	0.002 U	0.002 U	NA	0.002 U	0.002 U	0.002 U
Ethene	0.002 U	NA	0.002 U	0.002 U	0.002 U	0.002 U	0.002 U	0.002 U	0.002 U	0.002 U	0.002 U	NA	0.002 U	0.002 U	0.002 U
Propane	NA	NA	0.002 U	0.002 U	0.002 U	0.002 U	0.002 U	0.002 U	0.002 U	0.002 U	0.002 U	NA	0.002 U	0.002 U	0.002 U
cBOD	3.5	NA	2 U	2 U	2 U	2 U	2 U	2 U	2 U	2 U	9.7	NA	2 U	2 U	2 U
COD	21	NA	11	17	10 U	10 U	74	17	8.5 J	21	40	NA	18	26	18
TOC	1 U	NA	5.6	3.1	5.1	5.1	5.9	7.5	5.3	6	5.2	NA	6.1	6.3	6.9
Total Suspended Sol	NA	NA	NA	18	NA	NA	16	NA	10	15	320	NA	420	12	37
Total Phosphate	10 J	NA	0.16 J	0.4	0.31	0.11	0.125 U	0.1 J	0.17	0.08 J	0.54	NA	0.25	0.09 J	0.42
Barium	NA	NA	NA	NA	NA	NA	10 U	NA	10 U	20 U	NA	NA	NA	NA	NA
Calcium	NA	NA	NA	430	NA	NA	450	NA	270	210	NA	NA	NA	61	NA
Magnesium	NA	NA	NA	94	NA	NA	120	NA	92	100	NA	NA	NA	26	NA
Manganese	NA	NA	NA	NA	NA	NA	0.05	NA	0.03	0.06	NA	NA	NA	NA	NA
Potassium	NA	NA	NA	1.8	NA	NA	6.5	NA	4.8	4.1	NA	NA	NA	1.6	NA
Sodium	NA	NA	NA	45	NA	NA	73	NA	200	87	NA	NA	NA	51	NA

GWC6D															
Date	1/9/01 - 1/11/01	4/30/01 - 5/2/01	5/21/01 - 5/23/01	6/12/01 - 6/14/01	6/25/01 - 6/27/01	7/10/01-7/12/01	7/23/01 - 7/25/01	8/20/01 - 8/22/01	9/24/01 - 9/26/01	10/22/01 - 10/24/01	11/27/01 - 11/29/01	12/17/01 - 12/19/01	1/14/02 - 1/15/02	2/19/02 - 2/21/02	3/11/2002 - 3/12/02
Chloride	94	NA	100	88	100	110	99	115	110	100	99	NA	90	95	105
Nitrite	0.2 U	NA	0.2 U	0.2 U	0.2 U	0.2 U	0.2 U	0.2	0.2 U	0.2 U	0.2 U	NA	0.2 U	0.2 U	0.2 U
Bromide	NA	NA	2.4	NA	NA	NA	NA	NA	NA	NA	NA	NA	NA	NA	NA
Nitrate	0.2 U	NA	0.2 U	0.24	0.4	0.28	0.34	0.28	0.4	0.27	0.33	NA	0.3	0.2 U	0.13 J
o-Phosphate	0.2 U	NA	0.2 U	0.2 U	0.2 U	0.2 U	0.2 U	0.2	0.2 U	0.2 U	0.2 U	NA	0.2 U	0.2 U	0.2 U
Sulfate	1100	NA	1400	1300	1300	1700	1400	8200	1300	1300	1200	NA	1170	1200	1200
Ammonia	1.1	NA	0.98	0.5 U	0.5 U	1	0.5 U	4	0.5 U	0.5 U	0.5 U	NA	0.3 J	2.8	0.5 U
Alkalinity	570	NA	520	18	380	350	340	350	410	420	520	NA	420	470	480
CO2	84	NA	83	420	61	56	68	92	82	53	90	NA	97	29	86
Methane	0.008	NA	0.008	0.0014 J	0.002 U	0.0027	0.003	0.002	0.002 U	0.003	0.001 J	NA	0.002	0.008	0.0042
Ethane	0.002 U	NA	0.002 U	0.002 U	0.002 U	0.002 U	0.002 U	0.002	0.002 U	0.002 U	0.002 U	NA	0.002 U	0.002 U	0.002 U
Ethene	0.002 U	NA	0.002 U	0.002 U	0.002 U	0.002 U	0.002 U	0.002	0.002 U	0.002 U	0.002 U	NA	0.002 U	0.002 U	0.002 U
Propane	NA	NA	0.002 U	0.002 U	0.002 U	0.002 U	0.002 U	0.002	0.002 U	0.002 U	0.002 U	NA	0.002 U	0.002 U	0.002 U
cBOD	3.4	NA	2 U	2 U	2 U	2 U	2 U	2	2 U	2 U	18	NA	2 U	2 U	2
COD	28	NA	20	34	14	10 U	43	14	14	18	18	NA	27	29	30
TOC	1 U	NA	6.5	7.2	6.6	4.9	6.2	6.1	4.6	5.1	5.6	NA	7.1	7	6.8
Total Suspended Sol	NA	NA	NA	75	NA	NA	5 J	NA	17	14	ND	NA	19	2	4
Total Phosphate	0.33	NA	0.25 U	0.1 J	0.25	0.17	0.125 U	0.19 J	0.11	0.1 U	25 U	NA	0.04 J	0.05 J	0.1 U
Barium	NA	NA	NA	NA	NA	NA	10 U	NA	10 U	20 U	NA	NA	NA	NA	NA
Calcium	NA	NA	NA	460	NA	NA	390	NA	230	190	NA	NA	NA	400	NA
Magnesium	NA	NA	NA	310	NA	NA	150	NA	110	99	NA	NA	NA	120	NA
Manganese	NA	NA	NA	NA	NA	NA	0.79	NA	0.59	0.81	NA	NA	NA	NA	NA
Potassium	NA	NA	NA	3.6	NA	NA	6.7	NA	5.4	4.8	NA	NA	NA	5.1	NA
Sodium	NA	NA	NA	250	NA	NA	220	NA	310	110	NA	NA	NA	290	NA

NOTES:
 All units in mg/L
 U - indicates that compound was not detected above Practical Quantitation Limit (PQL)
 J - compound was detected at concentration below PQL

TABLE 7
SUMMARY OF GEOCHEMICAL DATA IN CONTROL AND TEST PLOTS
 ESTCP Propane Biosparging Demonstration
 Port Hueneme, CA
 Envirogen Project No. 92132
 Page 3 of 6

GWT1S															
Date	1/9/01 - 1/11/01	4/30/01 - 5/2/01	5/21/01 - 5/23/01	6/12/01 - 6/14/01	6/25/01 - 6/27/01	7/10/01-7/12/01	7/23/01 - 7/25/01	8/20/01 - 8/22/01	9/24/01 - 9/26/01	10/22/01 - 10/26/01	11/27/01 - 11/29/01	12/18/01 - 12/19/01	1/14/02 - 1/15/02	2/19/02 - 2/21/02	3/11/02 - 3/12/02
Chloride	65	NA	63	55	62	62	61	71	74	73	72	68	72	67	68
Nitrite	0.2 U	NA	0.2 U	0.2 U	0.2 U	0.2 U	0.2 U	0.2 U	0.2 U	0.2 U	0.2 U	0.2 U	0.2 U	0.2 U	0.2 U
Bromide	NA	NA	1.3	NA	NA	NA	NA	NA	NA	NA	NA	NA	NA	NA	NA
Nitrate	3.7	NA	5	5	6.1	6.8	6.8	3.9	4.7	4.4	2	2.1	1.5	3.4	3.9
o-Phosphate	0.2 U	NA	0.2 U	0.2 U	0.4	0.2 U	0.2 U	0.8	0.2 U	0.4	0.2 U	0.2 U	0.2 U	0.2 U	0.2 U
Sulfate	1700	NA	1500	1400	1400	1400	1500	1500	1400	1400	1400	1600	1310	1500	1500
Ammonia	0.56	NA	1.5	0.5 U	0.5 U	0.6	6.9	2.7	0.5 U	0.5 U	0.5 U	0.27 J	0.3 J	9.8	0.5 U
Alkalinity	470	NA	430	440	350	330	330	370	430	430	460	450	450	430	430
CO2	62	NA	61	62	60	51	55	59	28	81	97	86	85	76	68
Methane	0.002 U	NA	0.002 U	0.0017 J	0.0027	0.0021	0.005	0.002 U	0.002 U	0.002 U	0.001 J	0.002	0.002	0.003	0.0014 J
Ethane	0.002 U	NA	0.002 J	0.002 U	0.002 U	0.002 U	0.002 U	0.002 U	0.002 U	0.002 U	0.002 U	0.002 U	0.002 U	0.002 U	0.002 U
Ethene	0.002 U	NA	0.002 U	0.002 U	0.002 U	0.002 U	0.002 U	0.002 U	0.002 U	0.002 U	0.002 U	0.002 U	0.002 U	0.002 U	0.002 U
Propane	NA	NA	0.001	0.002 U	0.0015 J	0.001	0.002 U	0.01	0.002 U	0.002 U	0.002 U	0.02	0.002 U	0.002 U	0.002 U
cBOD	2.1	NA	2 U	2 U	2 U	2	2 U	2 U	2.5	2 U	26	2 U	2 U	11	4.1
COD	18	NA	17	28	11	10	40	10 U	8.5 J	18	12	37	12	8.9 J	12
TOC	1 U	NA	6.3	6.1	7.5	5.7	7.4	4.9	4.7	5	5.2	5.2	6.3	6.1	6.2
Total Suspended Sol	NA	NA	NA	0	NA	NA	1 J	NA	2	10	4	27	12	3	0
Total Phosphate	0.25 U	NA	0.15 J	0.07 J	0.17	0.25 U	0.25 U	0.05 J	0.09 J	0.1 U	0.2	0.12	0.05 J	0.32	0.1 U
Barium	NA	NA	NA	NA	NA	NA	10 U	NA	10 U	20 U	NA	10 U	NA	NA	NA
Calcium	NA	NA	NA	420	NA	NA	390	NA	220	190	NA	290	NA	280	NA
Magnesium	NA	NA	NA	380	NA	NA	220	NA	150	170	NA	170	NA	180	NA
Manganese	NA	NA	NA	NA	NA	NA	0.05	NA	0.1	0.06	NA	0.06	NA	NA	NA
Potassium	NA	NA	NA	3.6	NA	NA	6	NA	3.6	2.8	NA	4.2	NA	3.1	NA
Sodium	NA	NA	NA	240	NA	NA	180	NA	160	96	NA	220	NA	240	NA

GWT1D															
Date	1/9/01 - 1/11/01	4/30/01 - 5/2/01	5/21/01 - 5/23/01	6/12/01 - 6/14/01	6/25/01 - 6/27/01	7/10/01-7/12/01	7/23/01 - 7/25/01	8/20/01 - 8/22/01	9/24/01 - 9/26/01	10/22/01 - 10/24/01	11/27/01 - 11/29/01	12/17/01 - 12/19/01	1/14/02 - 1/15/02	2/19/02 - 2/21/02	3/11/2002 - 3/12/02
Chloride	84	NA	92	82	92	98	88	82	96	89	86	76	80	91	96
Nitrite	0.2 U	NA	0.2 U	0.2 U	0.2 U	0.2 U	0.2 U	0.2 U	0.2 U	0.2 U	0.2 U	0.2 U	0.2 U	0.2 U	0.2 U
Bromide	NA	NA	1.6	NA	NA	NA	NA	NA	NA	NA	NA	NA	NA	NA	NA
Nitrate	0.2 U	NA	0.2 U	0.2 U	0.2 U	0.13 J	0.2 U	0.2 U	0.2	0.2 U	0.2 U	0.2 U	0.2 U	0.2 U	0.2 U
o-Phosphate	0.2 U	NA	0.2 U	0.2 U	0.2 U	0.2 U	0.2 U	0.2 U	0.2 U	0.2 U	0.2 U	0.2 U	1.9	0.2 U	0.2 U
Sulfate	1200	NA	1400	1300	1300	1200	1300	2000	1300	1200	1300	1460	1310	1100	1300
Ammonia	0.5 U	NA	3.2	0.7	0.2 J	1.2	0.5 U	5.4	0.5 U	0.03 J	0.5 U	0.27	0.4 J	15	0.7
Alkalinity	520	NA	580	530	420	430	430	430	480	480	470	461	480	480	590
CO2	140	NA	86	63	61	60	59	68	55	37	59	80	62	50	97
Methane	0.007	NA	0.0086	0.0049	0.0037	0.0047	0.006	0.0028	0.003	0.003	0.002	0.002	0.003	0.005	0.0036
Ethane	0.002 U	NA	0.002 U	0.002 U	0.002 U	0.002 U	0.002 U	0.002 U	0.002 U	0.002 U	0.002 U	0.002 U	0.002 U	0.002 U	0.002 U
Ethene	0.002 U	NA	0.002 U	0.002 U	0.002 U	0.002 U	0.002 U	0.002 U	0.002 U	0.002 U	0.002 U	0.002 U	0.002 U	0.002 U	0.002 U
Propane	NA	NA	0.0016 J	0.002 U	0.002 U	0.002 U	0.002 U	0.002 U	0.002 U	0.01	0.002 U	0.002 U	0.002 U	0.002 U	0.002 U
cBOD	1.7 J	NA	2.7	2 U	2 U	2 U	2 U	2 U	2 U	2.4	16	5.7	1.5 J	2 U	3.2
COD	22	NA	23	28	17	10 U	120	10 U	20	25	31	18	12	12	15
TOC	1 U	NA	6.7	5.2	7.1	5.5	5.9	4	4.7	4.7	5	4.7	5.9	5.6	6.1
Total Suspended Sol	NA	NA	NA	13	NA	NA	17	NA	14	18	7	18	16	6	10
Total Phosphate	10 J	NA	0.31	0.13 J	12 J	0.09 J	0.1 J	0.12	0.1 U	0.1 U	0.09 J	0.11	0.1	0.07 J	0.1 U
Barium	NA	NA	NA	NA	NA	NA	10 U	NA	10 U	20 U	NA	10 U	NA	NA	NA
Calcium	NA	NA	NA	5	NA	NA	450	NA	240	210	NA	280	NA	310	NA
Magnesium	NA	NA	NA	25	NA	NA	130	NA	86	94	NA	100	NA	110	NA
Manganese	NA	NA	NA	NA	NA	NA	1.28	NA	1.56	1.77	NA	0.85	NA	NA	NA
Potassium	NA	NA	NA	4.6	NA	NA	8.3	NA	3.5	4.1	NA	6.3	NA	5.2	NA
Sodium	NA	NA	NA	280	NA	NA	260	NA	220	105	NA	210	NA	260	NA

NOTES:
 All units in mg/L
 U - indicates that compound was not detected above Practical Quantitation Limit (PQL)
 J - compound was detected at concentration below PQL

TABLE 7
SUMMARY OF GEOCHEMICAL DATA IN CONTROL AND TEST PLOTS
ESTCP Propane Biosparging Demonstration
Port Hueneme, CA
Envirogen Project No. 92132
Page 4 of 6

GWT3S															
Date	1/9/01 - 1/11/01	4/30/01 - 5/2/01	5/21/01 - 5/23/01	6/12/01 - 6/14/01	6/25/01 - 6/27/01	7/10/01-7/12/01	7/23/01 - 7/25/01	8/20/01 - 8/22/01	9/24/01 - 9/26/01	10/22/01 - 10/24/01	11/27/01 - 11/29/01	12/17/01 - 12/19/01	1/14/02 - 1/15/02	2/19/02 - 2/21/02	3/11/2002 - 3/12/02
Chloride	76	NA	34	41	53	58	56	106	75	64	66	60	63	62	76
Nitrite	0.2 U	NA	0.2 U	0.2 U	0.2 U	0.2 U	0.2 U	0.2 U	0.2 U	0.2 U	0.2 U	0.2 U	0.2 U	0.2 U	0.2 U
Bromide	NA	NA	3.1	NA	NA	NA	NA	NA	NA	NA	NA	NA	NA	NA	NA
Nitrate	1.3	NA	0.11 J	0.2 U	0.2 U	0.2 U	0.2 U	0.2 U	0.4	0.33	0.2 U	0.2 U	0.2 U	0.2 U	0.2 U
o-Phosphate	0.2 U	NA	0.2 U	0.2 U	0.2 U	0.2 U	0.2 U	0.2 U	0.2 U	0.2 U	0.2 U	0.2 U	0.2 U	0.2 U	0.2 U
Sulfate	1350	NA	880	950	1100	1000	1100	1300	1300	1300	1200	1300	1160	1200	1300
Ammonia	0.5	NA	1.1	0.6	0.5 U	0.5 U	0.5 U	2.7	0.4J	0.5 U	0.5 U	1.1	0.56	5.6	0.5 U
Alkalinity	430	NA	290	340	320	350	370	380	NA	420	490	460	480	10 U	460
CO2	120	NA	24	43	53	63	83	60	NA	35	53	150	160	2 U	100
Methane	0.005	NA	0.008 U	0.0029	0.0031	0.0031	0.005	0.002 U	0.002	0.003	0.002 U	0.002	0.003	0.003	0.002
Ethane	0.002 U	NA	0.002 U	0.053	0.063	0.11	0.12	0.11	0.024	0.01	0.024	0.002 U	0.03	0.004	0.063
Ethene	0.002 U	NA	0.002 U	0.002 U	0.002 U	0.002 U	0.002 U	0.002 U	0.002 U	0.002 U	0.002 U	0.002 U	0.002 U	0.002 U	0.002 U
Propane	NA	NA	1.1	1.2	0.002 U	1.6	1.4	3.9	2.9	0.76	2.7	3.2	2.2	0.24	1.5
cBOD	4.4	NA	14	17	6.4	13	12	18	2 U	2.2	33	4.5	8	2 U	9.9
COD	36	NA	31	34	20	10 U	150	35	20	25	22	28	18	24	32
TOC	1 U	NA	5.5	5.5	7.5	6.4	7.6	7.9	5.8	6.7	8.4	6.8	8	7.3	8.1
Total Suspended Sol	NA	NA	NA	1	NA	NA	1 J	NA	10	14	10	10	15	14	8
Total Phosphate	0.1 J	NA	0.25 U	0.05 J	0.21	0.25 U	0.25 U	0.27	0.09 J	0.1 U	0.14	0.1	0.13	0.1 J	0.14
Barium	NA	NA	NA	NA	NA	NA	10 U	NA	10 U	20 U	NA	10 U	NA	NA	NA
Calcium	NA	NA	NA	410	NA	NA	430	NA	260	240	NA	300	NA	350	NA
Magnesium	NA	NA	NA	200	NA	NA	140	NA	110	96	NA	99	NA	100	NA
Manganese	NA	NA	NA	NA	NA	NA	0.75	NA	0.78	0.81	NA	0.76	NA	NA	NA
Potassium	NA	NA	NA	2.3	NA	NA	6.2	NA	4.4	3.9	NA	5.5	NA	3.8	NA
Sodium	NA	NA	NA	140	NA	NA	130	NA	370	100	NA	180	NA	180	NA

GWT3D															
Date	1/9/01 - 1/11/01	4/30/01 - 5/2/01	5/21/01 - 5/23/01	6/12/01 - 6/14/01	6/25/01 - 6/27/01	7/10/01-7/12/01	7/23/01 - 7/25/01	8/20/01 - 8/22/01	9/24/01 - 9/26/01	10/22/01 - 10/26/01	11/27/01 - 11/29/01	12/18/01 - 12/19/01	1/14/02 - 1/15/02	2/19/02 - 2/21/02	3/11/02 - 3/12/02
Chloride	101	NA	85	80	94	87	80	83	84	76	84	83	74	74	83
Nitrite	0.2 U	NA	0.2 U	0.2 U	0.2 U	0.2 U	0.2 U	0.2 U	0.2 U	0.2 U	0.2 U	0.2 U	0.2 U	0.2 U	0.2 U
Bromide	NA	NA	3.8	NA	NA	NA	NA	NA	NA	NA	NA	NA	NA	NA	NA
Nitrate	0.2 U	NA	0.2 U	0.2 U	0.2 U	0.2 U	0.2 U	0.2 U	0.3	0.2	0.2	0.27	0.2 U	0.2 U	0.14 J
o-Phosphate	0.2 U	NA	0.2 U	0.2 U	0.2 U	0.2 U	0.2 U	0.2 U	0.2 U	0.2 U	0.2 U	0.2 U	0.2 U	0.2 U	0.2 U
Sulfate	1000	NA	1400	1300	1300	1300	1500	1500	1400	1300	1200	1200	1280	1300	1500
Ammonia	1.2	NA	2.7	0.5	0.5 U	1	0.5 U	4	0.5 U	0.3 J	0.5 U	1.1	0.03 J	11	0.7
Alkalinity	550	NA	400	360	310	320	320	290	350	340	340	360	360	300	310
CO2	210	NA	51	72	60	78	80	73	85	69	68	86	49	44	58
Methane	0.005	NA	0.008 U	0.003	0.0037	0.0026	0.005	0.002 U	0.062	0.003	0.001 J	0.002	0.002	0.003	0.0053
Ethane	0.002 U	NA	0.002 U	0.085	0.17	0.022	0.13	0.085	0.027	0.027	0.002 U	0.002 U	0.012	0.007	0.24
Ethene	0.002 U	NA	0.002 U	0.002 U	0.002 U	0.002 U	0.002 U	0.002 U	0.002 U	0.002 U	0.002 U	0.002 U	0.002 U	0.002 U	0.002 U
Propane	NA	NA	7.1	5.6	4.4	2.1	1.9	4.9	2.4	2.7	0.96	3.4	3.4	0.35	9.6
cBOD	2.5	NA	16	51	11	12	2 U	6	5	2 U	23	7	9.7	2 U	50
COD	41	NA	34	40	23	10 U	180	23	20	80	37	31	27	29	60
TOC	1 U	NA	6.9	6.9	8.6	7.1	10	6.9	5.8	7.4	7.1	6.9	8.6	7.5	8.5
Total Suspended Sol	NA	NA	NA	5	NA	NA	6 J	NA	9	13	52	10	30	12	4
Total Phosphate	0.16 J	NA	0.25 U	0.07 J	0.17	0.25 U	0.25 U	0.04 J	0.1 U	25 U	0.15	0.08 J	0.12	0.05 J	0.11
Barium	NA	NA	NA	NA	NA	NA	10 U	NA	10 U	20 U	NA	10 U	NA	NA	NA
Calcium	NA	NA	NA	470	NA	NA	430	NA	250	210	NA	200	NA	360	NA
Magnesium	NA	NA	NA	220	NA	NA	140	NA	100	100	NA	73	NA	100	NA
Manganese	NA	NA	NA	NA	NA	NA	0.6	NA	0.72	0.65	NA	0.38	NA	NA	NA
Potassium	NA	NA	NA	5	NA	NA	7.3	NA	6.7	5.7	NA	6.3	NA	6.1	NA
Sodium	NA	NA	NA	260	NA	NA	240	NA	180	120	NA	210	NA	250	NA

NOTES:
All units in mg/L
U - indicates that compound was not detected above Practical Quantitation Limit (PQL)
J - compound was detected at concentration below PQL

TABLE 7
SUMMARY OF GEOCHEMICAL DATA IN CONTROL AND TEST PLOTS
 ESTCP Propane Biosparging Demonstration
 Port Hueneme, CA
 Envirogen Project No. 92132
 Page 5 of 6

GWT9S															
Date	1/9/01 - 1/11/01	4/30/01 - 5/2/01	5/21/01 - 5/23/01	6/12/01 - 6/14/01	6/25/01 - 6/27/01	7/10/01-7/12/01	7/23/01 - 7/25/01	8/20/01 - 8/22/01	9/24/01 - 9/26/01	10/22/01 - 10/24/01	11/27/01 - 11/29/01	12/17/01 - 12/19/01	1/14/02 - 1/15/02	2/19/02 - 2/21/02	3/11/2002 - 3/12/02
Chloride	8.9	NA	19	29	43	49	53	72	77	64	13	42	48	40	60
Nitrite	0.2 U	NA	0.2 U	0.2 U	0.2 U	0.2 U	0.2 U	0.2 U	0.2 U	0.2 U	0.2 U	0.2 U	0.2 U	0.2 U	0.2 U
Bromide	NA	NA	0.34	NA	NA	NA	NA	NA	NA	NA	NA	NA	NA	NA	NA
Nitrate	2.4	NA	0.15 J	0.24	0.2 U	0.2 U	0.2 U	0.2 U	0.23	0.58	0.16	0.2 U	0.2 U	0.2 U	0.2 U
o-Phosphate	0.2 U	NA	0.2 U	0.2 U	0.2 U	0.2 U	0.2 U	0.2 U	0.2 U	0.2 U	0.25	0.2 U	0.2 U	0.2 U	0.2 U
Sulfate	20	NA	550	650	760	840	980	1200	1200	1200	125	700	710	670	1100
Ammonia	0.36 J	NA	1.2	0.5 U	0.7	0.7	0.5 U	6.8	0.5 U	0.3 J	0.5 U	0.5 U	0.3 J	4.2	1.4
Alkalinity	60	NA	160	210	210	240	270	350	470	470	230	320	440	430	480
CO2	31	NA	21	20	24	25	28	30	68	45	23	60	88	73	47
Methane	0.002 U	NA	0.0077	0.0017 J	0.04 U	0.0028	0.005	0.002	0.003	0.003	0.002 U	0.002	0.002	0.003	0.0026
Ethane	0.002 U	NA	0.0028	0.011	0.038	0.08	0.11	0.065	0.11	0.057	0.002 U	0.028	0.018 J	0.03	0.028
Ethene	0.002 U	NA	0.002 U	0.002 U	0.04 U	0.002 U	0.002 U	0.002 U	0.002 U	0.002 U	0.002 U	0.002 U	0.002 U	3	0.028
Propane	NA	NA	0.071	0.39	1.31	1.1	1.4	3.2	5.2	3.1	0.015	1.6	1.7	0.004	1.9
cBOD	5.4	NA	2 U	1.4 J	2 U	3	2 U	10	4.3	13	2	8.1	4.5	8	5
COD	28	NA	14	17	11	10 U	65	28	31	34	34	43	23	18	21
TOC	2.2	NA	6.2	5.7	5.7	8.5	11	6.2	3.8	6.5	8.1	6.4	4.6	7.5	7.4
Total Suspended Sol	NA	NA	NA	2	NA	NA	10 U	NA	5	10	16	11	28	2	4
Total Phosphate	0.39	NA	0.13 J	0.03 J	0.14	0.25 U	0.125 U	0.06 J	0.1	0.1 U	0.19	0.09 J	0.15	0.1	0.1 U
Barium	NA	NA	NA	NA	NA	NA	10 U	NA	10 U	20 U	ND	10 U	NA	NA	NA
Calcium	NA	NA	NA	350	NA	NA	380	NA	260	230	120	230	NA	270	NA
Magnesium	NA	NA	NA	110	NA	NA	110	NA	61	79	18	59	NA	38	NA
Manganese	NA	NA	NA	NA	NA	NA	0.5	NA	0.98	1.29	0.18	0.65	NA	NA	NA
Potassium	NA	NA	NA	2	NA	NA	5.5	NA	5.1	4.3	1.3	4.3	NA	1.9	NA
Sodium	NA	NA	NA	55	NA	NA	100	NA	160	80	28	110	NA	55	NA

GWT9D															
Date	1/9/01 - 1/11/01	4/30/01 - 5/2/01	5/20/01 - 5/22/01	6/12/01 - 6/14/01	6/25/01 - 6/27/01	7/10/01-7/12/01	7/23/01 - 7/25/01	8/20/01 - 8/22/01	9/24/01 - 9/26/01	10/22/01 - 10/26/01	11/27/01 - 11/29/01	12/18/01 - 12/19/01	1/14/02 - 1/15/02	2/19/02 - 2/21/02	3/11/02 - 3/12/02
Chloride	61	NA	80	77	93	91	85	82	75	74	75	75	78	72	87
Nitrite	0.2 U	NA	0.2 U	0.2 U	0.2 U	0.2 U	0.2 U	0.2 U	0.2 U	0.2 U	0.2 U	0.2 U	0.2 U	0.2 U	0.2 U
Bromide	NA	NA	4.1	NA	NA	NA	NA	NA	NA	NA	NA	NA	NA	NA	NA
Nitrate	0.2	NA	0.2 U	0.2 U	0.2 U	0.2 U	0.2 U	0.2 U	0.21	0.2 U	0.2 U	0.2 U	0.2 U	0.2 U	0.2 U
o-Phosphate	0.2 U	NA	0.2 U	0.2 U	0.2 U	0.2 U	0.2 U	0.2 U	0.2 U	0.2 U	0.2 U	0.2 U	0.2 U	0.2 U	0.2 U
Sulfate	630	NA	1280	1300	1300	1200	1300	1400	1300	1300	1300	1320	1320	1200	1200
Ammonia	1.2	NA	1.1	0.9	0.5 U	1.1	0.9	6.8	0.4 J	0.5	1.5	1.1	0.9	0.5 U	0.5 U
Alkalinity	330	NA	480	420	340	330	360	370	410	410	510	430	480	470	530
CO2	55	NA	70	70	NA	47	54	41	93	84	60	86	106	37	110
Methane	0.002 U	NA	0.0085	0.0035	0.04 U	0.003	0.006	0.0019 J	0.0031	0.003	0.002 U	0.003	0.002	0.003	0.0028
Ethane	0.002 U	NA	0.0088	0.027	0.06	0.1	0.1	0.0058	0.113	0.057	0.002 U	0.047	0.039	0.03	0.021
Ethene	0.002 U	NA	0.002 U	0.002 U	0.04 U	0.002 U	0.002 U	0.002 U	0.002 U	0.002 U	0.002 U	0.002 U	0.002 U	2	0.021
Propane	NA	NA	0.56	1.4	1.9	2.2	3.3	5.4	6.8	9.7	2.7	1.9	6.1	0.004	0.77
cBOD	7.1	NA	2 U	4.4	2 U	12	13	21	9.6	18	34	16	30	17	2.1
COD	26	NA	11	23	25	10 U	77	43	28	28	22	52	23	20	24
TOC	1 U	NA	6.5	6.1	7.6	72	7.6	6.9	5.4	6.4	6.4	6.2	7.6	6.8	7.7
Total Suspended Sol	NA	NA	NA	19	NA	NA	18	NA	29	30	32	29	39	17	26
Total Phosphate	0.31	NA	0.24 J	0.22 J	0.4	0.19	0.22	0.24	0.29	0.06 J	0.55	0.28	0.1 U	0.27	0.3
Barium	NA	NA	NA	NA	NA	NA	10 U	NA	10 U	20 U	ND	10 U	NA	NA	NA
Calcium	NA	NA	NA	490	NA	NA	410	NA	260	220	410	290	NA	450	NA
Magnesium	NA	NA	NA	220	NA	NA	140	NA	77	89	98	100	NA	110	NA
Manganese	NA	NA	NA	NA	NA	NA	1.2	NA	1.82	2.26	1.4	1.33	NA	NA	NA
Potassium	NA	NA	NA	4.6	NA	NA	6.8	NA	3.2	4.2	3.8	5.3	NA	5.2	NA
Sodium	NA	NA	NA	260	NA	NA	260	NA	150	105	170	220	NA	290	NA

NOTES:
 All units in mg/L
 U - indicates that compound was not detected above Practical Quantitation Limit (PQL)
 J - compound was detected at concentration below PQL

TABLE 7
SUMMARY OF GEOCHEMICAL DATA IN CONTROL AND TEST PLOTS
 ESTCP Propane Biosparging Demonstration
 Port Hueneme, CA
 Envirogen Project No. 92132
 Page 6 of 6

GWT15S															
Date	1/9/01 - 1/11/01	4/30/01 - 5/2/01	5/20/01 - 5/22/01	6/12/01 - 6/14/01	6/25/01 - 6/27/01	7/10/01-7/12/01	7/23/01 - 7/25/01	8/20/01 - 8/22/01	9/24/01 - 9/26/01	10/22/01 - 10/26/01	11/27/01 - 11/29/01	12/18/01 - 12/19/01	1/14/02 - 1/15/02	2/19/02 - 2/21/02	3/11/02 - 3/12/02
Chloride	12	NA	6.6	14	18	23	32	54	67	63	2.9	22	17	12	35
Nitrite	0.2 U	NA	0.2 U	0.2 U	0.2 U	0.2 U	0.2 U	0.2 U	0.2 U	0.2 U	0.2 U	0.2 U	0.2 U	0.2 U	0.2 U
Bromide	NA	NA	3.1	NA	NA	NA	NA	NA	NA	NA	NA	NA	NA	NA	NA
Nitrate	4.7	NA	0.5	0.43	0.2 U	0.2 U	0.2 U	0.2 U	0.24	0.2 U	0.82	0.2 U	0.2 U	0.2	0.2 U
o-Phosphate	0.2 U	NA	0.2 U	0.2 U	0.2 U	0.2 U	0.2 U	1.6	0.2 U	0.2 U	0.25	0.2 U	0.2 U	0.2 U	0.2 U
Sulfate	33	NA	260	400	410	480	600	1000	1,100	1200	6.7	430	300	210	890
Ammonia	0.7	NA	0.8	0.5 U	0.5 U	0.5 U	0.5 U	5.4	0.5 U	0.5 U	0.5 U	0.5 U	0.3 J	0.5 U	0.5 U
Alkalinity	65	NA	140	170	150	170	200	270	400	440	92	240	280	260	400
CO2	55	NA	8.9	20	9.5	9.4	15	19	51	68	3.5	26	28	31	64
Methane	0.002 U	NA	0.0067	0.002 U	0.04 U	0.0021	0.004	0.0026	0.0043	0.003	0.001 J	0.003	0.002	0.003	0.0029
Ethane	0.002 J	NA	0.002 U	0.002 U	0.02	0.027	0.06	0.18	0.106	0.087	0.002 U	0.063	0.036	0.01	0.052
Ethene	0.002 U	NA	0.002 U	0.002 U	0.04 U	0.002 U	0.002 U	0.002 U	0.002 U	0.002 U	0.002 U	0.002 U	0.002 U	0.002 U	0.002 U
Propane	NA	NA	0.004	0.08	0.46	1.6	1.5	5.4	4.9	5.2	0.026	2.4	1.2	0.7	1.7
cBOD	1.9 J	NA	2 U	11	2 U	3	7	3.9	2 U	9.6	35	5.6	9	4	13
COD	54	NA	17	8.5 J	10 U	10 U	60	28	31	83	25	25	12	12	24
TOC	5.7	NA	6.7	4.9	5.6	5.3	5.5	5.7	5.1	6	5.5	5.9	6.4	5.4	6.6
Total Suspended Sol	NA	NA	NA	0	NA	NA	10 U	NA	1	210	19	14	440	31	20
Total Phosphate	0.23 J	NA	0.25 U	0.05 J	0.1 U	0.1 U	0.125 U	0.06 J	0.1 U	0.1	0.1 U	0.1	0.14	0.1	0.1
Barium	NA	NA	NA	NA	NA	NA	10 U	NA	10 U	20 U	ND	10 U	NA	NA	NA
Calcium	NA	NA	NA	200	NA	NA	270	NA	250	220	28	140	NA	NA	NA
Magnesium	NA	NA	NA	59	NA	NA	90	NA	63	87	5	29	NA	NA	NA
Manganese	NA	NA	NA	NA	NA	NA	0.26	NA	0.65	0.81	0.02	0.25	NA	NA	NA
Potassium	NA	NA	NA	0.91	NA	NA	3.4	NA	4.1	4.1	0.9	2.5	NA	NA	NA
Sodium	NA	NA	NA	28	NA	NA	53	NA	130	64	8.2	38	NA	NA	NA

GWT15D															
Date	1/9/01 - 1/11/01	4/30/01 - 5/2/01	5/21/01 - 5/23/01	6/12/01 - 6/14/01	6/25/01 - 6/27/01	7/10/01-7/12/01	7/23/01 - 7/25/01	8/20/01 - 8/22/01	9/24/01 - 9/26/01	10/22/01 - 10/24/01	11/27/01 - 11/29/01	12/17/01 - 12/19/01	1/14/02 - 1/15/02	2/19/02 - 2/21/02	3/11/2002 - 3/12/02
Chloride	97	NA	84	83	88	91	87	87	82	78	85	77	86	80	98
Nitrite	0.2 U	NA	0.2 U	0.2 U	0.2 U	0.2 U	0.2 U	0.2 U	0.2 U	0.2 U	0.2 U	0.2 U	0.2 U	0.2 U	0.2 U
Bromide	NA	NA	0.8	NA	NA	NA	NA	NA	NA	NA	NA	NA	NA	NA	NA
Nitrate	0.2 U	NA	1	0.2 U	0.2 U	0.2 U	0.2 U	0.2 U	0.32	0.2 U	0.2 U	0.2 U	0.2 U	0.2	0.32
o-Phosphate	0.2 U	NA	0.2 U	0.2 U	0.2 U	0.2 U	0.2 U	0.2 U	0.2 U	0.2 U	0.2 U	0.2 U	0.2 U	0.2 U	0.2 U
Sulfate	1020	NA	1400	1200	1200	1200	1200	1400	1,400	1300	1200	1250	1210	1200	1400
Ammonia	2	NA	3.9	0.5 U	1.2	1	0.9	6.8	0.4 J	0.5	0.5 U	0.5 U	0.8	0.5 U	0.28 J
Alkalinity	540	NA	480	470	370	360	350	350	380	390	430	430	450	420	430
CO2	200	NA	80	73	59	56	60	6.9	65	38	66	97	94	63	47
Methane	0.006	NA	0.007	0.002 U	0.04 U	0.0033	0.005	0.004	0.002	0.003	0.002 U	0.002	0.003	0.002	0.002
Ethane	0.002 U	NA	0.002 U	0.002 U	0.04 U	0.015	0.04	0.11	0.01	0.04	0.02	0.02	0.015	0.002 U	0.002 U
Ethene	0.002 U	NA	0.002 U	0.002 U	0.04 U	0.002 U	0.002 U	0.002 U	0.002 U	0.002 U	0.002 U	0.002 U	0.002 U	0.002 U	0.002 U
Propane	NA	NA	0.0038	0.14	0.36	0.9	1.5	1.1	4	3.5	1.14	0.86	0.24	0.004	0.0049
cBOD	2.6	NA	2 U	4	2 U	2 U	5	11	4.4	9.8	32	3.6	7.7	2 U	20
COD	28	NA	25	20	23	10 U	50	28	23	25	28	28	12	15	15
TOC	1 U	NA	6.6	5.7	6.5	6.2	6.2	6.7	5.6	6.2	5.7	5.8	6.2	6.6	7.4
Total Suspended Sol	NA	NA	NA	12	NA	NA	15	NA	2,540	61	15	15	23	1	5
Total Phosphate	1.1	NA	0.22 J	0.23 J	0.28	0.1 U	0.16	0.21	0.23	0.05 J	0.27	0.16	0.14	0.1 U	0.1 U
Barium	NA	NA	NA	NA	NA	NA	10 U	NA	10 U	20 U	ND	10 U	NA	NA	NA
Calcium	NA	NA	NA	490	NA	NA	400	NA	250	210	370	300	NA	NA	NA
Magnesium	NA	NA	NA	220	NA	NA	140	NA	96	92	84	96	NA	NA	NA
Manganese	NA	NA	NA	NA	NA	NA	0.1	NA	1.82	1.94	0.2	0.71	NA	NA	NA
Potassium	NA	NA	NA	4.1	NA	NA	4	NA	3.7	4.7	4.4	6.2	NA	NA	NA
Sodium	NA	NA	NA	240	NA	NA	50	NA	330	110	230	230	NA	NA	NA

NOTES:
 All units in mg/L
 U - indicates that compound was not detected above Practical Quantitation Limit (PQL)
 J - compound was detected at concentration below PQL

TABLE 8: ANALYTICAL METHODS

ESTCP Propane Biosparging Final Report

Sample Matrix	Analysis	Method	Container Type	Container Size	Preservative	Holding Time
Groundwater	VOCs	SW 8260B	glass	40 ml (3)	HCl, cool (4°C)	7 days
	TBA	SW 8015B (P/T)	glass	40 ml (2)	HCl, cool (4°C)	14 days
	Total Heterotrophs	SM 9215C	plastic	50 ml	None	24 Hours
	Substrate Specific Heterotrophs	SM 9215C (modified)	plastic	50 ml	None	24 hours
	Carbon dioxide	SM 4500CO ₂	glass	40 ml (2)	None	14 days
	Propane	SW 8015B	glass	40 ml (2)	None	14 days
	Anions (see below)	EPA 300	plastic	250 ml	cool (4°C)	48 hours
	Cations (see below)	EPA 200 series	glass	200 ml	cool (4°C)	6 months
	Phosphate (Total)	EPA 365.2	glass	250 ml	cool (4°C)	14 days
	Alkalinity	EPA 310.1	glass	120 ml	None	14 days
	Ammonia Nitrogen	EPA 350.2	glass	250 ml	H ₂ SO ₄	28 days
	TOC	EPA 415.1	glass	40 ml (2)	H ₂ SO ₄	28 days
	COD	EPA 410.4	glass	120 ml	H ₂ SO ₄	28 days
cBOD ₅	EPA 405.1	plastic	500 ml	None	48 hours	
Soil	VOCs	SW 8260B	glass	4 ounce	MeOH, cool (4°C)	7 days
	TBA	SW 8015 (P/T)	glass	4 ounce	None	14 days
	TOC	EPA 415.1	glass	120 ml	None	28 days
	Grain size	ASTM D421, D422	glass	1L	None	N/A
Soil Vapor/Ambient Air Quality*	VOCs	SW 8260B	Tedlar bag	2-liter	None	7 days
	Propane	SW 8015B	Tedlar bag	2-liter	None	7 days

VOC - Volatile Organic Compounds

TBA – Tertiary Butyl Alcohol

Anions – Bromide, Chloride, Nitrate, Nitrite, Phosphate and Sulfate

TOC - Total Organic Carbon

COD – Carbon Oxygen Demand

cBOD₅ – Carbonaceous Biological Oxygen Demand

Cations: Barium, Calcium, Magnesium, Manganese, Potassium, and Sodium

DO - Dissolved Oxygen

SC – Specific Conductivity

T – Temperature

O₂ – Oxygen

CO₂ – Carbon Dioxide

N/A – Not Applicable

* Vapor samples are field-screened using a portable flame ionization detector.)

3.5.3 PERIOD OF OPERATION

A summary of demonstration activities is presented in Table 9. Oxygen and propane sparging were initiated on May 4, 2001. An inoculum of the propane-oxidizing bacterial culture ENV425 was grown at ENVIROGEN's facilities in Lawrenceville, NJ, and was shipped on ice overnight to the Site. Based on 16S rDNA sequencing, ENV425 it is most closely related to the bacterium *Rhodococcus ruber*. The inoculum was injected into the subsurface through the seven bacterial injection points on May 25, 2001. The bacterial injection protocol is attached as Appendix B. The demonstration continued through March 2002.

**TABLE 9
 SCHEDULE OF ACTIVITIES**

Date	Activity
4/30/01 – 5/2/01	Pre-sparging sampling. Start oxygen and propane sparge.
5/21/01 – 5/23/01	Pre-bioaugmentation Sampling
5/25/01	Bioaugmentation
6/12/01 – 6/14/01	Biweekly Demonstration Sampling 1
6/25/01 – 6/27/01	Biweekly Demonstration Sampling 2
7/10/01 – 7/12/01	Biweekly Demonstration Sampling 3
7/23/01 – 7/25/01	Biweekly Demonstration Sampling 4
Monthly (4-weekly) Sampling Start	
8/20/01 – 8/22/01	Demonstration Sampling 5
9/24/01 – 9/24/01	Demonstration Sampling 6
10/22/01 – 10/24/01	Demonstration Sampling 7
11/27/01 – 11/29/01	Demonstration Sampling 8
12/17/01 – 12/19/01	Demonstration Sampling 9
1/14/02 – 1/15/02	Demonstration Sampling 10
2/19/02 – 2/21/02	Demonstration Sampling 11
3/11/02 – 3/12/02	Demonstration Sampling 12

3.5.4 OPERATING PARAMETERS

Oxygen was injected into the subsurface in the Test and Control Plots through the Oxygen Injection Points (OIPs), and propane was injected into the subsurface in the Test Plot through the Propane Injection Points (PIPs). A system of solenoid valves and timers was used to inject the gases. Initial oxygen flow rates of 10 SCFH and propane flow rates of 1 SCFH were set at each injection point. The oxygen system operated for four, 6-minute cycles per day, yielding approximately 5 pounds of oxygen per day in the Test and Control Plots. The propane system operated for four, 10-minute cycles per day and yielded approximately 0.5 pounds of propane per day at the Test Plot.

Performance Optimization

The objective of the performance optimization phase of operations was to achieve adequate distribution of oxygen and propane to stimulate biodegradation of MTBE in the aquifer, and to ensure that fugitive emissions of VOCs did not occur during the demonstration. Initial oxygen and propane injection flow rates, duration, and frequency were to be modified as necessary during this period to achieve adequate substrate distribution throughout the demonstration plots.

After approximately six months of operation, a data review suggested that less-than-optimal MTBE degradation was occurring in the Test Plot. This was thought to be due to the presence of excess propane, which is a competitive inhibitor of MTBE degradation. After a review of the geochemical data, the decision was made to decrease the flow of propane from 1 SCFH to between 0.3 and 0.4 SCFH, corresponding to the addition of approximately 0.17 to 0.2 pounds of propane per day to the Test Plot.

Labor

In the ten-month demonstration period, Base personnel performed routine site checks and maintenance. The primary maintenance activity was the monitoring of the oxygen and propane tank contents and arranging for tank replacement when necessary. Part-time employees of ENVIROGEN worked at the site for 2 to 3 days per sampling event. Base personnel assisted in sampling activities when necessary.

3.5.5 AMOUNT OF MATERIAL TO BE TREATED

The dimensions of the demonstration plot, including both the test and control plots, were approximately 60 ft by 60ft. The treatment zone extended from the water table to 10 ft below the water table. Assuming a porosity of 0.3, the total volume of groundwater to be treated was approximately 81,000 gallons.

3.5.6 RESIDUALS HANDLING

Application of the propane biosparging technology does not generate any process waste. However, limited soil cuttings and groundwater derived from drilling and sampling were generated during the demonstration and were handled as follows:

The demonstration injection points, monitoring wells and vapor monitoring points were installed using Geoprobe™ methods to minimize drill-cutting volumes. Approximately 0.6 yards of soil cuttings were generated during installation of the demonstration wells. Soil cuttings were contained in DOT certified drums and were characterized and disposed of by Base personnel. Limited volumes of purge water were generated during low-flow sampling of each monitoring well. A total of approximately 750 gallons of purge water were generated during groundwater sampling activities. Purge water was contained on-site in drums and was characterized and disposed of by Base personnel.

3.5.7 EXPERIMENTAL DESIGN

Tracer studies were performed as part of the EPA certification process, and are described in Section 3.5.2. The operating conditions under which the demonstration was conducted are described in Section 3.5.4. Other than performance optimization activities described in that section, operating parameters were not varied during the 10-month demonstration. Additional experiments included the microcosm studies, which were conducted prior to the demonstration and are described in Section 3.4.2.

3.5.8 SAMPLING PLAN

The sampling plan for this site was developed in accordance with the objectives of determining the efficiency of treatment of MTBE and the evaluating the effect that demonstration activities would have on the geochemistry of the Site. All appropriate Quality Assurance/Quality Control samples and procedures were included in the execution of the Sampling Plan presented in the *Technology Demonstration Workplan* dated October 7, 2000, and in the QAP included in Appendix D.

Pre-demonstration sampling activities are described in Sections 3.4.1 and 3.5.2 above. All samples collected during pre- demonstration activities were analyzed according to the methods presented in Table 8. The demonstration sampling schedule outlined in the *Technology Demonstration Workplan* was developed based on anticipated performance characteristics derived through preliminary modeling efforts. A tracer study was performed during the early phase of operation to quantify groundwater flow velocity and solute transport parameters to aid in system performance refinement. These data indicated that the velocity of groundwater flow was lower than predicted. The sampling schedule was modified based on the results of the tracer study and based on the sampling requirements of the California Regional Water Quality Control Board (WQCB) Monitoring and Reporting Program. Samples were collected biweekly for the first two months of the demonstration and monthly thereafter. The permit obtained under the WQCB monitoring program required more frequent and extensive sampling than was scheduled in the workplan.

The activity and sampling schedule is presented in Table 9.

Sample Collection

The primary contaminants of concern during this demonstration were MTBE and the MTBE degradation by-product, TBA. Samples from select wells in the Control Plot (GWC-1 and 6) and in the Test Plot (GWT-1, 3, 9, and 15) were analyzed for MTBE, TBA, heterotrophs and propanotrophs, and a set of geochemical parameters at every sampling event following bioaugmentation. The geochemical parameters included dissolved propane and carbon dioxide, anions (bromide, chloride, nitrate, nitrite, sulfate and phosphate), total phosphate, ammonia, alkalinity, and oxygen demand parameters (TOC, COD and cBOD₅). Samples from all other Test and Control Plot wells were analyzed for MTBE, TBA, heterotrophs and propanotrophs at

every sampling event. Samples were analyzed according to the analytical methods listed in Table 8.

All of the above parameters were included in the Table 3 of the *Technology Demonstration Workplan* for this site. In addition, the WCQB required that the following parameters be measured on a regular basis: total suspended solids (TSS), total dissolved solids (TDS), and cations. TSS and TDS were measured in the field as described below; cations were measured according to the analytical method listed in Table 8.

Sample Collection

Soil samples were collected only during Site Characterization Confirmation sampling. Groundwater and vapor samples were collected at each sampling event listed in Table 9. In order to ensure that representative samples were obtained, groundwater samples were collected in accordance with USEPA Region I's "Low Stress (low flow) Purging and Sampling Procedure for the Collection of Groundwater Samples from Monitoring Wells". Due to the dense spacing of monitoring points in the well networks, well purging prior to sampling was limited to approximately 2.5 liters/well/event to minimize impacts on natural gradient flow patterns. The limited purge volume was necessary a modification of the USEPA Region I Method which was included in the *Technology Demonstration Workplan*.

Samples were obtained using a peristaltic pump and dedicated polyethylene and silicone tubing at each well. Groundwater elevation measurements were collected prior to the start of pumping and throughout the sample period using an electronic water level indicator. Measurements were obtained from the top-of-casing and recorded to the nearest 0.01-foot. Groundwater elevations were used to establish background hydraulic gradient and groundwater flow directions on the demonstration plots.

Groundwater samples were collected using low-flow peristaltic pumps connected to flow-through cells equipped with in-line monitoring instruments (YSI 6920 with Flow-Through Cell, Pine Environmental, Cranbury, NJ) to allow field measurements of geochemical conditions including redox potential (Eh), pH, dissolved oxygen (DO), specific conductivity (SC), total suspended solids (TSS), total dissolved solids (TDS), and temperature. Geochemical field indicator measurements were collected at 5-minute intervals during the purge period.

Following the purge period, the outlet of the peristaltic pump was disconnected from the flow-through cell and laboratory samples were collected. Samples were collected into bottles that were prepared at ENVIROGEN's Lawrenceville, NJ facility and shipped to the Site. The labels affixed to the bottles included the Site name, ENVIROGEN project number, Well ID, parameter, and preservative. Upon sample collection, the sample collector entered the date and time, and initialed each bottle. Chains of custody were prepared each day and were shipped with the samples via overnight delivery. Samples were wrapped to prevent breakage and were stored on ice upon collection. Samples were packed in coolers and were shipped overnight to

ENVIROGEN's Lawrenceville, NJ facility, where sample analysis was conducted within the hold-time of each sample. Cation analysis was performed by New Jersey Analytical Laboratories of Pennington, NJ.

Quality Assurance/Quality Control

This section describes the field quality control program that was used to measure and evaluate data quality associated with site sampling.

All field meters were calibrated once at the beginning of the day and were checked periodically throughout the day to determine if re-calibration was required. All non-dedicated and non-disposable materials and equipment were properly decontaminated between sample collection at each well.

Duplicate Samples. Field duplicate samples are separated into two categories: field split samples and collection duplicates. Each type of duplicate was collected and analyzed at a frequency of at least 5 percent of the total number of samples collected for that matrix and analysis. At least 20 percent of the duplicate samples were "blind duplicates", i.e., the laboratory did not know which samples were replicates of each other.

Field Split Samples. The first type of duplicate is a field split sample, obtained by collecting a sample and splitting it into two sub-samples and submitting each sub-sample to a different analytical laboratory for analysis. The purpose of splitting the sample is to check the performance of the laboratory. For water samples, field split samples were first be collected in a pre-cleaned 1-liter glass jar. The samples were then poured from the jar into the appropriate sample containers. Because some volatile chemicals may be lost during the splitting of the samples, field split samples were not used to assess quantitative VOC concentrations within the stream sampled, but to assess the performance of ENVIROGEN's laboratory. Split samples were analyzed by New Jersey Analytical Laboratories of Pennington, NJ.

Collection Duplicates. The second type of duplicate is a collection duplicate. This duplicate is obtained by collecting a second discrete sample from the same sample location and submitting both collections as discrete samples to the laboratory. The purpose of the collection duplicate is to assess the homogeneity of the contaminants in the matrix.

Blank Samples. Blanks are artificial samples designed to detect the introduction of contamination or other artifacts into the sampling, handling, and analytical process. Blanks are the primary QC check of measurements for trace-level concentrations and also for laboratory contamination.

Field Blanks. Field blanks were prepared to evaluate field conditions that may contribute to sample contamination and were analyzed for VOCs, including MTBE. These blanks are equivalent to obtaining a background reading at the sampling site. Field blanks were collected at

a sample location at the time of field sampling. The blank samples consisted of sample containers; identical to those designated for the field sample (40-mL amber glass vial), filled with laboratory-grade purified water. Field blanks will be prepared at a frequency of 5% of the total number of samples collected for that matrix and analysis.

Trip Blanks. Trip blanks were not collected on site, but were kept on site during sample collection. Trip blanks were prepared at ENVIROGEN's NJ facility using distilled water and the same containers to be used for collection of groundwater VOC samples. The blanks were shipped with the other sample containers to the Site in the sample coolers, were kept on site during sample collection, and were shipped along with the samples back to the analytical laboratory. Analyses of trip blanks was used indicate the presence of contamination from handling errors or cross-contamination during transport. Trip blanks were submitted at a frequency of one trip blank per cooler per shipment of groundwater samples for VOC analysis.

Pump Blanks. Pump blanks were used to assess the level of VOC contamination of sampling devices. Pump blanks were prepared by running 1 L of laboratory-grade purified water through the pump before sampling, and collecting the wash water for analysis according to the methods established for collection of the water samples. Equipment blanks will be prepared at a minimum of 5% of all soil and groundwater samples.

The results of QA/QC sample analysis were evaluated to ensure that the contaminants of concern detected in Test and Control Plot samples was not the result of poor collection practices, cross-contamination between wells, contamination during shipping, etc.

Soil-Gas Measurements

Field measurements of soil-gas were performed using a Gas Tech Flame Ionization Detector (FID) at each of the Test and Control Plot vapor monitoring points (VMPs) to determine the baseline total petroleum hydrocarbon concentrations. The results of the baseline soil-gas monitoring were used to assess potential stripping of groundwater VOCs and to evaluate accumulation of hydrocarbon vapors and propane in the unsaturated zone during the propane biosparging field demonstration.

Soil-gas samples were collected in 2-liter TedlarTM bags using a hand-held vacuum pump. A duplicate bag sample was collected at the VMP location that exhibited the highest FID reading for laboratory analysis of propane, MTBE, TBA, and BTEX. The soil-gas measurements were compared to the lower explosive limit (LEL) for propane, MTBE, and BTEX compounds. Based on field sampling and laboratory analysis, LELs were not exceeded at any time during pre-demonstration and demonstration activities. During pre-demonstration and demonstration activities, VOCs were measured in soil gas samples on two occasions at less than 75 ppmv VOCs as methane. These samples were collected on May 23, 2001 from VMPT-5, and on June 27, 2001 from VMPT-2. Laboratory analysis of these samples confirmed that on both occasions, MTBE and TBA concentrations were below 1.5 and 2 ppmv, respectively. BTEX was not

detected in these samples. Propane was detected in the VMPT-5 sample at 430 ppmv and in the VMPT-2 sample at 59 ppmv. These concentrations are well below 10% of the LEL for propane of 2,100 ppmv.

Ambient Air Quality Monitoring of Propane in Breathing Zone

Concentrations of VOCs and propane in the breathing zone were monitored during each sampling event using the FID meter in the same manner as described for soil-gas monitoring. Four breathing zone samples were collected during each monitoring events: a sample collected upwind of the demonstration plot, a downwind sample and two side-wind samples (i.e., one sample from either side of the demonstration plot). A laboratory confirmation sample was to be collected at the location that exhibited the highest FID reading. No readings above background were obtained from the FID for any of the breathing zone samples during pre-demonstration and demonstration activities. These monitoring data indicate that no fugitive emissions of VOCs or propane were present in the breathing zone.

3.5.9 DEMOBILIZATION

Demobilization activities were conducted during March of 2002 following the final sampling event. These activities were carried out by Base and ENVIROGEN personnel, and included disconnecting the distribution lines from the well-heads, removing the flow manifold, control panel, propane and oxygen tanks, pumps, and all miscellaneous materials and equipment. Site restoration was carried out by Base personnel.

3.6 SELECTION OF ANALYTICAL METHODS

All analytical methods used to monitor technology performance were either EPA- or ASTM-approved methods. All methods are listed in Table 8. Modifications to the methods are noted in this table.

PERFORMANCE ASSESSMENT

4.1 PERFORMANCE CRITERIA

The primary performance objective was to evaluate the capabilities of the propane biostimulation approach to treat MTBE contamination to acceptable end-point concentrations, based on State groundwater quality standards. Other specific performance criteria are included in Tables 10 and 11.

Table 10: Performance Criteria

Performance Criteria	Description	Primary or Secondary
Reduction in MTBE	MTBE concentrations reduced to < 5 µg/L in Test plot	Primary
Reduction in MTBE metabolites (e.g., TBA)	TBA concentrations reduced to < 12 µg/L in Test plot	Primary
Emission or accumulation of explosive gasses	No detectable propane in groundwater or air samples	Primary
Stimulate POB	Treatment enhances growth of POB	Primary
Safety	System operates safely including successful performance of system controls (emergency shut-off, etc.)	Primary
Reliability	System operates without continuous supervision	Primary
Ease of Use	System can be operated and maintained by field technicians	Primary
Factors affecting technology performance	Identify biogeochemical conditions that affect performance of the technology	Primary
Waste generation	Operation of the system generates minimal waste material	Secondary
Versatility	System can be adapted to treat other sites/contaminants	Secondary
Maintenance	System requires minimal maintenance	Primary
Scale-up constraints	System is suitable for scale-up to full-scale implementation	Primary

Table 11: Expected Performance and Performance Confirmation Methods

Performance Criteria	Expected Performance Metric	Performance Confirmation Method	Actual
Primary Performance Criteria			
Reduction in MTBE	MTBE concentrations reduced to < 5 µg/L in Test plot; compare Test plot to Control plot	Measure MTBE in Test and Control plot monitoring wells	Unsuccessful; MTBE concentrations exceeded 5 µg/L; MTBE concentrations in Test plot not lower than those in Control plot
Reduction in MTBE metabolites (e.g., TBA)	TBA concentrations reduced to < 12 µg/L in Test plot; compare Test plot to Control plot	Measure MTBE in Test and Control plot monitoring wells	Unsuccessful: TBA concentrations exceeded 12 µg/L; TBA concentrations in Test plot not lower than those in Control plot
Emission or accumulation of explosive gasses	No detectable propane in groundwater or air samples	Groundwater monitoring, above ground air sampling for VOCs.	Successful; GW propane levels near or below detection limit, no detectable VOCs in air samples
Stimulate/support POB	Treatment enhances growth of POB in Test plot	Plate count analysis of POB, compare Test and Control plots	Successful; POB numbers greater in Test Plot; MTBE-degrading POB isolated from Test plot but not Control plot
Safety	System operates safely including successful performance of system controls (emergency shut-	Monitor and record system operation	System performed as designed

	off, etc.)		
Reliability	System operates without continuous supervision	Monitor and record system operation	System performed as designed
Ease of Use	System can be operated and maintained by field technicians	Monitor and record system operation	System performed as designed
Factors affecting technology performance	Identify biogeochemical conditions that affect performance of the technology	Perform Microcosm testing; Monitor groundwater chemistry in Test and Control plots;	Microcosm testing revealed need to seed aquifer with POB
Maintenance	System requires minimal maintenance	Monitor and record system operation	System performed as designed
Scale-up constraints	System is suitable for scale-up to full-scale implementation	Monitor and record system operation and operation costs	Operational costs were low relative to alternative technologies
Secondary Criteria			
Waste generation	Operation of the system generates minimal waste material	Monitor and record system operation	Waste generation limited to sampling waste
Versatility	System can be adapted to treat other sites/contaminants	Monitor and record system operation	Unclear from demonstration results

4.2 DATA ANALYSIS, INTERPRETATION, AND EVALUATION

As described previously, the demonstration employed a Test Plot, with oxygen and propane injection and bioaugmentation, and a Control Plot, with oxygen injection only, to allow a direct comparison of degradation rates with and without propane and bioaugmentation. The propane and oxygen were injected into the saturated aquifer using sparging wells and pressurized gas systems. Oxygen and propane were intermittently sparged into the aquifer using separate oxygen and propane sparge points. A network of dual-level monitoring wells, shallow and deep, were installed downgradient of the gas injection points to allow measurement of contaminant concentration trends and biogeochemical parameters during the demonstration. In addition, soil-gas sampling probes were installed in both plots for air quality monitoring to evaluate potential accumulation of explosive vapors in the subsurface and fugitive emissions to the atmosphere.

After system startup (i.e., oxygen, propane and bacterial injections) groundwater samples were collected from both plots on a bi-weekly basis during the first two months and monthly thereafter for a period of eight months. During each groundwater sampling event, all monitoring wells, shallow and deep, were sampled for MTBE and TBA and geochemical parameters (pH, temperature, dissolved oxygen, specific conductivity, and oxidation reduction potential). Selected wells were sampled for ammonia nitrogen, total phosphate, total organic carbon, chemical oxygen demand, carbonaceous biological oxygen demand, alkalinity, anions (including nitrate, phosphate, and sulfate) microbial populations, and dissolved carbon dioxide and propane. Additional analysis required by the California Water Quality Control Board but not included in the Work Plan included cations (barium, calcium, magnesium, manganese, potassium, and sodium), total suspended solids and total dissolved solids. The field and analytical results from the performance monitoring are discussed below.

4.2.1 HYDROGEOLOGY

As part of the hydrogeologic evaluation of conditions during the demonstration, depth to water (DTW) was measured in all monitoring wells during all sampling events. By averaging the deep and shallow DTW at each monitoring location, the groundwater surface elevations during each sampling event were mapped. Figures 13A through 14O are included in Appendices E and F. Figures 13A through 13O show the groundwater surface map beneath the Control Plot and Figures 14A through 14O show the groundwater surface map beneath the Test Plot. Groundwater gradients beneath the Test Plot were very shallow (0.0003 ft/ft) and generally sloped from the upgradient well towards the monitoring well network, though reverse slopes were also occasionally observed in this Plot (Figures 14A, 14C, 14D, 14K, and 14O). Groundwater gradients beneath the Control Plot were also relatively shallow (0.001 ft/ft) but consistently sloped from the upgradient well towards the monitoring well network. The groundwater velocity estimated using results from the U.S. EPA tracer test is 0.2 to 0.3 ft/day. Using an average hydraulic conductivity for this aquifer of 200 ft/day and a porosity of 0.35, over the duration of the demonstration, the average groundwater velocity in the Test Plot and Control Plot were 0.17 ft/day and 0.57 ft/day, respectively. Based upon these velocities, amendments injected upgradient of the monitoring well network should pass through the Test Plot after approximately 5 months, and through the Control Plot after 1.5 months. These travel times, however, must be viewed only as estimates because the groundwater elevations were not measured continuously, but rather only during our scheduled sampling events. However, even assuming reasonable variability in the rates, the travel times were longer than the design travel time for the demonstration but were sufficient to promote MTBE biodegradation in the aquifer (see Section 4.3 below).

4.2.2 GEOCHEMISTRY

The geochemical parameters pH, DO, ORP, temperature, and specific conductivity were measured during this demonstration. Groundwater samples were collected using the low-flow,

low-stress method while using a flow through cell. These field data were used to assess changes in groundwater conditions and to evaluate their influence on biodegradation.

4.2.1.1 Test Plot

Geochemical conditions in the Test Plot did not change significantly over the duration of the demonstration. The pH prior to system startup was approximately 7 and remained in the neutral range throughout the study. Similarly, measured temperature, ORP, and specific conductivity values remained relatively constant in both the shallow and deep wells in this plot. Total dissolved solids (TDS) measured in shallow and deep monitoring wells ranged between 1.5 and 2 g/L. These values are similar to TDS values measured in the upgradient wells (GWT1S and GWT1D, respectively). Finally, dissolved oxygen levels in the Test Plot were generally higher than in the background well (See Table 7 and Figure 15) indicating that aerobic conditions were successfully maintained in the aquifer throughout the demonstration. Based upon results from the field-measured geochemical parameters in the Test Plot, little or no change other than DO concentrations was observed in the aquifer due to demonstration activities, including oxygen and propane addition, and seed culture injection.

4.2.1.2 Control Plot

Geochemical conditions in the Control Plot did not change significantly over the duration of the demonstration. The pH prior to system startup was approximately 7 and remained within that range throughout the study. Similarly, measured temperature, ORP, and specific conductivity values remained relatively constant in both the shallow and deep wells in this plot. As with the Test Plot, total dissolved solids (TDS) measured in shallow and deep monitoring wells ranged between 1.5 and 2 g/L. These values are similar to TDS values measured in the upgradient wells (GWC1S and GWC1D, respectively). Finally, dissolved oxygen levels in the Control Plot were generally higher than the background well (See Table 7 and Figure 16), indicating that aerobic conditions were maintained in the aquifer throughout the demonstration. Based upon results from the field-measured geochemical parameters in the Control Plot, little or no change other than DO concentrations was observed in the aquifer due to demonstration activities.

4.2.3 MTBE/TBA

All monitoring wells, both shallow and deep, were sampled for MTBE and TBA during 15 sampling events conducted in this demonstration. The first three sampling events were conducted prior to bioaugmentation to obtain baseline conditions at the Site. Subsequent sampling events involved collecting groundwater samples from wells upgradient of the demonstration plots (to assess levels of contamination entering the bioreactive zones) and within the monitoring well network to evaluate the MTBE and TBA levels leaving the propane biosparging zone. Measured MTBE and TBA concentrations from all sampling events are presented in Tables 3 and 4, respectively. MTBE concentrations are also presented in Figures 17 and 18.

Figure 15. Dissolved Oxygen Concentrations in Test Plot Monitoring Wells

MTBE Demonstration Project
ESTCP
Port Hueneme, CA
Envirogen Project No. 92132

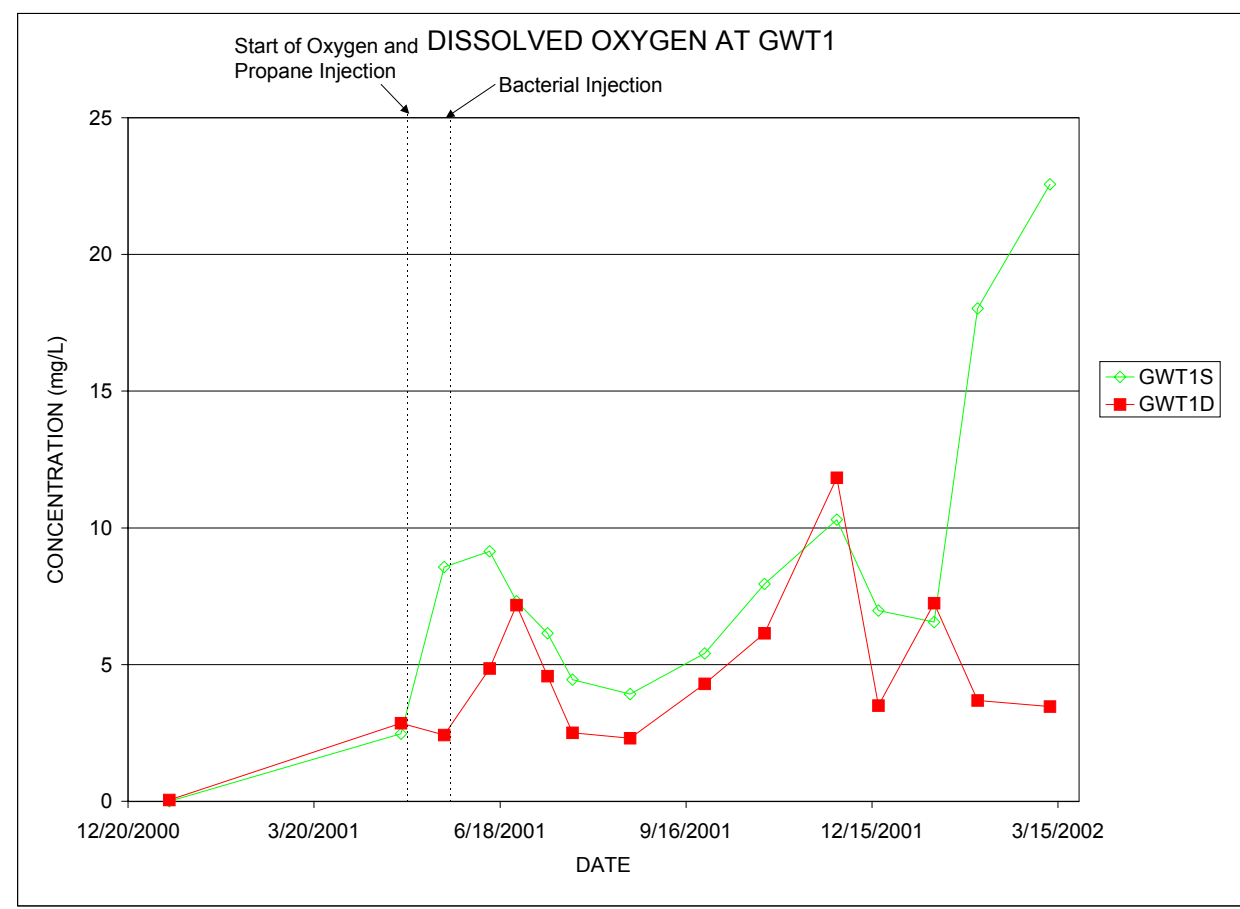

O O B P O B P O

Oxygen Injection Points
Bacterial Injection Points
Propane Injection Points

O B P O B P O

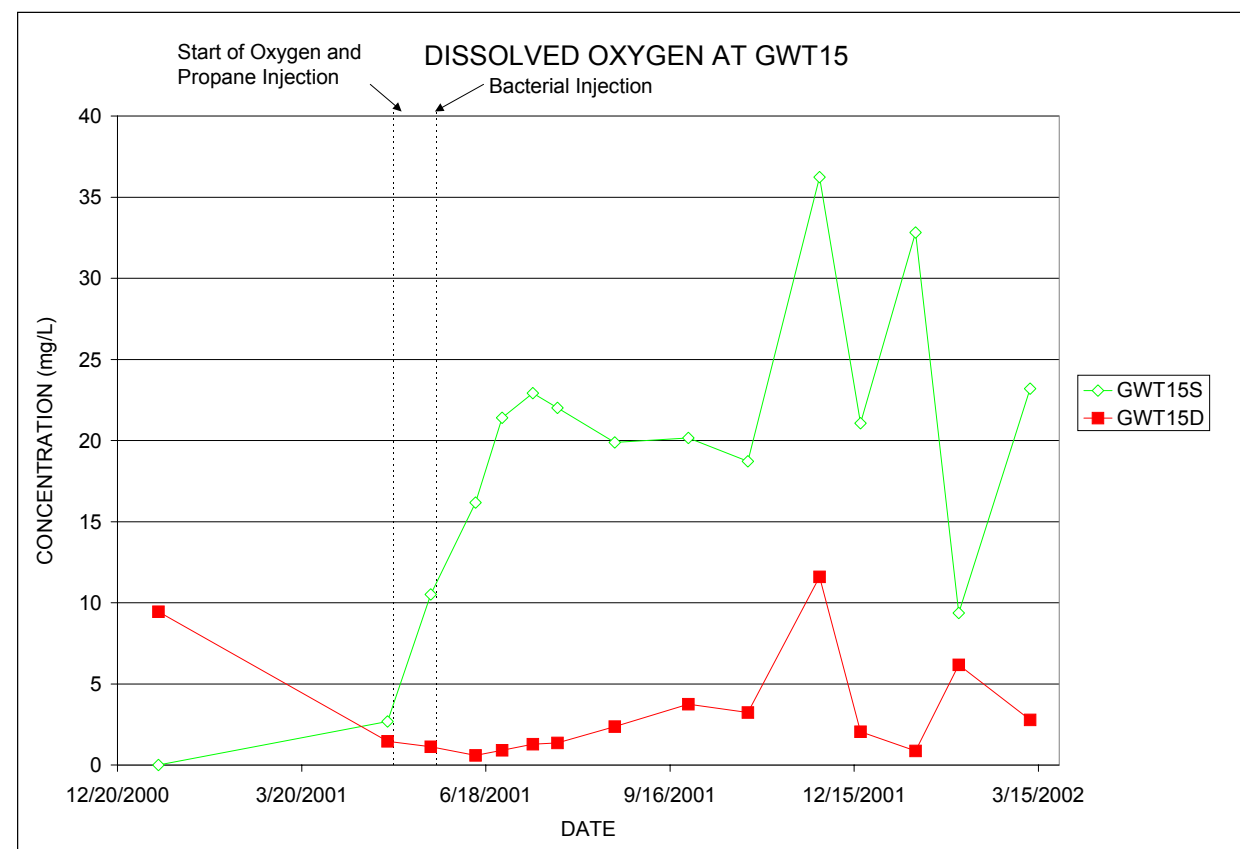
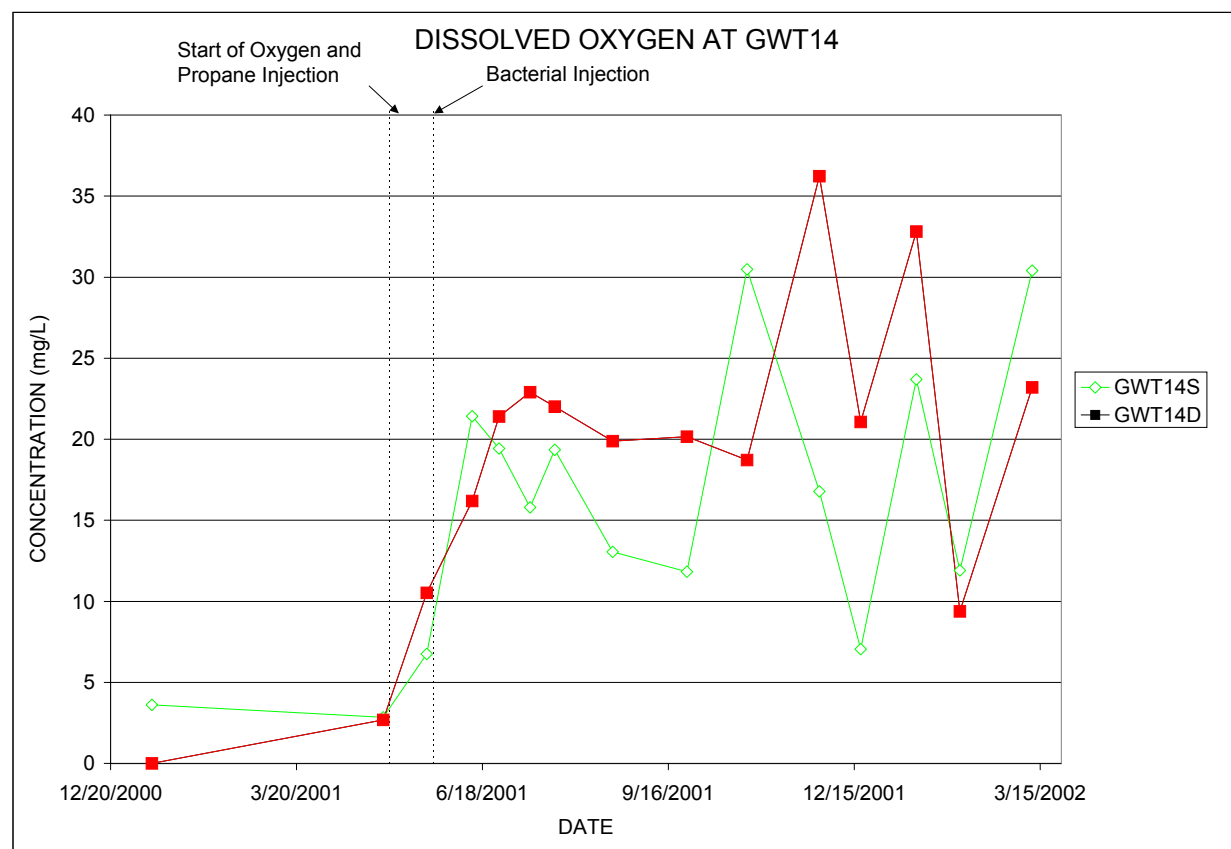
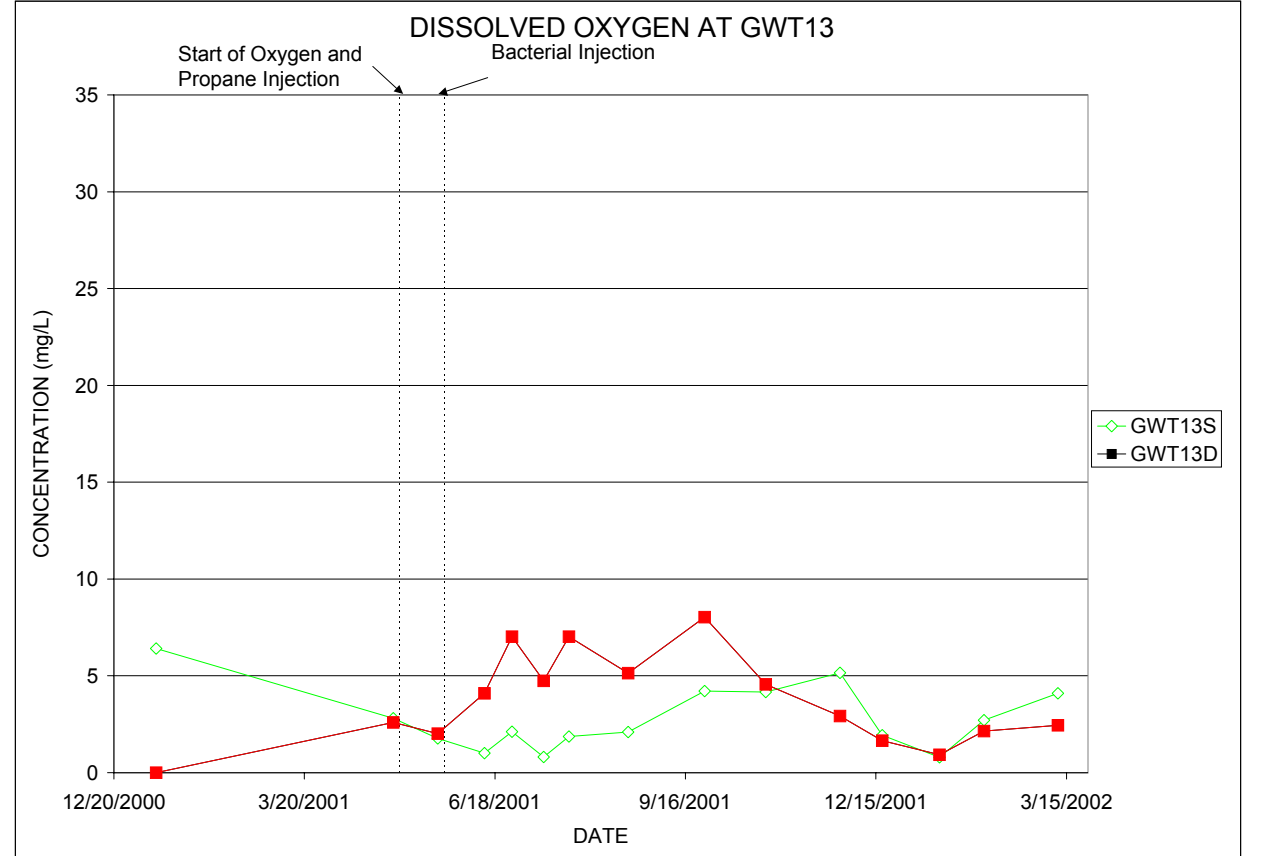
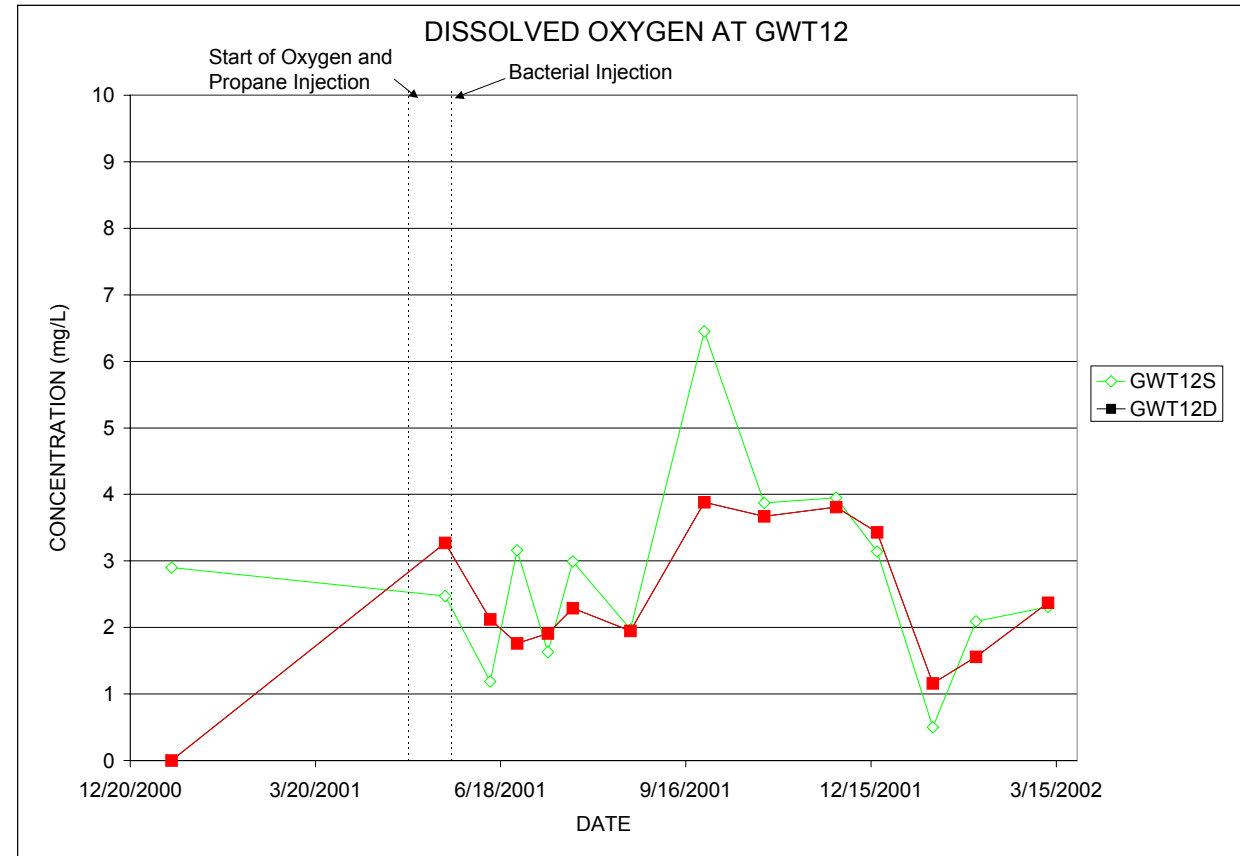
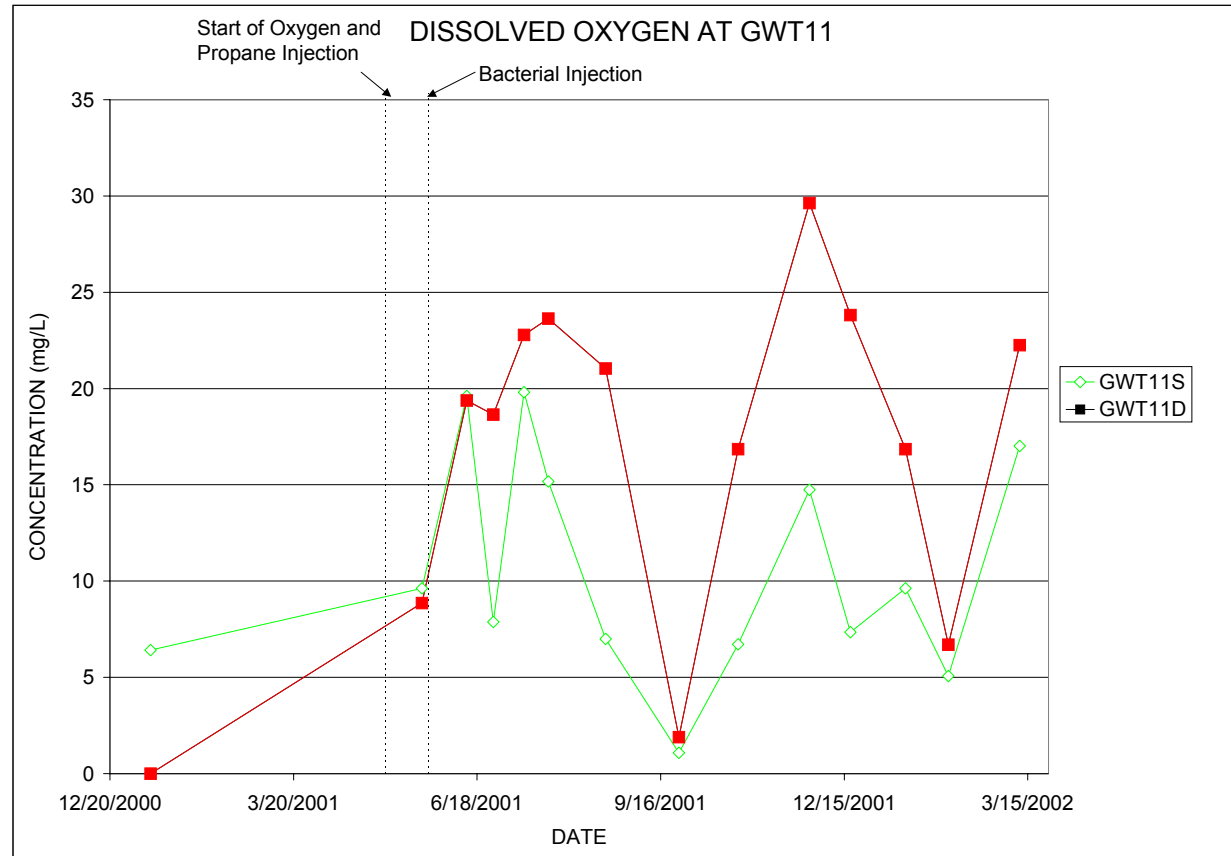
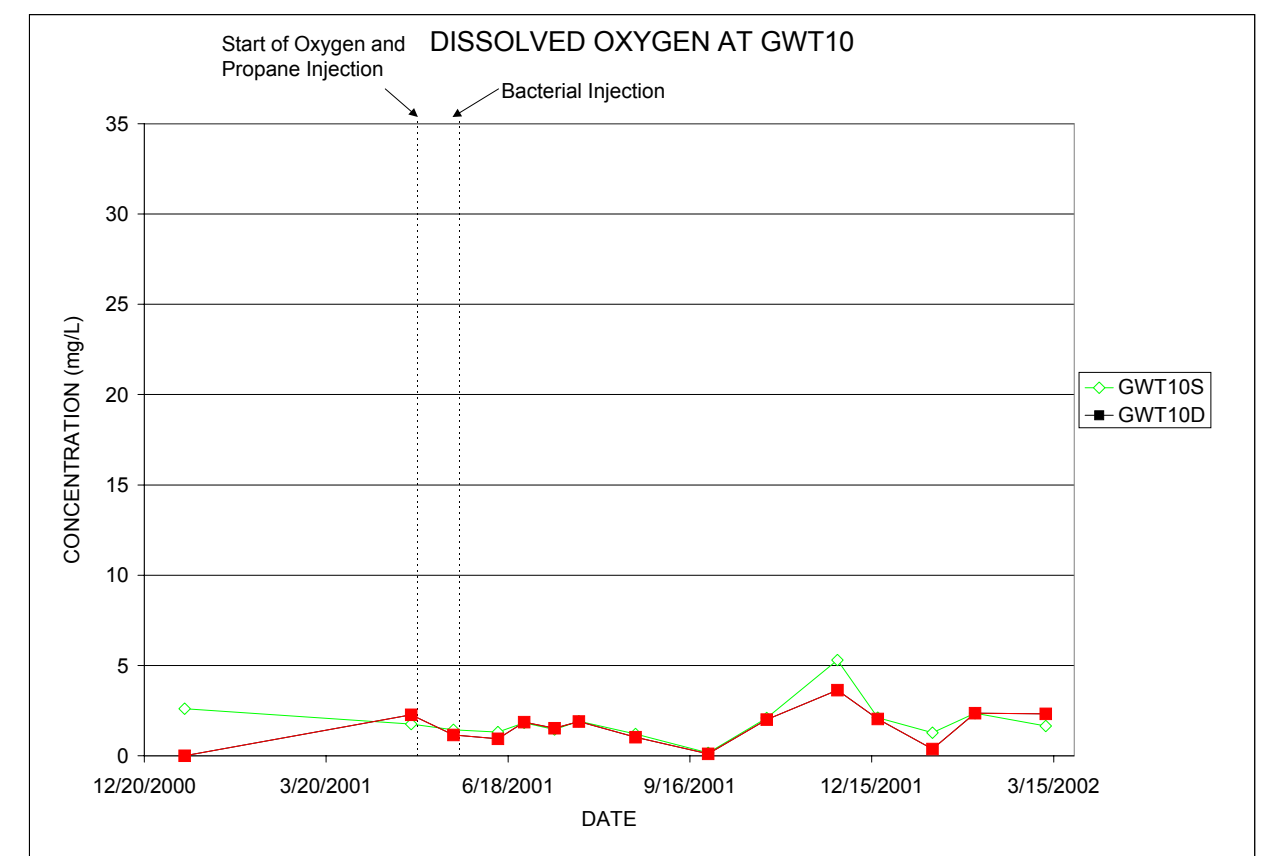
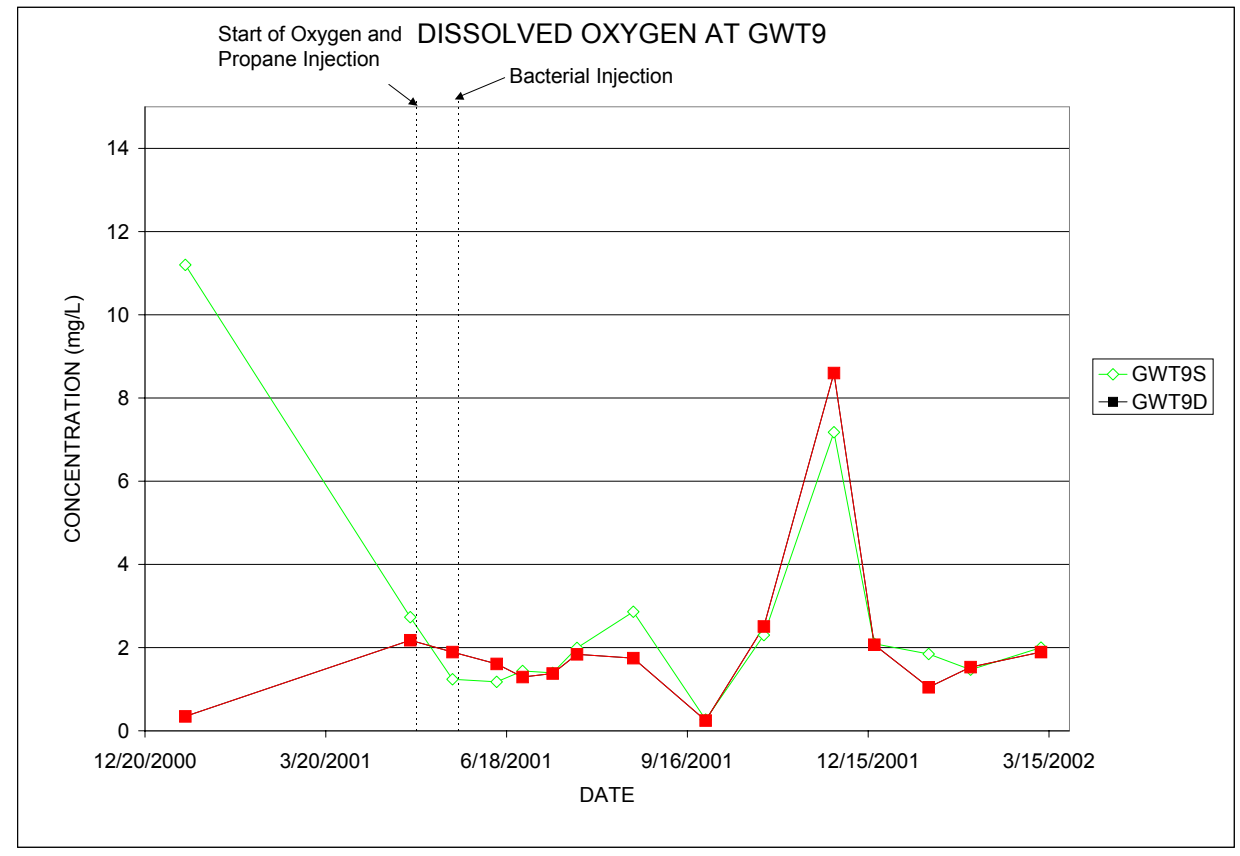
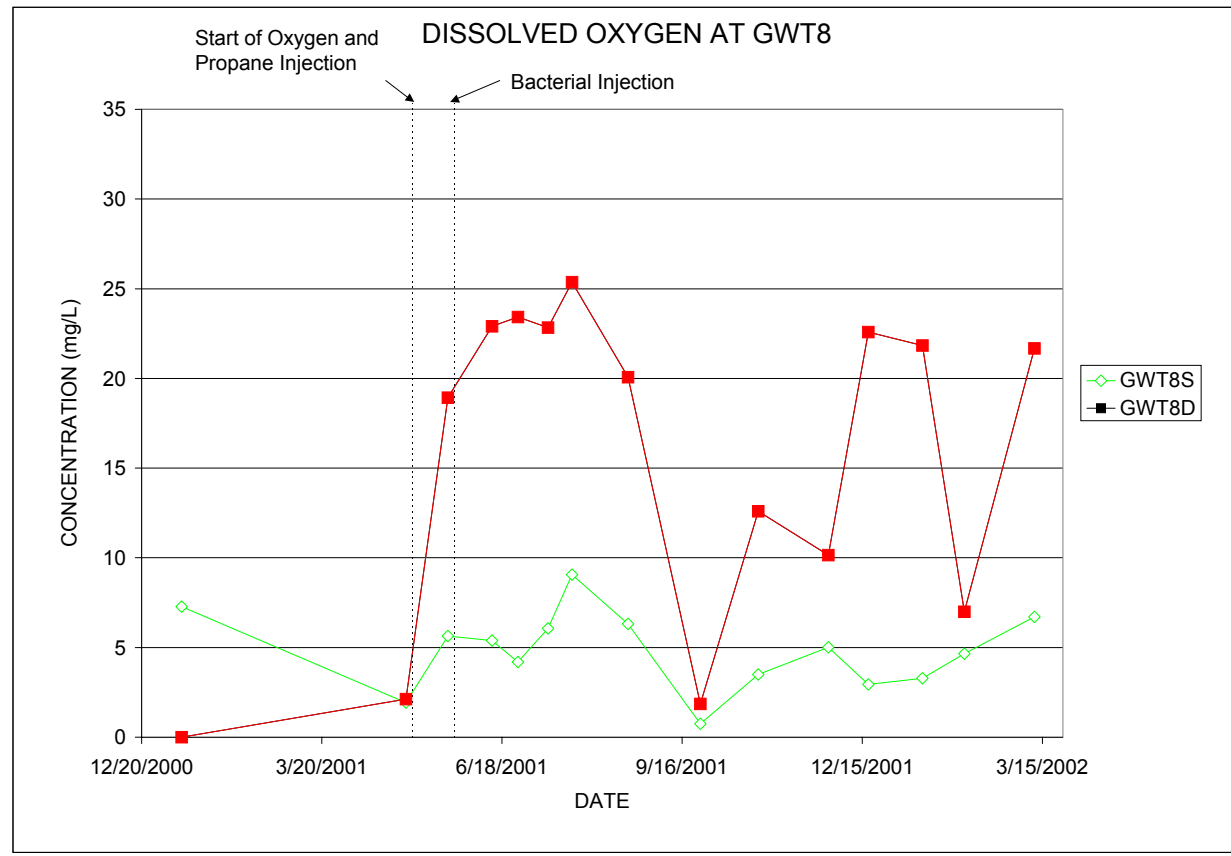
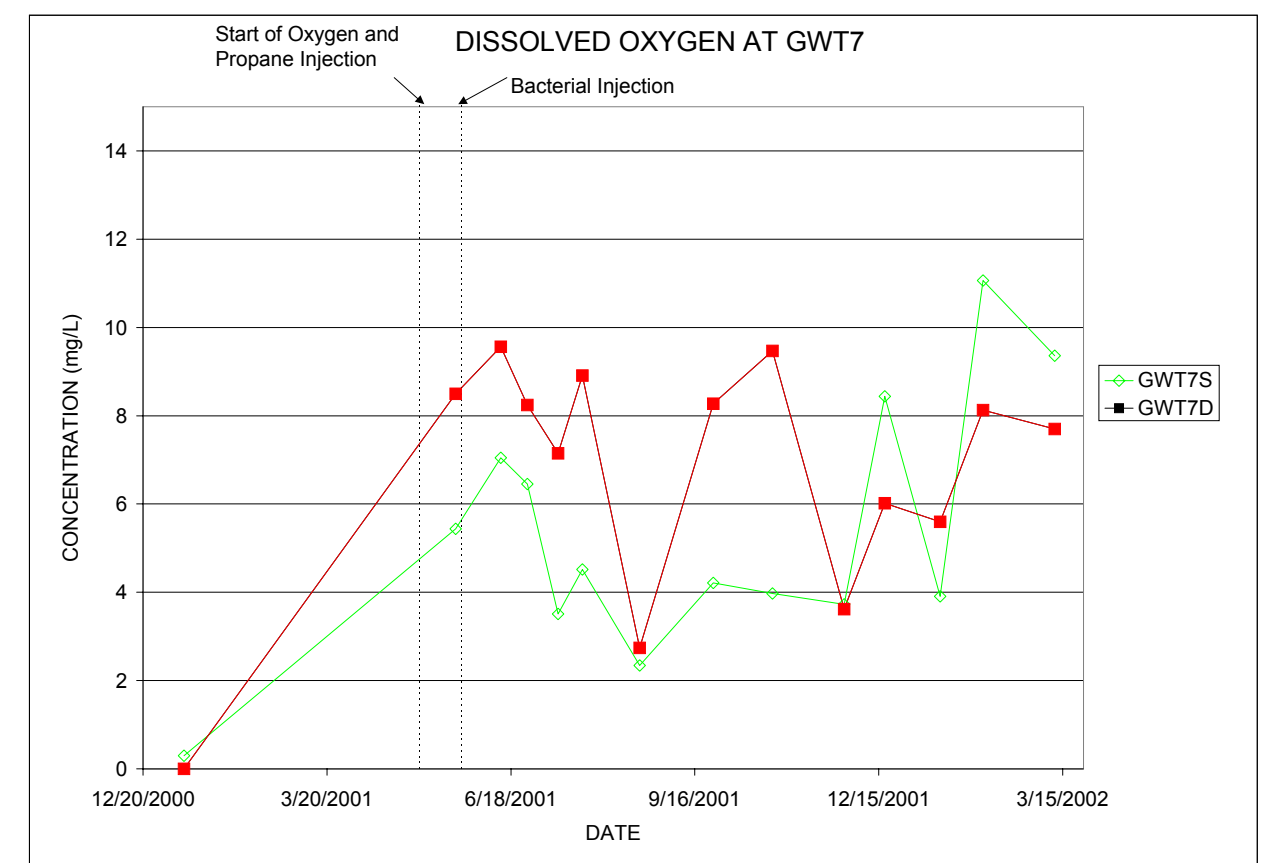
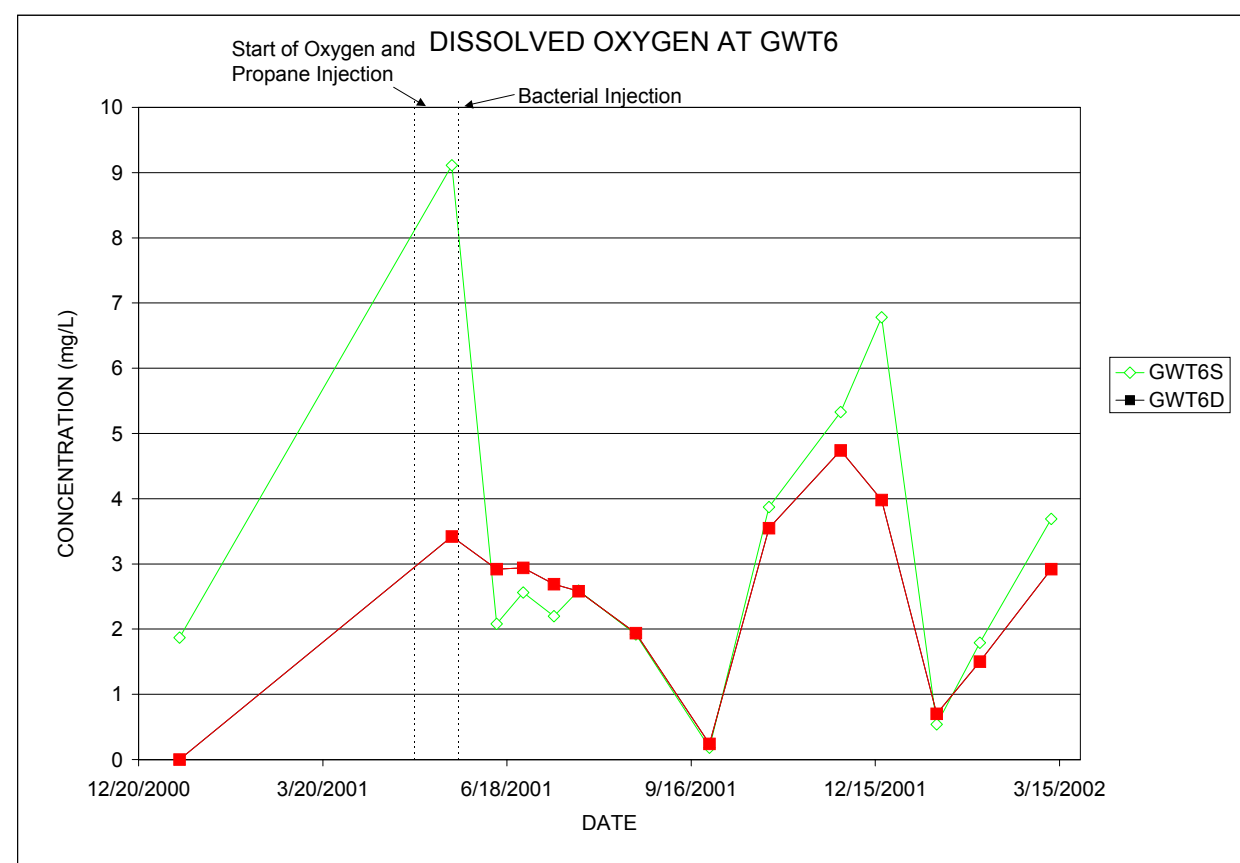
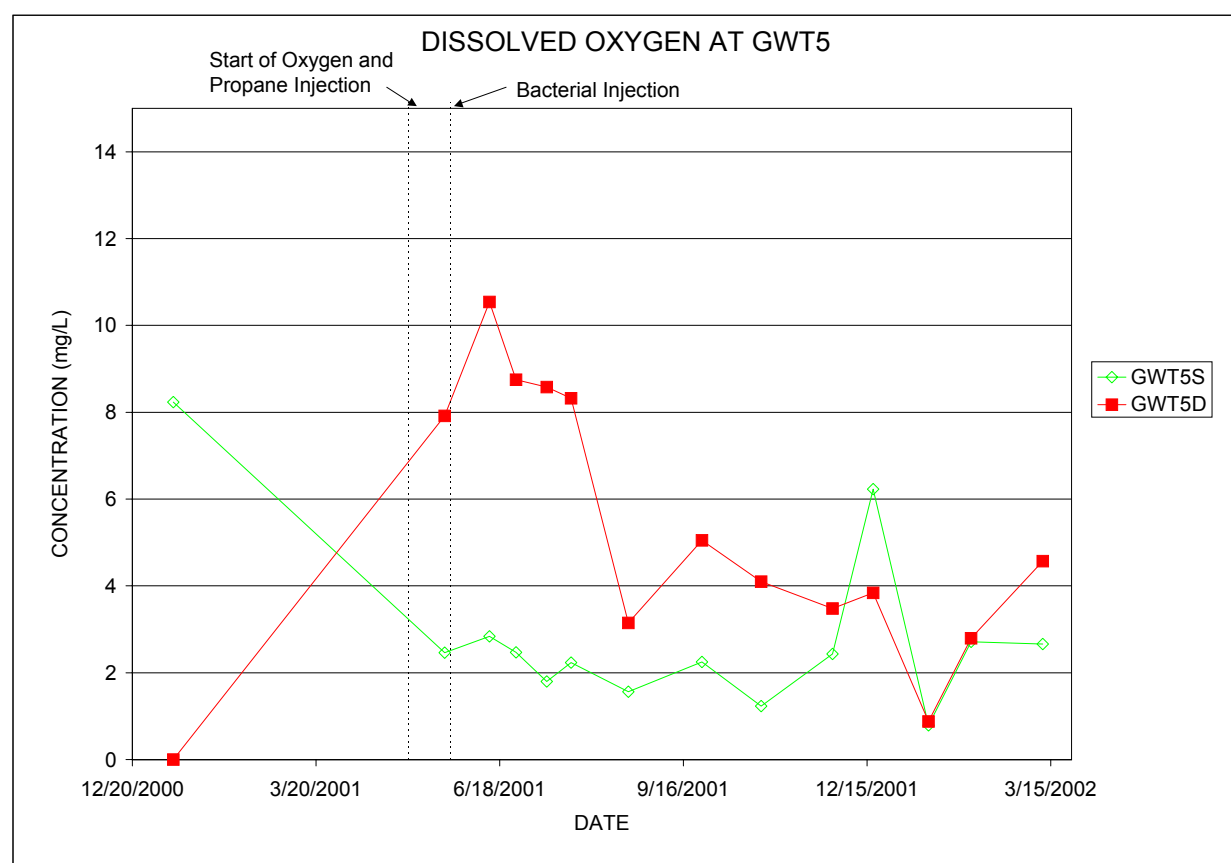
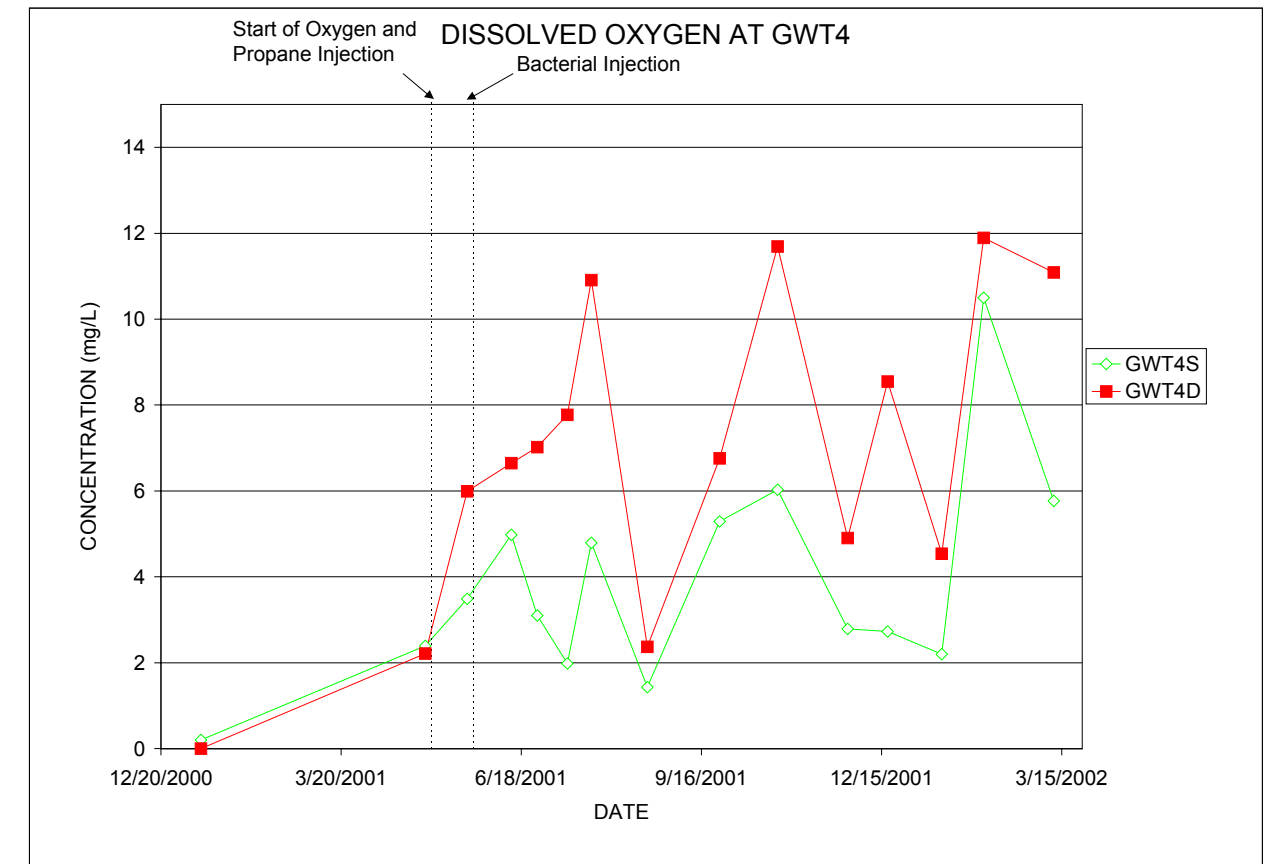
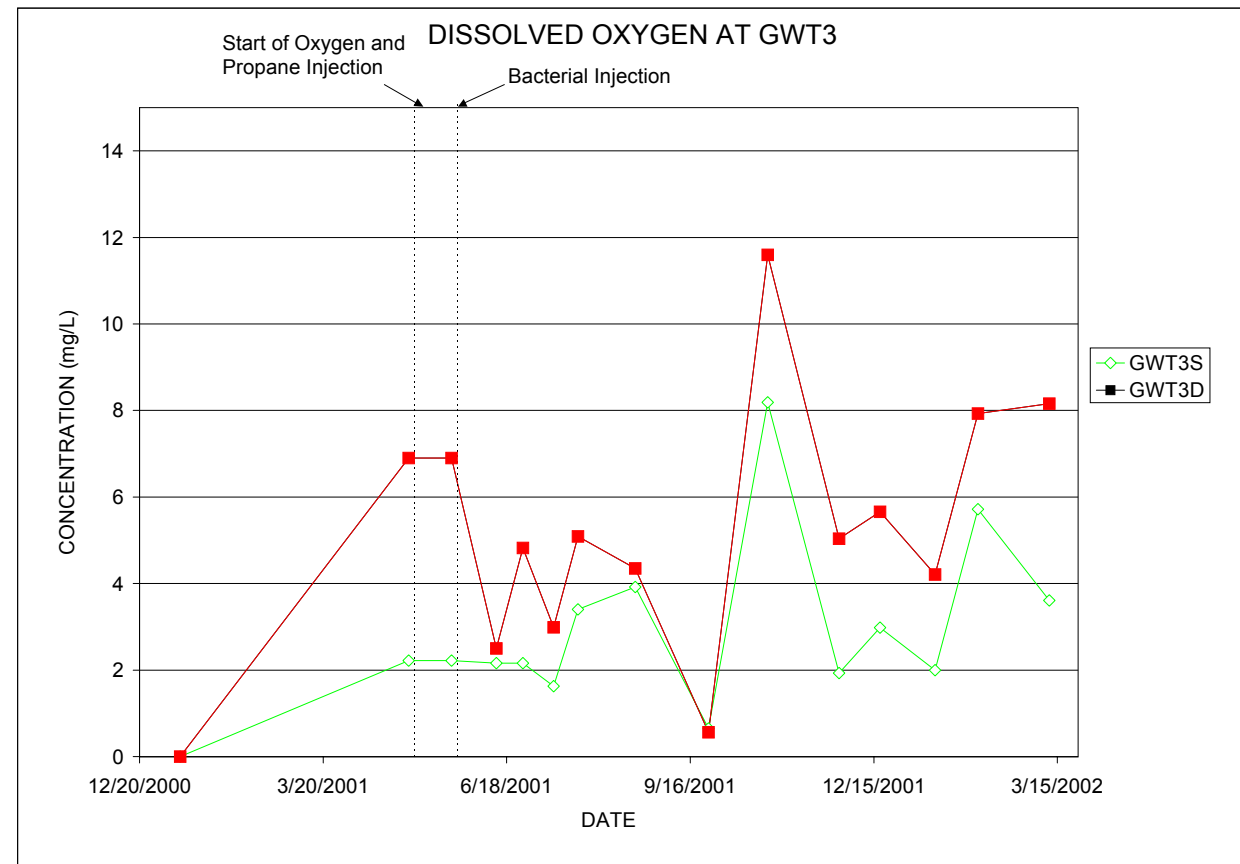
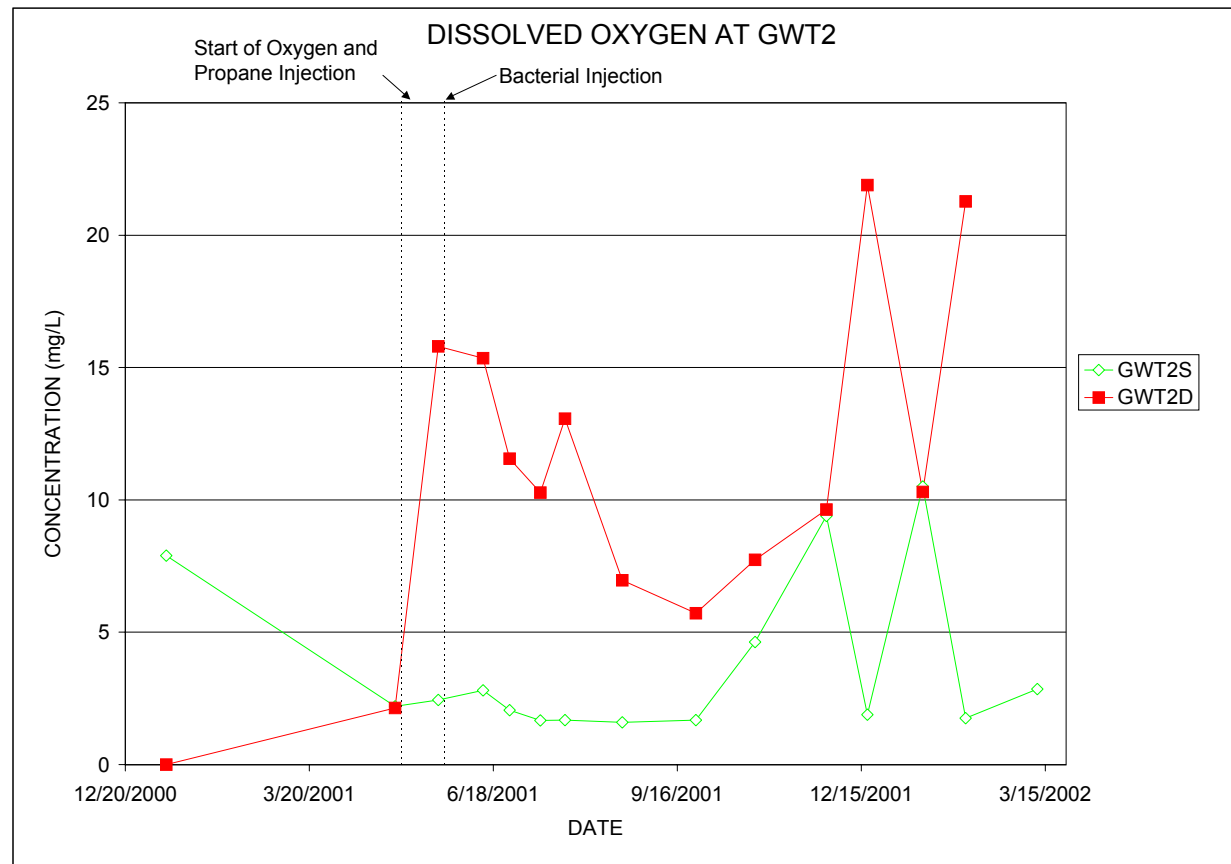
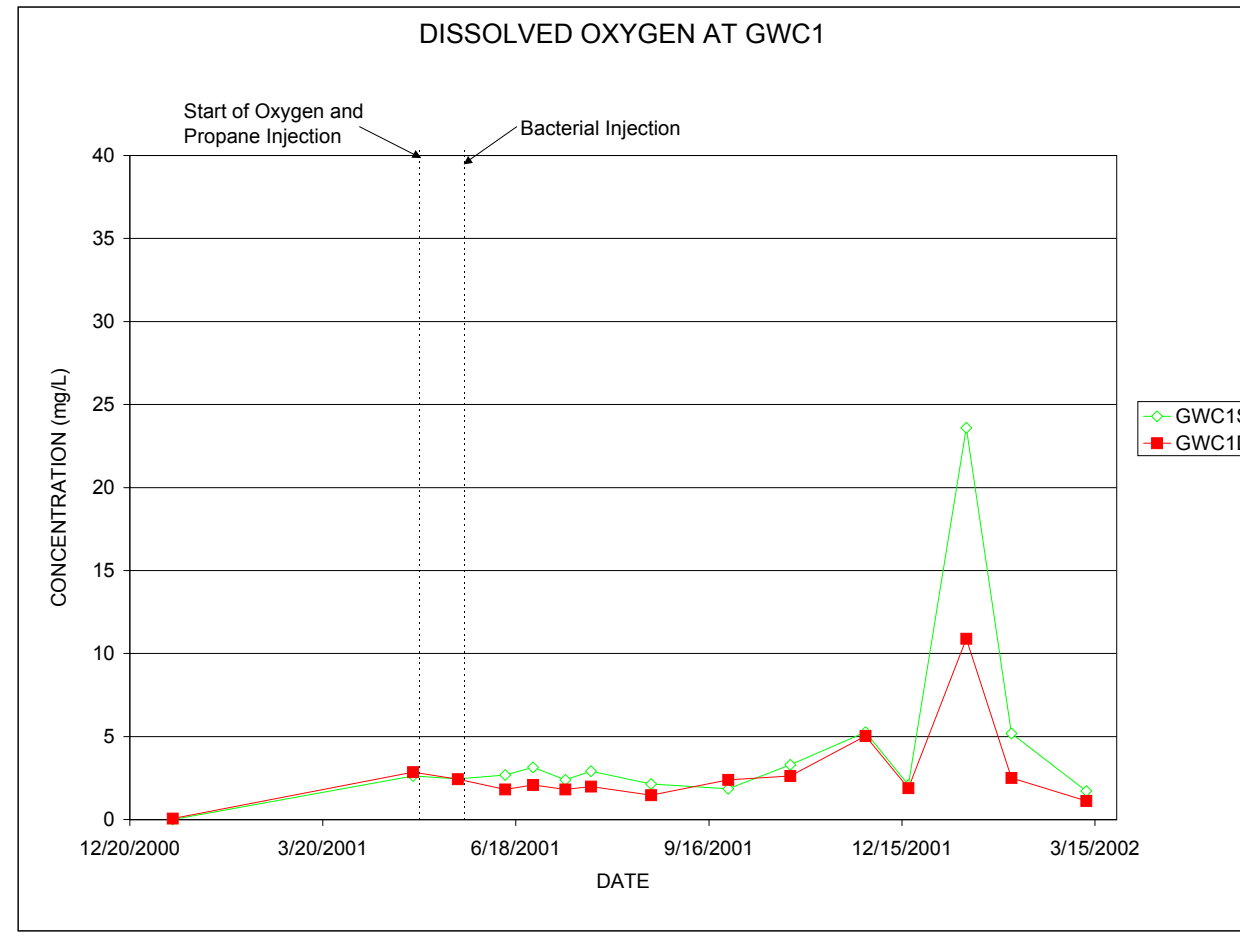

Figure 16. Dissolved Oxygen Concentrations in Control Plot Monitoring Wells

MTBE Demonstration Project
ESTCP
Port Hueneme, CA
Erwiogen Project No. 92132



Oxygen Injection Points

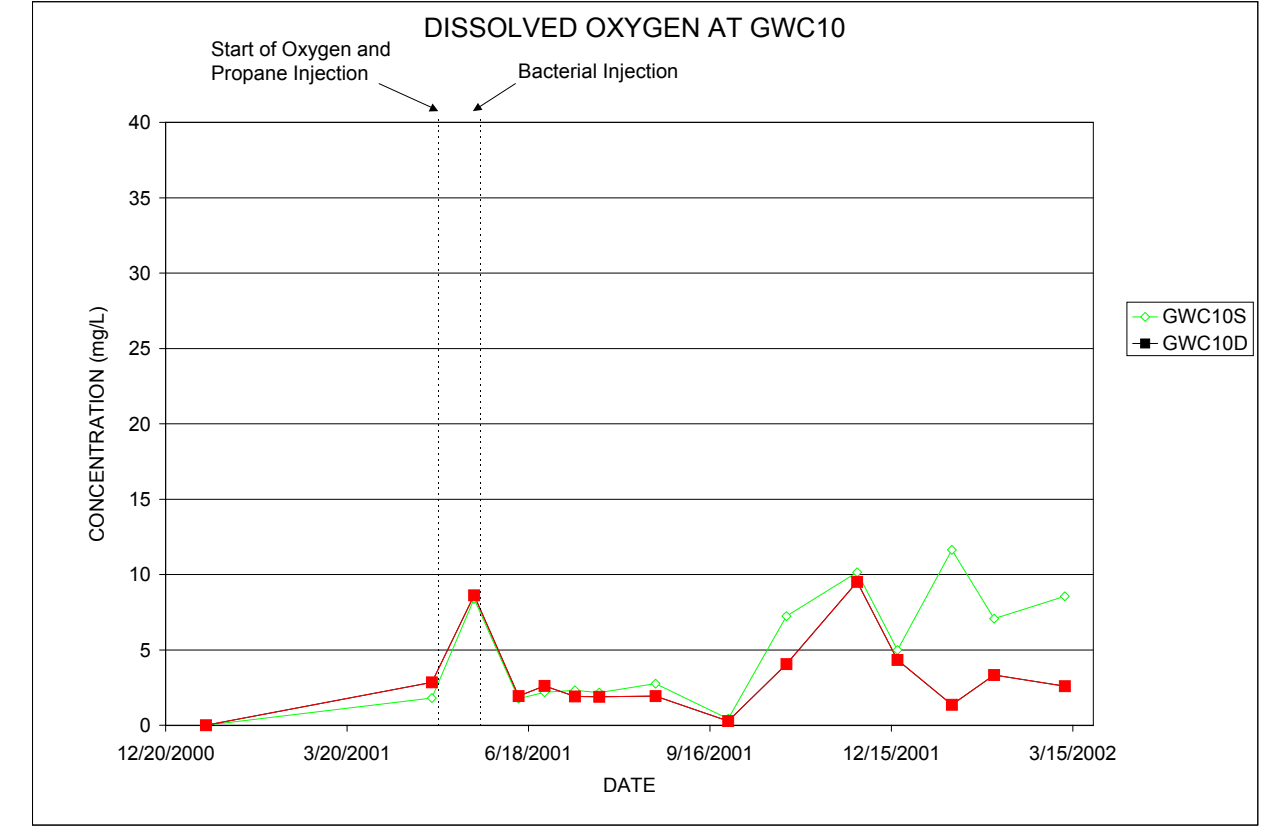
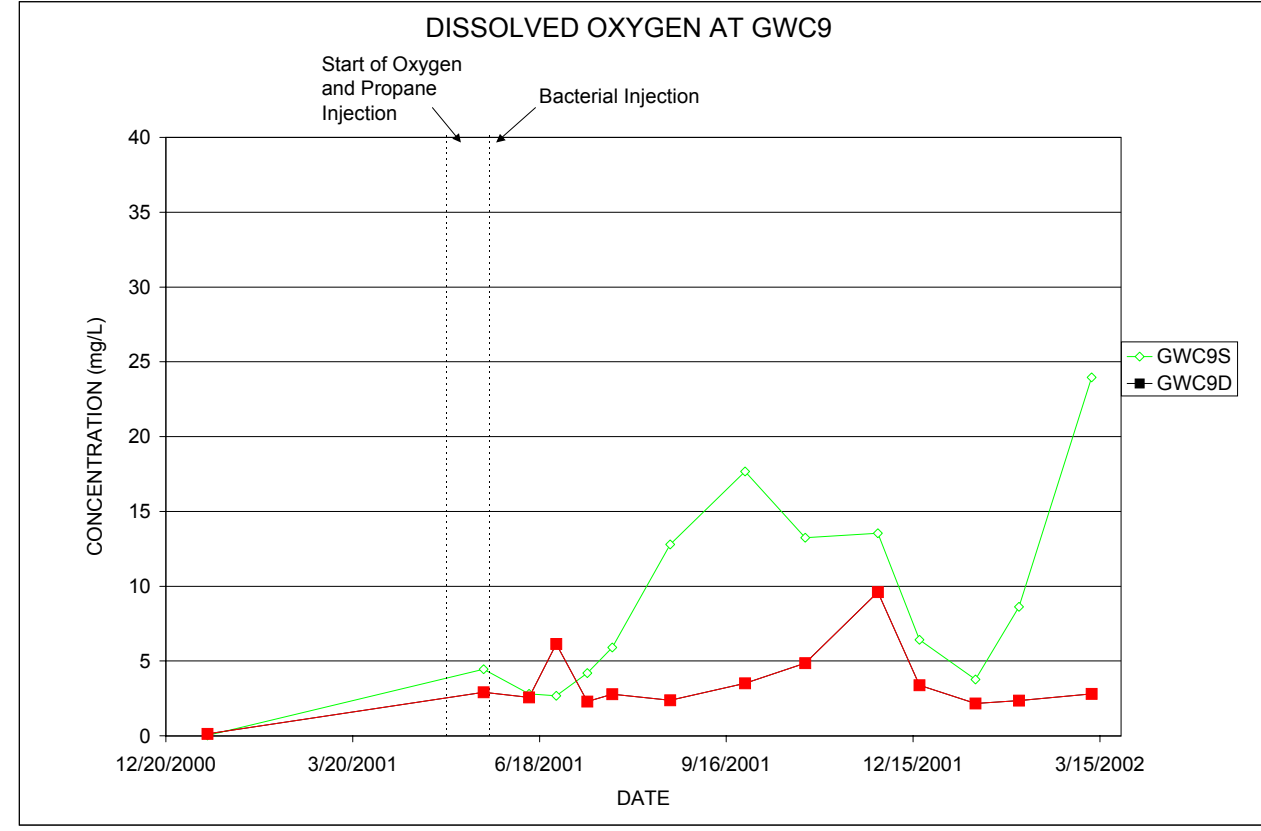
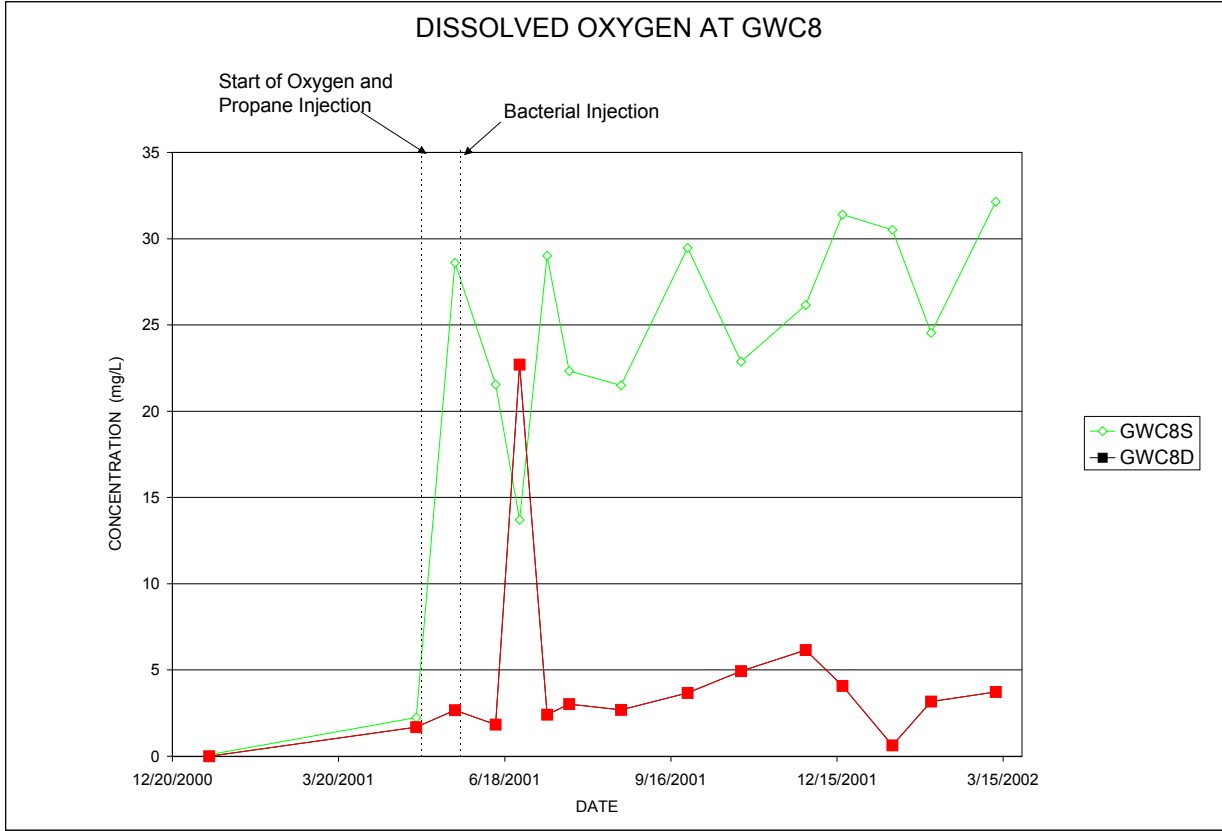
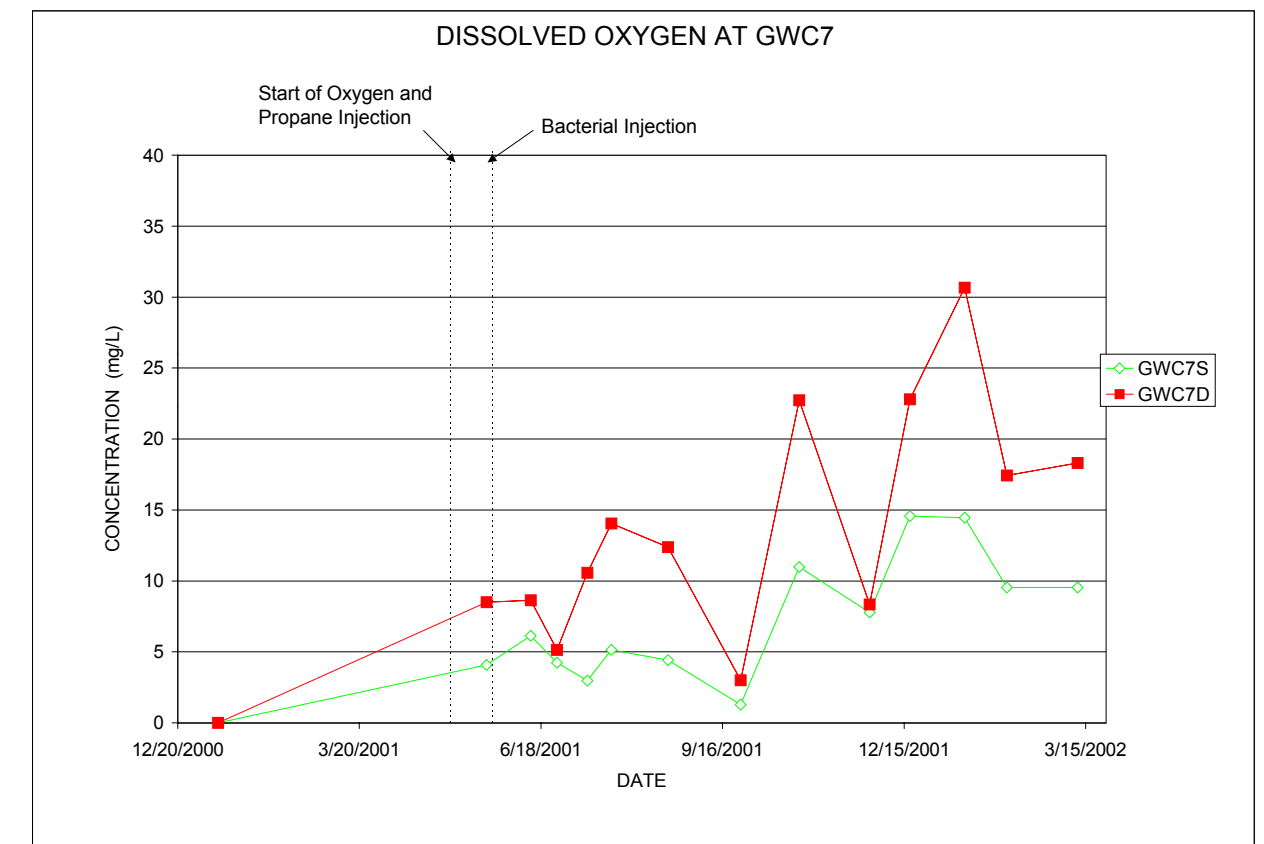
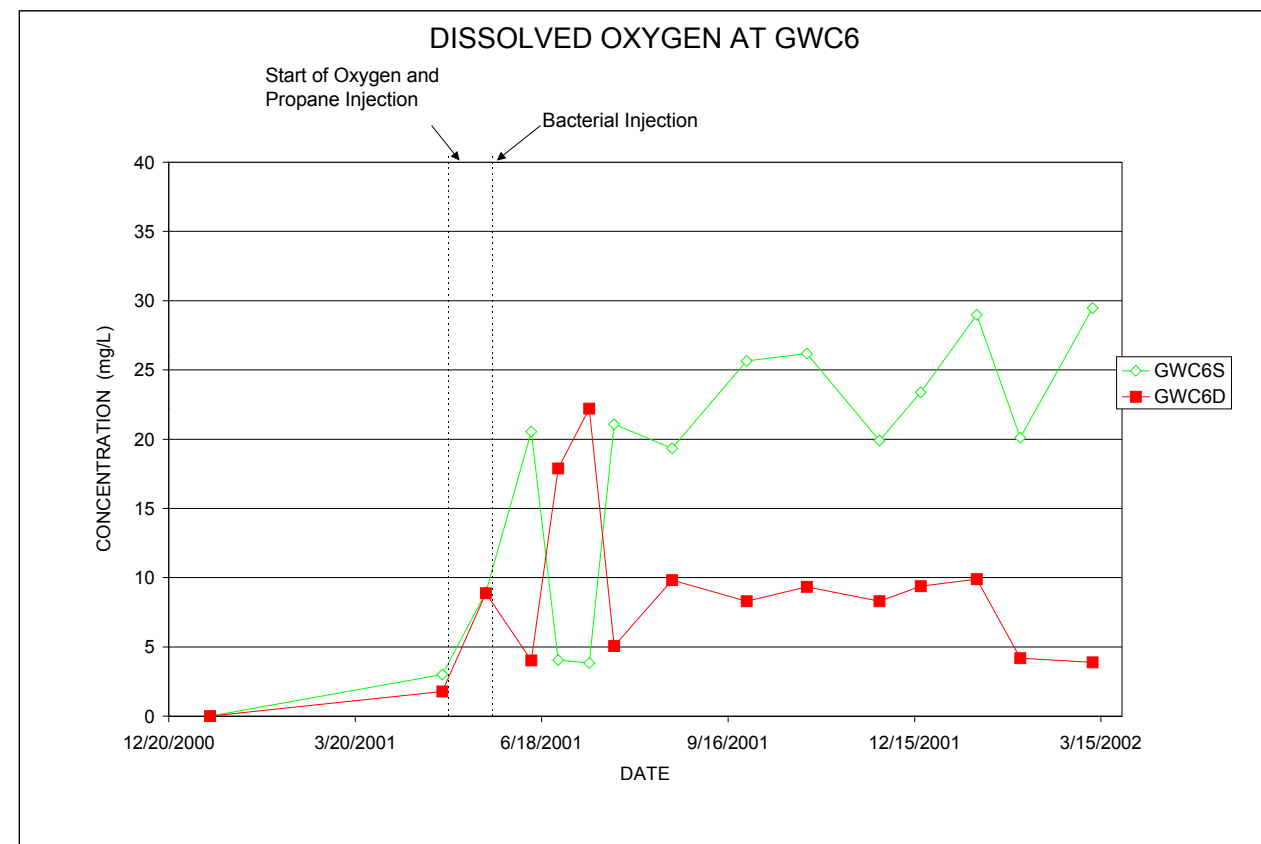
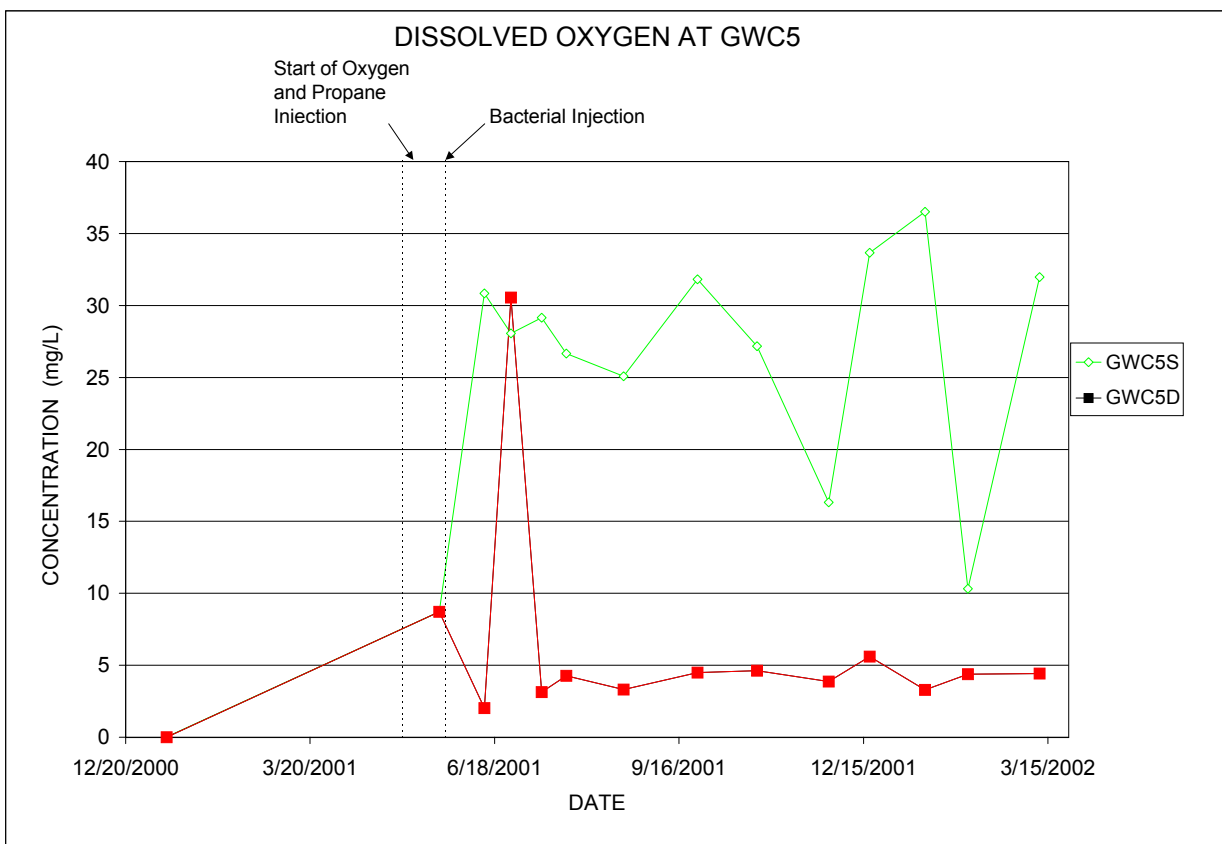
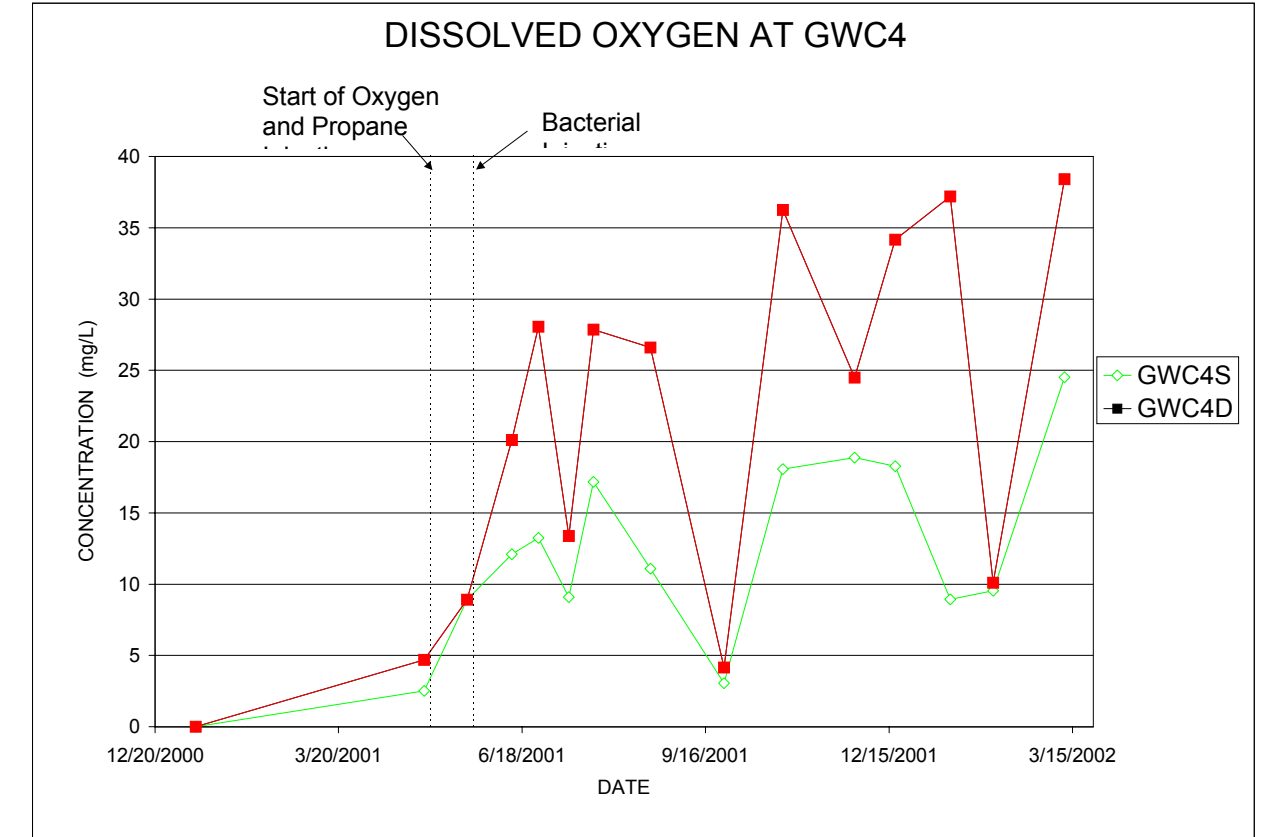
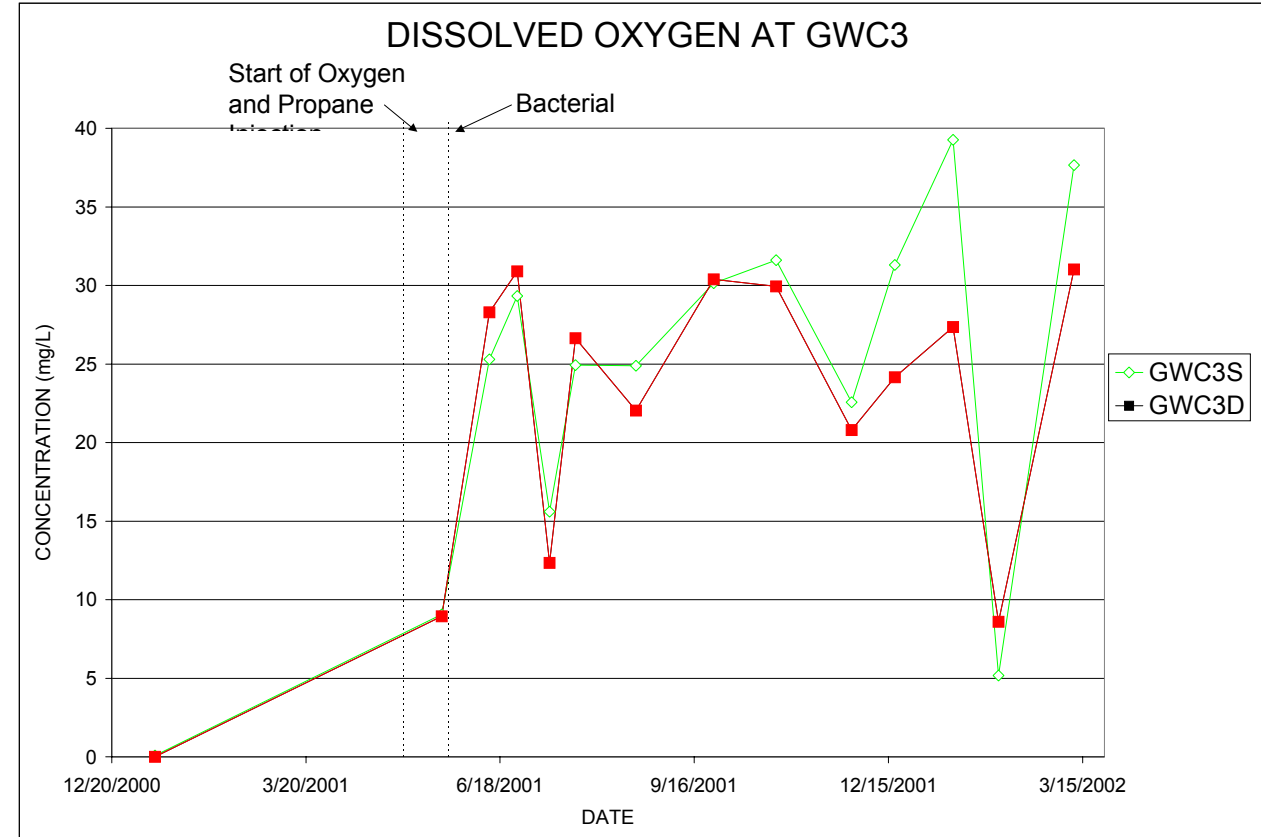
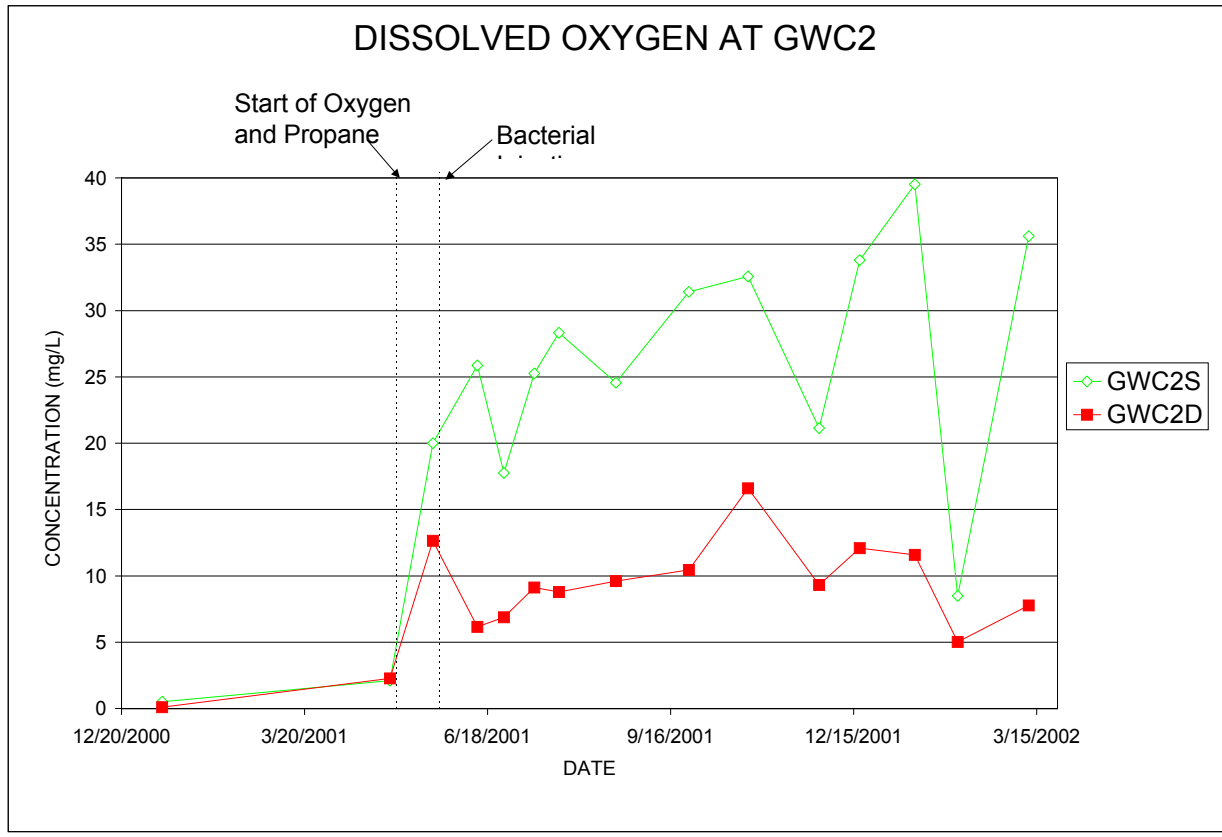
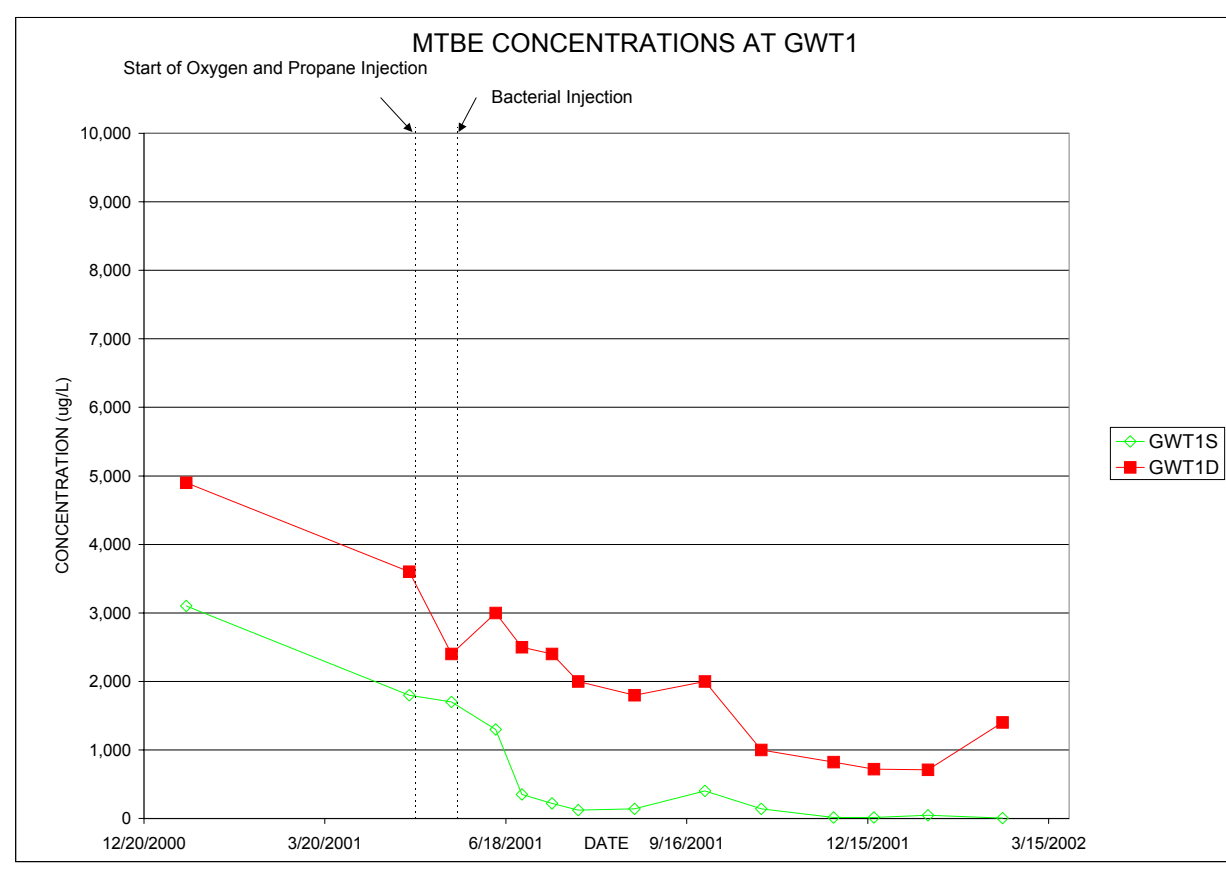

Figure 17. MTBE Concentrations in Test Plot Monitoring Wells

MTBE Demonstration Project
ESTCP
Port Hueneme, CA
Envirogen Project No. 92132



O B P O B P O B P O

Oxygen Injection Points
Bacterial Injection Points
Propane Injection Points

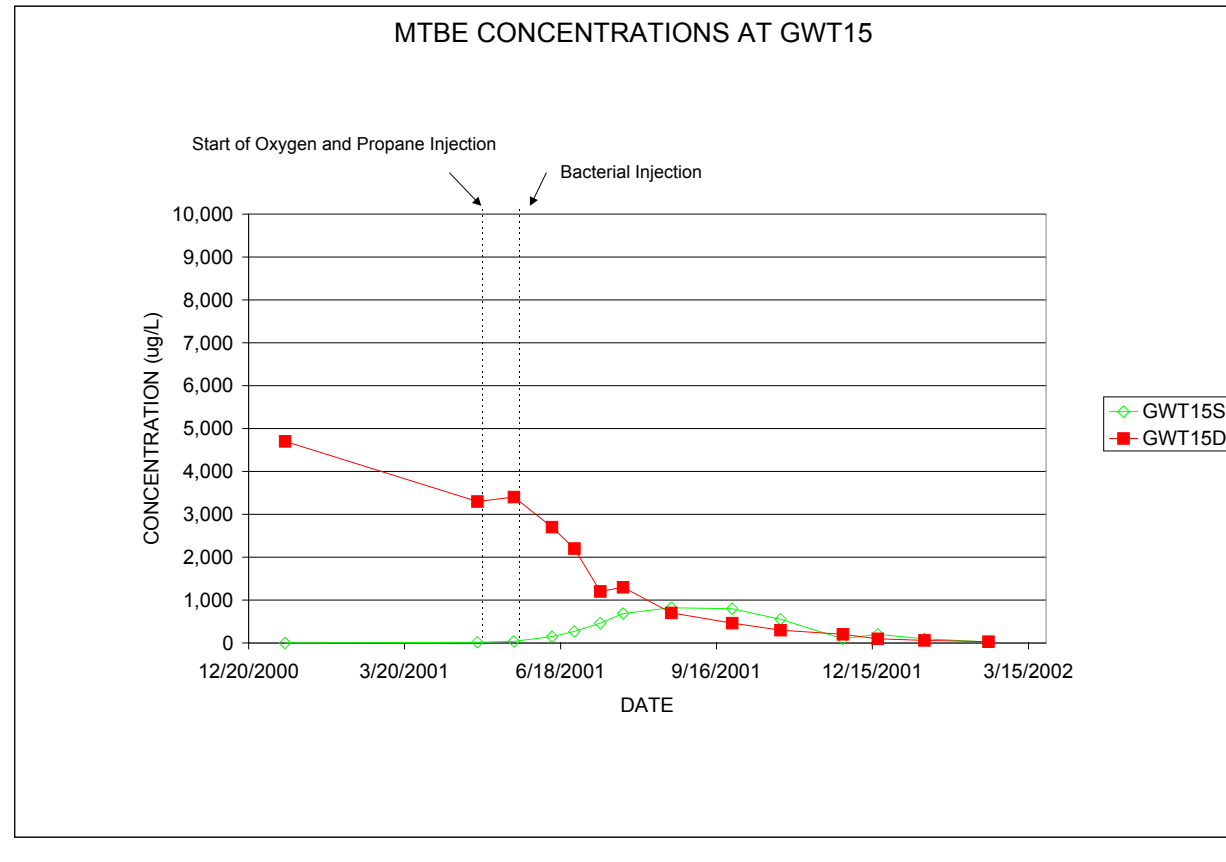
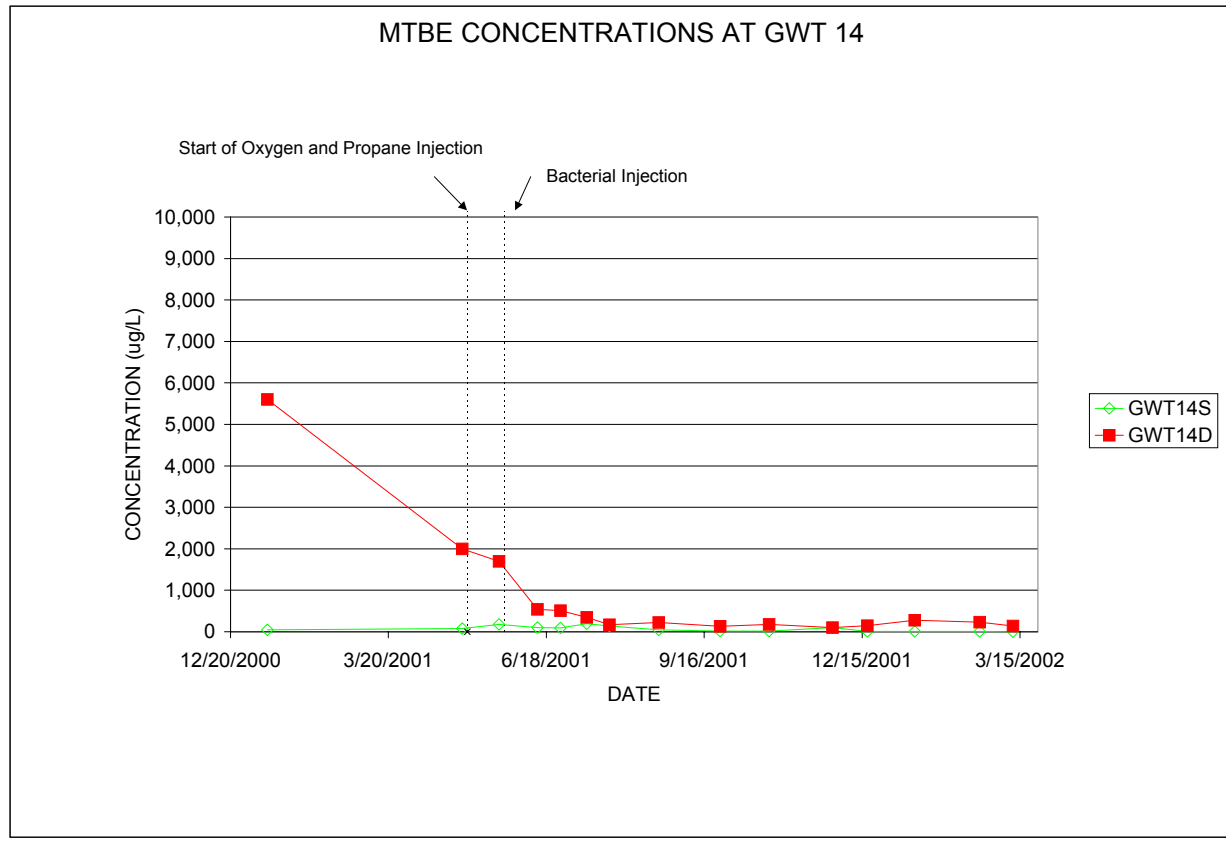
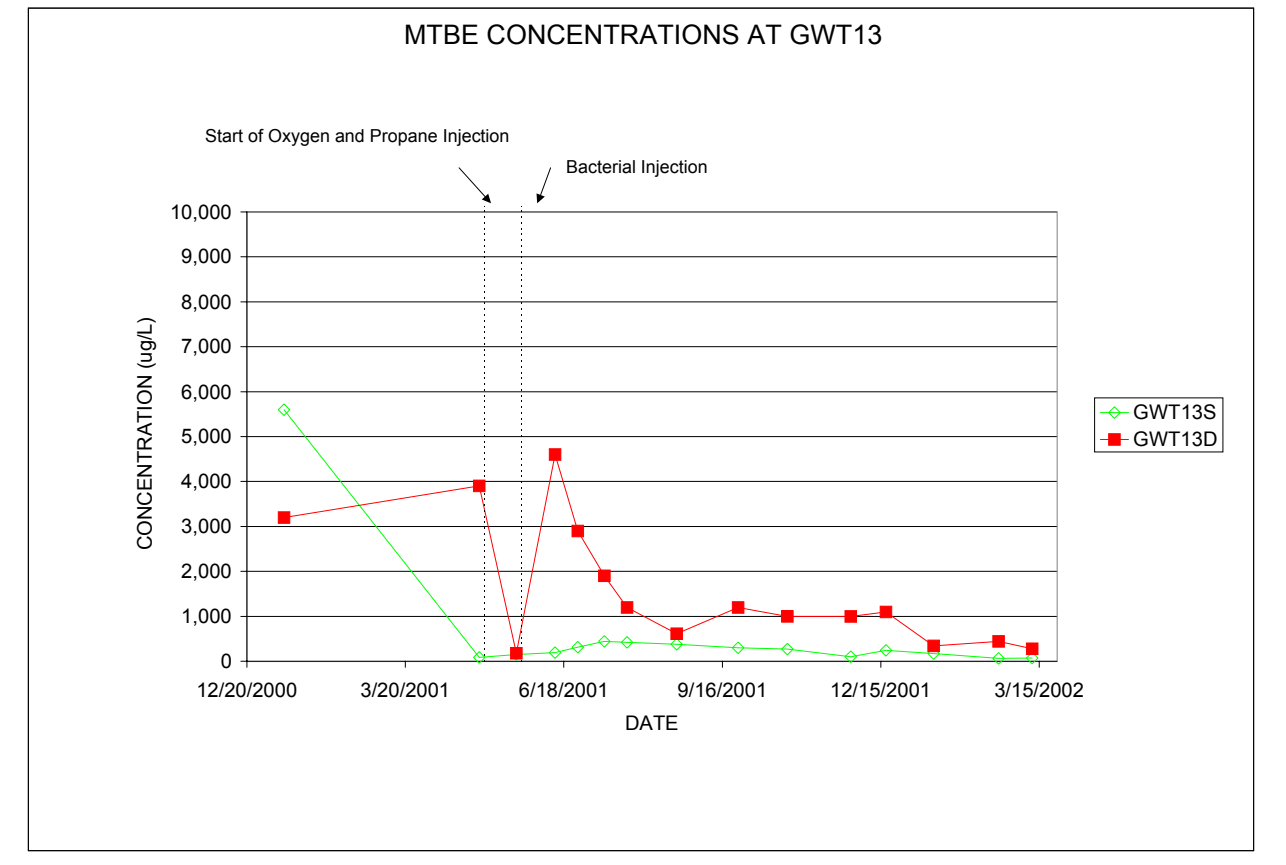
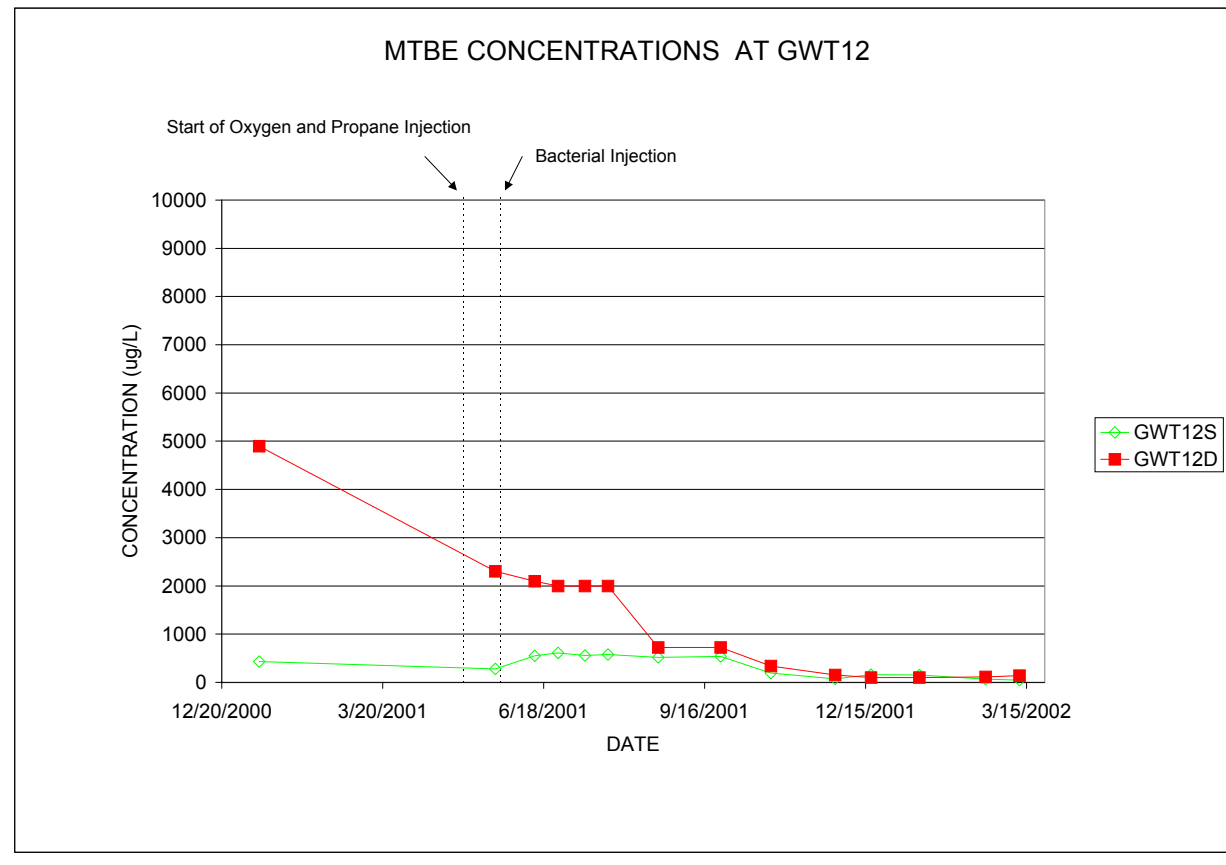
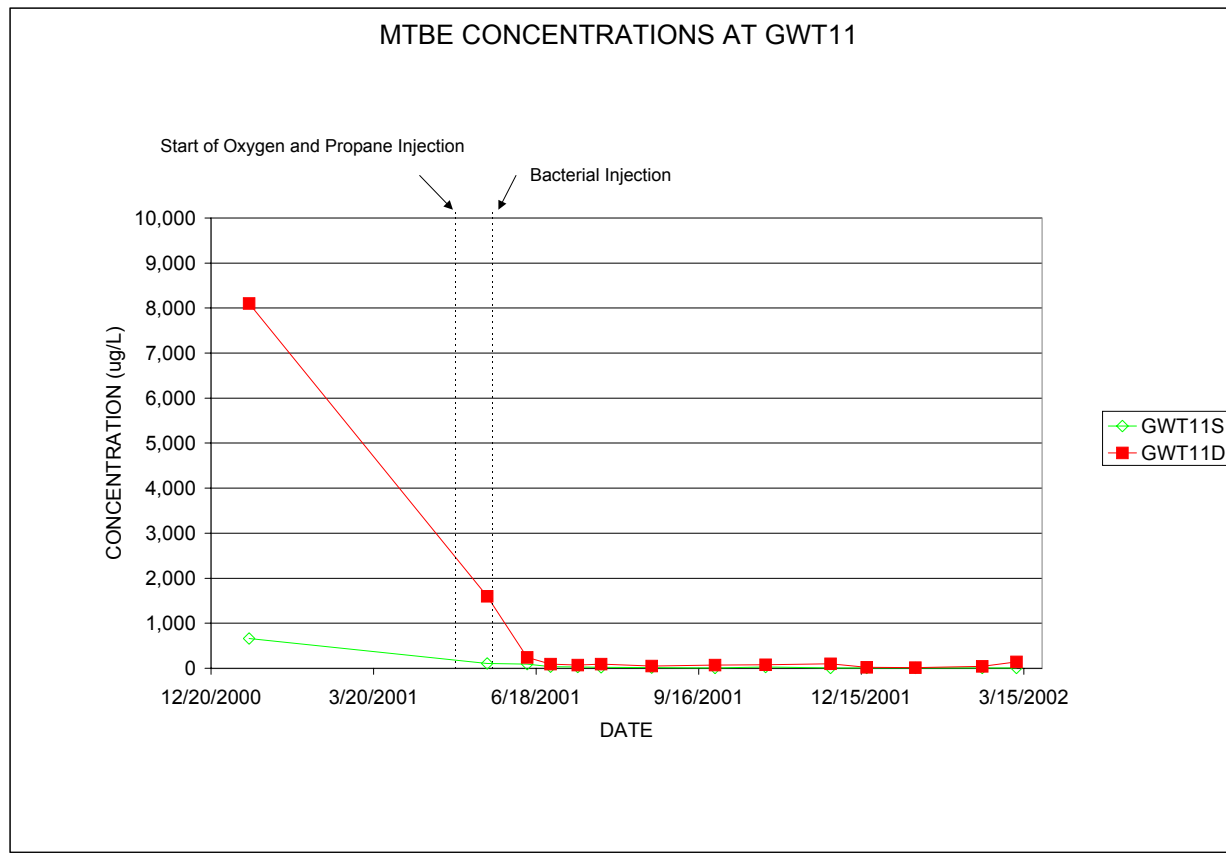
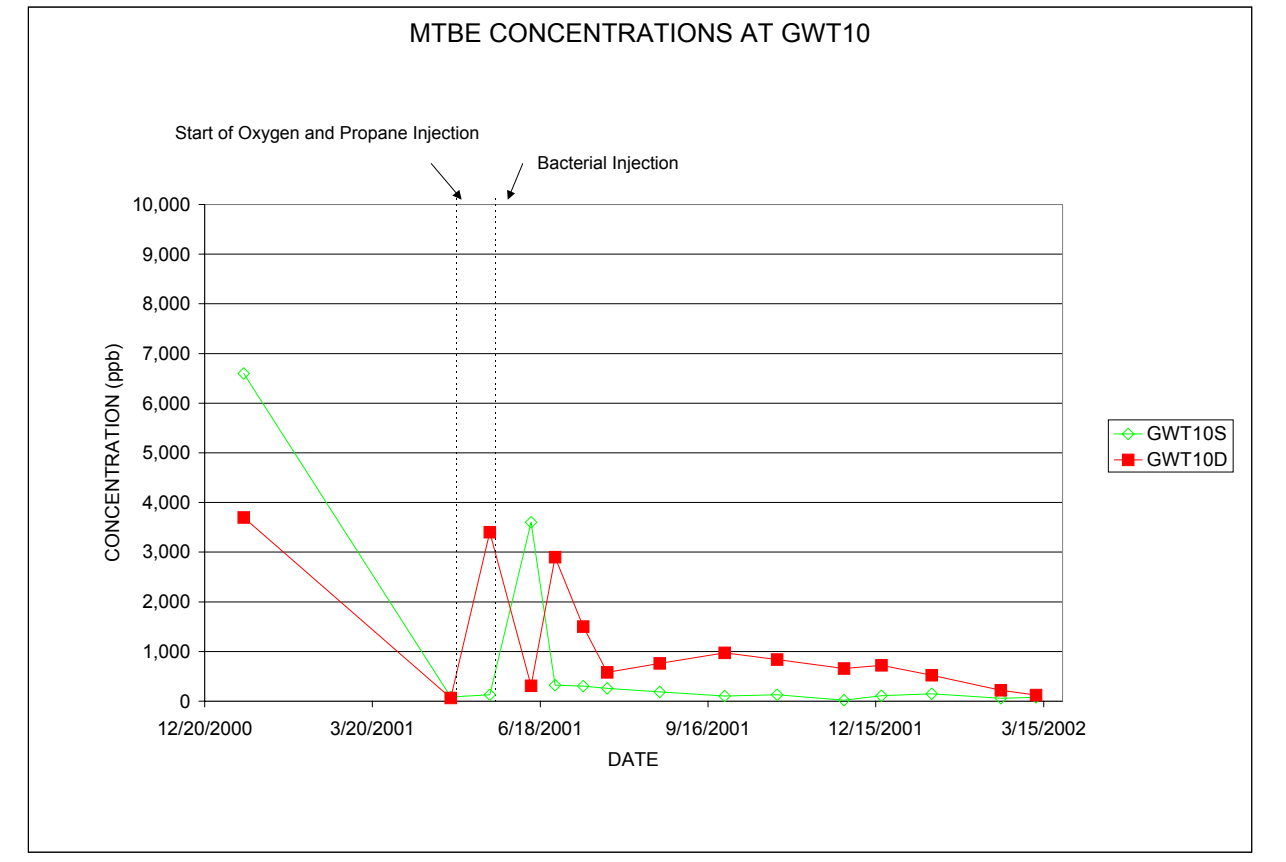
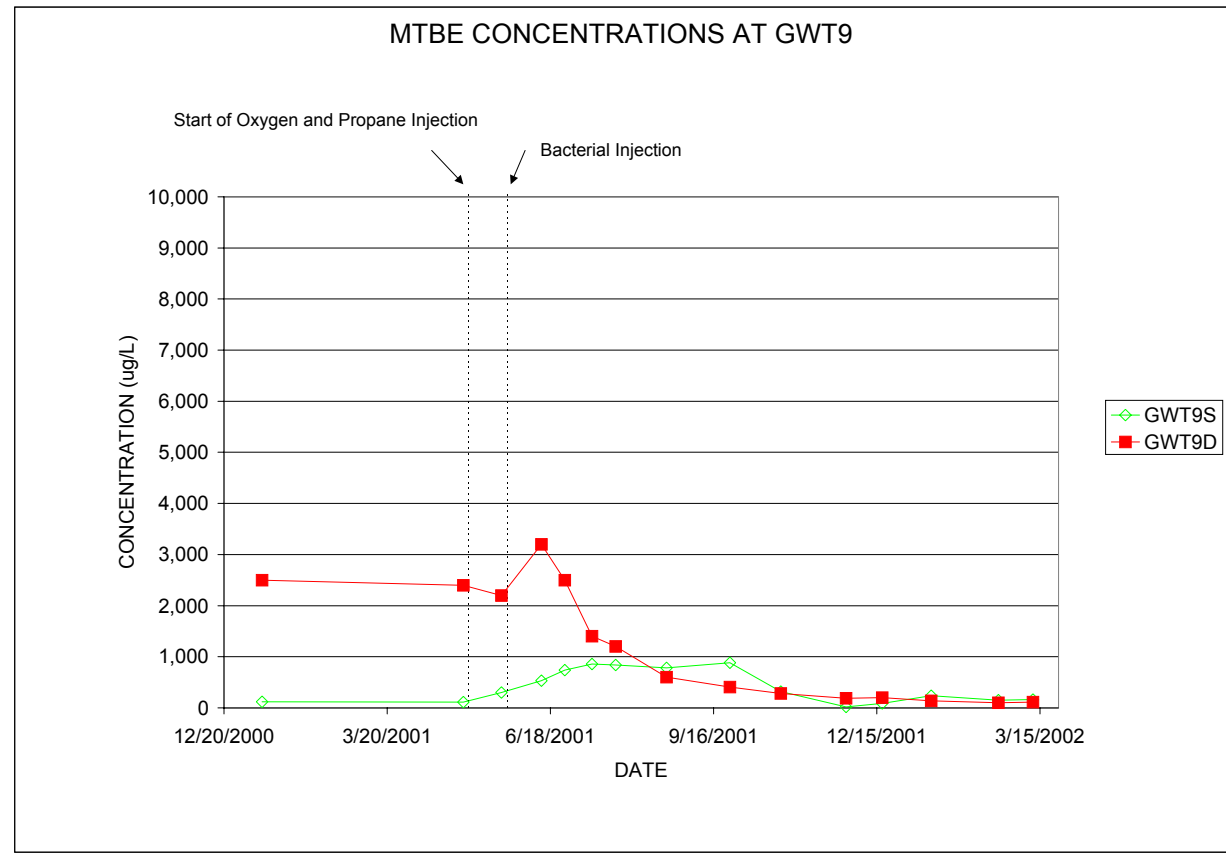
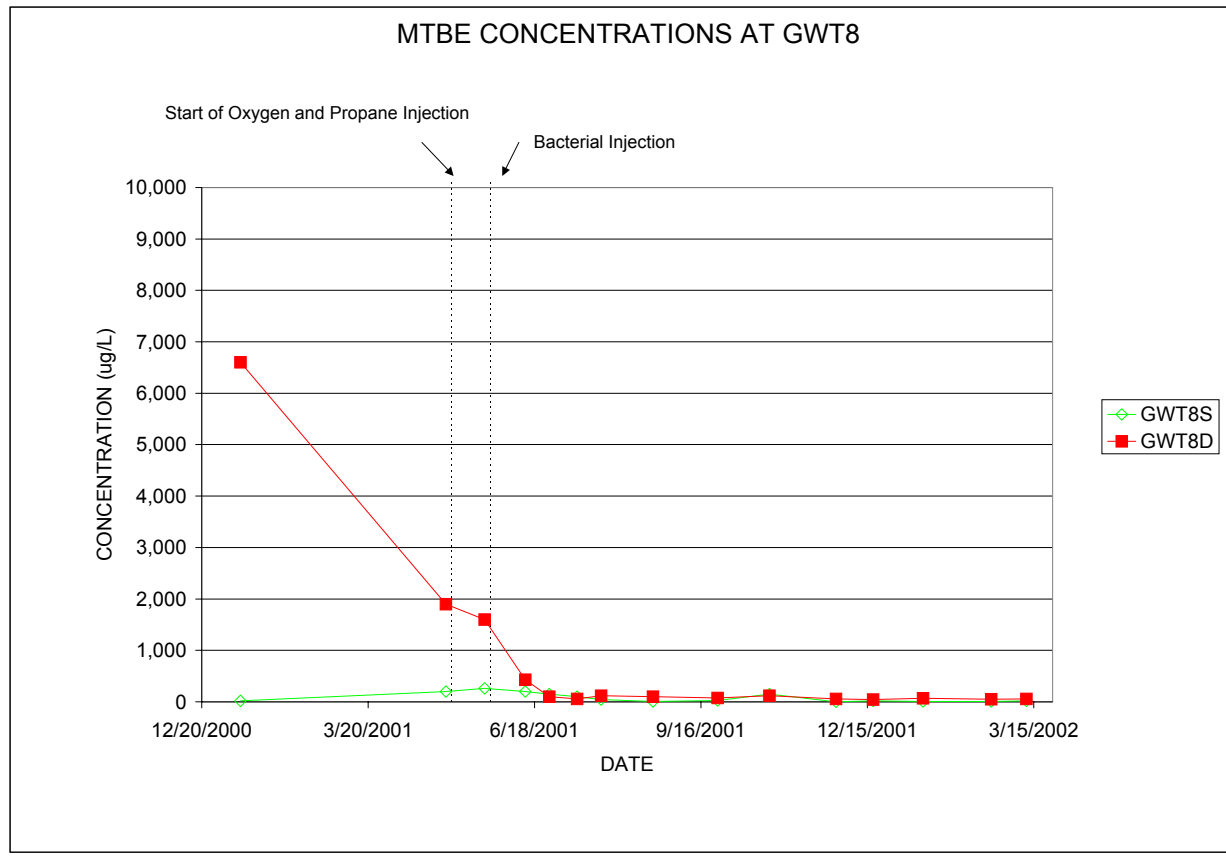
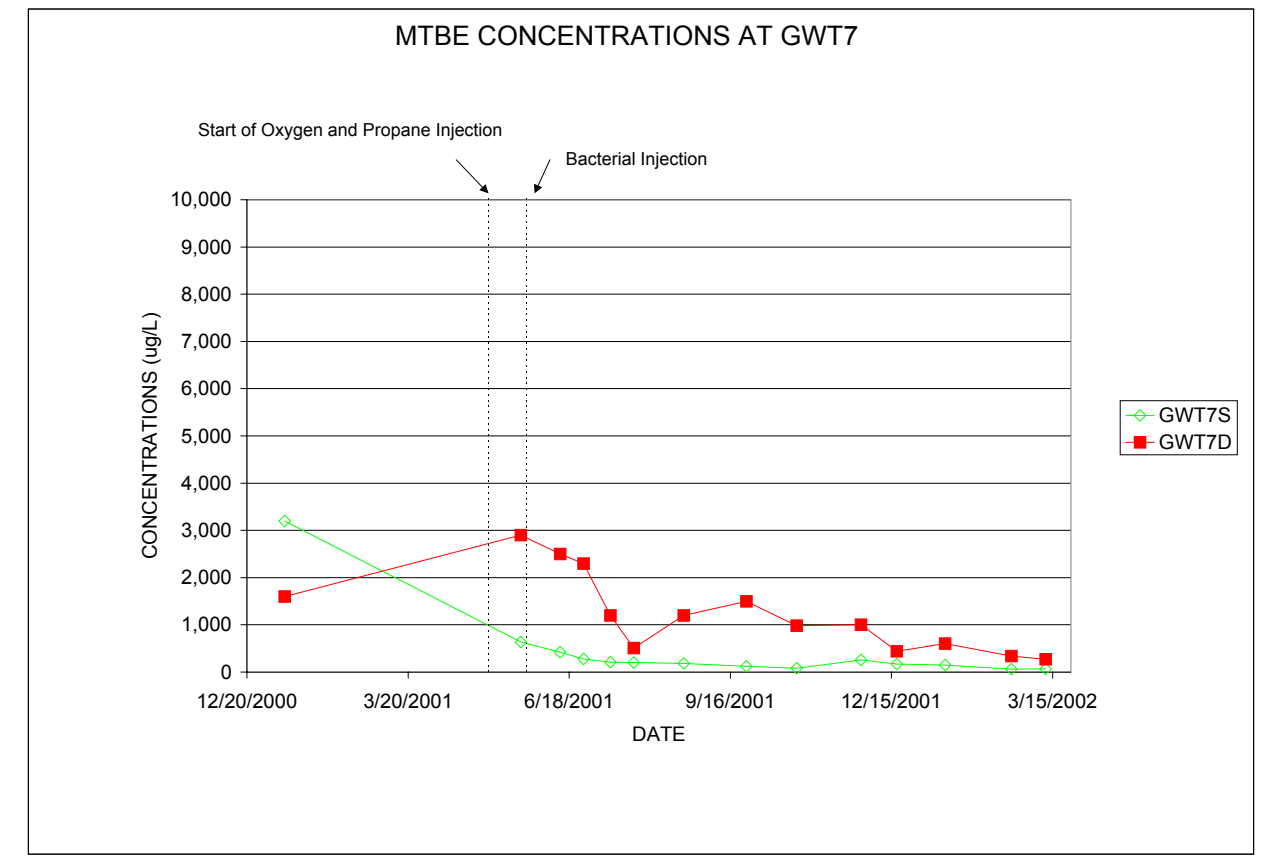
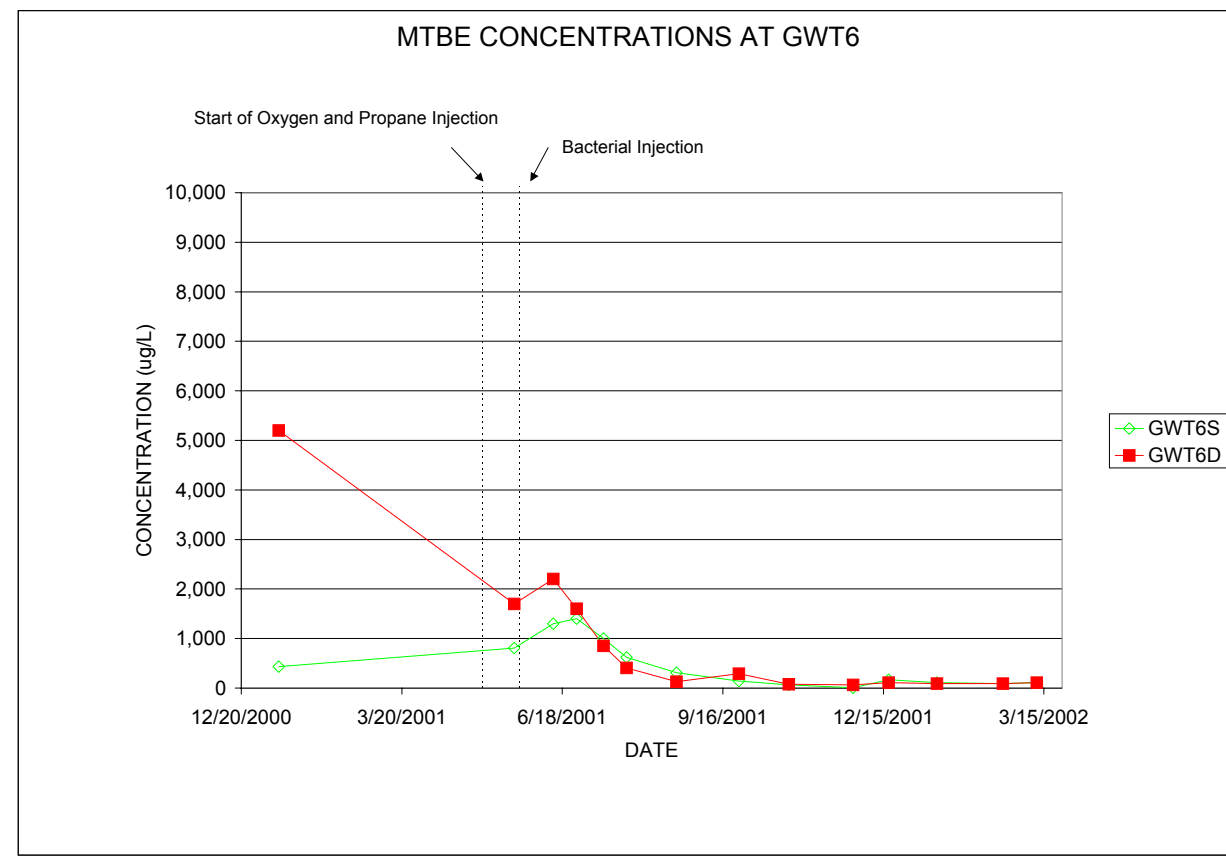
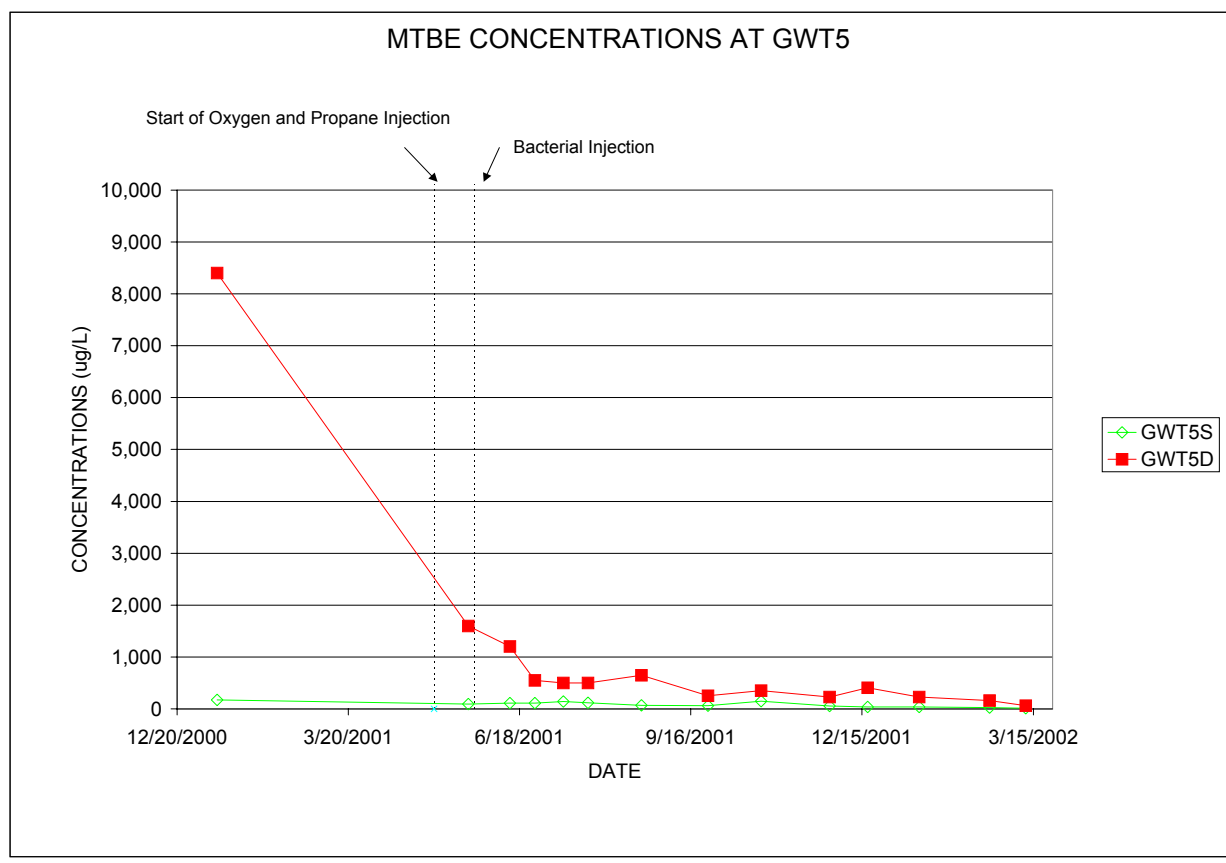
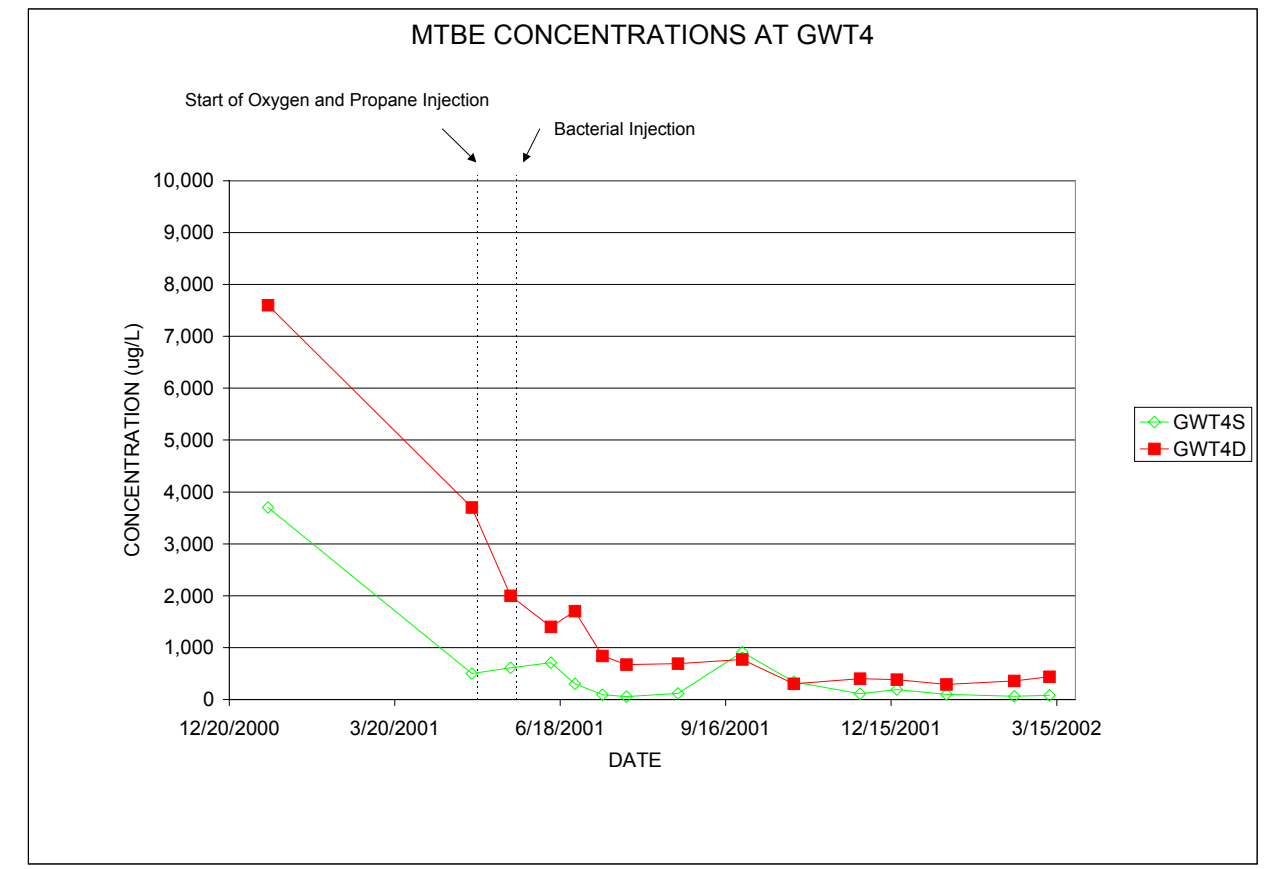
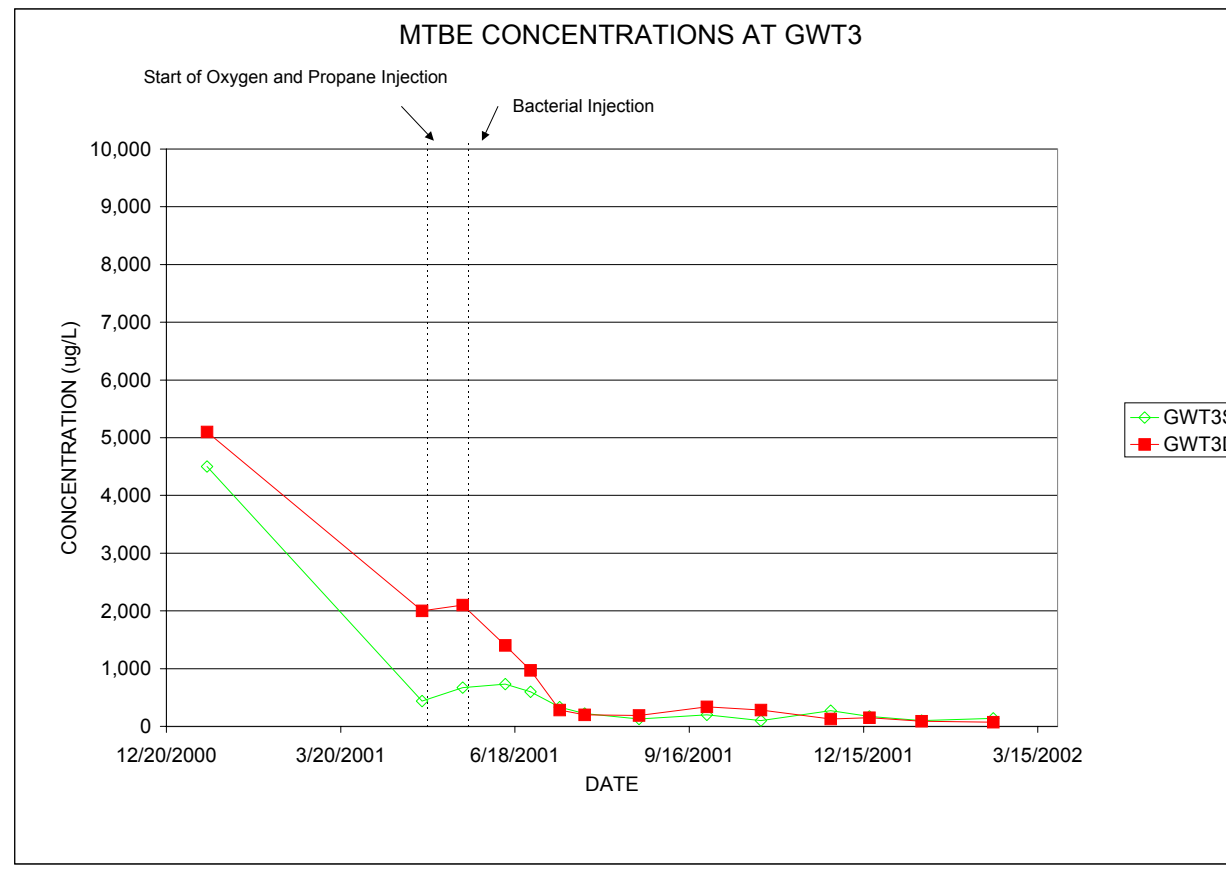
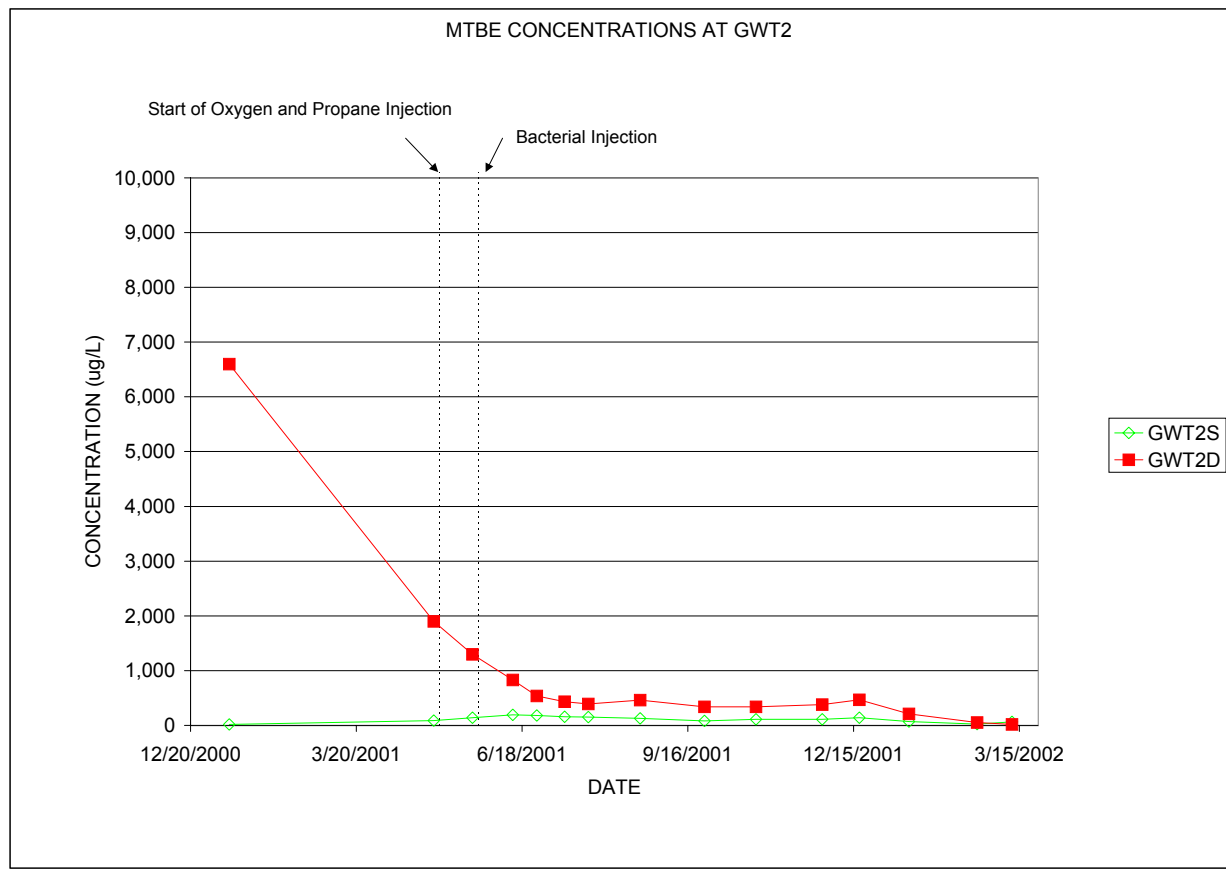
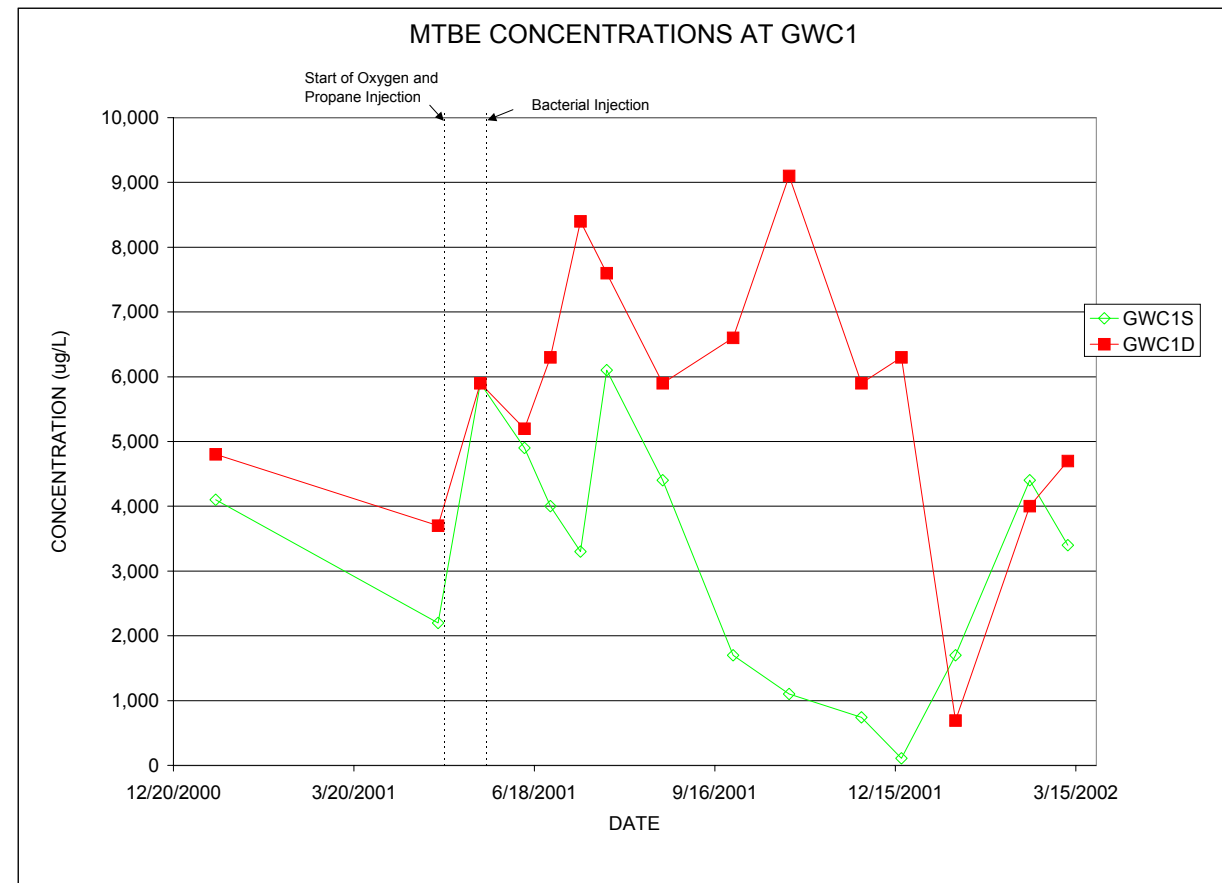
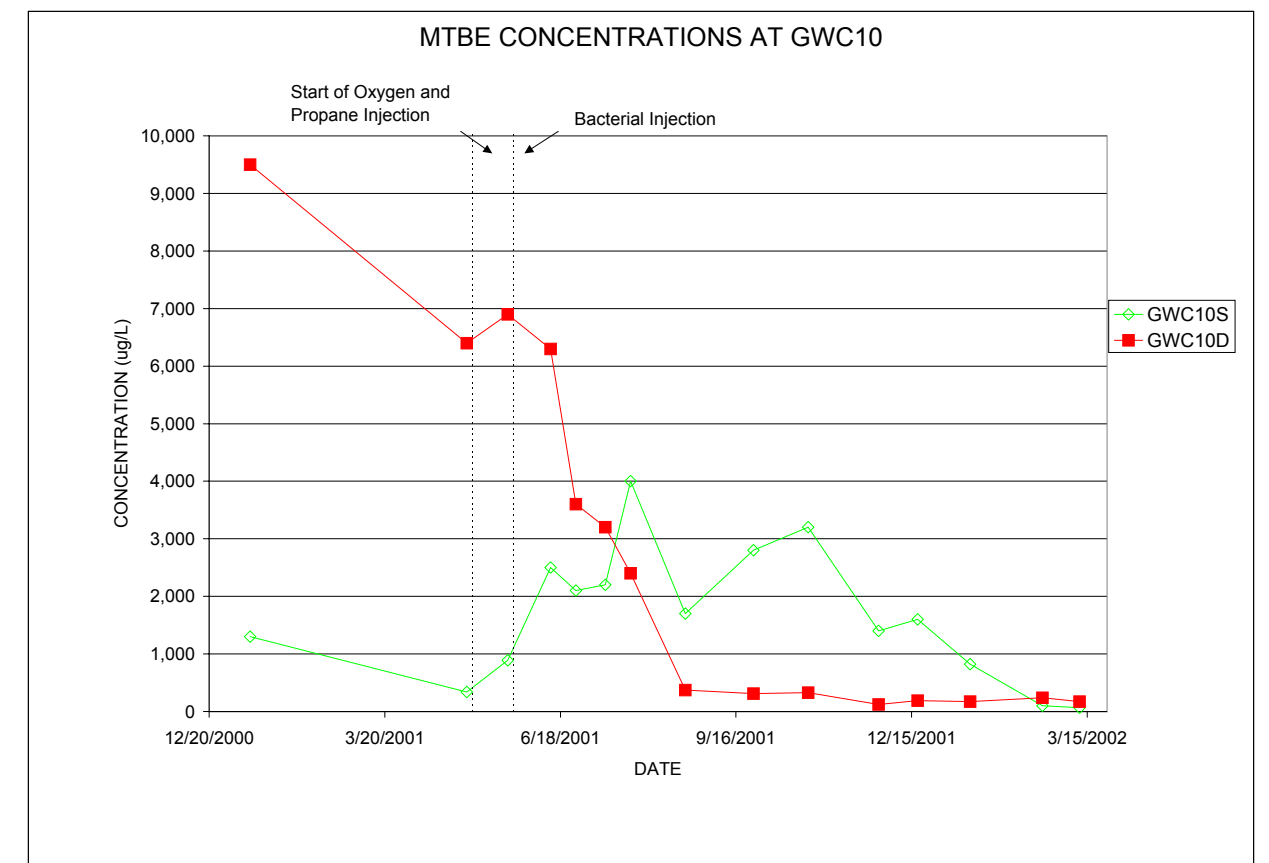
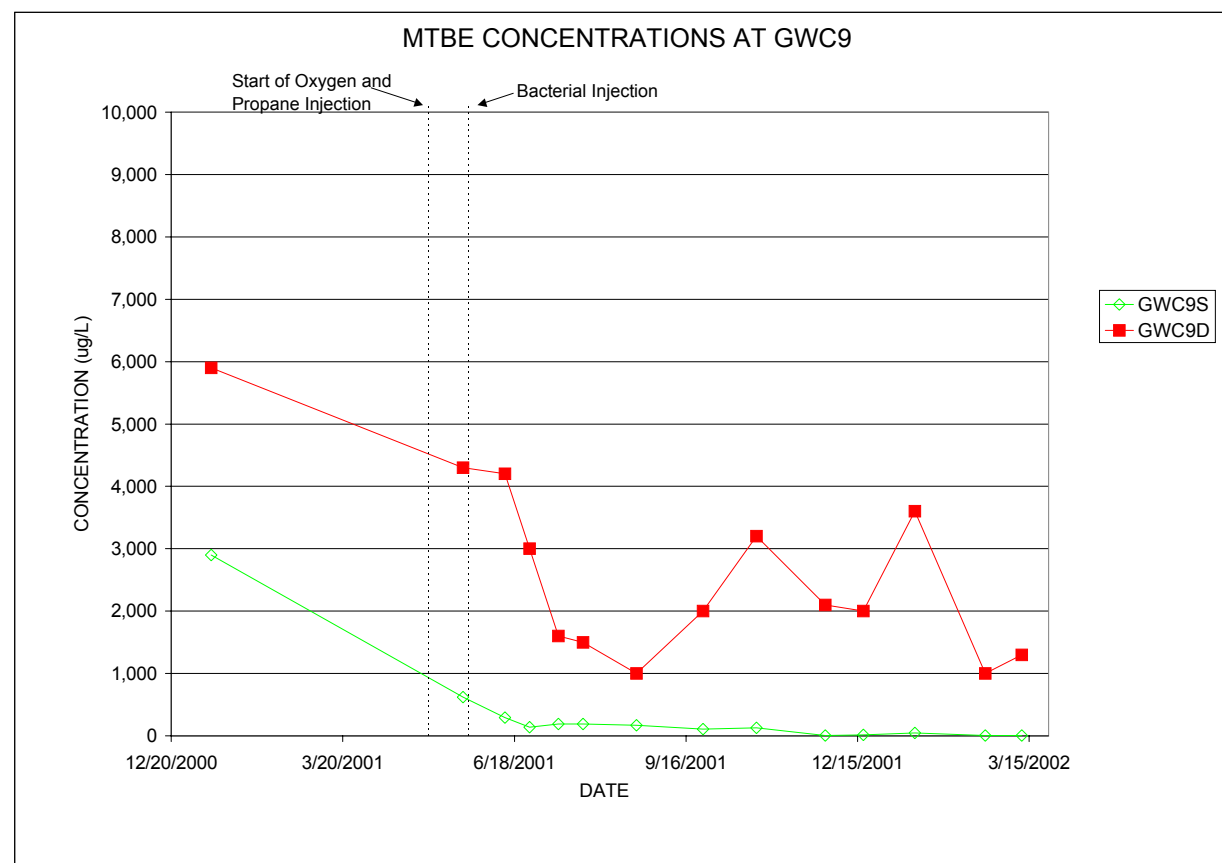
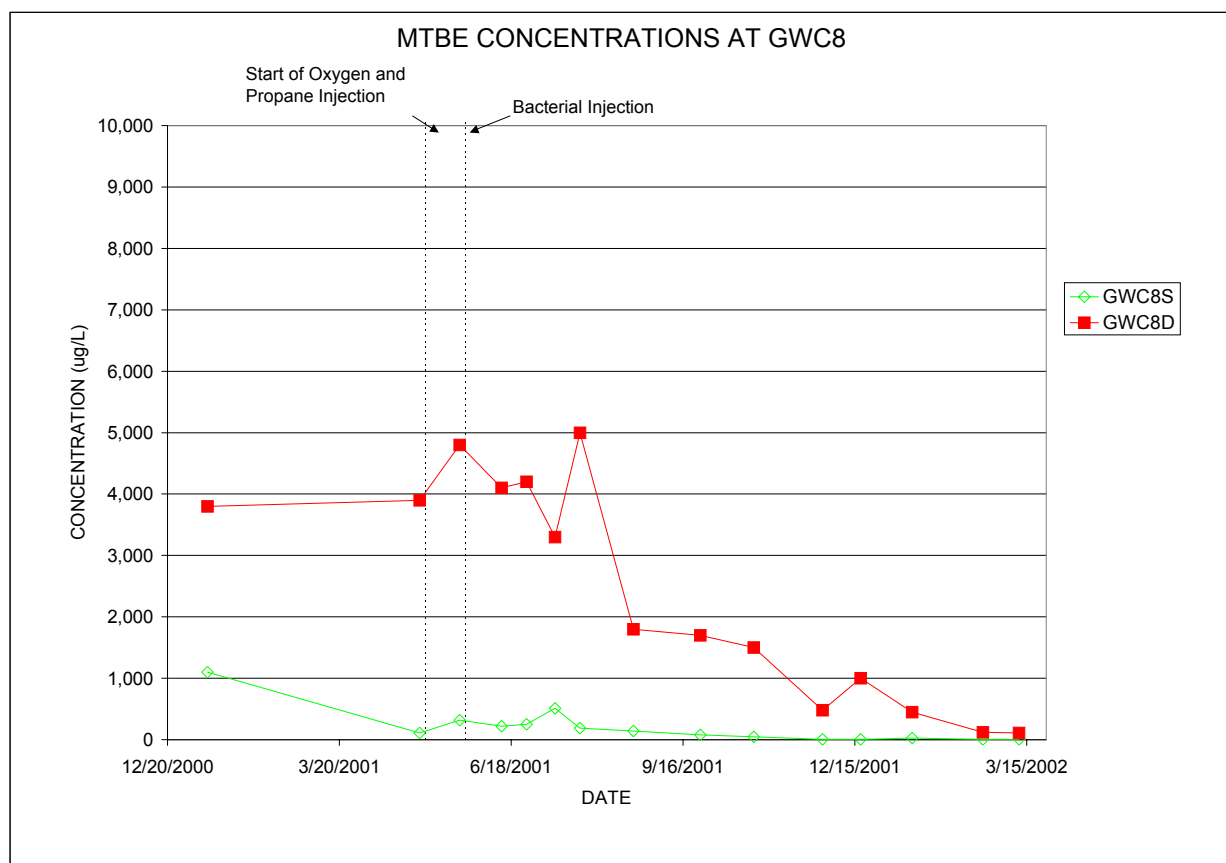
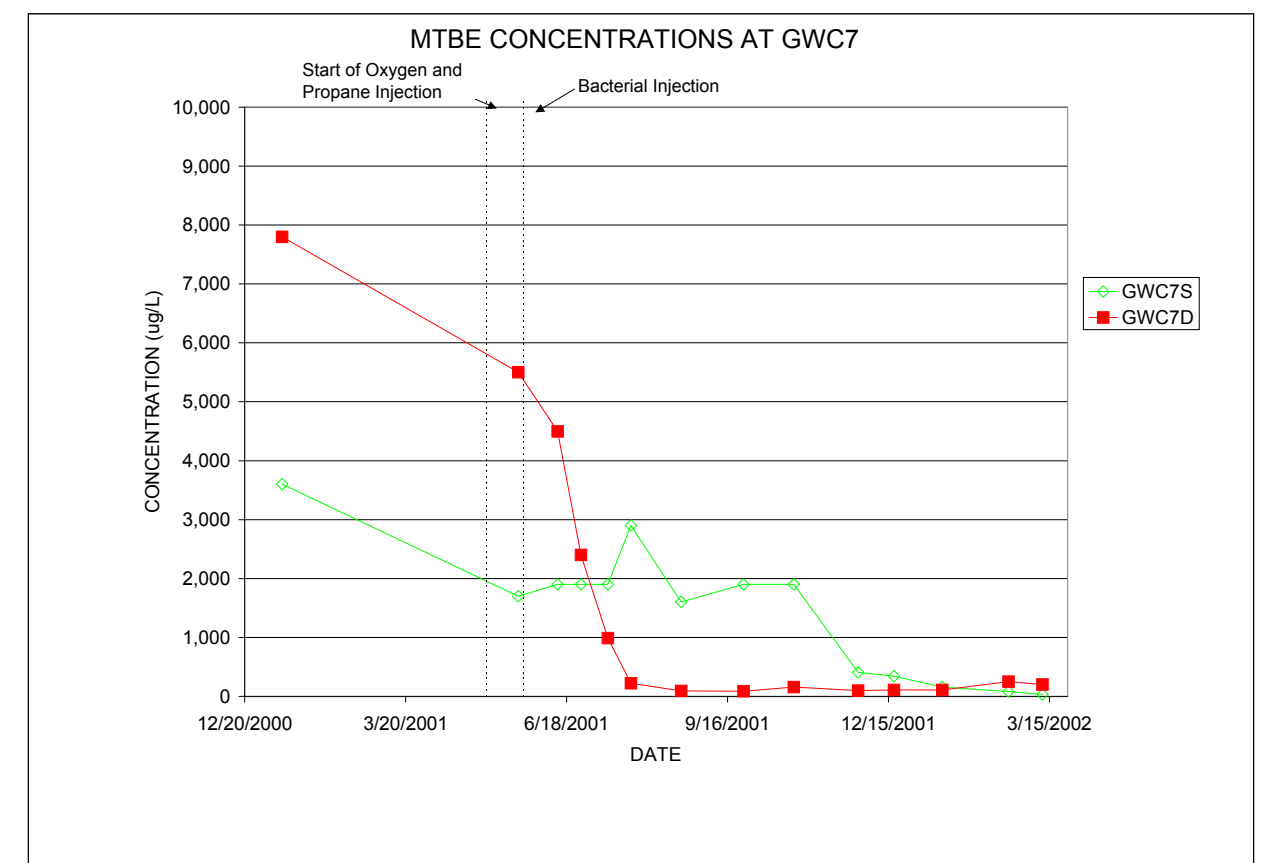
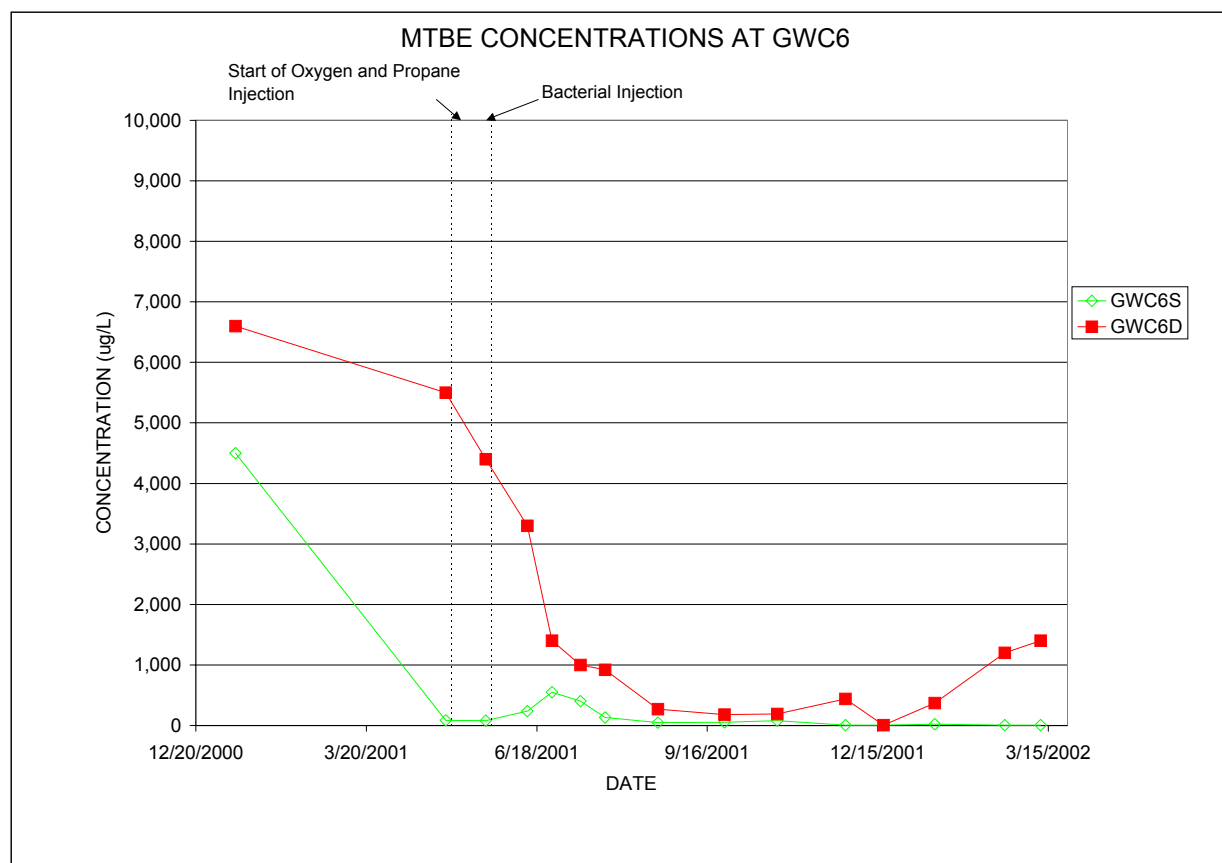
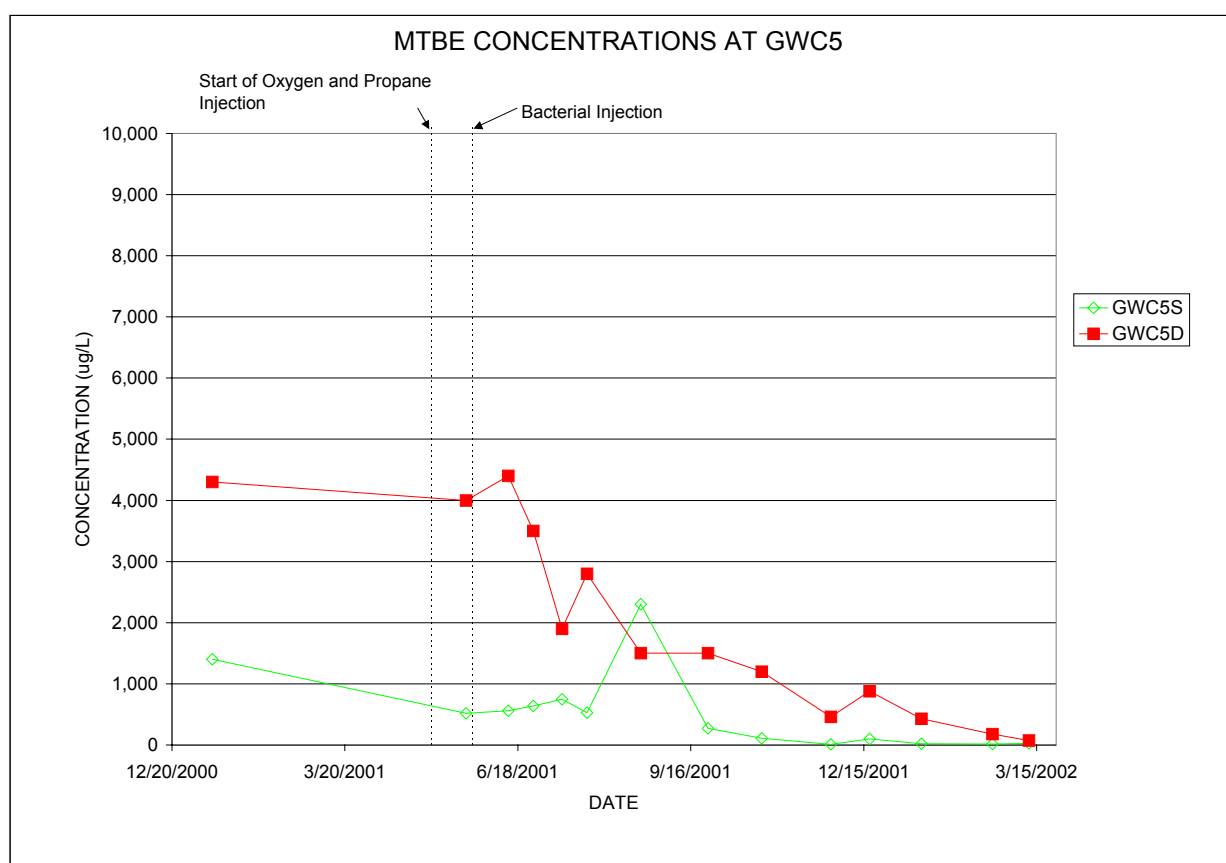
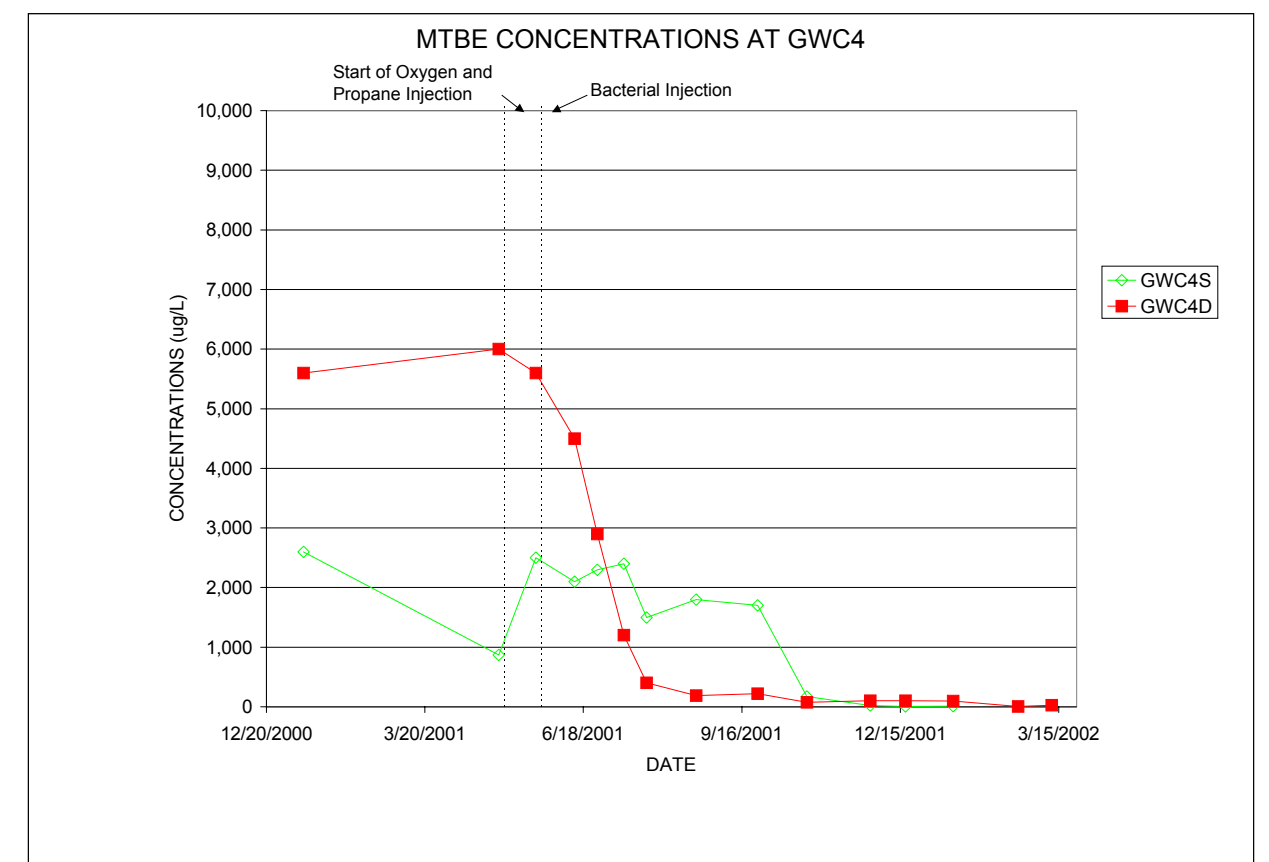
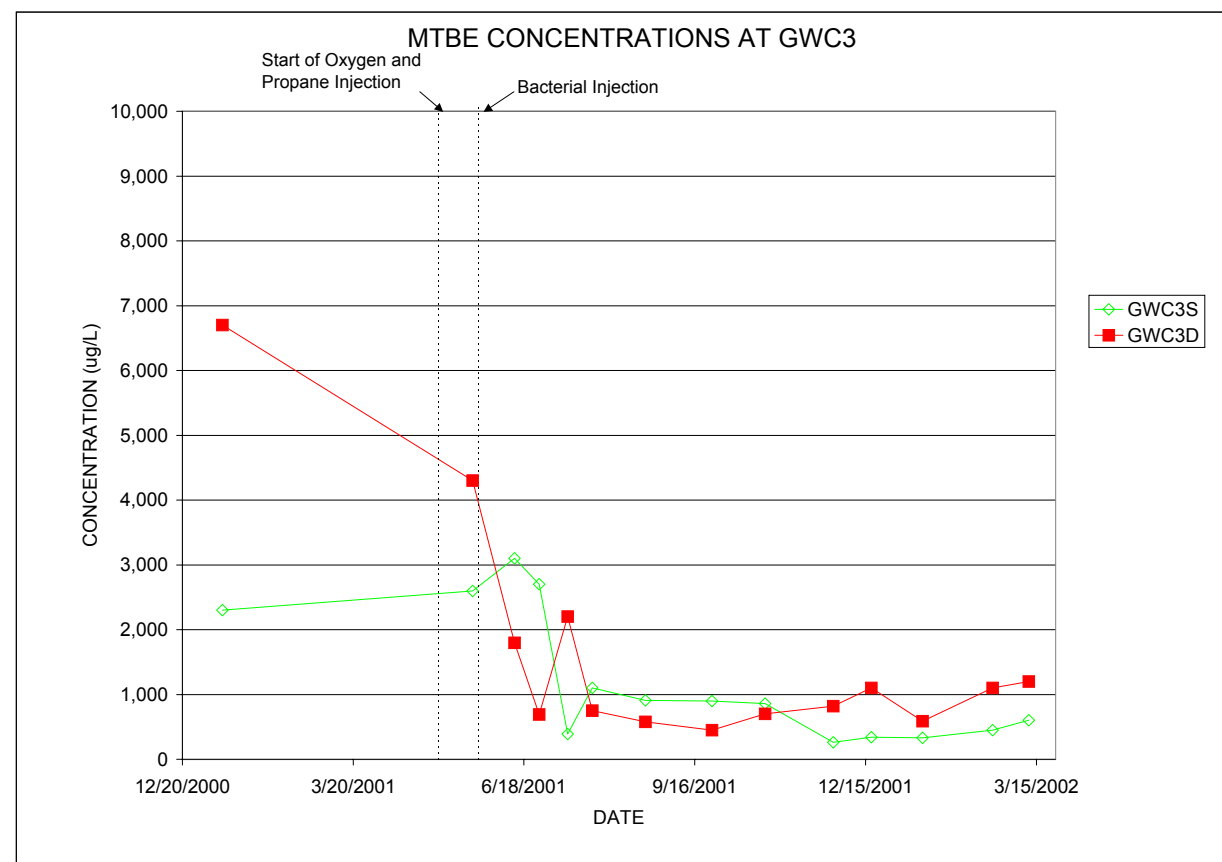
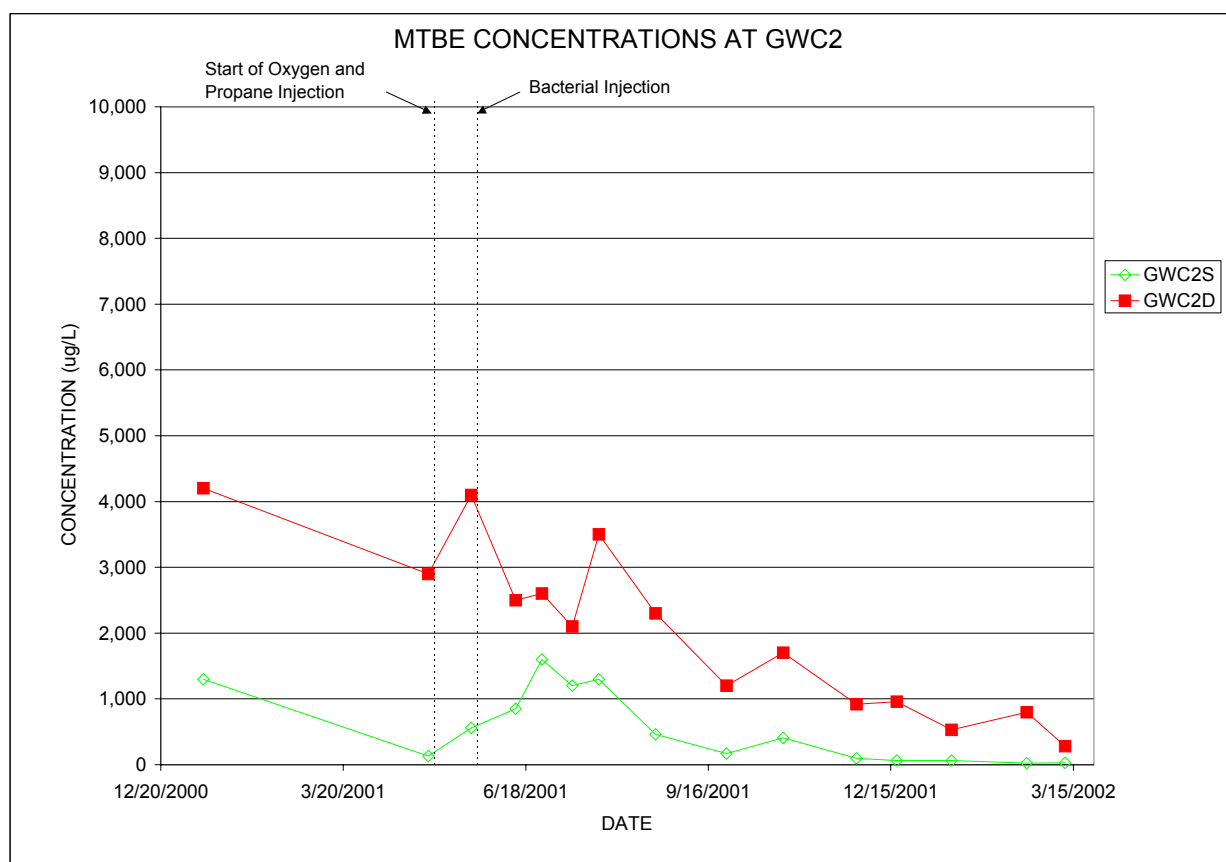

Figure 18. MTBE Concentrations in Control Plot Monitoring Wells
 MTBE Demonstration Project
 ESTCP
 Port Hueneme, CA
 Envirogen Project No. 92132



O O O O Oxygen Injection Points O O O O



4.2.3.1 Test Plot

MTBE concentrations varied widely throughout the Test and Control Plots, even before the demonstration was initiated. For example, in January 2001, approximately 5 months before beginning the demonstration, MTBE concentrations in the Test Plot shallow wells averaged 1,906 $\mu\text{g/L}$ with a standard deviation of 2,236 $\mu\text{g/L}$ ($n=15$). MTBE concentrations ranged from 3 $\mu\text{g/L}$ in GWT-15S to 6,600 $\mu\text{g/L}$ in GWT-10S. In the deep wells of the Test Plot MTBE concentrations ranged from 1,600 $\mu\text{g/L}$ at GWT-7D to 8,400 $\mu\text{g/L}$ in GWT-5D, with a mean MTBE concentration of 5,247 $\mu\text{g/L}$ and a standard deviation of concentrations of 1,922 $\mu\text{g/L}$ ($n=15$). The relatively high concentrations of MTBE may have been related to a large rain event that occurred during the days immediately preceding sampling. By the time oxygen and propane were injected into the plots on May 4, 2001, mean MTBE concentrations in the Test Plot shallow and deep wells were 340 $\mu\text{g/L}$ ($SD=510 \mu\text{g/L}$; $n=10$) and 2,477 $\mu\text{g/L}$ ($SD=1114 \mu\text{g/L}$; $n=10$), respectively. This variability in MTBE concentrations made it difficult to analyze the data by typical methods such as comparing mean concentration values from rows of monitoring wells located equidistant down gradient of the treatment zone (Salanitro et al., 2000). Consequently, most degradation analyses involved comparing the concentrations of MTBE at single monitoring wells, or along the flow gradient in columns of monitoring wells (see below).

In the deep monitoring well network, MTBE concentrations in the well upgradient of the Test Plot (GWT-1D) were generally above 2,000 $\mu\text{g/L}$ for the first four months following bioaugmentation, and they decreased to approximately 1,000 $\mu\text{g/L}$ for the remaining six months of the demonstration. The reason for the decrease is unknown, but it could be due to lower concentrations of MTBE moving downgradient in the plume, or because of microbial activity near the upgradient monitoring well. In comparison, MTBE concentrations in monitoring wells directly downgradient of MW-1D (i.e., the center well line, including GWT-3D, GWT-6D, and GWT-9D) rapidly decreased during the first two months of system operation following bioaugmentation (Table 3). MTBE levels decreased in GWT-3D from 2,100 $\mu\text{g/L}$ (May 20, 2001) to 280 $\mu\text{g/L}$ (July 10 2001) and 73 $\mu\text{g/L}$ by the end of the demonstration. Similarly, MTBE concentrations in wells GWT-6D, GWT-9D, and GWT-12D decreased dramatically over the course of the demonstration. The concentration at GWT-6D decreased from 1,700 $\mu\text{g/L}$ in May 2001 to 110 $\mu\text{g/L}$ by the end of the demonstration (March, 2002). A similar degree of MTBE decrease was observed in wells GWT-9D, GWT-12D, and GWT-15D (See Figure 17).

MTBE concentrations also decreased by a factor of 20 in the other deep monitoring wells in the Test Plot. The maximum MTBE concentrations in the deep Test Plot wells immediately prior to bioaugmentation was 3,400 $\mu\text{g/L}$ at GWT-10D and GWT-15D, with most wells having a concentration above 1,300 $\mu\text{g/L}$. At the conclusion of the demonstration, the maximum MTBE concentration in the deep Test Plot wells was 440 $\mu\text{g/L}$, with most wells having a concentration below 150 $\mu\text{g/L}$. Given that MTBE concentrations in the deep upgradient well were approximately 1,000 $\mu\text{g/L}$ in the last several months of the demonstration, the observed decrease

in MTBE concentrations in the monitoring well network is a strong indication that MTBE biodegradation is occurring in the aquifer.

In the shallow monitoring well network, MTBE concentrations in the well upgradient of the Test Plot (GWT-1S) decreased from 1,700 µg/L to 5 µg/L by the end of the demonstration (Table 3 and Figure 17). Groundwater entering the shallow aquifer in the Test Plot generally contained less than 250 µg/L after July 2001. This result suggests that groundwater upgradient of the demonstration area contains low concentrations of MTBE or, more likely, that propane and oxygen spread upgradient into the shallow aquifer and promoted MTBE biodegradation at GWT-1S. As stated previously, dissolved oxygen in the background well was generally lower than in the rest of the Test Plot, but dissolved oxygen increases were observed in the background well over the course of the demonstration.

MTBE concentrations in the other shallow monitoring wells in the Test Plot were typically less than 1,000 µg/L during the demonstration. Concentrations of MTBE in the line of wells GWT-2S, GWT-5S, GWT-8S, and GWT-11S was generally less than 200 µg/L and, in fact, approached 5 µg/L by the end of the demonstration. A similar trend in MTBE concentrations was observed in all of the shallow monitoring wells in the Test Plot. This trend may be due groundwater with low MTBE concentrations entering the Test Plot, as indicated by the MTBE concentrations in the upgradient well. However, given that DO levels in the shallow Test Plot wells were generally above 2 mg/L, the low MTBE concentrations in this plot may be an indication that fast biodegradation rates were achieved in this zone as a result of effective oxygen and propane distribution to the shallow portion of the aquifer.

The observed trends in MTBE concentrations, both in the shallow and deep wells, indicate that MTBE biodegradation occurred in this plot. Further, the data suggests that MTBE consumption proceeded at a relatively rapid rate. A quantitative analysis of biodegradation rates is further discussed in Section 4.5 below.

The concentrations of TBA in Test Plot wells, both shallow and deep, were generally below 260 µg/L. These data are presented in Table 3. At the May 2001 sampling event (immediately before bioaugmentation), TBA was detected at low levels in 5 of the 30 ENVIROGEN monitoring wells in this plot. By the end of the demonstration in March 2002, TBA was detected at low concentrations in 19 of the 30 monitoring wells in this plot (Table 4). This occurrence of TBA was likely the result of MTBE degradation in the plots. The production of small amounts of TBA was expected based upon the laboratory microcosm studies, and our previous analysis of the MTBE degradation pathway of ENV425 (Steffan et al., 1997). Our microcosm studies also revealed that TBA is degraded in the site aquifer material provided MTBE loading is not too great. Thus, it is likely that most of the TBA generated during MTBE degradation at the site also was biodegraded in situ.

4.2.3.2 Control Plot

Control Plot MTBE concentrations in the deep and shallow wells are presented in Table 3 and in Figure 18. MTBE concentration trends in the Control Plot were not as consistent as those observed in the Test Plot. In the deep monitoring well network, MTBE concentrations in the well upgradient of the Control Plot (GWC-1D) were generally above 6,000 µg/L for the first seven months following system startup and decreased to approximately 4,000 µg/L for the remaining three months of the demonstration (Table 3). In monitoring wells directly downgradient of GWC-1D (i.e., the central well line GWC-3D, GWC-6D, and GWC-9D) MTBE concentrations initially decreased, but increasing trends were observed over the duration of the demonstration. In well GWC-3D, MTBE decreased from 4,300 µg/L to 450 µg/L four months after startup, then increased to 1,200 µg/L by the end of the demonstration (Table 3). Similarly, MTBE concentrations in GWC-6D decreased from 4,400 µg/L to 5 µg/L over the first seven months then increased to 1,200 µg/L by the end of the demonstration (Table 3). In GWC-9D, MTBE concentrations decreased from 4,300 µg/L to 1000 µg/L within three months of system startup, then increased to 3,600 µg/L.

Trends in MTBE concentrations in the two other lines of deep monitoring wells were different than those observed in the central monitoring well line. MTBE concentrations in deep wells GWC-2D, GWC-5D and GWC-8D decreased gradually over the duration of the demonstration from approximately 4,000 µg/L to below 280 µg/L by the end of the demonstration. On the other hand, MTBE concentrations in the deep wells GWC-4D, GWC-7D and GWC-10D decreased from approximately 6,000 µg/L to less than 200 µg/L within six months of system startup (Table 3), and remained at these concentrations for the remainder of the demonstration.

In the shallow monitoring well network, MTBE concentrations in the well upgradient of the Control Plot (GWC-1S) decreased from approximately 6,000 µg/L to 110 µg/L seven months after system startup (December 2001), then increased to approximately 4,000 µg/L by the end of the demonstration (March, 2002) (Table 3).

MTBE concentrations in the shallow monitoring wells along the center line of the monitoring wells in the Control Plot (i.e., GWC-3S, GWC-6S and GWC-9S) were generally less than concentrations observed in the upgradient well GWC-1S. In GWC-3S, MTBE concentrations decreased from approximately 2,600 µg/L in May 2002 (before system startup) to approximately 1,000 µg/L by July 2002 (Table 3). On the other hand, MTBE concentration in wells GWC-6S and GWC-9S were generally less than 620 µg/L at system startup (May 2001) and decreased to 6 µg/L by the end of the demonstration.

Trends in MTBE concentrations in the well line GWC-4S, GWC-7S and GWC-10S showed evidence of biodegradation and a “biodegradation front” moving across these wells. MTBE concentrations in GWC-4S were approximately 2,000 µg/L through September 2001, then decreased to 20 µg/L by November 2001. In GWC-7S, MTBE levels were approximately 2,000

µg/L through October 2001 and decreased to 82 µg/L by February 2002. Finally, in GWC-10S, MTBE concentrations were approximately 2,000 µg/L through December 2002 and decreased to 68 µg/L by March 2002. MTBE concentrations in the well line GWC-2S, GWC-5S and GWC-8S were generally at or below 1,000 µg/L and decreased to less than 30 µg/L by the end of the demonstration.

The observed trends in MTBE concentrations in the Control Plot suggest that biodegradation occurred in this Plot also. Data from both shallow and deep wells show a decreasing trend in MTBE concentrations over the duration of the demonstration. These results indicate that indigenous bacteria at this Site are capable of aerobically degrading MTBE.

4.2.4 BIOLOGICAL PARAMETERS

4.2.4.1 Total Heterotrophs

The average total heterotrophs measured in groundwater during the demonstration was generally higher in the Test Plot than in the Control Plot. Figure 19 shows the average heterotrophic population in both plots at each sampling event. The maximum average total heterotrophic population in the Test and Control Plots were approximately 3.6×10^5 cfu/ml and 3.4×10^4 cfu/ml, respectively. The difference between the two plots became significantly more pronounced after the fifth groundwater sampling event (approximately 2 months after system startup). The higher population in the Test Plot suggests greater microbial growth was occurring in this plot, presumably because a readily degradable carbon source (i.e., propane) was added to this plot. Given that these populations are measured in groundwater, it is likely that microbial population on soil in the Test Plot is also higher than the population in the Control Plot.

4.2.4.2 Propanotrophs

Propanotroph populations were measured by using the plate count method which can lead to an underestimation of total propanotroph numbers because of their slow growth. Because this method was used for both plots, it at least provides a method for comparison. The average propanotroph population measured in groundwater during the demonstration was generally 1 to 2 orders of magnitude higher in the Test Plot than in the Control Plot (Figure 20). The maximum average propanotrophic population in the Test and Control Plots were approximately 1.1×10^5 cfu/ml and 1.1×10^4 cfu/ml, respectively. The difference between the two plots became significantly more pronounced after the fifth groundwater sampling event (approximately 2 months after system startup). The higher propanotroph population in the Test Plot was likely a result of the addition of ENV425 and propane injection into the Test Plot.

**Figure 19: Average Heterotroph Population
ESTCP Propane Biostimulation Demonstration
Port Hueneme, CA**

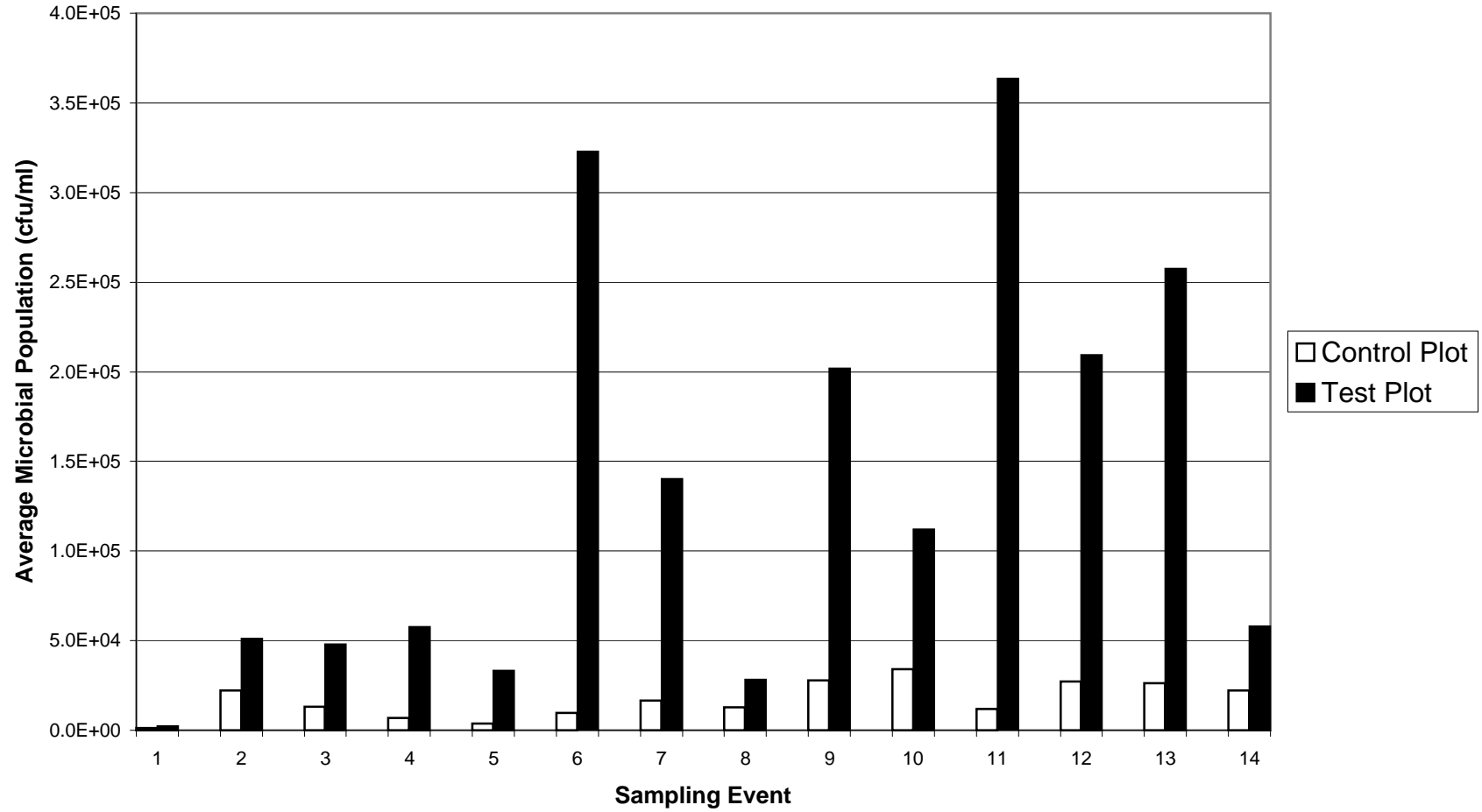

**Figure 20: Average Propanotroph Population
ESTCP Propane Biostimulation Demonstration
Port Hueneme, CA**

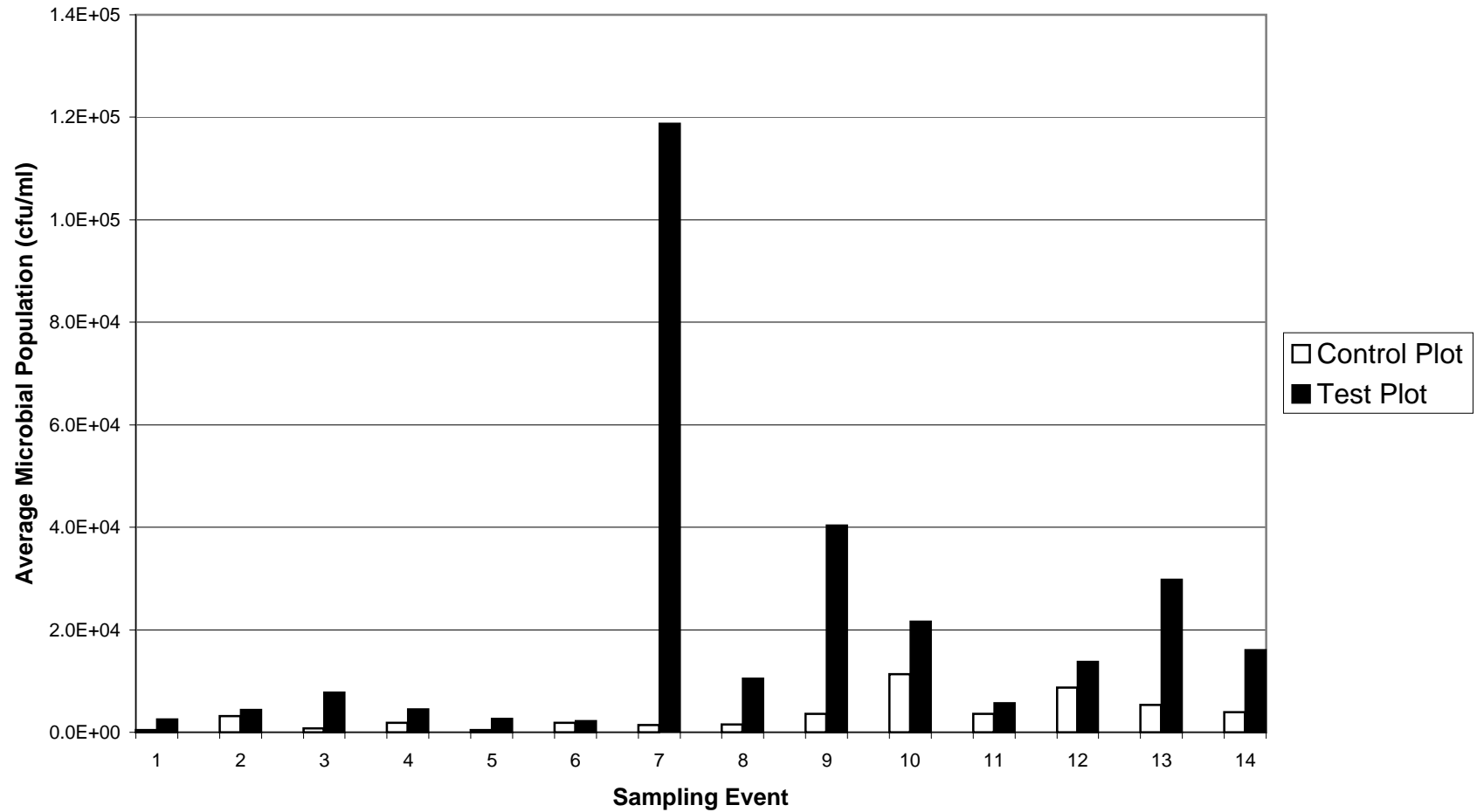

4.2.5 MTBE BIODEGRADATION RATES

MTBE biodegradation rates in the Test and Control Plots were determined using the method described by Buscheck and Alcantar (Buscheck and Alcantar, 1995). This method utilizes the analytical solution of the one-dimensional advection-dispersion equation with a first-order biodegradation term to develop a simplified expression for chemical concentration over space. Assuming that the plume is at steady-state, Buscheck and Alcantar developed the following equation for concentration change along the plume:

$$C(x) = C_0 \exp \left[\left(\frac{x}{2\alpha_x} \right) \left[1 - \left(1 + \frac{4\lambda\alpha_x}{v_c} \right) \right] \right]$$

where:

x is distance (ft)

C is concentration ($\mu\text{g/L}$)

C_0 is the concentration ($\mu\text{g/L}$) at $x = 0$

α_x is the dispersivity in the x -direction (1/ft)

v_c is the retarded chemical velocity (ft/day)

λ is the first-order biodegradation rate constant (1/day)

A compact form of this equation is:

$$C(x) = C_0 \exp(mx)$$

where

$$m = \frac{1}{2\alpha_x} \left[1 - \left(1 + \frac{4\lambda\alpha_x}{v_c} \right)^{1/2} \right]$$

Thus, a plot of concentration versus distance can be fit with an exponential function. The fitted exponent value is equal to m . Solving for the first order biodegradation rate constant, λ , we obtain:

$$\lambda = \frac{V_c}{4\alpha_x} \left[(1 + 4\alpha_x m)^2 - 1 \right]$$

Figures 21 and 22 show the change in concentration versus distance along the central line of wells in the Control and Test Plots, respectively, at five sampling events. Because the Buscheck and Alcantar method is based on the assumption that the plume is at steady-state, only data from the last five sampling events (where approximately steady-state concentrations are observed across both plots) is used.

To calculate the first-order rate constant, chemical velocity and dispersivity need to be estimated. Using the groundwater elevation maps to calculate the hydraulic gradient, and assuming an average hydraulic conductivity of 200 ft/day, the average groundwater pore velocity in the Test and Control Plots were calculated for each sampling event (see Table 12 below). Because the aquifer is relatively sandy, and because MTBE generally does not sorb onto sand, the velocity at which MTBE travels is assumed to equal the groundwater velocity. Finally, the longitudinal dispersivity for this aquifer is assumed to be 2/ft (oil x plot length; Freeze and Cherry, 1979). The calculated MTBE rates for the last five sampling events are summarized in the table below.

The average calculated half-life for MTBE in the Test Plot is approximately 4 times larger than that in the Control Plot. However, reductions in MTBE concentrations in the Test Plot were more consistent than those in the Control Plot. The regression parameter, R^2 , for the Test Plot ranged between 0.54 and 0.87. For the Control Plot, R^2 ranged between 0.09 and 0.96. During the last five sampling events, MTBE concentrations measured in the last monitoring well in the Test Plot were generally equal to or less than concentrations measured in the other monitoring wells (Figure 21). In the Control Plot, the last monitoring well was consistently higher than the other monitoring wells (Figure 22).

Comparison of the MTBE degradation rates between the plots in this demonstration may be misleading and they should not be considered definitive. MTBE concentrations entering the plots decreased during the treatment period, but they were always greater in the Control plot. As with any degradative system that appears to follow first order kinetics, higher degradation rates are expected at higher contaminant concentrations. Thus, higher degradation rates would be expected in the Control Plot. Similarly, the calculations used to estimate in situ degradation rates in this studies are dependent on groundwater flow velocity. Results of groundwater elevation measurements during the study, and tracer test results, clearly demonstrate significant flow variation both spatially and with time. In fact, groundwater elevation measurements suggested that flow in the Test Plot may have reversed at times during the treatment period, demonstrating that the calculated rates can not be exact. Furthermore, it is unlikely that the addition of propane significantly slowed degradation of MTBE in the Test Plot, or that propane degraders degraded MTBE more slowly than the native MTBE degraders. During this demonstration, efforts were

made to ensure that propane concentrations remained at or near the limit of their detection to minimize competitive inhibition, and laboratory studies with pure cultures suggest that propanotrophs degrade MTBE (Steffan et al., 1997) at rates comparable to those achieved with organisms that grow on MTBE as a carbon source (Hanson et al., 1999; Hatzinger et al., 2001).

Table 12. Biodegradation Rate Calculations

Date	Fitted m (1/ft)		Gradient (ft/ft)		Velocity (ft/day)		λ (λ day)		Half life (day)	
	Test	Control	Test	Control	Test	Control	Test	Control	Test	Control
11/28/01	0.052	0.071	0.003	0.010	1.714	5.714	0.390	1.853	1.776	0.374
12/18/01	0.062	0.135	0.003	0.010	1.714	5.714	0.480	3.919	1.445	0.177
1/14/02	0.071	--	0.005	0.012	2.857	6.857	0.927	--	0.748	--
2/20/02	0.104	0.055	--	0.007	--	4.171	--	1.019	--	0.680
3/11/02	0.084	0.053	0.005	0.075	2.857	42.857	1.114	10.049	0.622	0.069
Average	0.074	0.079	0.004	0.023	2.286	13.063	0.728	4.210	1.148	0.325

- Notes:
- 1) Fitted m values were obtained from Figures 21 and 22 for the Test and Control Plots, respectively.
 - 2) dispersivity, α_s , was assumed to be 2/ft (approximately 0.1 the length of the plots).
 - 3) gradients were calculated from the individual groundwater contour maps for each date.
 - 4) for 1/14/02 in the Control Plot, the fitted m value was positive (because concentrations increased with distance), thus no rate was calculated for this date.
 - 5) for 2/20/02 in the Test Plot, the groundwater gradient was reversed, thus no rate was calculated.

Based on Figures 21 and 22, it is evident that most of the MTBE is consumed between the upgradient well and the first row of monitoring wells. In both plots, MTBE concentrations decreased by 5 or 6 fold across the bioreactive zone. Little or no reduction in MTBE concentrations was observed between the first and last rows of monitoring wells in the Test Plot, whereas concentrations increased across the monitoring network of the Control Plot (Figures 21 and 22). MTBE concentrations leaving the Test Plot (i.e., measured in the last row of monitoring wells) after the November, 2001 sampling event were less than 100 $\mu\text{g/L}$. On the other hand, MTBE concentrations leaving the Control Plot during the same period ranged from 1000 to 3,500 $\mu\text{g/L}$. This difference between the Plots is likely due to differences in the MTBE concentration upgradient of each plot. Based on these results, it is expected that non-detection levels of MTBE in the aquifer can be achieved by increasing the length of the bioreactive zone through which groundwater must travel.

Figure 21 - Biodegradation Rates in the Test Plot
MTBE In Situ Biostimulation Demonstration
Port Hueneme, CA
Envirogen Project No. 92132

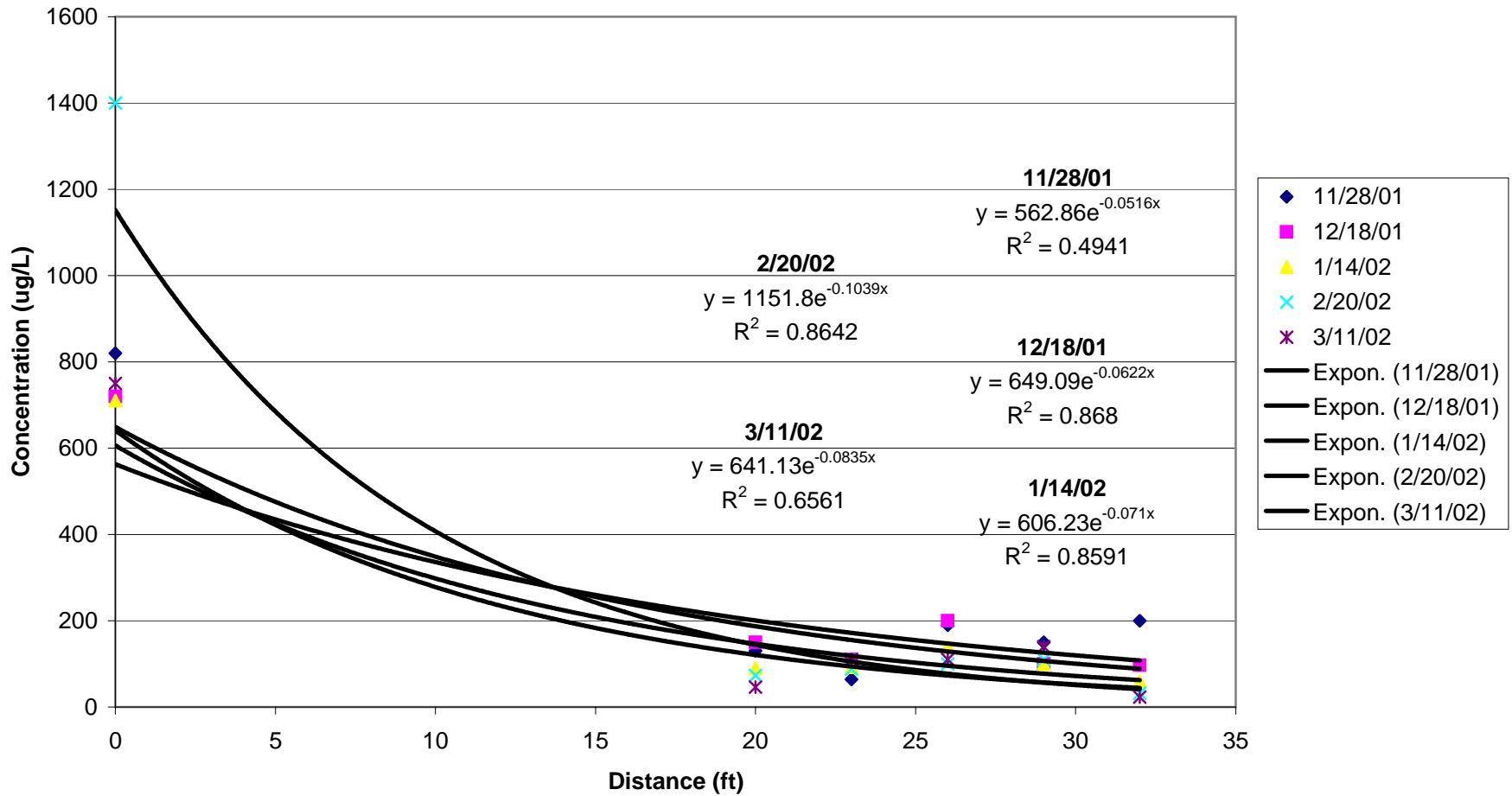
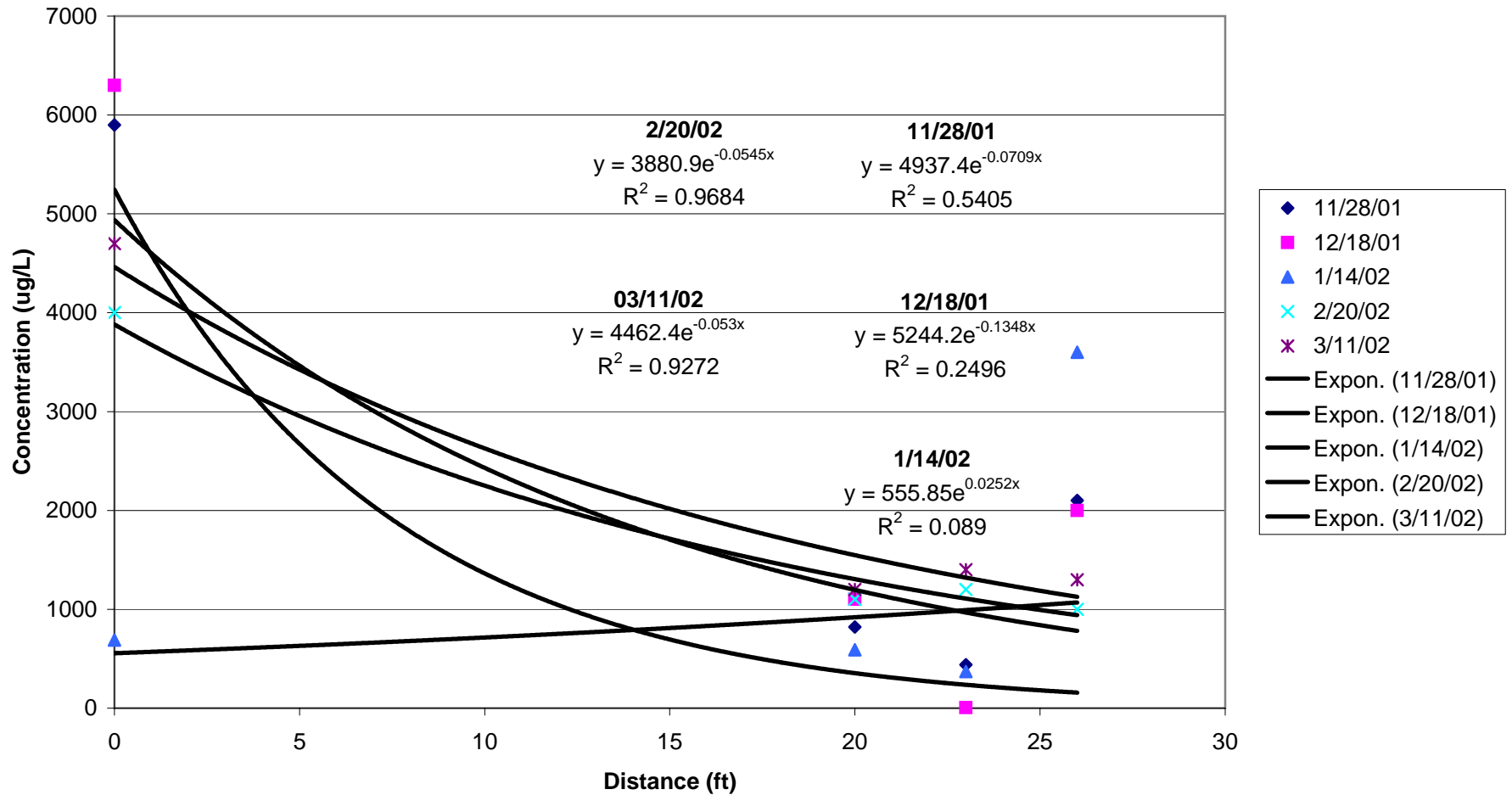

Figure 22 - Biodegradation Rates in the Control Plot
MTBE In Situ Biostimulation Demonstration
Port Hueneme, CA
Envirogen Project No. 92132



4.2.6 SUMMARY AND CONCLUSION

The Port Hueneme NETTS site has been the site of a series of field-scale demonstrations of MTBE biotreatment technologies. In each study, microcosm testing was performed to evaluate treatment conditions, to assess MTBE degradation by indigenous microbial populations, and to identify non-biological degradation mechanisms. In our microcosm study, aquifer microcosms containing sediments and groundwater were amended with oxygen or oxygen and propane. With both treatments MTBE concentrations decreased slowly during approximately 70 days of incubation (Figure 5). These results suggested that indigenous MTBE degraders are present in the aquifer, but that active and efficient in situ MTBE degradation activity would likely develop only after more than 2 months of treatment. Conversely, if the microcosms were seeded with a propane oxidizing microbe like *R. ruber* ENV425 (Steffan et al., 1997), MTBE degradation occurred rapidly, and was active during many weeks of incubation (Figure 6). Salanitro et al. (2000) and Hristova and colleagues (2001) had similar results. In the Salanitro study, some MTBE degradation occurred in oxygen-amended microcosms during 9 weeks of incubation, but degradation activity was much greater in microcosms inoculated with an MTBE-degrading consortium. In the Hristova study rapid MTBE degradation was observed in Port Hueneme groundwater inoculated with an MTBE degrading culture, and the organisms were able to grow on MTBE in the aquifer samples. In other related work, Hartzell and colleagues (2001) evaluated stimulation of MTBE biodegradation in Port Hueneme aquifer samples by adding propane or butane to groundwater microcosms. They observed a lag period of approximately 50 days before observing noticeable MTBE degradation in microcosms treated with or without alkane addition. Remarkably, propane degradation appeared to occur at approximately the same time and rate as MTBE degradation, rather than propane being preferentially degraded before MTBE. The authors concluded that propane addition did not enhance MTBE degradation in the samples, but the simplicity of the experiments performed and the fact that the microcosms apparently were continually spiked with alkanes may have limited observations of long-term enhancement of MTBE degradation. The authors also concluded that the addition of nitrate enhanced MTBE and propane biodegradation in the Port Hueneme samples, but the addition of nitrate to the Port Hueneme aquifer may raise regulatory concerns.

In this microcosm study, microcosms were used to select the appropriate treatment approach for the Port Hueneme site. Our microcosm data, and the others described, indicated the indigenous MTBE degraders occurred in the aquifer and that their activity could be enhanced by oxygen addition. Even though this activity exists at the site and the aquifer is shallow and sandy and likely supplied with oxygen through rain events, the MTBE plume is very large and apparently expanding. This suggests that MTBE degradation by indigenous organisms may be ineffective over the long term. Thus, we elected to evaluate enhancing the natural activity at the site by inoculating the aquifer with a small amount of a propane oxidizing bacterium and supporting their degradative activity by adding propane and oxygen. A similar approach had recently proven successful at a New Jersey gasoline station aquifer that was contaminated with high

concentration of MTBE (Steffan et al., 1999 and Vainberg et al., 2002). In that study the incremental additional cost of propane used for biostimulation was so low (~\$250 for 6 months) that it did not impact the total project budget significantly.

Microcosm studies revealed that the addition of 10^8 CFU/mL of ENV421 provided rapid activity in the Port Hueneme samples (Figure 7). Based on our experience with bioaugmentation (Steffan et al., 1999, Johnson et al., 2001) we anticipated that wild-type organisms (i.e., not adhesion deficient strains) because of their adhesive properties would not be widely distributed in the aquifer after injection. Thus, even a relatively small amount of organisms would create a high cell density biobarrier around the injection points. As the organisms grew on the added propane and oxygen, the biobarrier was expected to expand with the groundwater movement. In earlier demonstrations at the site as much as 6000 L of culture was injected into a similarly-sized Test Plot (Salanitro et al., 2000). We, however, elected to inject only approximately 16 L (i.e., 5 gal.) of seed culture (equivalent to 5 L at $\sim 10^{11}$ CFU/mL) into the aquifer. This amount of culture can be produced inexpensively and shipped inexpensively via overnight courier even to remote sites. One potential advantage of adding alkane oxidizing bacteria for remediation rather than cultures that grow on MTBE is that their growth can be maintained by adding sufficient amounts of high-yield substrate. Biomass yields on MTBE are very low (Salanitro et al., 1998), and the amount of substrate reaching the organisms in an aquifer is determined by groundwater flow. Thus, organisms that grow on MTBE could starve in an aquifer if groundwater flow is slow and MTBE concentrations are low. Because addition of propane can be easily regulated to maintain a continuous food source, and because bacterial yields on propane are great (i.e., greater than 50%; Salanitro et al., 1998), biomass levels and MTBE degradation activity should be less dependent on MTBE concentrations and groundwater flow rates. Unfortunately, MTBE degradation in our Control Plot complicated the evaluation of the effectiveness of the MTBE degrading propanotrophs stimulated in this study. At the end of the study, however, we were able to isolate several MTBE-degrading POB from the Test Plot, but none from the Control Plot. This suggests that propanotrophs did play a role in MTBE degradation in the Test Plot. Interestingly, the isolated propanotrophs did not have the same colony morphology and color as ENV425, suggesting that native propanotrophs increased in abundance and/or dominance in the aquifer during the course of the demonstration.

As expected based on microcosm studies and previous demonstrations at the site (Salanitro et al., 2000), MTBE concentrations decreased in both the Test and Control Plots during the demonstration (Table 3 and Figures 17 and 18). In the Test Plot, MTBE concentrations in the first row of deep monitoring wells began to decrease almost immediately after seeding the aquifer with ENV425. The decrease in MTBE was accompanied by a decrease in dissolved oxygen concentration. Some of the corresponding wells in the Control Plot also had fairly rapid decreases in MTBE concentrations after oxygen injection began. For example, MTBE concentrations in the first deep monitoring well in the center of the Control Plot, GWC-3D, decreased from 4300 $\mu\text{g/l}$ on May 21, 2001 to 690 $\mu\text{g/L}$ on June 26, 2001. This apparent

microbial response to oxygen injection is much more rapid than the lag period observed by Salanitro and colleagues (2000), and may reflect further adaptation or growth of an MTBE degrading microbial population in the aquifer since the initiation of the earlier study. During the Salanitro demonstration, MTBE concentrations in shallow wells of the “oxygen only” plot remained approximately the same between days 0 and 129 of the demonstration, and similar changes in MTBE concentrations occurred in the unamended Control Plot. Greater decreases in MTBE occurred in the oxygen only plot between days 129 and 261 in that demonstration. MTBE concentrations in some of their shallow wells decreased to less than 10 µg/L. Decreases in the shallow wells of the unamended plot were less during the same period. Decreases in MTBE also were observed in the deep wells of both the oxygen only and Control Plot. In the oxygen only plot decreases were observed between days 67 and 129, and concentrations continued to decline through day 261. Although MTBE declines were greater than 90%, MTBE concentrations were typically greater than 10 µg/L. MTBE concentrations decreased less in deep wells of the Control Plot that did not receive oxygen.

Similar evidence for the rapid development of MTBE-degrading microbial populations/activity have been reported for sites around the country (Bradley et al, 2001a, 2001b, Wilson et al., 2002), including sites not previously exposed to MTBE (Bradley et al., 2001b). At some of these sites, MTBE degradation occurred without a significant lag period after addition of oxygen, even though the sites had very long MTBE plumes. For example, at Vandenberg Air Force Base, which is located near Port Hueneme, MTBE was degraded in oxygen-amended microcosms with essentially no lag period. Likewise, when oxygen was introduced into a flow cell located in the aquifer, MTBE degradation began almost instantly after the addition of oxygen. If the oxygen was turned off, MTBE degradation ceased, but it resumed when oxygen was again added. All of these studies suggest that MTBE degradation activity is more widely distributed than originally believed, or that MTBE degradation activity increases with extended exposure time like those associated with large plumes. Thus, in some aquifers, like Port Hueneme, the addition of a co-substrate like propane may not be necessary. Conversely, additional treatment such as propane biosparging will clearly be necessary at other sites where an indigenous MTBE degrading population does not exist (see for example, Vainberg et al., 2002).

In the shallow wells of the Control Plot, MTBE concentrations in groundwater entering the plot were approximately 2 mg/L at the beginning of the study (May 1, 2001), but by June 25, 2001 they had declined to approximately 350 µg/L. They continued to decline to only 3 µg/L by the end of the study (March, 11, 2002). MTBE concentration in the upgradient deep monitoring wells decreased from approximately 2400 µg/L at the beginning of the study to approximately 800 µg/L at the end. Some decreases in the upgradient wells of the Control Plot also occurred, but the extent of the decline was not as great as the Test Plot. The reason for these declines is uncertain, but it is possible that oxygen (and possibly propane in the Test Plot) from the injection system infiltrated the upgradient area and stimulated microbial activity. The greatest decreases

in the deep upgradient monitoring well of the Control Plot occurred in January 2002, and this closely followed a period of the greatest oxygen levels measured at this well.

In a related demonstration performed by researchers from Arizona State University (ASU) and others at another location at the site, and simultaneously with our demonstration, MTBE similarly was degraded in all locations of the test area that were amended with oxygen (Bruce et al., 2002). That demonstration was performed a several hundred meters upgradient of our demonstration in an area with greater MTBE and BTEX concentrations. The “biobarrier” treatment system was divided into 7 different treatment areas including a no addition control, air treatment, oxygen treatment, and bioaugmentation treatments, and it was operated for at least 472 days. Demonstration results indicated that MTBE was biodegraded in all parts of the biobarrier to below 5 µg/L during the 472-day treatment. As in our demonstration, differences in the influent MTBE and BTEX concentrations and groundwater flow rates across the barrier made it difficult to calculate meaningful degradation rates or to accurately assess the role of the different treatments (e.g., bioaugmentation, oxygen, air) in the overall remediation success (Cristin Bruce and Karen Miller, personal communication).

Several factors may have played a role in their ability to reach lower levels of MTBE in their biobarrier demonstration relative to our demonstration. First, the region of the aquifer/biobarrier that was treated with only air or oxygen had lower initial MTBE concentrations (approximately 0.005 to 1mg/L) than our test plots (approximately 1 to 5 mg/L). The center region of their test location, which was treated by bioaugmentation, had greater initial concentrations of MTBE (5 to 10 mg/L). Secondly, because their test site was upgradient from ours, their area of the aquifer had been exposed to MTBE for a longer period than our downgradient location. The longer exposure to MTBE may have allowed more time for the development and growth of naturally-occurring MTBE degraders, thereby providing a greater base population that could be stimulated by the addition of oxygen. Additionally, recent research at North Carolina State University has suggested that biodegradation products of BTEX (e.g, short chain fatty acids) can support the growth and activity of MTBE degrading microorganisms, including POB (Michael Hyman, personal communication). Thus, the location of the BTEX plume near the biobarrier may have resulted in a supply of growth substrates that supported the growth of MTBE degraders and the MTBE degradation observed in the biobarrier. Additionally, the biobarrier system used by ASU appeared to supply higher levels of dissolved oxygen than the system used in our demonstration. In the ASU demonstration, oxygen concentrations as great as 20 mg/L were achieved in the subsurface and in some cases oxygen concentrations exceeded 15 mg/l more than 30 feet downgradient of the injection points. During our demonstration, because of restrictions imposed by the USEPA QA/QC requirements as part of the MTBE Treatment Technology Verification Program and concerns about the effect of increased gas flow on groundwater flow rates, our ability to adjust our gas flow rates after beginning the demonstration was limited. As a result, our in situ dissolved oxygen concentrations remained low throughout our demonstration, and the low oxygen may have limited MTBE degradation in situ.

In summary, MTBE was degraded in both our Test and Control plots during our demonstration, but in neither case were the MTBE concentrations maintained at below the desired level of 5 µg/L. Response to oxygen addition in the Control Plot was much more rapid than anticipated based on microcosm studies performed by others, and us, and based on prior and ongoing demonstrations at the site. This high level of activity frustrated analysis of the effect of propane biosparging on MTBE degradation at the site. Likewise, changes in the groundwater flow also made analysis of the data difficult. For example, because degradation rate calculations are dependent on groundwater flow, and because the hydraulic gradient was flat and the flow was low at the site, even small variations in flow could significantly affect degradation rate calculations. Groundwater elevation data even suggested that groundwater flow may have reversed its flow direction periodically during the study, especially in the Test Plot. Furthermore, changes in the MTBE concentration entering the plots, and the high influent concentration in the Control Plot relative to the Test Plot made the comparison of calculated degradation rates between the plots less useful anticipated. Thus, unlike our prior demonstration where the positive effects of propane biosparging were obvious (Steffan et al., in press) the effects are less apparent in these results.

We have demonstrated that propane biosparging can be safely and economically applied at the field scale to promote in situ degradation of MTBE. Application of the technology resulted in no measurable fugitive emissions of propane, and in situ biodegradation maintained propane levels near or below its detection limit in groundwater. Propane costs for the 10-month demonstration were only about \$50/month, indicating that application of this technology costs little more than a traditional air sparging system. Because of low propane emissions, the technology should not require secondary containment systems (e.g., soil vapor extraction) in most cases. Thus, it may be cost effective to incorporate propane biosparging equipment into MTBE remediation designs, even at sites where MTBE biodegradation by indigenous organisms is suspected. If indigenous bacteria prove to be inefficient or ineffective at remediating the site, propane can be injected to enhance activity at minimal additional cost.

Results of this study also demonstrated that most of the active MTBE degradation that occurred in both plots occurred near the oxygen injection points. This limit of degradation activity was probably caused by consumption of the oxygen added to the plot. Oxygen was likely consumed by both geochemical oxygen sinks and biological activity. Because of the process monitoring and technology validation procedures of both Envirogen and the USEPA, we elected not to increase gas flows into the site during this demonstration. To reach even lower MTBE levels, however, either additional rows of oxygen injection points should be used, or oxygen loading rates should be increased.

5.0 COST ASSESSMENT

5.1 COST REPORTING

5.1.1 REPORTED DEMONSTRATION

The actual demonstration costs were estimated based on a review of the billing records from the time of work plan preparation through the completion of the project. The actual demonstration costs are presented in Table 13. The total capital costs were \$122,300 and included mobilization and demobilization, planning and preparation, equipment, start-up and testing, engineering, management support, and travel. Operation and maintenance costs were \$184,650 and included material, equipment rental, utilities, performance testing and analysis, report writing, and other miscellaneous costs. Costs for report revisions not yet completed were estimated. The cost of the treatability studies was approximately \$26,300. The total demonstration costs were estimated at approximately \$333,000. These high costs are in part due to the fact that this was a first-time demonstration of the technology for many of the personnel involved, the distance between the managing office (NJ) and the site (CA), the time taken to prepare the work plan and deal with regulatory considerations, and the frequency of sampling. The delay in permitting of the project and the additional sampling required under the discharge permit also added unexpected cost.

Start-Up Costs

Each of the costs is site-specific and will vary according to the degree of design and installation required. Start-up costs that were evaluated include the following:

- System design and Work Plan preparation;
- Permitting and Regulatory approval;
- Well installation costs including air sparge points and monitoring wells;
- Capital equipment costs including system components and monitoring equipment; and

Well installation costs are not applicable if an existing system (e.g., an air sparge system) is being retrofitted to include propane injection and bioaugmentation. In that case, existing monitoring wells would be used, and existing air sparge points could be used for substrate and bacterial injection. Capital equipment costs for system components associated with retrofitting an existing system are minimal. In any propane biosparging system, very little propane is required, with typical feed rates of less than 0.3 pounds of propane per day. When coupled with air or oxygen injection, the need for vapor extraction is typically eliminated, although the need for this contingency is site-specific. If a vapor extraction system is required, the cost for a standard SVE system would apply.

Operation and Maintenance Costs

Operation and maintenance costs were based on typical monitoring requirements including:

- Personnel training required to operate, maintain and monitor the system;
- Analytical costs;
- Routine maintenance;
- Waste handling and disposal;
- Utilities;

Performance testing and analysis represented almost 50 percent of the O&M costs for this demonstration. This task included sampling and analysis, data analysis and data management. The need for monthly sampling during the demonstration and the requirement to sample for

TABLE 13
ACTUAL DEMONSTRATION COSTS
ESTCP Propane Biosparging Final Report

CAPITAL COSTS		
1	Mobilization/Demobilization	\$ 12,820
2	Planning/Preparation (Labor)	\$ 34,994
3	Equipment Cost	\$ 21,597
4	Startup and Testing	\$ 15,898
5	Engineering	\$ 16,440
6	Management Support	\$ 5,404
7	Travel	\$ 15,157
	Sub-Total (\$)	\$ 122,311
OPERATION AND MAINTENANCE COSTS		
1	Labor	\$ 12,054
2	Materials and Consumables (inc. propane)	\$ 9,736
3	Utilities	\$ 649
4	Equipment Rental (GW collection and monitoring)	\$ 18,620
5	Performance Testing/Analysis *	\$ 86,988
6	Shipping of GW samples	\$ 9,924
7	Report Writing	\$ 18,785
8	Out-of -house Analytical	\$ 14,873
9	CA State tax on purchases	\$ 2,047
10	Management Support	\$ 10,972
	Sub-Total (\$)	\$ 184,647
OTHER TECHNOLOGY-SPECIFIC COSTS		
1	Treatability Studies	\$ 26,329
	Sub-Total (\$)	\$ 26,329
	TOTAL COSTS (\$)	\$ 333,288

*This cost includes sampling and analysis, data analysis, and data management.

additional parameters required by the California Water Quality Control Board added cost to this task. The cost for this task in a subsequent demonstration or full-scale system would probably be reduced because less frequent and extensive sampling would be required.

No specialized training costs are associated with the operation, maintenance, and monitoring of this type of system. An understanding of system operation and the importance of vapor monitoring results as they apply to fugitive VOC and propane emissions is required. Analytical costs for MTBE analysis would not increase for the typical site at which regular VOC analysis is conducted, as MTBE is included in the standard VOC scan. Additional analytical costs might include analysis for TBA, and possible analysis for dissolved carbon dioxide and propane. Bacterial analyses may be required or desired at some sites, with an associated additional cost, particularly at sites where bioaugmentation is performed. Routine system maintenance, including maintenance to prevent silting and clogging of wells, is similar to that required for a typical air sparge system at a comparable cost. The labor costs for sampling and monitoring activities would be slightly higher than those for a standard monitoring program, because low-flow groundwater sampling methods would be employed.

Demobilization

Demobilization costs were minimal in this study and are anticipated to be minimal at full-scale. Elements of demobilization could include the following:

- Labor associated with equipment decommissioning and removal;
- Demobilization of staff;
- Subcontractor costs associated with abandonment of demonstration wells;
- Removal of above-grade distributions lines and equipment; and
- Site restoration.

Equipment decommissioning and removal and demobilization of staff were accomplished in this study in one and one half days, and would not be expected to exceed 3 days at the full scale.

Treatability Study Costs

In many cases, treatability studies will be required or advised prior to implementing the technology at a particular site. A treatability study whose purpose is to evaluate the efficacy of the technology on soil and groundwater from a specific site can typically be completed for \$30,000. Treatability study costs for this demonstration were approximately \$26,300.

5.2 COST ANALYSIS

Overall life cycle costs for a propane biosparging system are expected to be comparable to the life cycle costs for a typical air sparge system, with the exception of minimal additional costs for propane, and for bioaugmentation if needed.

Liability costs are expected to be lower for propane biosparging technology than for alternate technologies. This is because alternate technologies, such as air stripping and carbon adsorption, simply transfer contaminant from the aqueous phase to the solid phase. The solid phase must then be treated and/or disposed of, raising waste handling and liability costs. Successful propane biosparging, on the other hand, results in complete destruction of the MTBE and TBA molecules, reducing or eliminating associated waste handling and liability costs.

The treatment efficiency of a propane biosparging system is expected to be greater than the efficiency of alternate technologies. This increased efficiency could result in significant cost savings in the long term. Historically, the most common treatment technology for groundwater contamination has been a pump-and-treat approach. Because of the high aqueous solubility of MTBE, its low Henry's Law Constant (low volatility from water) and poor adsorption to carbon, the usual *ex situ* treatment techniques designed for contaminants such as benzene and trichloroethylene have proven ineffective for removal of MTBE from groundwater. Despite poor removal, air stripping is often considered to be the most effective and economical method for remediating MTBE-contaminated groundwater (Keller et al., 1998). The use of air stripping and carbon adsorption is even less useful in regions of the country where TBA levels in groundwater are regulated, because TBA strips more poorly than MTBE, and it has a lower affinity for activated carbon.

The following sections present a cost comparison between propane biosparging, pump-and-treat, and combined air sparging and soil vapor extraction (AS/SVE) for the remediation of MTBE-contaminated groundwater at a typical gas station. The following assumptions are made for the gas station remediation:

- The service station area is 100 ft. x 60 ft. with the remediation area measuring 60 ft. x 60 ft.
- The subsurface soil is a medium sand with a porosity of 0.3 and the depth to groundwater is 10 ft. below grade (bg).
- The vertical extent of the groundwater contamination is 10 ft. below the groundwater. Thus, the volume of groundwater to be treated is 81,000 gal. (60' x 60' x 10' x 0.3 porosity x 7.5 gal/cubic foot). The volume of saturated soil that is contaminated is 1,330 yd³ (60' x 60' x 10' x cubic yard/27 cubic feet).
- The BTEX/MTBE concentration in the groundwater in the source area is 60 ppm with the maximum contaminant being MTBE.

5.2.1 COST ESTIMATE FOR PROPANE BIOSPARGING

The following assumptions are made for the installation and O&M of the biosparging system:

- 3 air sparging / propane injection points installed to 10 ft. below groundwater
- 4 monitoring wells installed to 10 ft. below groundwater.
- 4 vapor monitoring points installed to 1 ft. above groundwater.
- Estimated 70 ft. of piping to injection points installed below grade.

- Biosparging system trailer with air sparging blower, propane tank, piping, instrumentation and control panel.

In the full-scale system presented here, air and propane would be injected into the same sparging points. This combined injection configuration has been safely used at other sites during previous demonstrations of this technology (Steffan et al., in press). In the demonstration at Port Hueneme, pure oxygen was injected; therefore, the propane and oxygen were injected into separate points for safety reasons.

In the full-scale system presented here, the air sparging/propane injection points would be oriented in one row perpendicular to groundwater flow to form a “biobarrier”, as in the Port Hueneme demonstration. One groundwater monitoring well would be placed up-gradient of the contaminant plume, and three groundwater monitoring wells would be placed down-gradient.

The tasks for implementing the design, installation, and O&M of the system with a description of the subtasks are the following:

- Design - design of system, preparation of application for Discharge to Groundwater Permit, one meeting.
- Procurement and mobilization – procurement of equipment and materials, preparation for mobilization, and mobilization.
- Installation- installation of AS points, monitoring wells, trenching, pipe installation, backfilling, surface restoration, connection to system, electrical connection, disposal of soils from trench.
- Baseline monitoring – baseline monitoring of VOCs, geochemical, and biological parameters in monitoring wells. Injection of MTBE degrading bacteria and/or buffer solution, if needed.
- Startup – startup of system, three days of startup surveillance and monitoring to maximize performance of the system, and letter report.
- Monitoring – quarterly monitoring of VOCs, geochemical, and biological parameters in monitoring wells. Injection of MTBE degrading bacteria and/or buffer solution if needed. Weekly visits for system inspection and balancing.
- Demobilization – disconnect and dismantle system, remove system from site.
- Final Report – final letter report prepared and submitted to client.

A summary of the costs for the propane biosparging system is presented in Table 14 with a breakdown for labor, pass through, equipment and sub contractors, and materials. The total cost is based on the time needed to remediate the groundwater to a cleanup objective of 70 ppb and estimated from degradation rates from other sites. The time to remediate the groundwater to the cleanup objective is estimated to be two years. Based on a two-year remediation, the total cost for the project is estimated to be \$174,600 +/- 20%. At a volume of contaminated groundwater of 81,000 gallons and volume of contaminated saturated soil of 1,330 cy³, the unit cost to remediate

**TABLE 14
COST DATA TABLE FOR MTBE REMEDIATION WITH BIOSPARGING
PORT HUENEME – ESTCP
ENVIROGEN PROJECT 92132**

ACTIVITY	LABOR	PASS THROUGH	EQUIPMENT SUBS	MATERIALS	SUBTOTAL	NUMBER EVENTS	TOTAL	TOTAL ROUNDED
DESIGN	\$21,700	\$ -	\$ -	\$ -	\$21,700	1	\$21,700	\$21,700
PROCUREMENT AND MOBILIZATION	\$19,540	\$ 120	\$ 2,625	\$ -	\$22,285	1	\$22,285	\$22,300
INSTALL	\$31,660	\$ 1,350	\$ 13,382	\$ 787	\$47,179	1	\$47,179	\$47,200
BASELINE MONITORING	\$ 1,400	\$ 1,550	\$ 1,208	\$ -	\$ 4,158	1	\$ 4,158	\$ 4,200
STARTUP	\$ 4,360	\$ 480	\$ -	\$ -	\$ 4,840	1	\$ 4,840	\$ 4,800
O&M AND QUARTERLY MONITORING	\$ 6,135	\$ 2,005	\$ 53	\$ 28	\$ 8,220	8	\$65,760	\$65,800
UTILITIES (ELECTRIC AND PROPANE) PER QTR.		\$ 430			\$ 430	8	\$ 3,440	\$ 3,400
DEMOB	\$ 3,325	\$ 300	\$ -	\$ -	\$ 3,625	1	\$ 3,625	\$ 3,600
FINAL REPORT	\$ 1,605	\$ -	\$ -	\$ -	\$ 1,605	1	\$ 1,605	\$ 1,600
							\$171,591	\$174,600

NOTE:

1. DESIGN INCLUDES DESIGN AND DRAWINGS, DISCHARGE PERMIT APPLICATION, ONE MEETING
2. PROCUREMENT INCLUDES PREPARATION FOR MOB AND MOBILIZATION
3. INSTALLATION INCLUDES LABOR, MATERIALS, EQUIPMENT, SITE WORK SUB, ELECTRICAL SUB, DRILLER, DISPOSAL OF SOIL
4. BASELINE MONITORING INCLUDES SAMPLING 4 WELLS AND VOC ANALYSES
5. STARTUP IS THREE DAYS, MONITORING, AND LETTER REPORT
6. QUARTERLY MONITORING AND LETTER REPORT
7. DEMOB INCLUDES DISMANTLING OF EQUIPMENT

TOTAL PRICE FOR SITE REMEDIATION IS BASED ON 2 YEARS OF OPERATION.

these media are \$2.15/gal and \$131/cy³, respectively. Furthermore, the propane injection trailer is suitable for use at other sites.

The following assumptions were made for the cost estimate:

- The AS system will operate four times a day at 0.5 hour each time for a total operating time of 2 hours/day.
- The site is near Envirogen's office and per diems are not needed.
- If a bacterial injection is needed, the additional cost is \$1,000 per event.
- The biosparging system will be leased to the project.

5.2.2 COST ESTIMATE FOR PUMP AND TREAT

The following assumptions are made for the installation and O&M of the pump-and -treat system:

- 2 groundwater extraction wells installed to 10 ft. below groundwater with submersible pumps and controls.
- 4 monitoring wells installed to 10 ft. below groundwater.
- Estimated 150 ft. of piping to groundwater extraction wells installed below grade with conduit and wire to each pump from control panel at system enclosure.
- Groundwater treatment system in enclosure with two 1,000 lb. liquid phase granular activated carbon (LPGAC) adsorbers in series with connecting piping, valves, meter, and discharge to sewer or surface water, air sparging blower, propane tank, piping, instrumentation and control panel.
- Using a VOC concentration of 60 ppm, a volume of 81,000 gallons of groundwater to be treated, and a loading of 1%, a total of 4,000 lbs. of LPGAC is needed.

The tasks for implementing the design, installation, and O&M of the system with a description of the subtasks are the following:

- Design - design of system, preparation of application for Discharge to Groundwater Permit or Sewer Use Permit, one meeting.
- Procurement and mobilization – procurement of equipment and materials, preparation for mobilization, and mobilization.
- Installation- installation of groundwater extraction wells, monitoring wells, trenching, pipe installation, backfilling, surface restoration, connection to system, electrical connection, disposal of soils from trench.
- Baseline monitoring – baseline monitoring of VOCs.
- Startup – startup of system, three days of startup surveillance and monitoring to maximize performance of the system, and letter report.

- Monitoring – quarterly monitoring of VOCs. Weekly visits for system inspection and balancing.
- Demobilization – disconnect and dismantle system, remove system from site.
- Final Report – final letter report prepared and submitted to client.

A summary of the costs for the pump-and treat system is presented in Table 15 with a breakdown for labor, pass through, equipment and sub contractors, and materials. The total cost is based on the time needed to remediate the groundwater to a typical cleanup objective (70 ppb) and estimated to be 10 years (based on experience from other sites, the use of pump-and-treat systems typically requires 10 to 30 years to attain cleanup objectives). The time to remediate the groundwater to the cleanup objective for this project is assumed to be ten years. Based on a ten-year remediation, the total cost for the project is estimated to be \$518,600 +/- 20%. At a volume of contaminated groundwater of 81,000 gallons and volume of contaminated saturated soil of 1,330 yd³, the unit cost to remediate these media are \$.6.40/gal and \$390/ yd³, respectively.

The following assumptions were made for the cost estimate:

- The pump-and –treat system will operate continuously for 24 hours/day.
- The site is near Envirogen’s office and per diems are not needed.

**TABLE 15
COST DATA TABLE FOR MTBE REMEDIATION WITH PUMP AND TREAT
PORT HUENEME – ESTCP
ENVIROGEN PROJECT 92132**

ACTIVITY	LABOR	PASS THROUGH	EQUIPMENT SUBS	MATERIALS	SUBTOTAL	NUMBER EVENTS	TOTAL	TOTAL ROUNDED
DESIGN	\$21,700	\$ -	\$ -	\$ -	\$21,700	1	\$ 21,700	\$ 21,700
PROCUREMENT AND MOBILIZATION	\$19,540	\$ 120	\$ 2,625	\$ -	\$22,285	1	\$ 22,285	\$ 22,300
INSTALL	\$29,860	\$ 1,850	\$ 21,956	\$ 385	\$54,051	1	\$ 54,051	\$ 54,100
BASELINE MONITORING	\$ 1,400	\$ 1,250	\$ 79	\$ -	\$ 2,729	1	\$ 2,729	\$ 2,700
STARTUP	\$ 4,360	\$ 480	\$ -	\$ -	\$ 4,840	1	\$ 4,840	\$ 4,800
O&M AND QUARTERLY MONITORING	\$ 6,135	\$ 2,885	\$ 79	\$ -	\$ 9,099	8	\$363,950	\$364,000
UTILITIES (ELECTRIC) PER QTR.		\$ 970			\$ 970	8	\$ 38,800	\$ 38,800
ADDITIONAL LPGAC		\$ 5,000			\$ 5,000		\$ 5,000	
DEMOB	\$ 3,325	\$ 150	\$ 210	\$ -	\$ 3,685	1	\$ 3,685	\$ 5,000
FINAL REPORT	\$ 1,605	\$ -	\$ -	\$ -	\$ 1,605	1	\$ 1,605	\$ 3,700
							\$518,644	\$518,600

NOTE:

1. DESIGN INCLUDES DESIGN AND DRAWINGS, DISCHARGE PERMIT APPLICATION, ONE MEETING
2. PROCUREMENT INCLUDES PREPARATION FOR MOB AND MOBILIZATION
3. INSTALLATION INCLUDES LABOR, MATERIALS, EQUIPMENT, SITE WORK SUB, ELECTRICAL SUB, DRILLER, DISPOSAL OF SOIL
4. BASELINE MONITORING INCLUDES SAMPLING 4 WELLS AND VOC ANALYSES, INJECTION OF BUFFER SOLUTION
5. STARTUP IS THREE DAYS, MONITORING, REPORT
6. QUARTERLY MONITORING INCLUDES REPORT
7. DEMOB INCLUDES DISMANTLING OF EQUIPMENT

TOTAL PRICE FOR SITE REMEDIATION IS BASED ON 10 YEARS OF OPERATION.

5.2.3 COST ESTIMATE FOR COMBINED AIR SPARGING/SOIL VAPOR EXTRACTION

The installation and O&M of a combined air sparging/soil vapor extraction system (AS/SVE) is based on the following:

- Using a radius of influence for air sparging of 10 feet, 9 AS points will be installed to 10 ft. below groundwater.
- Using a radius of influence for SVE, 1 SVE well will be installed to 9 feet bg (1 foot above the groundwater) with 7 feet of screen.
- 4 monitoring wells installed to 10 ft. below groundwater.
- Estimated 180 ft. of trench for piping to AS points and the SVE well. All piping is installed below grade.
- 5 hp SVE blower with inlet filter, outlet silencer, control panel, air/water separator, and instrumentation.
- 5 hp AS blower with filter, control panel, and instrumentation.
- 4- 1000 lb. vapor phase granular activated carbon (VPGAC) adsorbers for the treatment of the extracted vapors. Two adsorbers will be on-line and replaced as needed.
- 2- 200 lb. liquid phase granular activated carbon (LPGAC) adsorbers for the treatment of condensate.
- One 10' x 20' equipment building with insulation. Although the building will be heated by the blowers, a small space heater is required to prevent freezing in the air/water separator, VPGAC, LPGAC, and condensate holding tank if there is a system shut down or extended period for maintenance. No air conditioning is needed and only vents will be used for cooling.

The tasks for implementing the design, installation, and O&M of the system with a description of the subtasks are the following:

- Design - design of system, preparation of application for building permit (if needed), and one meeting.
- Procurement and mobilization – procurement of equipment and materials, preparation for mobilization, and mobilization.
- Installation- installation of AS points, SVE well, monitoring wells, trenching, pipe installation, backfilling, surface restoration, connection to system, electrical connection, disposal of soils from trench.
- Baseline monitoring – baseline monitoring of VOCs in monitoring wells.
- Startup – startup of system, three days of startup surveillance and monitoring to maximize performance of the system, and letter report.
- Monitoring – monthly visits for system monitoring, quarterly monitoring of VOCs in monitoring wells.
- Demobilization – disconnect and dismantle system, remove system from site.

- Final Report – final letter report prepared and submitted to client.

A summary of the costs for the AS/SVE system is presented in Table 16 with a breakdown for labor, pass throughs, equipment and sub contractors, and materials. The total cost is based on the time needed to remediate the groundwater to a typical cleanup objective (70 ppb). The time to remediate the groundwater to the cleanup objective is estimated to be two years. Based on a two year remediation, the total cost for the project is estimated to be \$189,600 +/- 20%. At a volume of contaminated groundwater of 81,000 gallons and volume of contaminated saturated soil of 1,330 cy³, the unit cost to remediate these media are \$2.34/gal and \$143/cy³, respectively.

The following assumptions were made for the cost estimate:

- The SVE system will operate continuously while the AS system will be pulsed to operate 50% of the time.
- The site is near Envirogen's office and per diems are not needed.
- The AS/SVE system equipment will be purchased for the project.

5.2.4 COST COMPARISON OF TECHNOLOGIES

A comparison of the costs for propane biosparging vs. pump-and-treat and AS/SVE indicates that propane biosparging is slightly more cost effective than AS/SVE and significantly more cost effective than pump-and-treat. Propane biosparging is more cost effective than AS/SVE since more treatment equipment is needed for the AS/SVE system, and this system will require an enclosure for noise reduction and winterization of the air/water separator, VPGAC adsorbers, LPGAC adsorbers, and condensate holding tank. Propane biosparging is significantly more cost effective than pump-and-treat because a much longer time is expected to be required using pump and treat than would be required using propane biosparging (10 years vs. 2 years) to meet the same treatment objective. The increased time needed for operation of the system to attain the cleanup objective and the associated increased number of monitoring events add significant cost.

**TABLE 16
COST DATA TABLE FOR MTBE REMEDIATION WITH AS/SVE
PORT HUENEME – ESTCP
ENVIROGEN PROJECT 92132**

ACTIVITY	LABOR	PASS THROUGH	EQUIPMENT SUBS	MATERIALS	SUBTOTAL	NUMBER EVENTS	TOTAL	TOTAL ROUNDED
DESIGN	\$15,135	\$ -	\$ -	\$ -	\$ 15,135	1	\$ 15,135	\$ 15,100
PROCUREMENT AND MOBILIZATION	\$19,540	\$ 120	\$ 2,625	\$ -	\$ 22,285	1	\$ 22,285	\$ 22,300
INSTALL	\$31,660	\$ 1,350	\$ 34,283	\$ 1,698	\$ 68,991	1	\$ 68,991	\$ 69,000
BASELINE MONITORING	\$ 1,400	\$ 1,550	\$ 158	\$ -	\$ 3,108	1	\$ 3,108	\$ 3,100
STARTUP	\$ 4,360	\$ 480	\$ -	\$ -	\$ 4,840	1	\$ 4,840	\$ 4,800
O&M AND QUARTERLY MONITORING	\$ 6,135	\$ 1,055	\$ 53	\$ 28	\$ 7,270	8	\$ 58,160	\$ 58,200
UTILITIES (ELECTRIC AND PROPANE) PER QTR.		\$ 600			\$ 600	8	\$ 4,800	\$ 4,800
DEMOB	\$ 8,765	\$ 450	\$ 1,418	\$ -	\$ 10,633	1	\$ 10,633	\$ 10,600
FINAL REPORT	\$ 1,605	\$ -	\$ -	\$ -	\$ 1,605	1	\$ 1,605	\$ 1,600
							\$ 189,556	\$189,600

NOTE:

1. DESIGN INCLUDES DESIGN AND DRAWINGS, ONE MEETING
2. PROCUREMENT INCLUDES PREPARATION FOR MOB AND MOBILIZATION
3. INSTALLATION INCLUDES LABOR, MATERIALS, EQUIPMENT, SITE WORK SUB, ELECTRICAL SUB, DRILLER, DISPOSAL OF SOIL
4. BASELINE MONITORING INCLUDES SAMPLING 4 WELLS AND VOC ANALYSES.
5. STARTUP IS THREE DAYS, MONITORING, AND LETTER REPORT
6. MONTHLY O&M, QUARTERLY MONITORING AT MWS, AND QUARTERLY LETTER REPORT
7. DEMOB INCLUDES DISMANTLING OF EQUIPMENT

TOTAL PRICE FOR SITE REMEDIATION IS BASED ON 2 YEARS OF OPERATION.

6. IMPLEMENTATION ISSUES

6.1 ENVIRONMENTAL CHECKLIST

Application of propane biosparging generates few waste materials that require handling and disposal, with the exception soil cuttings generated during installation of the demonstration injection points, monitoring wells, and vapor monitoring points, and groundwater derived from sampling during the demonstration. Depending on various states requirements, application of the technology may require air emissions controls, especially if propane biosparging is combined with soil vapor extraction.

6.2 OTHER REGULATORY ISSUES

The regulations applicable to implementation of this technology depend on site-specific remediation logistics and the type of contaminated liquid being treatment. In most cases, state and local environmental regulations will control application of the technology. As such, application regulations are likely to vary widely throughout the country. At some sites, however, application of the technology may be regulated under federal law including the Comprehensive Environmental Response, Compensation, and Liability Act (CERCLA; aka, Superfund) and the Resource Conservation and Recovery Act (RCRA) regulations, depending on other circumstances and/or contaminants at the site.

Some sites, depending on the aquifer involved, may be regulated under the the Safe Drinking Water Act (SDW A) of 1974, as most recently amended by the Safe Drinking Water Amendments of 1986. These regulations require EPA to establish regulations to protect human health from contaminants in drinking water. EPA has developed a drinking water standards program, an underground injection control program, and a sole-source aquifer and well-head protection programs under SDWA. SDWA primary (or health-based) and secondary (or aesthetic) MCLs generally apply as clean-up standards for water that is, or may be, used as drinking water. In some cases, such as when multiple contaminants are present, more stringent maximum contaminant level goals (MCLG) may be appropriate. In other cases, alternate concentration limits (ACL) based on site-specific conditions may be applied.

Water discharge through injection wells is regulated by the underground injection control program. Injection wells are categorized as Classes I through V, depending on their construction and use. Reinjection of treated water involves Class IV (reinjection) or class V (recharge) wells and should meet SDWA requirements for well construction, operation, and closure. If the groundwater treated is a RCRA hazardous waste, the treated groundwater must meet RCRA Land Disposal Restriction (LDR) treatment standards (40 CFR Part 268) before reinjection.

The sole-source aquifer and well-head protection programs are designed to protect specific drinking water supply sources. If such a source is to be remediated using propane biosparging,

appropriate program officials should be notified, and any potential regulatory requirements should be identified. State groundwater antidegradation requirements and (WQSS) may also apply.

Occupational Safety and Health Administration (OSHA) regulations in 29 CFR Parts 1900 through 1926 are designed to protect worker health and safety. Both Superfund and RCRA corrective actions must meet OSHA requirements, particularly §1910.120 that describes safety and health regulations for construction sites. On-site construction activities at Superfund or RCRA corrective action sites must be performed in accordance with 1926 of OSHA, which describes safety and health regulations for construction sites. For example, electric utility hookups for the propane biosparging system must comply with Part 1926, Subpart K, Electrical. Likewise, application of the technology requires meeting OSHA requirements for working with flammable gasses (for example, Part 1926, Subpart D, Occupational Health and Environmental Controls and Subpart H, Materials Handling, Storage, and Disposal). Also, all technicians operating the propane biosparging system and performing on-site work must have completed OSHA training course and must be familiar with all OSHA requirements relevant to hazardous waste sites. Thus, health and safety plans for site remediations using this technology should address chemicals of concern and include monitoring practices to ensure that worker health and safety are maintained. Compliance with local (e.g., city, base, fire department, etc.) regulations and codes also is required.

6.3 END-USER ISSUES

In addition to the quality of groundwater entering the system and downgradient discharge requirements, some site characteristics and support requirements may be important when considering the propane biosparging technology. Because the system can be either transportable or permanently installed, the support requirements for these systems are likely to vary.

A primary site requirement is the availability of electricity. For the unit used during the demonstration, a 3-phase, 206V power was utilized. The system controls operated using conditioned power reduced to 24V AC power to the individual timers and solenoid valves, but other power sources can be used as needed by changing system components to meet the available power. At many sites power conditioning will not be required, but historical electrical problems at the Port Heuneme site led to the inclusion of power conditioning to protect the system components from electrical system-related damage or failure. Other utilities required include a small amount of water for cleaning equipment. A fence and/or shed may be utilized to secure the system components, and signage should be utilized to ward of the potential explosion hazard. No smoking should be permitted anywhere on site. If the portable unit is used, the site must be accessible for an 8-foot by 10-foot trailer; approximating the size of a small horse trailer. The area containing the trailer should be paved or covered with compact soil or gravel to prevent the trailer from sinking into soft ground.

Propane biostimulation technology uses commercially available, off-the-shelf components to establish bioreactive treatment zones. Equipment used in the performance and monitoring of the demonstration is available through standard suppliers. The equipment includes compressed gas cylinders to provide the source of propane, and sometimes oxygen, and simple timer-actuated solenoid valves to control flow. Thus, system performance is dictated by the delivery of the gases into solution, and routine monitoring of flow and pressure measurements at the injection points, monitoring of oxygen and propane use, and changing spent gas cylinders is required. If oxygen is supplied with a blower or compressor, routine checks of the airflow rates and blower or compressor operation, and routine blower or compressor maintenance, is required.

Although propane biosparging was used to treat a shallow aquifer during this demonstration, the presence of a deep water table could add to the cost and operating challenges of the technology. Also, as discussed earlier, the system would be less effective in aquifers with low hydraulic conductivities. The type of aquifers for which propane biosparging is most effective include those composed of sand to cobbles and with hydraulic conductivities greater than 10^{-4} cm/sec. The irregular distribution of oxygen and propane caused by heterogeneities could result in zones where little or no treatment can occur. Biochemical factors that must be present include microbes capable of degrading propane, MTBE, and TBA, the availability of nutrients, and a neutral pH.

7.0 REFERENCES

- Acharya, S. K. Mehta, S. Rodriguez, J. Pereira, S. Krishnan, and C.V. Rao. 1997. A histopathological study of liver and kidney in male Wistar rats treated with subtoxic doses of t-butyl alcohol and trichloroacetic acid. *Exp Toxicol Pathol*, 49:369-373.
- American Petroleum Institute. 1991. Chemical fate and impact of oxygenates in groundwater: Solubility of BTEX from gasoline - oxygenate mixtures. Pub. No. 4531.
- Anderson, E. V. 1993. Health studies indicate MTBE is safe gasoline additive. *Chem. Engineer. News* 71:9-18.
- Beckenbach, E.H., and A.M. Happel. 1998. Methyl tertiary butyl ether plume evolution at California LUFT sites. *Proc. Nat. Groundwater Assoc. SW Focused Groundwater Conf.* p. 15. Anaheim, CA. June 3-4.
- Belpoggi, Fiorella, Soffritti, Morando, Maltoni, and Cesare. 1995. Methyl-tertiary-butyl ether (MTBE)-a gasoline additive-causes testicular and lympho-haematopoietic cancer in rats. *Toxicol. Ind. Health* 11:119-149.
- Bernauer, U., A. Amberg, D. Scheutzow, and W. Dekant. 1998. Biotransformation of ¹²C- and ¹³C-labeled methyl tert-butyl ether, ethyl tert-butyl ether, and tert-butyl alcohol in rats: identification of metabolites in urine by ¹³C nuclear magnetic resonance and gas chromatography/mass spectrometry. *Chem Res Toxicol*, 11:651-658.
- Bowman, J. B., L. Jimenez, I. Rosario, T.C. Hazen, and G. S. Saylor. Characterization of the methanotrophic bacterial community in a trichloroethylene-contaminated subsurface groundwater site. *Appl. Environ. Microbiol.* 99:2380-2387.
- Bradley, P. M., F. H. Chapelle, and J. E. Landmeyer. 2001a. Effect of redox conditions on MTBE biodegradation in surface water sediments. *Environ. Sci. Technol.* 35:4643-4647.
- Bradley, P. M., J. E. Landmeyer, and F. H. Chapelle. 2001b. Widespread potential for microbial MTBE degradation in surface-water sediments. *Environ. Sci. Technol.* 35:658-662.
- Bruce, C. L., K. D. Miller, and P. C. Johnson. 2002. Full scale bio-barrier demonstration of a mixed MTBE.TBA/BTEX plume at Port Hueneme. *Contam. Soil Sediment Water* July/August: 80-84.
- Burleigh-Flayer, H. D., J. S. Chun, W. J. Kintigh. 1992. Methyl tertiary butyl ether: vapor inhalation oncogenicity study in CD-1 mice. Union Carbide Bushy Run Research Center, Export PA, October 15.
- Buscheck, T.E., 1998. Occurrence and behavior of MTBE in groundwater. *Proc. Nat. Groundwater Assoc. SW Focused Groundwater Conf.* pp. 2-3. Anaheim, CA. June 3-4.
- Buscheck, T. E. and C. M. Alcantar. 1995. Regression techniques and analytical solutions to demonstrate intrinsic bioremediation. In: *Intrinsic Bioremediation*. Pp. 109-116. R. E. Hinchee, J. T. Wilson, and D. C. Downey (eds.), Battelle Press, Columbus, OH.
- California Department of Health Services Website. <http://www.dhs.ca.gov/ps/ddwem/chemicals/AL/actionlevels>.
- Cirvello, J. D., A. Radovsky, J. E. Heath, D. R. Farnell and C. Lindamood, 3rd. 1995. Toxicity and carcinogenicity of t-butyl alcohol in rats and mice following chronic exposure in drinking water. *Toxicol Ind Health*, 11:151-165.

- Cowan, R.M., and K. Park. 1996. Biodegradation of the gasoline oxygenates MTBE, ETBE, TAME, TBA, and TAA by aerobic mixed cultures. Proc. 28th Mid-Atlantic Ind. Haz. Waste Conf., July, pp. 523-530.
- ESTCP. April 15, 1996. Final Report Guidelines for Funded Projects. www.estcp.org.
- Fortin, N. Y. and M. A. Deshusses. 1999a. Treatment of methyl *tert*-butyl ether vapors in biotrickling filters. 1. Reactor startup, steady-state performance, and culture characteristics. Environ. Sci. Technol. 33:2980-2986.
- Fortin, N. Y. and M. A. Deshusses. 1999b. Treatment of methyl *tert*-butyl ether vapors in biotrickling filters. 2. Analysis of the rate limiting step and behavior under transient conditions. Environ. Sci. Technol. 33:2987-2991.
- Francois, A., H. Mathis, D. Godefroy, P. Piveteau, F. Fayolle, and F. Monot. 2002. Biodegradation of methyl *tert*-butyl ether and other fuel oxygenates by a new strain, mycobacterium austroafricanum IFP 2012. Appl. Environ. Microbiol. 68:2754-2762.
- Freeze, R. A., and J. A. Cherry. 1979. In: *Groundwater*. Prentice-Hall, Inc. (pub.), Englewood Cliffs, NJ.
- Garnier, P. M., R. Auria, C. Augur, and S. Revah. 1999. Cometabolic biodegradation of methyl *t*-butyl ether by *Pseudomonas aeruginosa* grown on pentane. Appl. Microbiol. Biotechnol. 51:498-503.
- Hanson, J. R., C. E. Ackerman, and K. M. Scow. 1999. Biodegradation of methyl *tert*-butyl ether by a bacterial pure culture. Appl Environ Microbiol, 65:4788-4792.
- Hardison, L., L. Ciuffetti, and M. Hyman. 1997. Cometabolic degradation of methyl *tert*-butyl ether (MTBE) by filamentous fungus, *Graphium* sp. after growth on gaseous *n*-alkanes. In: Abstracts for the 97th American Society for Microbiology General Meeting, Miami Beach, FL, Abstract #Q-371.
- Hartzell, K. E., V. S. Magar, J. T. Gibbs, E. A. Foote, and C. D. Burton. Bioremediation of MTBE through aerobic biodegradation and cometabolism. In: *Bioremediation of MTBE, Alcohols, and Ethers*. pp. 137-143. V. S. Magar, J. T. Gibbs, K. T. O'Reilly, M. R. Hyman, and A. Leeson (eds.), 6th International In Situ and On-Site Bioremediation Symposium, San Diego, CA. June 4-7, 2001.
- Hatzinger, P.B., K. McClay, S. Vainberg, M. Tugusheva, C. W. Condee, and R. J. Steffan. 2001. Biodegradation of methyl *tert*-butyl ether (MTBE) by a pure bacterial culture. Appl. Environ. Microbiol. 67:5601-5607.
- Hazen, T.C. et al. 1994. Summary of *in situ* bioremediation demonstration (methane biostimulation) via horizontal wells at the Savannah River Site Integrated Demonstration Project. In: *In Situ Remediation: Scientific Basis for Current and Future Technologies*, Battelle Press, Richland, WA. pp. 137-150.
- Hernandez-Perez, G., F. Fayelle, J. -P. Vandecasteele. 2001. Biodegradation of ethyl *t*-butyl ether (ETBE), methyl *t*-butyl ether (MTBE) and *t*-amyl methyl ether (TAME) by *Gordonia terrae*. Appl. Microbiol. Biotechnol. 55:117-121.
- Hristova, K. R., C. M. Lutenegger, and K. M. Scow. 2001. Detection and quantification of methyl *tert*-butyl ether-degrading strain PM1 by real-time TaqMan PCR. Appl. Environ. Microbiology. 67:5154-5160.

- Hyman, M., P. Kwon, K. Williamson, and K. O'Reilly. 1998. Cometabolism of MTBE by alkane-utilizing microorganisms. In: *Natural Attenuation Chlorinated and Recalcitrant Compounds*, G. B. Wickramanayake and R. E. Hinchee (Eds), pgs. 321-326, Battelle Press, Ohio.
- Hyman, M., C. Taylor, and K. O'Reilly. 2000. Cometabolic degradation of MTBE by *iso*-alkane-utilizing bacteria from gasoline-impacted soil, p. 149-155. In: *Bioremediation and phytoremediation of chlorinated and recalcitrant compounds*. G.B. Wickramanayake, A. R. Gavaskar, B.C. Alleman, and V. S. Magar (ed.), Battelle Press, Columbus, OH.
- Hyman, M. and K. O'Reilly. 1999. Physiological and enzymatic features of MTBE-degrading bacteria. In: *In Situ Bioremediation of Petroleum Hydrocarbon and Other Organic Compounds*, pgs. 7-12.
- Johnson, R., J. Pankow, D. Bender, C. Price, and J. Zogorski. 2000. MTBE: To what extent will past releases contaminate community water supply wells? *Environ. Sci. Technol. News*, 2A-9A.
- Johnson, W. P., P. Zhang, M. E. Fuller, T. D. Scheibe, B. J. Mailloux, T. C. Onstott, M. F. DeFlaun, S. S. Hubbard, J. Radtke, W. P. Kovacik, and W. Holben, 2001. Ferrographic tracking of bacterial transport in the field of the Narrow Channel Focus Area, Oyster, VA, *Environ. Sci. Technol.*, 35:182-191.
- Keller, A. A., et al., 1998. Cost and performance evaluation of treatment technologies for MTBE-contaminated water. <http://tsrtp.ucdavis.edu/mtberpt/homepage.html>.
- Lindamood, C. 3rd, D. R. Farnell, H. D. Giles, J. D. Prejean, J. J. Collins, K. Takahashi, and R. R. Maronpot. 1992. Subchronic toxicity studies of *t*-butyl alcohol in rats and mice. *Fundam Appl Toxicol*, 19:91-100.
- MacDonald, C. S. The impacts of MTBE on health and the environment. Report prepared by Mid-Hudson Geosciences, New Paltz, New York, March 15, 1996.
- Mo, K., C. O. Lora, A. E. Wanken, M. Javanmardian, X. Yang, and C. F. Kulpa. 1997. Biodegradation of methyl *t*-butyl ether by pure bacterial cultures. *Appl. Microbiol. Biotechnol.* 47:69-72.
- Mormile, M. R., S. Liu, and J. M. Suflita. 1994. Anaerobic biodegradation of gasoline oxygenates: extrapolation of information to multiple sites and redox conditions. *Environ. Sci. Technol.* 28:1727-1732.
- Morrison, J. R., Suidan, M. T., Venosa, A. D., and Pruden, A. (2001). "Use of a membrane bioreactor for removal of MTBE." *Proceedings of the 74th Water Environment Federation Conference & Exposition, October 13-17, 2001, Atlanta, GA*.
- Park, K, and Cowan, R.M., 1997. Effects oxygen and temperature on the biodegradation of MTBE. *Am. Chem. Soc. Nat. Meet.* 37:421-423.
- Salanitro, J. P., L. A. Diaz, M. P. Williams, and H. L. Wisniewski. 1994. Isolation of a bacterial culture that degrades methyl *t*-butyl ether. *Appl. Environ. Microbiol.* 60:2593-2596.
- Salanitro, J. P., P. C. Johnson, G. E. Spinnler, P. M. Maner, H. L. Wisniewski, and C. Bruce. 2000. Field-scale demonstration of enhanced MTBE bioremediation through aquifer bioaugmentation and oxygenation. *Environ. Sci. Technol.* 34:4152-4162.

- Salanitro, J. P., C.-S. Chou, H. L. Wisniewski, and T. E. Vipond. Perspectives on MTBE biodegradation and the potential for in situ aquifer bioremediation. Presented at Southwestern Regional Conference of the National Groundwater Association, Anaheim, CA. June 3-4, 1998.
- Squillace, P. J., J. S. Zogorski, W. G. Wilber, and C. V. Price. 1996. Preliminary assessment of the occurrence and possible sources of MTBE in groundwater in the United States, 1993-1994. *Environ. Sci. Technol.* 30:1721-1730.
- Steffan, R. J., K. McClay, S. Vainberg, C. W. Condee, and D. Zhang. 1997. Biodegradation of the gasoline oxygenates methyl *tert*-butyl ether (MTBE), ethyl *tert*-butyl ether (ETBE), and *tert*-amyl methyl ether (TAME) by propane oxidizing bacteria. *Appl. Environ. Microbiol.* 63:4216-4222.
- Steffan, R. J., C. Condee, J. Quinnan, M. Walsh, S. H. Abrams, and J. Flanders. 2000. In situ application of propane sparging for MTBE bioremediation. pp. 157-165, in G.B. Wickramanayake, A. R. Gavaskar, B.C. Alleman, and V. S. Magar, eds. *Bioremediation and phytoremediation of chlorinated and recalcitrant compounds*. Battelle Press, Columbus, OH.
- Steffan, R. J., Y. Farhan, C. W. Condee, and S. Drew. 2003. Bioremediation at a New Jersey Site Using Propane-Oxidizing Bacteria. In: Ellen Moyer and Paul KostECKI (eds.), Chapter 27: MTBE Remediation Handbook, Amherst Scientific Publisher, Amherst, MA (in press).
- Steffan, R. J., K. L. Sperry, M. T. Walsh, S. Vainberg, and C. W. Condee. 1999. Field-scale evaluation of in situ bioaugmentation for remediation of chlorinated solvents in groundwater. *Environ. Sci. Technol.* 33:2771-2781.
- Suflita, J. M., and M. R. Mormile. 1993. Anaerobic biodegradation of known and potential gasoline oxygenates in the terrestrial subsurface. *Environ. Sci. Technol.* 27:976-978.
- Sun, P. T., Salanitro, J. P., and Tang, W. T. (1997). "Fate and biokinetics of methyl-*t*-butyl ether in activated sludge systems." *Proc. of 51st Industrial Waste Conference*, Purdue University.
- Tang, G. J. Wang, and Z. Zhuang. 1997. Cytotoxicity and genotoxicity of methyl *tert*-butyl ether and its metabolite to human leukemia cells. *Chung Hua Yu Fang I Hsueh Tsa Chih*, 31:334-337.
- Technology Demonstration Workplan. ENVIROGEN. October 17, 2000.
- United States Environmental Protection Agency. 1995. Health risk perspective on fuel oxygenates. EPA 600/R-94/217.
- United States Environmental Protection Agency. 1998. MTBE Fact Sheet #2 – Remediation of MTBE contaminated soil and groundwater. EPA 510-F-97-015.
- United States Patent #5814514, September 29, 1998.
- United States Environmental Protection Agency. 2002. <http://www.epa.gov/mtbe/faq.htm#drinking>. Last updated July 2, 2002.
- Vainberg, S, A. P. Togna, P. M. Sutton, and R.J. Steffan. 2002. Treatment of MTBE-contaminated water in a fluidized bed bioreactor. *J. Environ. Engineer.* 128:842-851.
- Wilson, J. T., J. S. Cho, B. H. Wilson, and J. A. Vardy. 2000. Natural attenuation of MTBE in the subsurface under methanogenic conditions. EPA/600/R-00/006.
- Wilson, G. J., Richter, A. P., Suidan, M. T., and Venosa, A. D. (1999). "Biodegradation of MTBE". *Proc. Water Environment Federation WEFTEC '99*, New Orleans, LA.

- Wilson, R. D., D. M. Mackay, and K. M. Scow. 2002. In Situ MTBE biodegradation supported by diffusive oxygen release. *Environ. Sci. Technol.* 36:190-199.
- Yeh, C.K. and J.T. Novak. 1994. Anaerobic biodegradation of gasoline oxygenates in soil. *Water Environ. Res.* 66:744-752.
- Yeh, C.K. and J.T. Novak. 1995. The effect of hydrogen peroxide on the degradation of methyl and ethyl *tert*-butyl ether in soil. *Water Environ. Res.* 67:828-834.0

8.0 POINTS OF CONTACT

Principal Investigator

Dr. Robert Steffan
ENVIROGEN
4100 Quakerbridge Road
Lawrenceville, NJ 08648
Steffan@envirogen.com
609.936.9300 phone
609.936.9221 fax

Project Managers

Dr. Yassar Farhan
ENVIROGEN
4100 Quakerbridge Road
Lawrenceville, NJ 08648
farhan@envirogen.com
609.936.9300 phone
609.936.9221 fax

Dr. Todd Webster
ENVIROGEN
5111 LaJolla Blvd, #3
San Diego, CA 92109
tswebs@cox.net
858.483.8684 phone
858.483.8684 fax

Assistant Project Manager

Martha D. Arkins
ENVIROGEN
4100 Quakerbridge Road
Lawrenceville, NJ 08648
Arkins@envirogen.com
609.936.9300 phone
609.936.9221 fax

APPENDIX A
SOP – PRESSURE/AIR SPARGE TESTING

STANDARD OPERATING PROCEDURE (SOP) PRESSURE TESTING

Propane Biostimulation Demonstration

October 17, 2000
ENVIROGEN Project No. 92132

1.0 INTRODUCTION

This document describes ENVIROGEN's Standard Operating Procedure (SOP) for pressure testing of the gas-injection wells at the Port Hueneme site selected for ESTCP propane biostimulation. This SOP is to be implemented during the installation Phase. The well network is being installed in accordance with Draft Demonstration Workplan dated August 17, 2000.

Pressure testing at each location will occur immediately after the gas injection point is installed. Pressure testing is necessary to ensure that the injection point is installed in a permeable (spargeable) material. The gas injection points may be moved up or down depending on the results of the pressure testing.

During pressure testing, the breakout pressure and operating pressure for each well will be measured. The breakout pressure (BP) is the pressure required to initiate airflow into the formation through the well screen. The operation pressure (OP) is the pressure required to operate the air sparge well at the desired flow rate (3 to 5 scfm). Based on previous testing, the OP for wells screened in the targeted spargeable material should be approximately 2 to 8 psi greater than the hydrostatic pressure ($P_H + 3$ psi). The hydrostatic pressure (P_H) is the height of water above the top of the screen. The measured BP and OP will be compared to the maximum system pressure (P_{sys}) at that well location, and the overburden pressure (P_o). P_{sys} is the pressure that the AS blower can supply to the well under normal operation condition. The estimated P_{sys} for the sparge systems is 10 to 12 psi. P_o is the pressure realized at the top of the well screen from the water and soil columns above. The BP and/or OP should not exceed 80% of the P_o , to avoid the risk of pneumatic fracturing. The following section presents the procedures for pressure testing.

2.0 PRESSURE TESTING PROCEDURE

This section outlines the standard operating procedure for pressure testing that will be implemented following the installation of each AS well/piezometer.

The following steps should be followed during pressure testing:

1. Connect the flexible hose to the wellhead. Turn the compressor on and let the pressure build up in the compressor tank to approximately 50 psi. Be sure that the valve and regulator downstream of the compressor are both fully closed.
2. Open the shut-off valve and slowly increase the pressure at the regulator to approximately 1-2 psi below P_H for the well, which is calculated on the field specification sheets. This

- pressure should push most of the water out of the well through the screen. Intermittent airflows may be observed as the pressure is gradually increased.
3. Continue to open the regulator in 1 psi increments, each time watching the air flow meter needle. As long as air is not yet entering the formation, the flow meter should increase a small amount and then drop back down to zero. When the airflow increases and remains measurable, the breakout pressure has been achieved and air has started to flow into the formation. Record this pressure on the field form.
 4. One of three scenarios will take place with regard to the breakout pressure:
 - The breakout pressure is less than ($P_H + 8$ psi). In this case, the breakout pressure is assumed to be acceptable. Move on to Step #5.
 - The breakout pressure is between ($P_H + 8$ psi) and the lower of P_{sys} (20 psi) or 80% of P_o . In this case, the breakout pressure is assumed to be acceptable. Move on to Step #5.
 - The breakout pressure increases to a level above the lower of P_{sys} (20psi) or 80% of P_o . In this case, the breakout pressure is assumed to be unacceptable. Move on to well development (see CQAP).
 5. Increase the airflow to approximately 10-12 scfm by opening the regulator further. Continually watch the air flow meter and the pressure gauge downstream of the air flow meter.
 6. One of three scenarios will take place with regard to the operating pressure:
 - The operating pressure will stabilize at a level less than ($P_H + 8$ psi), at an airflow of 10-12 scfm. In this case, the well is assumed to be screened in spargeable material and can be considered complete. Continue operating for no more than an additional 5 minutes to confirm the pressure and flow have stabilized. Move on to the next well.
 - The operating pressure will stabilize at a level between ($P_H + 8$ psi) and the lower of P_{sys} (20 psi) or 80% of P_o at an airflow of 10-12 scfm. In this case, operation of the well is marginal. Move on to well development (see CQAP). If, after well development and retesting, well performance does not improve, a decision will be made by ENVIROGEN whether or not to adjust the well (see CQAP). This decision will be based on the magnitude of the difference between ($P_H + 8$ psi), and the lower P_{sys} (20psi), or 80% of P_o , the type of well (shallow or deep), and the location of the well including geologic complexity and contaminant distribution.
 - The operating pressure increased to a level above the lower of P_{sys} (20psi), or 80% of P_o . In this case, move on to well development (see CQAP).
 7. When the pressure test is complete, close the shut-off valve completely. Turn off the compressor. Release the pressure in the line between the shut-off valve and the check valve with the regulator. Disconnect the flexible hose from the wellhead upstream of the check valve (leave check/needle valve assembly on the wellhead). After approximately 5 minutes, open the needle valve just enough to hear the air flowing out (hissing). Do not let the air flow out rapidly, to avoid silting of the well. It may take several minutes for the well to depressurize. Move on to the next well during depressurization.

APPENDIX B
BACTERIAL INJECTION PROTOCOL

Bacterial Injection Protocol

ENVIROGEN will ship 16 L of ENV425 to the Site, which is roughly the equivalent of 5L of ENV425 at a concentration of 10^{11} cfu/mL in a cooler on ice to the Site (via FedEx priority overnight).

Dilution of ENV425 culture

Dilute 16 L of ENV425 culture to a final volume of approximately 50 L as follows:

1. Using a peristaltic pump, from each of the 7 bacterial injection points (BIP), purge 5 L of groundwater into a common vessel, for a total volume of 35 L.
2. Add 16 L of ENV425 culture to the vessel (final volume approx. 50 L of bacterial culture at 10^{10} cfu/mL).

Well purge and bacterial injection

Repeat the following at each bacterial injection point:

1. Purge 6 L of groundwater from well BIP1 into a clean plastic container using a peristaltic pump.
2. Transfer 7 L of the 50 L of diluted (10^{10} cfu/mL) culture to a clean, 10 L container. Place the inlet line of a peristaltic pump into the 10 L container.
3. Lower the outlet tube from the peristaltic pump to the midpoint of the injection well (approx. 11 ft bgs). Pump approximately 2.5 L of the 7 L of bacterial culture into the midpoint of the well.
4. Lower the outlet tube to approximately 2 ft from the bottom of the well (approx. 14 ft bgs). Pump the remaining 4.5 L of culture into the well at this point.
5. Reinject the 6 L of purge water purged from the well in Step 1.
6. Rinse well the container that held the 6 L of purge water for use at the next BIP.
7. Repeat Steps 1-6 for each BIP.

APPENDIX C
STANDARD HEALTH AND SAFETY PLAN

FOR

ESTCP Propane Biostimulation Demonstration

August 2000

PREPARED BY
ENVIROGEN, INC.

ENVIROGEN PROJECT NO. 92132

TABLE OF CONTENTS

	<u>PAGE</u>
SIGNATURE SHEET	IV
CONTINGENCY CONTACTS	V
DIRECTIONS TO HOSPITAL (EMERGENCY ROUTE MAP)	VI
C1.0 INTRODUCTION/BACKGROUND OF HASP	1
C2.0 SCOPE OF WORK	4
C2.1 TASK DESCRIPTIONS	4
C2.2 PROJECT PARTICIPANTS AND RESPONSIBILITIES	5
C2.3 WORK STOPPAGE AUTHORITY	6
C3.0 HAZARD EVALUATION	7
C3.1 TASK HAZARD	7
C3.1.1 Task 1: Equipment Installation and Setup	7
C3.1.2 Task 2: Baseline Monitoring	8
C3.1.3 Task 3: Initial Testing	8
C3.1.4 Task 4: Performance Optimization and Monitoring	9
C3.1.5 Task 5: Long-Term Monitoring and Operations	9
C3.2 SUBSTANCE HAZARDS	12
C3.3 OVERHEAD AND BURIED UTILITIES	13
C4.0 MONITORING EQUIPMENT	14
C4.1.1 Purpose	14
C5.0 WORK ZONES	17
C5.1 EXCLUSION ZONE - (WORK AREA)	17
C5.2 CONTAMINATION REDUCTION ZONE (CRZ)	17
C5.3 SUPPORT ZONE	17
C6.0 DECONTAMINATION PROCEDURES	18

C6.1 PERSONNEL	18
C6.2 EQUIPMENT	18
C6.3 LEVEL C/D DECONTAMINATION	18
C7.0 GENERAL WORK REQUIREMENTS	22
C8.0 SITE ENTRY AND EXIT PROCEDURES	24
C9.0 VISITOR PROTOCOL	25
C9.1 Non-Exclusion Zone Work Areas	25
C9.2 Exclusion Zones	25
C10.0 WEATHER-RELATED CONCERNS	26
C10.1 HEAT STRESS	26
C10.1.1 Heat Rash	26
C10.1.2 Heat Cramps	26
C10.1.3 Heat Exhaustion	26
C10.1.4 Heat Stroke	27
C10.2 COLD STRESS	28
C10.2.1 Frostbite	28
C10.2.2 Hypothermia	29
C11.0 EMERGENCY CONTINGENCY PLAN	31
C11.1 SITE-SPECIFIC CONTINGENCY PLANS	31
C11.1.1 Preventative Measures	31
C11.1.2 Response Actions	32
C11.1.3 Notification	33
C11.2 UNEXPECTED VAPOR/PARTICULATE RELEASE	33
C11.3 PERSONNEL INJURY	33
C11.4 FIRST AID FOR OVEREXPOSURE	34
C11.5 EVACUATION PLAN	35
C11.6 SPILL PREVENTION AND RESPONSE	35
C11.7 ONSITE COMMUNICATIONS FOR EMERGENCY SITUATIONS	36
C12.0 HEALTH AND SAFETY PLAN APPROVAL/SIGN-OFF FORM	37

TABLES

Table C-1	Potential Physical Hazards	10
Table C-2	Biological Hazards	11
Table C-3	Monitoring Action Level Criteria	16
Table C-4	Noise Action Levels (AS NEEDED)	Appendix C-J

APPENDICES

Appendix C-A	Emergency Routes
Appendix C-B	MSA Ultra Twin Inspection Checklist Prior to Field Use
Appendix C-C	Procedure for Cleaning and Disinfecting Respirators
Appendix C-D	Project Participants; Site Entry/Exit Log
Appendix C-E	Visitor Site Entry/Exit Log
Appendix C-F	Ladder Safety
Appendix C-G	Eye and Face Protection
Appendix C-H	Head Protection
Appendix C-I	Donning PPE
Appendix C-J	Noise

SIGNATURE SHEET

Dr. Robert Steffan
Principal Investigator

Joseph Quinnan
Project Coordinator

Todd Webster
Site Coordinator/Project Manager

Susan Schenck
Site Safety and Health Officer

CONTINGENCY CONTACTS

Agency	Contact	Phone No.
Fire Department		911
Police Department		911
St. John's Regional Medical Center		805-988-2500
Poison Control Center Hotline		800-822-3232
Ambulance		911
State Police		911
ENVIROGEN, Inc. Project Coordinator	Joseph Quinnan	Work: 609-936-9300 Home: 215-369-2927
ENVIROGEN, Inc. Project Manager	Todd Webster	Work: 858-483-8684 Home:
ENVIROGEN, Inc. Site Safety and Health Officer (SSHO)	Susan Schneck	Work: 609-936-9300 Home: 215-493-1918
National Response Center (NRC) for Oil/Chemical Spills		800-424-8802

DIRECTIONS TO HOSPITAL (EMERGENCY ROUTE MAP)

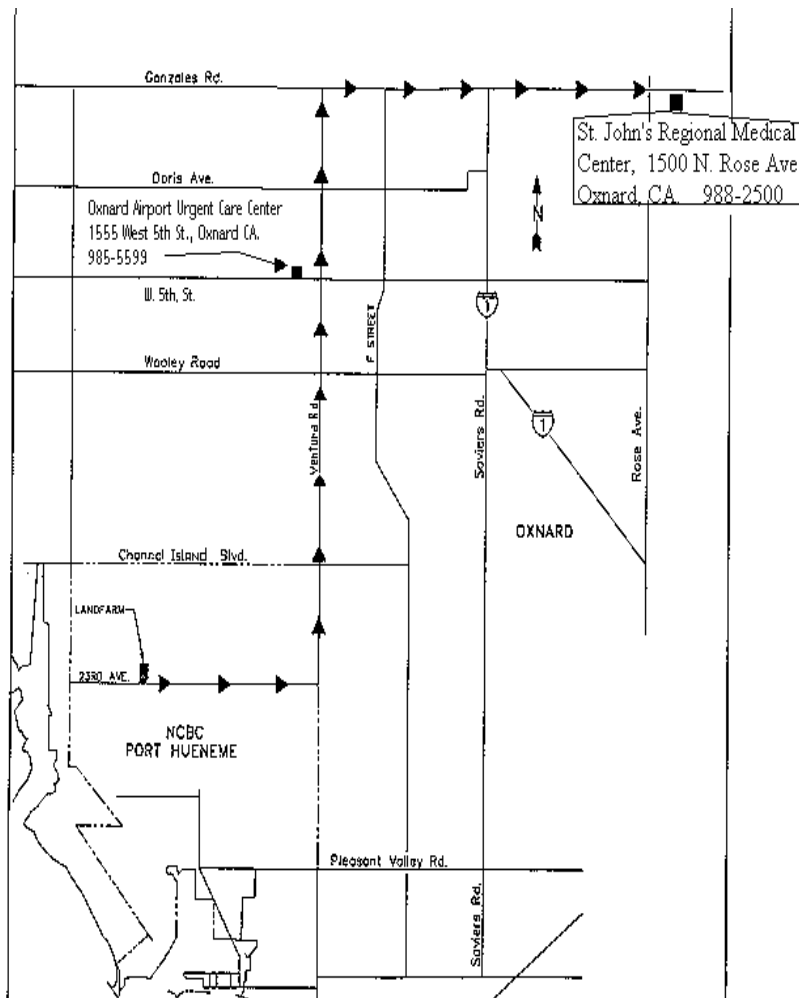

C1.0 INTRODUCTION/BACKGROUND OF HASP

This Health and Safety Plan (HASP) is to be used during the startup and operation of the soil and groundwater remediation system, and associated groundwater monitoring. The full text HASP shall remain onsite during all applicable project activities.

The HASP specifies safety and health practices for all field activities at the site, including:

- site characterization, including history and potential contaminants of concern, their physical properties, toxicities, and associated signs and symptoms of exposure;
- responsibilities of key site safety and health personnel;
- work practices and standard operating procedures (SOPs);
- hazard identification and assessment, including chemical, biological, and physical hazards;
- establishment of work zones [Exclusion Zone (EZ), contamination reduction zone (CRZ), and support zone (SZ)];
- levels of personal protective equipment (PPE) for work zones and tasks therein;
- exposure monitoring/air sampling practices;
- heat/cold stress monitoring;
- entry and exit routes;
- decontamination procedures;
- responses to accidents, injuries and emergencies;
- emergency contacts, phone numbers, evacuation routes and assembly areas;
- medical surveillance;
- training and record keeping requirements for all site workers.

SITE: National Environmental Technology Test Site (NETTS) at the Naval Construction Battalion Center, Port Hueneme, California

LOCATION/ADDRESS:

23rd Avenue and Dodson Street
Naval Construction Battalion
Port Hueneme

PROJECT DESCRIPTION:

The propane biostimulation technology that will be applied in this demonstration involves the addition of oxygen (for aerobic respiration) and propane (as a cosubstrate) to simulate the production of the enzyme propane monooxygenase (PMO) by propane oxidizing bacteria (POB), which catalyzes the destruction of MTBE. The addition of the substrates to the contaminated aquifer creates an aerobic treatment zone that promotes the growth and activity of the POB. MTBE and its primary breakdown product, tert-butyl alcohol (TBA), are completely converted to carbon dioxide and water through this process.

The demonstration will employ a Test Plot, with oxygen and propane injection, and a Control Plot, with oxygen only, to allow a direct comparison of degradation rates with and without propane. The propane and oxygen will be injected into the saturated aquifer using sparging wells and pressurized gas systems, designed to provide flexible performance characteristics and safe operation. Oxygen and propane will be intermittently sparged into the aquifer using separate oxygen and propane sparge points at a total rate of approximately 1- to 10-pounds/day and 0.1- to 0.5- pounds/ day, respectively.

STARTUP DATE OF REMEDIATION SYSTEMS:

September 2000

PROJECTED LENGTH OF REMEDIATION PROGRAM:

The length of remediation program will be approximately 10 months.

SITE DESCRIPTION:

The National Environmental Technology Test Site (NETTS) at the Naval Construction Battalion Center (CBC), Port Hueneme, California is an active United States Naval Facility located approximately 70 miles northwest of Los Angeles.

SITE STATUS: Active

SITE HISTORY:

The Naval Exchange (NEX) service station is the source of the petroleum plume that at the Port Hueneme CBC facility. According to NEX inventory records, approximately 4,000 gallons of leaded and 6,800 gallons of unleaded premium were released from the distribution lines between September 1984 and March 1985. The resulting groundwater plume consists of approximately 9 acres (1,200 feet) of BTEX and approximately 36 additional acres of MTBE contamination, extending approximately 4,500 feet from the NEX service station.

C2.0 SCOPE OF WORK

ENVIROGEN, Inc. cannot guarantee the health and/or safety of any person entering this site for it is not possible to evaluate and provide protection for all possible hazards, which may be encountered. Adherence to the HASP will reduce, but cannot totally eliminate, the possibility for worker injuries and illness to occur at this site.

This HASP has been developed for ENVIROGEN, ESTCP employees and all onsite subcontractors, and provides protocols to be followed during onsite activities. Visitors to the site must review this HASP and agree to comply with the protocols set forth in this plan. Any changes to the set protocols must be approved by the ENVIROGEN Safety and health officer. Pre-work safety meetings will be held daily and prior to starting any new site activity.

C2.1 TASK DESCRIPTIONS

ENVIROGEN will perform an in-situ MTBE bioremediation field demonstration. The tasks associated with this scope of work are listed below.

Task 1

Equipment Installation and Setup

Task 2

Baseline Monitoring

Task 3

Initial Testing

Task 4

Performance Optimization and Monitoring

Task 5

Long-Term Operations and Monitoring

C2.2 PROJECT PARTICIPANTS AND RESPONSIBILITIES

ENVIROGEN Project Coordinator	Joseph Quinnan
ENVIROGEN Project Manager	Todd Webster
ENVIROGEN Site Coordinator	Todd Webster
ENVIROGEN SSHO	Susan Schneck

Project Coordinators

The Project Coordinators are responsible for coordinating activities between ESTCP and ENVIROGEN.

Project Managers

The Project Managers will be responsible for assigning qualified field personnel and coordinating the work with all contractors and subcontractors.

Site Coordinators

The Site Coordinators will be responsible for coordinating field activities, and monitoring site conditions including local weather.

Site Safety and Health Officer (SSHO)

A sign-in/out book will be utilized to identify personnel present at the site. It is a subcontractor's responsibility to notify the ENVIROGEN Site Safety and Health Officer (SSHO) of their presence.

At the site, the SSHO shall:

- a. Assure that appropriate personal protective equipment is available and properly used by all field personnel. The client, regulatory agency personnel, and subcontractors will supply their own personal protective equipment and ensure its use.
- b. Assure that personnel are aware of the provisions of this HASP and are instructed in work practices, safety, and emergency procedures.
- c. Conduct onsite monitoring of hazards (biological, chemical and physical) prior to initiation and during remediation activities to determine the degree of hazards and establish the proper level of protection required.

- d. Evaluate potential weather (heat or cold stress, electrical storms) and topography hazards, and recommend any necessary modifications to the work plans and personal protection levels to assure the safety and health of all project personnel. If severe weather threatens, a local radio station will be monitored.
- e. Monitor the safety performance of all project personnel to assure that proper safety and health procedures are employed. If, after being requested to comply with health and safety procedures by the SSHO, an individual fails to comply, the SSHO will report the individual to the appropriate supervisor and the Project Coordinator.
- f. Maintain the site entry/exit log (Appendix D) or equivalent and the visitor site entry/exit log (Appendix E) or equivalent.
- g. Be onsite at all times when work is being conducted unless the specific task does not necessitate an onsite presence.
- h. Maintain communication with all onsite personnel, the project coordinators, the project managers, and the ENVIROGEN Project Manager or designee in the event there is an emergency, or if a dangerous site condition develops.
- i. Designate emergency evacuation assembly areas on a daily basis dependent on the direction of prevailing winds, and inform all on site personnel of this specific area, also on a daily basis.
- j. Periodically review and modify accordingly the HASP during the project to assure flexibility as the project proceeds. Communicate any changes to the set protocols as listed in the HASP to the ENVIROGEN Project Manager as soon as practical.

C2.3 WORK STOPPAGE AUTHORITY

The Project Manager and SSHO shall have authority to make immediate corrections dealing with on-site safety matters and deviations from or infractions of this HASP. If the matter cannot be resolved immediately, the PM and SSHO shall have the authority to order a cessation of activity at the site until the matter is resolved. This shall include weather related work stoppages.

C3.0 HAZARD EVALUATION

C3.1 TASK HAZARD

The following hazard assessments identify site-specific tasks/operations to be performed. They present an analysis of documented or potential hazards for tasks that shall be conducted at the site.

C3.1.1 Task 1 : Equipment Installation and Set-Up

The demonstration system will consist of a network of oxygen and propane injection points, pressurized oxygen and propane gas delivery and control systems, and groundwater and soil-gas monitoring network.

Chemical Hazards: Propane, Oxygen

Specific compounds and their exposure data may be found in Section 3.2.

Electrical Hazards: All underground electrical lines will be marked out prior to drilling. The drill rig will not operate near overhead power lines.

Physical Hazards: Heat, cold, noise, electricity and vehicle traffic may be present in some areas of the site. See Table 2.

Biological Hazards: Wild animals, insects and poisonous plants may be present in some areas of the site. See Table 2.

Confined Space(s): No (Yes/No)

Explosion Hazard(s): Yes (Yes/No)

Propane has a lower explosive limit (LEL) of 2.1%. No smoking will be permitted anywhere on site.

PPE Required: Hand, foot, head, eye, skin and respiratory protection may be required. Respiratory protection may be changed by the site SSHO based on historic and/or real-time air monitoring data: any PPE changes, upgrades or downgrades, will be approved by the ENVIROGEN Project Manager in writing.

Level D (atmosphere contains no known hazards). Minimal skin protection and no respiratory protection.

Recommended:

- Hard Hat
- Safety glasses or chemical splash goggles
- Steel Toe Workboots/Shoes
- Rubber boots or disposable booties if muddy or potential for contaminated water

Optional:

- Gloves (latex under and/or leather outer)
- Full Body Coveralls
- Reflective Vest (heavy vehicle traffic or night work)

Level C -Atmosphere must not exceed IDLH levels. Air contaminants, liquid splashes and other direct contact will not harm exposed skin. Air contaminants have been identified, measured, and an air-purifying canister is available which can remove them.

Recommended:

- Full-face, air purifying respirator with organic vapor/high efficiency particulate air cartridges
- Chemical-resistant coveralls (i.e. Tyvek, Saranex, etc.)
- Inner & outer chemical resistant gloves (chemical-specific/manufacturer’s recommendation)
- Chemical resistant safety shoes/boots or booties
- Hard hat
- Safety glasses or chemical splash goggles

<u>Air Monitoring Type</u>	<u>Frequency and Activity</u>
-----------------------------------	--------------------------------------

Flame Ionization Detector	Monitor continuously during drilling activities in the breathing zone
---------------------------	---

Air monitoring action levels and additional information on air monitoring may be found in Section 4.0.

C3.1.2 Task 2: Baseline Monitoring

A protocol of monitoring will be implemented prior to initiating the propane biostimulation demonstration to establish background conditions of groundwater quality and biogeochemistry, soil-gas, and ambient air quality.

Background sampling will be performed once each week in the two weeks prior to initiating the propane biostimulation. Envirogen and NETTS personnel will perform the sampling. Each sampling event is anticipated to require 2 people approximately 2 days to complete.

All sections from C3.1.1 also apply to this task.

C3.1.3 Task 3: Initial Testing

Once the background sampling is complete, a series of tests will be performed on the demonstration system to verify system performance and safe operations. The scope of activities included in the initial testing phase will include gas injection point pressure testing, verification of control assembly performance and initial system adjustments. Soil-gas and ambient air monitoring will be performed to verify safe operating conditions. Envirogen and NETTS personnel will conduct initial testing activities over a period of 3 to 5 days.

All sections from C3.1.1 apply to this task.

C3.1.4 Task 4: Performance Optimization and Monitoring

The objective of the performance optimization phase of operations is to achieve adequate distribution of oxygen and propane to stimulate biodegradation of MTBE in the aquifer. Initial oxygen and propane injection flow rates, duration, and frequency will be modified as necessary to achieve adequate substrate distribution throughout the demonstration plots. Based on the estimated groundwater flow velocity, approximately 30 days of substrate injection will be required to attain adequate concentrations throughout the Test and Control Plot networks. A tracer study will be performed during the early phase of operation to quantify groundwater flow velocity and solute transport parameters to aid in system performance refinement. In addition, a bacterial seed injection may be completed once oxygen and propane concentrations meet design levels, if microcosm studies indicate that response times are too slow to meet project objectives.

The duration of the Phase II operations is anticipated to be approximately 5 months. Envirogen and NETTS personnel will perform operations, maintenance and sampling. Optimization phase sampling will include groundwater monitoring, field measurements of geochemical indicators (pH, dissolved oxygen, specific conductivity, etc.), laboratory analysis of biogeochemical parameters and soil-gas and ambient air monitoring.

All sections from C3.1.1 apply to this task.

C3.1.5 Long-Term Monitoring and Operations

The propane biostimulation demonstration will continue for a period of up to 10 months. During the long-term monitoring phase groundwater sampling will be performed on a monthly basis for the following analyses: groundwater quality parameters, field geochemical indicators, dissolved propane and carbon dioxide. Soil-gas and ambient air monitoring will be performed on a monthly basis in conjunction with groundwater sampling. Nutrients, bacterial population assays and oxygen demand parameters will be sampled and analyzed during the sixth and tenth months.

All sections from C3.1.1 apply to this task.

Table C-1

Potential Physical Hazards

Physical Hazard	Protection
Heavy Manual Lifting	Lift with legs; get assistance.
Housekeeping	Store equipment properly; Remove rubbish/scrap material from work area.
Compressed Gases (calibration gas)	Store properly (i.e. secured from falling/tipping)
Vehicle Traffic	Warning signs; away from work area.
Heavy Equipment	Trained/licensed operators; warning signs, backup alarms.
Using Ladders	Examine for defects prior to use.
Materials Handling	Material stacked/stored to prevent collapsing; machinery properly braced.
Hazardous Material Storage	Segregate flammable/combustible liquid from ignition sources. Segregate incompatibles. Store in approved containers. Solvent waste, oily rags, and liquids kept in fire resistant containers.
Fire Prevention	Be aware of the location and proper use of the Fire Extinguisher.
Electrical	Approved grounding and bonding procedures. Electrical lines/cords; cables guarded and maintained. Lockout/Tagout must be considered and implemented as appropriate. Damaged equipment tagged/removed from service.
Hand/Power Tool	Guards and safety devices in place. Must be double insulated or an assured grounding program must be implemented (i.e. use of GFCIs).
Tools	Defective tools tagged/removed from service. Tools maintained and inspected per manufacturer's specs.; Proper eye protection used.

Table C-2

Biological Hazards

Hazard	Location/Source (K/S)*	Route of Exposure (I,G,D,C)**	Prevention
Poisonous Plants (Dermatitis, Poisoning)	Fields, Brush-covered and wooded areas (S)	I, C, G	Avoid contact with plants. Wear long sleeves and pants. Do not eat wild plants.
Insects, Arachnids	All areas (S)	D	Insect repellent. Wear long sleeves and pants. Those allergic should wear ID and carry epinephrine dose (i.e. epipen).
Deer Tick (Lyme Disease)	Fields, Brush-covered and wooded areas (S)	D	Insect repellent. Wear long sleeves and pants. Avoid contact with plants. Check yourself for bites and rashes.
Wild and Feral Mammals (Rabies)	All areas (S)	D	Avoid contact with wild/feral mammals. Wear long sleeves and pants.
Toxic bacteria/fungi	All areas (S)	I,S,D	Avoid working in soil without gloves. Avoid breathing mists and aerosols, especially from cooling towers, compost piles, and also fine wood dust. Tetanus vaccination must be up to date. Dust respirators should be considered.
Wild Birds (Histoplasmosis)	Vacant buildings (S) Soil where bird roosts are or had been.	I	Avoid disturbing accu- mulations of bird droppings. Wear dust mask. Wet accumulations with chlorine bleach and water.

* - K - Known, S - Suspect
** - I - Inhalation, G- Ingestion, C- Contact, D - Direct Penetration (Bite, Injection, Open Wound or Sore).

C3.2 SUBSTANCE HAZARDS

The following substances have been detected in soil and/or groundwater, or have been introduced for use by onsite personnel. The primary hazards of each are identified. Concentration results have been taken from previous sampling activities performed at this site. Acronyms are listed at the end of the section.

Chemical	Maximum Concentration Detected in Soil/ Groundwater Air	OSHA PEL OSHA STEL ACGIH TLV ACGIH STEL NIOSH IDLH NIOSH REL Ionization Potential (eV)	Primary Hazards
Gasoline	3,000 ppm (soil)	PEL: Not Established STEL: Not Established IDLH: Not Established	LEL: 1.4% Carcinogen Eye, skin, membrane irritant
MTBE	23,000 µg (groundwater)	TLV: 40 PPM PEL: -- STEL: -- IDLH: --	LEL: 1.6% Liver and kidney damage Eye and skin irritant Can cause burning sensation
Oxygen	NA	PEL: -- STEL: -- IDLH: --	LEL: High concentrations of oxygen can lead to coughing and pulmonary changes, concentrations above 75% can cause symptoms of hyperoxia
Propane	NA	PEL: 1000 PPM STEL: -- IDLH: 2,100 PPM	LEL: 2.1% Dizziness, confusion, excitation, Asphyxia, Colorless gas with mercaptan odor

OSHA PEL = Occupational Safety and Health Administration: Permissible Exposure Limit (8-hour time-weighted averages/TWA). PEL* designates the stricter vacated 1989 concentration.

ACGIH TLV = American Conference of Governmental Industrial Hygienists: Threshold Limit Value for an 8-hour time-weighted average.

NIOSH IDLH = National Institute for Occupational Safety and Health: Immediately Dangerous to Life or Health concentration of vapors or gases.

NIOSH REL= National Institute for Occupational Safety and Health: Recommended Exposure Limit (used in absence of any regulatory limits)

- STEL = OSHA and ACGIH: Short Term Exposure Limit for 15-minute period.
STEL* designates the stricter vacated 1989 concentration.
- C = OSHA and ACGIH: Ceiling Limit. The concentration that should not be exceeded for any period of time. C* designates the stricter vacated 1989 concentration.
- CA = Per NIOSH, chemicals to be treated as human carcinogens.
- S = OSHA: Skin Caution. Potential for significant contribution to overall exposure via skin absorption including mucous membranes and eye, either by airborne, or more particularly, by direct contact with the substance. S* designates the stricter vacated 1989 concentration.
- ppm = Parts of vapor or gas per million parts of air by volume at 25°C and 760 mm Hg.
- ug/m³ = Micrograms of substance per cubic meter of air.
- ug/kg = Micrograms of substance per kilogram in a solid sample.
- mg/m³ = Milligrams of substance per cubic meter of air.
- mg/kg = Milligrams of substance per kilogram in a solid sample.
- ug/l = Micrograms of substance per liter (aqueous).
- f/cc = fibers per cubic centimeter of air (usually fiberglass or asbestos)
- LEL = Lower Explosive Limit = Minimum concentration of vapor in air below which propagation of flame does not occur in the presence of an ignition source.
- UEL = Upper Explosive Limit = Maximum concentration of vapor or gas in air above which propagation of flame does not occur in the presence of an ignition source.
- NE = Not established.
- eV = Electron volts (ionization potential) - Sample gases are exposed to photons emanating from an ultraviolet lamp. Ionization occurs for those molecules having ionization potential near to or less than that of the lamp; this response is displayed on the meter. Therefore, use a lamp with an eV equal to or greater than (but closest to) the ionization potential of the compound.
- CAS = The Chemical Abstracts Service Registry number is a numeric designation assigned by the American Chemical Society's Chemical Abstracts Service and uniquely identifies a specific chemical element or compound. This entry allows one to conclusively identify a substance regardless of the name or naming system used.
- NOTE: Material Safety Data Sheets are in Appendix M.

The overall hazard rating for the listed tasks is low to moderate.

NOTE: Selection for the overall hazard rating of the site is based on onsite tasks and the hazard evaluations prior to initiation of on site activities.

C3.3 OVERHEAD AND BURIED UTILITIES

The use of a drill rig on a site or project within the vicinity of electrical power lines and other utilities requires special precautions by all personnel involved. Electricity can shock, burn and cause death.

- All utilities should be noted and emphasized on all boring location plans and assignment sheets;
- When overhead electrical lines exist at or near a drilling site or project, consider them to be alive and dangerous;
- Be aware of any sagging power lines before entering a site. Do not lift power lines to gain entrance, but call the utility to raise the lines or de-energize them;
- Before raising a drill rig mast (derrick) on a site in the immediate vicinity of overhead power lines, walk completely around the drill rig. Determine what the minimum distance from any point on the drill rig will be to the nearest line when the mast is being raised or is full raised. Do not raise the mast or operate the drill rig if this distance is less than 20 feet (6 meters) or, if known, the minimum clearance stipulated by the local utility or governmental safety regulations (i.e. local utility contact shall be made prior to raising rig to verify clearances)
- Underground utilities shall be located by the local utility, or contract location service, and visibly marked prior to any site operations which will penetrate the ground surface.

C4.0 MONITORING EQUIPMENT

C4.1 AIR MONITORING INSTRUMENTS

- Flame ionization detector (Foxboro OVA Model 128) calibrated to methane.
- Oxygen/carbon dioxide detector (Gastech Model 3250X)

C4.1.1 Purpose

The following Air Monitoring Program will entail real-time monitoring and is designed for use during the air and propane injections performed at the site.

The objective of the program is to ensure that proper levels of respiratory protection are employed by all onsite workers based on air monitoring data.

C4.1.1.1 Exclusion Zone Monitoring

When specified in Section 3.0 of this HASP, the exclusion zones, defined by the SSHO, will be monitored with real-time instrumentation at a minimum, once at initial entry, and periodically throughout the task. Task-specific air-monitoring requirements are detailed in Section 3.0. Air monitoring will be used to identify and quantify airborne levels of hazardous substances in order to determine the appropriate level of employee protection needed onsite.

C4.1.1.2 Air Monitoring Requirements

All instruments will be calibrated and maintained according to the manufacturer's instructions. Manuals for each instrument are maintained in the instrument case and will be onsite at all times.

1. Check and record calibration at start of applicable task (see Section 3.0) and at the end of each work shift.

NOTE: Calibration will be performed with standard calibration gases as recommended by the manufacturer.

2. Prior to entering the exclusion zone, conduct test and record background volatile organic compound (VOC) levels.
3. Check and record breathing zone levels during applicable tasks (see Section 3.0).
4. Check and record source levels (i.e., wells, iron removal filter canister) as presented.
5. Check and record VOC levels at the perimeter of the work zone if elevated concentrations are detected in the workers' breathing zones.
6. Check and record instrument readings following completion of task.

TABLE C-3**AIR MONITORING ACTION LEVEL CRITERIA**

Monitoring Instrument	Potential Hazard	Action Level	Action
Personal breathing zone monitoring	dusts/mists	Use when working with Bacteria	Level D, plus dust mask, eye goggles, nitrile gloves
Organic vapor monitor (OVA)	Organic vapors/gases	< 5 PPM	No respiratory protection required
		5 PPM to 100 PPM or mercaptan odor detected	Level C respiratory protection Turn off oxygen and propane injection
		> 100 PPM	Evacuate area
Explosimeter (CGI)	Explosive atmosphere	Vapor monitoring well sample exceeds 3,200 PPM _v	Turn off oxygen and propane injection

Note: The action levels listed are selected based on the OSHA permissible exposure limit for the compounds of concern, along with current data on toxicological, physical and chemical properties of these compounds.

* Monitoring of the workers' breathing zone.

- (1) If the action level is exceeded, all work in the area will stop, engineering techniques will be utilized to reduce the explosive atmosphere below the action level. Re-entry must be authorized by Senior Industrial Hygienist or alternate Health and Safety.
- (2) Oxygen enriched environments (>23.5%) are not anticipated.

C5.0 WORK ZONES

C5.1 EXCLUSION ZONE - (WORK AREA)

The exclusion zone is defined as the area that is considered to be contaminated (i.e. "hot", etc.), potentially contaminated, or that could become contaminated during completion of a specific task (see Section 3.0). All personnel working in the defined exclusion zone will utilize the appropriate level of protection. All areas considered to be part of the defined exclusion zone will be physically delineated. Exclusion zones in high-profile areas will be marked with traffic cones.

C5.2 CONTAMINATION REDUCTION ZONE (CRZ)

This zone serves as the interface between the exclusion zone (contaminated) and the support zone (clean) for the completion of a specific task. This transition zone serves as a buffer to further reduce the probability of the support zone becoming contaminated. This zone provides additional assurance that the physical transfer of contaminated substances on people, equipment, or in the air is limited through a combination of decontamination, distance between zones, air dilution, zone restrictions, and work functions.

Material supplies will be staged within the CRZ for the servicing of equipment and personnel within the defined exclusion zone. All vehicles, equipment, and personnel will be totally decontaminated before leaving this area. All protective clothing, which is removed, will be staged temporarily in the CRZ and disposed of properly.

C5.3 SUPPORT ZONE

This portion of the area is considered "clean" or uncontaminated during completion of a specific task. Individuals who are not participating in a given task must remain in the support zone. Support equipment and supplies will be located here. The support (or clean) zone shall be clearly delineated so as to prevent active or passive contamination from the exclusion zone(s) or CRZ(s). This area serves as the entry point to the CRZ(s) for personnel, equipment, and material. This area also serves as the location of individuals and materials that are involved in other onsite tasks that do not require the establishment of an exclusion zone.

C6.0 DECONTAMINATION PROCEDURES

C6.1 PERSONNEL

Personnel leaving the Exclusion Zone (work area) shall be thoroughly decontaminated. The minimum *Level D/C* decontamination protocol shall be used with the following decontamination stations. However, if the need arises, complete decontamination procedures are outlined in Section 6.3.

1. Equipment drop
2. Glove wash
3. Glove rinse
4. Boot wash
5. Boot rinse
6. Protective clothing removal
7. Respirator removal

NOTE: The above wash and rinse stations may be eliminated if a totally disposable outfit is utilized; however, protective clothing removal shall be performed as stated above.

Clothing known to be contaminated should be contained and left onsite for proper disposal along with decontamination solutions. See Appendix C for respirator sanitizing procedure.

The following decontamination articles are required if a totally disposable outfit is not utilized:

Tubs, buckets, brushes, Liquinox, sprayer, and trash bags.

C6.2 EQUIPMENT

All equipment coming in contact with contaminated soil or groundwater must be properly decontaminated before leaving the work area. Small equipment (i.e., trowels, bailers, etc.) will be decontaminated at the personnel decontamination area.

Any portion of the remediation system that has been in contact with contaminated groundwater or a hazardous chemical must be decontaminated prior to its removal from the site for the purposes of repair, replacement, reuse, disposal, or sale.

C6.3 LEVEL C/D DECONTAMINATION

A. Equipment Worn

The full decontamination procedure outlined is for workers wearing Level C/ D protection consisting of:

- Cotton Coveralls, or one-piece, hooded, polyethylene-coated Tyvek Coverall - Modified Level D
- Safety glasses
- Hard hat
- Steel-toe and shank boots
- Work gloves or inner latex gloves with outer nitrile gloves (if working in wet conditions)
- Full-face respirator equipped with dual cartridges - Level C

B. Procedure For Full Decontamination

Station 1: Segregated Equipment Drop

Deposit equipment used onsite (tools, sampling devices and containers, monitoring instruments, radios, clipboards, etc.) on plastic drop cloths or in different containers with plastic liners. Each will be contaminated to a different degree. Segregation at the drop reduces the probability of cross-contamination.

Equipment: Various size containers
Plastic liners
Plastic drop cloths

Station 2: Latex Booties/Rubber Boot and Glove Wash

Scrub outer booties/rubber boots and gloves with decon solution or detergent/water.

Equipment: Container (20 to 30 gallons)
Decon solution or detergent water
2 to 3 long-handle, soft-bristle scrub brushes

Station 3: Latex Booties/Rubber Boot and Glove Rinse

Rinse off decon solution from Station 2 using copious amounts of water. Repeat as many times as necessary.

Equipment: Container (30 to 50 gallons) or high-pressure spray unit (not to exceed 30 psi)
Water

2 to 3 long-handle, soft-bristle scrub brushes

Station 4: Tape Removal

Remove tape around boots and gloves and deposit in container with plastic liner.

Equipment: Container (20-30 gallons)
Plastic liners

Station 5: Poly-coated Tyvek Coverall Removal

With assistance of helper, remove coverall. Deposit in container with plastic liner.

Equipment: Container (30 to 50 gallons)
Bench or stool
Liner

Station 6: Latex Booties/Rubber Boot Removal

Remove Latex Booties and deposit in container with plastic liner.

Equipment: Container (30 to 50 gallons)
Plastic liners
Bench or stool

Station 7: Outer Glove Removal

Remove outer gloves and deposit in container with plastic liner.

Equipment: Container (20 to 30 gallons)
Plastic liners

Station 8: Cartridge or Mask Change

If worker leaves Exclusion Zone to change cartridges (or mask), this is the last step in the decontamination procedure. Worker's cartridges are exchanged, new outer gloves and boot covers donned, and joints taped. Worker returns to duty.

Equipment: Cartridges
Replacement masks
Tape
Boot covers
Gloves

Station 9: Face piece Removal

Remove face piece. Avoid touching face with gloves. Deposit in container with plastic liner.

Equipment: Container (30 to 50 gallons)
Plastic liners

Station 10: Inner Glove Removal

Remove inner gloves and deposit in container with plastic liner.

Equipment: Container (20 to 30 gallons)
Plastic liners

C7.0 GENERAL WORK REQUIREMENTS

All personnel must satisfy the medical surveillance requirements as listed in 29 CFR Part 1910.120 Hazardous Waste Operations and Emergency Response, Final Rule.

All onsite personnel engaging in the investigation activities shall be participants in a medical surveillance program as set forth in 29 CFR Part 1910.120 Hazardous Waste Operations and Emergency Response, Final Rule.

The medical surveillance program includes a comprehensive physical examination to establish baseline values, a routine annual checkup, and a termination medical examination. At a minimum, the program examinations should include a medical and occupational history review, a screening physical examination, and a monitoring examination including clinical chemistries to evaluate the blood-forming, liver, kidney, respiratory, reproductive, and endocrine/metabolic functions.

Medical examinations are also conducted as soon as possible upon notification by an employee that they have been potentially overexposed. Either the site SSHO, Project Managers, or Project Coordinators should be notified in the event of a potential exposure (see Team Organization Section 2.2). Each employee has the authority and responsibility to notify management should a co-worker demonstrate symptoms or signs of exposure.

Note: The above notification applies to ESTCP and ENVIROGEN employees only. Contractors should notify their management in accordance with the Contractor's Standard Operating Procedures.

All personnel must also satisfy the following requirements:

1. Hazard communication training (OSHA 29 CFR Part 1910.1200).
2. HAZWOPER training (29 CFR Part 1910.120{e}). Workers whose tasks will be limited to non-intrusive activities (i.e. air monitoring, drum transport, etc.) shall have received 24-hours of initial safety and health training and annual refresher training (8 hours). Workers whose tasks will include intrusive activities (clearing & grubbing, well placement, etc.) shall have received 40-hours of initial safety and health training and annual refresher training (8-hr.) Supervisors shall have completed an additional 8-hours of Supervisory Training.
2. Complete three days of prior fieldwork under a qualified supervisor.
3. Supply documentation for medical surveillance and Item 1 & 2.
4. Attend the site-specific pre-project safety training session to review this HASP.

5. Dress in accordance with the task-specific plans.
6. No eating, drinking, smoking, gum or tobacco chewing is allowed in the defined work zones.
7. Wash hands and face before leaving the work area. Individuals will shower, as soon as possible, after leaving the job site at the end of the day.
8. Contact with contaminated surfaces or surfaces suspected of being contaminated should be avoided while the worker is unprotected. In the event that protective clothing is ripped or torn, the employee shall stop work and replace it with intact clothing as soon as possible. In the event of direct skin contact, the affected area is to be washed immediately with soap and water.
9. Any person under a physician's care, taking medication, or those who experience allergic reactions must inform the site SSHO.
10. The wearing of contact lenses for onsite personnel is prohibited.

All personnel entering areas requiring Level C protection shall complete the requirements above and:

1. Be respirator fit-tested within the previous year. Documentation must be provided to show respirator size, model, and manufacturer.
2. Be cleanly shaven.
3. Have been trained (per 29 CFR 1910.134 - 1998 revision) in the use of respiratory protection being used at the site.

C8.0 SITE ENTRY AND EXIT PROCEDURES

Entry Procedures

1. Sign site entry/exit log in treatment building.
2. Team briefing to review intended daily operations and safety procedure update.
3. Air monitoring check in accordance with Section 4.0.
4. Personnel dress out, as necessary, followed by team proceeding to the work areas.

Exit Procedures

1. All personnel exit from the work zone according to procedures outlined in Section 6.0.
2. Ensure that the work area and all equipment are secured.
3. Sign site entry/exit log in treatment building.

C9.0 VISITOR PROTOCOL

C9.1 Non-Exclusion Zone Work Areas

All visitors who visit the site, and other work areas that are not part of a defined exclusion zone must comply with the following requirements and set forth in Section 7.0.

1. Visitors must sign visitor entry/exit log and notify SSHO of presence onsite.
2. Visitors must have reviewed the site-specific HASP and must agree to comply with the guidelines set forth in this plan.
3. Visitors will be limited to Level D work areas unless they provide documentation of training, etc. as outlined in Section 7.0 of this plan.
4. Visitors must sign visitor entry/exit log and notify SSHO of departure.

C9.2 Exclusion Zones

All visitors who proceed into areas where they may come in contact with contaminated materials must comply with the following requirements and those set forth in Section 7.0.

1. Visitors must have reviewed the site-specific HASP and must agree to comply with the guidelines set forth in this plan.
2. Visitors will be limited to Level D work areas unless they provide documentation of training, etc. as outlined in Section 7.0 of this plan.
3. Visitors are required to provide their own Personal Protective Equipment (PPE) as outlined in Section 3.1 of this plan.
4. Visitors must be escorted by the site SSHO or their designee.
5. Visitors must sign visitor entry/exit log and notify SSHO of departure.

C10.0 WEATHER-RELATED CONCERNS

C10.1 HEAT STRESS

Heat stress is a significant hazard, especially for workers wearing protective clothing. Depending on the ambient conditions and the work being performed, heat stress can occur very rapidly - within as little as 15 minutes. The keys to preventing heat stress is slowly acclimatizing to the heat, educating personnel on heat hazards and effects, and of proper controls and work practices. Encourage workers to drink water at regular short intervals throughout the day.

C10.1.1 Heat Rash

Heat rash (prickly heat) may result from continuous exposure to heat or humid air where the skin remains wet due to lack of evaporation, sweat ducts become plugged, and a skin rash appears. This uncomfortable rash can be prevented by resting in a cool place during breaks and by good daily personal hygiene.

C10.1.2 Heat Cramps

Heat cramps are muscular spasms, usually in abdomen or limbs due to loss of salt following profuse sweating. The drinking of large quantities of water tends to dilute the body's fluids, while the body continues to lose salt.

First Aid:

1. Apply warm moist heat and pressure to reduce pain
2. Give electrolyte drinks by mouth (e.g. Gatorade, Quench, etc.)

C10.1.3 Heat Exhaustion

Caution: Persons with heart problems or on a "low sodium" diet who work in hot environments should consult a physician about what to do under these conditions.

Heat exhaustion is a result of overexertion in hot or warm weather. It is highly possible for an onsite worker to experience heat exhaustion due to the use of worker protective coveralls, boots, gloves, and respiratory protection, even if ambient temperatures are mild.

Symptoms:

1. Pale, clammy skin
2. Profuse perspiration
3. Weakness
4. Headache
5. Nausea

First Aid:

1. Get victim into shade or cooler place
2. Immediately remove any protective clothing
3. Victim should drink plenty of fluids, preferably water or electrolyte replacements
4. Victim should lie down with feet raised
5. Fan and cool victim with cool, wet compresses
6. If vomiting occurs, transport to hospital

Prevention:

1. If possible, schedule as much work for early morning or evening during warm weather
2. Work in shifts and follow with frequent breaks at the workers' discretion
3. Have cool liquids at exclusion zone border for personnel to continuously replace body fluids
4. The SSHO or designee should continually monitor personnel for signs of heat stress

C10.1.4 Heat Stroke

The body's temperature control system that causes sweating stops functioning correctly in the case of heat stroke. Brain damage and death may occur if body core temperature is extremely elevated and is not reduced.

Symptoms:

1. Flushed, hot dry skin (*usually, but not always*)
2. High body core temperature (>105°F)
3. Dizziness
4. Nausea
5. Headache
6. Rapid pulse
7. Unconsciousness

First Aid:

HEAT STROKE IS A LIFE THREATENING CONDITION: Summon emergency medical personnel immediately. Immediately take precautions to cool body core temperature by removing clothing and sponging body with alcohol, or cool water, or placing in tub of cold water for body core cooling. Give cool

liquids to the victim only if conscious. Use fans or air conditioning, if available, to cool victim, but only if air is less than 98 degrees F. Victim should be transferred to emergency room as soon as possible.

C10.2 COLD STRESS

Cold injury (frostbite and hypothermia) and impaired ability to work are dangers at low temperatures and at extreme wind-chill factors. To guard against them: wear appropriate clothing; have warm shelter readily available; carefully schedule work and rest periods, and monitor workers' physical conditions. Learn to recognize warning symptoms, such as reduced coordination, drowsiness, impaired judgment, fatigue and numbing of toes and fingers.

C10.2.1 Frostbite

Frostbite is a localized injury that results from the freezing of tissue. It is most common to the fingers and toes (due to reduced circulation in the extremities), and on the face and ears (they are most commonly exposed to the weather).

For frostbite to occur, there must be subfreezing temperatures. It is most prevalent in very cold temperatures (20°F or less), or when cold temperatures are exacerbated by the wind (wind chill).

Symptoms:

1. Pre-Frostbite - The affected area feels painfully cold, but usually flushed (rosy-red) in color.
2. First-Degree Frostbite (Frost Nip) - Crystallization in superficial tissues. The affected area no longer feels cold, and is completely numb. Skin coloration is a small white or grayish-yellow waxy patch. Immediate treatment will completely reverse the condition with no ill effects.
3. Second-Degree Frostbite (Deep) - A deep freezing of the fluids in the underlying soft tissues. Symptoms and treatment are the same as for first degree frostbite. It usually results in a death of tissue-blistering, black skin, loss of toes, etc., with possible complications from gangrene.

First Aid:

1. Cover and protect the affected part
2. Provide extra clothes
3. Bring victim indoors as soon as possible
4. Give warm liquids to drink (DO NOT GIVE ALCOHOL)
5. Rewarm frozen tissue quickly by immersing it in warm water (if thawed and refrozen, warm at room temperature)
6. Do not rub skin - causes tissue death
7. Do not apply heat
8. Do not break blisters
9. Do not allow to walk after feet thaw
10. Discontinue warming as soon as part becomes flushed
11. Exercise thawed part
12. Separate fingers and toes with sterile gauze
13. Elevate frostbitten parts
14. Seek medical attention due to chance of infection or gangrene

C10.2.2 Hypothermia

Hypothermia is a systemic lowering of the body temperature. Extreme cases (core temperature below 90°F) result in death. Hypothermia is the most common cause of death for persons involved in outdoor/wilderness activities. It does not require freezing temperatures, and in fact can occur in ambient air temperatures as high as 70°F. Wind and wetness greatly accentuate hypothermia by enhanced cooling. Typical hypothermia conditions are a rainy, windy day with 50°F air temperatures.

Symptoms:

1. First Stage - "goose bumps," shivering, feeling chilly
2. Second Stage - violent shivering, blue lips, pale complexion, feeling extremely cold
3. Third Stage - no longer feel cold, lack of coordination, mild unresponsiveness, drowsiness, stumbling
4. Fourth Stage - failing eyesight, victim barely responsive, cannot speak, barely able to or cannot walk
5. Fifth Stage - coma and rapid death

Treatment:

For all levels - remove wet, frozen, or restrictive clothing. Dry the victim; rewarming should be external heat that completely envelops the victim (a warm vehicle, a warm room, a sauna, a tub of warm water, or place the victim in a sleeping bag with another person, etc.). Do not use a source of radiant heat that will warm only one side of the victim. Be prepared to administer CPR. Do not give the victim alcohol.

1. First Stage - Put on hat, shirt, additional clothing, windbreaker, etc.; eat and drink; exercise tense muscles
2. Second Stage - Same as above, only more so; warm drinks and rewarming if possible

NOTE: In hypothermia beyond second stage, the victim can no longer warm himself, and must have an external heat source.

3. Third Stage - Rewarming, warm food and drink
4. Fourth Stage - Remove wet or cold clothing, and gradually rewarm victim so that blood trapped in extremities is rewarmed before it is circulated back into inner body, in order to prevent afterdrop. Afterdrop is a further lowering of the body core temperature that results from recirculation of cold blood. Avoid hot, radiant heat sources that will warm surface blood before inner blood has been warmed. Do not give warm drinks which fool the body internally into feeling it is warm (i.e. alcohol). Fourth-Stage hypothermia victims are best treated by supervised, experienced medical help, as complications can cause death. Place victim in warm vehicle and evacuate immediately to a medical facility.
5. Fifth Stage - Gradual rewarming, but requires sophisticated medical help to prevent death from aftershock (a recirculation of chilled blood causing heart fibrillation).

C11.0 EMERGENCY CONTINGENCY PLAN

The potential for an emergency situation during work on this site is considered to be low to moderate. Safety precautions will be taken to avoid emergency situations. However, if an incident occurs that requires declaring an emergency, all personnel will assemble at the designated area located outside the gate of the study area enclosure (see map Appendix A). Arrangement for decontamination, evacuation, and/or transportation to a medical facility will be made at that time. The proper emergency personnel will be notified immediately. The client and the appropriate personnel will be notified of the incident as soon as possible (see Contingency Contacts , Page vi in the front of this document).

Preparatory steps necessary for responding to an emergency are given below and they should be complied with before beginning any work at the site.

C11.1 SITE-SPECIFIC CONTINGENCY PLANS

The contingency plans for this site include measures to prevent emergencies or, if any emergency occurs, limit the negative impact. The three major aspects of the plan are:

Preventative Measures - These are the measures that should prevent or limit an emergency incident.

Response Actions - Response actions are the specific actions to be taken as a response to an emergency situation.

Notification - Organizations or personnel to be notified in case of an emergency.

C11.1.1 Preventative Measures

The following measures will be implemented to prevent or limit an emergency incident:

1. Use of prescribed PPE during all onsite activities.
2. Determining the wind direction and using that information not only to locate the contamination reduction zone (CRZ) upwind of the work area (for outdoor activities) but also to plan the evacuation route. This shall be a daily responsibility of the SSHO.
3. Evacuation Route(s): Upon arrival at the site, and following definition of the work zones, the SSHO will determine all possible evacuation routes and communicate these to all field personnel during the first onsite meeting and whenever exclusion zones are changed.

4. Hospital/Infirmary Route: For medical treatment beyond onsite first aid, follow the directions provided in the front of this document under Directions to Local Hospital (see Page vi in the front of this document). The SSHO shall drive the route to the local hospital prior to work beginning on the site.
5. Fire Prevention: As a part of general work safety practices, sources of ignition (excluding vehicles and portable heaters for personnel shelters) shall be restricted from all work areas unless a hot work permit is completed. Fire extinguishers will be located at the entrance to the CRZ from the Support Zone and in the project support vehicle.
6. Absorbent materials, shovels, and plastic liners will be kept on the site to contain spills or leaks.
7. Work Stoppage (refer to Section 2.3 above): Field operations shall be discontinued by order of the Project Manager, SSHO or both, when weather conditions pose a threat to a safe working environment. Items to be considered prior to determining if work should continue are:
 - Potential for heat stress or heat-related injuries
 - Potential for cold stress or cold-related injuries
 - Treacherous weather-related working conditions
 - Severe weather conditions (e.g. electrical storms)
8. Training specific to Emergency Contingency Plans at the site (reference item #3 above).

C11.1.2 Response Actions

Following any and all response actions given below, all appropriate authorities must be immediately notified (see Contingency Contacts located in the front of this document) in accordance with the following notification subsection.

All personnel in both the restricted and non-restricted areas will evacuate and assemble outside the gate of the study area enclosure (see map Appendix A). The location shall be upwind of the site as determined by the wind direction indicator. For efficient and safe site evacuation and assessment of the emergency situation, the SSHO will have authority to initiate proper action if contingency services are required. Under no circumstances, will incoming personnel or visitors be allowed to proceed into the area once the emergency signal has been given (the SSHO will sound a vehicle or air horn three times for 5-second intervals). The SSHO shall ensure that access for emergency equipment is provided and that all combustion apparatus has been shut down once the alarm has been sounded.

C11.1.3 Notification

Upon establishing that all onsite personnel have been accounted for and are safe, the following will be notified of the emergency as appropriate (see Contingency Contacts located in the front of this document, Page v, for telephone numbers):

Incident responder calls SSHO. The SSHO contacts, in order:

- Local fire department
- Local police department
- ENVIROGEN Project Manager
- Client Project Coordinator

C11.2 UNEXPECTED VAPOR/PARTICULATE RELEASE

In the event that volatile organic compounds or particulates migrate from the designated work zone and potentially endanger unprotected personnel or the community, all onsite activities will cease until the release is brought under control.

Potential or Actual Fire or Explosion

Immediately evacuate the site (the SSHO will sound a vehicle or air horn three times for 5-second intervals). If potential for fire or explosion exists in the defined work zone(s) or if an actual fire or explosion has taken place, the following will be notified (see the front of this document for telephone numbers, Page v):

- Persons in immediate area
- Local fire department
- Local police department
- ENVIROGEN Project Manager
- Client Project Coordinator

C11.3 PERSONNEL INJURY

In the event of an injury, all personnel directly involved or summoned for assistance will assemble at the decontamination station or alternative site pre-designated by the SSHO. If the injured person is immobile, one or more persons will remain nearby to provide any necessary first aid. If medical help is needed, the site SSHO will summon the appropriate assistance as outlined below, or arrange for transportation to a medical facility as necessary. The extent of decontamination of any injured personnel, and those coming to his or her aid, is a judgment that must be made on a case-by-case basis.

C11.4 FIRST AID FOR OVEREXPOSURE

As outlined under the medical surveillance requirements in Section 7.0, medical evaluations are conducted as soon as possible upon notification by an employee that there has been a potential overexposure. The SSHO, Project Managers, and ESTCP are to be notified. Each employee has the authority and responsibility to notify management if they or a co-worker demonstrate signs of overexposure.

Note: The above notification applies to all ESTCP, Contractor and ENVIROGEN employees. However, after contractors notify their management in accordance with their own operating and reporting procedures, they are solely responsible for follow-up and first aid.

Working on a HAZWOPER regulated site can pose potential overexposure for onsite workers to a variety of stressors. For the chemicals identified at this site, the following paragraphs list signs and symptoms of overexposure. All onsite workers shall be familiar with and trained on this information. Treatment for overexposures should follow guidelines listed in the respective MSDSs.

Inhalation

Symptoms: Dizziness, nausea, lack of coordination, headache, irregular and rapid breathing, weakness, loss of consciousness, coma

Treatment:

- a) Bring victim to fresh air. Rinse eyes or throat if irritated
- b) If symptoms are severe (victims vomits, is very dizzy or groggy, etc.), evacuate to hospital
- c) Be prepared to administer CPR if certified
- d) Seek medical assistance

Dermal

Symptoms: Irritation, rash, or burning

Treatment:

- a) Flush affected area with water for at least 15 minutes
- b) Apply a clean dressing
- c) Seek medical assistance

Ingestion

Symptoms: Dizziness, nausea with stomach cramps, loss of consciousness, coma

Treatment: a) Evacuate victim to hospital

Eye

Symptoms: Redness, irritation, pain, impaired vision

Treatment: a) Flush with copious amounts of water for at least 15 minutes
b) Seek medical assistance

C11.5 EVACUATION PLAN

In the event of an onsite evacuation (i.e., fire, explosion, tornado, etc.), the following plan will be activated:

1. The SSHO will give a signal consisting of five 1-second blasts of a vehicle or air horn. (The SSHO or designee will sound alarm.)
2. All personnel will immediately evacuate to the designated area located outside of the gate of the study area enclosure. The SSHO will determine and post onsite site evacuation routes to the support zone.

C11.6 SPILL PREVENTION AND RESPONSE

In the event of a leak or a spill, the area will be cordoned off and evacuated. Aside from initial efforts to prevent spreading of contaminants, the spill must be contained and cleaned up by authorized personnel only. All materials will be disposed of in a proper manner.

The following will be notified in the event of a spill (see Contingency Contacts in the front of this document, Page v):

- People in immediate area (if affected)
- ENVIROGEN Project Coordinator
- Local fire department (if needed)
- Local police department (if needed)
- U.S. EPA (as needed)
- National Response Center (as needed)
- U.S. Coast Guard (as needed)

Clean-up will be conducted in accordance with applicable federal, state, and local laws and regulations by a qualified contractor.

C11.7 ONSITE COMMUNICATIONS FOR EMERGENCY SITUATIONS

The following standard hand signals will be used onsite as a means of communications:

- Hand gripping throat - Cannot breathe
- Grip partner's wrist or both hands around waist - Leave area immediately
- Hands on top of head or hand waving - Need assistance
- Thumbs up - OK; I am all right; I understand
- Thumbs down - No; negative

C12.0 HEALTH AND SAFETY PLAN APPROVAL/SIGN-OFF FORM

I have read, understood, and agree with information set forth in this Health and Safety Plan and discussed in the Personnel Health and Safety briefing.

_____ Name	_____ Signature	_____ Organization	_____ Date
_____ Name	_____ Signature	_____ Organization	_____ Date
_____ Name	_____ Signature	_____ Organization	_____ Date
_____ Name	_____ Signature	_____ Organization	_____ Date
_____ Name	_____ Signature	_____ Organization	_____ Date
_____ Name	_____ Signature	_____ Organization	_____ Date
_____ Name	_____ Signature	_____ Organization	_____ Date
_____ Name	_____ Signature	_____ Organization	_____ Date
_____ Name	_____ Signature	_____ Organization	_____ Date
_____ Name	_____ Signature	_____ Organization	_____ Date

If all tasks are not addressed in the aforementioned scope of work, an addendum will be issued.

Personnel Health and Safety Briefing Conducted by:

_____ Name	_____ Signature	_____ Organization	_____ Date
---------------	--------------------	-----------------------	---------------

APPENDIX C-A
EMERGENCY ROUTES

DIRECTIONS TO HOSPITAL (EMERGENCY ROUTE MAP)

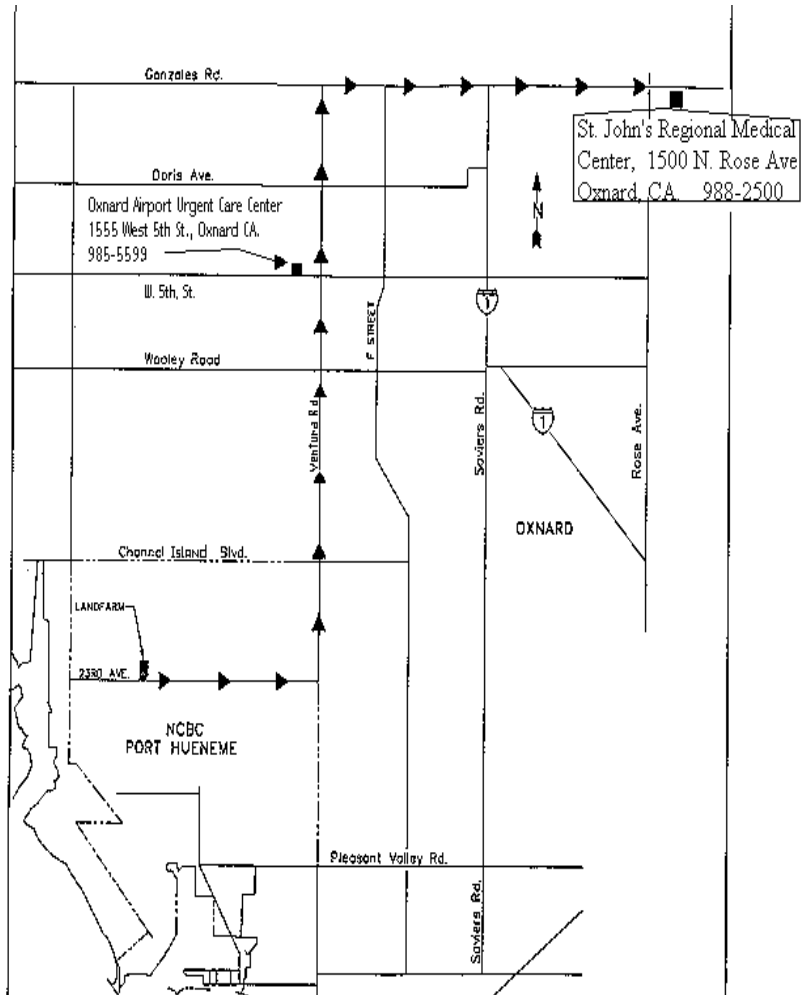

APPENDIX C-B

MSA ULTRA TWIN
INSPECTION CHECKLIST PRIOR TO FIELD USE

MSA ULTRA TWIN INSPECTION CHECKLIST PRIOR TO FIELD USE

1. Exhalation Valve - pull off plastic cover and check valve for debris or for rips in the neoprene valve (which could cause leakage).
2. Inhalation Valves (two) - Look inside the facepiece and visually inspect neoprene valves for tears. Make sure that the inhalation valves and cartridge receptacle gaskets are in place.
3. Ensure an exterior protective cover lens is attached to the lens.
4. Ensure you have the proper cartridge (check with SSHO if questionable).
5. Ensure that the face piece harness is not damaged. The serrated portion of the harness can fragment which will prevent proper face seal adjustment.
6. Ensure the speaking diaphragm retainer ring is hand tight.
7. Don the respirator and perform the positive/negative pressure fit-check procedures.

POSITIVE/NEGATIVE FIT CHECK PROCEDURES

The respirator must be subjected to the following tightness test before each use:

Test respirator for leakage using a positive pressure method. Lightly place palm over exhalation valve cover. Gently exhale. A slight positive pressure should build up inside the respirator. If any leakage is detected around the facial seal, readjust head harness straps and repeat test until there is no leakage. If other facial seal leakage is detected, the condition must be investigated and corrected before another test is made. A negative pressure test may also be performed on certain types of respirators. Lightly place palms over cartridges or filter holders. Gently inhale and the face piece should collapse against the face. The respirator must pass the tightness tests before used. The respirator will not furnish protection unless all inhaled air is drawn through suitable cartridges or filters.

APPENDIX C-C

**PROCEDURE FOR CLEANING AND DISINFECTING
RESPIRATORS**

PROCEDURE FOR CLEANING AND DISINFECTING RESPIRATORS

1. Remove cartridges (if of the air-purifying type) and dispose.
2. Remove any gross contamination with water and paper towels, taking care not to scratch the plastic lens.
3. Mix cleaning solution approved by respirator manufacturer, or a mild solution of dish soap (i.e. ivory, dawn, joy, etc.) and water in a designated bucket.
4. Soak respirator in solution for about 10 minutes.
5. Dip respirator into rinse designated bucket several times.
6. Rinse respirator with copious amounts of fresh water.
7. Shake excess water from respirator, dry with paper towels, ensure that exhalation valve is clean, dry, and operable, and place into new plastic bag.

APPENDIX C-D

PROJECT PARTICIPANTS' SITE ENTRY/EXIT LOG

APPENDIX C-E
VISITOR'S SITE ENTRY/EXIT LOG

APPENDIX C-F
LADDER SAFETY

LADDER SAFETY

1. Except where either permanent or temporary stairways or suitable ramps or runways are provided, ladders described in this subpart shall be used to provide safe access to all elevations.
2. The use of ladders with broken or missing rungs or steps, broken or split side rails, or with other faulty or defective construction is prohibited. When ladders with such defects are discovered, they shall immediately be withdrawn from service and disposed of properly.
3. Portable ladders shall be placed on a substantial base at a 4-1 pitch, have clear access at top and bottom, extend a minimum of 36 inches above the landing (i.e. upper contact point), or where not practical, be provided with grab rails and be secured against movement while in use.
4. Portable metal ladders shall not be used for electrical work or where they may contact electrical conductors.
5. Ladders must not be used on slippery surfaces unless secured or provided with slip-resistant feet to prevent accidental movement.
6. All persons utilizing ladders and stairways must be trained to recognize hazards related to ladders and stairways and to use proper procedures to minimize these hazards.
9. When climbing a fixed ladder greater than 20'-0", a ladder belt should be used to avoid slippage and falling. If a safety cage is provided, this is deemed adequate.

APPENDIX C-G
EYE AND FACE PROTECTION

EYE AND FACE PROTECTION
(In accordance with 29 CFR 1926.102)

1. Employees shall wear approved eye and face protection equipment when machines or operations present potential eye or face injury from physical, chemical, or radiological agents.
2. Employees whose vision requires the use of corrective lenses in spectacles, when required by this regulation to wear eye protection, shall be protected by goggles or spectacles of one of the following:
 - a. Spectacles whose protective lenses provide optical correction.
 - b. Goggles that can be worn over corrective spectacles without disturbing the adjustment of the spectacles.
 - c. Goggles that incorporate corrective lenses mounted behind the protective lenses.
3. Face and eye protection equipment shall be kept clean and in good repair.
4. When handling acids or caustics (i.e. corrosives), full face protection in the form of a faceshield or full-face respirator shall also be worn.

APPENDIX C-H
HEAD PROTECTION

HEAD PROTECTION
(In accordance with 29 CFR Part 1926.100)

1. Head protection will be worn where there is a possible danger of head injury from impact, from falling or flying objects, or from electrical shock and burns.
2. Helmets for the protection of employees against impact and penetration of falling and flying objects shall meet the specifications contained in American National Standards Institute (ANSI), X89.2-1986, Safety Requirements for Industrial Head Protection.

APPENDIX C-I

DONNING PPE

DONNING PPE

A routine will be established and followed at the site for donning the PPE. The procedures will be discussed in detail during the site-safety meeting before starting the project and briefly during the daily site-safety meetings.

Before wearing any level of PPE, it will be checked to ensure that it is in proper condition for the purpose for which it is intended. Also, workers with any minor injuries and/or openings in the skin surface (such as cuts and scratches) will be attended to in order to protect such areas which may potentially enhance exposure effects. Workers with large cuts, rashes, or other such skin damage will not be allowed to don PPE.

After donning the equipment, its fit will be evaluated by either the Onsite Supervisor or the SSHO before the worker is allowed to enter the exclusion zone.

APPENDIX C-J

NOISE

NOISE

(In accordance with 29 CFR Part 1910.95)

A noise hazard has been identified in the trailer containing the blowers for sparging and SVE. The effects of this noise can include:

- Workers being startled, annoyed, or distracted
 - Physical damage to the ear, pain, and temporary and/or permanent hearing loss
 - Communication interference that may increase potential hazards due to the inability to warn of danger and the proper safety precautions to be taken
1. When engineering or administrative controls fail to reduce the noise level to within the levels shown in Table 4, personal protective equipment shall be provided and used to reduce the noise to an acceptable level.
 2. Protection against the effects of occupational noise exposure shall be provided when the sound levels are measured above 90 dBA (i.e. require an individual to raise their voice to communicate in casual conversation). Engineering and/or administrative controls shall be utilized whenever possible to keep exposures below the allowable limits.
 3. Exposure to noise shall not exceed 115 dB at any time.
 4. Where the sound levels exceed an 8-hour time-weighted average of 85 decibels measured on the A scale, a continuing, effective hearing conservation program shall be administered.
 5. If the excessive noise (above normal talking levels) cannot be eliminated by standard engineering practices, it shall be further reduced by the use of Personal Protective Equipment (PPE) (e.g., earmuffs, ear plugs). Cotton balls are strictly forbidden, as is any homemade noise reducer.
 7. The SSHO shall assure that sound level measurements are taken on any equipment or in any areas suspected of exceeding 90 dBA
 6. Any equipment or areas associated with noise exceeding 90 dBA shall be identified with signs stating that hearing protection is required.

APPENDIX D

QUALITY ASSURANCE PLAN

Appendix D Quality Assurance Plan

1.0 Purpose and Scope

This section presents the project-specific Quality Assurance Plan (QAP) for the aerobic biostimulation demonstration. This QAP specifies the procedures the demonstration will follow to ensure it generates analytical data of known quality. These procedures are integral to the demonstration and complement the sampling and quality control procedures presented in [Sections 5 and 7](#).

Both laboratory analytical and field screening methods will be used to measure parameters indicative of the aerobic biostimulation demonstration's performance. The purpose of this QAP is to outline steps to ensure that: (1) data generated during the course of the demonstration are of an acceptable and verifiable quality (*i.e.*, quality assurance); and (2) a sufficient number of control measurements are taken for proper data evaluation (*i.e.*, quality control).

2.0 Quality Assurance Responsibilities

Key personnel for the project and their responsibilities are outlined below. [Figure B-1](#) shows the QA reporting structure.

Dr. Robert Steffan is the Principal Investigator for the demonstration, and has overall project QA responsibility.

Mr. Yassar Farhan, Ph.D., is the Project Coordinator for the demonstration, and is responsible for allocating resources to the project and coordinating efforts between the demonstration site and Envirogen's office.

Dr. Todd Webster is the Project Manager for the demonstration, and is responsible for overseeing the operation, testing, and sampling of the aerobic biostimulation demonstration in the field. Dr. Webster will report directly to Dr. Steffan.

Mr. William Guarini is Envirogen's Vice President of Government Programs. Mr. Guarini will provide overall project guidance from a business perspective, and ensure that a commercial focus is maintained throughout the project.

Dr. Randi Rothmel is the Manager of Envirogen's Customer Service and Analytical Laboratory, and will have laboratory QA responsibility during the project. Dr. Rothmel will perform external audits of the independent laboratories. Dr. Rothmel will report directly to Dr. Steffan.

3.0 Data Quality Parameters

This section describes all of the measurements that will be made to achieve the project's objectives.

The laboratory program for the aerobic biostimulation demonstration will include measuring the concentrations of VOCs in groundwater and soil samples, as well as organics (TOC), inorganics (total-phosphate, ammonia nitrogen, and anions), and other performance-related parameters (alkalinity, and total heterotroph plate counts) in groundwater monitoring well samples. These measurements are outlined in **Table B-1**. Envirogen's analytical laboratory (New Jersey-certified, non-CLP) will be used for routine off-site analysis of these parameters. For all groundwater analyses, standard U.S. EPA methods will be used, as outlined in: (1) *U.S. EPA Test Methods for Evaluating Solid Waste, Physical/Chemical Methods SW846*, Third Edition, revised November 1986, Update II, September 1994, and Update IIB, January 1995; (2) *Methods for Organic Chemical Analysis of Municipal and Industrial Wastewater* (EPA-600/4-85 054); (3) *U.S. EPA Methods for Analysis of Water and Wastes* (EPA-600/4-79-020, 1979); and (4) *Methods for Determination of Organic Compounds in Drinking Water* (EPA-600/4-88/039). As a QA/QC measure, 5 percent of the laboratory groundwater VOC measurements will be performed by an independent laboratory (split samples).

Additional groundwater and soil vapor parameters may be screened in the field using electronic meters. These parameters will be measured using methods approved or accepted by the U.S. EPA for reporting purposes. Groundwater field-measured parameters will include ORP, pH, specific conductivity, DO and temperature. Soil vapor and ambient air quality field-measured parameters will include propane.

4.0 Calibration Procedures, Quality Control Checks, and Corrective Action

4.1 Quality Control Objectives

The goal of the biostimulation demonstration is to accomplish the following: 1) Evaluate the efficacy of the biostimulation technology with respect to MTBE degradation; 2) Develop the design criteria and protocol necessary for full-scale application of the technology; and 3) Evaluate

the cost-effectiveness of the technology compared to existing MTBE remediation technologies. As such, the project data quality objectives (Project DQOs) are as follows:

- (1) collect data of sufficient quantity and quality to determine destruction efficiencies and biodegradation rates of MTBE as a function of oxygen addition and propane co-substrate;
- (2) collect data of sufficient quantity and quality to assess (a) site-specific aerobic biostimulation operating characteristics, (b) the extent of aerobic biostimulation operator attention required, and (c) the optimal range of aerobic biostimulation for treatment of groundwater at the demonstration site;
- (3) collect data suitable for use in designing a full-scale aerobic biostimulation system; and
- (4) collect data suitable for preparing a cost comparison analysis.

To meet the Project DQOs stated above, individual measurements must meet particular quantitative QA objectives for precision, accuracy, method detection limits, and completeness, as well as qualitative QA objectives for comparability and representativeness. This section describes the quality assurance objectives for the aerobic biostimulation demonstration in order to meet the specific Project DQOs stated above.

The specific data QA objectives are as follows:

- ◆ establish sample collection and preparation techniques that will yield results representative of the media and conditions analyzed;
- ◆ collect and analyze a sufficient number of field blanks to evaluate the potential for contamination from ambient conditions or sample collection techniques;
- ◆ collect and analyze a sufficient number of field duplicates to assess the homogeneity of samples received by the laboratory as well as the homogeneity of contaminants in the matrix; and
- ◆ analyze method blanks, laboratory duplicates, matrix spikes, matrix spike duplicates, and surrogate spikes as required by the specific analytical methodology to determine if QA goals established for precision and accuracy are met for off-site laboratory analyses.

The data generated during the demonstration will be used primarily for assessing the efficacy of the aerobic biostimulation technology for remediating MTBE contaminated groundwater. In an effort to produce data that will be useful for this assessment, definitions of data usage, data types, data acquisition, and data quality level have been made for each medium. These defined data parameters are collectively defined as DQOs. **Table B-1** presents the DQOs for this technology demonstration. The aerobic biostimulation demonstration system sampling locations listed in **Table B-1** are shown in **Figure B-2**. **Table B-1** correlates data use with the required degree of

analytical sophistication. This approach is based on the generalized DQOs presented by the U.S. EPA (1987). Five levels of data quality are used, ranging from Level I (field screening) to Level V (CLP special analytical services). Due to the variation in the types of monitoring throughout the demonstration, data quality objective Levels I and III will be used. Several geochemical parameters, such as pH, temperature, and DO, will be determined in the field with immediate response required for process control (Level I). All off-site analytical laboratory measurements will be performed using Level III criteria for production of validated data.

Quality assurance objectives have been established to evaluate the criteria of precision, accuracy, and completeness. The evaluation of these criteria for validated (Level III) off-site laboratory analyses will be based upon sample duplicates, matrix spikes, matrix spike duplicates, and surrogates, as described in [Section 4.3](#). The criteria for precision, accuracy, and completeness for all validated data will follow the guidelines established in [Section 6.1](#). Evaluation of method detection limits (MDLs) will be in accordance with the procedures outlined in Appendix B to Part 136 “Definition and Procedures for the Determination of Method Detection Limit - Revision 1.1,” 40 Code of Federal Regulations (CFR) 136, 1984.

4.2 Analytical Procedures and Calibration

4.2.1 Analytical Procedures. All laboratory analyses will be performed according to the established SW-846 and U.S. EPA Methods (see [Table B-.1 and Tables 1 through 5](#)) found in *Envirogen’s Standard Operating Procedures, Volume I - Limited Chemistry (Revised 11/96), Volume II - Organic Analysis (Revised 11/96), Analytical & Treatability Laboratories - SW-846 Methods (Revised 11/96)*.

4.2.2 Calibration Procedures and Frequency. Calibration refers to the checking of physical measurements of both field and laboratory instruments against accepted standards. It also refers to determining the response function for an analytical instrument, which is the measured net signal as a function of the given analyte concentration. These determinations have a significant impact on data quality and will be performed regularly. In addition, preventative maintenance is important to the efficient collection of data. The calibration policies and procedures set forth will apply to all test and measuring equipment. For preventative maintenance purposes, critical spare parts will be obtained from the instrument manufacturer.

All field and laboratory instruments will be calibrated according to manufacturers’ specifications. All laboratory instruments will be calibrated in accordance with established Standard Operating Procedures [*Envirogen Standard Operating Procedures - Quality Assurance and Quality Control - Volume I, Section I, and Volume II, Section I - Organic Analysis*]. Calibration will be performed prior to initial use and after periods of non-use. A record of calibration will be made in the field logbook each time a field instrument is calibrated. A separate logbook will be maintained by laboratory QA personnel similarly for laboratory instrumentation.

4.2.3 Process and Field Measurements. The portable instruments used to measure field parameters (*e.g.*, temperature, pH, etc.) will be calibrated in accordance with manufacturers' instructions. Flow measuring devices will not be calibrated if calibration requires the instruments to be sent back to the manufacturer. All other manufacturer-recommended checks of the flow instruments will be performed. The instruments will be calibrated at the start and completion of the demonstration. The pH, DO, and ORP probes will be calibrated prior to every site check during the demonstration.

4.2.3.1 Field Measurements: Groundwater. Groundwater will be assessed for dissolved oxygen and oxidation/reduction potential. Depth to groundwater measurements will be taken using a water interface probe.

Dissolved Oxygen, Temperature, pH, Conductivity and Oxidation/Reduction Potential

Groundwater samples will be collected using a low-flow peristaltic pump. Samples will be measured for dissolved oxygen, temperature, pH, conductivity and redox potential under continuous flow using a multi-probe water quality meter (Horiba Model U-22 or similar). In order to minimize aeration of the sample, a continuous flow-through cell will be used to provide a sampling chamber for the meter. A sufficient volume of water from the well or groundwater sampling point will be purged before sample collection to ensure that a sample representative of the formation is obtained.

Depth to groundwater

The depth to groundwater in site wells will be measured with a water interface probe (ORS Model #1068013 or equivalent). The probe lead is a 50- to 200-ft measuring tape with 0.01-ft increments. The probe gives a constant beep when it encounters the water table. The water-level measurement will be recorded in the field logbook and the probe decontaminated between measurements.

Groundwater Sampling

Prior to sampling, the well or sampling point identification will be checked and recorded along with the date and time in the field logbook. Groundwater samples will be collected using a low-flow peristaltic pump and flow-through cell and collected in a 40-mL VOA vial with a septa-lined cap. Samples will be analyzed for target compounds: MTBE, TBA, and BTEX; as well as biogeochemical parameters listed in **Table B-1**.

4.2.3.2 Field Measurements: Soil Gas. Soil gas will be field analyzed for concentration of propane. Soil gas analysis will be conducted during background soil gas surveys and demonstration system operation. Soil gas analysis in the field is a noncritical measurement.

Propane

An FID meter will be used on each well head to detect propane levels within the headspace of the well. If the propane levels in the wells exceed 25% of the LEL for propane (0.55%), the propane injection will be shut off. The LEL for propane is 2.2%.

Gaseous concentrations of propane will be analyzed using a Foxboro Flame Ionization Detector Model OVA 128 or equivalent. A digital display displays the soil gas concentrations within the sample instantaneously. The battery charge level will be checked to ensure proper operation. The air filters will be checked and, if necessary, will be cleaned or replaced before sampling is started. The instrument will be turned on and equilibrated for at least 10 minutes before conducting calibration or obtaining measurements. The sampling pump of the instrument will be checked to ensure that it is functioning. Low flow of the sampling pump can indicate that the battery level is low or that some fines are trapped in the pump or tubing.

Meters will be calibrated each day prior to use against purchased propane calibration standards. These standards will be selected to be in the concentration range of the soil gas to be sampled. The propane will be calibrated against two propane calibration gases (100 ppmv and 2000 ppmv). Standard gases will be purchased from a specialty gas supplier. To calibrate the instrument with standard gases, a Tedlar® bag (capacity approximately 500 mL) is filled with the standard gas, and the valve on the bag is closed. The inlet nozzle of the instrument is connected to the Tedlar® bag, and the valve on the bag is opened. The instrument is then calibrated against the standard gas according to the manufacturer's instructions. Next, the inlet nozzle of the instrument is disconnected from the Tedlar® bag and the valve on the bag is shut off. The instrument will be rechecked against atmospheric concentration. If re-calibration is required, the above steps will be repeated.

4.2.3.3 Ambient Air Quality Monitoring. Ambient air quality monitoring will be performed using a Foxboro Flame Ionization Detector Model OVA 128 or equivalent to monitor potential fugitive emissions of propane to the breathing zone. Ambient air quality monitoring will be conducted during all phases of operation to ensure that fugitive emissions of injected propane do not occur. The FID will be calibrated using the same standards and procedures as described in Section 4.2.3.2.

4.2.4 Laboratory Measurements. The calibration procedures for all off-site analyses will follow the established SW-846 and U.S. EPA guidelines for the specific method (see [Table 7.1 \(B-1\)?](#) for methods) [*Envirogen Standard Operating Procedures, Volume I - Limited Chemistry (Revised 11/96), Volume II - Organic Analysis (Revised 11/96), Quality Assurance and Quality Control - Volume I, Section I,), Quality Assurance and Quality Control - Volume II, Section I - Organic Analysis, Analytical & Treatability Laboratories - SW-846 Methods (Revised 11/96)*]. Certified standards will be used for all calibrations and calibration check measurements. The frequency and acceptance criteria for all off-site analyses will follow the guidelines outlined below, or more stringent guidelines if they are used by the off-site laboratory.

Initial Calibration. During initial calibration, a minimum of one blank and five calibration standards that bracket the validated testing range will be analyzed singularly on one day. The concentration of the calibration standards will be prepared in the solvent that results from all the preparation steps of the method, taking into account any steps that are part of the method. Concentrations in the solvent will correspond to those in the environmental matrix as if the method preparation steps had been performed.

In addition to the initial calibration standards, the analysis of an initial calibration check standard is required prior to analysis of any samples. If the method requires what could be an initial calibration each day an analysis is performed, then the calibration check standards will be analyzed once each week rather than each day.

If the results of the calibration check standard are not acceptable, immediate re-analysis of the calibration check standard will be performed. If the results of the re-analysis still exceed the limits of acceptability, the system will be considered to have failed calibration. Sample analysis will be halted and will not resume until successful completion of initial calibration. Corrective actions taken to restore initial calibration will be documented in the analyst's notebook.

Daily Calibration. Calibration standards will be analyzed each day analyses are performed to verify that instrument response has not changed from previous calibration. Each day before sample analysis, the highest concentration standard will be analyzed. The response must fall within the required percentage or two standard deviations of the mean response for the same concentration, as determined from prior initial/daily calibrations (see below). If the response fails this test, the daily standard will be re-analyzed. If the response from the second analysis fails this range, initial calibration will be performed before analyzing samples.

Each day after sample analyses are completed, the highest concentration standard will be analyzed. If the response is not within the required percentage or two standard deviations of the mean response from prior initial/daily calibrations, the daily standard will be re-analyzed. If the response from the second analysis fails this range, the system will be considered to have failed calibration. Initial calibration will be performed and all samples analyzed since the last acceptable calibration will be re-analyzed.

For non-linear or non-zero-intercept calibration curves, daily calibration will consist of analysis of the low, middle, and high standards at the beginning of the day. When sample analyses are completed at the end of the day, the low and high standards will be analyzed. Instrument responses for each concentration determination must fall within two standard deviations of the mean response, as described previously, for the appropriate standard. For calibrations fitted by the quadratic equation, a minimum of four standards over the validated range are required, along with the highest level standard analyzed at the end of the day. For all other equations, one more standard than needed to meet the degrees of freedom for any lack-of-fit is required, as a minimum.

Calibration Check Standards. Calibration check standards will be analyzed during each initial calibration. The calibration check standard will contain all analytes of interest for the method in question at a concentration near the upper end of the calibration range. Results of the calibration check standards must fall within the limits of acceptability as described below:

Case 1 - A certified check standard is available from the U.S. EPA or some other source with both the true value and limits of acceptability specified by the supplier. The results must fall within the limits specified by the supplier, or $\pm 10\%$ for inorganics and $\pm 25\%$ for organics, whichever is less.

Case 2 - A certified check standard is available from the U.S. EPA or some other source with a true value specified but without limits of acceptability. The results must fall within $\pm 10\%$ for inorganics and within $\pm 25\%$ for organics.

Case 3 - If no certified check standard is available, the laboratory shall prepare a check standard using a second source of reference material. This standard shall be prepared by a different analyst than the one who prepared the calibration standard. If weighing of the material is required, a different balance will be used, if possible. The results must fall within $\pm 10\%$ for inorganics and within $\pm 25\%$ for organics.

Case 4 - If there is only one source of reference material available, then the calibration and calibration check standards must be prepared from the same source. The standards shall be prepared by different analysts. If weighing is required, different balances will be used, if possible. The results must fall within $\pm 10\%$ for inorganics and within $\pm 25\%$ for organics.

For all cases listed above, after the seventh acceptable check standard, the limits of acceptability will be \pm two standard deviations, as determined from the first seven points.

For multi-analyte methods, the calibration check standard will contain all analytes of interest (target analytes). For the check standard to be deemed acceptable, at least two-thirds of the analytes must meet the limits of acceptability as defined above. In addition, if a single analyte falls outside the limits of acceptability for two consecutive times, then the calibration check standard will be deemed unacceptable. If a calibration check standard is not acceptable, the procedures detailed above will be followed.

4.3 Internal Quality Control Checks

4.3.1 Quality Control Samples. Internal QC data provide information for identifying and defining qualitative and quantitative limitations associated with measurement data. Analysis

of the following types of QC samples will provide the primary basis for quantitative evaluation of analytical measurement data quality:

Field QC Samples

- ◆ field blanks to evaluate the potential for contamination from ambient conditions, sampling equipment, or sample collection techniques;
- ◆ trip blanks to evaluate the presence of contamination from handling errors or cross-contamination during transport; and
- ◆ field split samples and collection duplicates to assess the homogeneity of samples received by the laboratory as well as the homogeneity of contaminants in the matrix, respectively.

Laboratory QC Samples

- ◆ method blanks, laboratory duplicates, matrix spikes, and matrix spike duplicates to determine if QA goals established for precision and accuracy are met by the analytical laboratory.

The number and types of field QC samples, which will be performed for each analysis during the demonstration, are shown in [Table B-1](#). The number, type, and frequency of off-site laboratory QC samples will be dictated by the validated SW-846 or U.S. EPA Methods used by the off-site laboratories. The SW-846 and U.S. EPA Methods shown in [Table B-1](#) specify the number and types of laboratory QC samples required during routine analysis. This information will be supplied with the data package provided by the laboratory.

In addition to the internal QC samples described above, the off-site laboratories will provide, at a minimum, additional internal QC checks as follows:

- ◆ use of standard analytical reference materials for traceability of independent stock solutions prepared for calibration stocks, control spike stocks, and reference stock solutions;
- ◆ verification of initial calibration curves with independent reference stock solutions according to [Section 4.1](#);
- ◆ verification of initial calibration curves with daily calibration standards according to [Section 4.1](#);
- ◆ verification of continued calibration control by analysis of calibration standards to document calibration drift;
- ◆ analysis of control spikes to document method performance and control with respect to recent performance.

An attempt will be made to analyze all samples within the calibrated range of the analytical method. Dilution of a sample extract with extracting solvent, or of the original sample matrix with distilled/de-ionized water, will be performed if the concentration of an analyte is greater than the calibrated range of the method.

Blank Samples

Blanks are artificial samples designed to detect the introduction of contamination or other artifacts into the sampling, handling, and analytical process. Blanks are the primary QC check of measurements for trace-level concentrations.

Equipment Blanks. Equipment blanks are used to assess the level of contamination of sampling devices. Dedicated, factory-cleaned polycarbonate liners will be used for sampling soils from the subsurface. The blanks will be prepared by running laboratory-grade purified water through the polycarbonate line into 40-ml VOA bottles for VOC analysis. Groundwater samples will be collected using a peristaltic pump with dedicated polyethylene and silicone tubing. Purified-water will be run through the tubing and collected into 40-ml VOA bottles for VOC analysis. Equipment blanks will be prepared at a minimum of 5% of all samples.

Field Blanks. Field blanks will be prepared to evaluate field conditions that may contribute to sample contamination. These blanks are equivalent to obtaining a background reading at the sampling site. Field blanks will be collected at a sample location at the time of field sampling. For groundwater and soil blanks, a blank sample will consist of a single sample container, or a suite of sample containers if appropriate (for methods requiring more than one sample container, *i.e.*, SW8260B), identical to that/those designated for the field sample, filled with laboratory-grade purified water. A sufficient quantity of “blank” water will be taken to an appropriate sample port location within the water’s original air-tight container. The blanks will then be prepared by pouring the water into the appropriate containers in an analogous fashion to the method used for sample collection. Field blanks will be analyzed for VOCs only. Field blanks for groundwater samples will be prepared at a minimum frequency of 5% of all samples for each method.

Trip Blanks. Trip blanks will be prepared by the analytical laboratory with purified water for groundwater and soil samples. The water will be sent to the site in the same containers to be used for collection of the samples. Trip blanks will be submitted at a frequency of one trip blank per shipment of samples for SW8260B VOC analysis. For non-VOC analyses, no trip blanks will be submitted.

Method Blanks. Method blanks will be prepared by the off-site laboratories to evaluate the impact of the analytical process on detected concentrations of contaminants. Method blanks will be prepared for each batch of samples run for a given method of analysis. The method blanks will be processed through the entire preparation and analytical procedure in the same manner as field

samples. The method blanks will provide data to assess potential systematic contamination of the measurement system.

Field Duplicate Samples. Duplicate samples will be analyzed to evaluate the accuracy of the analytical process. Two types of field duplicate samples will be analyzed as described below. Each type of duplicate will be run at a frequency of at least 5 percent of the total number of environmental samples. A comparison of the detected concentrations in the two duplicate samples will be performed to evaluate precision. The evaluation will be conducted using Equation B-2 for Relative Percent Difference (RPD) as described in [Section 6.1](#). The accepted range of RPD values for *field duplicate* samples for each laboratory analysis is shown in Tables B-2 and 3 under “FD RPD”.

Field Split Samples. The first type of duplicate is a field split sample, obtained by mixing the sample and splitting it into two sub-samples and submitting both samples for analysis. The purpose of splitting the sample is to assess the homogeneity of the mixed sample as received by the laboratory.

Collection Duplicate. The second type of duplicate is a collection duplicate. This duplicate is obtained by collecting a second discrete sample from the same sample location and submitting the collections as discrete samples to the laboratory. The purpose of the collection duplicate is to assess the homogeneity of the contaminants in the matrix.

Blind Samples. At least 20 percent of field blanks and duplicate samples will be submitted to the laboratory as “blind samples,” so that the laboratory does not know the location from which the sample was taken. [Section 4.2.3](#) describes the documentation of blind samples.

Laboratory Control Samples. Laboratory control samples will be used by the laboratory to assess analytical performance under a given set of standard conditions. These samples will be specifically prepared to contain some or all of the analytes of interest at known concentrations. The samples will be prepared independently of the calibration standards. Types of laboratory control samples that may be used are laboratory duplicates, matrix spikes, matrix spike duplicates, and surrogate spikes. Analysis of laboratory control samples will be used to estimate the analytical bias and accuracy by comparing measured results obtained during analysis to theoretical concentrations. This comparison will be measured using Equation B-1 as presented in [Section 6.0](#). The QA objectives for accuracy are outlined in [Tables B-2 and 3](#). The matrix spike/matrix spike duplicate samples will be used to evaluate precision according to Equation B-2. The accepted range of RPD values for *matrix spike/matrix spike duplicate* samples for each laboratory analysis is shown in [Tables B-2 and 3](#) under “MS/MSD RPD”. Stock solutions used to spike QC samples will be prepared independently of stocks used for calibration. Validation of spiked solutions will be performed on a regular basis before the solution is used.

4.3.2 Split Samples for Independent Laboratory Analysis. As a QA/QC measure, 5 percent of the aqueous samples for VOC analysis (using SW8264B) and 5 percent of the soil

samples for VOC analysis will be split and analyzed by both Envirogen's laboratory and an independent laboratory. The split samples will be collected according to the methods used to collect field split samples as outlined in Section . Results from the two laboratories will be compared for precision according to Equation B-2. The QA objective for precision for each analyte will correspond to the QA objectives listed in **Tables B-2 and 3** for field duplicate samples ("FD RPD"). At least one set of QC field samples (field blank, field split duplicate, and collection duplicate) for each matrix (groundwater and soil) will be sent to the independent laboratory to determine if the criteria for accuracy and precision are met.

4.3 Sample Documentation. The on-site Field Engineer will coordinate with the off-site laboratories for shipment and receipt of sample bottle, coolers, icepacks, COC forms, and Custody Seals. Upon completion of sampling, the COC will be filled out and returned with the samples to the laboratory. An important consideration for the collection of environmental data is the ability to demonstrate that the analytical samples have been obtained from predetermined locations and that they have reached the laboratory without alteration. Evidence of collection, shipment, laboratory receipt, and laboratory custody until disposal must be documented to accomplish this. Documentation will be accomplished through a COC Record that records each sample and the names of the individuals responsible for sample collection, transport, and receipt. A sample is considered in custody if it is:

- ◆ in a person's actual possession;
- ◆ in view after being in physical possession;
- ◆ sealed so that no one can tamper with it after having been in physical custody; or
- ◆ in a secured area, restricted to authorized personnel.

Sample custody will be initiated by field personnel upon collection of samples. As discussed in Section , samples will be packaged to prevent breakage or leakage during transport, and will be shipped to the laboratory via commercial carrier, or transported via car or truck.

Sample Identification

A discrete sample identification number will be assigned to each sample. These discrete sample numbers will be placed on each bottle and will be recorded, along with other pertinent data (such as use of a preservative) in a field notebook dedicated to the project. For blind samples, the sample location will be recorded in the field notebook along with a note indicating that the sample was submitted to the laboratory as a blind sample. The sample identification number will designate the sample location ("MW-" for specific monitoring well, and "B" for blind samples) and date collected. For example, a sample collected from the MW-4 groundwater sample port collected December 22, 1998 would be identified as follows:

Chain-of Custody Forms

The COC Record used by Envirogen's laboratory is shown on **Figure B-B-X.X**. The independent laboratories will supply their own COCs with sample bottles that are shipped to the site. All samples collected for off-site analysis will be physically inspected by the Field Engineer prior to shipment.

Each individual who has the sample in their possession will sign the COC Record. Preparation of the COC Record will be as follows:

- ◆ The COC Record will be initiated in the field by the person collecting the sample, for every sample. Every sample shall be assigned a unique identification number that is entered on the COC Record.
- ◆ The record will be completed in the field to indicate project, sampling person, etc.
- ◆ If the person collecting the samples does not transport the samples to the laboratory or ship the samples directly, the first block for "Relinquished By _____, Received By _____" will be completed in the field.
- ◆ The person transporting the samples to the laboratory or delivering them for shipment will sign the record for as "Relinquished By _____".
- ◆ The original COC Record will be sealed in a watertight container, taped to the top (inside) of the shipping container, and the shipping container sealed prior to being given to the commercial carrier. A copy of the COC Record will be kept on-site.
- ◆ If shipping by commercial carrier, the waybill will serve as an extension of the COC Record between the final field custodian and receipt by the off-site laboratory.
- ◆ Upon receipt by the off-site laboratory, the laboratory QC Coordinator, or designated representative, shall open the shipping container(s), compare the contents with the COC Record, and sign and date the record. Any discrepancies shall be noted on the COC Record.
- ◆ The COC Record is completed after sample disposal.
- ◆ COC Records will be maintained with the records for the project, and become part of the data package.

Laboratory Sample Receipt

Following sample receipt, the Laboratory Manager will:

- ◆ Examine all samples and determine if proper temperature has been maintained during transport. If samples have been damaged during transport, the remaining samples will be carefully examined to determine whether they were affected. Any samples affected shall be considered damaged. It will be noted on the COC Record that specific samples were damaged and that the samples were removed from the sampling program. Field personnel will be instructed to re-sample, if appropriate.
- ◆ Compare samples received against those listed on the COC Record.
- ◆ Verify that sample holding times have not been exceeded.
- ◆ Sign and date the COC Record, attaching the waybill if samples were shipped for off-site analysis.
- ◆ Denote the samples in the laboratory sample log-in book which will contain, at a minimum, the following information:
 - Project Identification Number
 - Sample numbers
 - Type of samples
 - Date and time received
 - Date put into storage after analysis is completed
 - Date of disposal
- ◆ Place the completed COC Record in the project file.

The date and time the samples are logged in by the Sample Custodian or designee should agree with the date and time recorded by the person relinquishing the samples. Any nonconformance to the stated procedures that may affect the cost or data quality should be reported to the Principal Investigator.

Other Documentation

Following sample receipt at the laboratory, the Laboratory Manager or sample custodian will clearly document the processing steps that are applied to the sample. The analytical data from laboratory QC samples will be identified with each batch of related samples. The laboratory log book will include the time, date, and name of the person who logged each sample into the laboratory system. This documentation will be thorough enough to allow tracking of the sample analytical history without aid from the analyst. At a minimum, laboratory documentation procedures will provide the following:

- ◆ Recording in a clear, comprehensive manner using indelible ink;

- ◆ Corrections to data and logbooks made by drawing a single line through the error and initialing and dating the correction;
- ◆ Consistency before release of analytical results by assembling and cross-checking the information on the sample tags, custody records, bench sheets, personal and instrument logs, and other relevant data to verify that data pertaining to each sample are consistent throughout the record;
- ◆ Observations and results identified with the project number, date, and analyst and reviewer signatures on each line, page, or book as appropriate;
- ◆ Data recorded in bound books or sheaf of numbered pages, instrument tracings or hard copy, or computer hard copy; and,
- ◆ Data tracking through document consolidation and project inventory of accountable documents: sample logbook, analysis data book, daily journal, instrument logbook, narrative and numerical final reports, etc.

4.4 Data Reduction, Validation, and Reporting

This section describes procedures for reducing, validating, and reporting data. All validated analytical data generated within the off-site laboratories will be extensively checked for accuracy and completeness by laboratory and project personnel. Records will be kept throughout the analytical process, during data generation, and during reporting so that adequate documentation to support all measurements is available. Recordkeeping, data reduction, validation, and reporting procedures are discussed in this section.

4.4.1 Data Reduction. Data reduction will follow the requirements contained in the SW-846 and U.S. EPA analytical methods cited in [Section 4.1.1](#). Reduction involves the reformatting of data to present the desired end-product, *i.e.*, the concentrations of the contaminants. Reformatting will involve the process of performing calculations on the raw data and presenting all values in appropriate units. The information generated by the data reduction step will be used in the interpretation of the data qualifiers.

The responsibility for data acquisition and reduction of raw data resides with the analysts who perform the analysis. Raw data for the quantitative VOC analysis procedures used during this project will consist of peak areas for surrogates, standards, and target compounds. Analytical results will be reduced to concentration units appropriate for the medium being analyzed: micrograms per liter ($\mu\text{g/L}$) for aqueous samples, micrograms per kilogram ($\mu\text{g/kg}$) for soil samples, and mg/m^3 for soil-gas and breathing zone air samples.

4.4.2 Data Validation. Data validation involves a review of the QC data and the raw data in order to identify any qualitative, unreliable, or invalid measurements. As a result, it will

be possible to determine which samples, if any, are related to out-of-control QC samples. Laboratory data will be screened for inclusion of and frequency of the necessary QC supporting information, such as detection limit verification, initial calibration, continuing calibration, duplicates, matrix spikes, surrogate spikes, and the method and preparation blanks. QC supporting information will be screened to determine whether any datum is outside established control limits. If out-of-control data are discovered, appropriate corrective action will be determined based upon QC criteria for precision, accuracy, and completeness. Any out-of-control data without appropriate corrective action will be cause to qualify the affected measurement data.

Levels of data validation for the demonstration are defined below:

- ◆ **Level I.** For Level I field screening data quality, a data “package” including the results from sample blanks, method blanks, and supporting calibration information, will be recorded in the field logbook and on log sheets maintained within a folder on-site. The extent of contamination and the achievement of detection limits can be determined from this information. The sample results and QC parameters will be routinely evaluated by site personnel, and 10% of the analytical raw data results will be reviewed by the Project Manager to verify sample identity, instrument calibration, quantification limits, numerical computation, accuracy of transcriptions, and calculations.

- ◆ **Level III.** For Level III validated data quality, a CLP-like data package will be provided. For the SW8260B VOC analyses, this includes CLP-like summary forms 1 through 10 and all raw data associated with the samples, without the chromatograms of calibration standards, matrix spikes, or matrix spike duplicates. The laboratory deliverable format for the New Jersey-certified laboratories will follow the guidelines in Appendix A “Laboratory Data Deliverables Formats - Section III (Reduced Laboratory Data Deliverables - USEPA/CLP Methods)” CITE 25 of the New Jersey Register (NJR), June 7, 1993. Sample results will be evaluated according to the current version of the U.S. EPA functional guidelines for organic and inorganic analyses for selected QA/QC parameters, and 10% of the analytical raw data results will be reviewed to verify sample identity, instrument calibration, detection limits, numerical computation, accuracy of transcriptions, and calculations.

At a minimum, the following data validation procedures will be followed.

Each data package will be reviewed and the data validated prior to submission. Checklists will be used to demonstrate that the data review was accomplished. The Laboratory Manager or designee will perform the data review and validation.

The data review will include, but not be limited to, the following subjects:

- ◆ Completeness of laboratory data;

- ◆ Evaluation of data with respect to reporting limits;
- ◆ Evaluation of data with respect to control limits;
- ◆ Review of holding time data;
- ◆ Review of sample handling;
- ◆ Correlation of laboratory data from related laboratory tests;
- ◆ Comparison of the quality of the data generated with DQOs as stated in this Work Plan (on a daily basis, during routine analyses, and during internal laboratory audits); and
- ◆ QC chart review, performed weekly, following receipt of control charts for analyses performed the previous week. Review shall consist of assessing trends, cycles, patterns, etc. This review shall also assess whether control corrective actions have been implemented.

The elements of data validation shall include, but not be limited to, the following items:

- ◆ Examination of COC records to assess whether custody was properly maintained;
- ◆ Comparison of data on instrument printouts with data recorded on worksheets or in notebooks;
- ◆ Comparison of calibration and analysis dates and assessment of whether the same calibration was used for all samples within a lot;
- ◆ Examination of chromatographic outputs for manual integrations, and documentation of the reasons for any manual integrations;
- ◆ Comparison of standard, sample preparation, and injection records with instrument output to assess whether each output is associated with the correct sample;
- ◆ Examination of calibration requirements, as specified in the methods;
- ◆ Use of a hand-held calculator to perform all calculations on selected samples to assess the correctness of results; and
- ◆ Examination of all papers and notebooks to ensure that all pages are signed and dated, that all changes are initialed, dated, have sufficient explanation for the change, and that all items are legible.

Required record-keeping following a laboratory audit shall document that all lots were reviewed in the audit report. The audit report shall also identify any deficiencies that were noted. A copy of the audit report shall be placed in the applicable installation audit folder.

4.4.3 Data Reporting. Data and information generated during the demonstration will be summarized in a Technology Application Analysis Report, to be submitted at the completion of the project. QA/QC analysis reports will be generated by laboratory personnel as a product of

validation procedures described above. All off-site Level III analyses will be accompanied by QA/QC data packages as described in [Section 4.4.2](#). The summary QA/QC reports will not be included in the Technology Application Analysis Report, but will be made available upon request. The ultimate data set produced for project use will consist of all values reported in appropriate units flagged with respective data qualifiers for entry into the project database. All sample results with concentrations between the instrument detection limit and the QL will be reported. These analytical results will be qualified as estimates and flagged with a “J”. Analytical results will be reduced to concentration units appropriate for the medium being analyzed:

- ◆ “µg/L” for aqueous samples;
- ◆ “µg/kg” for soil samples; and
- ◆ “mg/m³” for gaseous samples.

The laboratory will retain all samples and sample extracts for 6 weeks following data package submittal.

The results for each analyte in spiked QC samples will be determined using the same acceptable calibration curve that is used for environmental samples in the lot. Values above the MDL shall be reported as the found value. Raw values that fall below the method detection limit will be reported as “less than” the MDL. Results for QC samples will not be corrected, except as described below. Because all spike levels must be within the calibrated range, no dilutions should be required. Data will be reported using the correct number of significant figures.

Each day of analysis, the analyst will quantify each analyte in the method blank and spiked QC samples. A new lot of samples will not be introduced into the analytical instrument until results for QC samples in the previous lot have been calculated, plotted on control charts as necessary, and the entire analytical method shown to be in control. If time is a constraint, the calculation of associated environmental sample results may be postponed until a later date. The analyst will maintain control charts by the instrument so that the results of QC samples can be hand-plotted, in order to have an early indication of problems.

Data from the method blank will be reported, usually as less than the MDL for each analyte. Any values above the MDL shall be reported as the found value. Corrections to the QC samples, necessitated by background levels in the method blank, will be performed using instrument response values and not the found values calculated from the linear calibration curve. Reported entries will be in terms of concentration. The importance attached to finding measurable concentrations in the method blank is dependent on analyte and method. Identification of measurable concentrations in the method blanks will be reported in writing to the Principal Investigator for possible corrective actions.

The following additional data reporting procedures will be followed.

All data will be reported, and numerical results will be reported in terms of concentration in the environmental sample. Resultant found concentrations will be adjusted for dilution, etc. before being reported, and both the raw data and correction factors (*e.g.*, percent moisture, and dilution factor) will be recorded in the data package submitted. Laboratory comments on the usability of the data will also be included.

In reporting results, rounding to the correct number of significant figures will occur only after all calculations and manipulations have been completed. As many figures as are warranted by each analytical technique will be used in pre-reporting calculations. Rounding will be accomplished using the following rules:

Rule 1 - In expressing an experimental quantity, retain no digits beyond the second uncertain one.

Rule 2 - In rounding numbers (*i.e.*, in dropping superfluous digits):

- ◆ Increase the last retained digit by one if the first uncertain digit is larger than 5;
- ◆ Retain the last digit unchanged if the first uncertain digit is less than 5;
- ◆ Retain the last digit unchanged if even, or increase it by one if odd, if the first uncertain digit is 5 and the second uncertain digit is 0;
- ◆ Increase the last retained digit by one if the first uncertain digit is 5 and the second uncertain digit is greater than 0.

The correct number of reported significant figures, by validation type, is 3 significant figures. The number of allowable significant figures is reduced when added uncertainties are included in the analysis, *i.e.*, the results for samples diluted into the validated range allow one less significant figure due to the uncertainty added by the dilution process.

5.0 Demonstration Procedures

5.1 Technology Startup

5.2 Technology Maintenance

5.3 Problems

5.4 Corrective Action Plan

If routine procedures (*e.g.*, equipment calibration), QC sample analysis, or performance and system audits indicate that sampling or analysis systems are unsatisfactory, a corrective action shall be implemented. During performance audits, if PE samples do not meet the QA criteria for accuracy and precision specified in **Section 4.0**, analytical work will stop until the problems are identified and resolved. Before work resumes, another blind PE sample must be analyzed, and results must meet the acceptance criteria. Results of all PE samples will be included in the Application Analysis Report. If previously reported data are effected by the situation requiring correction or if the corrective action will impact the project budget or schedule, the action will directly involve the Principal Investigator. ESTCP will be informed of all major performance problems, and will be included in corrective action planning.

Corrective actions are of two kinds:

1. Immediate, to correct or repair non-conforming equipment and systems. The need for such an action will most frequently be identified by the analyst or technician as a result of calibration checks and QC sample analyses. Immediate corrective actions address problems peculiar to a single measurement or lot of samples. Immediate corrective action may include:
 - ◆ Re-run of analyses if sample holding times have not been exceeded;
 - ◆ Instrument re-calibration using freshly prepared standards;
 - ◆ Replacement of reagents or solvents that give unacceptable blank values;
 - ◆ Examination of data calculation errors; and
 - ◆ Replacement of reference standards that have been degraded.

If corrective action indicates that non-conformance is due to problems with laboratory equipment, procedures, and/or calibration, once the problem is resolved, the non-conforming samples will be re-analyzed if holding times have not been exceeded. If holding times have been exceeded, new samples will be collected if the completeness criteria specified in **Section 4.0** require that these samples be collected. If corrective action indicates that non-conformance of duplicate samples is due to sampling technique, once the problem is corrected, new samples will be collected if the completeness criteria specified in **Section 4.0** requires that these samples be collected.

2. Long-term, to eliminate causes of non-conformance. The need for such actions will probably be identified by audits. Long-term corrective actions may address procedural deficiencies or unsatisfactory trends or cycles in data that affect multiple lots of samples. Examples of long-term corrective action may include:

- ◆ Staff training in technical skills or in implementing the QAP;
- ◆ Rescheduling of laboratory routine to ensure analysis within allowed holding times;
- ◆ Identifying alternate vendors to supply reagents of sufficient purity; and
- ◆ Revision of the QAP.

For either immediate or long-term corrective action, steps comprising a closed-loop corrective action system will be implemented as follows:

- ◆ Define the problem;
- ◆ Assign responsibility for investigating the problem;
- ◆ Investigate and determine the cause of the problem;
- ◆ Determine a corrective action to eliminate the problem;
- ◆ Assign responsibility for implementing the corrective action; and
- ◆ Verify that the corrective action has eliminated the problem.

Unsatisfactory items or situations may be identified by anyone involved with the project, particularly the analysts, field engineers, technicians, or QA personnel. Depending on the nature of the problem, the corrective action employed may be formal or informal.

To enhance the timeliness of corrective action and thereby reduce the generation of unacceptable data, problems identified by assessment procedures will be resolved at the lowest possible management level. Problems that cannot be resolved at this level will be reported to the Project Manager. The Project Manager will determine the management level at which the problem can best be resolved, and will notify the appropriate manager. Monthly progress reports from the on-site Field Engineer will detail all problems and subsequent resolutions.

In all cases, the occurrence of the problem, the corrective action(s) employed, and verification that the problem has been eliminated will be documented. In addition, if the corrective action results in the preparation of a new standard or calibration solution(s), then a comparison of the new versus the old standard or solution will be performed, and the results supplied with a full QC report as verification that the problem has been eliminated. Corrective action reports that relate to a particular lot analysis will be included in the data package for that lot.

6.0 Calculation of Data Quality Indicators

6.1 Quantitative QA Objectives: Accuracy, Precision, Completeness, and Method-Detection Limit

Accuracy: Accuracy indicates the degree of bias in a measurement system, and is the degree of agreement of a measurement with an accepted reference value. Sample measurement uses laboratory equipment. The percent recovery of matrix spike/matrix spike duplicate samples measures the accuracy of the laboratory equipment, calculated according to the following equation:

$$\%R = (C_i - C_o) / C_t * 100 \quad \text{(Equation B-1)}$$

Where: %R = percent recovery

C_i = measured concentration; spiked sample aliquot

C_o = measured concentration, unspiked sample aliquot

C_t = actual concentration of spike added

The accuracy objectives for each off-site laboratory method and analyte of interest are summarized in [Tables B-2 and B-3](#).

Precision: Precision is the reproducibility of measurements under a given set of conditions. For large data sets, precision is expressed as the variability of a group of measurements compared to their average value. Variability may be attributable to field practices or chemical analyses. Precision is expressed as relative percentage difference, determined using the Equation B-below.

Precision is measured by calculating the Relative Percent Difference (RPD) of laboratory duplicates, matrix spike/matrix spike duplicate sample pairs, surrogate spikes, and field duplicate samples.

The precision objectives for each off-site laboratory method and analyte of interest are summarized in [Tables B-2 and B-3](#).

$$RPD = (C_1 - C_2) * 100 / ((C_1 + C_2) / 2) \quad \text{(Equation B-2)}$$

Where: RPD = relative percent difference

C_1 = the larger of the two observed values

C_2 = the smaller of the two observed values

Completeness: Completeness is defined as the qualified and estimated results, and represents the results usable for data interpretation and decision making. Results qualified as rejected or unusable, or that were not reported because of sample loss, breakage, or analytical error, negatively influence completeness and are subtracted from the total number of results to calculate completeness. Percent completeness is determined by using the following equation:

$$\% \text{ Completeness} = (\text{VPD} / \text{TDP}) * 100 \quad (\text{Equation B-3})$$

Where: VDP = number of valid data points
TDP = number of total samples obtained

Completeness will be calculated for each method and matrix during the demonstration. The completeness objective for all validated data is **95 percent** for aqueous.

Method-Detection Limits. Method detection limits (MDLs) and quantitation limits (QLs) must be distinguished for proper understanding and data use. The MDL is the minimum analyte concentration that can be measured and reported with a 99% confidence that the concentration is greater than zero. The QL represents the concentration of an analyte that can be routinely measured in the sampled matrix with “reasonable” confidence in both identification and quantitation. QLs are often based on analytical judgement and experience, and should be verifiable by having the lowest non-zero calibration standard or calibration check sample concentration at or near the QL. **Tables B-4, B-5, and B-6** present the MDL range and QLs for the analytical methods to be used during the demonstration. The limits shown in **Tables B-4 through B-6** assume optimal conditions. MDLs may be higher, particularly in contaminant mixtures, due to dilution limits required for analysis. Concentrations detected below the QL will be appropriately flagged. **These flagged concentrations will be considered below the practical quantification limits of the analytical method used, but will not negatively impact completeness.**

The evaluation of method detection limits (MDLs) will be in accordance with the procedures outlined in Appendix B to Part 136 “Definition and Procedures for the Determination of Method Detection Limit - Revision 1.1,” 40 Code of Federal Regulations (CFR) 136, 1984. Method quantification limits and detection limits will be reported for each sample set of validated data. The calculated MDL shall be equal to or less than the Required Detection Level (RDL). If the calculated MDL is lower than the level the laboratory deems practical, the calculated MDL may be raised to a higher level. In no instance shall the reported MDL be below the calculated level. The method documentation shall include both the calculated MDL and the request for an increased reportable MDL. Raising the reportable MDL to a higher level will be contingent upon approval by Envirogen’s Principal Investigator and ESTCP.

6.2 Qualitative QA Objectives: Comparability and Representativeness

Comparability refers to the confidence with which one data set can be compared to another. Comparability is essential for the evaluation of technology performance compared to that of similar technologies. Comparable data will be generated by following standard SW-846 and U.S. EPA protocols for all laboratory analyses, and manufacturers' instructions for all on-site test kits and meters.

Representativeness is a measure of the degree to which data accurately and precisely represent the conditions of the parameter represented by the data. Collected samples must be representative of the matrix characteristics and contamination concentrations. Representativeness is affected by errors introduced through the sampling process, field contamination, preservation, handling, sample preparation, and analysis.

Representativeness will be ensured through the following practices:

- ◆ selecting the necessary number of samples, sample locations, and sampling procedures that will depict as accurately and precisely as possible the matrix and conditions measured;
- ◆ developing protocols for storage, preservation, and transport that preserve the representativeness of the collected samples;
- ◆ using documentation methods to ensure that protocols have been followed and that samples are properly identified to maintain integrity and traceability; and
- ◆ using standard, well-documented analytical procedures to ensure consistent, representative data.

While none of these practices can be quantified as a measure of representativeness, QC samples will be collected to indicate factors that may affect representativeness. The QC samples to be used for this purpose are as follows:

- ◆ field duplicates (field split samples and collection duplicates) to indicate variations caused by sampling techniques;
- ◆ trip blanks to indicate contamination of samples during transport; and
- ◆ field blanks to indicate contamination introduced through ambient conditions.

7.0 Performance and System Audits

Two types of audits will be conducted during the aerobic biostimulation demonstration; (1) external audits of the independent laboratory (for water and soil analyses) conducted periodically by Envirogen personnel, and (2) internal audits of Envirogen's laboratory and field activities con-

ducted by Envirogen personnel not directly associated with the project. During auditing visits by Envirogen personnel, the independent laboratory will make available whatever records and personnel are necessary to assess the effective implementation of this QAP. The individuals responsible for performing QA audits are listed in [Section 2](#). [Figure B-1](#) shows the QA organizational reporting structure.

The internal audit program will be conducted monthly during the demonstration, and will include both performance and system audits as independent checks of the quality of data obtained from the New Jersey-based laboratory analyses in addition to field audits conducted during sampling and field screening (analytical kit analyses) activities. Every effort will be made to have the audit assess the measurement process in normal operation. The Envirogen external performance and system audit program will include checks of the quality of data obtained from the independent laboratory. The external audits will be conducted every six weeks.

Performance Audits. The analysis and data-gathering segments of the aerobic biostimulation demonstration will be checked during performance audits, which may include submitting blind performance evaluation (PE) samples to the laboratories, as necessary throughout the course of the project, in order to evaluate the effectiveness of each laboratory's QC program. Results of the PE samples will be recorded and compared with routinely-obtained data. Reference standards may be randomly dispersed among samples awaiting analysis to check the analytical procedures. At a minimum, each audit will include an analysis of the data handling and reporting procedures of the laboratories by performing a complete check of one of the data packages submitted by each laboratory by using the original raw data and performing all necessary calculations by hand. In addition, the audit will include a review of all QA/QC data attained up through the date of the audit. Formal Performance Audit Reports, performed by the Envirogen QA Manager and/or Project Manager, will be distributed to the Envirogen Principal Investigator.

System Audits. An on-site system audit is a qualitative review that checks that the QC measures outlined in the QAP are in use; it is a general overview of the whole quality system for the project. The Envirogen QA Manager and/or Project Manager will conduct a system audit on site at the start of the project and periodically throughout the program. As with the Performance Audits, a formal System Audit Report will be submitted to the Principal Investigator.

Analytical Laboratory Requirements. All routine off-site analyses will be performed by Envirogen's analytical laboratory. As a QA/QC check, duplicate field-split samples for VOC analysis (SW8260B) will be analyzed by an independent laboratory according to the schedule outline in [Table B-1](#).

APPENDIX E

**FIGURES 13A - 13O CONTROL PLOT GROUNDWATER
CONTOUR MAPS**

Figure 13A - Control Plot Groundwater Elevations - 1/10/01
ESTCP MTBE Demonstration Project
Port Hueneme, California

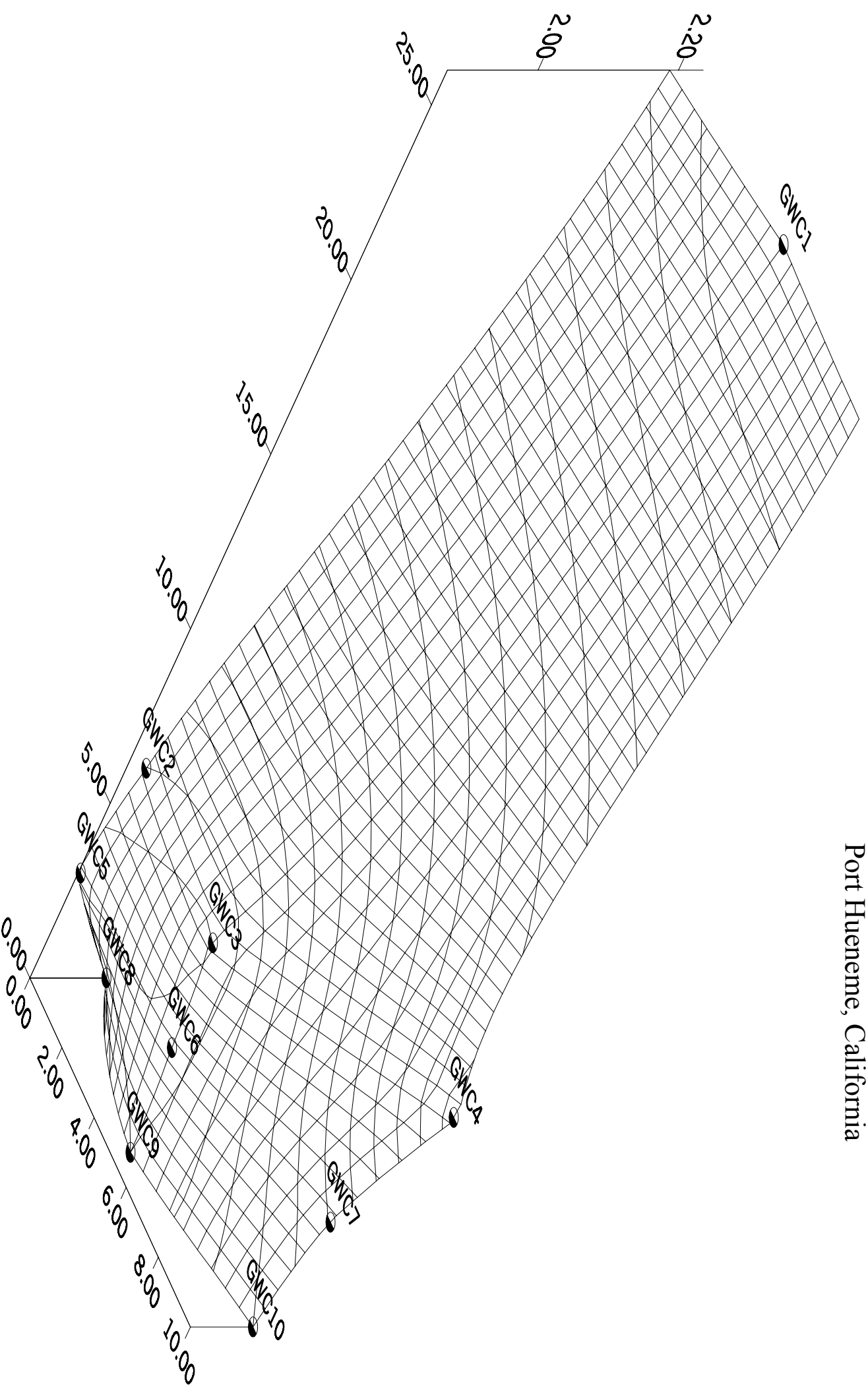

Figure 13B - Control Plot Groundwater Elevations - 5/1/01
ESTCP MTBE Demonstration Project
Port Hueneme, California

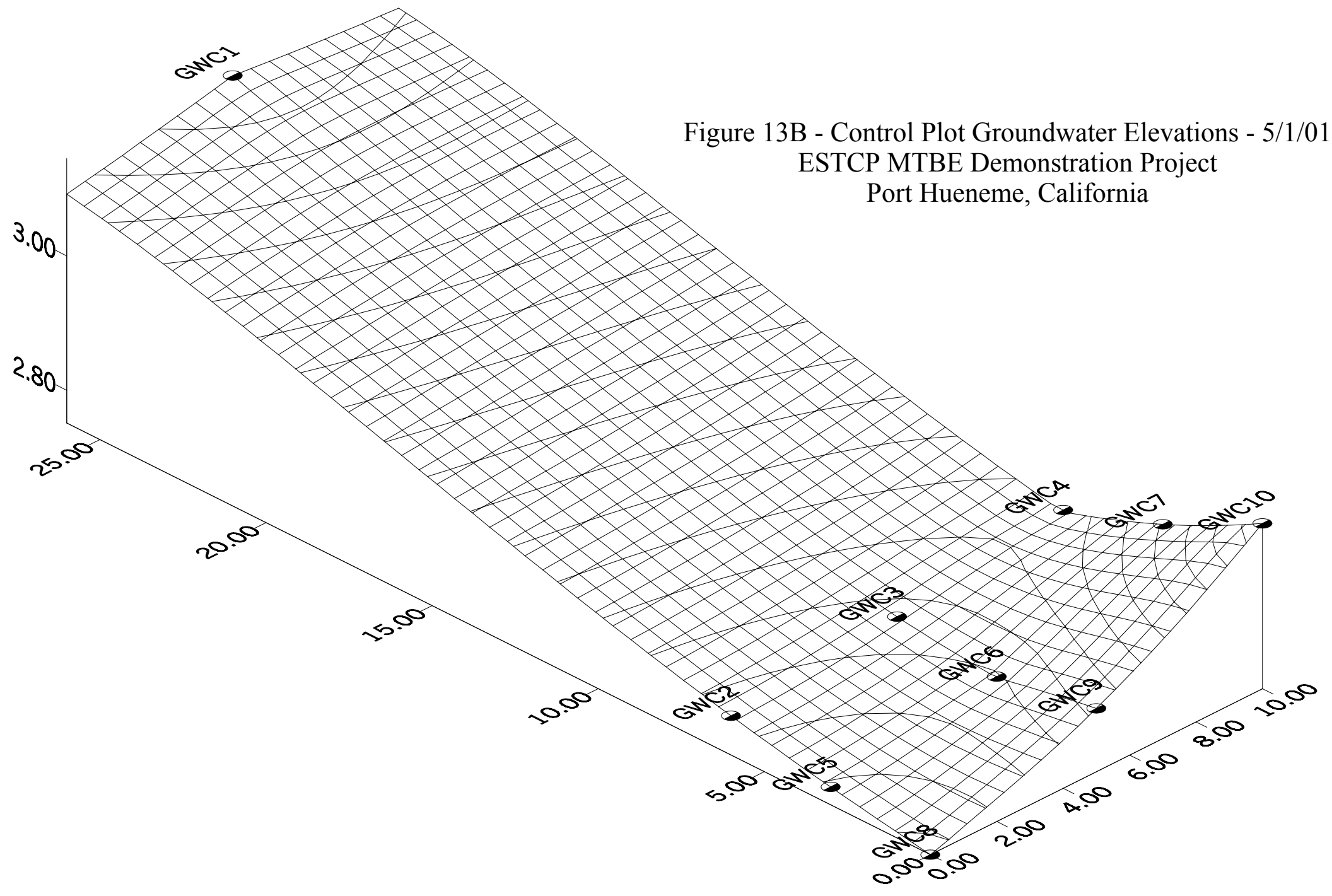

Figure 13C - Control Plot Groundwater Elevations - 5/21/01
ESTCP MTBE Demonstration Project
Port Hueneme, California

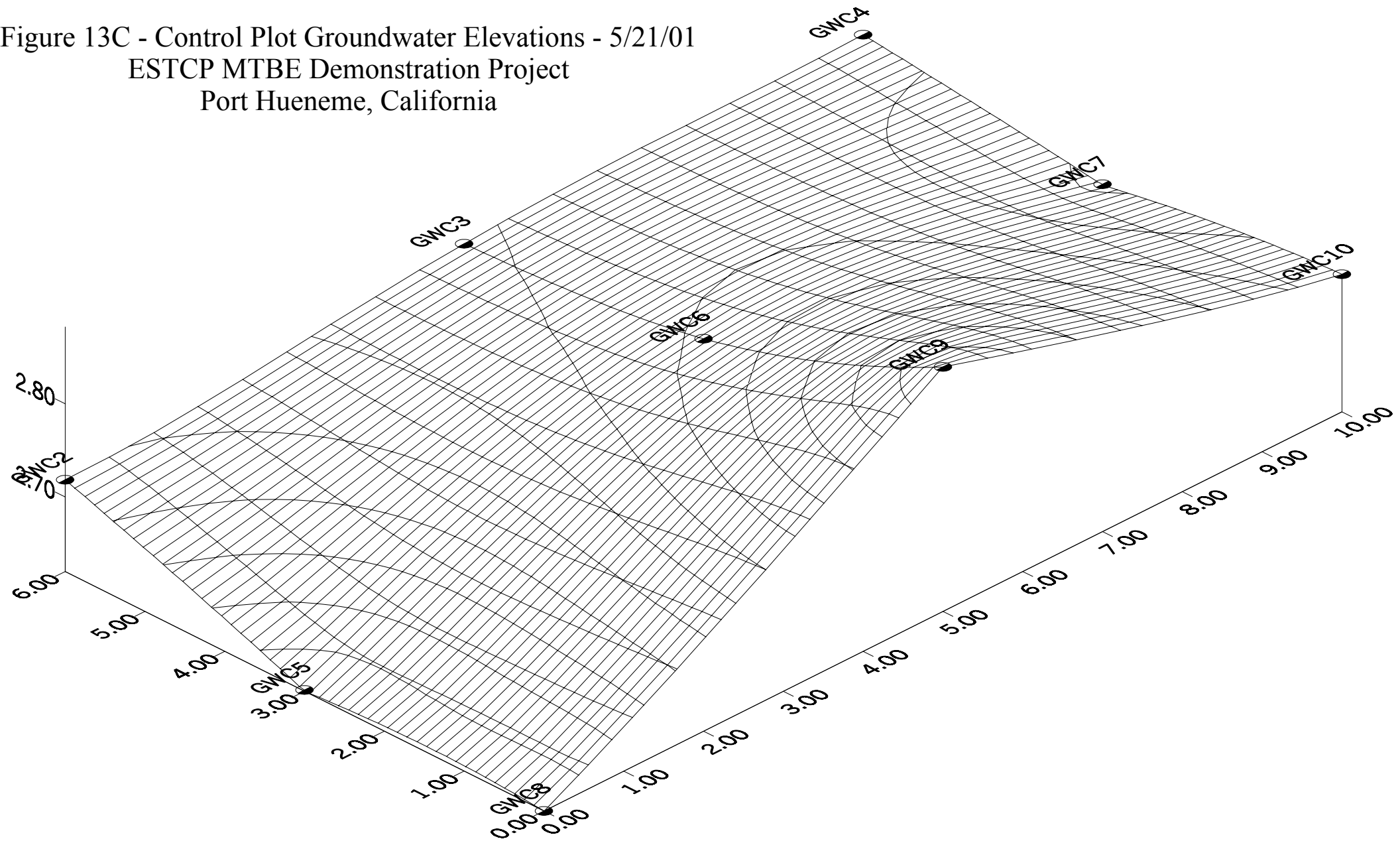

Figure 13D - Control Plot Groundwater Elevations - 6/13/01
ESTCP MTBE Demonstration Project
Port Hueneme, California

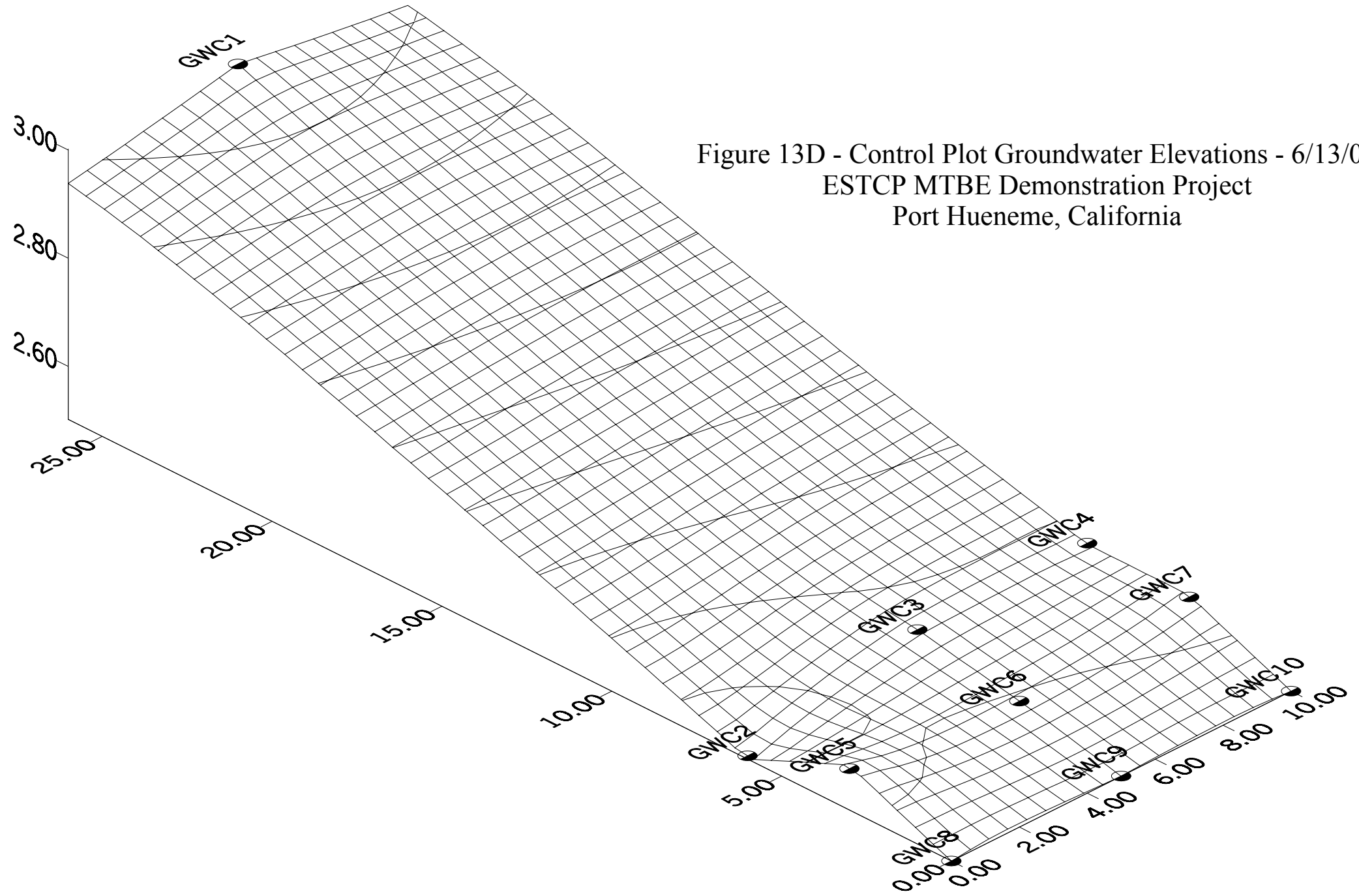

Figure 13E - Control Plot Groundwater Elevations - 6/25/01
ESTCP MTBE Demonstration Project
Port Hueneme, California

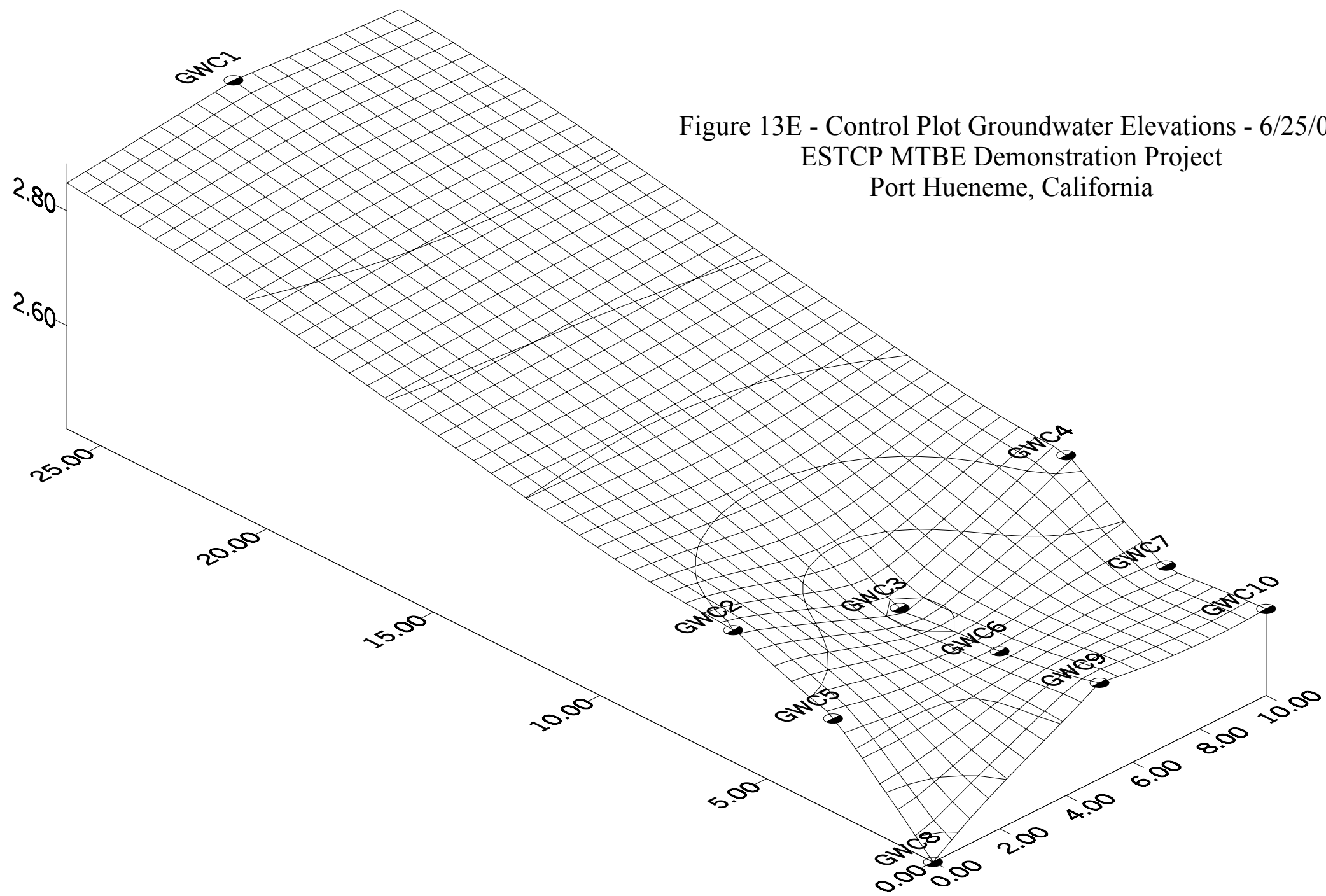

Figure 13F - Control Plot Groundwater Elevations - 7/11/01
ESTCP MTBE Demonstration Project
Port Hueneme, California

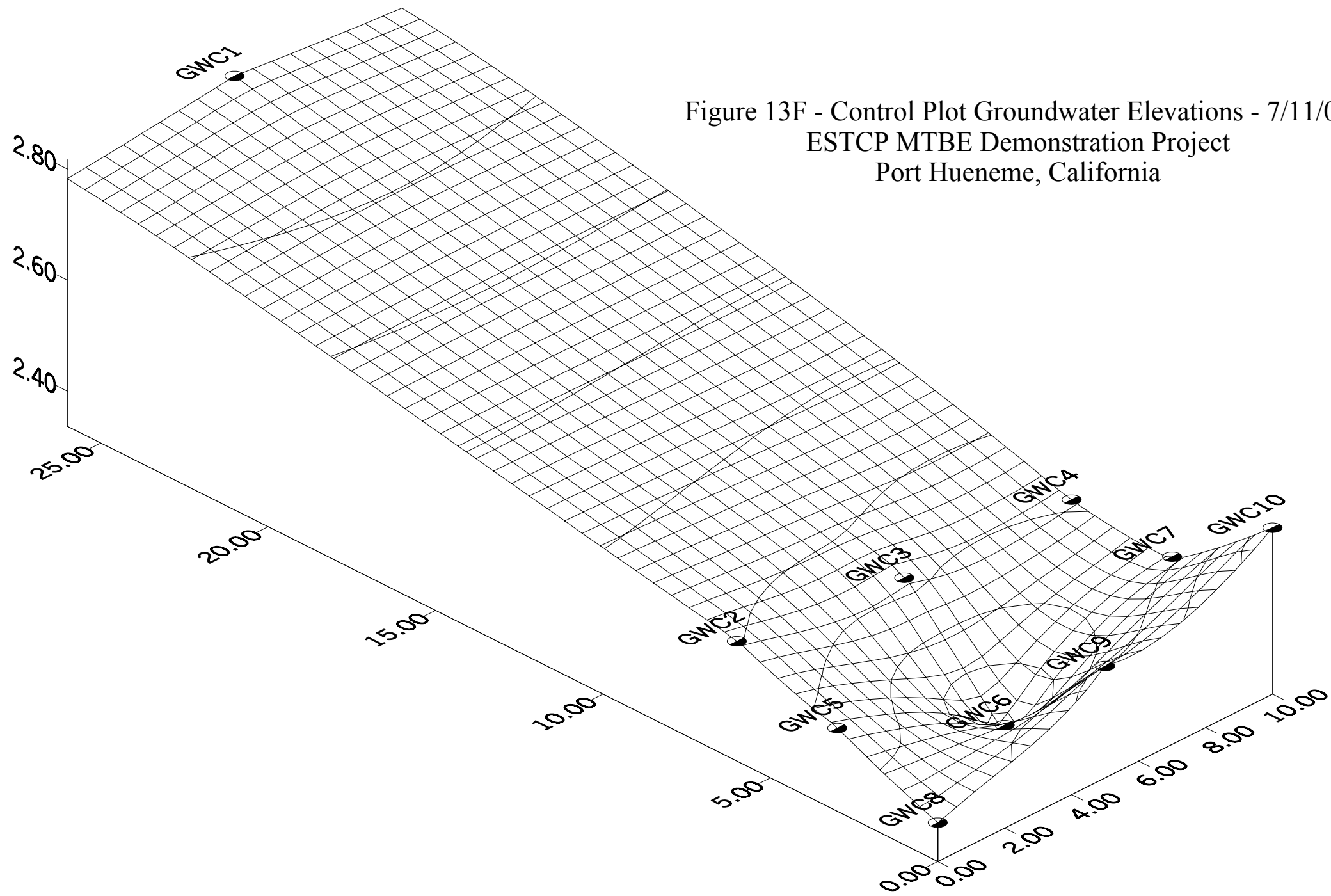

Figure 13G - Control Plot Groundwater Elevations - 7/24/01
ESTCP MTBE Demonstration Project
Port Hueneme, California

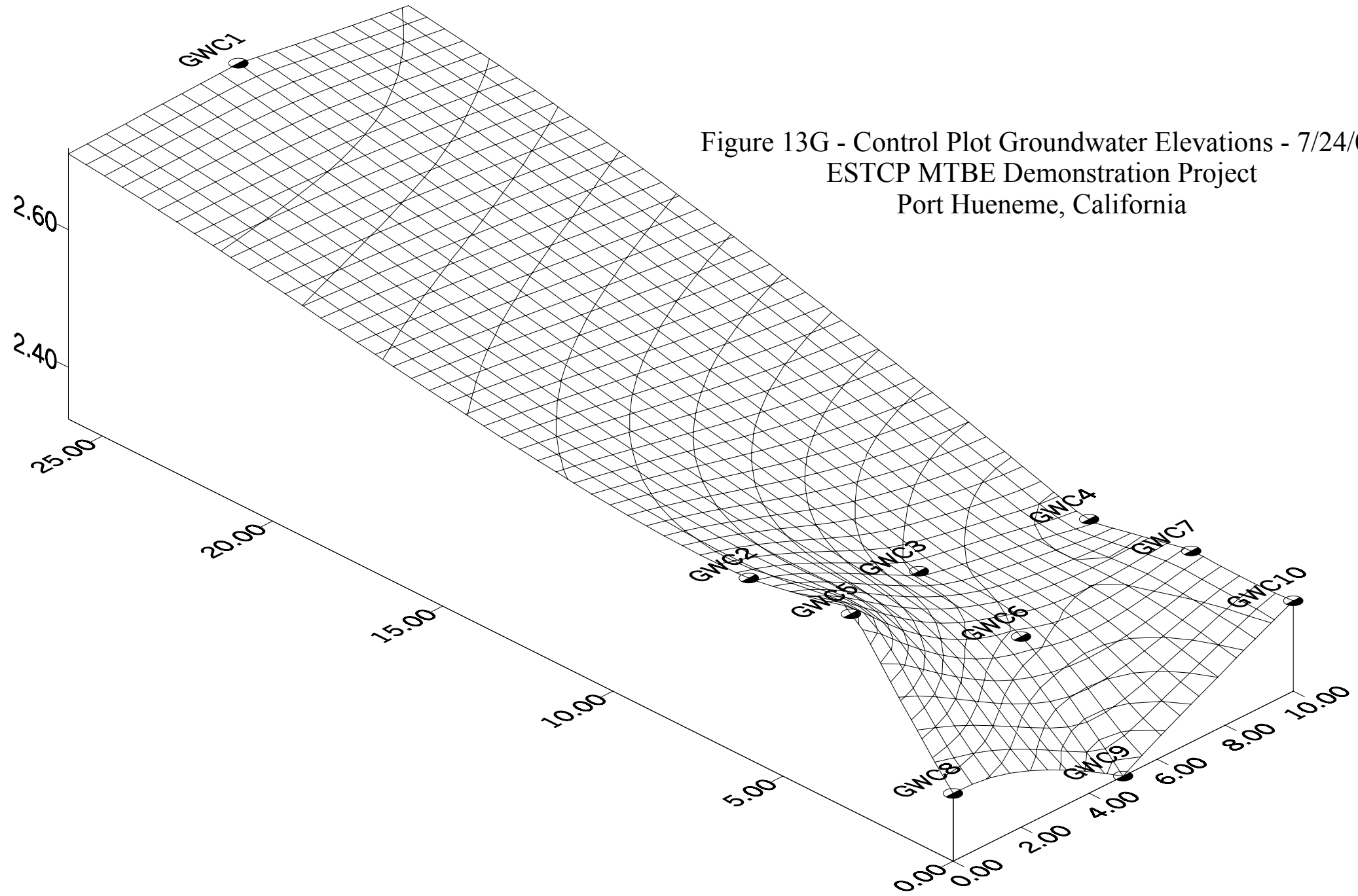

Figure 13H - Control Plot Groundwater Elevations - 8/21/01
ESTCP MTBE Demonstration Project
Port Hueneme, California

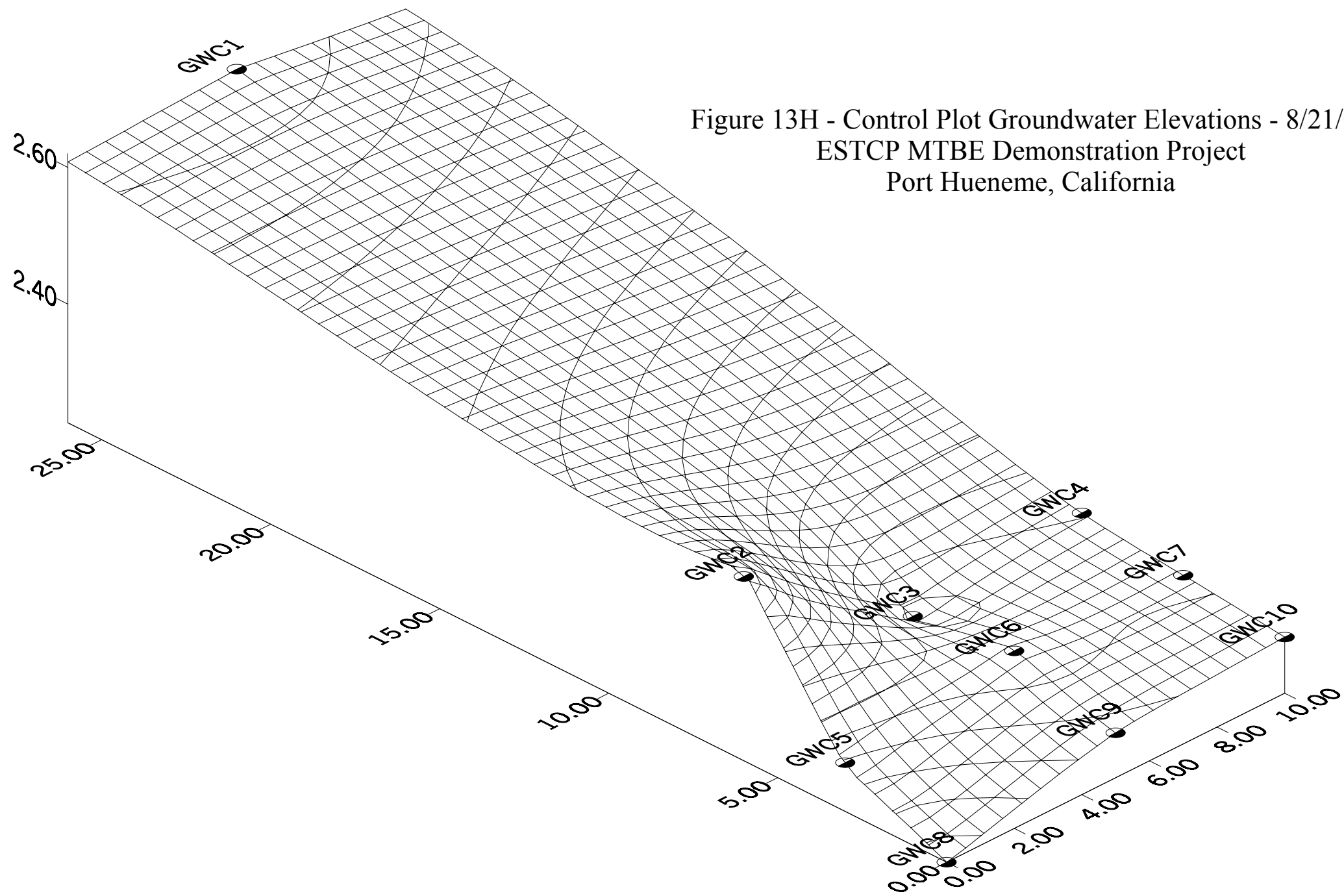

Figure 13I - Control Plot Groundwater Elevations - 9/25/01
ESTCP MTBE Demonstration Project
Port Hueneme, California

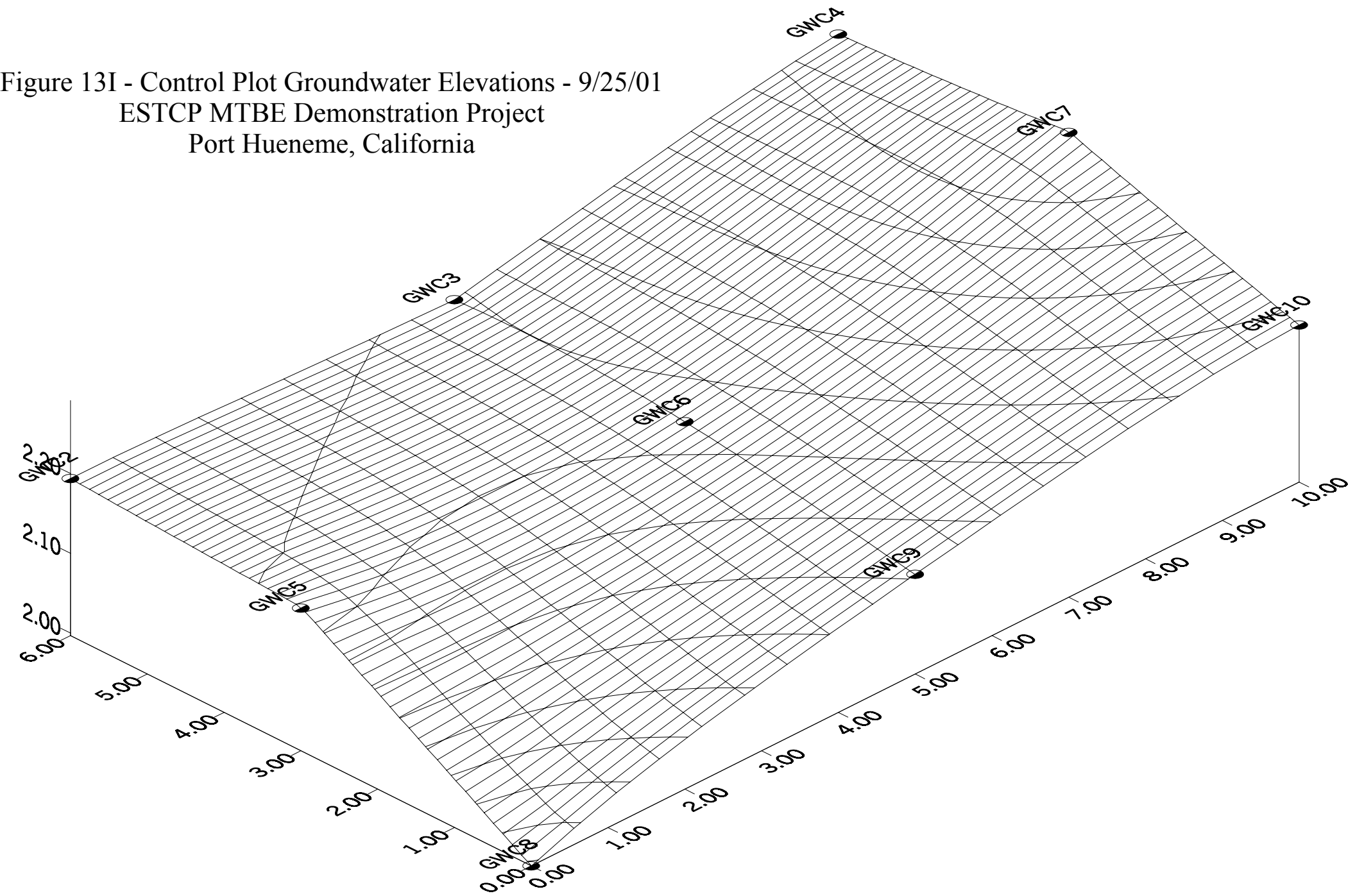

Figure 13J - Control Plot Groundwater Elevations - 10/15/01
ESTCP MTBE Demonstration Project
Port Hueneme, California

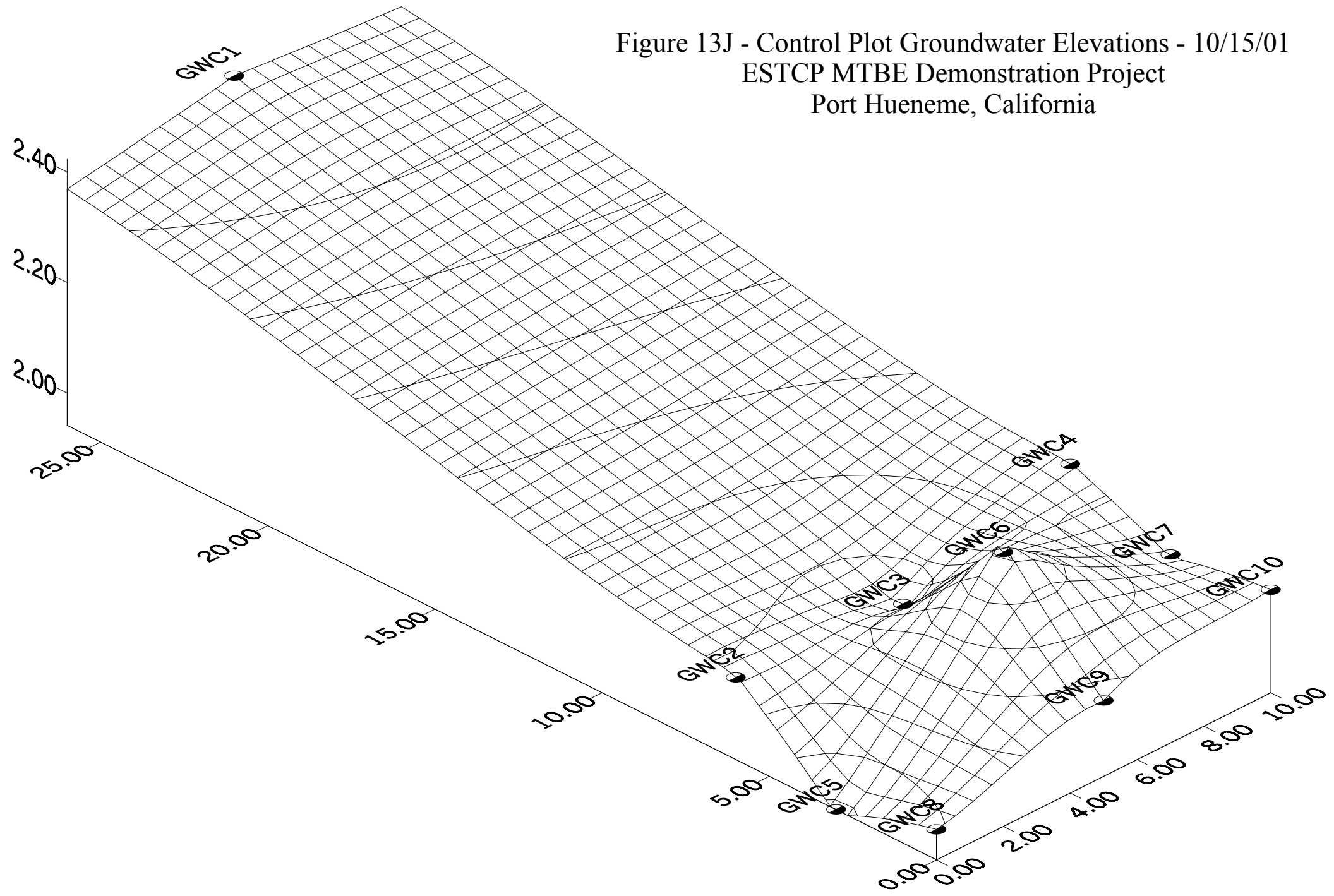

Figure 13K - Control Plot Groundwater Elevations - 11/12/01
ESTCP MTBE Demonstration Project
Port Hueneme, California

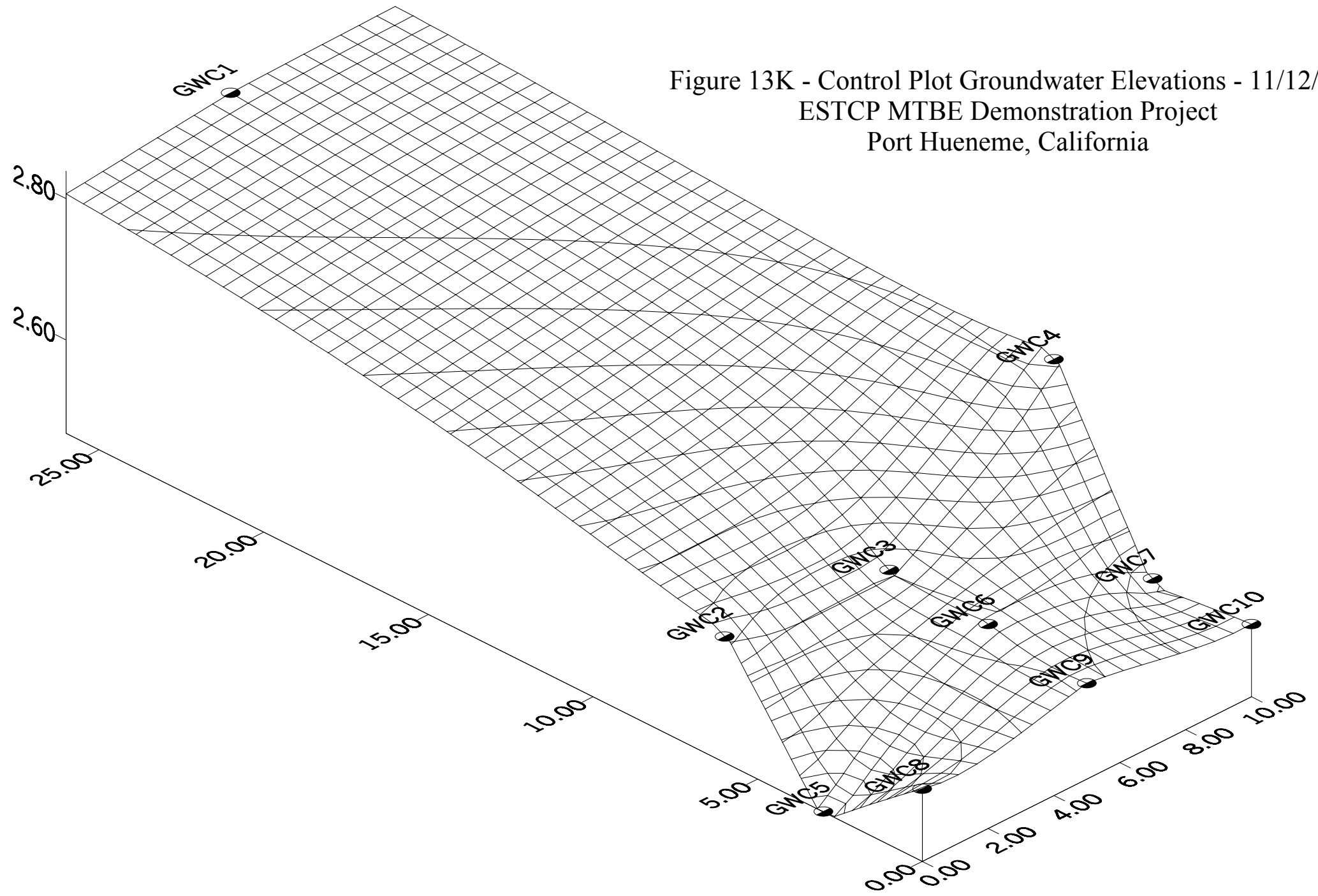

Figure 13L - Control Plot Groundwater Elevations - 12/10/01
ESTCP MTBE Demonstration Project
Port Hueneme, California

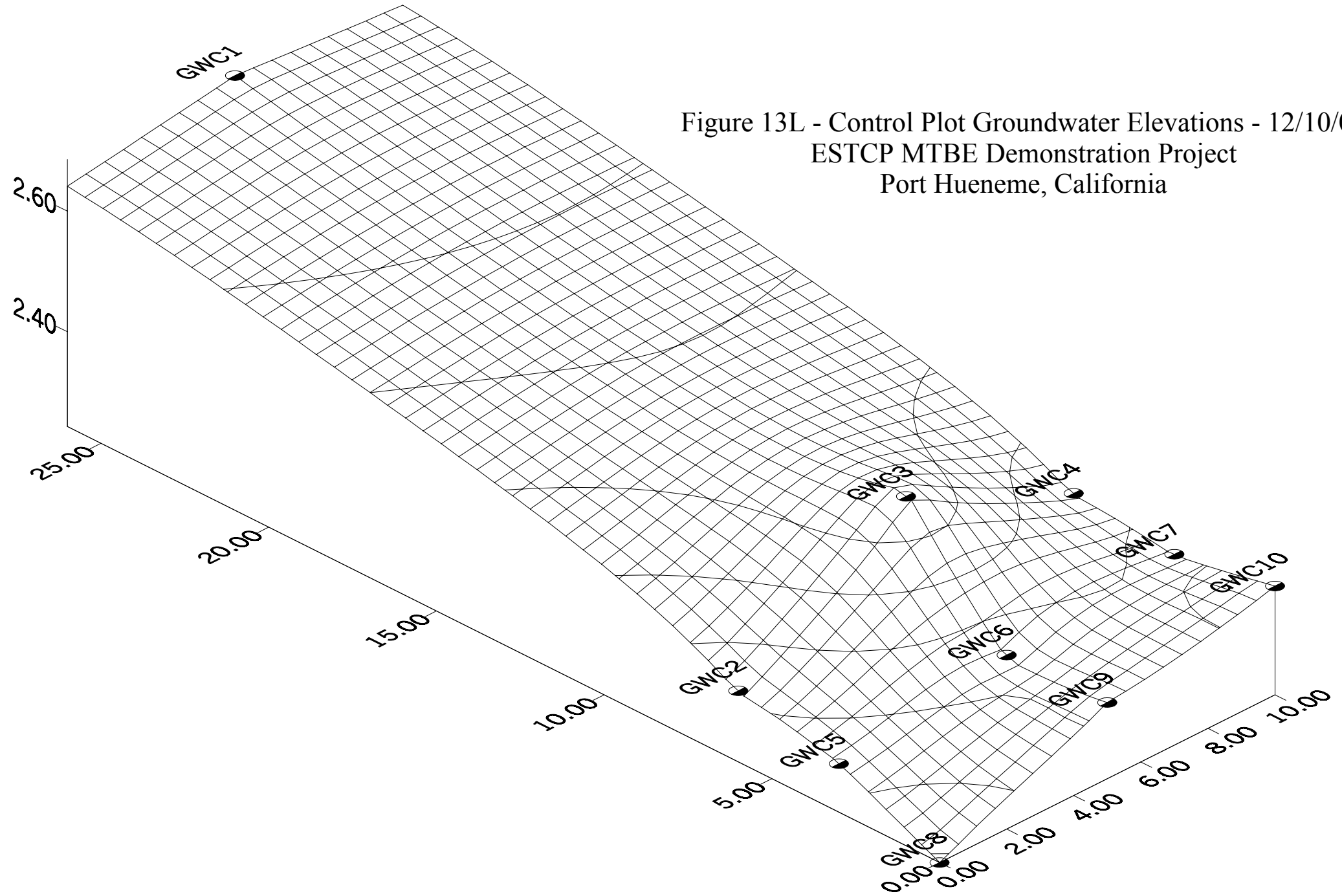

Figure 13M - Control Plot Groundwater Elevations - 1/14/02
ESTCP MTBE Demonstration Project
Port Hueneme, California

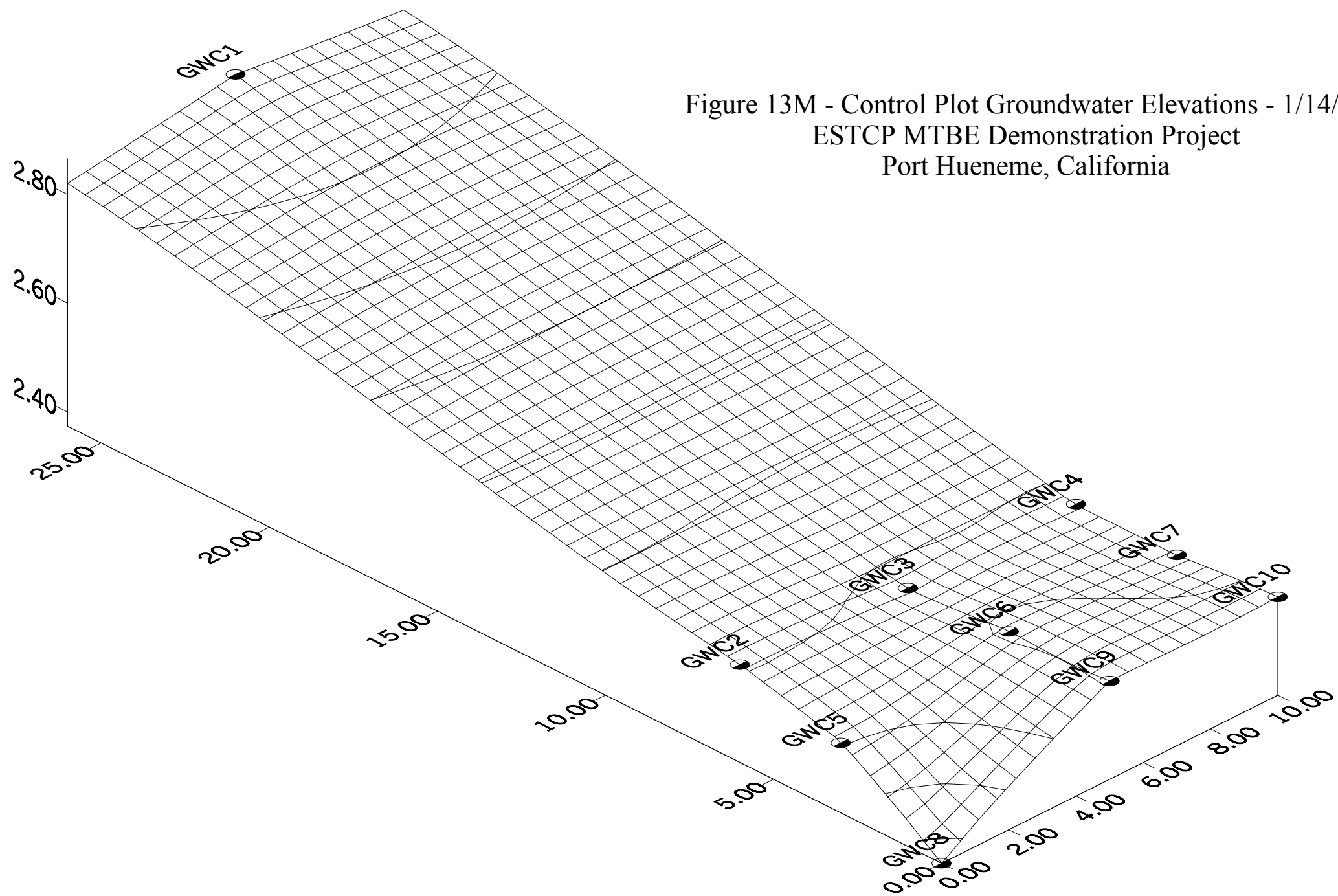

Figure 13N - Control Plot Groundwater Elevations - 2/4/02
ESTCP MTBE Demonstration Project
Port Hueneme, California

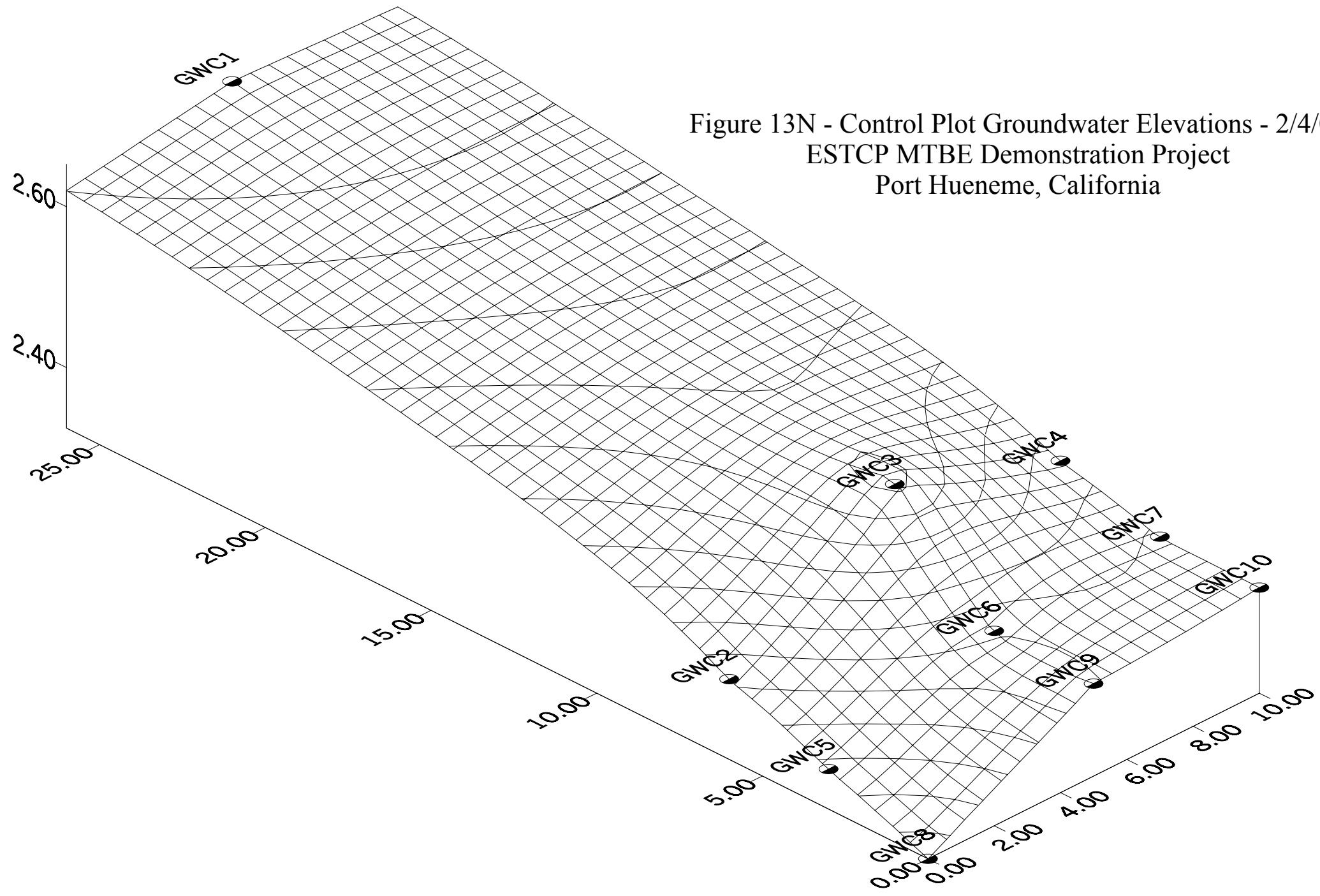
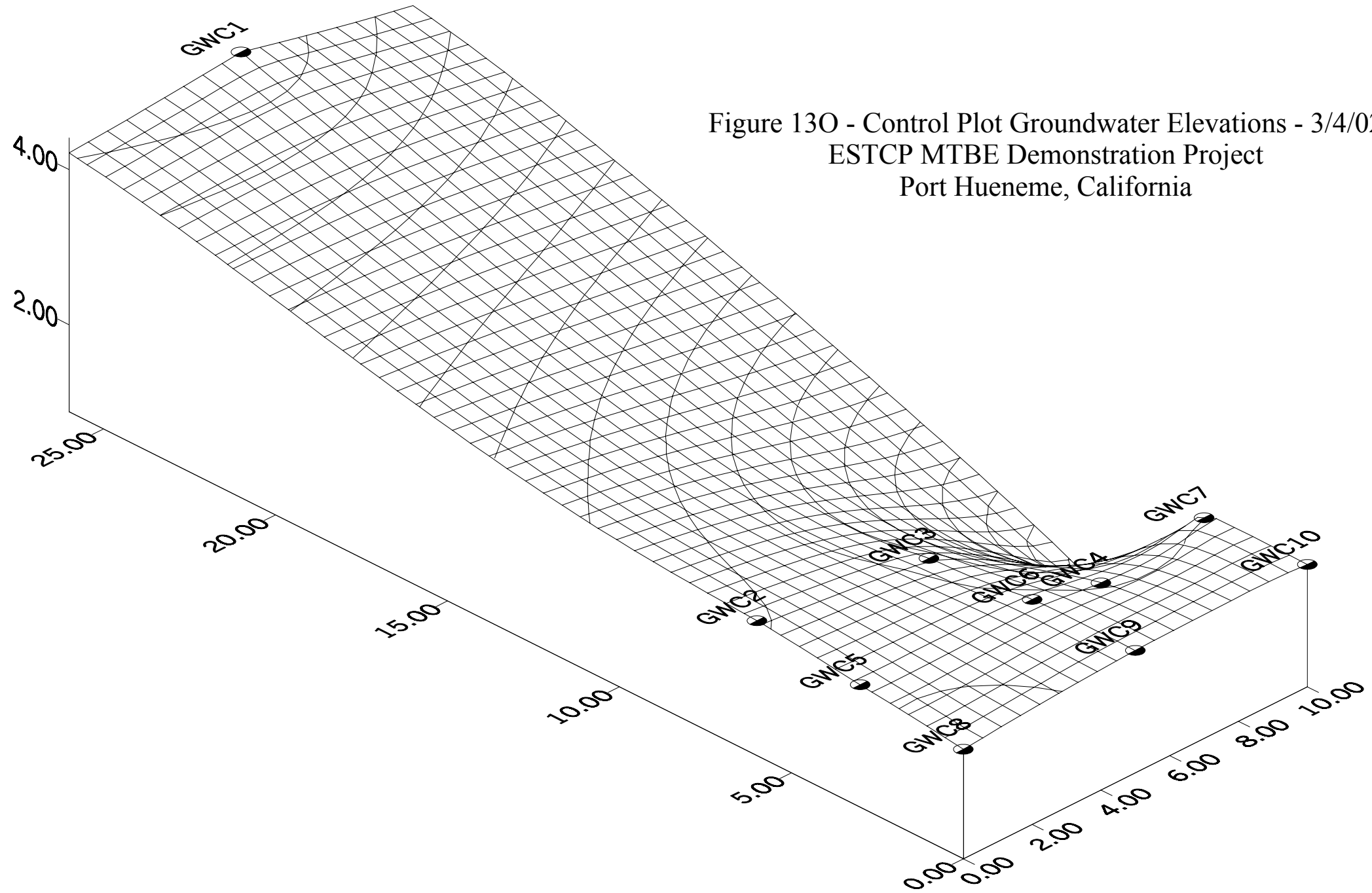

Figure 130 - Control Plot Groundwater Elevations - 3/4/02
ESTCP MTBE Demonstration Project
Port Hueneme, California



APPENDIX F

**FIGURES 14A - 14O TEST PLOT GROUNDWATER CONTOUR
MAPS**

Figure 14A - Test Plot Groundwater Elevations - 1/9/01
ESTCP MTBE Demonstration Project
Port Hueneme, California

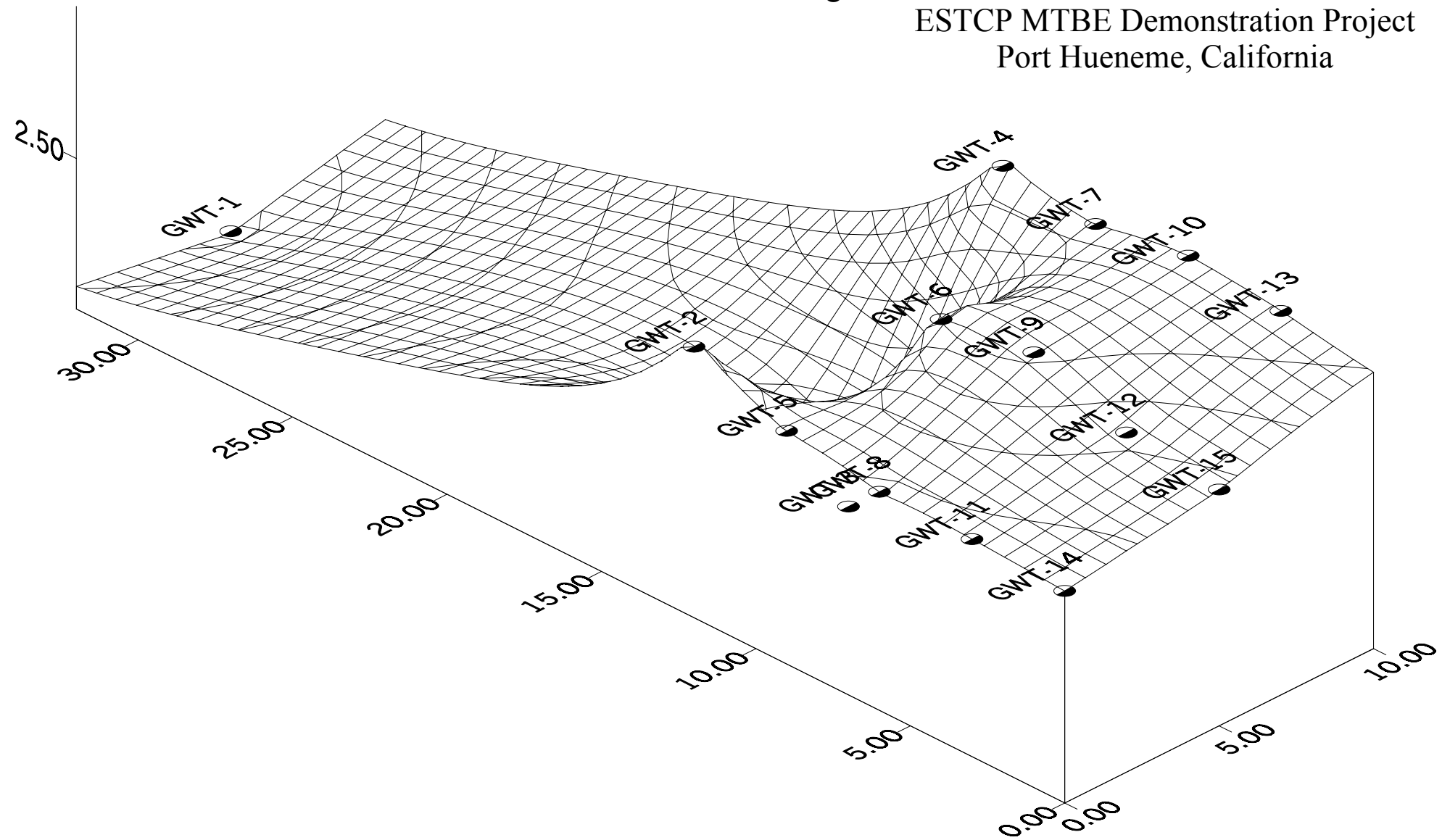

Figure 14B - Test Plot Groundwater Elevations - 5/1/01
ESTCP MTBE Demonstration Project
Port Hueneme, California

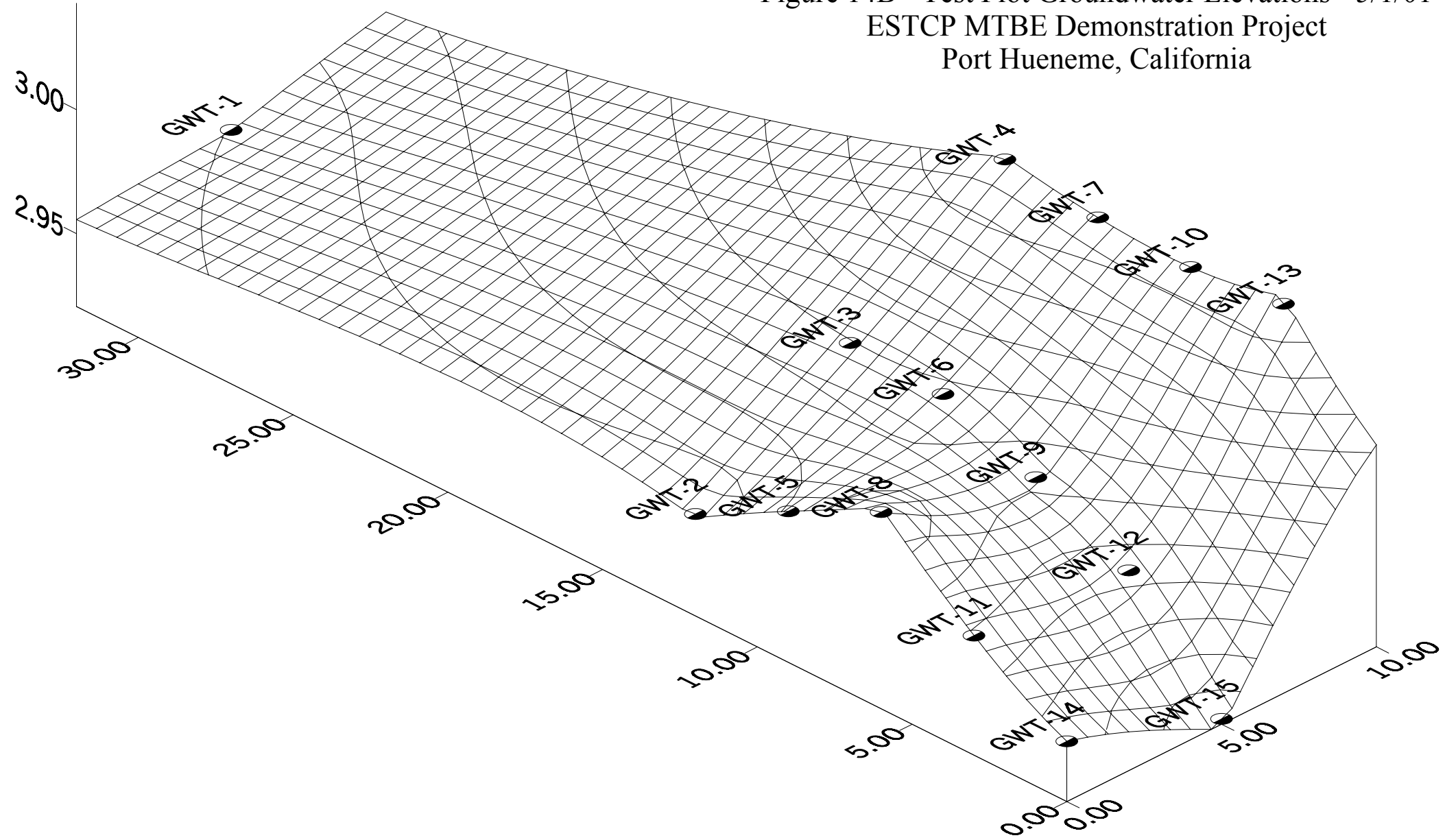

Figure 14C - Test Plot Groundwater Elevations - 5/21/01
ESTCP MTBE Demonstration Project
Port Hueneme, California

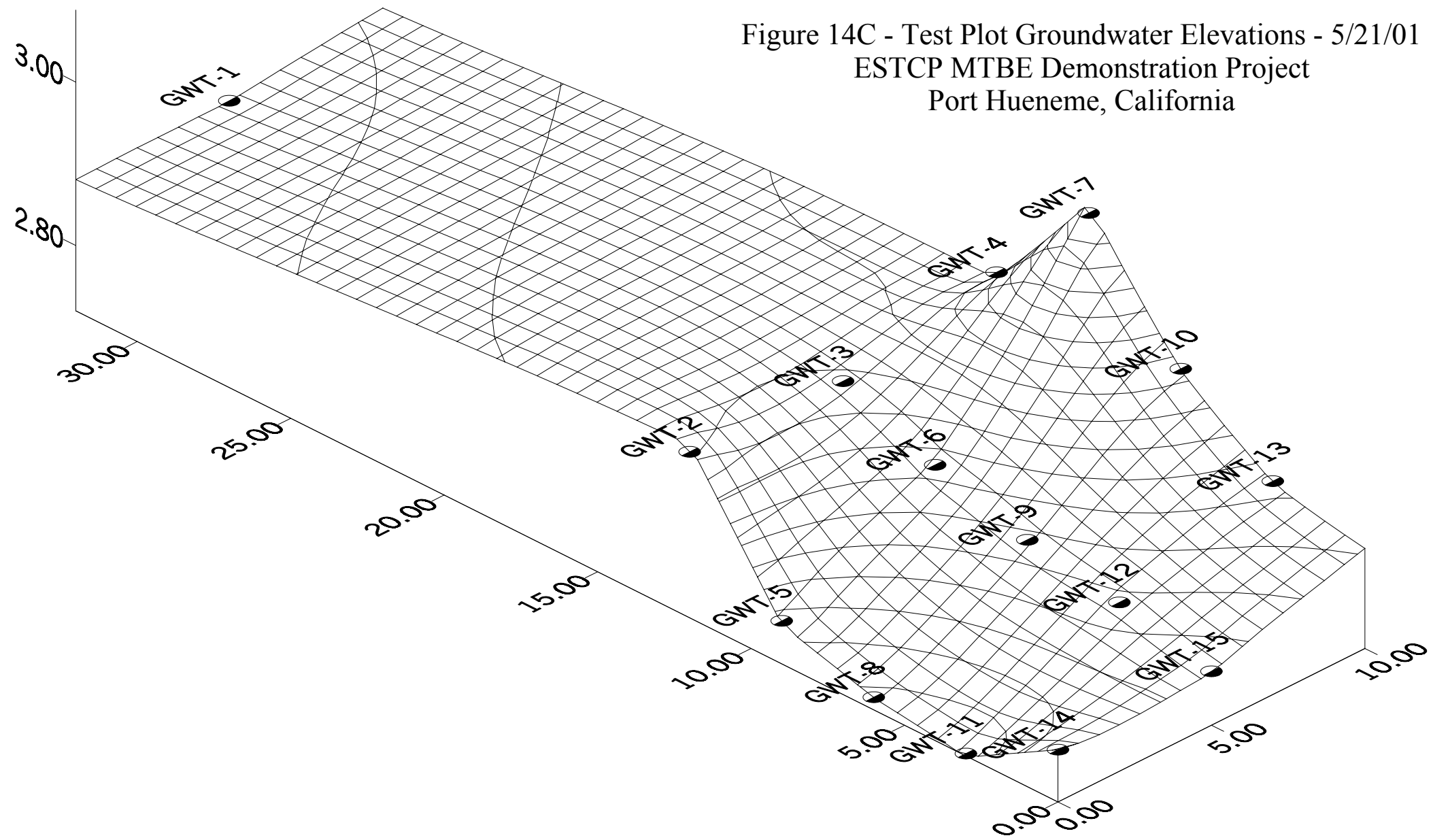

Figure 14D - Test Plot Groundwater Elevations - 6/13/01
ESTCP MTBE Demonstration Project
Port Hueneme, California

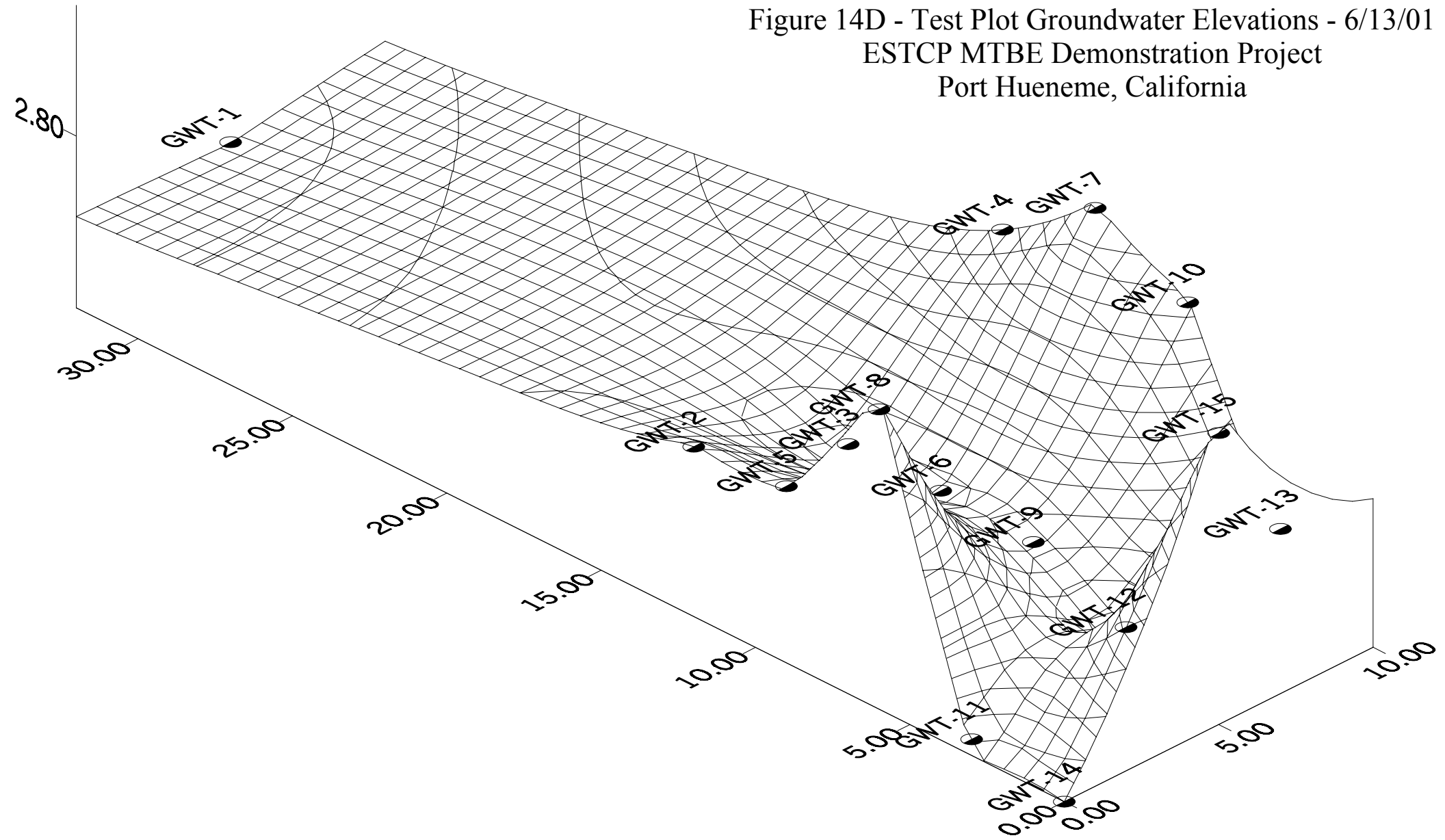

Figure 14E - Test Plot Groundwater Elevations - 6/25/01
ESTCP MTBE Demonstration Project
Port Hueneme, California

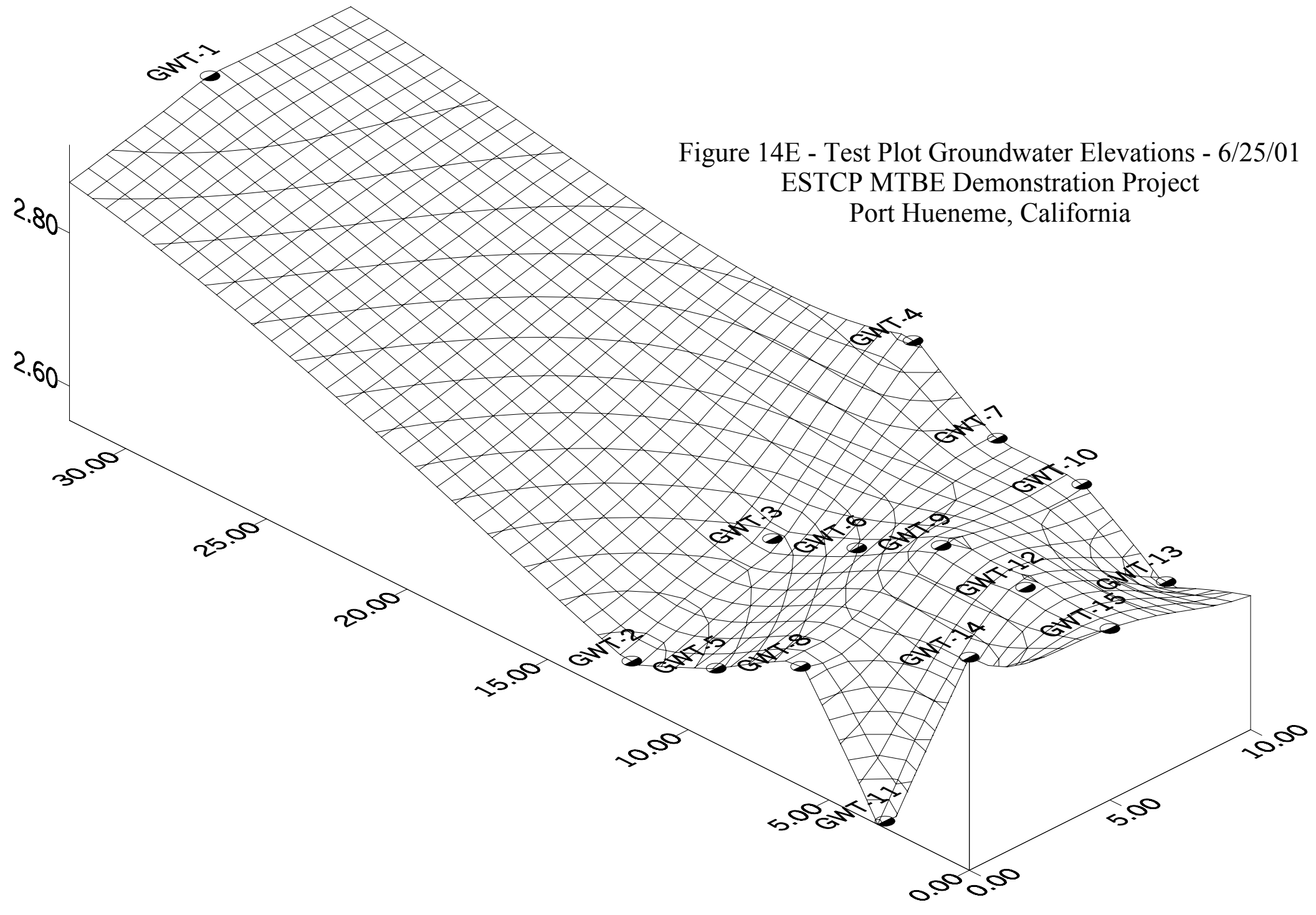

Figure 14F - Test Plot Groundwater Elevations - 7/11/01
ESTCP MTBE Demonstration Project
Port Hueneme, California

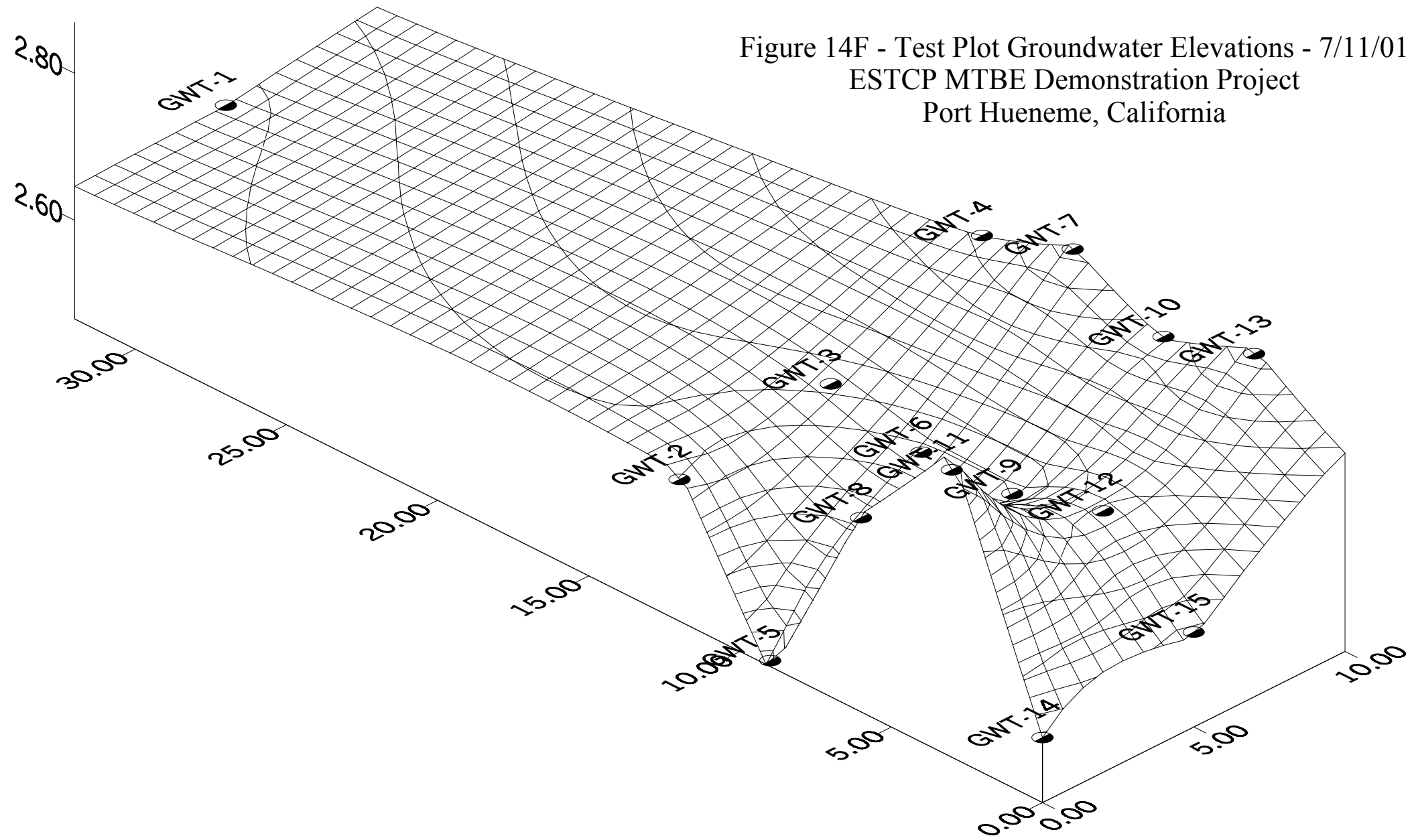

Figure 14G - Test Plot Groundwater Elevations - 7/24/01
ESTCP MTBE Demonstration Project
Port Hueneme, California

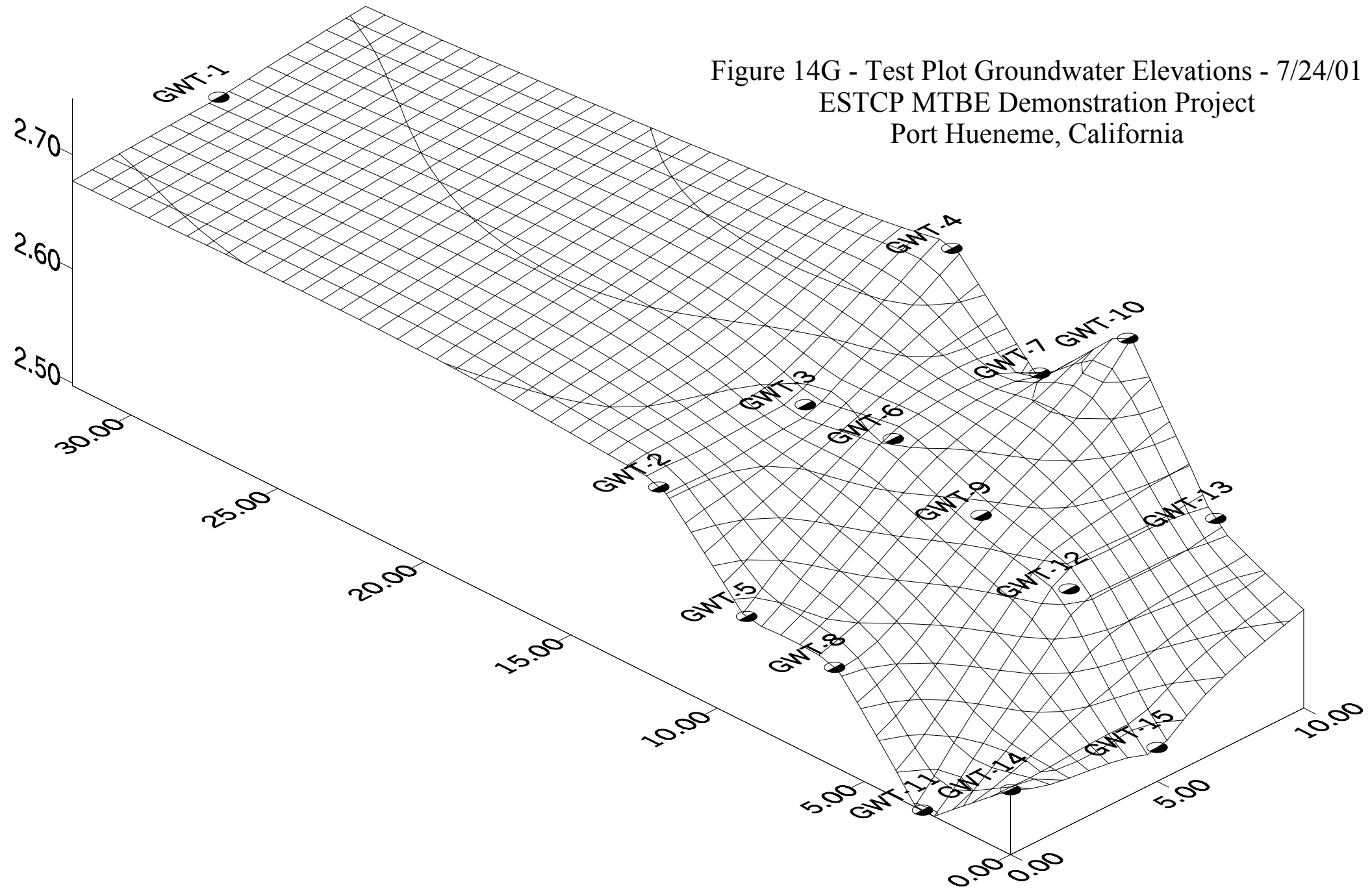

Figure 14H - Test Plot Groundwater Elevations - 8/21/01
ESTCP MTBE Demonstration Project
Port Hueneme, California

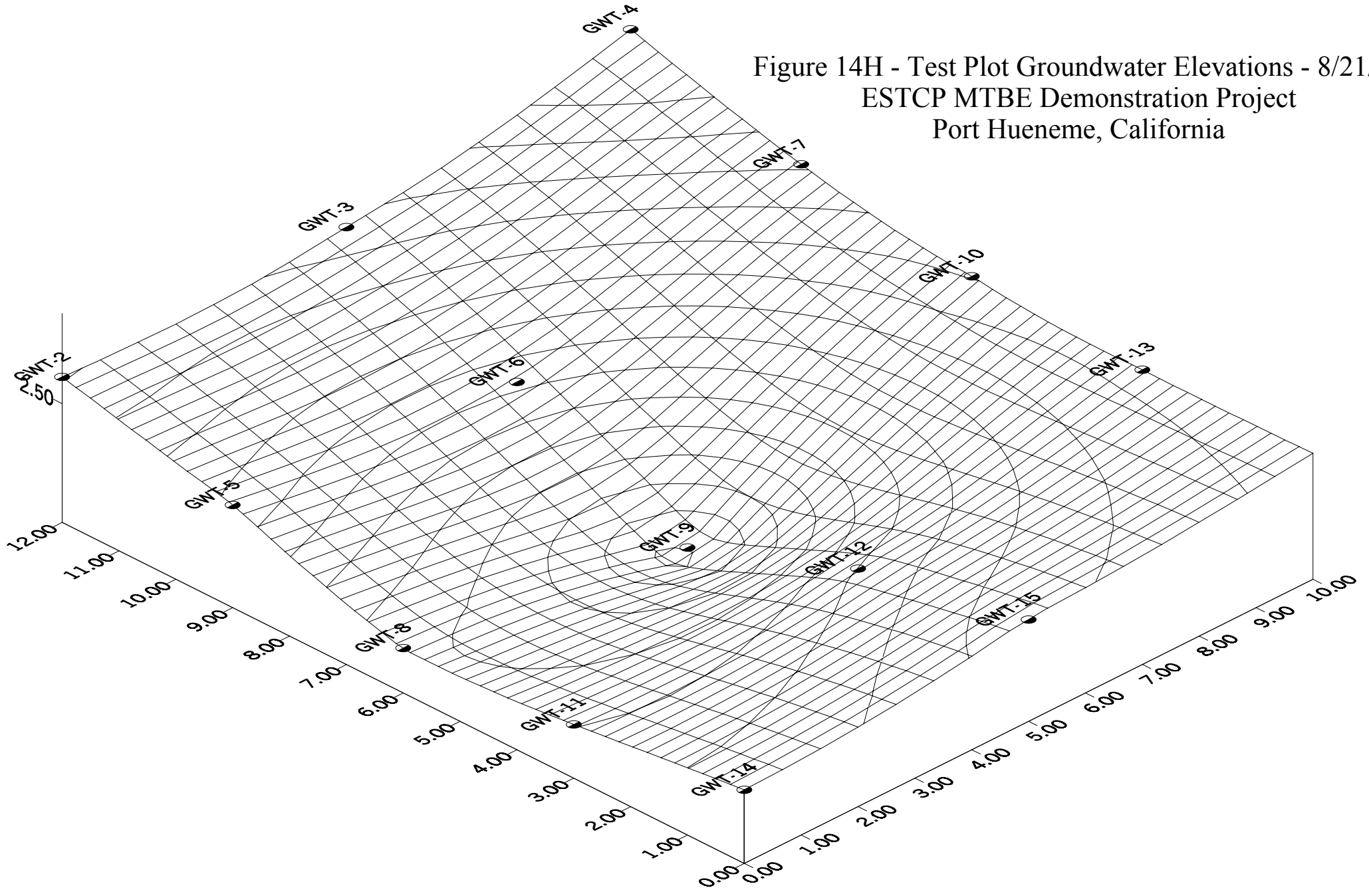

Figure 14I - Test Plot Groundwater Elevations - 9/25/01
ESTCP MTBE Demonstration Project
Port Hueneme, California

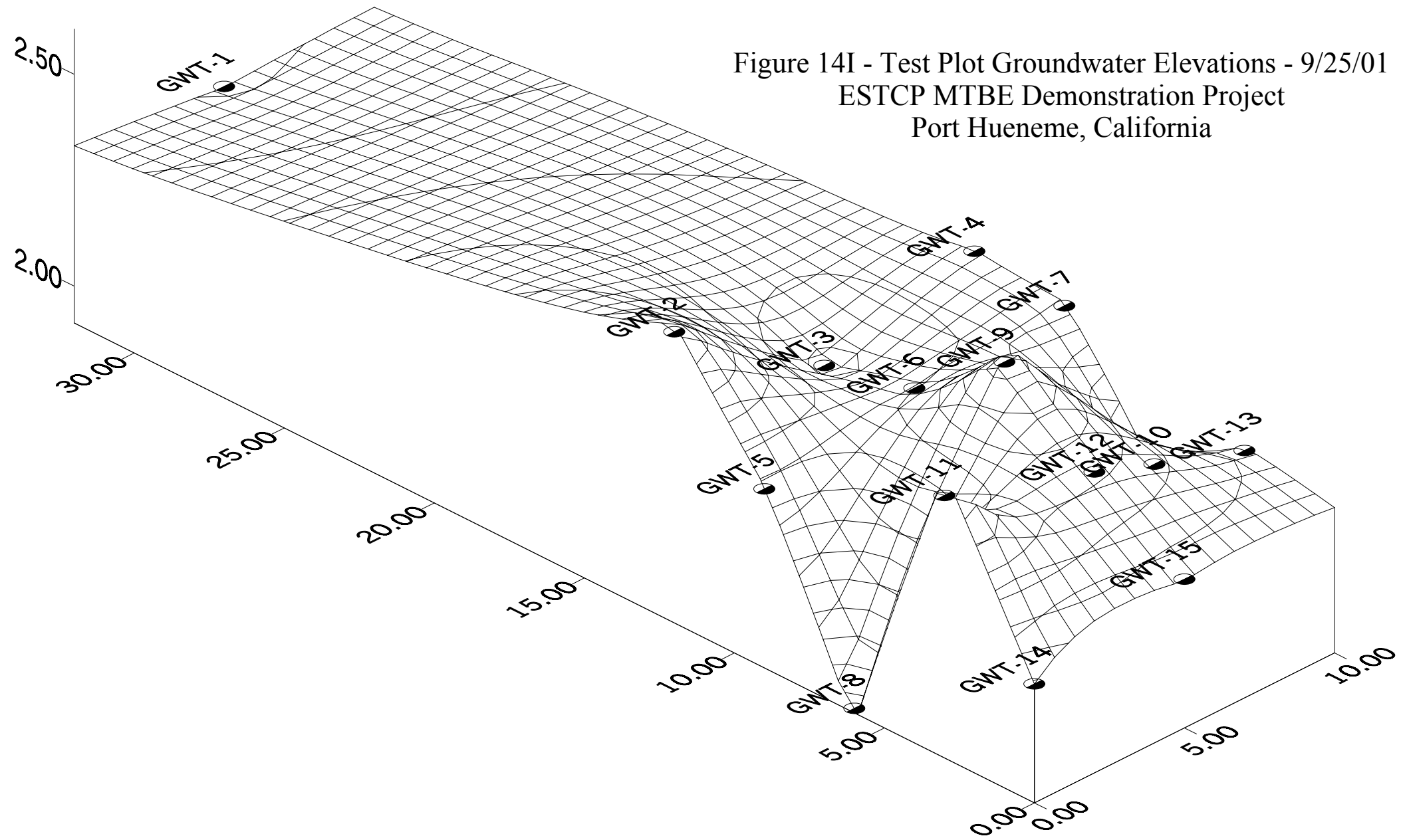

Figure 14J - Test Plot Groundwater Elevations - 10/15/01
ESTCP MTBE Demonstration Project
Port Hueneme, California

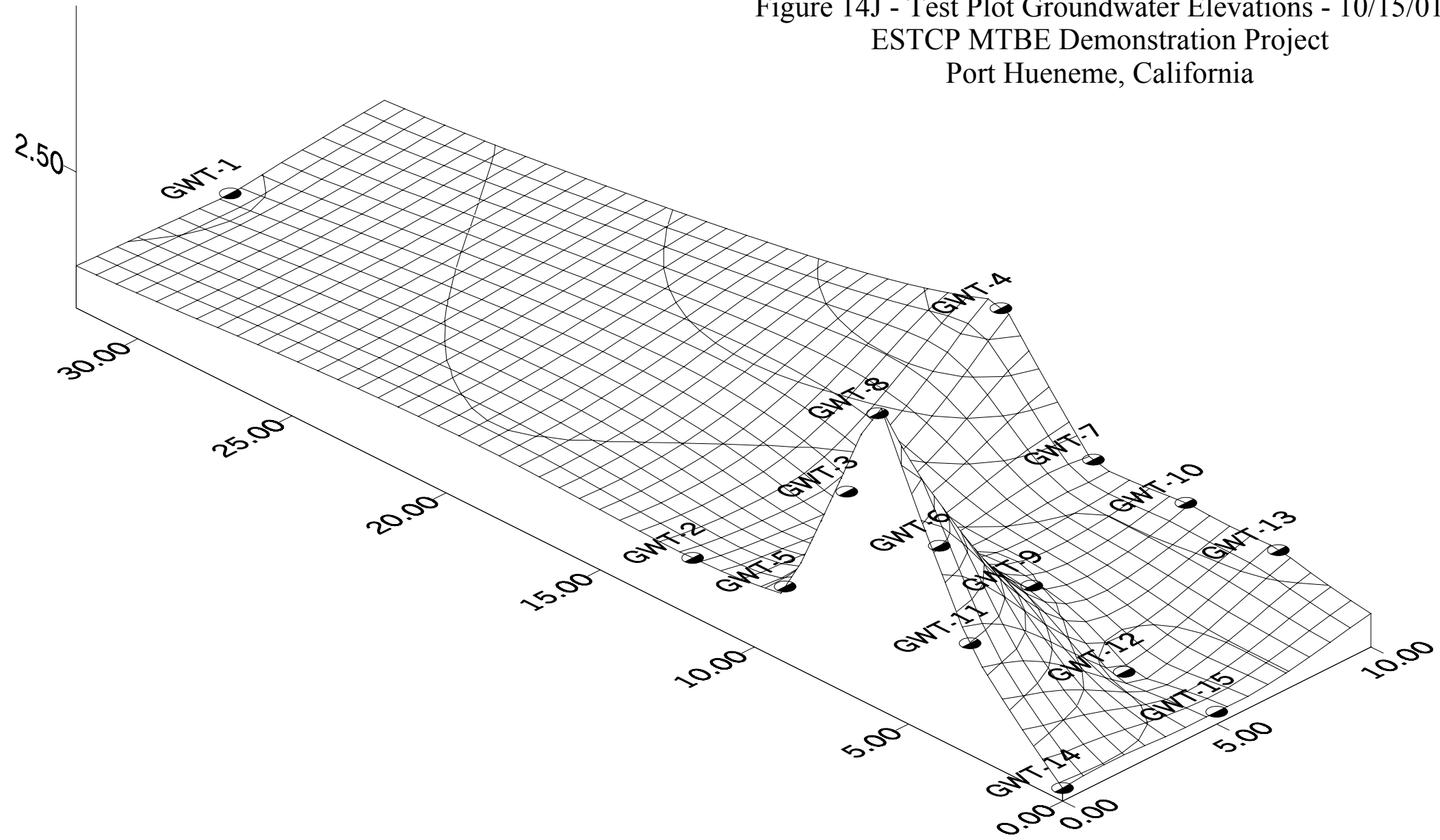

Figure 14K - Test Plot Groundwater Elevations - 11/12/01
ESTCP MTBE Demonstration Project
Port Hueneme, California

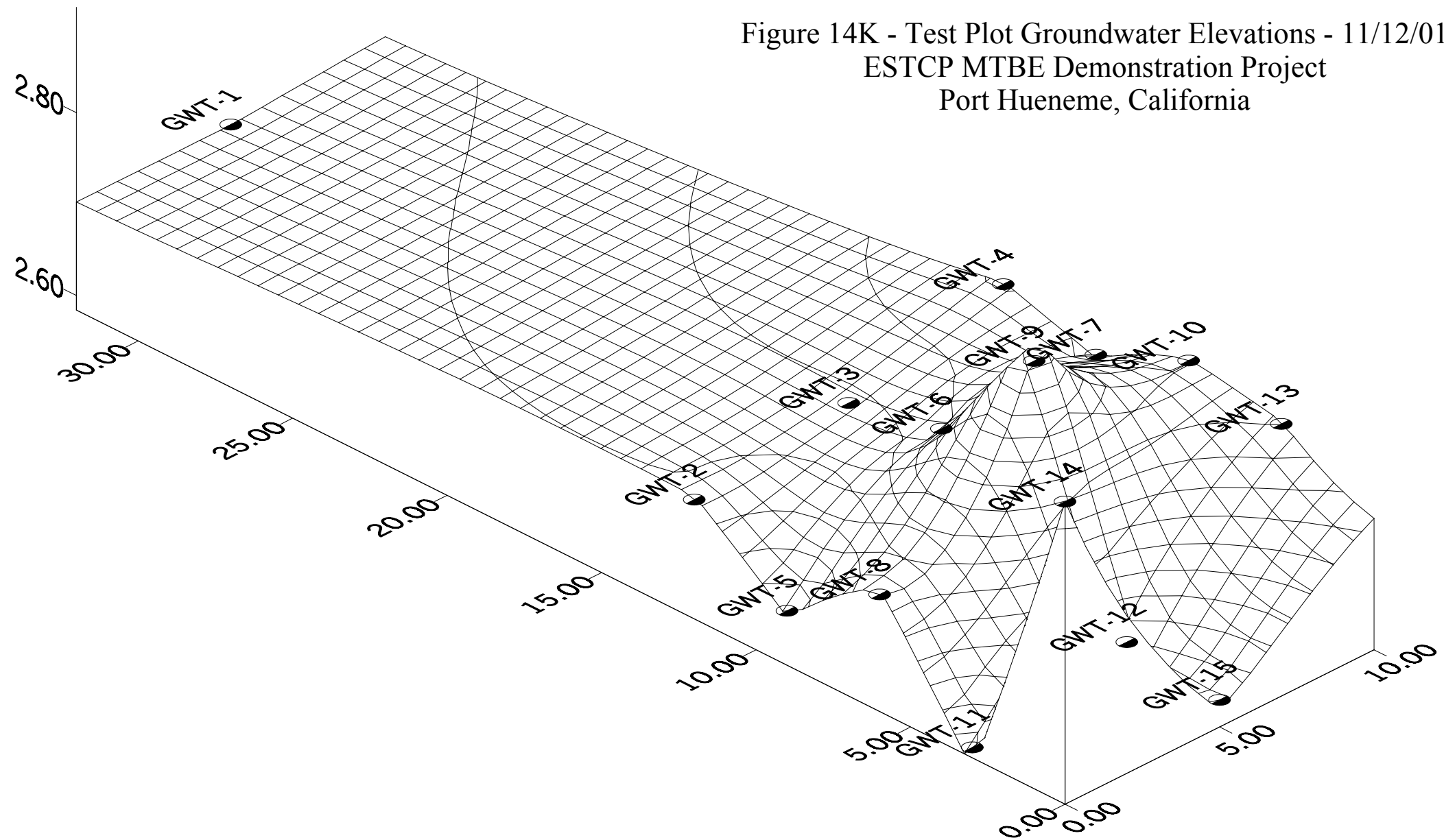

Figure 14L - Test Plot Groundwater Elevations - 12/10/01
ESTCP MTBE Demonstration Project
Port Hueneme, California

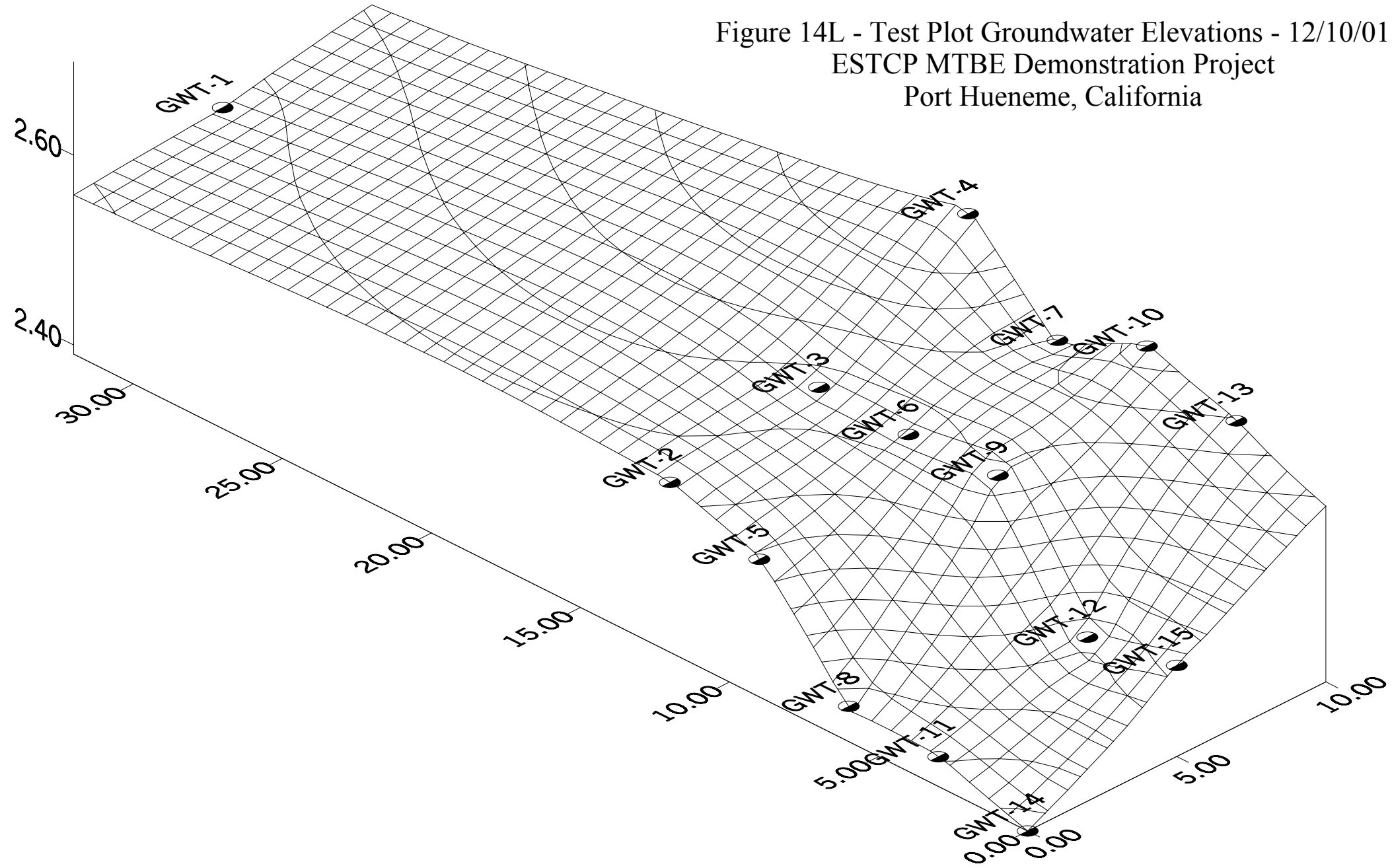

Figure 14L - Test Plot Groundwater Elevations - 12/10/01
ESTCP MTBE Demonstration Project
Port Hueneme, California

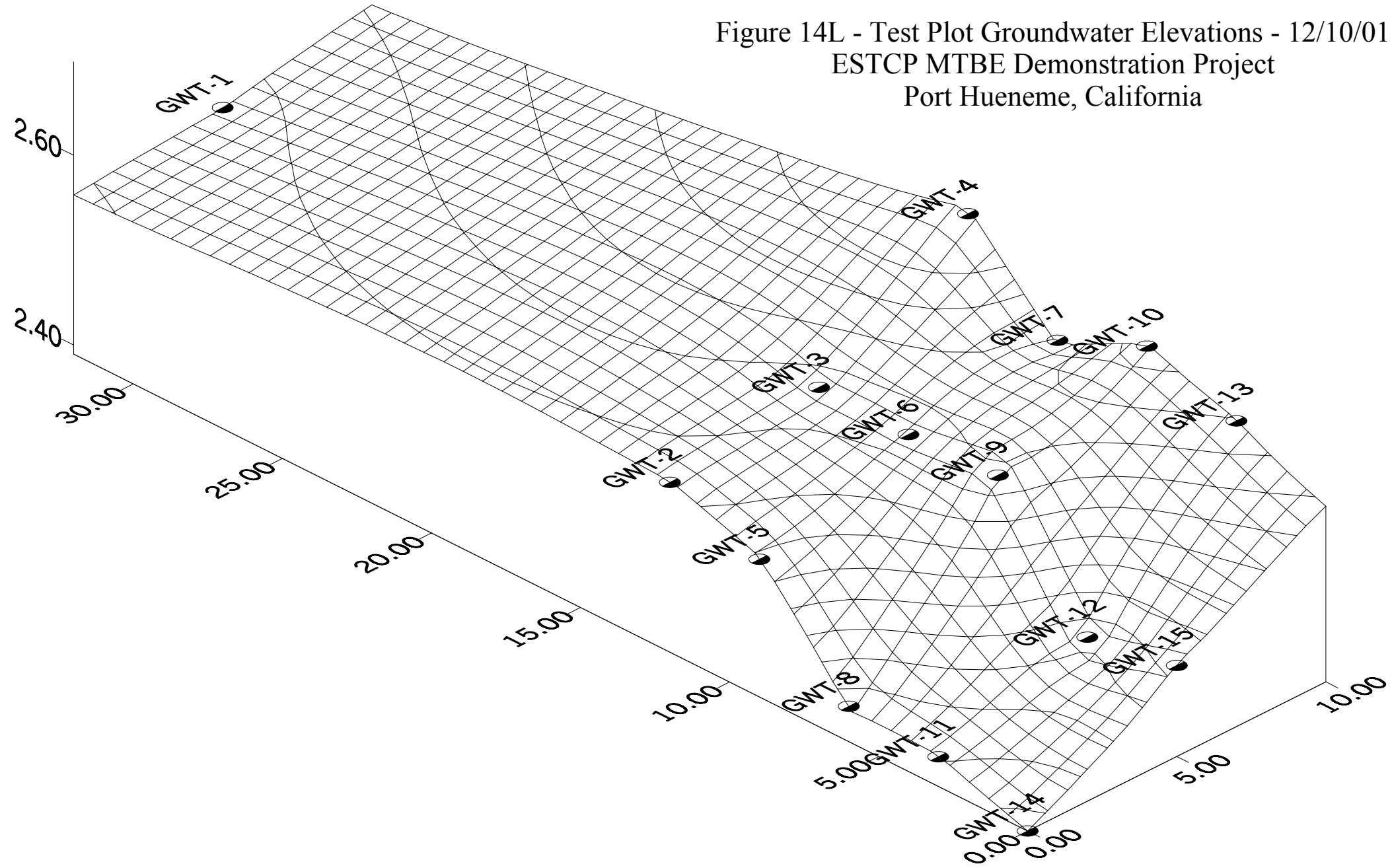

Figure 14M - Test Plot Groundwater Elevations - 1/14/02
ESTCP MTBE Demonstration Project
Port Hueneme, California

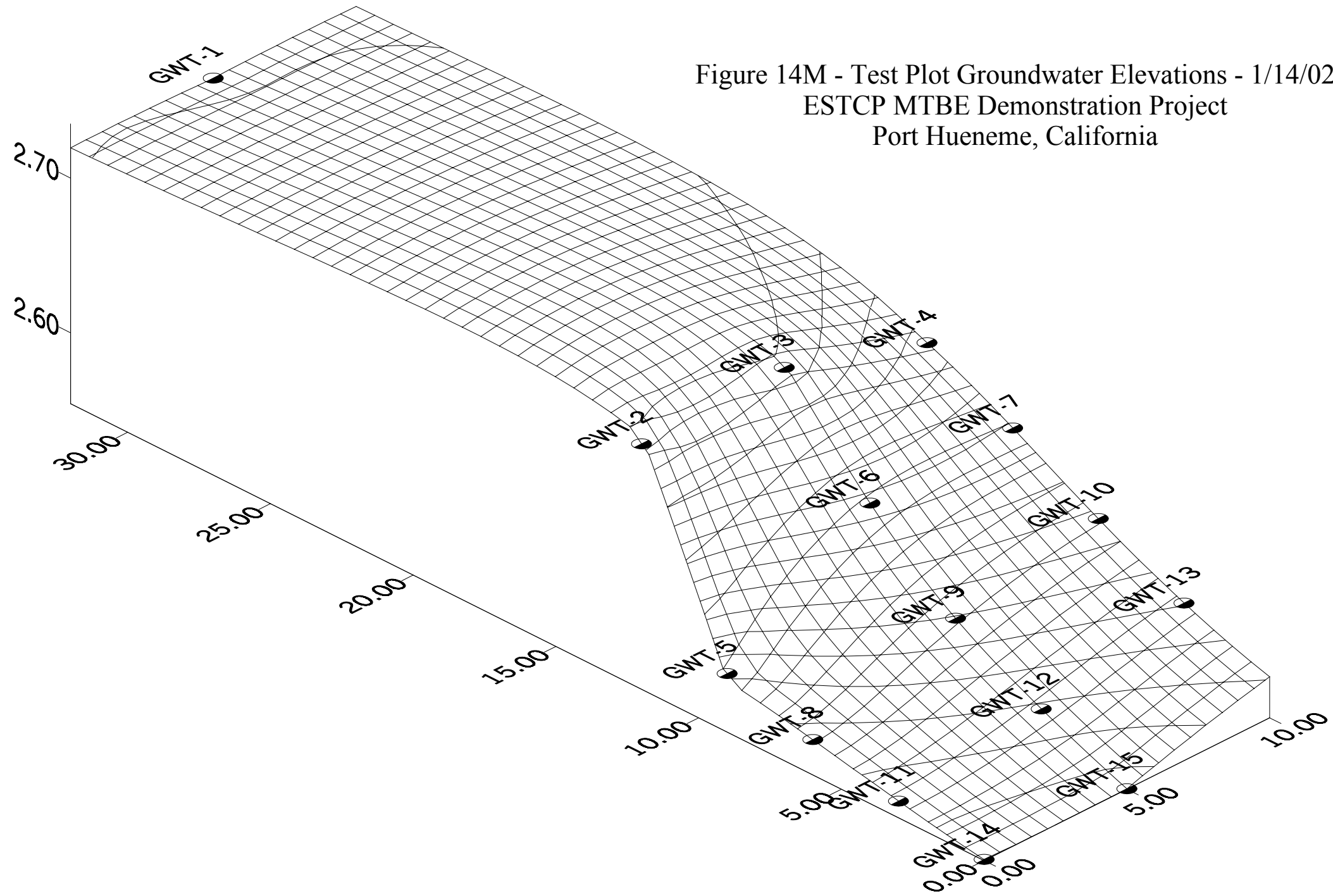

Figure 14N - Test Plot Groundwater Elevations - 2/4/02
ESTCP MTBE Demonstration Project
Port Hueneme, California

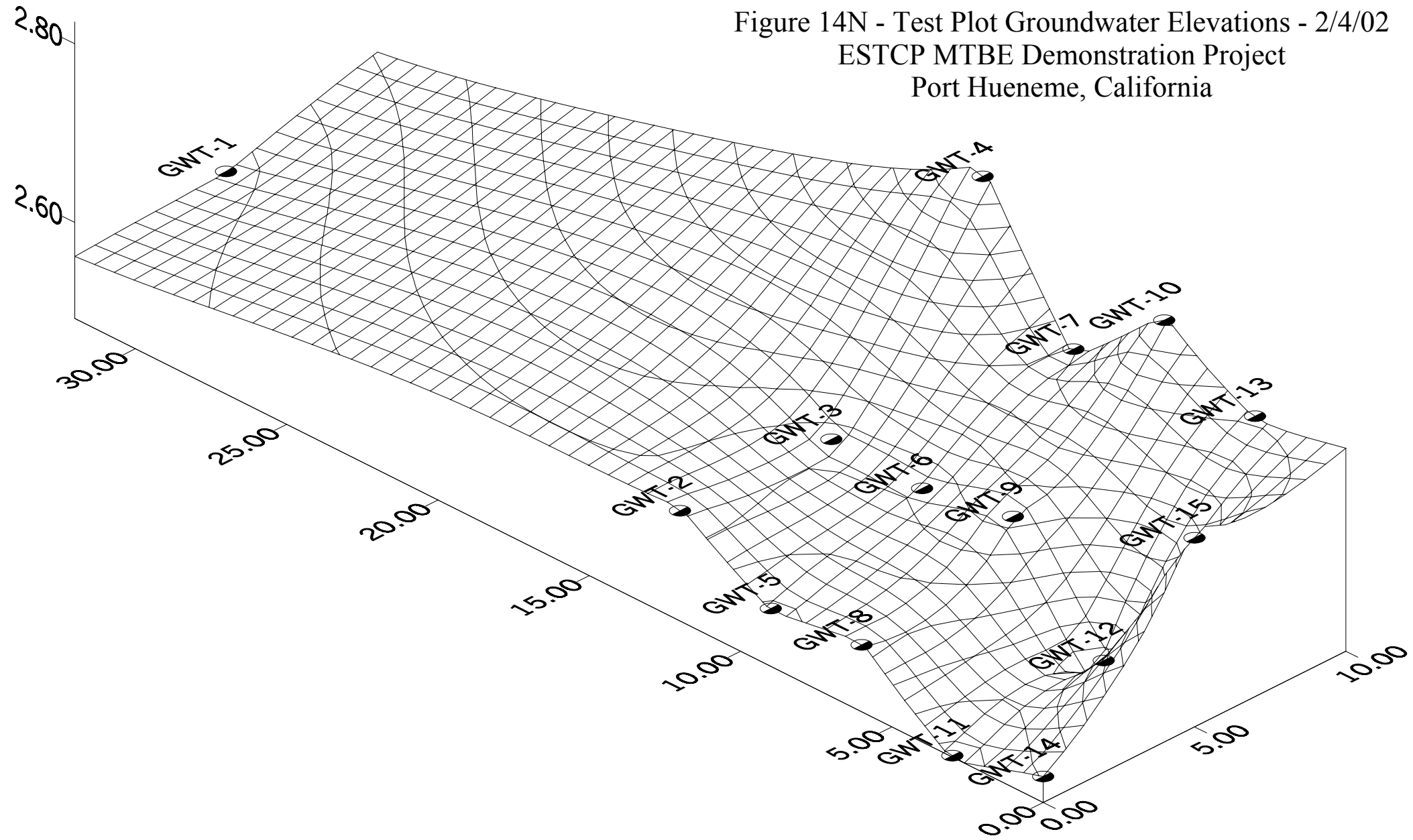

Figure 140 - Test Plot Groundwater Elevations - 3/4/02
ESTCP MTBE Demonstration Project
Port Hueneme, California

