

ESTCP Cost and Performance Report

(ER-0012)



In Situ Catalytic Groundwater Treatment Using Palladium Catalysts and Horizontal Flow Treatment Wells

January 2008



ENVIRONMENTAL SECURITY
TECHNOLOGY CERTIFICATION PROGRAM

U.S. Department of Defense

Report Documentation Page

Form Approved
OMB No. 0704-0188

Public reporting burden for the collection of information is estimated to average 1 hour per response, including the time for reviewing instructions, searching existing data sources, gathering and maintaining the data needed, and completing and reviewing the collection of information. Send comments regarding this burden estimate or any other aspect of this collection of information, including suggestions for reducing this burden, to Washington Headquarters Services, Directorate for Information Operations and Reports, 1215 Jefferson Davis Highway, Suite 1204, Arlington VA 22202-4302. Respondents should be aware that notwithstanding any other provision of law, no person shall be subject to a penalty for failing to comply with a collection of information if it does not display a currently valid OMB control number.

1. REPORT DATE JAN 2008	2. REPORT TYPE	3. DATES COVERED 00-00-2008 to 00-00-2008			
4. TITLE AND SUBTITLE In Situ Catalytic Groundwater Treatment Using Palladium Catalysts and Horizontal Flow Treatment Wells		5a. CONTRACT NUMBER			
		5b. GRANT NUMBER			
		5c. PROGRAM ELEMENT NUMBER			
6. AUTHOR(S)		5d. PROJECT NUMBER			
		5e. TASK NUMBER			
		5f. WORK UNIT NUMBER			
7. PERFORMING ORGANIZATION NAME(S) AND ADDRESS(ES) Environmental Security Technology Certification Program (ESTCP), 4800 Mark Center Drive, Suite 17D08, Alexandria, VA, 22350-3605		8. PERFORMING ORGANIZATION REPORT NUMBER			
9. SPONSORING/MONITORING AGENCY NAME(S) AND ADDRESS(ES)		10. SPONSOR/MONITOR'S ACRONYM(S)			
		11. SPONSOR/MONITOR'S REPORT NUMBER(S)			
12. DISTRIBUTION/AVAILABILITY STATEMENT Approved for public release; distribution unlimited					
13. SUPPLEMENTARY NOTES					
14. ABSTRACT					
15. SUBJECT TERMS					
16. SECURITY CLASSIFICATION OF:			17. LIMITATION OF ABSTRACT Same as Report (SAR)	18. NUMBER OF PAGES 42	19a. NAME OF RESPONSIBLE PERSON
a. REPORT unclassified	b. ABSTRACT unclassified	c. THIS PAGE unclassified			

COST & PERFORMANCE REPORT

Project: ER-0012

TABLE OF CONTENTS

	Page
1.0 EXECUTIVE SUMMARY	1
1.1 BACKGROUND	1
1.2 OBJECTIVES OF THE DEMONSTRATION.....	1
1.3 REGULATORY DRIVERS	1
1.4 DEMONSTRATION RESULTS.....	2
1.5 STAKEHOLDER/END-USER ISSUES	2
2.0 TECHNOLOGY DESCRIPTION	3
2.1 PD-CATALYZED DEHALOGENATION: DEVELOPMENT AND APPLICATION	3
2.2 TREATMENT SYSTEM AND PROCESS FOR PD CATALYZED TCE DESTRUCTION.....	4
2.2.1 Development of a Hydrogen Feed System	4
2.2.2 Hydrogen Demand and Safety	5
2.2.3 Optimization of Treatment Conditions, Catalyst Maintenance, and Regeneration	5
2.3 MOBILIZATION, INSTALLATION, AND OPERATIONAL REQUIREMENTS.....	6
2.4 PREVIOUS TESTING OF THE TECHNOLOGY	7
2.5 ADVANTAGES AND LIMITATIONS OF THE TECHNOLOGY.....	7
3.0 DEMONSTRATION DESIGN	9
3.1 PERFORMANCE OBJECTIVES	9
3.2 SELECTION OF TEST SITE.....	9
3.3 TEST SITE, FACILITY HISTORY, AND CHARACTERISTICS.....	10
3.4 PHYSICAL SETUP AND OPERATION	12
3.5 SAMPLING/MONITORING PROCEDURES	12
3.6 ANALYTICAL PROCEDURES.....	12
4.0 PERFORMANCE ASSESSMENT	13
4.1 CATALYTIC TCE REMOVAL: DATA AND INTERPRETATION.....	13
4.2 PERFORMANCE CRITERIA AND DATA ASSESSMENT	15
4.3 TECHNOLOGY COMPARISON.....	16
5.0 COST ASSESSMENT.....	17
5.1 COST REPORTING.....	17
5.2 COST ANALYSIS.....	18
5.3 COST COMPARISON	22
5.4 LIFE-CYCLE ANALYSIS.....	23

TABLE OF CONTENTS (continued)

	Page
6.0 IMPLEMENTATION ISSUES	25
6.1 COST OBSERVATIONS WITH THE DEMONSTRATION SYSTEM	25
6.2 PERFORMANCE OBSERVATIONS.....	25
6.3 SCALE-UP	25
6.4 OTHER SIGNIFICANT OBSERVATIONS.....	25
6.5 LESSONS LEARNED.....	25
6.5.1 In Situ Versus Ex Situ.....	26
6.5.2 Site Selection	26
6.5.3 System Design, Fabrication, and Procurement.....	27
6.5.4 Project Management	27
6.6 END-USER ISSUES	28
6.7 APPROACH TO REGULATORY COMPLIANCE AND ACCEPTANCE.....	28
7.0 REFERENCES	29
APPENDIX A POINTS OF CONTACT.....	A-1

LIST OF FIGURES

	Page
Figure 1.	Schematic of Treatment System 4
Figure 2.	Schematic of Hydrogen Feed System 4
Figure 3.	Regeneration After Severe Episodes of Reactor Poisoning During 2004 5
Figure 4.	Regeneration and Reactivation of Reactor After Poisoning Events Due to Insufficient Maintenance Bleaching 6
Figure 5.	Performance of T1 Pd Catalyst Reactor July-September 2005 13
Figure 6.	TCE Removal During One-Day Bleaching Regime 14
Figure 7.	TCE Residual Concentration Detail Under One-Day Bleaching Regime 14

LIST OF TABLES

	Page
Table 1.	Advantages of Pd/HFTW Technology Relative to Competing Technologies..... 7
Table 2.	Performance Objectives 9
Table 3.	Expected Performance and Performance Confirmation Results..... 15
Table 4.	Cost Elements 17
Table 5.	Technologies for VOC Remediation 18
Table 6.	Basis for Cost Comparison 19
Table 7.	Capital Costs 19
Table 8.	Operation and Maintenance Costs 20
Table 9.	Monitoring Costs 21
Table 10.	Examples of Cost Evaluations of Different Competing Technologies..... 22
Table 11.	Present Value Estimates Pd Reactor Operation 24

ACRONYMS AND ABBREVIATIONS

AFB	Air Force Base
AFFTC	Air Force Flight Test Center
ASAP	Automated Sampling and Analysis Platform
DBCP	1,2-dibromo-3-chloropropane
DCE	dichloroethylene
DoD	Department of Defense
EPA	Environmental Protection Agency
ESTCP	Environmental Security Technology Certification Program
GAC	granular activated carbon
GC	gas chromatography
gpm	gallons per minute
HazWOpER	Hazardous Waste Operations and Emergency Response
HFTW	horizontal flow treatment well
IC	ion chromatography
LLNL	Lawrence Livermore National Laboratory
MCL	maximum contaminant level (established under the Safe Drinking Water Act)
NPV	net present value
O&M	operations and maintenance (or operating and maintenance)
OSHA	Occupational Safety and Health Administration
P&T	pump and treat
PCE	perchloroethylene or tetrachloroethylene
Pd	palladium
PRB	permeable reactive barrier
TCE	trichloroethylene
VC	vinyl chloride
VOC	volatile organic compound
XPS	X-ray photo-electron spectroscopy

This page left blank intentionally.

ACKNOWLEDGEMENTS

In addition to Environmental Security Technology Certification Program (ESTCP), the following organizations and agencies provided support for this project:

- Environmental Protection Agency (EPA) under agreements R-825421 and R-815738-01 through the Western Region Hazardous Substance Research Center, Stanford University under Lew Semprini
- The National Science Foundation Science and Technology Center The Center of Advanced Materials for the Purification of Water with Systems (WaterCAMPWS) through agreement CTS-0120978 under Vern Snoeyink
- The Environmental Management Restoration Branch, AFFTC/EMR, Edwards Air Force Base.

Technical material contained in this report has been approved for public release.

This page left blank intentionally.

1.0 EXECUTIVE SUMMARY

1.1 BACKGROUND

The EPA estimated in 1996 that of 8,336 Department of Defense (DoD) sites needing cleanup, approximately 70% had contaminated groundwater, mostly from chlorinated solvents such as trichloroethylene (TCE) and tetrachloroethylene (PCE). Because TCE and PCE are mobile and refractory in aquatic environments, there is significant need for efficient treatment methods. Palladium (Pd) catalyzed reductive dechlorination transforms chlorinated ethylenes and other volatile organic compounds (VOCs) into their respective saturated hydrocarbons or lesser chlorinated analogues. With hydrogen gas as the reductant, the process is selective requiring only small quantities of hydrogen to remove contaminants to below regulatory limits. For some VOCs the dechlorination reaction occurs rapidly, even in water under ambient temperature, pressure and pH. The process can be utilized to efficiently treat water contaminated with reactive chlorinated contaminants. A one-pass catalytic process has many advantages, mainly that contaminants are destroyed instead of being transferred to another medium (e.g., air or activated carbon), thus avoiding generating a secondary waste stream. The technology is particularly favorable for treating water contaminated with high concentrations (>1 mg L⁻¹) of chlorinated ethylenes and is therefore suited for source control.

1.2 OBJECTIVES OF THE DEMONSTRATION

The principal objectives of this evaluation were to:

- Demonstrate the efficacy of catalytic treatment for the destruction of chlorinated ethylenes in groundwater using Pd catalyst
- Optimize treatment efficiency
- Develop cost and performance data for full-scale application of the technology.

The demonstration at Edwards AFB was operated in a manner close enough to full-scale that costs were scaled accordingly to represent full-scale application. In the initial proposal, the reactors were expected to be mounted below grade within the horizontal flow treatment wells (HFTW), thus qualifying as an in situ technology. The selected test site was the Edwards AFB site where the HFTW technology was tested previously in the context of biological treatment (McCarty et al., 1998). Although a dual-column configuration in situ might be possible in principle, its realization was not feasible within the constraints of this pilot-scale demonstration. Once operational issues were resolved and the regeneration protocol was optimized, the catalyst reactor successfully reduced the TCE concentrations in the groundwater by two to three orders of magnitude (more than 99%) consistently and without significant loss of catalyst activity.

1.3 REGULATORY DRIVERS

TCE is a known carcinogen, along with other chlorinated ethylenes such as PCE, dichloroethylene (DCE), and vinyl chloride (VC). EPA and the State of California Department of Health Services set a maximum contaminant level (MCL) of 5 µg L⁻¹.

1.4 DEMONSTRATION RESULTS

Catalytic TCE destruction was demonstrated for the treatment of contaminated groundwater at Edwards AFB, California. The process performed as expected, resulting in average effluent concentrations consistently below the MCL ($5 \mu\text{g L}^{-1}$) after one pass through a Pd reactor with contact time of approximately one minute. Influent concentrations ranging from 800 to $1,200 \mu\text{g L}^{-1}$ were reduced by more than 99.6% under normal operating conditions. Based on the experience of this project, a capital investment of \$574,000 and annual operations and maintenance (O&M) costs of about \$70,000 (including monitoring and analysis) are sufficient to successfully remediate TCE-contaminated groundwater. The total net present value (NPV) of such a project over a 10-year period is calculated to be \$1.07 million. Unique water matrices and the opportunity for multi-contaminant remediation in a single pass make reductive catalysis competitive with and potentially advantageous over other remediation schemes such as air stripping, granular activated carbon (GAC) and permeable reactive barriers (PRB).

1.5 STAKEHOLDER/END-USER ISSUES

Potential end users for this technology are organizations responsible for remediating groundwater sites contaminated with chlorinated ethylenes (PCE, TCE, DCE isomers and VC). The technology demonstration at Edwards AFB focused on TCE and concluded:

- Pd catalysis consistently destroys TCE even in anaerobic (but not sulfidic) groundwater.
- The technology can reduce concentrations of TCE to below its MCL.
- Hazardous byproducts are not formed during treatment.
- Operating protocols were determined for aboveground systems.
- Experience gained in designing and constructing the reactor system led to significant improvements, lower anticipated costs, and more reliable cost estimates for future applications.
- Site specific operating protocols were developed.
- Cost information was developed that demonstrates that the technology can be competitive at the scale of the demonstration. From the data provided, it is possible to estimate treatment costs for scaled-up systems. Before scale-up, however, site-specific pilot tests are recommended to assess the fouling potential of the groundwater.

For some frequently found groundwater contaminants such as 1,1,1-trichloroethane, 1,2-dichloroethane and methylene chloride, the process is not effective, and for others (e.g., chloroform), it is slower than for TCE and PCE.

2.0 TECHNOLOGY DESCRIPTION

2.1 PD-CATALYZED DEHALOGENATION: DEVELOPMENT AND APPLICATION

Pd catalysts, in the presence of hydrogen gas, transform many chlorinated VOCs into their respective hydrocarbon compounds. To maximize the specific Pd surface area while minimizing the amount of metal used, a thin layer of Pd is supported on a porous support material such as porous gamma-alumina ($\gamma\text{-Al}_2\text{O}_3$). Pd catalyst transforms chlorinated ethylenes to ethane by replacing all chlorine atoms with hydrogen and hydrogenating the double bond. TCE, for example, reacts with four moles of hydrogen gas to form ethane and three moles of hydrochloric acid, as shown below:

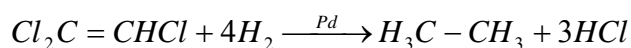

This reaction is extremely rapid in water (nearly diffusion limited), even at ambient temperature, and proceeds completely to ethane (Lowry and Reinhard, 1999). In the presence of excess hydrogen, no significant amounts of intermediates (e.g., vinyl chloride) are formed. The formation of hydrochloric acid as a reaction product does not generally represent an obstacle for technology application to contaminated groundwater sites because the reactant TCE concentrations are generally low (less than 30 mg L^{-1}), and groundwater usually has sufficient natural buffer capacity.

The ability of Pd metal to catalyze dehalogenation reactions has been known for decades, but only recently has been applied to treatment of contaminated water. Over the past decade, Reinhard and coworkers have investigated contaminants that are amenable to dechlorination or reduction via Pd catalysis, determined the reaction rates, and developed protocols to maintain catalyst activity over time (Schreier and Reinhard, 1995; Siantar et al., 1996; Lowry and Reinhard, 1999, 2000; Munakata, 2005; Davie and Reinhard, 2006; Munakata and Reinhard, 2007).

A column reactor was designed for this demonstration in conjunction with HFTWs. The treatment system design was based on the subsurface reactor system that has been operated since 1999 at the Lawrence Livermore National Laboratory (LLNL) (McNab et al., 2000). That system relies on daily venting with air for approximately 12 hrs to prevent growth of sulfidogenic bacteria and fouling. These operating conditions limit the overall efficiency of the system to about 50% (McNab et al., 2000). To increase the operating time, the Edwards AFB system was equipped with an automatic bleaching system to allow for more aggressive regeneration and fouling prevention protocols, relying on bleach or hydrogen peroxide as oxidants (Lowry and Reinhard, 2000). The system was built by a commercial vendor (Bigler and Associates, Lakewood, New Jersey) and delivered directly to the site. During the start-up phase, numerous components of the system had to be modified to meet the needs and conditions of the Edwards AFB site, significantly delaying operation and augmenting expenses, as discussed below.

2.2 TREATMENT SYSTEM AND PROCESS FOR Pd CATALYZED TCE DESTRUCTION

The reactor designed for this demonstration is shown in Figure 1. The major components include the column reactor, hydrogen feed system, and bleaching system. Because the catalytic reaction is most efficient for the destruction of TCE, the technology demonstration focused on TCE as the target contaminant, and a site was selected where TCE was the only contaminant.

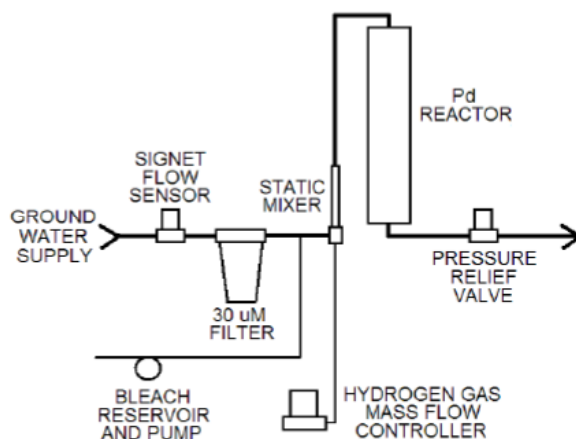

Figure 1. Schematic of Treatment System.

The hydrogen feed system and the protocol for maintaining catalyst activity by bleaching were developed during the course of this demonstration.

2.2.1 Development of a Hydrogen Feed System

According to the original design, the hydrogen feed system consisted of hollow fiber diffusion modules, a 5 L min^{-1} mass flow meter for hydrogen feed and controlled by a hydrogen pressure regulator. To achieve reliable hydrogen feed, mass flow meters were replaced with mass flow controllers; to make the system resistant against biological fouling, gas diffusion modules were replaced with a low-pressure solvent frit and static mixer. The frit produced fine hydrogen bubbles that were dissolved in the static mixer, as shown in the final feed design in Figure 2.

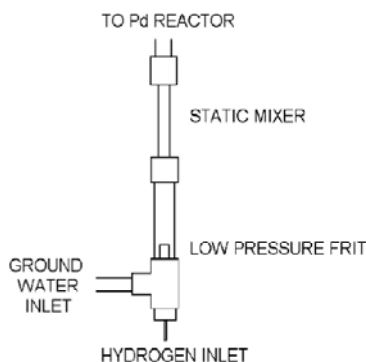

Figure 2. Schematic of Hydrogen Feed System.

2.2.2 Hydrogen Demand and Safety

The flammability of hydrogen is a well known risk and prompted health and safety precautions at the Edwards AFB site. For hydrogen/air mixtures, the flammability at standard temperature and pressure is 6.2 to 71.1% by volume (Dean, 1952) (62 to 711 mL L⁻¹ in air). Considering the low surface area of exposed discharge within the well, the cross sectional area of the well casing and the hydrogen concentration being less than about 20% its solubility, very little hydrogen was expected to volatilize within the well—most would transport into the aquifer as dissolved hydrogen or would rapidly be consumed by sulfate-reducing bacteria.

2.2.3 Optimization of Treatment Conditions, Catalyst Maintenance, and Regeneration

The reactor “effluent” sample was actually measured in the discharge well, thus some of the time attributed to catalyst regeneration in this study was actually just mixing time for discharged water within the well to reduce sample TCE concentrations to near or below the detection limit. The discussion of system optimization includes this mixing time in the catalyst regeneration cycle; a more optimized design would sample at the discharge port of the Pd reactor and would likely show a much shorter regeneration cycle time.

Bleaching the Pd catalyst with a dilute solution both prevents the growth of sulfidogenic bacteria and removes inhibitory materials from the catalyst surface. Preventing growth of sulfidogenic bacteria is imperative because once sulfide production starts the catalyst is poisoned, TCE removal decreases rapidly and breakthrough occurs. Loss of activity can be tolerated up to the point where effluent specifications MCLs are exceeded, but preventive regeneration with bleach oxidation curtails these operational issues.

Bleaching the catalyst temporarily suspends its activity for TCE reduction because the Pd surface is oxidized in the process. Reactivation of the catalyst is accomplished by contacting the catalyst with hydrogen-saturated water, reducing the oxidized active sites on the Pd surface. Recovery of catalytic activity is shown in Figure 3; catalyst that was severely poisoned and subsequently oxidized by bleaching regained activity for TCE reduction as hydrogen-saturated groundwater was passed through the column.

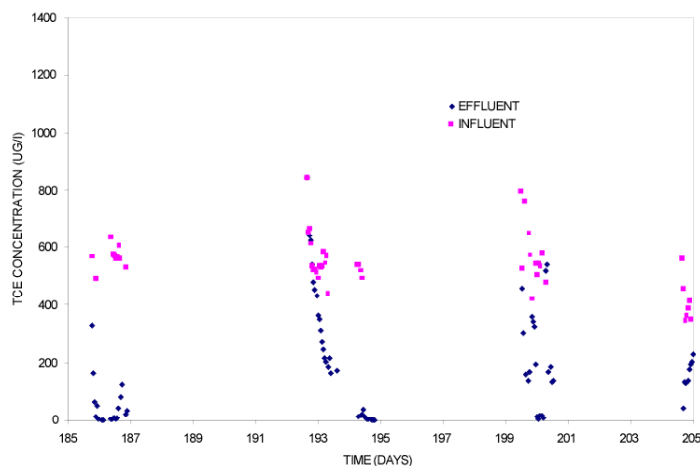

Figure 3. Regeneration After Severe Episodes of Reactor Poisoning During 2004.

A sequence of several maintenance bleaching cycles is shown in Figure 4. Bleach affects the catalyst surface by creating oxidative conditions within the reactor—eliminating hydrogen from the water oxidizes Pd active sites. When groundwater containing sulfide species is treated in a reductive catalytic reactor, hydrogen sulfide strongly binds to active Pd sites and poisons the catalyst. However, catalyst activity and capacity for TCE reduction may remain high for several days, keeping the effects of sulfide poisoning undetected. After 3-4 days and treatment of approximately 10,000 gal water (at 2 gpm), the number of active Pd sites poisoned by hydrogen sulfide becomes significant and overall TCE removal efficiency decreases. Effluent TCE concentrations eventually exceed the MCL ($5 \mu\text{g L}^{-1}$) and another oxidative treatment (bleach) must be applied to regain catalyst activity.

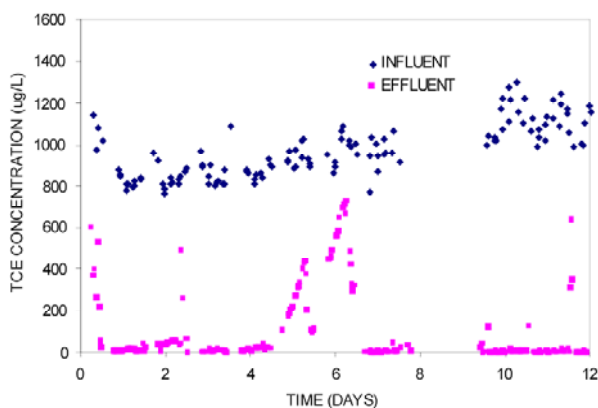

Figure 4. Regeneration and Reactivation of Reactor After Poisoning Events Due to Insufficient Maintenance Bleaching.

The effect of omitted daily bleach cycles on reactor performance is also evident from the data shown in Figure 4. The expected TCE pulse on Day 4 was not detected, presumably because the bleaching systems malfunctioned and did not deliver the bleach pulse. On Day 5, TCE concentrations began to rise rapidly because, after two missed bleach cycles, biological fouling began and caused sulfide poisoning of the Pd catalyst. Fouling was severe enough that the bleach cycle of Day 5 (indicated by the sharp drop in TCE concentration) was not sufficient to regenerate catalyst activity. Catalyst poisoning increased until two manual bleach cycles were applied on Day 6.

2.3 MOBILIZATION, INSTALLATION, AND OPERATIONAL REQUIREMENTS

Reactor components, (Pd reactor, hydrogen augmentation, bleach pump, and reservoir) should be installed in a secure place near the treatment well. Mass flow controllers, hydrogen supply and computer control systems require housing in a weather-proof and temperature controlled room such as a trailer. Bleach solution usage should be logged regularly. Samples should be collected at a frequency sufficient to detect the onset of fouling and control with maintenance bleaching. If contaminant concentrations exceed expectations (i.e., MCL), more frequent sampling and/or long term regeneration should be performed. Effluent bleach concentrations during regeneration should be monitored on initial startup and periodically thereafter to confirm bleach residual of at least 50 mg L^{-1} . This can be done using a standard pool chlorine test kit.

2.4 PREVIOUS TESTING OF THE TECHNOLOGY

McNab et al. (2000) describe the design and performance of the first LLNL system, which has operated since 1999 in situ with reactor columns mounted in the well bore. The second LLNL system is an above grade system operated since 2002. The first LLNL system operates for 12 hrs followed by regeneration in air for 12 hrs. The second system is limited by the yield of the wells and operates only 6 hrs daily. During the remaining 18 hrs, the system is drained and catalyst is exposed to air to prevent growth of anaerobic bacteria. Reactor design for the Edwards AFB demonstration was based on the experiences gained through operation of the LLNL systems and laboratory research at Stanford on catalyst fouling. Compared with the LLNL systems, the Edwards AFB project incorporated two major modifications to improve overall efficiency:

- (1) Catalyst regeneration with bleach instead of air venting
- (2) Treatment of groundwater streams with two catalytic reactors simultaneously in conjunction with a horizontal flow treatment well (HFTW).

2.5 ADVANTAGES AND LIMITATIONS OF THE TECHNOLOGY

The potential advantages of the catalytic treatment technology compared to potential alternatives are listed in Table 1. Alternatives considered include pump-and-treat, biological cometabolic oxidation (McCarty et al., 1998), and a PRB.

Table 1. Advantages of Pd/HFTW Technology Relative to Competing Technologies.

Technology	Advantages of Pd/HFTW Technology
Pump-and-treat with activated carbon or air stripping	<ol style="list-style-type: none"> 1. No secondary waste stream. 2. Destroys trichloroethylene (TCE), tetrachloroethylene (PCE), dichloroethylene (DCE), vinyl chloride (VC) and other chlorinated compounds 3. Rapid transformation, making technology applicable to source control 2. Destroys TCE, PCE, and other chlorinated compounds, rather than merely transferring them from the groundwater to another medium (e.g., activated carbon) 3. Transforms chlorinated ethylene compounds very rapidly, making Pd/HFTW technology less expensive in many cases and cleanup times shorter
Biological co-metabolic oxidation	<ol style="list-style-type: none"> 1. Applicable at high concentrations, e.g., source control 2. Can destroy contaminants such as PCE that are not amenable to biodegradation 3. No toxic intermediates formed 4. Rapid transformation
PRB	<ol style="list-style-type: none"> 1. Cheaper installation, especially at sites with deep contamination 2. Faster transformation than zerovalent iron, the metal typically used in PRBs

Advantages of Pd catalysis stem from the technology being destructive and having a small footprint selectivity. Additionally, the process requires only small quantities of a cheap reagent (hydrogen) to complete the reduction. Limitations to the Pd/HFTW technology include the following:

- Sulfide poisons the catalyst, and growth of sulfate-reducing bacteria is encouraged by hydrogen addition to the groundwater as a reagent, requiring biofouling control systems.

- Pd reductive technology is not effective for some common VOCs (e.g., 1,1-dichloroethane, 1,2-dichloroethane, and methylene chloride).

3.0 DEMONSTRATION DESIGN

3.1 PERFORMANCE OBJECTIVES

The objective of this project was to demonstrate the feasibility of catalytically destroying TCE in groundwater. The technology is also applicable to high concentrations for control of contaminant sources. Table 2 provides details of the performance objectives.

Table 2. Performance Objectives.

Performance Objective	Primary Performance Criteria	Expected Performance (Metric)	Actual Performance Objective Met?
Qualitative	Safety and reliability	Operation of the technology, including hydrogen addition, can be performed safely. Technology gains regulatory acceptance.	Yes, with proper routine maintenance, an appropriate treatment, and regeneration cycles, the system is reliable. Technology is accepted by regulators.
	Maintenance	Requires routine maintenance (e.g., changing hydrogen cylinders and preparing bleach solution) for duration of demonstration	Yes, after developing standard operating procedures and modifying the reactor, two weekly visits were sufficient. With remote control, this might be reduced to one visit a week or two, depending on conditions. Implementation of a regular oxidative regeneration and cleaning schedule was required to maintain catalytic activity
	Ease of use	Routine operation does not require site operator.	No, on-site maintenance required biweekly operator visits.
Quantitative	Contaminant reduction	At least 99% TCE destruction	Yes, destruction was greater than 99% under normal operating conditions.
	Ability to meet regulatory standards	Final concentration of TCE is below 5 µg L ⁻¹ .	Yes, on average concentrations were below 5 µg L ⁻¹ during a 21 hr operating cycle.
	In situ operation	System is operated in situ with HFTW.	Was not accomplished due to technical challenges
	Robustness	Achieves contaminant reduction goals when TCE concentration is > 1 mg L ⁻¹	Influent concentrations ranged from 0.8 to 1.2 mg L ⁻¹ and system was still able to reduce concentrations to below MCL. Efficacy is sensitive to sulfide concentration (Lowry and Reinhard, 2000).
	By-product formation	MCLs are met for cis-DCE and VC	Yes, ethylene was the only end product.

3.2 SELECTION OF TEST SITE

Of the criteria identified as critical, the following were met at Edwards AFB:

- Presence of halogenated contaminants, e.g., TCE and/or PCE, which are amenable to Pd-catalyzed reductive dehalogenation.
- Absence of compounds that are recalcitrant to Pd-catalyzed dehalogenation.

- Shallow water table. Although the Pd/HFTW technology is applicable at sites where the water table is deep, a shallow water table is preferable for the purposes of the technology demonstration because the cost of well installation increases with well depth.
- Presence of at least two hydrogeologic layers of high conductivity, in which the screened sections of the HFTWs can be placed.
- Sufficient hydrogeologic anisotropy to promote groundwater recirculation using HFTWs.
- Site has access to electricity, water, and other required infrastructure.
- Preferably, site has been well characterized in terms of hydrogeology, water quality, and contaminant concentrations.
- Support from the site host and relevant regulatory agencies.

The following conditions were met marginally and resulted in significantly higher development and operational costs and delays:

- Very low concentrations of sulfide ion, which can poison the Pd catalyst. Complete absence of sulfide is preferable.
- Site location must be such that personnel can travel from Stanford to the demonstration site in a reasonably short time (i.e., less than one day).

The following conditions were not considered but resulted in major complications:

- The site was located in a flood plain causing near catastrophic damage during the winter storms of 2004-2005.
- The site was often not accessible because of weapons testing in the vicinity of the site causing many unproductive trips.
- For security reasons, access was restricted to American citizens, limiting collaboration of foreign students.

The following sites were evaluated as potential demonstration sites for this project: Moffett Federal Airfield (Mountain View, California), Beale AFB (Marysville, California), Travis AFB (Fairfax, California), and Edwards AFB (Lancaster, California). Edwards AFB was selected because the site was well characterized, infrastructure was already in place, and the site personnel and local regulators were supportive.

3.3 TEST SITE, FACILITY HISTORY, AND CHARACTERISTICS

Edwards AFB occupies about 470 square miles of high desert area, including all of Rogers and Rosamond dry lakes. The primary mission of the base has been aviation development through experimental and test flight activities. The base presently is operated by the U.S. Air Force Flight Test Center (AFFTC). The base is located about 80 miles northwest of Los Angeles. Site 19 is an open tract of approximately 100 acres situated east of Taxiway E and south of Taxiway D. The

site includes buildings 1928, 1931, and adjoining parking areas. These buildings and adjacent concrete pads were constructed in 1958 to house maintenance equipment and test racks for engines used in the X-15 rocket plane.

From 1958 through 1967, approximately one 55-gallon drum of TCE was used per month to clean X-15 rocket engine parts. After 1967, the facility was used for much smaller engines and the TCE use dropped substantially. Testing at the facility ended altogether in 1975. During testing, standard practice was to rinse the spent solvent from the test stands into maintenance shop drains that led to a concrete basin/holding pond. Wastewater that did not evaporate from the holding pond was periodically pumped and discharged into the desert south of Building 1931. Most of the wastewater was discharged through a steel pipe leading from the holding pond and terminating approximately 300 feet south.

An additional source of contamination may have resulted from substances disposed into a septic tank and leach field that serviced Building 1931. The septic tank was removed in 1984 but the drain field was left in the ground. The exact location of the leach field is unclear. Two other potential sources for contamination include the original storm water retention pond and the Drainage Area B channel. The original storm water retention pond was located west of the current pond, covering an area approximately 350 ft by 180 ft. Surface runoff from Drainage Area A, which currently flows into the existing pond, previously flowed into the former pond. The unlined drainage channel in the northern portion of the site (discharging onto Rogers Dry Lake) is the terminus for surface runoff from Drainage Area B. Potentially contaminated surface runoff from Drainage Area B may enter the soil, and subsequently the groundwater, along any portion of this unlined channel.

The area south of the buildings has not been developed, although the current storm water retention pond was constructed in the 1960s to prevent drainage from the paved areas west of Site 19 from reaching Rogers Dry Lake. The pond is approximately 1000 ft long, 400 ft wide, and less than 10 ft deep. Historical photographs from Base History Office, Edwards AFB, indicate that parts of Site 19 and parts of Rogers Dry Lake east of Site 19 were periodically flooded prior to construction of the current storm water retention pond in the 1960s. During wet seasons, excess water from the retention pond periodically overflows into low-lying areas north of the pond.

The first evidence of contamination at Site 19 was the detection of TCE in a water sample from a well upgradient of the storm water retention pond. The aquifer containing the TCE is not used as a potable or agricultural water supply near the site. However, base supply wells are withdrawing from similar alluvial materials approximately 3 miles south of the site. The plume has moved approximately 700 m (2,300 ft) from its origin 40 years ago. PCE has not been detected at Site 19 and could not be evaluated.

The demonstration site at Edwards AFB is approximately 400 m east of the storm water retention pond at Site 19. McCarty et al. (1998) and Gandhi et al. (2001) reported TCE concentrations of 1,100–1,400 $\mu\text{g L}^{-1}$ in the groundwater entering the demonstration site in the upper aquifer zone. Recent measurements elsewhere at Site 19 have shown TCE concentrations of 2,300 $\mu\text{g L}^{-1}$ in

shallow wells and $4,500 \mu\text{g L}^{-1}$ in deep wells (internal communication between Stanford University and Edwards AFB personnel).

Site 19 also contains parts of the main fuel transfer (pipeline) system that extends along Taxiway E. Fuel leakage from the pipeline occurred in the 1960s in the northwestern corner of Site 19, and an estimated 250,000 gallons of JP-4 jet fuel were released. Soil was excavated and approximately 100,000 gallons of fuel were recovered during remediation efforts. JP-4 jet fuel was last detected in 1992, and benzene was last detected in 1993.

3.4 PHYSICAL SETUP AND OPERATION

The reactor system was mounted on a skid platform and placed on the ground next to the treatment well. A trailer housing the pump controls systems for the pumps and the computer system, a storage supply and chemicals preparation room, and a small workshop were in the vicinity. Hydrogen tanks were stored next to the skid.

3.5 SAMPLING/MONITORING PROCEDURES

Sampling and analysis was automatic and performed with the Automated Sampling and Analysis Platform (ASAP) system, which was used at the Seal Beach demonstration and other similar projects. Only reactor influent and effluent were monitored.

3.6 ANALYTICAL PROCEDURES

Samples processed by the ASAP were analyzed for VOCs by gas chromatography (GC) and anions by direct reading ion chromatography (IC). In addition, during background sampling, samples were processed by specific ion probe for sulfide (see Appendix of Final Report). For sulfide analysis, a Hach kit was used. TCE was analyzed with a detection limit of approximately $1 \mu\text{g L}^{-1}$. Biogenic sulfide production within the reactor system was identified by the distinct sulfide odor in the effluent groundwater. The olfactory threshold for sulfide is 29 ng L^{-1} , much lower than analytical detection limits, making odor a more sensitive detection technique.

4.0 PERFORMANCE ASSESSMENT

4.1 CATALYTIC TCE REMOVAL: DATA AND INTERPRETATION

Figure 5 represents the data collected from mid-July through the end of November 2005. The gaps in data are due to an interruption in analytical data collection, reactor down time or power failure. Removals exceeded 99% during normal operating conditions and 99.5% immediately after a regeneration cycle. Elevated effluent TCE concentrations during bleaching/regeneration cycles are not seen because they are too short to appear on the timescale of Figure 5. Figure 6 shows the removal efficiency under normal operating conditions with influent concentrations generally ranging from 800 to 1,230 $\mu\text{g L}^{-1}$, with residual concentrations ranging from 0 to 10 $\mu\text{g L}^{-1}$ during operation cycles and higher during bleaching/regeneration cycles.

TCE spikes occur during maintenance bleach cycles and last for about 3 hrs. Long-term average removals are 99.6% outside bleaching and 95.5% if concentrations during the bleaching periods are included. Figure 6 focuses on the effluent TCE concentrations under standard conditions. There is a trend of increasing TCE concentrations after a bleach pulse and preceding the following bleach pulse. Experience has shown that the effectiveness of the short bleach pulsing decreases with time and long-term or overnight bleaching of the catalyst is then required to restore activity.

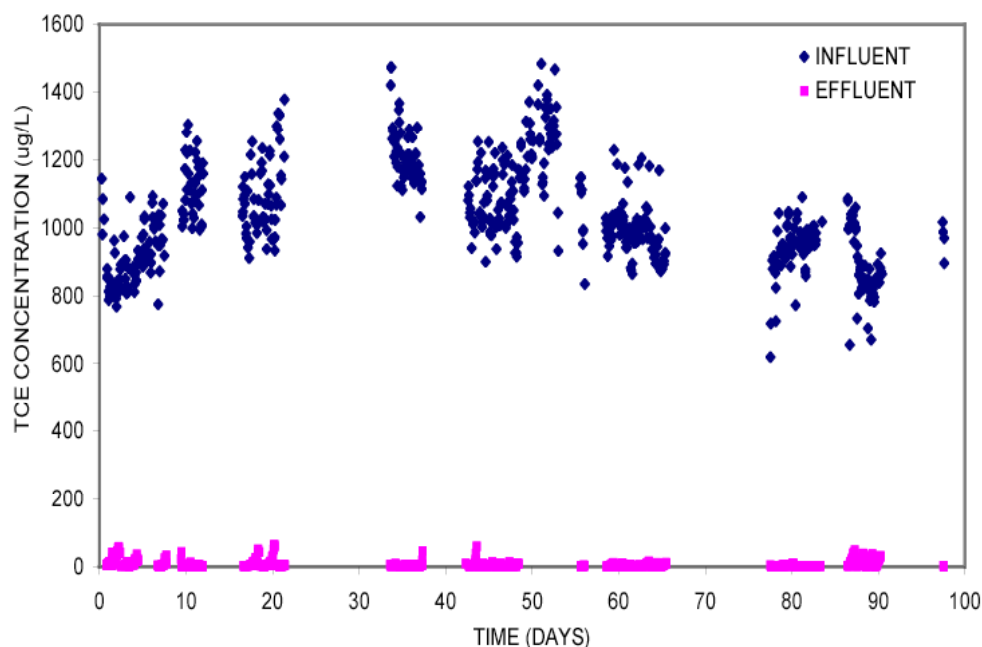

Figure 5. Performance of T1 Pd Catalyst Reactor July-September 2005.

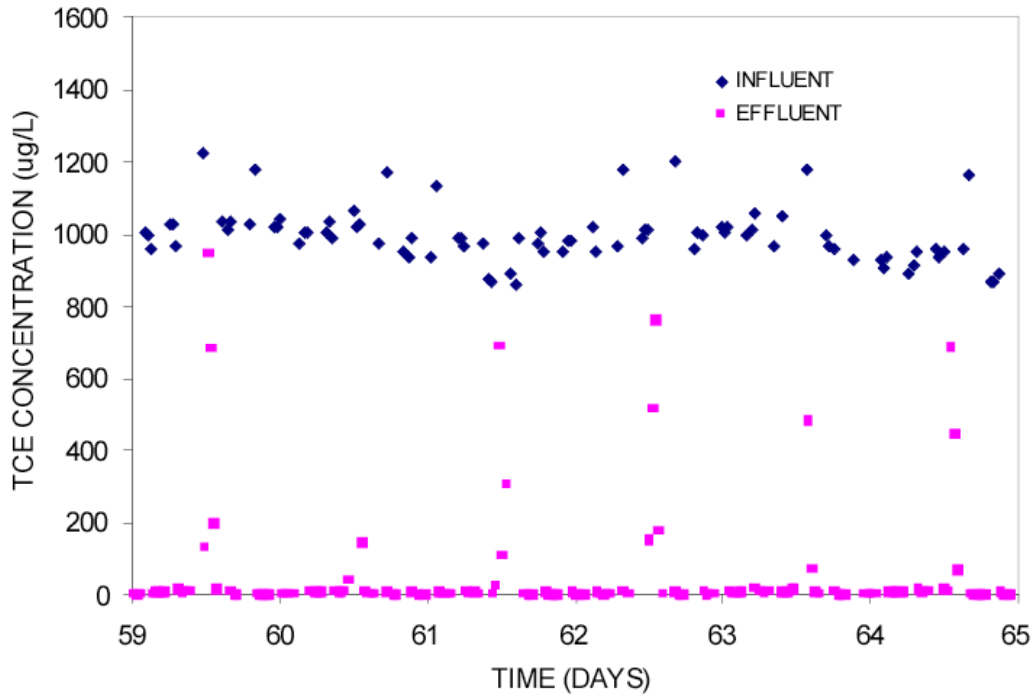

Figure 6. TCE Removal During One-Day Bleaching Regime.

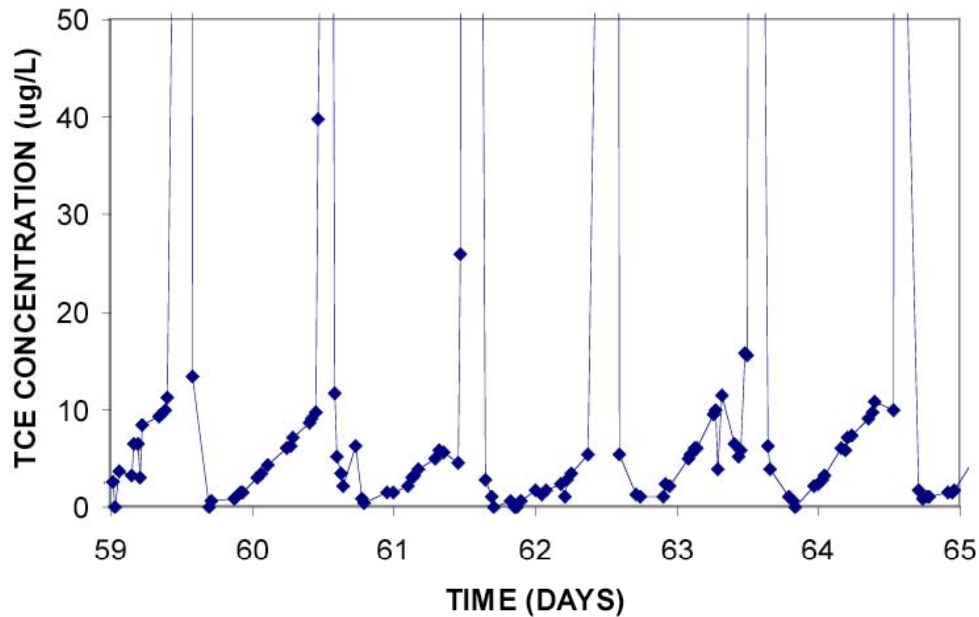

Figure 7. TCE Residual Concentration Detail Under One-Day Bleaching Regime.

Increasing the frequency of bleach cycles with shorter pulse durations of higher bleach concentrations was tried; unfortunately, this resulted in lower TCE reduction efficiencies, presumably from the shorter pulse durations, but did not decrease the concentrations of the resulting spike in TCE concentrations. Removal of the trace levels of sulfide by precipitation on

iron by adding a steel wool scrubber was also evaluated; although this worked, the steel wool dissolved in a relatively short time period.

4.2 PERFORMANCE CRITERIA AND DATA ASSESSMENT

Table 3 summarizes the expected and the actual performance of the process; Column 4 summarized the experience and data gained in this demonstration.

Table 3. Expected Performance and Performance Confirmation Results.

Performance Criteria	Expected Performance Metric (pre demo)	Performance Confirmation Method	Actual (post demo)
Qualitative Primary Criteria (Performance Objectives)			
Maintenance	Requires only routine maintenance (e.g., changing hydrogen cylinders) for duration of demonstration	-Experience during technology demonstration -Review of maintenance records	Operation with low maintenance level was possible with improved system design.
Ease of use	-Routine operation does not require an operator -Sample collection and changing hydrogen tanks can be performed by personnel with minimum training -System can be operated by personnel with Occupational Safety and Health Administration (OSHA) 24-hr or 40-hr Hazardous Waste Operations and Emergency Response (HazWOpER) training	-Experience during technology demonstration -Review of maintenance records.	Use was straightforward once standard operating procedures were in place.
Qualitative Primary Criteria (Performance Objectives)			
Contaminant reduction	At least 99% destruction of TCE and other applicable contaminants	Comparison of influent, effluent concentrations of Pd reactors	>99% removal; better than expected performance
Meeting regulatory standards	Final concentration of TCE is below MCL ($5 \mu\text{g L}^{-1}$)	Effluent concentration analysis	Effluent concentration below MCL when calculated as daily average (see comments).
By-product formation	MCLs met for cis-DCE ($6 \mu\text{g L}^{-1}$) and VC ($0.5 \mu\text{g L}^{-1}$)	Effluent concentration analysis	By-products below MCL
Robustness/flexibility		Effluent concentration histories	System failures result in hydrogen sulfide production.
Catalyst activity	Pd catalyst does not need replacement for at least 12 months, likely 5-10 years.	Catalyst was used for the entire project period, even though is was poisoned multiple times as a consequence of system failures.	Catalyst remained active for longer than 12 months could be regenerated after prolonged sulfide poisoning.

Table 3. Expected Performance and Performance Confirmation Results (continued)

Performance Criteria	Expected Performance Metric (pre demo)	Performance Confirmation Method	Actual (post demo)
Secondary Performance Criteria			
Operational safety	Hydrogen addition can be performed without acceptable safety hazard.	Hydrogen handled within safety margins	Hydrogen safety concerns need to be appropriately incorporated into the design of the system.
Versatility	Technology is applicable for a broad range of contaminants.	Laboratory studies testing other contaminants	Technology was tested for TCE only but is applicable for other chlorinated ethylenes.
Process waste	System operates in situ without generation of any secondary waste stream.	Experience during technology demonstration	The regenerant bleach solution was discharged to the treatment well. Future designs could easily incorporate neutralization step for bleach.
Factors affecting technology performance	Water quality, especially the presence of sulfidic compounds, is the most important determinant affecting technology performance.	Experience from this and other sites and laboratory experiments	The original single column design is not sufficient due to TCE spikes resulting from regeneration with bleach.

Comparing the actual with the expected performance indicates that the primary objectives of the destruction process were met. Significantly, it was possible to consistently achieve better than 99% TCE removal for 23 hrs a day and 1 hr catalyst regeneration. The regulatory limit of the effluent was met when concentrations were averaged over the 23-hr treatment cycle, during which concentrations increased from nearly zero to sometimes as high as $10 \mu\text{g L}^{-1}$, exceeding the MCL for approximately half the time.

These conclusions are based on a relatively small data set, however, because the system performed reliably only towards the end of the demonstration once the reactor was fully developed and the operating procedure was adapted to the site conditions. It is also important to notice that operating conditions had to be maintained within narrow margins. Failure to do so, e.g., missing a bleaching within the specified time intervals, resulted in catalyst poisoning and system upsets. Poisoning causes TCE breakthrough and requires aggressive bleaching for several days. The secondary criteria were met and do not limit application of the technology.

4.3 TECHNOLOGY COMPARISON

The treatment technology is most appropriately compared with air stripping and activated carbon adsorption. The principle advantages of Pd catalysis are that no by-products or emissions are produced except bleach solutions and that the technology has a smaller footprint. On the negative side, the technology requires much more sophisticated control mechanisms and detailed attentions to the safety concerns associated with the use of hydrogen. Additionally, Pd catalysis is compared with permeable reactive barriers that have been used for shallow groundwater contamination. A comprehensive efficacy and cost comparison is given in the next section.

5.0 COST ASSESSMENT

5.1 COST REPORTING

Table 4 shows the relevant costs that were tracked and documented during the demonstration in order to estimate with a high degree of veracity the capital and operational costs of the technology.

Table 4. Cost Elements.

Cost Category	Subcategory	Details
Start-up costs	Site characterization	Characterize the hydrogeology and contaminant distribution of the contaminated site
	Bench-scale tests	Optimize catalyst performance for specific site conditions
	Engineering design and modeling	Design well construction, placement of treatment/monitoring wells, etc.
Capital costs	Mobilization	1. Permitting, written plans 2. Clearing construction, utilities 3. Set-up of temporary facilities
	Pd catalyst for in-well reactors	Purchase commercially available Pd-on-alumina catalyst
	Reactor fabrication	Construction of two fixed-bed Pd reactors for installation in treatment wells
	Treatment well construction	Construct assembly for treatment wells, including reactors, controls, sampling ports, and safeties
	Treatment well installation	
	Monitoring well installation	
Operating costs: Direct environmental activity costs	Labor	Cost of an operator/technician to run the system not including labor costs associated with sampling, analysis, or maintenance, which are considered separately
	Consumable materials	1. Hydrogen gas 2. Catalyst replacement 3. Catalyst regenerant (e.g., hypochlorite)
	Maintenance and repairs	
	Utilities and fuel	Electricity, fuel, water
	Sampling and analysis	Sample collection by project personnel; sample analysis by project personnel or by commercial laboratory
	Long-term monitoring	Verification of remediation success
Operating costs: Indirect environmental activity costs	Environmental and safety training	Includes OSHA 24-hr or 40-hr HazWOpER training
	OSHA ambient environment sampling	Required for comparison with alternative technology
	Waste manifesting	Required for comparison with alternative technology
Operating costs: Demobilization	Site restoration	1. Removal of equipment and structures 2. Well closure/removal
	Decontamination	
	Personnel demobilization	
	Reporting	

5.2 COST ANALYSIS

Costs for Pd catalysis are compared with the costs of other baseline alternative technologies. The baseline alternative technologies chosen for this comparison are air stripping, GAC and PRBs. Pump-and-treat (P&T) technologies such as air stripping and GAC are the most commonly applied groundwater remediation methods. PRB is also referred to as “iron wall” or “iron curtain,” because zerovalent iron is almost always the catalytic material used. PRBs are often used for remediation of groundwater contaminated by chlorinated solvents. These technologies are compared in Table 5.

Table 5. Technologies for VOC Remediation.

Technology	PCE	TCE	DCE	VC	Destructive	Notes
Air stripping	•	•	•	•	No	<ul style="list-style-type: none"> - Ineffective at high concentrations - Generates waste stream - Deep aquifers increase well/pump cost
GAC	•	•			No	<ul style="list-style-type: none"> - Ineffective at high concentrations - Produces secondary waste stream - Deep aquifers increase well/pump cost
PRB	•	•	•	•	Yes	<ul style="list-style-type: none"> - Can also handle nitrate, nitrite - Only for shallow aquifers
Pd	•	•	•	•	Yes	<ul style="list-style-type: none"> - Can also handle nitrite - Faster kinetics than iron (Fe) - Applicable at high concentrations - Water quality affects performance - Deep aquifers increase well/pump cost

To compare costs for these three technologies, it is necessary to specify the operational conditions, such as the scale of the operation, the hydrogeologic setting, the contaminant concentrations and any other relevant site conditions. The values shown in Table 6 do not represent estimates of the conditions at Edwards AFB; rather, they are chosen to represent realistic values of a contaminated site, so that the Pd/HFTW technology can be compared to P&T and PRB technologies. The groundwater TCE concentration of 1 mg L⁻¹ is relatively average, as shown by the example field sites in Table 10. The acceptable endpoint of 5 µg L⁻¹ is the maximum contaminant level for TCE. Depth to water table will vary significantly by site, but 10 ft depth and 30 ft thickness is standard for a shallow aquifer, amenable to all technologies compared in Table 10. Other factors such as hydraulic gradient and conductivity are site specific, and the capture zone, maximum pump rate, inflation, and interest are selected during project design. As such, many of the assumptions are site- and project-specific, and those listed below represent only a starting point for new project design.

Table 6. Basis for Cost Comparison.

Factor Affecting Cost	Value
Contaminant concentrations	1 mg L ⁻¹ TCE
Acceptable endpoint	5 µg L ⁻¹ TCE
Depth to water table	10 ft below ground surface
Aquifer thickness	30 ft
Hydraulic gradient	0.0067
Hydraulic conductivity (average)	10 m d ⁻¹
Width of capture zone	600 ft
Maximum allowable pump rate through treatment wells	3.5 gpm
Annual inflation rate	5%
Annual interest rate	8%

Although budgeted, the Pd catalyst did not need frequent replacement and is expected to last for the life of the technology. Therefore, catalyst cost is to be a one-time capital investment for a typical groundwater remediation project. The reactor system is budgeted above using PVC instead of stainless steel. In the wake of this pilot study it was determined that stainless steel adds unnecessary expense. Capital and operational costs are shown in Tables 7 and 8.

Table 7. Capital Costs.

Cost Element	Cost	Subcost
Site Characterization	\$118,000	
Hydrogeological characterization		\$118,000
<i>Wells for estimating hydraulic head and gradient (7 wells @ \$10,000 each)</i>		\$70,000
<i>Pump tests to estimate hydraulic conductivity</i>		\$24,000
<i>Cores and analysis to estimate hydraulic conductivity</i>		\$24,000
Technology Mobilization, Setup, and Demobilization	\$59,000	
Transportation/delivery of equipments, facilities, and personnel		\$24,000
Setup of temporary facilities (e.g., trailer) and utilities		\$24,000
Demobilization		\$11,000
Planning and Preparation	\$155,000	
Engineering design and modeling		\$85,000
Permits and licenses, including water discharge		\$24,000
License fees associated with use of a technology		\$0
Regulatory interaction		\$6,000
Written plans		\$40,000
<i>Work plans</i>		\$12,000
<i>Sampling and analysis plans</i>		\$12,000
<i>Health and safety plans</i>		\$6,000
<i>Community relations plans</i>		\$5,000
<i>Site management plans</i>		\$5,000
Site Work	\$72,000	
Establishing physical infrastructure for technology application		\$18,000
Activities to restore site to prerediation conditions		\$18,000

Table 7. Capital Costs (continued).

Cost Element		Cost	Subcost
	Activities to meet specifications of site restoration plan		\$18,000
	Preparing specific site of the technology		\$18,000
	<i>Clearing and grubbing</i>		\$6,000
	<i>Earthwork</i>		\$6,000
	<i>Construction of utilities, etc.</i>		\$6,000
Installation of the Treatment System		\$134,000	
	Treatment wells (2 wells @ \$20,000 per well)		\$40,000
	Pumps (two pumps with 2 gpm flowrate @ \$5,000 per pump)		\$10,000
	Packet		\$5,000
	Assembly		\$2,000
	Monitoring wells (4 wells @ \$4,000 per well)		\$16,000
	Pd catalyst treatment system		\$61,000
	<i>Pd catalyst with eggshell coating (20 kg @ \$245 per lb)</i>		\$11,000
	<i>Skid-mounted reactor system and gas skid</i>		\$50,000
Startup and Testing		\$18,000	
	Establishment of operation conditions		\$6,000
	Shakedown		\$6,000
	Training of O&M personnel		\$6,000
Other Costs		\$18,000	
	Data processing and computer equipment		\$6,000
	Safety equipment		\$6,000
	Vehicles		\$6,000
	Miscellaneous		\$0
TOTAL CAPITAL COST		\$574,000	

Table 8. Operation and Maintenance Costs.

Cost Element		Cost	Subcost
Labor		\$35,000	
	Maintenance of technology and associated equipment		\$25,000
	Labor supervision (100 hrs @ \$50 per hr)		\$5,000
	Payroll expense (100 hrs @ \$50 per hr)		\$5,000
Materials		\$1,350	
	Pd catalyst		\$0
	Chemicals		\$1,350
	<i>Hydrogen gas (6 cyl @ \$50 per cyl and \$10 per month rental fee)</i>		\$720
	<i>Bleach (two columns, 2 gal per wk @ \$3 per gal)</i>		\$630
Utilities and Fuel		\$2,000	
	Fuel		\$500
	Electricity		\$1,000
	Water		\$500

Table 8. Operation and Maintenance Costs (continued).

Cost Element		Cost	Subcost
Equipment ownership, Rental or Lease		\$0	
	Equipment ownership		\$0
	Rental		\$0
	Lease		\$0
Other Costs		\$10,000	
	Repair/maintenance of office/administrative equipment		\$5,000
	Health and safety cost		\$5,000
	<i>Personal protective equipment</i>		\$2,000
	<i>Monitoring of personnel health and safety</i>		\$3,000
Total Operation and Maintenance Cost (Annually)		\$48,350	

Monitoring costs for a Pd/HFTW system are shown in Table 9. Early monitoring is monthly and bimonthly (years 1-3) in anticipation of operational issues that demand attention during start-up; monitoring in subsequent years is quarterly, reflecting the minimal attention needed once the reactor is operational and the early issues are resolved. A few important notes about the table are:

- The sampling frequency follows the shown schedule, and costs are based on the assumption of two monitoring wells and a cost of \$1,000 per well per round of sampling and analysis.
- Inflation was assumed 5% annually, with a discount rate of 8%.
- The cleanup time for the example site is estimated at 10 years, with a replacement cost of \$11,000 for pd catalyst included at the end of year 5.

Table 9. Monitoring Costs.

Year	Sample Frequency	Monitoring Cost	O&M Cost	Inflated O&M
1	Monthly	\$24,000	\$72,350	\$72,000
2	Bimonthly	\$12,000	\$60,350	\$63,000
3	Bimonthly	\$12,000	\$60,350	\$67,000
4	Quarterly	\$8,000	\$56,350	\$65,000
5	Quarterly	\$8,000	\$56,350	\$68,000
6	Quarterly	\$8,000	\$56,350	\$72,000
7	Quarterly	\$8,000	\$56,350	\$76,000
8	Quarterly	\$8,000	\$56,350	\$79,000
9	Quarterly	\$8,000	\$56,350	\$83,000
10	Quarterly	\$8,000	\$56,350	\$87,000
O&M cost, net present value (NPV)				\$482,000
Pd replacement cost ¹				\$11,000
Total O&M cost				\$493,000
Total O&M cost, NPV				\$493,000

¹ Assumes Pd catalyst is replaced every 5 years

The costs of the three technologies must be compared over their entire life cycles. This analysis is based on an NPV approach, using 5% annual inflation and 8% interest rates. The costs

considered are start-up costs, capital costs, O&M costs, and recurring regulatory or institutional oversight costs. Future liability is not considered for the PRB and the Pd/HFTW technologies because these destroy TCE rather than transferring it to a different medium. Future liability must be considered for evaluation of the P&T technology. The life-cycle period will commensurate with the time period required for each technology to treat the entire contaminant plume. Table 10 shows other pilot studies and field sites using alternative technologies. All costs are inflated to June 2006, and the adjusted total cost provides a basis for economic comparison of the competing technologies.

5.3 COST COMPARISON

Comparing various field sites where these technologies were implemented, Pd catalysis is cost competitive as an alternative treatment technology for VOC-contaminated groundwater. Table 10 details the cost comparison. Data for each project was extrapolated to an operation period of 10 years to provide consistent weighting for capital and operating costs.

Table 10. Examples of Cost Evaluations of Different Competing Technologies.

Technology	TCE (mg L ⁻¹)	Removal (%)	Cost per 1,000 gal treated ¹ (\$)
<i>Air Stripping</i>			
Gold Coast, FL ²	0.45	99	7
Des Moines, IA ²	0.045	96	1
<i>Granular Activated Carbon (GAC)</i>			
La Salle, IL ²	13.3	96	250
Old Mill, OH ²	6.1	75	336
Lawrence Livermore National Lab, CA ³	3.0	99	83
Commencement Bay, WA ²	0.13	98	10
<i>Permeable Reactive Barrier (PRB)</i>			
Moffett, CA ²	20	-- ⁴	547
Intersil, CA ²	13	98	228
<i>Palladium Reductive Catalysis</i>			
Edwards AFB, CA	1	99.6	8
	10	99.9	9 ⁵

¹ All costs amortized for 10-years operation

² Data taken from EPA Report no. 542-R-99-006 (127 EPA 1999)

³ Data taken from McNab et al. (41 McNab,W.W. 2000)

⁴ Data not given

⁵ Estimated using the economic model for Edwards AFB (2007)

The normalized costs (\$ per 1,000 gal) were calculated by dividing the total NPVs of capital and O&M costs by the total number of gallons treated during the 10-year project period. At \$8 per 1,000 gal, catalytic technology is cost competitive with GAC and PRB at all field sites listed. Air stripping is more cost effective at low TCE concentrations, but if TCE is present at or above 1 mg L⁻¹, Pd catalysis becomes much more competitive. An estimated cost for remediation of 10 mg L⁻¹ TCE to the MCL of 5 µg L⁻¹ was generated using the economic model developed during this project. As shown, the total cost increased only by \$1 per 1,000 gal treated because the capital costs are relatively nominal when compared with the O&M costs. There are many

compounds, including DCE and VC, that only adsorb weakly on GAC and thus Pd catalysis offers a significant improvement in remediation methods. GAC is not economically viable at elevated contaminant concentrations, as seen in Table 10, because the carbon must be replaced or regenerated frequently. If the groundwater is contaminated with multiple chlorinated solvents, GAC and air stripping will increase significantly in price as they become saturated much more quickly. Pd catalysis can handle multiple contaminants, especially chlorinated ethylenes, and elevated concentrations in a single pass, offering a distinct advantage over other technologies.

Given that PRBs need little to no maintenance, the technology costs in Table 10 may appear elevated. However, it is important to note that PRBs operate with very slow groundwater velocities at higher capital costs and relatively equal operating costs when compared with P&T technologies. Pd catalysis can be used to treat high volumes of water at controllable rates, but PRBs are constrained by groundwater flow rates and the permeability of the reactive wall. Thus, actual treatment costs are not as cheap as one might expect from a relatively passive treatment technology.

5.4 LIFE-CYCLE ANALYSIS

For full-scale implementation of Pd catalysis, the life-cycle costs are dependent primarily on the project duration and establishing an effective maintenance schedule. By operating a Pd reactor for a longer period of time, the capital costs including the catalyst, pumps, and associated plumbing are amortized at a lower rate, thereby lowering overall costs. Another important cost factor is effective maintenance of the catalyst and reactor (mainly periodic disinfection), which maintains high catalyst activity and long-term TCE removal, possibly beyond the 5-year budgeted catalyst lifetime.

Operational costs are relatively low given the amount of TCE destroyed in the process—having sufficient maintenance personnel time allocated to bleaching and periodic grab sampling ensures that the system is effectively collecting and treating the contaminated groundwater. The frequency of grab sampling could decrease over time if the system has consistent TCE removal during the start-up months but would likely depend on the requirements of the overseeing regulatory agency.

Table 11 presents the life-cycle costs for implementing Pd catalysis at a site contaminated with 1 mg L⁻¹ TCE. For an operational period of 5 years, the total cost of building and operating a catalytic Pd reactor would be \$840,000. If operated for 10 years, assuming Pd replacement after year 5, the total cost is \$1,065,000.

Table 11. Present Value Estimates Pd Reactor Operation.

Element	NPV
Capital investment	\$572,000
Pd replacement after 5 years	\$11,000
Annual O&M cost	\$48,000
Annual monitoring cost	\$70,000
Present value over 5 years	\$840,000
Present value over 10 years	\$1,065,000

6.0 IMPLEMENTATION ISSUES

6.1 COST OBSERVATIONS WITH THE DEMONSTRATION SYSTEM

The key factors that affected project costs included (1) debugging the control system, (2) redesigning and rebuilding the reactor, (3) developing a site-specific operating protocol, (4) developing a detailed understanding of the poisoning process, (5) flooding of the site, (6) travel to the site, (7) extreme variations in temperature, and (8) interlocking of hydrogen system and treatment system in areas that were not needed. Costs that could be avoided in a follow up demonstration are costs for stainless steel reactors and hollow fiber hydrogen feed modules. The most important parameter affecting the costs of operating the technology is monitoring frequency and the impact of water quality on the bleaching schedule. For instance, anaerobic conditions require more frequent bleaching and therefore reduce the throughput. Significantly, the catalyst turned out to be nearly indestructible and not a cost factor. With proper maintenance, the catalyst lifetime may last for the duration of a project. The reactor should be developed with a robust control and communication system, and reliable bleaching and hydrogen feed systems; and it should be procured with operational guarantees.

6.2 PERFORMANCE OBSERVATIONS

Although the site water had a high tendency to turn sulfidic, we were able to meet treatment goals. Operation in conjunction with the HFTW was not possible due to the long and difficult start-up phase. Subsurface operation of the reactors (originally planned) would have added costs to the operation that seem out of proportion to the benefits gained.

6.3 SCALE-UP

The demonstration-scale was perhaps two to four times smaller than an expected a full-scale application at this site. At many sites, water flow may be limited by the capacity of the well to produce water. We recommend extensive testing of a system of this size system before significant upscaling is attempted and systems with multiple treatment pairs are attempted.

6.4 OTHER SIGNIFICANT OBSERVATIONS

Significant benefits can be gained by implementing this technology. For typical sites the demonstration size was appropriate and cost estimates relatively accurate. Implementation requires a willingness to comply with the safety precautions for using hydrogen, which is not common knowledge for most environmental engineering firms.

6.5 LESSONS LEARNED

Overall, the Edwards AFB demonstration project showed that reductive catalytic destruction of TCE is an efficient technology ready for field implementation, provided the lessons learned from this project are applied to future sites. The capability of the technology to handle high TCE concentrations makes it very attractive for source control at many DoD and commercial contaminated groundwater sites. This memorandum identifies and explains the major technical, regulatory, and management aspects that must be considered in applying catalytic groundwater treatment at other field sites.

6.5.1 In Situ Versus Ex Situ

The Edwards AFB demonstration project was planned and designed to operate in situ by installing the reactors inside 6-inch diameter treatment wells, but was only tested ex situ, i.e., with the reactors and the associated plumbing and instrumentation mounted above grade on a rig accessible for maintenance. Mounting the reactor column inside the treatment wells (i.e., operating in situ) would result in higher maintenance costs since lifting the reactors from the wells would require a crane. The reasons to operate this technology in situ are:

- Regulatory compliance
- Site footprint requirements.

For the Edwards AFB demonstration project, the regulatory requirement that the treated water was not to be reinjected into the subsurface was waived, allowing evaluation of the technology above in ex situ mode. Considering that the technology is still relatively immature, it is recommended that the technology be operated ex situ until all reliability issues are resolved, which will require regulatory approval.

At military and industrial sites, it is not expected that the footprint will be of concern as open space is ample and the footprint of an ex situ system is still relatively small. In urban settings or locations where an extremely small footprint is required, operating in situ will reduce the visible footprint of the site.

6.5.2 Site Selection

Applicability of catalytic technology is determined by two criteria:

- (1) Target contaminant reactivity and site water concentration
- (2) Site water quality.

While this demonstration examined groundwater contaminated with TCE, the technology is also applicable to other contaminated aqueous streams such as wastewater, industrial effluent and drinking water as long as water quality does not significantly hinder the catalytic process. For contaminants that are less reactive than TCE and other chlorinated ethylenes, reactors would need to be larger than that used at Edwards AFB, increasing the cost.

Site water quality can significantly impact the efficacy of Pd-catalyzed contaminant reactivity. The most significant groundwater matrix species is sulfide, which is believed to poison Pd catalyst at any concentration, even at or below the odor threshold of $\sim 29 \text{ ng L}^{-1}$. From a practical standpoint, the technology should not be implemented where sulfide is detectable by odor or any other method. Similarly, if sulfide odor is noticed in the reactor effluent but not in the influent, sulfide is biogenically produced within the reactor, indicating the need for bleaching. There was no oxygen in the Edwards AFB groundwater. In laboratory experiments it was shown that dissolved oxygen impacts the process by consuming hydrogen; TCE conversion was reduced from 46.0% to 13.4% by adding 450 μM oxygen to the influent water (oxygen was 67% converted) (Lowry and Reinhard, 2001). However, these impacts are relatively insignificant and can be overcome increasing the reactor size and adding excess hydrogen. Overall, the presence of oxygen is beneficial because it inhibits sulfide formation.

Sulfate itself does not affect catalyst performance because it is not reduced by Pd and hydrogen, but in the presence of hydrogen and sulfate-reducing bacteria, it is readily converted to sulfide, which poisons the catalyst. The ideal site for Pd-catalyzed reduction of a target contaminant would have a very reactive contaminant (e.g., TCE) and a low concentration of oxygen to inhibit sulfide formation. Overall, anoxic sites such as the Edwards AFB site with no oxygen but some nitrate are suited for the application Pd catalysis.

6.5.3 System Design, Fabrication, and Procurement

As each field site has different groundwater contaminant and matrix conditions, sites must be evaluated on a case-by-case basis. Once groundwater hydrogeology is understood and contaminant removal levels are established, system sizing and detailed design can follow these simple guidelines:

- Systems should be sized based on the optimal design of horizontal flow treatment wells and the hydrogeological conditions.
- Components should be extensively tested at the factory under realistic treatment conditions.
- Delivery should be considered complete only after *on-site* testing.
- Systems should be equipped for remote control.
- For remote systems, local maintenance support should be available on an as-needed basis.

Sizing of the system depends on the overall treatment needs and the design of the water extraction and re-injection system. Hydraulic loading several times of that tested at the Edwards AFB site should be possible. Scaling to lower flows is also possible.

Component testing requires operating the system with similar groundwater (i.e., similar pH and matrix species). The desired flow rate should be verified and tested for pump and pipe sizing verification. Extreme temperatures should be considered if they will be encountered on site.

Requiring *on-site* testing of the system is essential to ensure hydraulic performance on-site is commensurate with that in the lab. Flow control and valve systems must be checked with the integration of automated sampling and analysis mechanical equipment. Also, training of on-site personnel is essential to minimize operation and maintenance costs. Remote control of the system should be tested to ensure technical feasibility of remote operation.

Finally, post-delivery support must be local. System downtime increases significantly when support is distant and/or nonresponsive.

6.5.4 Project Management

Managing a demonstration or full-scale field site using catalytic reductive technology requires trained management and operations personnel and well-designed operational and safety plans. The recommended approach is to develop a project management structure as follows:

- Implement a phased approach to all tasks with discrete goals for each phase.
- Scrutinize the interdependencies of each task and allow slack for adjustments.

The phased approach creates a much longer anticipated timeline but better addresses the needs encountered in the field. Having discrete goals focuses efforts on the task at hand and results in achievable deliverables. Scrutiny of the interdependencies of each task is important because delays in one task will inevitably impact all related tasks. For example, the technology should be contemplated for use only at well-characterized sites.

If the system is to be operated remotely, it is important to have an operational plan that details the interaction between remote operators and site personnel—especially during emergencies, periods of system malfunction, or maintenance.

6.6 END-USER ISSUES

To consider implementing the technology, potential end users need access to relevant expertise technology, which at this point is not yet widely available.

6.7 APPROACH TO REGULATORY COMPLIANCE AND ACCEPTANCE

Regulatory acceptance should not be a problem.

7.0 REFERENCES

Air Force Institute of Technology, <http://en.afit.af.mil/env/insitubio.htm>.

Baker, E.G., L.J. Sealock, R.S. Butner, D.C. Elliott, G.G. Neuenschwander, and N.G. Banns. 1989. *Catalytic destruction of hazardous organics in aqueous wastes: Continuous reactor system experiments*. Hazardous Waste and Hazardous Materials, vol. 6(1), pp. 87–94.

California Department of Health Services. 2001.
<http://www.dhs.ca.gov/ps/ddwem/chemicals/PHGs/TCEMCLreport12-01.pdf>.

Christ, J.A., M.N. Goltz, and J. Huang. 1999. *Development and application of an analytical model to aid design and implementation of in situ remediation technologies*. Journal of Contaminant Hydrology, vol. 37, pp. 295–317.

Cunningham, J.A., T.P. Hoelen, G.D. Hopkins, C.A. Lebron, and M. Reinhard. 2006. *Bioremediation of cis-DCE at a sulfidogenic site by amendment with propionate*. Groundwater Monitoring & Remediation, in press 26, (2006).

Dean, John A. 1952. *Lange's Handbook of Chemistry*. McGraw-Hill, Inc., New York.

Ferland, D.R., K.G. Boggs, S. Niekamp, J.A. Christ, A. Agrawal, and M.N. Goltz. 2000. *Chlorinated hydrocarbon treatment using a horizontal flow treatment well system*. Remediation of Chlorinated and Recalcitrant Compounds: Physical and Thermal Technologies. G.B. Wickramanayake and A.R. Gavaskar, editors. Battelle Press, Columbus, Ohio, vol. C2-5, pp. 253–260.

Ferland, D.R., and M.N. Goltz. 2000. *Modeling an innovative technology to remediate chlorinated-solvent-contaminated groundwater*. Military Engineer, in review.

Gandhi, R.K., G.D. Hopkins, M.N. Goltz, S.M. Gorelick, and P.L. McCarty. 2001. *Full-scale demonstration of in situ cometabolic biodegradation of trichloroethylene in groundwater, 1: Dynamics of a recirculating well system*. Water Resources Research, in review.

Kalnes, T.N., and R.B. James. 1988. *Hydrogenation and recycle of organic waste streams*. Environmental Progress, vol. 7(3), pp. 185–191.

Kovenklioglu, S., Z. Cao, D. Shah, R.J. Farrauto, and E.N. Balko. 1992. *Direct catalytic hydrodechlorination of toxic organics in wastewater*. American Institute of Chemical Engineers Journal, vol. 38(7), pp. 1003–1012.

Lowry, G., and M. Reinhard. 1999. *Hydrodehalogenation of 1- to 3-Carbon Halogenated Organic Compounds in Water Using a Palladium Catalyst and Hydrogen Gas*. Environmental Science & Technology, vol. 33(11), pp. 1905–1910.

- Lowry, G., and M. Reinhard. 2000. *Pd-catalyzed TCE dechlorination in groundwater: Solute effects, biological control, and oxidative catalyst regeneration*. Environmental Science & Technology, vol. 34(15), pp. 3217–3223.
- McCarty, P.L, M.N. Goltz, G.D. Hopkins, M.E. Dolan, J.P. Allan, B.T. Kawakami, and T.J. Carrothers. 1998. *Full-scale evaluation of in situ cometabolic degradation of trichloroethylene in groundwater through toluene injection*. Environmental Science & Technology, vol. 32(1), pp. 88–100.
- McNab, Jr., W.W., R. Ruiz, and M. Reinhard. 2000. *In-situ destruction of chlorinated hydrocarbons in groundwater using catalytic reductive dehalogenation in a reactive well: Testing and operational experiences*. Environmental Science & Technology, vol. 34(1), pp. 149–153.
- Munakata, N. 2005. *Palladium Catalyzed Hydrodechlorination for the Treatment of Groundwaters: Sulfide Deactivation Model, Regenerant Comparison, and Chemical Surface Changes*. PhD Thesis, Department of Civil and Environmental Engineering, Stanford, CA.
- Rylander, P.N. 1973. *Organic Syntheses with Noble Metal Catalysts*. Academic Press, New York.
- Schreier, C.G., and M. Reinhard. 1995. *Catalytic Hydrodehalogenation of Chlorinated Ethylenes Using Palladium and Hydrogen for the Treatment of Contaminated Water*. Chemosphere, vol. 31(6), pp. 3475–3487.
- Siantar, D.P., C.G. Schreier, C.-S. Chou, and M. Reinhard. 1996. *Treatment of 1,2-Dibromo-3-Chloropropane and Nitrate-Contaminated Water with Zero-Valent Iron or Hydrogen/Palladium Catalysts*. Water Research, vol. 30, pp. 2315–2322.
- United States Environmental Protection Agency. 1997. *Clean Up the Nation's Waste Sites: Markets and Technology Trends, 1996 Edition*. EPA 542-R-96-005, April 1997.

APPENDIX A

POINTS OF CONTACT

Point of Contact	Address	Phone/Fax/E-mail	Role in Project
Carmen LeBron	Naval Facilities Engineering Service Center Restoration Development Branch 1100 23rd Avenue, ESC-411 Port Hueneme, CA 93043	Phone: 805-982-1616 Fax: 805-982-4304 Carmen.lebron@navy.mil	Project Manager
Martin Reinhard	Stanford University Department of Civil and Environmental Engineering. Stanford, CA 94305-4020	Phone: 650-723-0308 Fax: 650-723-7058 reinhard@cive.stanford.edu	Principal Investigator
Mary Spencer	Edwards Air Force Base Chief, Environmental Management Restoration Branch AFFTC/EMR 5 East Popson Avenue Building 2650A Edwards AFB, CA 93524	Phone: 661-277-1466 Fax: 661-277-6145 mary.spencer@edwards.af.mil	Site Host
Richard Russell	U.S. Environmental Protection Agency Region 9, SFD-8-1 75 Hawthorne Street San Francisco, CA 94105	Phone: 415-744-2406 russell.richard@epa.gov	Remedial Program Manager (RPM)
Elizabeth Lafferty	Regional Water Quality Control Board Lahontan Region 6V, Victorville Office 15428 Civic Center Drive Suite 100 Victorville, CA 92392	Phone: 760-241-6583	Remedial Program Manager (RPM)
John O'Kane	Department of Toxic Substances Control 8800 Cal Center Drive Sacramento, CA 95826		Remedial Program Manager (RPM)
Bob Wood	Edwards Air Force Base Chief, Environmental Restoration Division AFFTC/EMR 5 East Popson Avenue Building 2650A Edwards AFB, CA 93524-1130	Phone: 661-277-1407 Fax: 661-277-6145 robert.wood@edwards.af.mil	Remedial Program Manager (RPM)
Dorothy Coughlin	Computer Sciences Corporation Flight Test Support Center P.O. Box 446 Edwards AFB, CA 93523-0446	Phone: 661-277-9203 Fax: 661-277-1527 dorothy.coughlin@edwards.af.mil	Community Relations

Point of Contact	Address	Phone/Fax/E-mail	Role in Project
Roberto Ruiz	Lawrence Livermore National Laboratory 7000 East Avenue, L-530 Livermore, CA 94550	Phone: 925-422-0061 Fax: 925-422-9203 mcnabl@llnl.gov	Reactor design
Mark Goltz	Air Force Institute of Technology Department of Engineering and Environmental Management 2950 P Street, Building 640 Wright-Patterson AFB, OH 45433-7765	Phone: 937-255-6565 Fax: 937-656-4699 mgoltz@afit.af.mil	Model development
Jeffrey Cunningham	Jeff Cunningham, Assistant Professor Department of Civil and Environmental Engineering University of South Florida 4202 E. Fowler Avenue, ENB 118 Tampa, FL 33620	Phone: 813-974-9540 Fax: 813-974-2957 cunning@eng.usf.edu http://www.eng.usf.edu/~cunning	Workplan Development
Gary Hopkins	Stanford University Department of Civil and Environmental Engineering Stanford, CA 94305-4020	Phone: 408-262-2070 FAX: 408-263-8931 hopkins@cive.stanford.edu	Site Construction, Site Management, Safety Officer



ESTCP Program Office

901 North Stuart Street
Suite 303
Arlington, Virginia 22203
(703) 696-2117 (Phone)
(703) 696-2114 (Fax)
e-mail: estcp@estcp.org
www.estcp.org