

# REPORT DOCUMENTATION PAGE

Form Approved  
OMB No. 0704-0188

Public reporting burden for this collection of information is estimated to average 1 hour per response, including the time for reviewing instructions, searching existing data sources, gathering and maintaining the data needed, and completing and reviewing this collection of information. Send comments regarding this burden estimate or any other aspect of this collection of information, including suggestions for reducing this burden to Department of Defense, Washington Headquarters Services, Directorate for Information Operations and Reports (0704-0188), 1215 Jefferson Davis Highway, Suite 1204, Arlington, VA 22202-4302. Respondents should be aware that notwithstanding any other provision of law, no person shall be subject to any penalty for failing to comply with a collection of information if it does not display a currently valid OMB control number. **PLEASE DO NOT RETURN YOUR FORM TO THE ABOVE ADDRESS.**

<b>1. REPORT DATE (DD-MM-YYYY)</b> April 2012		<b>2. REPORT TYPE</b> Viewgraph		<b>3. DATES COVERED (From - To)</b> April 2012- June 2012	
<b>4. TITLE AND SUBTITLE</b> Numerical Simulation of Confined Multiple Transverse Jets				<b>5a. CONTRACT NUMBER</b> In-House	
				<b>5b. GRANT NUMBER</b>	
				<b>5c. PROGRAM ELEMENT NUMBER</b>	
<b>6. AUTHOR(S)</b> F. Davoudzadeh, D. Forliti, A. Lee, H. Vu				<b>5d. PROJECT NUMBER</b>	
				<b>5e. TASK NUMBER</b>	
				<b>5f. WORK UNIT NUMBER</b> 33SP0795	
<b>7. PERFORMING ORGANIZATION NAME(S) AND ADDRESS(ES)</b> Air Force Research Laboratory (AFMC) AFRL/RQRC 10 E. Saturn Blvd. Edwards AFB CA 93524-7680				<b>8. PERFORMING ORGANIZATION REPORT NO.</b>	
<b>9. SPONSORING / MONITORING AGENCY NAME(S) AND ADDRESS(ES)</b> Air Force Research Laboratory (AFMC) AFRL/RQR 5 Pollux Drive Edwards AFB CA 93524-7048				<b>10. SPONSOR/MONITOR'S ACRONYM(S)</b>	
				<b>11. SPONSOR/MONITOR'S REPORT NUMBER(S)</b> AFRL-RZ-ED-VG-2012-221	
<b>12. DISTRIBUTION / AVAILABILITY STATEMENT</b> Distribution A: Approved for Public Release; Distribution Unlimited. PA#12471					
<b>13. SUPPLEMENTARY NOTES</b> Conference paper for the 2012 AIAA Fluids conference, New Orleans, Louisiana in 25 June 2012.					
<b>14. ABSTRACT</b> Behavior of unconfined transverse jets has been studied extensively, but little work is reported on the flow characteristics of confined transverse jets. The latter has been numerically investigated using a number of RANS codes. The computational results obtained from these codes have been evaluated against the existing experimental data, and the results of a Large-Eddy Simulations (LES) code reported in the literature. Furthermore, an extensive validation effort has been conducted to characterize the performance of the codes for predicting the flow within a propulsion-related mixing configuration. The validation case involves eight circumferentially spaced transverse jets issuing radially into an axisymmetric main flow, a configuration relevant for gas turbine burners and new liquid rocket engine preburners. The main flow Reynolds number was $1.7 \times 10^5$ and the jet-to-main flow momentum flux ratio was sixteen. The momentum and scalar mixing was investigated through the solution of the Reynolds-Averaged Navier Stokes (RANS) equations. The solutions of three commercial RANS solvers, Fluent, STAR-CCM+, and CFD++, are compared to experimental data and large-eddy simulation (LES) results available in literature. Due to demonstrated periodicity, only a one-eighth pie-shaped section of the geometry was considered. The different commercial codes used the same geometry, grid, boundary conditions, and variations of the $k-\epsilon$ turbulence model. The LES results obtained from literature used a different grid, but the same geometry. All numerical simulations using the above mentioned codes capture salient flow structures such as the counter-rotating vortex pair (CRVP). Experimental data used for validation of the codes include mean axial velocity and jet fluid mixture fraction profiles (at three distinct axial locations), jet trajectory, turbulent kinetic energy distributions, and velocity and mixture fraction cross-plane distributions. All CFD results except CFD++, exhibit symmetrical solutions about the center plane. The current investigation shows that although all codes considered predict the experimental data with various degrees of accuracy, Fluent using the standard $k-\epsilon$ turbulence model with the standard $\mu$ function, and LES results compare exceptionally well with the experimental data for this flow regime and configuration.					
<b>15. SUBJECT TERMS</b>					
<b>16. SECURITY CLASSIFICATION OF:</b>			<b>17. LIMITATION OF ABSTRACT</b>	<b>18. NUMBER OF PAGES</b>	<b>19a. NAME OF RESPONSIBLE PERSON</b> Nils Sedano
<b>a. REPORT</b> Unclassified	<b>b. ABSTRACT</b> Unclassified	<b>c. THIS PAGE</b> Unclassified			<b>19b. TELEPHONE NO</b> (include area code) 661-275-5972



## NUMERICAL SIMULATION OF CONFINED MULTIPLE TRANSVERSE JETS

*25 June 2012*

*Presented to: AIAA Fluids Meeting, New Orleans, Louisiana*

Farhad Davoudzadeh, Ph.D. – Air Force Research Laboratory

David Forliti, Ph.D. - Jackson and Tull, LLC

Anh-Tuan Le, Ph.D. & Henry Vu, Ph.D. - Advatech Pacific, Inc.

Distribution A: Approved for public release; distribution unlimited



# Outline:



- ❑ **Objectives**
- ❑ **Jet in Crossflow characteristics**
- ❑ **CFD Validation Case and the experimental data**
- ❑ **Geometry, Grid, and the Boundary Conditions**
- ❑ **Comparative Analysis Results**
- ❑ **Summary**



# Objectives:



## □ Primary Objectives:

- Investigate mixing characteristics of propellants in preburners
- CFD support for the in-house Themis project

## □ Secondary Objective:

- Validate commercial CFD codes—Fluent, CFD++, and Star-ccm++ against experimental data and an LES results
- Provide numerical data for theoretical developments



# Staged Combustion Cycle Rocket Engine:

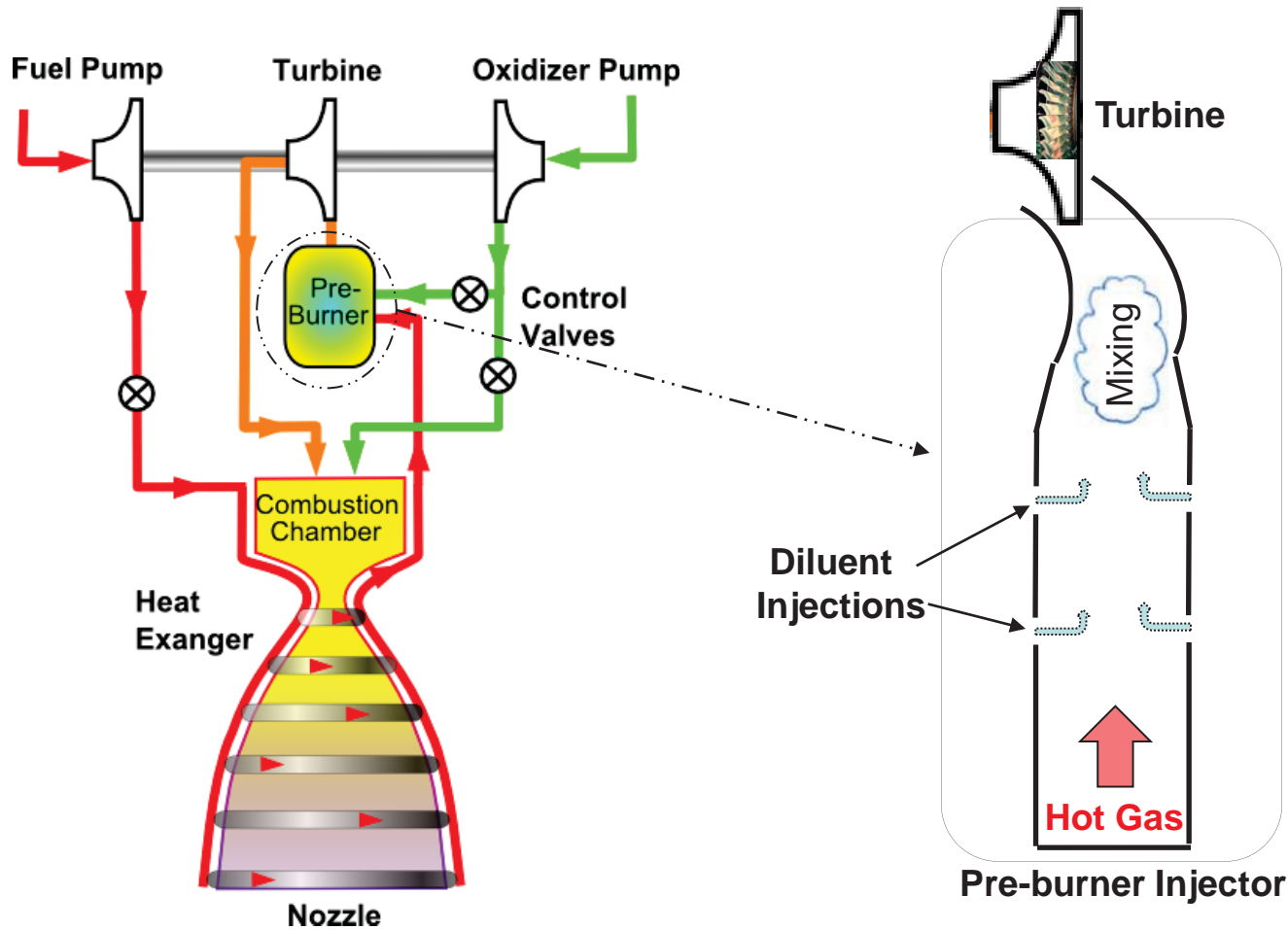

Staged Combustion cycle



Temperature Distribution On the Turbine Blades



# Jet in Cross Flow Characteristics



**Complex flow with multiple engineering applications:**

- Liquid rocket engine pre-burner
- Gas turbine combustors
- Film cooling of turbine blades
- Air pollution
- Chimney emissions
- Industrial burners
- Chemical mixing
- Wastewater discharges

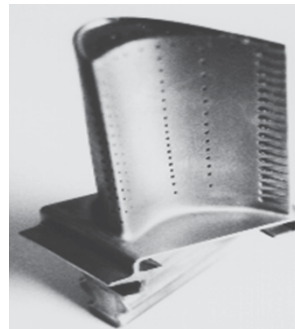



# Jet in Cross Flow Characteristics

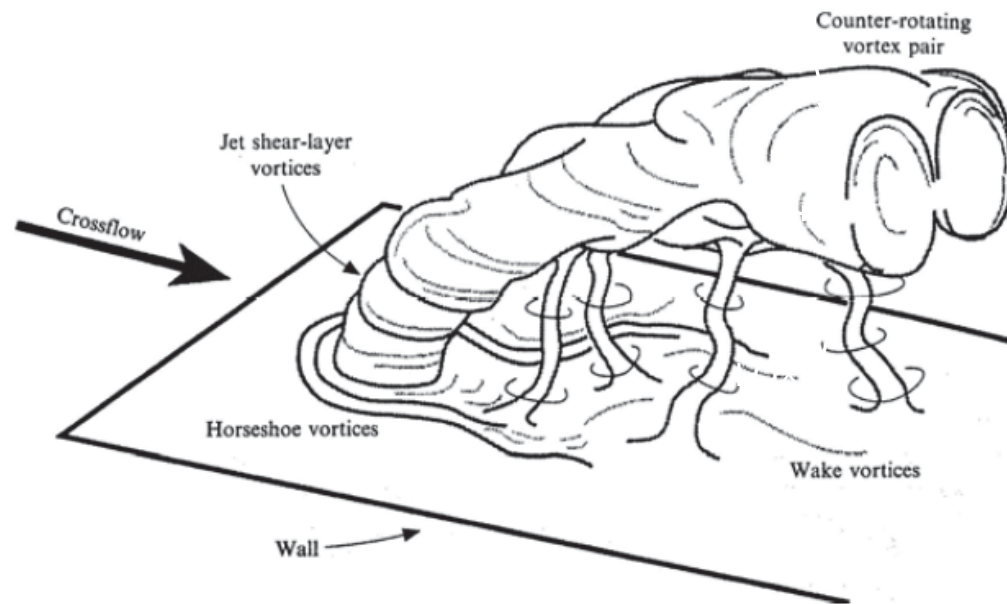

*Adapted from Fric and Roshko (1994)*



# Project Themis:



- ❑ In-house combustion device research within the Liquid Rocket Engines Branch (LREs) of AFRL
  
- ❑ Focuses on investigation of LOX/Hydrocarbon high pressure combustion devices through:
  - Theory development
  - Modeling and simulation
  - Subscale experimentation at reacting and inert conditions:
    - Design & test a 10k lbf pre-burner for liquid propellants
      - ▶ Requires good mixing of variable density propellants
      - ▶ Temperature uniformity
      - ▶ Concentration uniformity

Jet in  
Crossflow





# CFD Validation Case



Conduct a validation study for a baseline case:

- Experimental data available
- Unity density ratio
- Multiple confined transverse jets
- Single phase/component

## ONERA experimental/LES studies of an eight jet mixing chamber

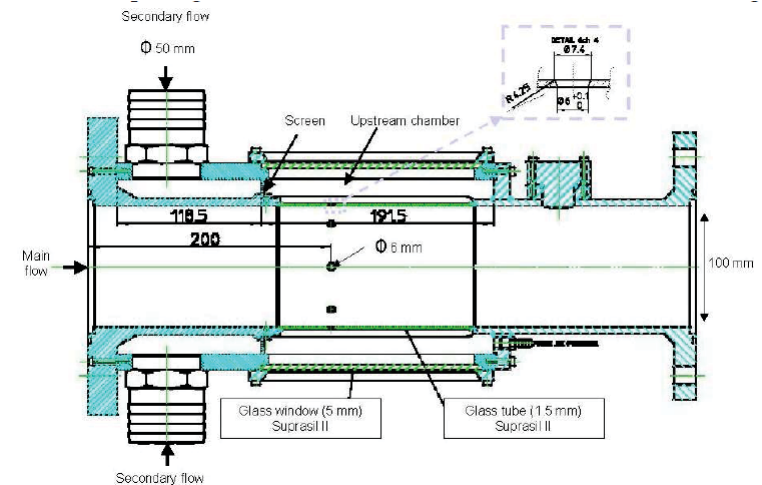
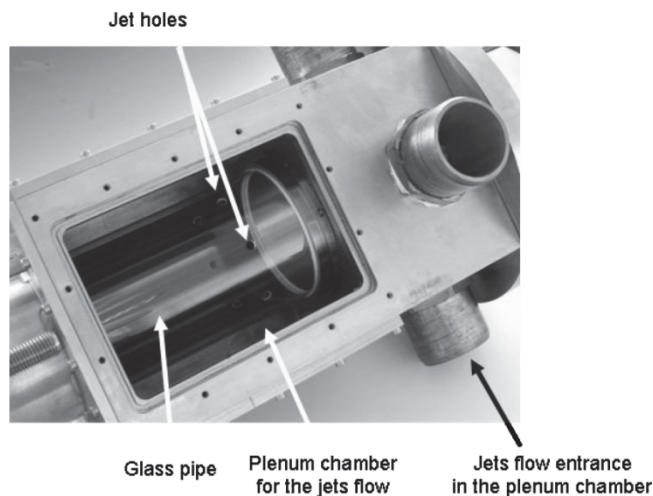



# ONERA Experiments



## Pros:

- PIV and PLIF data
- Characterized boundary conditions

## Cons:

- ONERA unable to share unpublished data
- Limited flow conditions (two cases)
- Emphasis on near field ( $> 1$  main pipe diameter)
- Geometry not fully specified

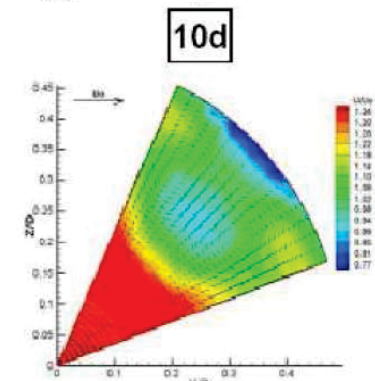
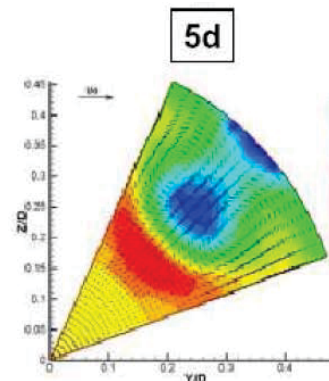
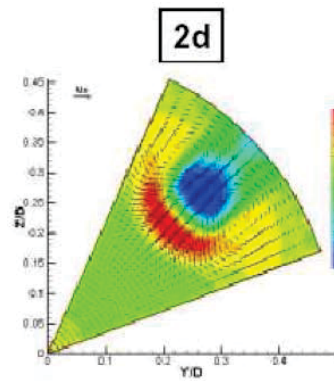
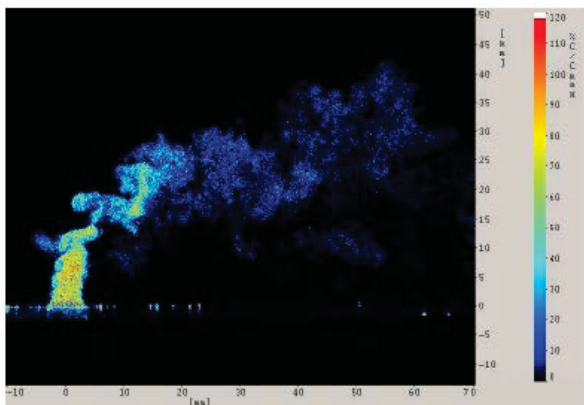
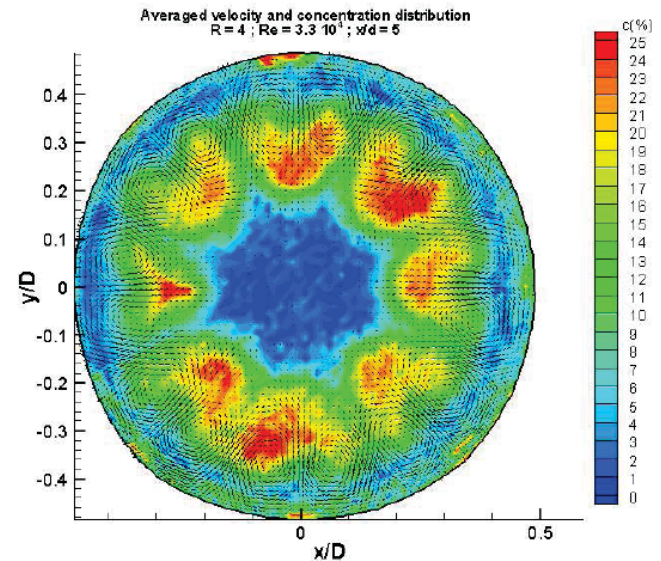



# Geometry Model

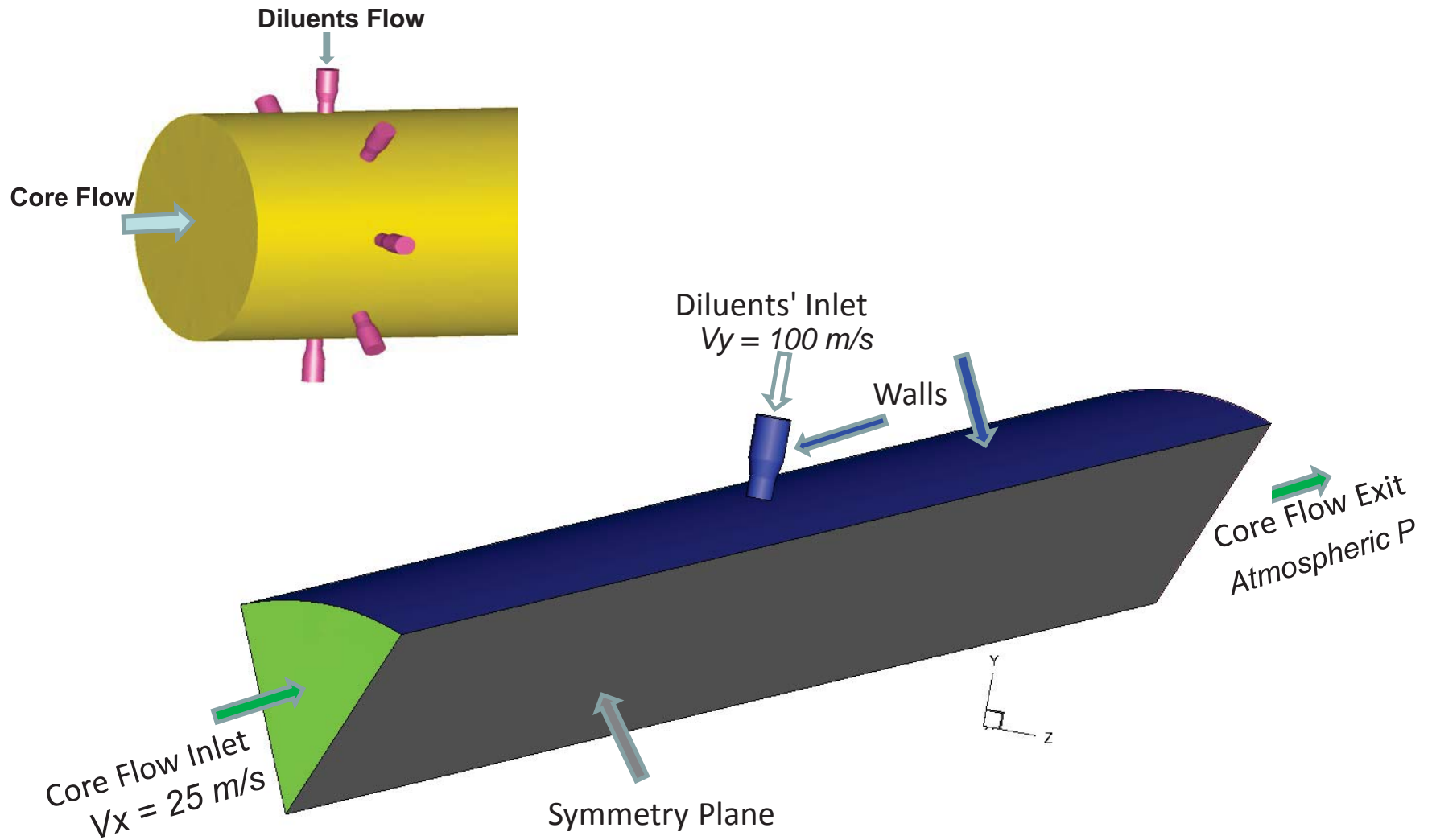



# Grid: 800K elements, all hex

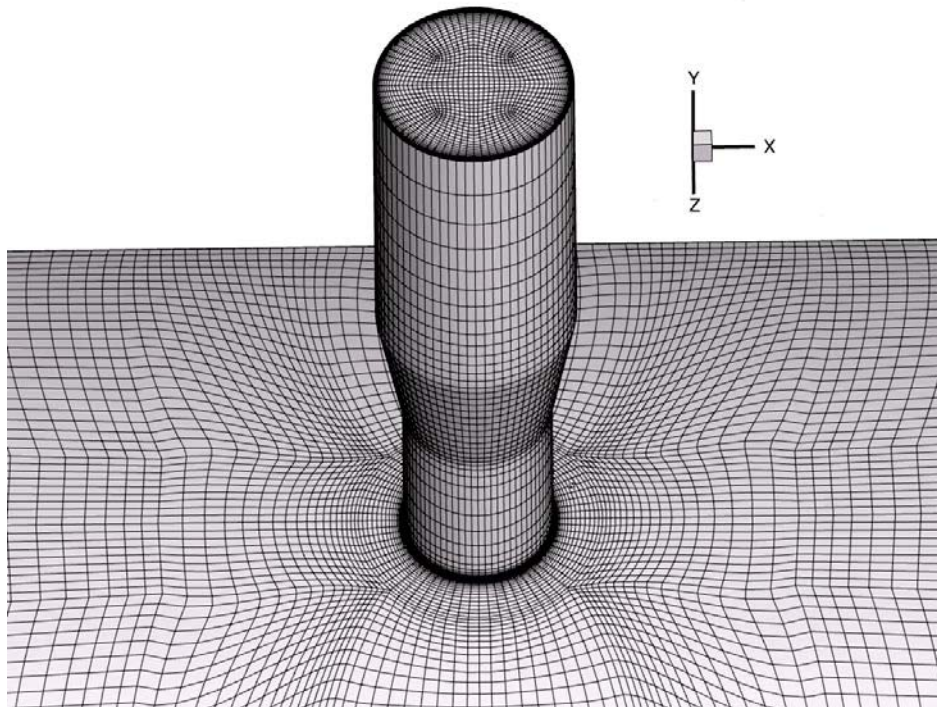

Jet Inlet

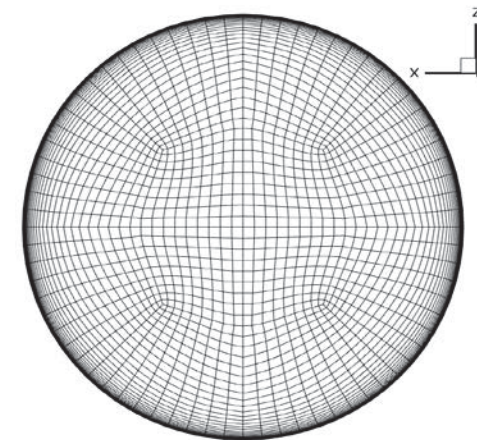

Inlet and exit



# Numerical and Experimental Investigation of Jets in Cross Flow

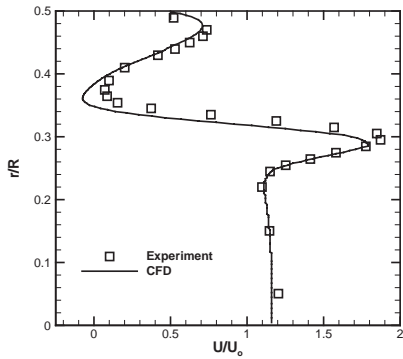

Axial velocity profile,  $x = 2d$

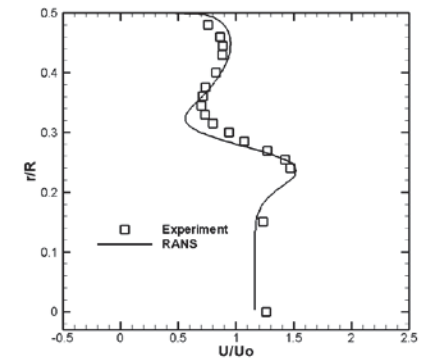
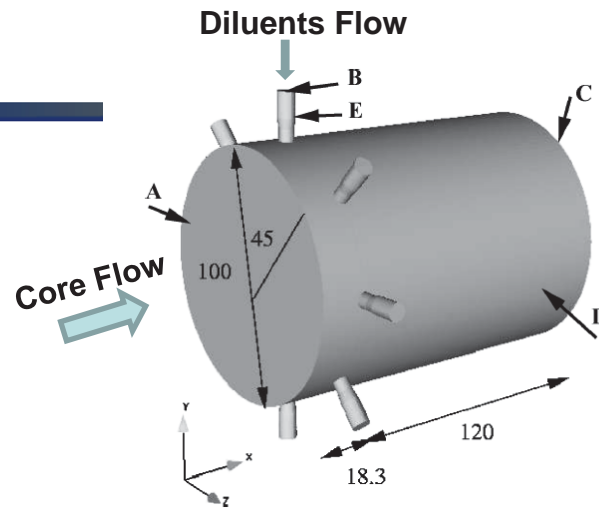

Axial velocity profile,  $x = 5d$

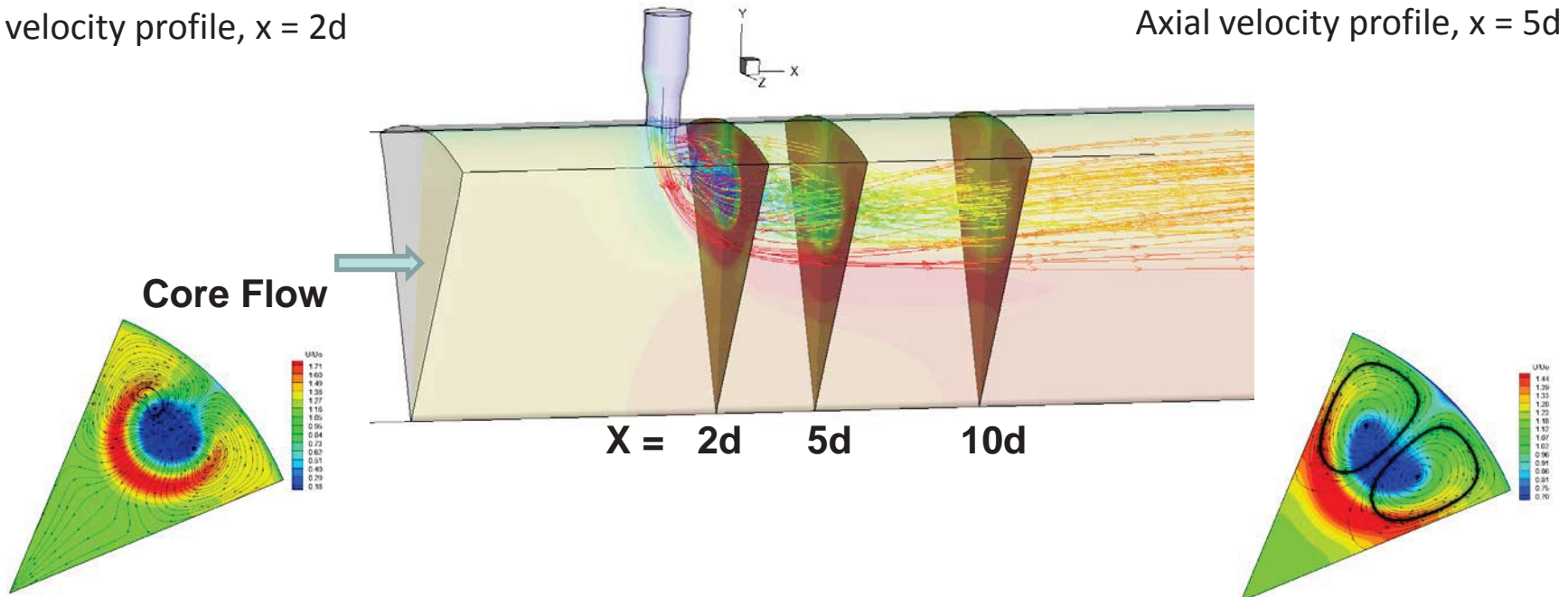

Axial velocity Contours,  $x = 2d$

Axial velocity contours,  $x = 5d$



# Counter Rotating Vortex Pairs

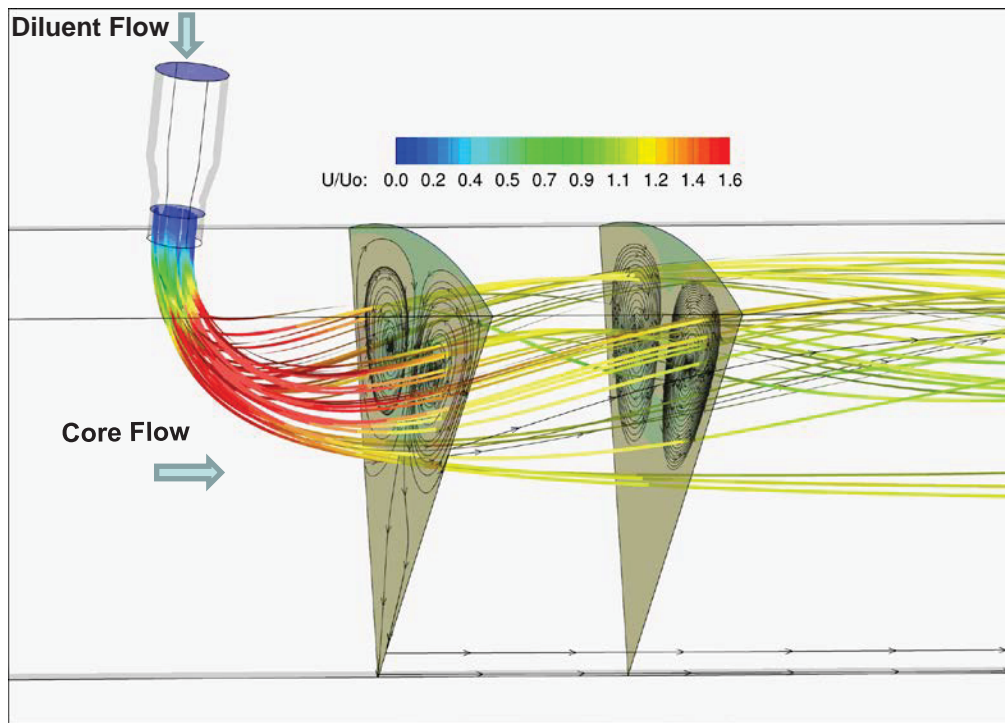

Perspective view

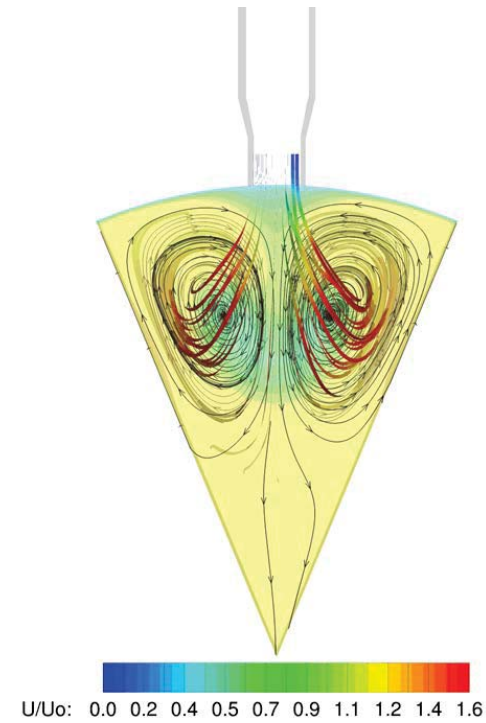

View from Upstream



# Experimental data versus computational results: Axial Velocity Contours



Axial  
locations  
( $d = \text{inj. dia.}$ )



$X = 2d$ :

Experiment

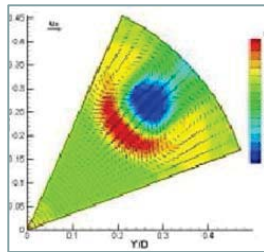

Fluent

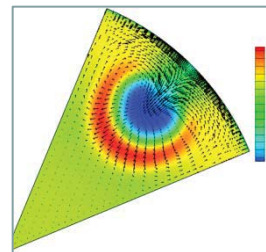

STAR-CCM+

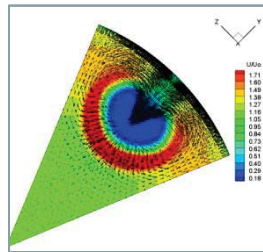

CFD<sup>++</sup>

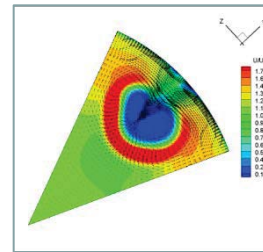

LES (ONERA)

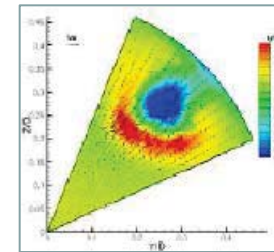

$X = 5d$ :

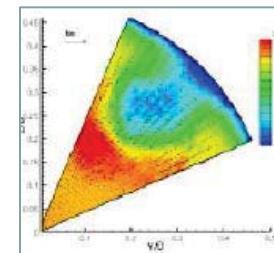
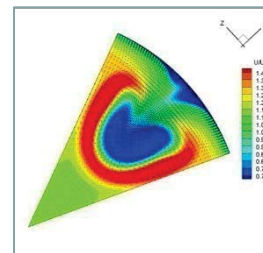
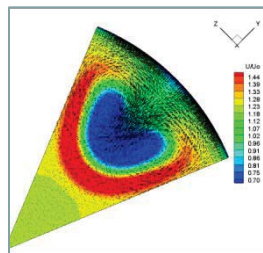
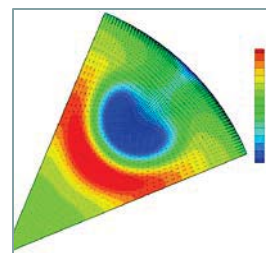
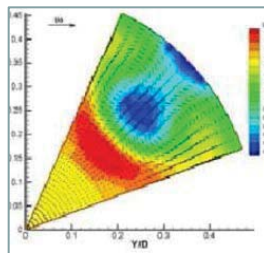

$X = 10d$ :

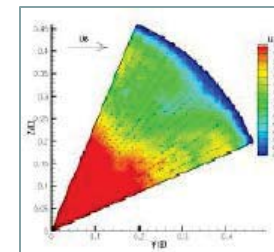
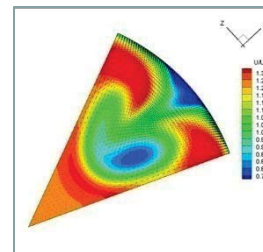
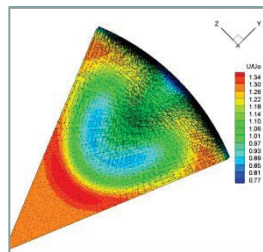
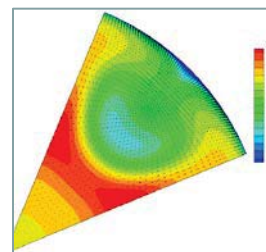
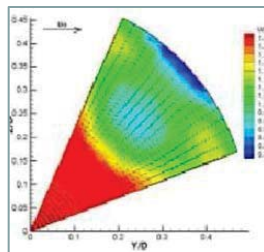



# Experimental data versus computational results: Axial Velocity Profiles



Axial  
locations  
( $d = \text{inj. dia.}$ )



$X = 2d$ :

LES (ONERA)

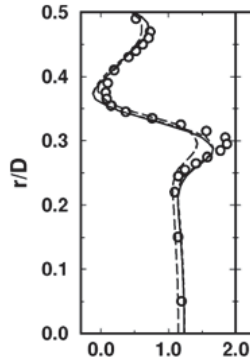

Fluent

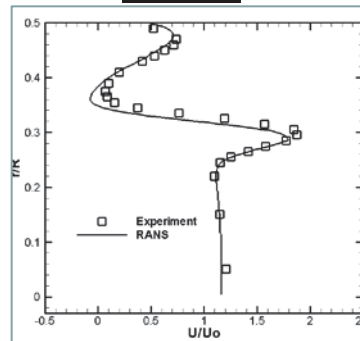

STAR-CCM+

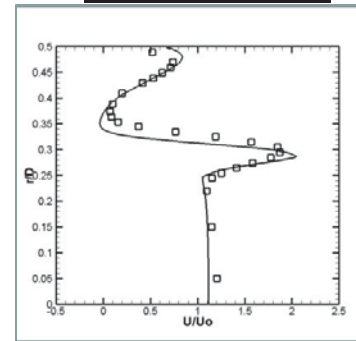

CFD<sup>++</sup>

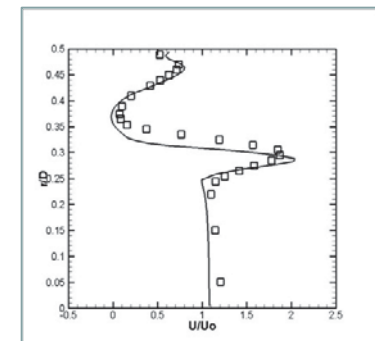

$X = 5d$ :

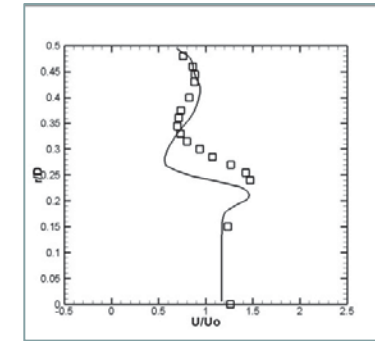
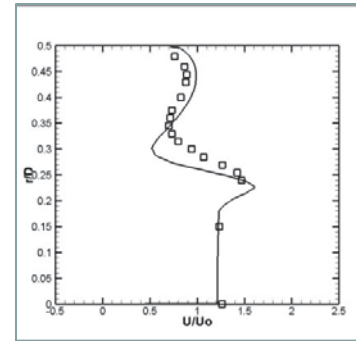
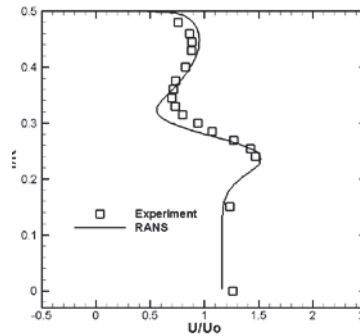
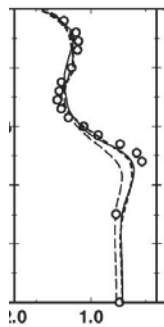

$X = 10d$ :

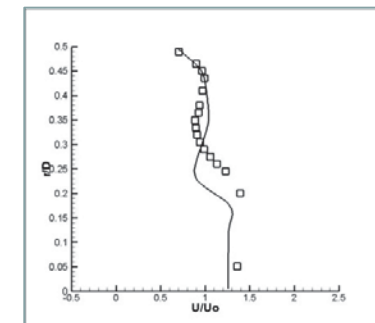
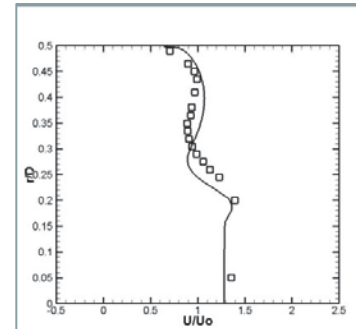
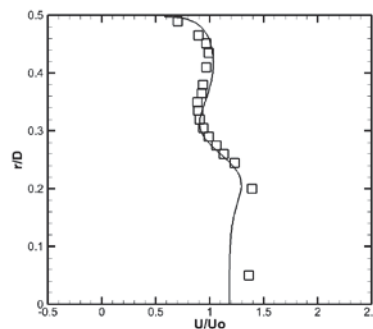
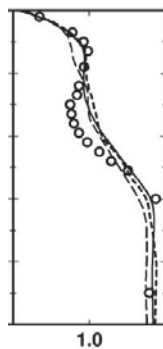





# Experimental data versus computational results: Axial Velocity Profiles



Axial locations  
( $d = \text{inj. dia.}$ )



$X = 2d$ :

$X = 5d$ :

$X = 10d$ :

Fluent: Std k- $\epsilon$

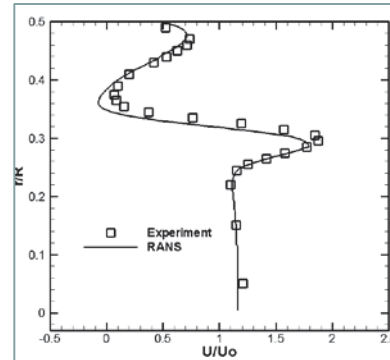

Fluent Realizable k- $\epsilon$

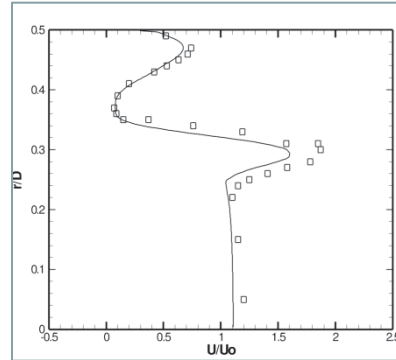

CFD++ Realizable k- $\epsilon$

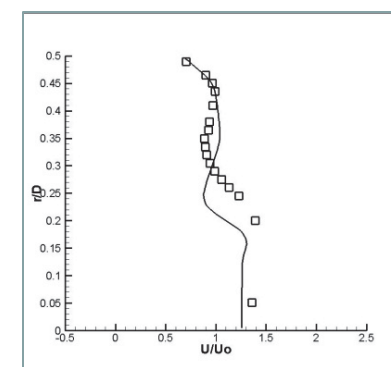
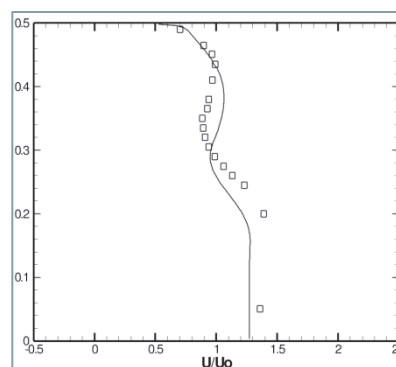
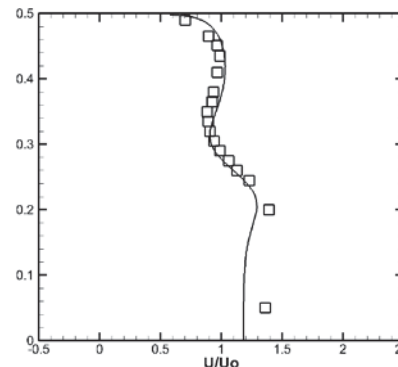
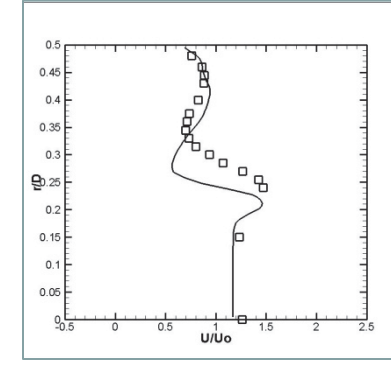
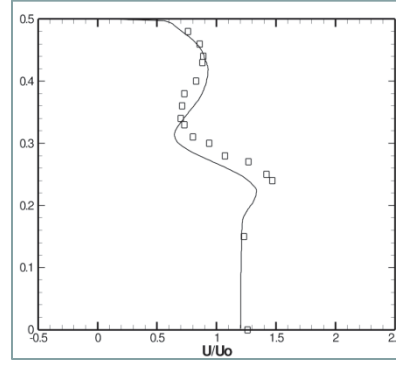
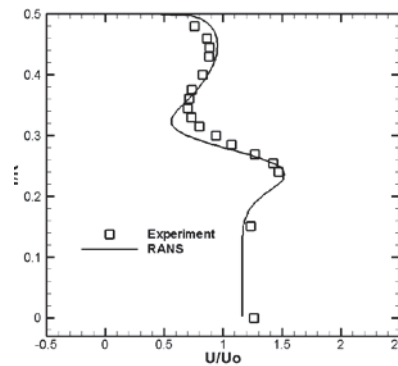
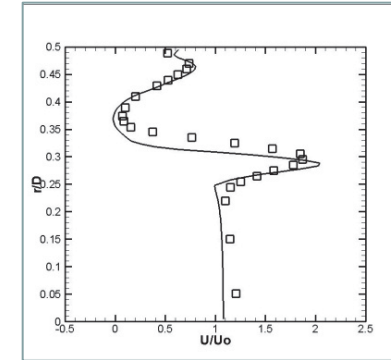



# Experimental data versus computational results:



$X = 2d$ :

Experiment

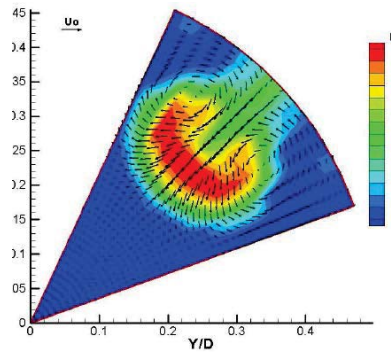

Fluent

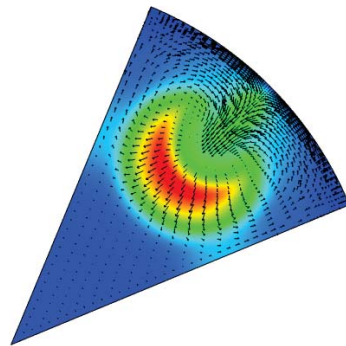

STAR-CCM+

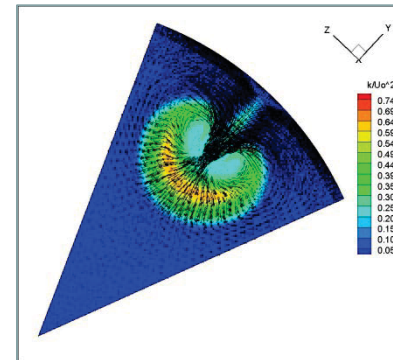

CFD<sup>++</sup>

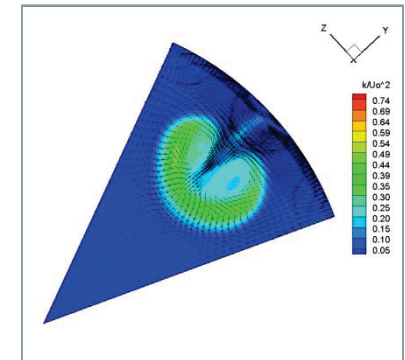

Turbulent kinetic energy contours

$Z = 0$ :

Experiment

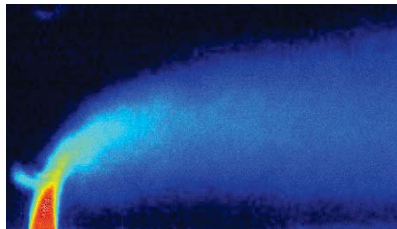

Fluent

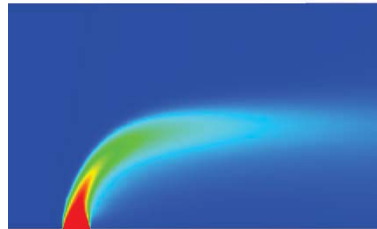

STAR-CCM+

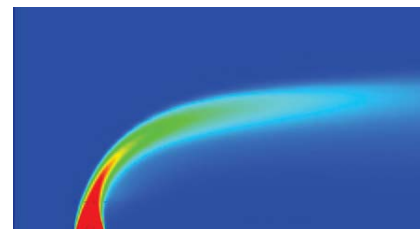

CFD<sup>++</sup>

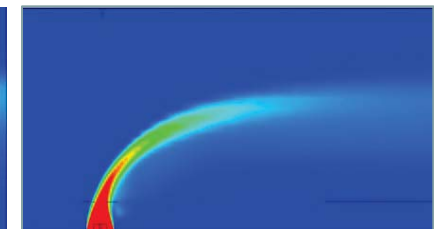

Jet Species Mass Fraction



# Turbulent Kinetic Energy Produced via Two Turbulence Models

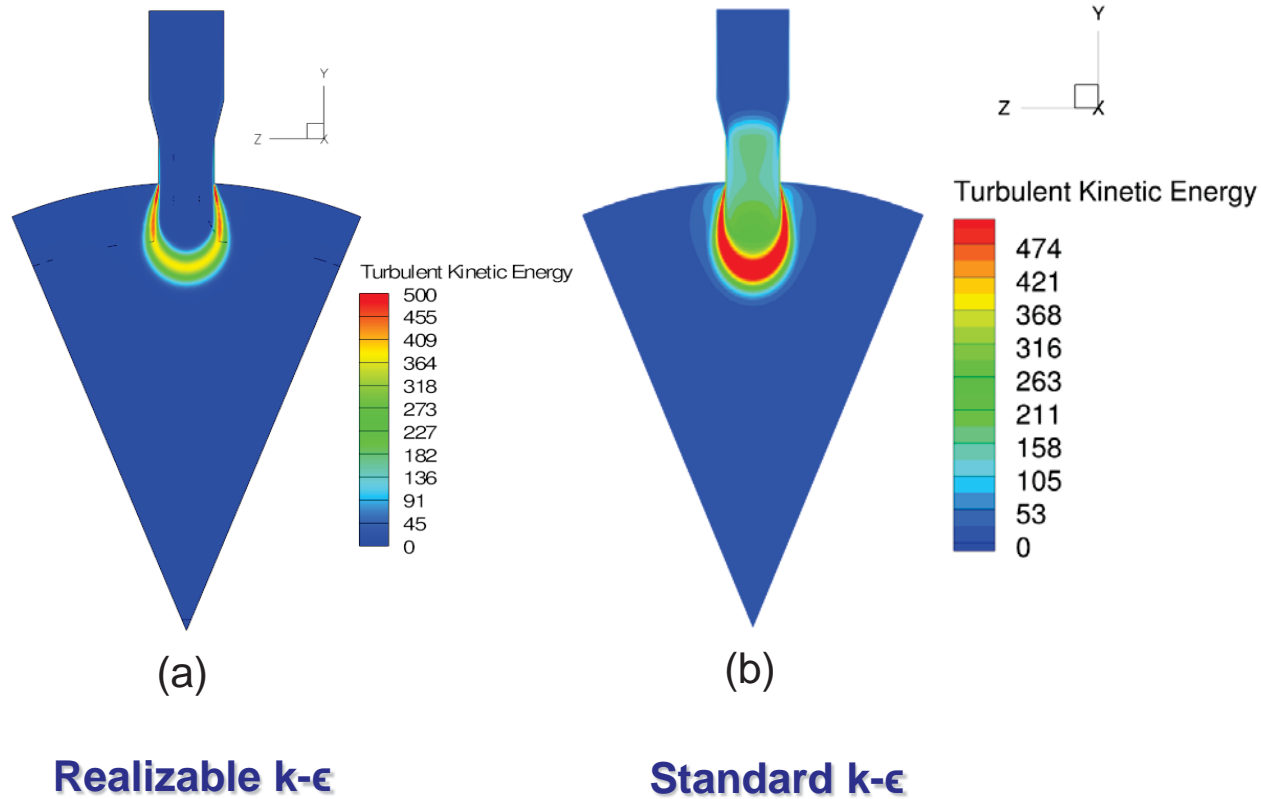



# Experimental data versus computational results: Jet Concentration Profiles



Axial  
locations  
( $d = \text{inj. dia.}$ )



$X = 2d$ :

$X = 5d$ :

$X = 10d$ :

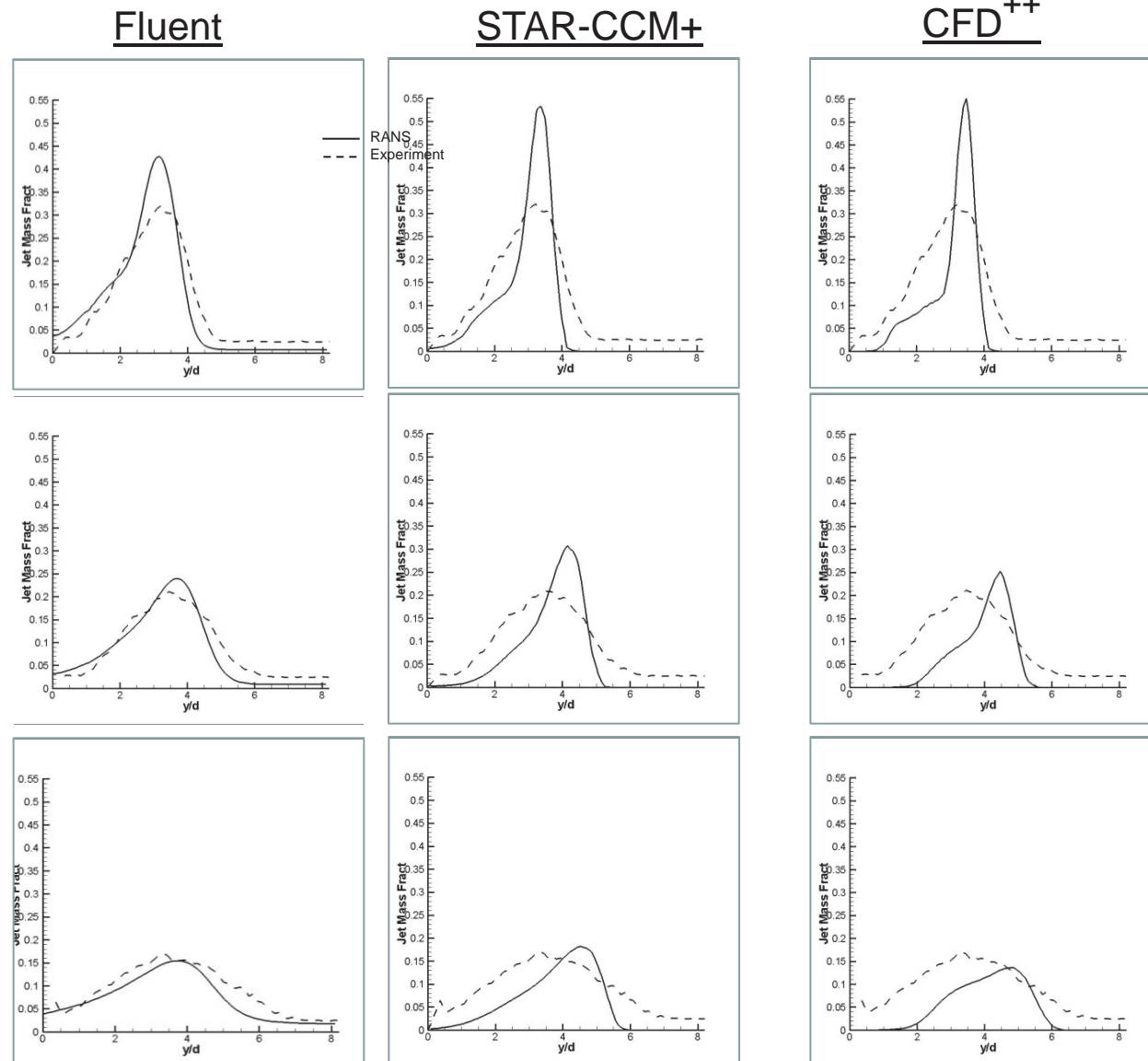



## Comparison of Predicted Un-mixedness



Predicted Un-mixedness over cross-sectional area for three codes

$$U_s = \frac{\sigma_c^2}{\bar{C}(1-\bar{C})} = \frac{1/A \int (C - \bar{C})^2 dA}{\bar{C}(1-\bar{C})}$$

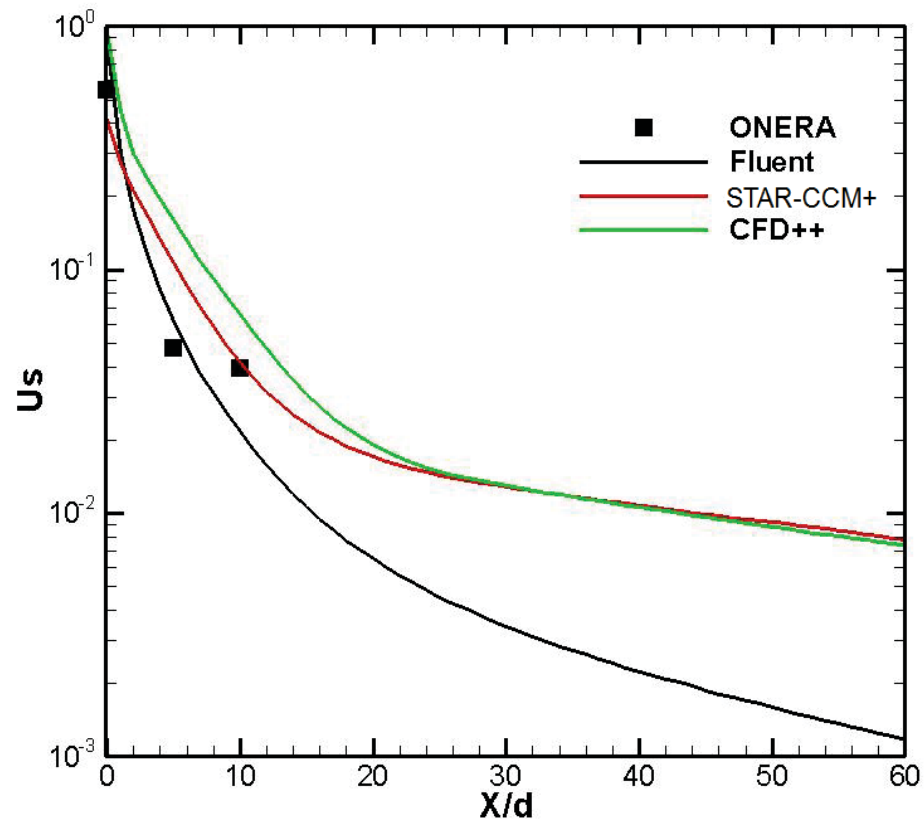



# Summary



- All codes (Fluent, CFD++, and Star-ccm+ using realizable k- $\epsilon$ ) predict the experimental centerline velocity profiles reasonably well
- Fluent, using the standard k- $\epsilon$ , & LES predict turbulent kinetic energy, centerline velocity profiles and centerline concentration profiles that better match the experimental data
- CFD++ calculations predict jet flow that manifests itself in an asymmetric wake profile in a symmetric domain
- STAR-CCM+ and FLUENT calculations predict a more stable flow that maintains wake symmetry
- Fluent predicts higher overall mixedness than other codes