

Applications of SMART: a DRDC atmospheric radiative transfer library optimized for wide band computations

**Vincent Ross (AEREX Avionique Inc.),
Denis Dion (DRDC-Valcartier)**

**ITBM&S, Toulouse France.
June 28th 2011**



Report Documentation Page

Form Approved
OMB No. 0704-0188

Public reporting burden for the collection of information is estimated to average 1 hour per response, including the time for reviewing instructions, searching existing data sources, gathering and maintaining the data needed, and completing and reviewing the collection of information. Send comments regarding this burden estimate or any other aspect of this collection of information, including suggestions for reducing this burden, to Washington Headquarters Services, Directorate for Information Operations and Reports, 1215 Jefferson Davis Highway, Suite 1204, Arlington VA 22202-4302. Respondents should be aware that notwithstanding any other provision of law, no person shall be subject to a penalty for failing to comply with a collection of information if it does not display a currently valid OMB control number.

1. REPORT DATE 28 JUN 2011		2. REPORT TYPE		3. DATES COVERED 00-00-2011 to 00-00-2011	
4. TITLE AND SUBTITLE Applications of SMART: a DRDC atmospheric radiative transfer library optimized for wide band computations				5a. CONTRACT NUMBER	
				5b. GRANT NUMBER	
				5c. PROGRAM ELEMENT NUMBER	
6. AUTHOR(S)				5d. PROJECT NUMBER	
				5e. TASK NUMBER	
				5f. WORK UNIT NUMBER	
7. PERFORMING ORGANIZATION NAME(S) AND ADDRESS(ES) Defence R&D Canada - Valcartier, 2459 Pie-XI Blvd North, Quebec (Quebec) G3J 1X5 Canada,				8. PERFORMING ORGANIZATION REPORT NUMBER	
9. SPONSORING/MONITORING AGENCY NAME(S) AND ADDRESS(ES)				10. SPONSOR/MONITOR'S ACRONYM(S)	
				11. SPONSOR/MONITOR'S REPORT NUMBER(S)	
12. DISTRIBUTION/AVAILABILITY STATEMENT Approved for public release; distribution unlimited					
13. SUPPLEMENTARY NOTES DRDC-VALCARTIER-SL-2011-442					
14. ABSTRACT					
15. SUBJECT TERMS					
16. SECURITY CLASSIFICATION OF:			17. LIMITATION OF ABSTRACT	18. NUMBER OF PAGES	19a. NAME OF RESPONSIBLE PERSON
a. REPORT	b. ABSTRACT	c. THIS PAGE			
unclassified	unclassified	unclassified	Same as Report (SAR)	16	

Contents

- Introducing the SMART and SMARTI libraries
- Features
- Wide band correlated-ks
- Speed and accuracy
- Possible application
- Current projects implementing SMART/SMARTI
 - KARMA engagement simulator
 - PSAD-MPIR on the FREMM French frigates
- Conclusion

The SMART library

S uite **MART**

for **ultiresolution**

tmospheric

adiative

ransmission

I **nterface**

The SMART library

- SMART (1.0 beta) features
 - Spectral and wideband CK transmittance & radiance
 - MODTRAN molecular extinctions (CK)
 - Seamless integration of MOD4v3r1
 - MODTRAN and DRDC aerosol models
 - Falling snow model (DRDC)
 - DRDC accurate refracted path calculation
 - 2-stream (flux) and DISORT (N-stream) MS calculations
 - Lambert and sea surface (DRDC analytical model) BRDF. Others to come.
 - Optimized by using advanced C++ programming methods
 - Intuitive like C++, fast like Fortran/C

The SMART library

- No modifications to the MODTRAN source code is necessary
 - Works with the official MODTRAN4 executable
 - Plans to support MODTRAN 5 in the near future

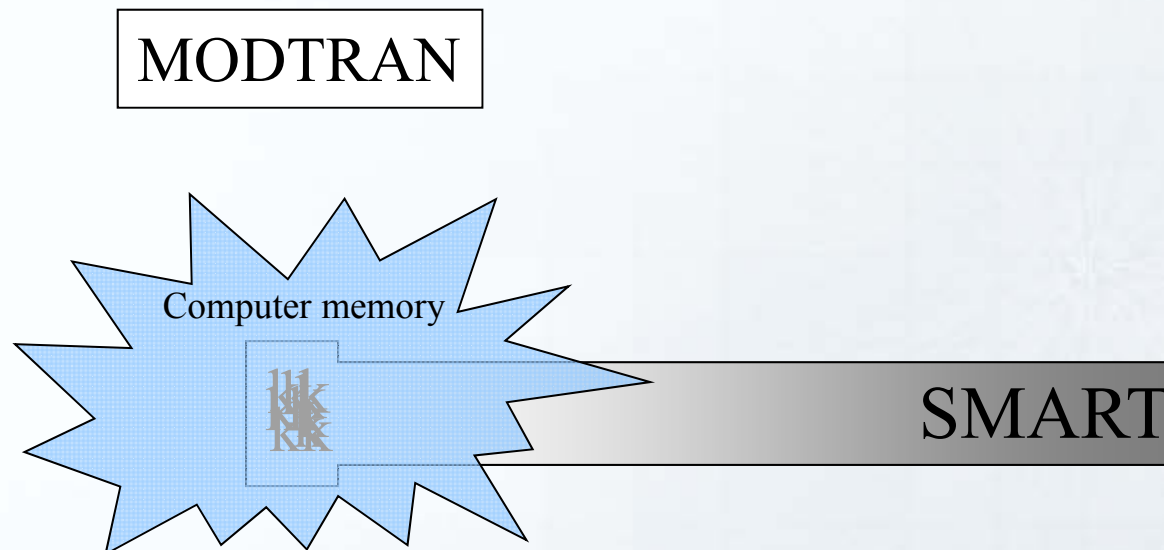

The SMART library

- High language portability (SMARTI)
 - C++ (native)
 - Java
 - Matlab (through Java)
- Other language wrappers are possible/planned
 - Python, C#, Lisp, Lua, Octave, Pearl, PHP, Pike, TCL, R, Ruby, and more...

The correlated-k theory

- Transformation to Correlated-K space

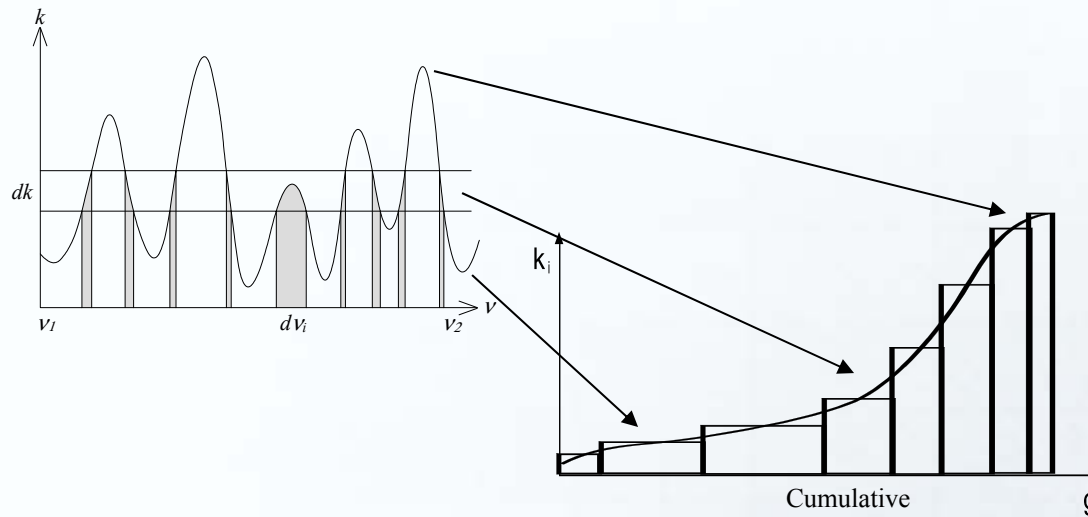

- Monotonic function need much fewer points to be represented accurately

$$T = \sum_i \exp(-k_i(g) \cdot s) \Delta g_i$$

Wideband correlated-ks

- Converting MODTRAN4™ CK extinctions to wideband CK

1) Sort

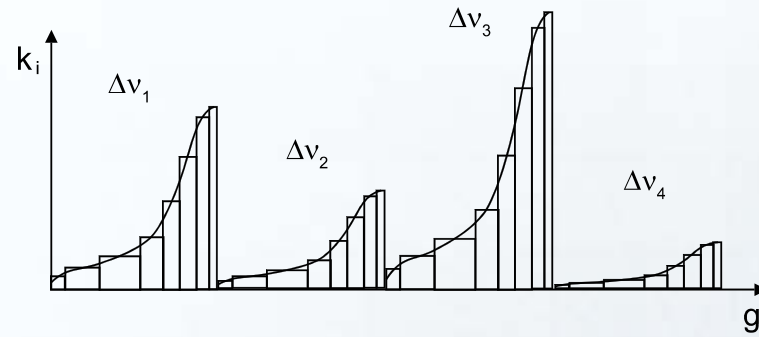

2) Interpolate

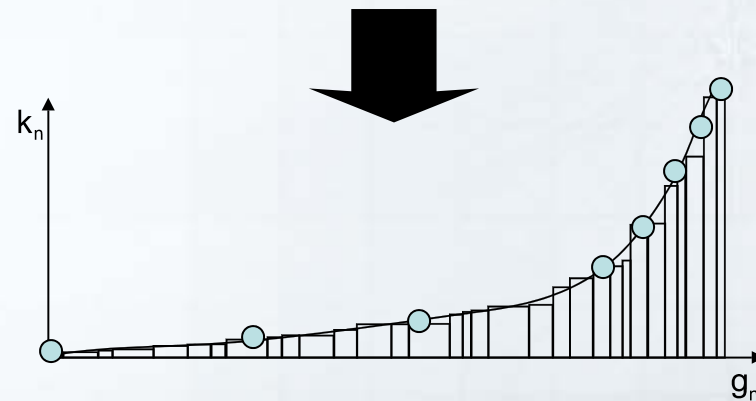

Wideband correlated-ks

- Converting other quantities to wideband CK space

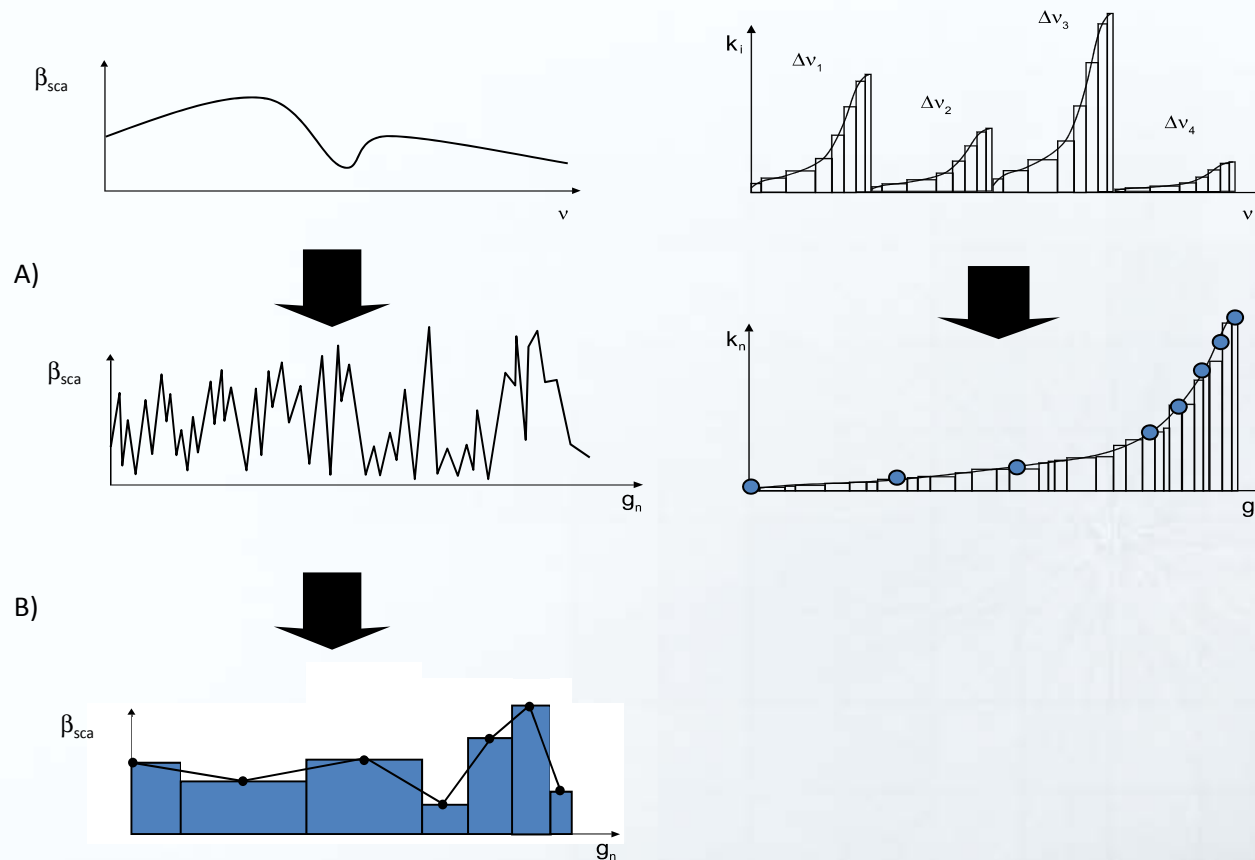

Benefits

- Speed (wideband)
 - Over 1000 lines of sight per second (excluding initialization) in single and 2-flux multiple scattering
 - 50 lines of sight per second with 16 stream DISORT.

	Wide band CK			MODTRAN 4		
	Single (17 ck)	2 Str MS	16 Str DISORT	Single	2 Str MS	16 Str DISORT
Visible	0.00078 s	0.00125 s	0.166 s	0.83 s	2.86 s	3061 s
3-5 μm	0.00124 s	0.00234 s	0.19 s	1.05 s	3.08 s	1586 s

(Excluding initializing phase)

Benefits

- Accuracy

- Spectral results are almost identical to MODTRAN 4.
- Wideband radiance results are within 5% of full MODTRAN 4 calculations

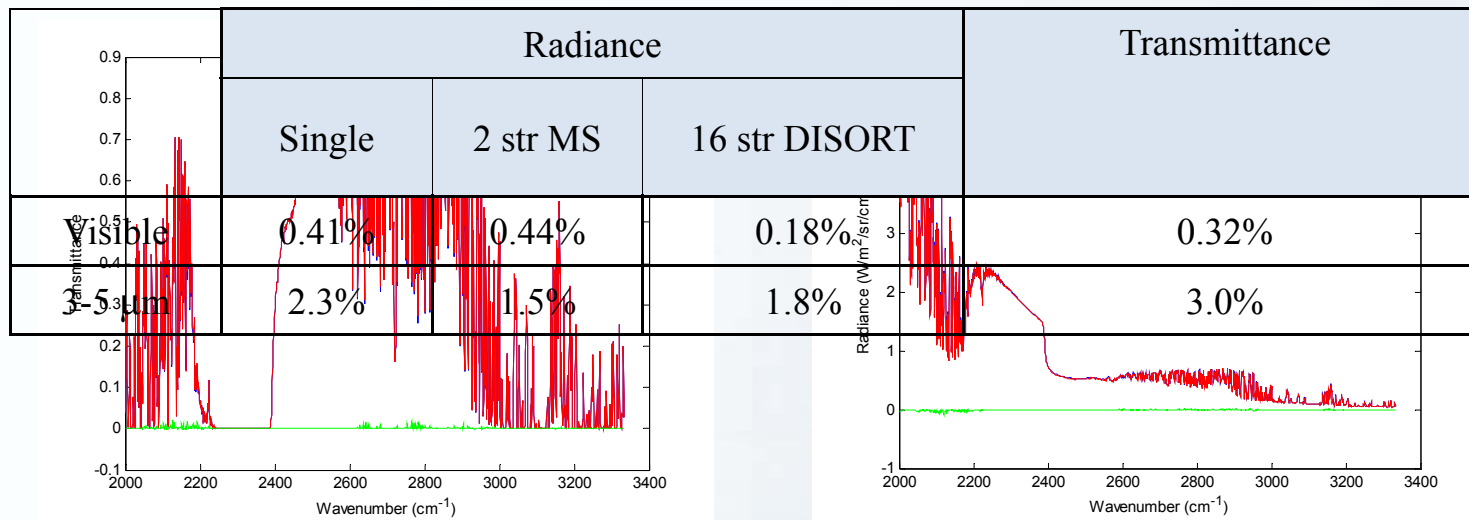

Applications

- Scene modeling:
 - Simulators
 - Assessing target detection/tracking algorithms.
 - Training

- EOTDA applications:
 - Contrast maps
 - Detection probability
 - “What if” scenarios
 - (requires especially optimized RT codes)

- Modeling for multi-spectral detectors.

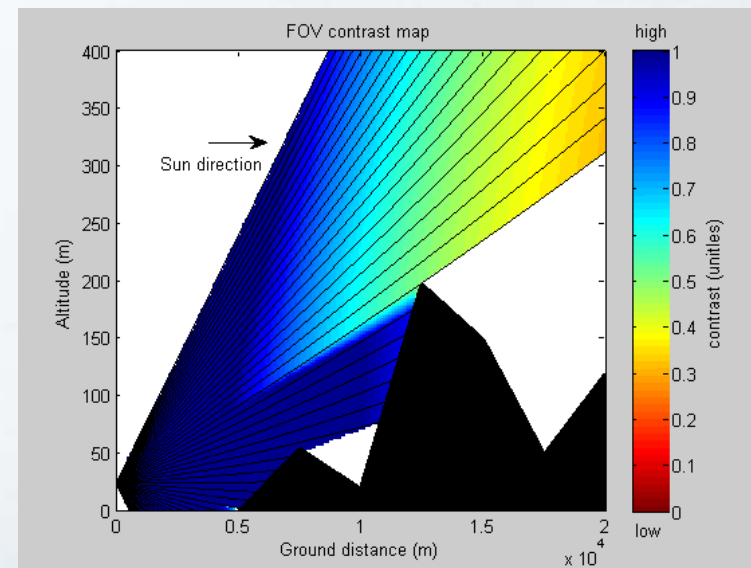
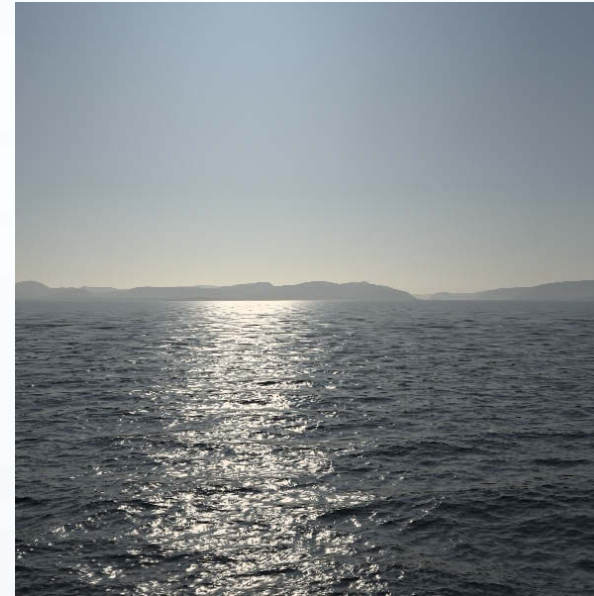

Current projects: KARMA simulation framework

IR scene Generation:

- IR scene = Input to the seeker models
- SMART atmosphere model
 - Dynamic atmospheric properties
 - Wideband-CK computations

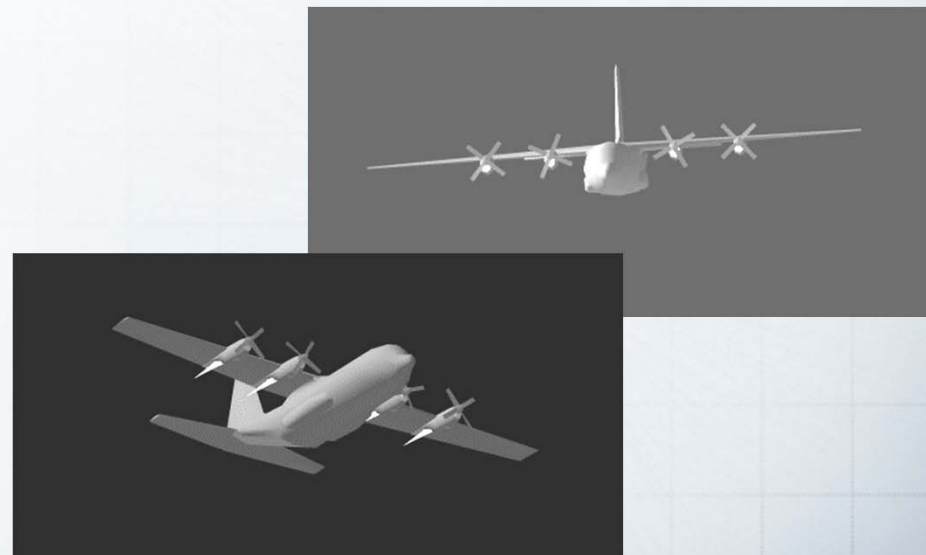
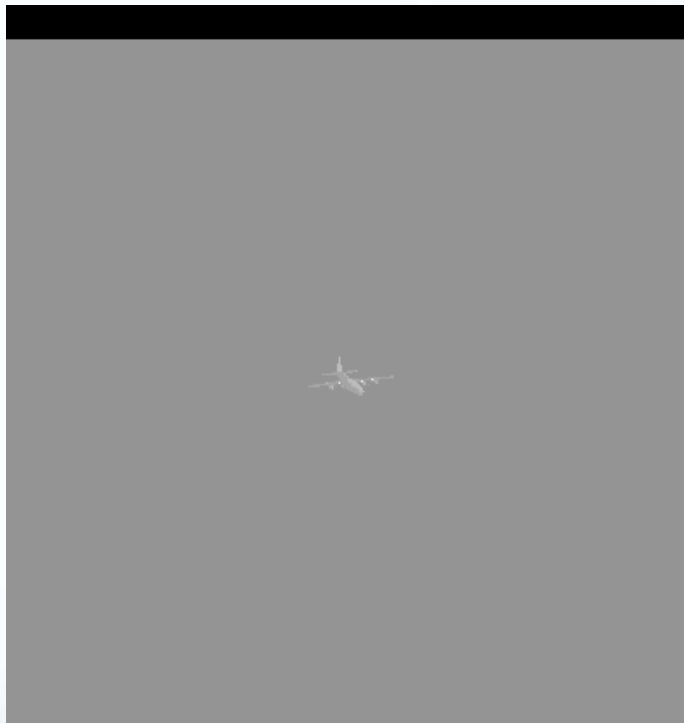

Current projects: MPIR (PSAD)

- PSAD-MPIR on the French FREMM (Multi Mission European FRigate) for DCNS

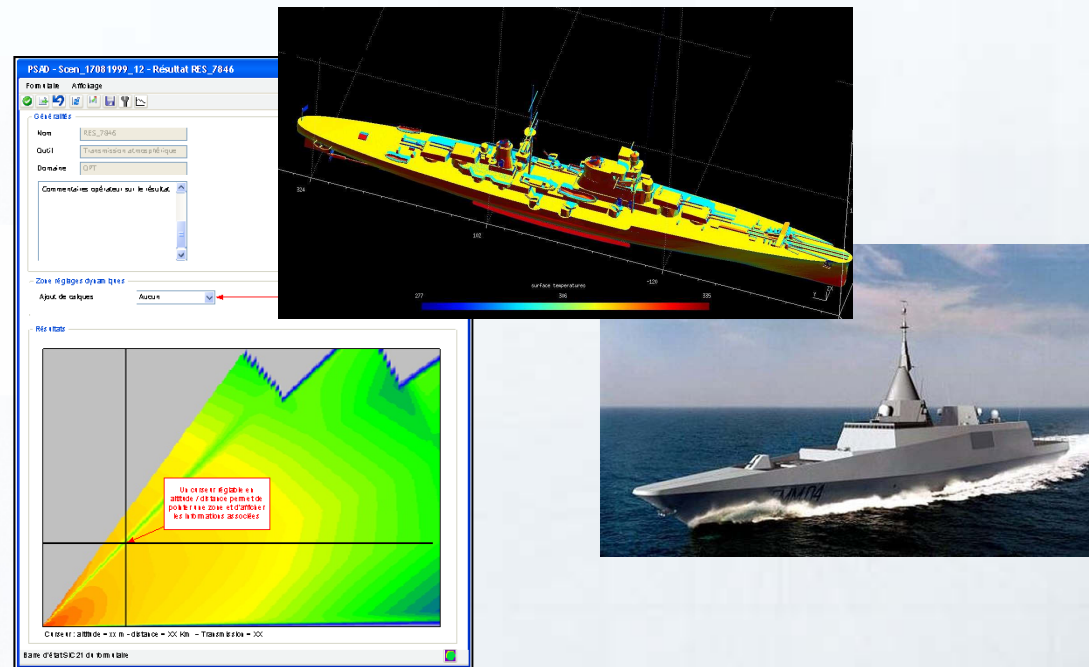

Thermal ship image courtesy of Fabian Lapiere, Royal Naval Academy of Belgium. (Computed using OSMOSIS)

Conclusion

- SMART(I) v1.0 beta is now ready.
- SMARTI is already in use in Canadian/International collaborative projects
- Interested beta users are welcome (vross@aerex.ca).
- Imaging, multispectral and EOTDA applications would benefit
- Divergence from MODTRAN 4 in radiance and transmittance are below 5% for most visible and IR bands in wide CK mode

DEFENCE



DÉFENSE