



Integrity ★ Service ★ Excellence

Computational Cognition and Robust Decision Making

Date: 6 March 2013

**Jay Myung, PhD
Program Officer
AFOSR/RTC**

Air Force Research Laboratory

Report Documentation Page

Form Approved
OMB No. 0704-0188

Public reporting burden for the collection of information is estimated to average 1 hour per response, including the time for reviewing instructions, searching existing data sources, gathering and maintaining the data needed, and completing and reviewing the collection of information. Send comments regarding this burden estimate or any other aspect of this collection of information, including suggestions for reducing this burden, to Washington Headquarters Services, Directorate for Information Operations and Reports, 1215 Jefferson Davis Highway, Suite 1204, Arlington VA 22202-4302. Respondents should be aware that notwithstanding any other provision of law, no person shall be subject to a penalty for failing to comply with a collection of information if it does not display a currently valid OMB control number.

1. REPORT DATE 06 MAR 2013		2. REPORT TYPE		3. DATES COVERED 00-00-2013 to 00-00-2013	
4. TITLE AND SUBTITLE Computational Cognition and Robust Decision Making				5a. CONTRACT NUMBER	
				5b. GRANT NUMBER	
				5c. PROGRAM ELEMENT NUMBER	
6. AUTHOR(S)				5d. PROJECT NUMBER	
				5e. TASK NUMBER	
				5f. WORK UNIT NUMBER	
7. PERFORMING ORGANIZATION NAME(S) AND ADDRESS(ES) Air Force Office of Scientific Research ,AFOSR/RTC,875 N. Randolph,Arlington,VA,22203				8. PERFORMING ORGANIZATION REPORT NUMBER	
9. SPONSORING/MONITORING AGENCY NAME(S) AND ADDRESS(ES)				10. SPONSOR/MONITOR'S ACRONYM(S)	
				11. SPONSOR/MONITOR'S REPORT NUMBER(S)	
12. DISTRIBUTION/AVAILABILITY STATEMENT Approved for public release; distribution unlimited					
13. SUPPLEMENTARY NOTES Presented at the AFOSR Spring Review 2013, 4-8 March, Arlington, VA.					
14. ABSTRACT					
15. SUBJECT TERMS					
16. SECURITY CLASSIFICATION OF:			17. LIMITATION OF ABSTRACT Same as Report (SAR)	18. NUMBER OF PAGES 19	19a. NAME OF RESPONSIBLE PERSON
a. REPORT unclassified	b. ABSTRACT unclassified	c. THIS PAGE unclassified			



2013 AFOSR SPRING REVIEW



NAME: Jay Myung

Years with AFOSR: 1.8

BRIEF DESCRIPTION OF PORTFOLIO

Support experimental and computational modeling work in:

1. Understanding **cognitive processes underlying human performance** in complex problem solving tasks;
2. Achieving **robust and seamless symbiosis between humans and systems** in decision making;
3. Creating **machine intelligent systems** that exhibit human-level performance in uncertain and dynamic environments.

LIST SUB-AREAS IN PORTFOLIO

1. **Mathematical and Computational Cognition**
2. **Robust Decision Making in Human-System Interface**
3. **Computational and Machine Intelligence**



Program Roadmap



Natural or artificial intelligence as **computational learning algorithms** requiring multi-disciplinary approaches

General purpose algorithms that the brain uses to achieve adaptive intelligent computation.

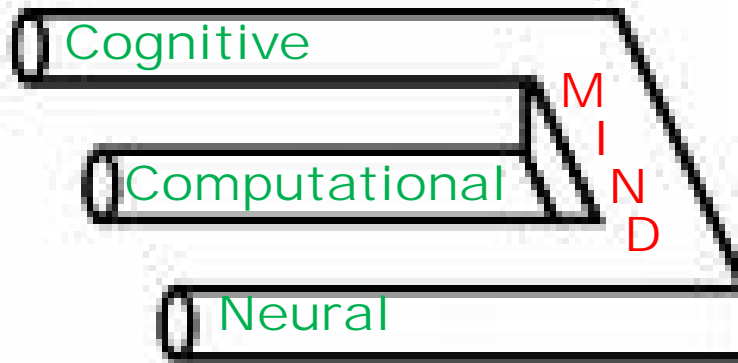

Mind as **computational learning algorithm** (software) running on the brain (hardware)

Cognitive science: *Identify the mind's invariants from behavioral experiments.*

Computer science: *Develop computational algorithms (i.e., software) implementable in artificial systems.*









Neuroscience: *Offer insights into how the brain implements natural intelligence on its neural hardware.*





Program Trends



- **Neurocomputational Cognition** 
- **Bio-inspired Computing Machines** 
- **Robust Decision Making and Classification** 
- **Memory, Categorization, and Reasoning** 
- **Belief and Preference in Decision Making under Uncertainty** 
- **Human-System Interface** 
- **Computational Intelligence** 
- **Meta-modeling** 
- **Optimal Learning and Planning** 



1. Mathematical and Computational Cognition



Goal:

Advance the computational modeling of **human cognition** in attention, memory, categorization, reasoning, and decision making.

Challenges and Strategy:

- Seek algorithms for adaptive intelligence inspired by neuroscience
- Multidisciplinary efforts cutting across mathematics, cognitive science, neuroscience, computer science, and electrical engineering.

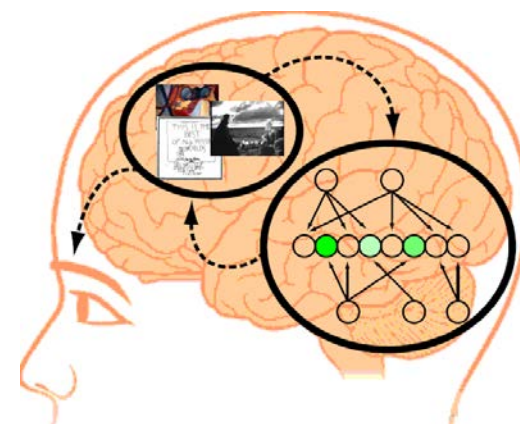
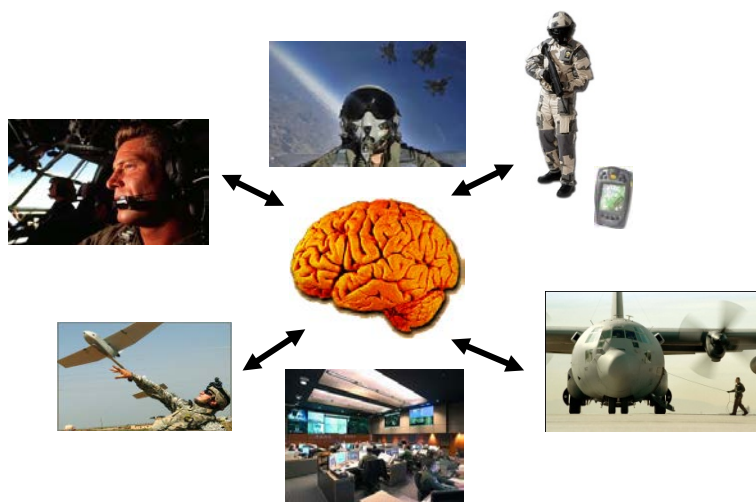



Neurocognitive Information Processing

A. Lazar (Columbia, EECS)



Aurel Lazar

Neuronal Information Processing (Hodgkin & Huxley, 1963, Nobel Prize)



Alan Hodgkin

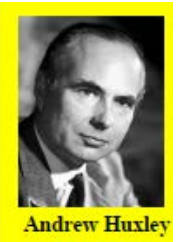

Andrew Huxley

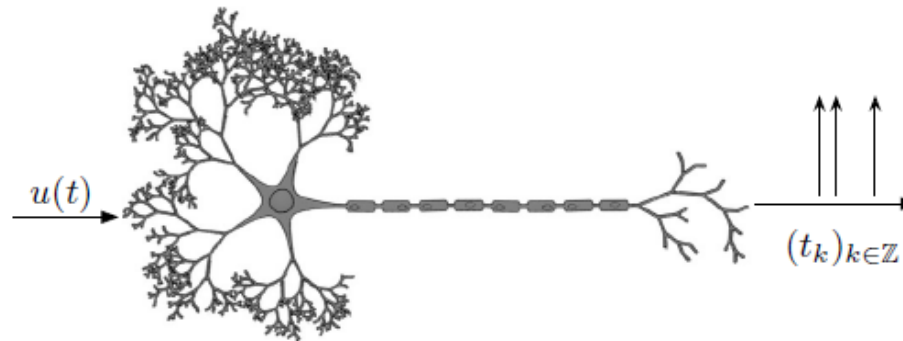

“Cognition is a kind of Neural Computation.”

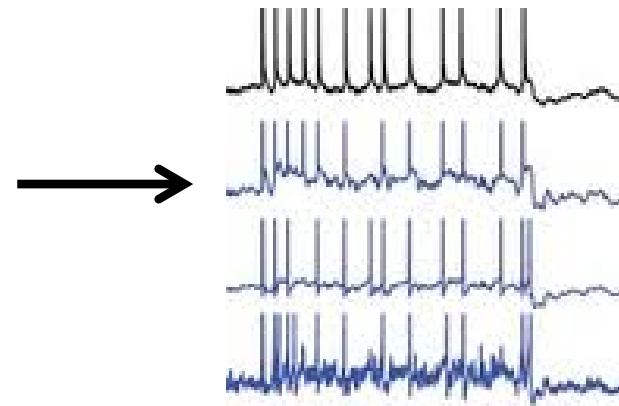
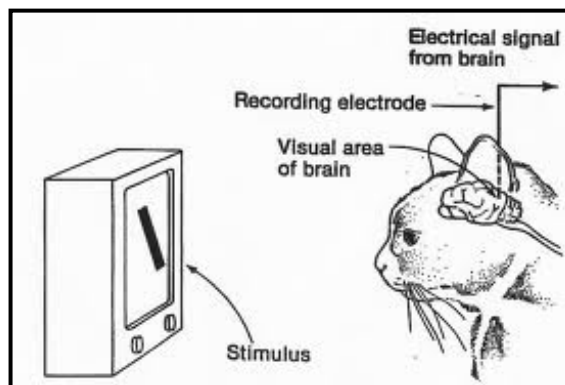



Neurocognitive Information Processing

A. Lazar (Columbia, EECS)



Scientific Challenge: The Holy Grail of Neuroscience

- How does the brain work?
- Can we “identify” the underlying neural circuit computations from neural and behavioral data?
- Reverse engineering problem (i.e., system identification)



(Behavioral data)

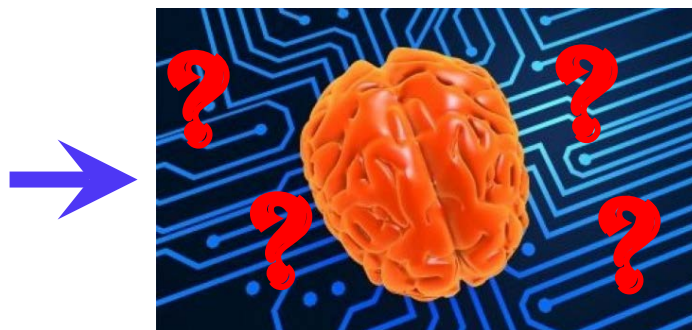

(To-be-identified)

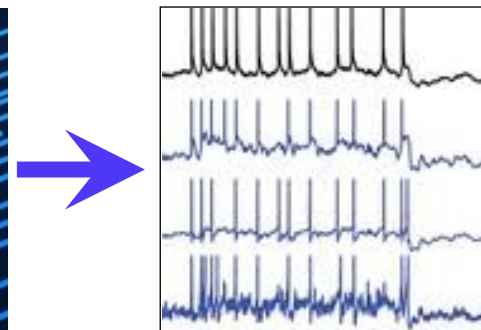

(Neural data)



Neurocognitive Information Processing

A. Lazar (Columbia, EECS)



Objective: Develop a formal methodology for identifying sensory neural circuits of the fruit fly brain.

Technical approach: Dynamic signal processing systems; convex optimization; parallel computing; frame theory.

DoD benefits: Next-generation brain-inspired information processing machines.

For future AF: Implementation of computational algorithms extracted from reverse engineering of insect flight control systems for designing nano air vehicles.

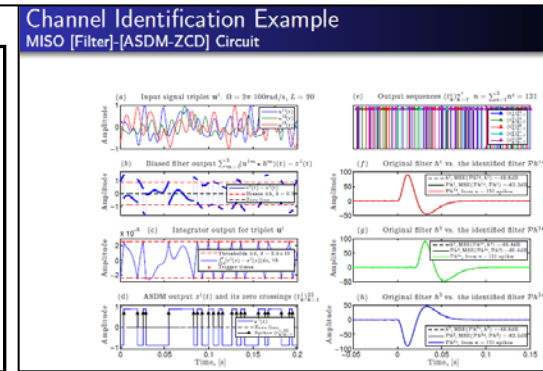
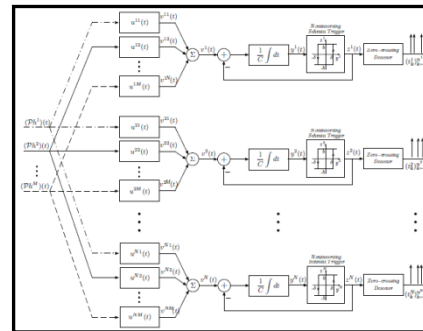
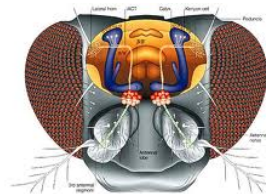
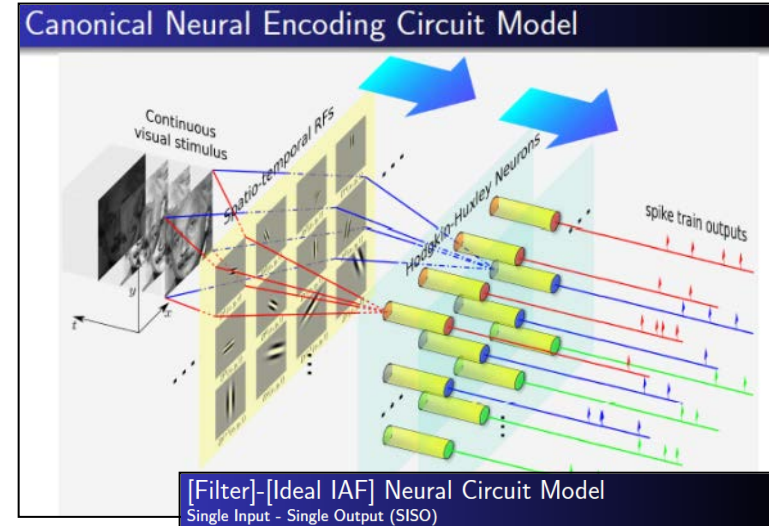



Mathematical Theory of Memristor Minds

L. Chua (Berkeley, EECS)



Objective: Uncover fundamental biophysical mechanisms of single neuronal information processing.

Technical approach: Develop memristor models of neuronal synapses and ion channels based on nonlinear dynamics theory.

DoD benefits: If successful, could radically change the notion of brain-inspired computation. Can potentially produce much more powerful neuromorphic chips than current state of the art.



L. Chua

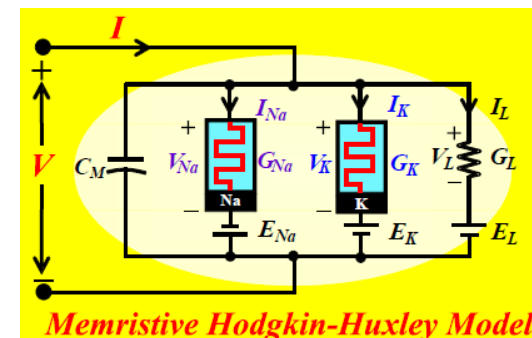
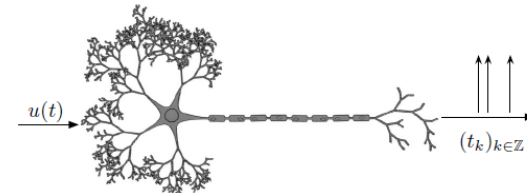

Memristive Hodgkin-Huxley Model

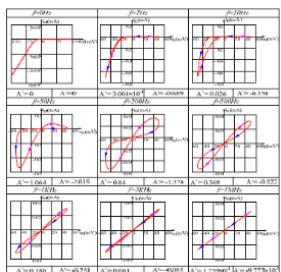

Theorem: Sub-Critical Hopf Bifurcation and Edge of Chaos

The Sub-Critical Hopf Bifurcation responsible for the Action Potential occurs exactly on the right boundary of the neuron's edge of chaos.

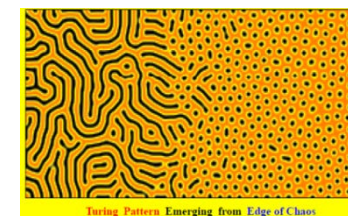
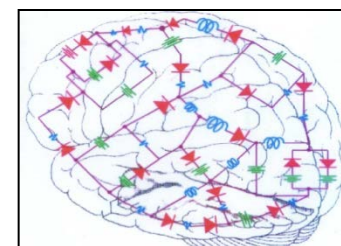
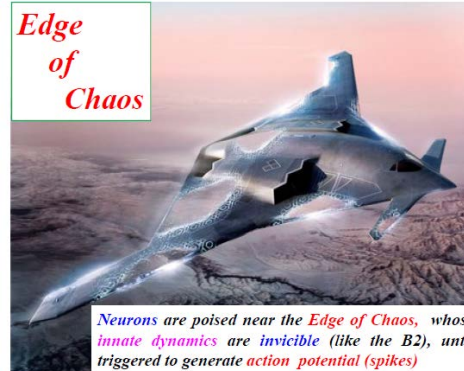

Turing Pattern Emerging from Edge of Chaos

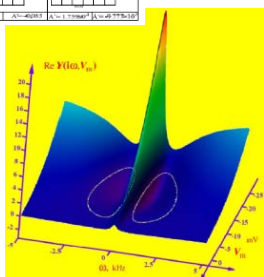



2. Robust Decision Making in Human-System Interface



Goal:

Advance the research on **mixed human-machine systems** to aid inference, communication, prediction, planning, scheduling, and decision making.

Challenges and Strategy:

- Seek computational principles for optimal symbiosis of mixed human-machine systems in data-to-decision problems.
- Machine learning methods for robust reasoning and planning.





Cognitive Processes of Spatial Visualization

G. Gunzelmann (AFRL, STAR team)



Objective: Explore and characterize the representation and mechanisms of spatial cognition in human-system interfaces.

Technical approach: Empirical studies of human performance on lab and naturalistic tasks.

DoD benefits: Improved understanding of human spatial information processing abilities, thereby informing decision making regarding training and workload assessment.

Air Force operations: Highly complex and fundamentally spatial



Human-system interface in UAVs



Coordination, Planning, Surveillance



Framework for spatial cognition

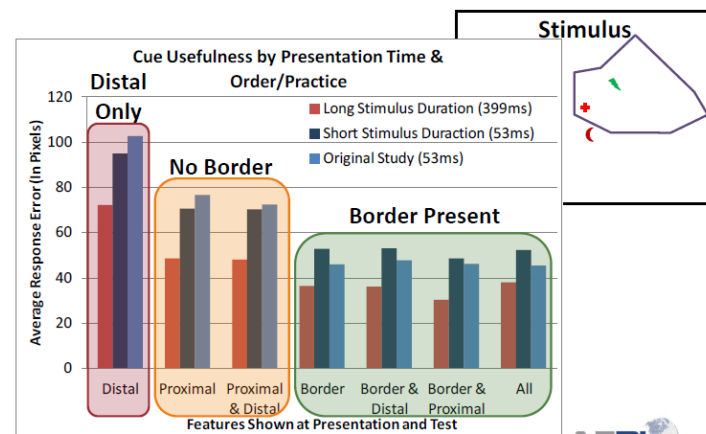
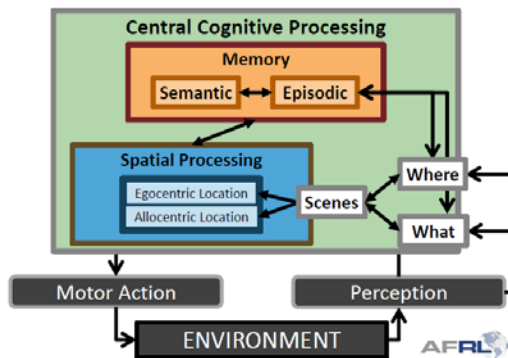



Robust Planning of Autonomous Systems

B. Williams (MIT, CSAIL)



Objective: Develop “calculus of risk” that enables autonomous systems to operate within specified risk bounds.

Technical approach: Planning algorithms that reason about risk and generate course of action to take while satisfying constraints on failure.

DoD benefits: Highly trustworthy autonomous systems with increased probability of mission success and reduced probability of catastrophic failure, such as UAV loss.



B. Williams

Drivers for Autonomous Decision Making



Piloting



Logistic support



Data Analysis and Adaptive Sampling

but autonomy incurs risk

5



A) Generate candidate contingent choices

B) Find flexible scheduling policy that meets risk constraint

Risk violated!

Risk ok!

Assignment to choices + Scheduling policy

Dispatch plan

Input: Probabilistic Temporal Plan Network

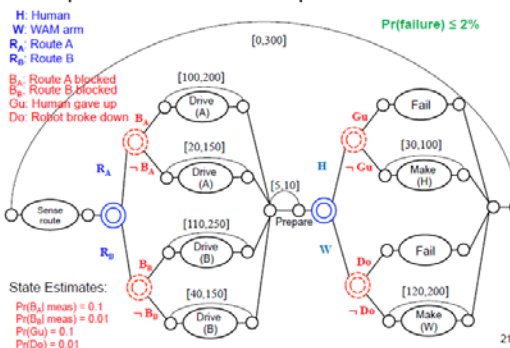

Demonstration: Robot Air Taxi Driver



Personal Transportation System

Goals →

- 1. Negotiation
- 2. Mission Planning
- 3. Risk-sensitive Navigation

→ Actions



3. Computational and Machine Intelligence



Goal:

Advance the research on **machine intelligence architectures** that derive from cognitive and biological models of human intelligence.

Challenges and Strategy:

- Seek fundamental computational principles for creating autonomous systems that learn and function at the level of flexibility comparable to that of humans.

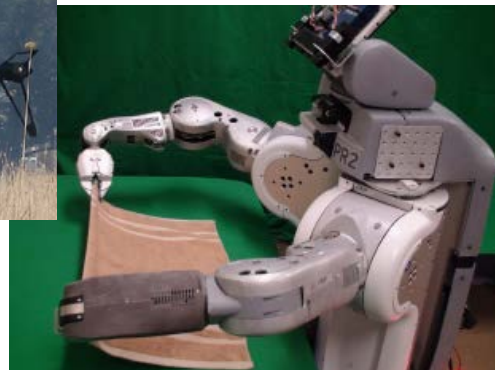



Bio-inspired Computation

J. Wiles (U. Queensland, ITEE)



Objective: Develop bio-inspired algorithms that are clock-free, grid-free, scale-free, and symbol-free.

Technical approach: Develop and test neural systems inspired by hippocampal architectures.

DoD benefits: Fundamental discoveries into computation in natural systems could lead to the development of robust and scalable machines.



J. Wiles

Bio-inspired computation

Summary: Rethinking the role of time in processing

Clock-free: spiking neuron as an asynchronous micro-pipeline

Grid-free: topological graphs with local metric structure and global regularization

Scale-free and symbol-free: multi-scale recurrent networks

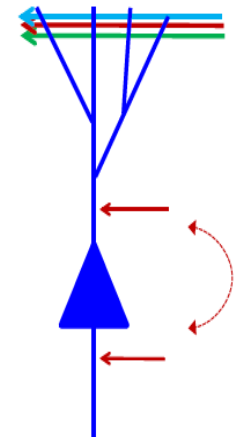

Clock-free

Coordination without global clocks

Neural networks with different inhibitory neuron classes can create an asynchronous temporal pipeline in excitatory neurons

- Fully asynchronous
- Every signal sends state information
- Scalable to any size circuit
- Require duplicate hardware and more complex circuits
- Can run at maximum speed when needed (no oscillations required)
- Can give rise to rhythms and mixtures of rhythms through emergent processes

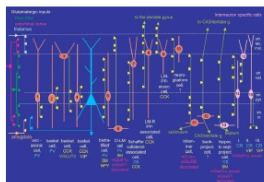

Defined types of cortical interneurons structure space and spike timing (Fig. Somogyi and Klausberger, 2005)

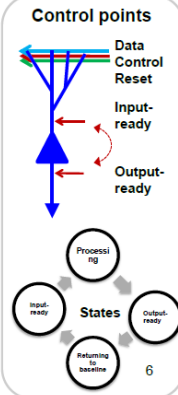

Grid-free: Simultaneous localization and mapping

Overhead view of environment



OpenRatSLAM map



iRAT: Neurobotic testbed

iRat
(intelligent rat animat technology)

PC on wheels

Size is the key challenge for the design of a robot that interacts with a rat

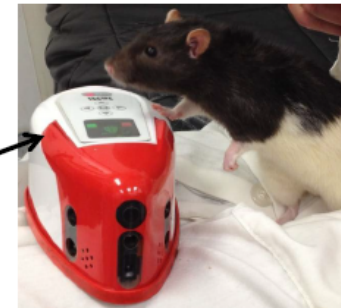

iRat meets Rat



Smith, DeMar, Yuan, Hagedorn and Ferguson, (2001) Delay-insensitive gate-level pipelining, *Integration, the VLSI Journal*, 30(2):103-131



Robust Intelligence in Complex Problem Solving

L. Kaelbling (MIT, EECS)



Objective: Develop algorithms that allow autonomous agents to perform long-duration tasks in complex and uncertain environments.

Technical approach: Formal A.I. methods for integrating logical and probabilistic reasoning.

DoD benefits: Robust and effective battle space planning, coordination, and surveillance in long-horizon, large-space, and uncertain domains.



L. Kaelbling



Laboratory testbed

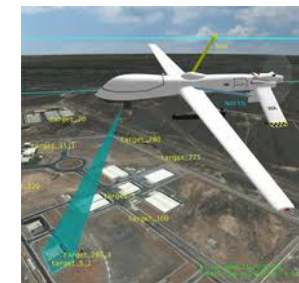

UAV mission

POMDP: Optimal solution is complex...

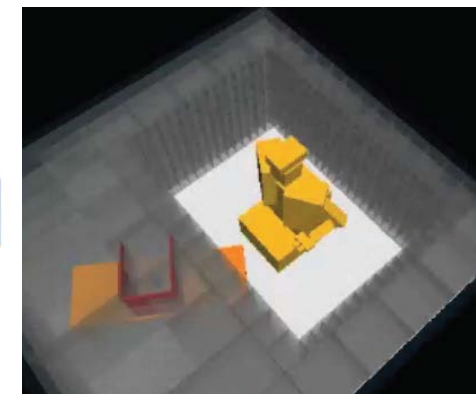
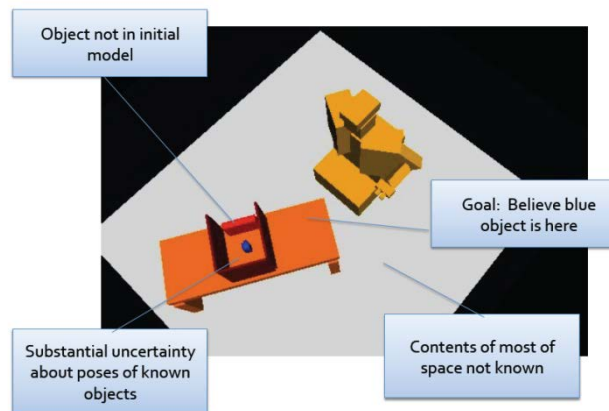
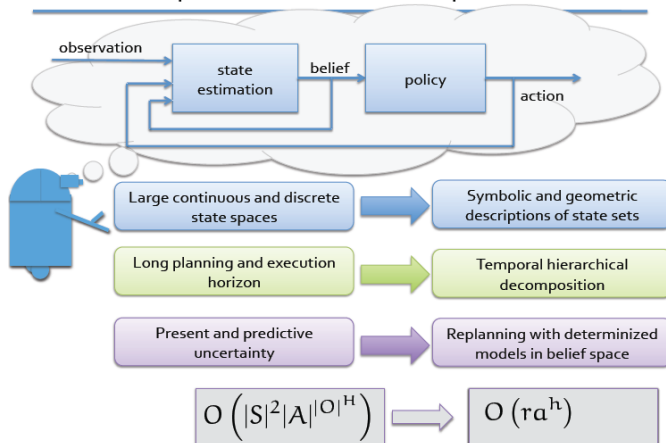



Interactions with Other Organizations



ONR (Paul Bello)

- **Perception, Metacognition, and Cognitive Control Program**

ONR (Tom McKenna)

- **Computational Neuroscience Program**

ARO (Janet Spoonamore)

- **Decision and Neurosciences Program**

NSF (Betty Tuller & Lawrence Gottlob)

- **Perception, Action, and Cognition Program**

DARPA (Gill Pratt)

- **Systems of Neuromorphic Adaptive Plastic Scalable Electronics (SyNAPSE) Program**

IARPA (Brad Minnery)

- **Integrated Cognitive-Neuroscience Architectures for Understanding Sensemaking (ICArUS) Program**



Transition



NICTA (Australia) team:

- Project on large-scale lifelong-learning optimization
- Recent visits by NICTA team to Air Mobility Command and US Transportation Command
- Access of real-world data: Huge benefits to model development
- Transition opportunities of basic research to help manage complex military logistics processes



T. Walsh

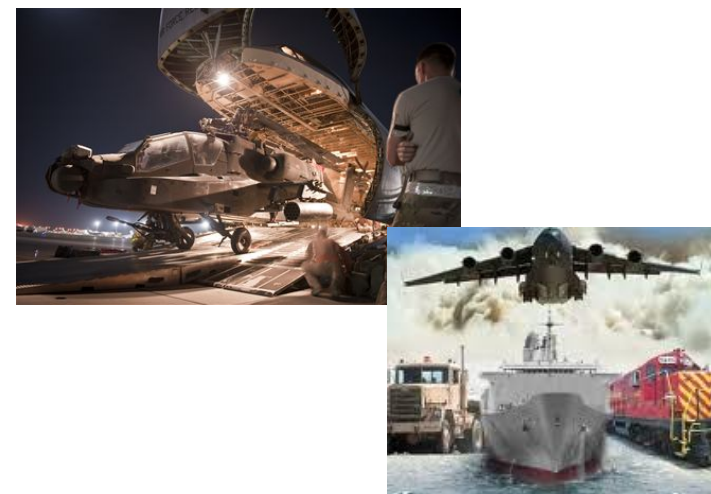
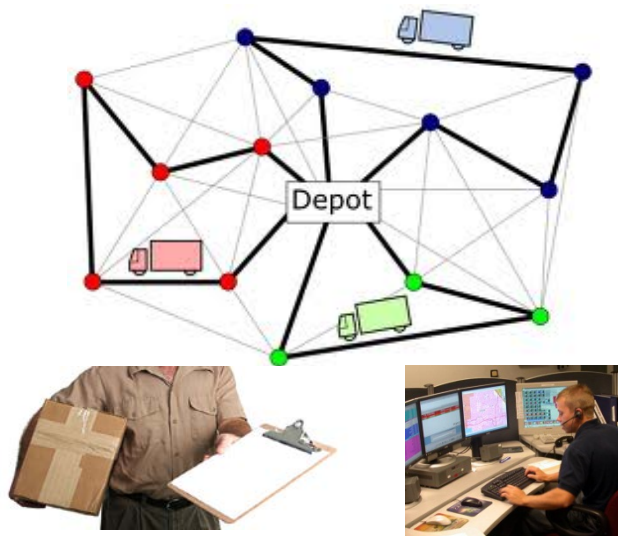



Recent Highlights



Korean Brain Science Initiative:

- AOARD initiative (PO: LtCol Brian Sells)
- Visit by AFOSR representatives to five Korean universities June 2012
- Four projects at SNU and KAIST co-funded with AOARD

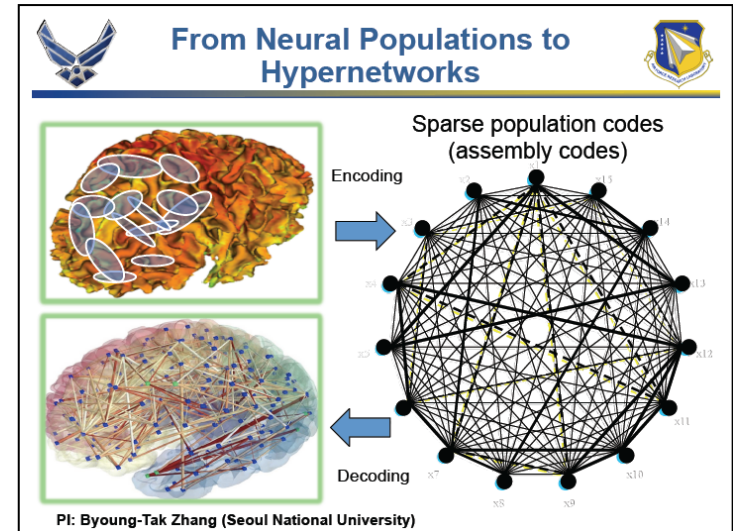

DARPA SyNAPSE Program:

- Design, fabrication, and demonstration of neuromorphic chips in real-world problems
- Ultra-low power consumption for ultra-high processing capacity
- Visit to IBM and HRL teams Oct 2012
- Intersection with Air Force Research Lab

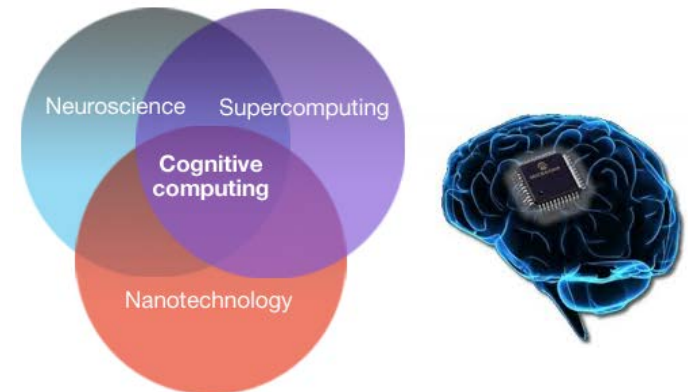



Questions?



Thank you for your attention

Jay Myung, Program Officer, AFOSR/RTC

Jay.myung@afosr.af.mil

(703) 696-8478