

FINAL REPORT

Environmentally Benign Aircraft Anti-Icing and Deicing Fluids
Based on Cost-Effective, Bio-Based Ingredients

SERDP Project WP-1678

SEPTEMBER 2012

S.P. Chauhan,
M.S. Roshon
Battelle

W.D. Samuels
PNNL

E.S. Berman
AFRL

This document has been cleared for public release



REPORT DOCUMENTATION PAGE*Form Approved*
OMB No. 0704-0188

Public reporting burden for this collection of information is estimated to average 1 hour per response, including the time for reviewing instructions, searching data sources, gathering and maintaining the data needed, and completing and reviewing the collection of information. Send comments regarding this burden estimate or any other aspect of this collection of information, including suggestions for reducing this burden to Washington Headquarters Service, Directorate for Information Operations and Reports, 1215 Jefferson Davis Highway, Suite 1204, Arlington, VA 22202-4302, and to the Office of Management and Budget, Paperwork Reduction Project (0704-0188) Washington, DC 20503.

PLEASE DO NOT RETURN YOUR FORM TO THE ABOVE ADDRESS.

1. REPORT DATE (DD-MM-YYYY) 12-09-2012		2. REPORT TYPE Final Technical Report		3. DATES COVERED (From - To) May 2009 - November 2012	
4. TITLE AND SUBTITLE Environmentally Benign Aircraft Anti-icing and Deicing Fluids Based on Cost Effective, Bio-based Ingredients				5a. CONTRACT NUMBER W912HQ-09-C-0026	
				5b. GRANT NUMBER N/A	
				5c. PROGRAM ELEMENT NUMBER N/A	
6. AUTHOR(S) Chauhan, S.P., Roshon, M.S.; Battelle Samuels, W.D.; PNNL Berman, E.S.; AFRL				5d. PROJECT NUMBER G006330	
				5e. TASK NUMBER 	
				5f. WORK UNIT NUMBER N/A	
7. PERFORMING ORGANIZATION NAME(S) AND ADDRESS(ES) Battelle Memorial Institute 505 King Avenue Columbus, Ohio 43201				8. PERFORMING ORGANIZATION REPORT NUMBER 	
9. SPONSORING/MONITORING AGENCY NAME(S) AND ADDRESS(ES) Strategic Environmental Research & Development Program 901 North Stuart Street, Suite 303 Arlington, Virginia 22203-1853				10. SPONSOR/MONITOR'S ACRONYM(S) SERDP	
				11. SPONSORING/MONITORING AGENCY REPORT NUMBER WP-1678	
12. DISTRIBUTION AVAILABILITY STATEMENT Approved for public release and distribution unlimited, except for Appendix B which is only available from USAF.					
13. SUPPLEMENTARY NOTES See final report for more details					
14. ABSTRACT By substituting several components to bio-based, more biodegradable, and less toxic ingredients, anti-icing fluids (AAFs) that are more environmentally friendly were achieved. Development of these fluids focused on the replacement of alkylphenol ethoxylate (APE) surfactants that are toxic, replacement of triazole corrosion inhibitors which are toxic and non-biodegradable, and replacement of non-biodegradable anti-precipitant. All three newly developed AAFs are free of APE surfactants and triazole compounds, contain a biodegradable anti-precipitant without a loss in performance, and are cheaper than currently used AAFs. These more environmentally-friendly ingredients had additional benefits such as a 50% reduction in ecotoxicity, the removal of an anti-foamer as the new surfactants were low foaming, a low gel forming potential, and performance that exceeded generic propylene glycol (PG)-based fluids currently on the market. Not only do these fluids provide excellent anti-icing, and enhanced environmental performance, they also perform similar or better to current commercial fluids in specialized DoD materials testing.					
15. SUBJECT TERMS Aircraft deicing fluid, aircraft anti-icing fluid, deicing fluid, anti-icing fluid, biodegradable, bio-based, freezing point depressants, biological oxygen demand					
16. SECURITY CLASSIFICATION OF:			17. LIMITATION OF ABSTRACT U	18. NUMBER OF PAGES 58	19a. NAME OF RESPONSIBLE PERSON S. Chauhan
a. REPORT U	b. ABSTRACT U	c. THIS PAGE U			19b. TELEPHONE NUMBER (Include area code) 614-424-4812

TABLE OF CONTENTS

	Page
LIST OF TABLES	iii
LIST OF FIGURES	iii
LIST OF ACRONYMS	v
KEY WORDS	vii
ACKNOWLEDGEMENTS	viii
ABSTRACT	1
1.0 OBJECTIVE	3
2.0 BACKGROUND	4
3.0 TECHNICAL APPROACH, MATERIALS, AND METHODS	6
3.1 APPROACH	6
3.1.1 Task 1. Improved Aaf Formulations	7
3.1.2 Task 2. Standard Anti-Icing Performance Testing	12
3.1.3 Task 3. Specialized Performance Testing	13
3.1.4 Task 4. Techno-Economic Assessment	13
3.1.5 Task 5. Improved ADF Formulations	14
3.2 MATERIALS AND METHODS	14
3.2.1 Viscosity vs. Temperature	14
3.2.2 Electrochemical Monitoring of Corrosion	16
3.2.3 Foaming Test	18
3.2.4 Hard Water Stability	18
3.2.5 Military Test Method Standard (MTMS)	19
4.0 RESULTS AND DISCUSSION	21
4.1 AAF FORMULATION	21
4.1.1 Water Spray Endurance Testing (WSET)	23
4.1.2 Aerodynamic Acceptance Testing	23
4.1.3 Freezing Point Depressants (FPDs)	25
4.1.4 PAA vs. Bio-based Thickeners	27
4.1.5 Replacement of Alkylphenol Ethoxylate (APE) Surfactant	31
4.1.6 Biodegradable Anti-precipitant	34
4.1.7 Selection of pH Modifier	38
4.1.8 Replacement of Triazole Corrosion Inhibitor	40
4.2 AAF MANUFACTURING PROCEDURE DEVELOPMENT	42
4.3 AAF PERFORMANCE TESTING	43
4.3.1 Level I Screening Tests	44
4.3.2 Level II Screening	44
4.3.3 Level III Screening	45
4.3.4 Material Test Method Standard (MTMS) Testing	46

4.3.5 Holdover Time (HOT) Testing	47
4.4 DOWN SELECTION OF AAFS FOR FIELD TESTING	50
4.5 IMPROVED ADF DEVELOPMENT	51
4.6 COST BENEFIT ANALYSIS FOR AAF	53
5.0 CONCLUSIONS AND IMPLICATIONS FOR FUTURE RESEARCH/IMPLEMENTATION	54
5.1 CONCLUSIONS	54
5.2 FUTURE RESEARCH AND TECHNOLOGY TRANSITION/IMPLEMENTATION	55
6.0 REFERENCES	56
7.0 APPENDIX	58
7.1 SUPPORTING DATA	58
APPENDIX A: AMS 1428 Specifications	
APPENDIX B: USAF Military Test Method Standard (MTMS) Testing	
APPENDIX C: AMS 1428 Certification for AAF	
APPENDIX D: Holdover Time (HOT) Report for AAF1 and AAF2	
APPENDIX E: Selected Results for Holdover Time (HOT) Testing of AAF3	
APPENDIX F: AMS 1424 Certifications for EcoFlo2 ADF	
APPENDIX G: Holdover Time (HOT) Results for EcoFlo2 ADF	
7.2 LIST OF TECHNICAL PUBLICATIONS	58

LIST OF TABLES

Table 1. WP-1678 Team.....	viii
Table 2. Components of ADF and AAF Fluids.....	8
Table 3. Selected PFDs for AAF Formulation.....	9
Table 4. AMS 1428 Groups of Tests.....	12
Table 5. MTMS Testing Parameters.....	19
Table 6. Screening List for Ingredients Other than Water.....	21
Table 7. Hard Water Testing Results at Various Anti-precipitant Levels.....	36
Table 8. Summary of Results of Corrosion Inhibitor Testing.....	42
Table 9. AAF Formulations Down-Selected for Level III Testing.....	46
Table 10. Summary of Materials Compatibility Testing of Battelle’s AAF1 and AAF2 Compared to Previously Tested Commercial Type IV AAF.....	47
Table 11. Endurance Time Testing for AAF1 and AAF2.....	48
Table 12. Type II Holdover Times.....	50
Table 13. EcoFlo <u>vs.</u> EcoFlo 2 Viscosity as a Function of Temperature.....	51
Table 14. Raw Material and Manufacturing Cost Comparison.....	53

LIST OF FIGURES

Figure 1. Comparison of Type I and Type IV Fluids Relative to Anti-icing Properties, as measured Water Spray Endurance Time (WSET) and Holdover Time (HOT).....	4
Figure 2. Typical Type I and IV Fluids and Spraying on Aircraft.....	6
Figure 3. Project Tasks.....	7
Figure 4. Freezing Point Curve for Glycerin-Water Mixture.....	9
Figure 5. Non-Newtonian (Pseudoplastic) Fluid Behavior for Type IV AAFs.....	10
Figure 6. Dependence of Viscosity as a Function of pH and PAA Concentration in Water.....	11
Figure 7. Viscosity <u>vs.</u> Temperature Testing Set-up.....	15
Figure 8. Typical viscosity <u>vs.</u> temperature curves for AAF at a low (0.06 sec ⁻¹) and high (1.26 sec ⁻¹) shear rate and ADF at a high (1.27 sec ⁻¹) shear rate.....	16
Figure 9. Electrochemical Potential Versus Current for i_{corr}	17
Figure 10. Typical LPR Curves for a Set of Forward and Reverse Scans.....	18
Figure 11. Typical 0.3 RPM Viscosity Curve for AAF.....	22
Figure 12. Typical 6 RPM Viscosity Curve for AAF.....	23
Figure 13. WSET Versus Viscosity at -5°C Relative to the 80 Minutes Minimum WSET for Type IV AAFs.....	24
Figure 14. BLDT Versus 6 RPM (1.66 sec ⁻¹ Shear Rate) Viscosity at -20°C Relative to the Maximum Specification Thickness.....	24
Figure 15. 0.3 RPM Viscosity <u>vs.</u> Temperature Curves for FPD Mixtures Containing Different Percentages of PG and Non-Glycol.....	26

Figure 16. 0.3 RPM Viscosity <u>vs.</u> Temperature Curves for FPD Mixtures Containing Different Percentages of PDO and Non-Glycol	27
Figure 17. Viscosity Versus Temperature Profiles of Three Thickeners.....	28
Figure 18. Effect of Thickener Concentration on Viscosity-temperature Profile for AAF-based on PG/Non-Glycol Mixture	29
Figure 19. Typical Rehydrated Gel Residue Weight (Note: Dry Residue Weight= 0.002g)	30
Figure 20. Results of AAF for Gel Residue Test.....	30
Figure 21. Rheological Behavior of No Surfactant Versus Associative Surfactant for AAFs at 0.3 RPM.....	31
Figure 22. Effect of Surfactant Concentration on Viscosity at 0.3 RPM	32
Figure 23. Effect of Addition of a Second Surfactant at 0.3 RPM Viscosity	33
Figure 24. Effect of Addition of a Second Surfactant at 6 RPM Viscosity	33
Figure 25. Molecular Structure of an EDTA	34
Figure 26. Effect of Anti-precipitant and Type on Rheology at 0.3 RPM.....	35
Figure 27. Effect of GL Concentrations on Rheology at 0.3 RPM.....	35
Figure 28. Effect of Acusol Concentration on Room Temperature Viscosity at 0.3 RPM	37
Figure 29. Effect of Acusol Concentration on Room Temperature Viscosity at 6 RPM	37
Figure 30. Effect of pH Modifier on Viscosity.....	38
Figure 31. Effect of pH on Viscosity at 0.3 RPM.....	39
Figure 32. Effect of pH on Viscosity at 6 RPM.....	39
Figure 33. LPR Measurements for Several Corrosion Inhibitor Candidates	41
Figure 34. Endurance Testing of Battelle AAF1 and AAF2 Compared to a Generic Type IV Fluid.....	49
Figure 35. Endurance Testing of Battelle AAF1 and AAF2 Compared to a Generic Type IV Fluid.....	49
Figure 36. COD Comparison of Typical Range for PG ADF Versus EcoFlo and EcoFlo 2	52
Figure 37. Acute Toxicity (LC ₅₀) for Fathead Minnow, 96 hours, for EcoFlo, EcoFlo 2, and Typical Range for PG-based ADFs.....	52

LIST OF ACRONYMS

AAF	Aircraft anti-icing fluid
ADF	Aircraft deicing fluid
AF	Air Force
AFMC	Air Force Materiel Command
AFRL	Air Force Research Laboratory
AMIL	Anti-icing Materials International Laboratory
AMS	Aerospace Material Specification
APC	Advanced Performance Coating
APE	Alkylphenol ethoxylate
APS	APS Aviation Inc.
ASC	Air Force Aeronautical Systems Center
BLDT	Boundary Layer Displacement Thickness
BOD	Biological Oxygen Demand
COD	Chemical Oxygen Demand
cP	Centipoise
CRREL	Corp of Engineers Cold Regions Research & Engineering Laboratory
DMG	Dimethyl glutarate
DMS	Dimethyl sebacate
DoD	Department of Defense
EDTA	Ethylenediaminetetraacetic acid
EG	Ethylene glycol
EPA	Environmental Protection Agency
ESTCP	Environmental Security Technology Certification Program
EO	Ethoxylate Unit
FAA	Federal Aviation Administration
FIE	First Icing Event
FPD	Freezing point depressant
F _{Pt}	Freezing point; first crystal
GFP	Gel forming potential
HE	Hydrogen embrittlement
HHET	High humidity endurance time
HOT	Holdover time
HVOF	High-velocity oxy-fuel
KOH	Potassium hydroxide
LO	Low observable
LPR	Linear polarization resistance
MPA	3-Methoxypropylamine
MTMS	Military Test Method Standard
NAS	National Academy of Sciences
NASA	National Aeronautics and Space Administration
PAA	Polyacrylic acid
PDO	1,3 Propanediol

PG	Propylene glycol
PNNL	Pacific Northwest National Laboratory
RDF	Runway deicing Fluid
REACH	Registration, Evaluation, Authorization and Restriction of Chemical
RPM	Revolutions per minute
SERDP	Strategic Environmental Research and Development Program
SON	Statement of need
SPO	System Program Office
TC	Transport Canada
TDC	Transport Development Centre
TEA	Triethanolamine
TRI	Toxic release inventory
WSET	Water spray endurance testing

KEY WORDS

- Aircraft Anti-icing Fluid (AAF)
- Aircraft Deicing Fluid (ADF)
- Bio-based anti-icing fluid ingredients
- Biological oxygen demand
- Freeze point depressants
- Non-triazole corrosion inhibitors
- Non-APE (alkyl phnol ethoxylate) surfactants
- Endurance time
- Holdover time (HOT)
- Military Test Method Standard (MTMS)

ACKNOWLEDGEMENTS

This project was conducted for the Strategic Environmental Research and Development Program (SERDP) by Battelle Corporate Operations (Battelle). Battelle's partners included the Department of Energy's Pacific Northwest National Laboratory (PNNL) and the Air Force Research Laboratory (AFRL).

The project was conducted under the programmatic guidance of Mr. Bruce Sartwell of the SERDP Program Office. Jeff Houff of HGL provided the primary SERDP project administration support.

The Project Manager and Principal Investigator was Dr. Satya P. Chauhan of Battelle. The members of the project team and their contributions are presented in Table 1.

Table 1. WP-1678 Team

Name	Organization	Project Activity
Dr. Satya Chauhan	Battelle	Aircraft Deicing/Anti-icing Fluid (ADF/AAF) formulation and evaluation; program management
Melissa Roshon	Battelle	ADF/AAF formulation and testing
Dr. Ramanathan Lalgudi	Battelle	Polymers, surfactants, and thickeners
Nick Conkle	Battelle	Cost-benefit analysis
Dr. William Samuels	PNNL	ADF/AAF formulation chemistry
Dr. Elizabeth Berman	AFRL	MTMS testing
Marc-Mario Tremblay	AMIL; University of Quebec at Chicoutimi	AMS 1424/1428 testing
Pat Viani	SMI Laboratories	AMS 1424/1428 testing
John D'Avirro	APS Aviation	Holdover time (HOT) testing
Mary Wyderski*	AF/ASC	ADF/AAF use in the AF
Dr. Charles Ryerson*	Army CRREL	ADF/AAF use in the Army
Raymond Wendrycki*	Navy/NAVAIR	ADF/AAF use in the Navy
Alex Meyers*	Octagon	Commercial ADF/AAF manufacturing
Tim Peyton*	LNT Solutions	Commercial ADF/AAF manufacturing

*Advisors to the project

ABSTRACT

This is the Final Report on SERDP Project WP-1678 “Environmentally Benign Aircraft Anti-icing and Deicing Fluids Based on Cost Effective, Bio-Based Ingredients.” The project began in May 2009, in response to the SERDP Statement of Need No. WPSO-09-05, for an Aircraft Anti-icing Fluid (AAF), with improved environmental and materials compatibility properties, while having the desired anti-icing properties.

OBJECTIVE

The objective of the project was to develop and evaluate an environmentally-friendly and low-residue Type IV AAF that is compatible with various Aircraft Deicing Fluids (ADFs), as well as aircraft materials. A second objective was to potentially further improve the performance of EcoFlo, a Battelle-developed ADF, based on the results from AAF development.

TECHNICAL APPROACH

The approach was to develop an AAF to meet the environmental, anti-icing, materials compatibility, and cost-effectiveness requirements, utilizing low-toxicity, bio-based, and biodegradable ingredients wherever possible. Both ADFs and AAFs are water-based formulations that are used for the removal (deicing) and the prevention (anti-icing) of snow, frost, or ice accumulation on the aircraft. Both fluid types are sprayed on the aircraft, providing a uniform coating that will shed off during take-off. The AAFs in this project utilize the same formulation strategies, including the use of bio-based ingredients, a low-foam wetting agent, reduced-corrosion anti-precipitant, and low-toxicity pH buffers and corrosion inhibitors, already demonstrated in the previous ADF-development efforts.

RESULTS

Three AAFs have been developed that meet the objectives of this project. By substituting several components to bio-based, more biodegradable, and less toxic ingredients, fluids that are more environmentally-friendly were achieved. Development of these fluids focused on the replacement of alkylphenol ethoxylate (APE) surfactants that are suspected endocrine disrupters, replacement of triazole corrosion inhibitors which are banned in Europe due to toxicity and their non-biodegradability, and replacement of non-biodegradable anti-precipitant. All three newly developed AAFs contain non-APE surfactants, non-triazole corrosion inhibitors, and a biodegradable anti-precipitant without a loss in performance. These more environmentally-friendly ingredients had additional benefits such as a 50 percent reduction in ecotoxicity, the removal of an anti-foamer as the new surfactants were low foaming, a low gel forming potential, and performance that is similar or better than generic propylene glycol (PG)-based fluids currently on the market.

Based on performance, the AAFs showed endurance times that are at least as good as for generic fluids and water-spray endurance test (WSET) times that exceeded the minimum of 80 minutes required for Type IV AAFs. Not only do these fluids provide excellent anti-icing, and greatly

enhanced environmental performance, they also perform similar to or better than current commercial fluids in specialized DoD materials testing. An additional benefit is that the raw material and manufacturing costs are less than the current AAFs on the market.

A second objective was met by leveraging research for these more environmentally-friendly ingredients for AAF and substitute them into a Type I fluid (ADF), called EcoFlo. This ADF was previously developed in an earlier SERDP project and is currently used on commercial aircraft. The improved ADF was fully certified to support field testing under an ESTCP project.

TECHNOLOGY COMMERCIALIZATION POTENTIAL

Based on the results to date, there are good prospects for commercializing at least one Type IV AAF and one Type II AAF. Both of these products are drop-in substitutes for currently used AAFs but are more environmentally-friendly and less costly. The involvement of several commercialization stakeholders in this project will help transition the technology to commercial use at U.S. military as well as civilian airports worldwide.

BENEFITS

The project findings were positive and the performance targets have been met or exceeded. The following are the anticipated benefits of the newly developed anti-icing/deicing fluids:

- Improved environmental properties by a reduction in aquatic toxicity by 50 percent, replacement of suspected endocrine disrupter APE surfactants, replacement of triazole corrosion inhibitors, and the replacement of non-biodegradable anti-precipitant.
- Introduction of bio-based freezing point depressants that produce a lower carbon footprint and a lower chemical oxygen demand (COD) and a lower, 5-day biological oxygen demand (BOD)₅.
- Enhanced performance with increased endurance time, WSET times that exceeded the minimum of 80 minutes required for Type IV AAFs, and materials compatibility similar or better than current PG-based fluids.
- Suitable as drop in replacement candidates for PG-based fluids with lower materials and manufacturing costs.
- Improved Type I fluid that has eliminated 75 percent of phosphates from original EcoFlo and maintained benefits of superior COD and ecotoxicity.
- Reduced freezing point of Type I ADF from -26°C to -41°C for a better operating range.

1.0 OBJECTIVE

The primary focus of the proposed project was to develop and evaluate an environmentally-friendly and low-residue Type IV Aircraft Anti-icing Fluid (AAF) that is compatible with various Aircraft Deicing Fluids (ADFs), as well as aircraft materials. A second objective was to potentially further improve the performance of EcoFlo, a Battelle-developed ADF, based on the results from AAF development. This new AAF would be superior to currently available AAFs in terms of one or more properties: (a) reduced BOD and chemical oxygen demand (COD); (b) reduced ecotoxicity; (c) reduced carbon footprint by using bio-based ingredients; (d) reduced tendency for leaving gel-forming residues; (e) reduced corrosivity; (f) free of alkylphenol ethoxylate (APE) surfactants; and (g) free of benzotriazole corrosion inhibitor. Additionally, this new AAF would need to be cost effective, compatible with ADFs, and compatible with military-unique aircraft materials and components.

The specifically targeted environmental properties improvements were as follows:

1. Replacement of APE surfactants, which are implicated in having biodegradation products that are endocrine disrupters;⁽¹⁾ these are banned in Europe and under close scrutiny in U.S.
2. Replacement of triazole compounds as corrosion inhibitors which also are banned in Europe and under close scrutiny in U.S.
3. Use of a biodegradable anti-precipitant
4. Reduced BOD and COD
5. Reduced carbon footprint
6. Reduced ecotoxicity.

Regardless of the environmental friendliness of the AAF, certain minimum requirements, in accordance with the Aerospace Material Specification (AMS) 1428, for anti-icing, aerodynamic, physical, and materials compatibility properties must be met. However, four additional targets for this project were as follows:

1. Reduced tendency for foaming, to allow elimination of an anti-foamer additive
2. Reduced tendency for leaving gel-forming residues
3. Improved compatibility with U.S. military-aircraft materials
4. A drop-in substitute AAF with same or lower formulation costs as the currently used AAFs.

The project had one Go/No-Go decision criteria of developing at least one AAF that had improved environmental and materials compatibility properties and was expected to pass AMS 1428 requirements.

2.0 BACKGROUND

Commercial airlines in the United States and Canada currently use a two-step aircraft deicing/anti-icing process. A Type I, Newtonian aircraft deicing fluid (ADF) is used to remove ice and snow as well as to provide a short-time anti-icing protection, also referred to as holdover time (HOT), under adverse weather conditions (e.g., 2 to 8 minutes below -3°C under moderate snow).⁽²⁾ In the case of adverse conditions, a Type IV, thickened, non-Newtonian aircraft anti-icing fluid (AAF) is applied, after Type I use, to provide an extended period (20 to 80 minutes) of anti-icing protection (see Figure 1). In Europe, the use of a single thickened fluid, called Type II, is more commonly used than the Type I/Type IV combination. When a Type II fluid is used, it is first diluted and heated for deicing, followed by use of undiluted, unheated fluid for anti-icing. The U.S. military, however, still primarily uses a Type I ADF, which results in extra personnel and chemical usage due to repeated Type I applications, and it otherwise reduces operational/launch capability in adverse weather conditions.

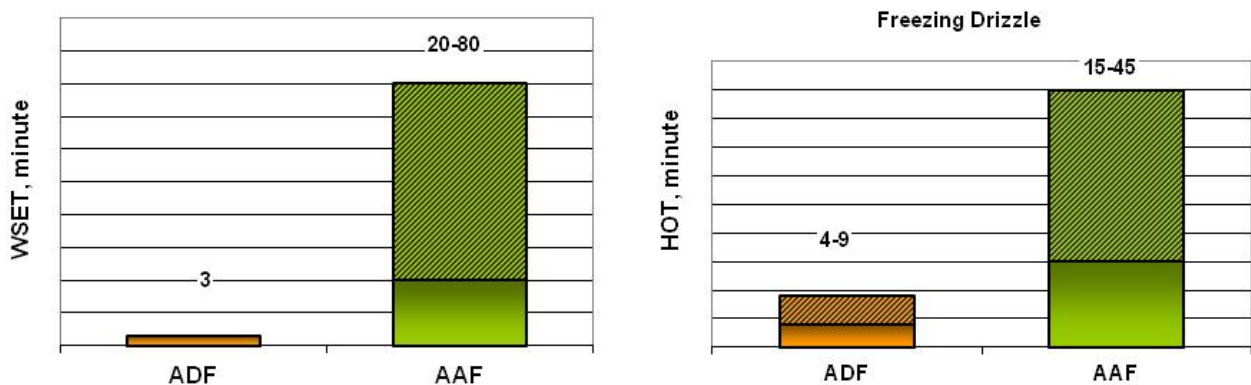

Figure 1. Comparison of Type I and Type IV Fluids Relative to Anti-icing Properties, as measured Water Spray Endurance Time (WSET) and Holdover Time (HOT)

The Aeronautical Enterprise Deicing Working Group, currently led by Mary Wyderski of AFMC/ASC, has one of its current objectives to achieve extensive use of aircraft anti-icing fluids (AAFs).⁽³⁾ In fact, the Canadian Department of Defense has flight tested and approved the use of AAFs for C130 and CP140 aircraft starting 2007/2008 Winter.⁽⁴⁾ Additionally, the C-17 SPO (System Program Office) of the U.S. Air Force (Aeronautical Systems Center, ASC) is working on the approval of propylene glycol (PG)-based AAFs for C-17s.

So, while the U.S. military regularly uses ADFs and desires to use AAFs, both types of commercially-available fluids are under U.S. Environmental Protection Agency (EPA) scrutiny. The EPA, in May of 2012, issued an effluent limitation guidelines for deicers used at U.S. Department of Defense (DoD) and commercial airports.⁽⁵⁾ The guidelines affect new airports and strongly encourage pollution prevention for ADF/AAF use at existing airports. The National Academy of Sciences (NAS) also recently funded a project, guided by a group of panelists including Dr. Satya Chauhan of Battelle, that has confirmed that both the high biological oxygen demand (BOD), and associated chemical oxygen demand (COD), as well as the toxicity of

currently available ADFs and AAFs is a concern.⁽⁶⁾ Additionally, there is a need to reduce the residue build-up from use of some commercially-available AAFs (Type IV fluids).⁽⁷⁾ Last, but not least, the currently used ADFs and AAFs have been shown to have poor compatibilities for some military-aircraft materials.⁽⁸⁾

This project (SERDP WP-1678) was therefore approved in response to a SERDP statement of need (SON) for an AAF with improved deicing, environmental, and materials compatibility properties. By replacing several ingredients considered to be problematic, in terms of environmental and materials compatibility, an improved fluid could be developed while maintaining desired anti-icing performance.

3.0 TECHNICAL APPROACH, MATERIALS, AND METHODS

3.1 APPROACH

This project was divided into several tasks in order to develop a promising AAF. Our approach to developing an AAF was to leverage the ADF technology previously developed by Battelle and supported by ESTCP to meet the environmental, deicing/anti-icing, materials compatibility, and cost-effectiveness requirements.⁽⁹⁻¹¹⁾ Both ADFs and AAFs are water-based formulations that are used for the removal (deicing) and the prevention (anti-icing) of snow, frost, or ice accumulation on the aircraft. Both fluid types are sprayed on the aircraft, providing a uniform coating that will shed off during take-off (see Figure 2).



Figure 2. Typical Type I and IV Fluids and Spraying on Aircraft

The AAFs in this project utilized strategies similar to the ones successfully used in the previous SERDP and ESTCP efforts on ADF and Runway Deicing Fluid (RDF) development. More specifically, the following strategies were used:

- Maximize the use of bio-based and biodegradable ingredients
- Use of lower molecular weight (C₃-C₅) polyols, covered by Battelle patents⁽⁹⁻¹⁰⁾
- Use of superior, multi-functional additives that minimize the number of additives so as to reduce corrosivity and toxicity of AAF
- Select lower toxicity ingredients utilizing published toxicity data as well as review of the Registration, Evaluation, Authorization and Restriction of Chemical (REACH) lists
- Select replacement ingredients with same or lower cost as the ingredients targeted for replacement (APE surfactants, non-triazole corrosion inhibitors, biodegradable anti-precipitant, etc).

The various tasks for this project and associated technical approaches are briefly described in Figure 3.

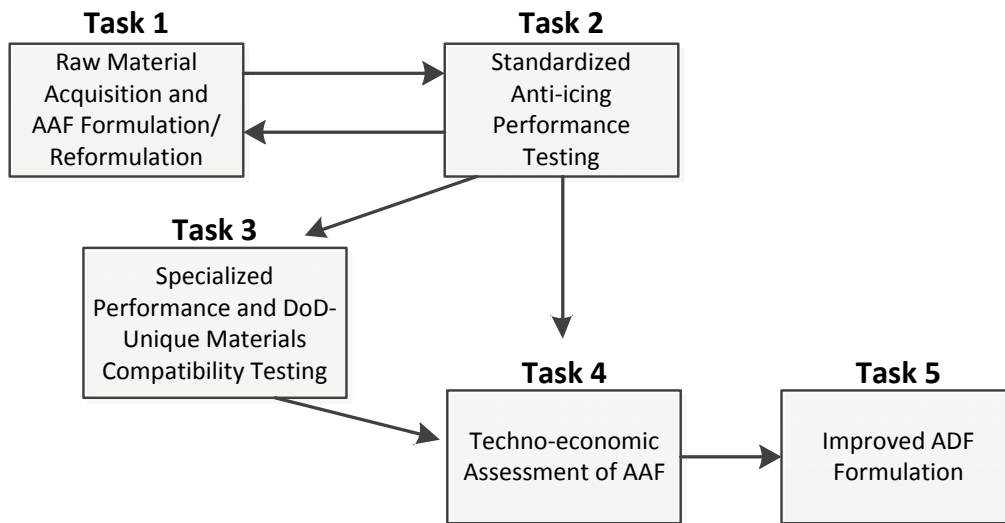

Figure 3. Project Tasks

3.1.1 Task 1. Improved AAF Formulations

Several ingredients are used to prepare AAF (Type IV) and ADF (Type I) fluids, as shown in Table 2. By individually researching and testing these components initially, then incorporating them into an AAF, effective and environmentally-friendly AAFs could be developed. Listed below are the key components of an AAF:

- Freezing point depressant (FPD)
- Thickener(s)
- Surfactant(s)
- Anti-foamer, if surfactants cause foaming
- Anti-precipitant
- pH control additive
- Corrosion inhibitor(s)
- Water.

The choice of FPD is the key determinant in reducing the 5-day BOD, or BOD₅, while the proper selection of additives helps reduce the ecotoxicity and provides acceptable anti-icing and materials compatibility properties. Based on previous work by Battelle on ADFs, the preferred choice for a wetting agent is a non-ionic, non-foaming surfactant that eliminates the need for an anti-foamer.

Table 2. Components of ADF and AAF Fluids

Component	ADF	AAF
FPD	x	x
Water	x	x
Surfactant(s)	x	x (multiple)
Anti-foamer	x	x
Anti-precipitant(s)	x	x
Thickener(s)	No	x (multiple)
Buffer/pH modifier(s)	x	x
Corrosion inhibitor(s)	x	x (multiple)
Colorant(s)	x	x

FPD Selection. The AMS 1428 requires the freezing point (FPt, i.e., the formation of the first crystal) of the AAF to be -32°C or lower in the undiluted form. When diluted at a ratio of 1:1, by weight with deionized water, the FPt should be -10°C or lower. On the other hand, the FPt of 1:1 diluted (by volume) of ADFs needs to be -20°C or lower. Therefore, the AAFs have a lower concentration of FPD in water. This provides an opportunity to use some less water-soluble or higher molecular weight polyols in the AAFs. This is because the FPt of solute (FPD)-solvent (e.g., water) mixtures depend on the mole fraction of the solute (FPD) and can be predicted from thermodynamics by the following equation:

$$\ln (y * x) = (-\Delta H_m/R) \left(\frac{1}{T} - \frac{1}{T_m} \right) \quad \text{Eq. (1)}$$

Where, y is activity coefficient, x is mole fraction of solute, ΔH_m is enthalpy of fusion (kJ/mol), R is ideal gas constant, T is melting point of the mixture, and T_m is melting point of the solvent.

The freezing point depression is expressed as $T_m - T$. The typical FPt curve for a glycerine-water mixture, for example, is shown in Figure 4. According to Eq. (1) above, lower molecular weight molecules are preferred for freezing point reduction, which is why the target FPDs for Battelle's ADFs and AAFs are C₃ - C₅ chemicals. Molecules smaller than C₃, such as ethylene glycol, are not suitable due to their toxicity or for being on the Toxic Release Inventory (TRI) list. Further, molecules larger than C₅, such as sorbitol or triethylene glycol, are typically poor candidates.

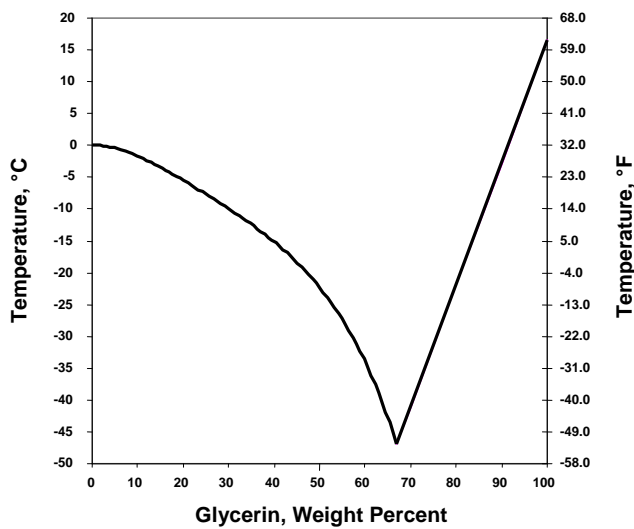

Figure 4. Freezing Point Curve for Glycerin-Water Mixture⁽¹²⁾

To select and utilize the lowest BOD/COD FPDs, the list of C₃ - C₅ chemicals can be further narrowed down by calculating the COD, which approximates the theoretical BOD for biodegradable chemicals. By considering the molecular weight, as suggested by Eq. (1), and by checking the COD, the most effective and lowest BOD FPDs can be targeted. Some examples are shown in Table 3.

Table 3. Selected FPDs for AAF Formulation

Chemical	Formula	Molecular Weight	COD kg O ₂ /kg	Comments
1,2,3 - Propanetriol (Glycerin)	C ₃ H ₈ O ₃	92	1.22	Thoroughly tested by Battelle in ADF & RDF; tested in this project
1,2 - Propanediol (PG)	C ₃ H ₈ O ₂	76	1.68	Currently used; tested in this project
1,3 - Propanediol (PDO)	C ₃ H ₈ O ₂	76	1.68	Available as bio-based; briefly explored in this project
Diethylene Glycol	C ₄ H ₁₀ O ₃	106	1.51	ADF available but mammalian toxicity a concern; not tested
Xylitol	C ₅ H ₁₂ O ₅	152	1.16	Briefly explored by Battelle; not tested in this project due to high cost

Based on molecular weight, COD (kg O₂/kg of chemical), availability, and cost, the following FPD candidates were tested:

- Bio-based 1, 2, 3-Propanetriol (glycerin)
- Petroleum-based 1,2-Propanediol (PG)
- Bio-based 1, 2-Propanediol (PG)
- Bio-based 1, 3-Propanediol (PDO).

Mixtures of FPDs sometimes provide a stronger, non-ideal solution behavior, which leads to a lower FPT and therefore lower BOD for achieving the same FPT. Similarly, the initial rate of biodegradation, indicated by BOD₅, can be affected without affecting the theoretical (long-term) BOD. Therefore, mixtures of these polyols were also explored for compatibility in AAFs.

Thickeners Selection. All AAFs (Type IV fluids) are non-Newtonian (pseudoplastic), as shown in Figure 5, while ADFs (Type I fluids, such as EcoFlo) are Newtonian. The shear-thinning behavior required for AAFs is typically achieved by using associative or particulate thickeners. Typical associative thickeners include polysaccharides such as xanthan gum, welan gum, or carraggenan gum.⁽¹³⁾ Examples of particulate thickeners include lightly cross-linked polyacrylic acid. Both types of thickeners contain large polymer chains that entangle to produce high viscosities. However, these interactions or entanglements are very weak, so they can be broken by molecular motion or shear. This ease of breakage leads to shear-thinning behavior.

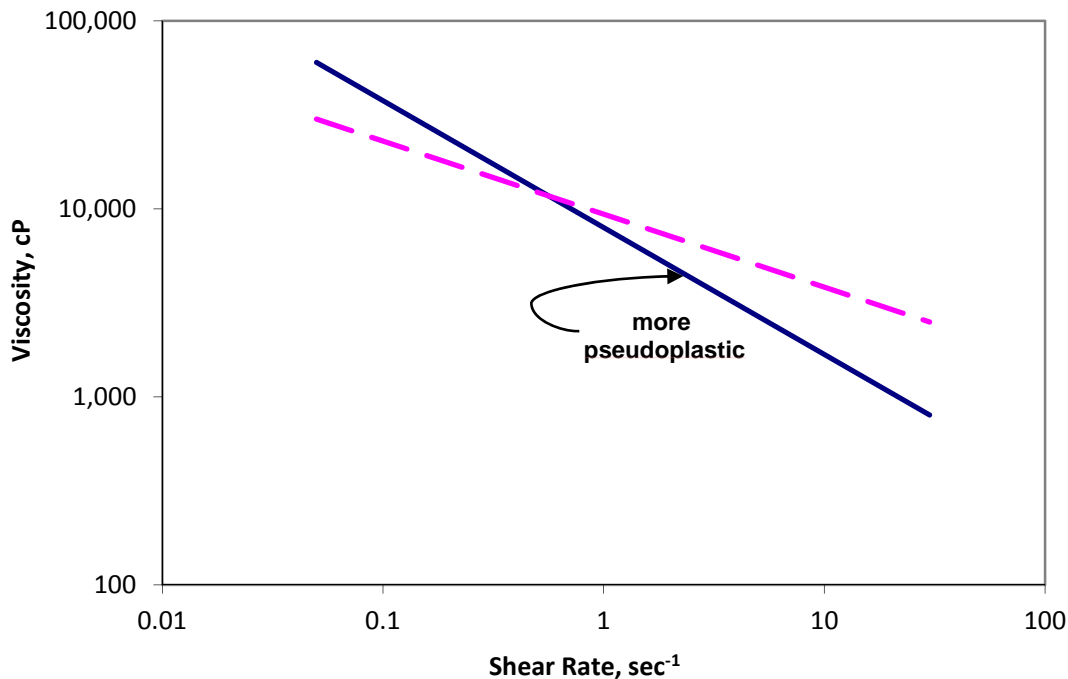

Figure 5. Non-Newtonian (Pseudoplastic) Fluid Behavior for Type IV AAFs

The National Aeronautics and Space Administration (NASA) had previously evaluated the use of xanthan gum for preparing Type II fluids that can be used as a single-step deicer/anti-icer, but

xanthan gum was not commercially successful due to the stickiness of its sucrose-based formulation.⁽¹⁴⁾

The currently used Type IV AAFs are believed to primarily use polyacrylic acid (PAA) polymer, stabilized by potassium hydroxide (KOH), as shown in Figure 6.

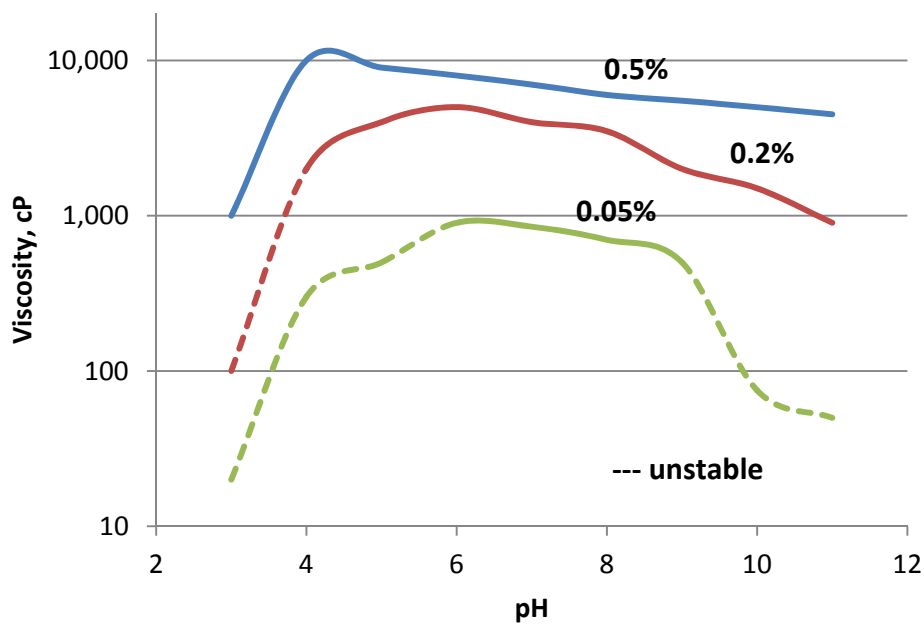

Figure 6. Dependence of Viscosity as a Function of pH and PAA Concentration in Water⁽¹⁵⁾

While there is some indication that the use of PAA-based thickeners in AAF might contribute to some toxicity, this is likely to be small compared to the potential toxicity contributions of other AAF additives.^(6, 16) Therefore, such a thickener is still a candidate along with the following polysaccharide candidates:

- Welan gum (provided by *Alcaligenes* species of bacteria in aerobic fermentations)
- Hydroxypropylmethyl cellulose (a non-ionic cellulose ether polymer)
- Xanthan gum (common food additive; to be employed at lower concentration than evaluated earlier for Type II AAF).

Based on literature reviews, only PAA and xanthan gum were explored.

Surfactants. A careful choice of a non-ionic surfactant, which helps with surface wetting, can further improve the rheological property through hydrophobic interaction with the thickener. Until now, the choice of surfactant was often an alkylphenol ethoxylate (APE), which produces biodegradation products that are suspected endocrine disrupters. Furthermore, these surfactants also produce foam, thus requiring an anti-foamer. The key focus was a low-foaming, non-APE surfactant.

Corrosion Inhibitors. A commonly used corrosion inhibitor is a triazole compound. These inhibitors are banned in Europe due to their toxicity and lack of biodegradability.⁽¹⁷⁾ We performed a literature search⁽¹⁸⁻³⁶⁾ and some screening for non-triazole containing inhibitors to find a suitable alternative.

Other Ingredients. Potential candidates for the other components were already established based on previous ADF work. The key focus here was to find a more environmentally-friendly, anti-precipitant than ethylenediaminetetraacetic acid (EDTA).

3.1.2 Task 2. Standard Anti-icing Performance Testing

The AAF formulations have to meet the specifications in AMS 1428. There are more than about 50 tests included in the specifications, as described in Appendix A. The various groups of tests and the key tests are summarized in Table 4 below.

Table 4. AMS 1428 Groups of Tests

Test Group	Key Tests
Anti-Icing Performance	<ul style="list-style-type: none"> • Water Spray Endurance Time (WSET) • High Humidity Endurance Time (HHET)
Aerodynamic Acceptance Qualification	<ul style="list-style-type: none"> • Viscosity <u>vs.</u> Temperature and Shear Rate (Rheology) • Boundary Layer Displacement Thickness (BLDT)
Fluid Stability	<ul style="list-style-type: none"> • Thin Film Thermal Stability • Successive Dry-Out and Rehydration • Hard Water Stability • Storage Stability
Physical Properties	<ul style="list-style-type: none"> • Flash Point • Freeze Point • Specific Gravity • Refractive Index • Surface Tension
Environmental Information	<ul style="list-style-type: none"> • BOD and COD • Biodegradability • Aquatic Toxicity • Trace Metals
Effect on Aircraft Materials	<ul style="list-style-type: none"> • Sandwich and Immersion Corrosion • Hydrogen Embrittlement (HE) • Stress Corrosion Cracking • Effect on Transparent Plastics
Effect on Other Materials	<ul style="list-style-type: none"> • Effect on Painted and Unpainted Surfaces • Runway Concrete Scaling Resistance

The AAF formulations were screened through various tests specified under AMS 1428, some of which were pre-tested at Battelle, using a multi-tiered approach, as discussed below.

Level I Screening. The initial formulations were evaluated for (a) FPt, (b) viscosity at various shear rates and temperatures (rheology), (c) BOD₅ at 20°C, (d) ecotoxicity, and (e) foaming. We were able to predict FPt, BOD₅ and ecotoxicity based on published data and theoretical modeling. The key focus was on AAF rheology as a function of temperature and fluid composition. Some foaming tests were also performed to determine the need for an anti-foamer.

Level II Screening. The down-selected formulations were refined, as necessary, and retested for Level I as well as following additional tests: (a) hydrogen embrittlement (HE), (b) cadmium (Cd) corrosion, (c) sandwich and immersion corrosion, (d) gel-forming residue, and (e) Water Spray Endurance Testing (WSET). Successful testing of at least one AAF at this stage was needed to support a Go/No-Go milestone, which was met.

Level III Screening. Additional screening (Level III) was conducted during the second half of the project to cover various tests under AMS 1428 on down-selected AAFs.

3.1.3 Task 3. Specialized Performance Testing

Previous ADF development efforts had established that AMS-related testing leads to certification of fluid, but other tests are still necessary to achieve successful implementation. The following such tests were therefore performed on the best AAF formulations, based on Level III testing and a preliminary economical analysis.

Spray Testing. This is a short (4-hour) test during which a commercial spray truck, fitted with both ADF and AAF tanks and spray nozzles, sprays the fluid on a portion of a wing. Such testing is to be conducted in Winter of 2012 by one of our industrial partners.

MTMS Testing. The AFRL led the MTMS testing by using the two preferred AAFs. Battelle and the AFRL jointly finalized the tests to be performed.

Holdover Time (HOT). The holdover time (HOT) testing is a very elaborate testing protocol that is carried out by APS Aviation, under the oversight of Transport Canada every spring. Three AAFs and one ADF were tested.

3.1.4 Task 4. Techno-economic Assessment

The development of a cost-effective ADF/AAF combination with superior environmental and material compatibility properties is critical to its acceptance at DoD and commercial airports. While the beneficial impact of BOD and toxicity reduction might be substantial for airport owners, the airlines pay for the fluids and, therefore, seek the lowest cost fluids. An environmentally superior or even a less corrosive ADF/AAF combination at a higher cost is not acceptable. The techno-economic impact of composition and formulation techniques on production, implementation, and use was assessed in this task.

3.1.5 Task 5. Improved ADF Formulations

This task was established since it was possible that the AAF efforts might lead to an improved-ADF. Indeed, an improved EcoFlo ADF with alternative ingredients was formulated and fully certified under AMS 1424 and associated HOT testing.

3.2 MATERIALS AND METHODS

As discussed in Subsection 3.1.2, all AAFs have to meet the AMS 1428 specifications. In addition, a number of special tests were conducted mostly in Battelle's laboratories, to help screen various AAF ingredients. These tests were as follows:

- Viscosity vs. temperature, during continuous chilling, at two shear rates
- Electrochemical monitoring of corrosion
- Foaming test
- Hard water stability test adapted from the specification in AMS 1428
- Military Test Method Standard (MTMS).

The details of these tests are provided below.

3.2.1 Viscosity vs. Temperature

Prior to testing any AAF fluid for environmental, physical, or WSET, a viscosity vs. temperature (referred to as a continuous-chill curve) was obtained for the formulation to determine a fluid's rheological behavior, and thus judge its anti-icing and aerodynamic acceptance properties. A chill curve measures the viscosity of the fluid at a given shear rate and at various temperatures, while the sample is being chilled. In this manner, viscosity at more than about 20 temperatures can be measured in about an hour.

A Brookfield LVII+ Pro equipped with WinGather software was used to perform viscosity measurements. Calculations are based on a spindle that rotates in a pool of fluid at a given velocity (RPM), which correlates with a shear rate (sec^{-1}). The viscometer measures the stress on the rotating spindle and thus calculates the viscosity. Various size spindles are provided by Brookfield for use with different range of viscosities. This type of a viscometer is prescribed in the AMS 1428, although the specification only calls for measurements at three shear rates and discrete temperature values.

The samples are chilled using a Kinetics Thermal System immersion chiller equipped with a flexible probe that chills a methanol bath down to desired temperature. A schematic of the system is shown in Figure 7. This viscosity measurement device was built similar to the one successfully used for over 5 years by one of our industrial partners, Clariant, which is the primary supplier of aircraft deicing/anti-icing fluids to U.S. Air Force.



Figure 7. Viscosity vs. Temperature Testing Set-up

Examples of a few different chill curve profiles are shown in Figure 8. There is a major difference among these chill curves as the thickener used will produce a different type of profile. This profile can be adjusted by altering components or the concentration of those components used in AAFs. Over 300 chill curves at 0.3 RPM (0.06 sec^{-1} shear rate) and 6 RPM (1.26 sec^{-1} shear rate) were obtained. The 0.3 RPM rheology, referred to as “AAF @ low shear” in Figure 8, can be related to the WSET (anti-icing) requirements in AMS 1428 and is representative of a “still” aircraft. While the 6 RPM rheology, referred to as “AAF @ high shear” in Figure 8, can be related to meeting aerodynamic (related to “lift loss” during aircraft take-off) requirements.

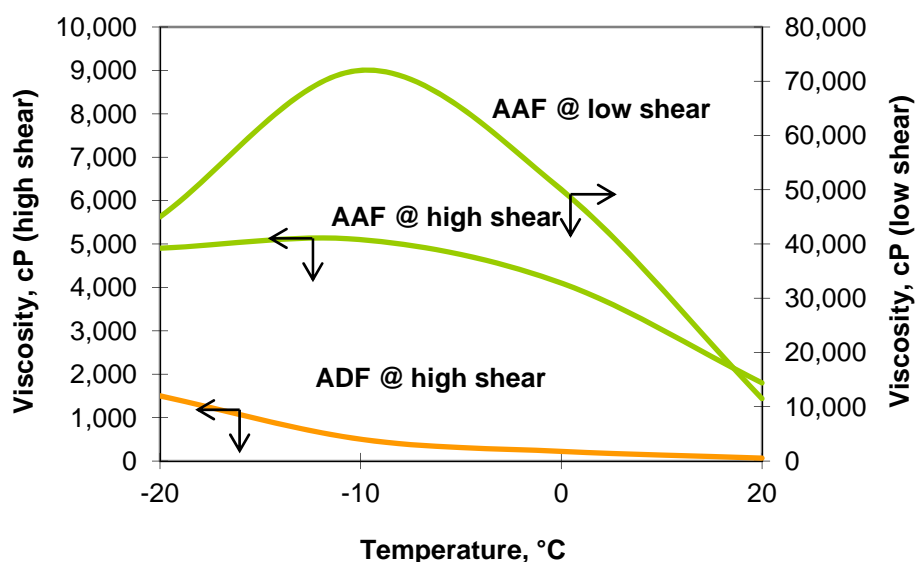

Figure 8. Typical viscosity vs. temperature curves for AAF at a low (0.06 sec^{-1}) and high (1.26 sec^{-1}) shear rate and ADF at a high (1.26 sec^{-1}) shear rate.

The advantage of this device is that we could continuously measure the viscosity at a given shear rate while the sample is cooled. In this manner the cost of measurement was reduced by an order of magnitude. When an aircraft anti-icing fluid (AAF) is certified under AMS 1428, however, additional measurements at several temperatures were performed and reported.

3.2.2 Electrochemical monitoring of corrosion

In collaboration with The Ohio State University, a laboratory scale test method was used to determine the relative corrosivity of AAFs towards cadmium plating used on hydrogen embrittlement (HE) test coupons. The HE test is quite long and expensive, hence a screening method was deemed necessary to guide the selection of preferred corrosion inhibitors. In the test method, electrochemical current and potential were measured and continuously recorded. The i_{corr} values (corresponding to the corrosion potential) were calculated by first normalizing all currents by the area of the electrode used in the given test (on the order of 0.2 to 0.3 cm^2). The electrochemical potential (E_{corr}) was plotted vs. the log of the normalized current (i) or current density. Portions of linearity near E_{corr} on both the anodic and cathodic curves were extrapolated and the current density at which they intersect was reported as i_{corr} . An example of these curves is shown in Figure 9. Samples containing a variety of corrosion inhibitors were measured using Cadmium metal.

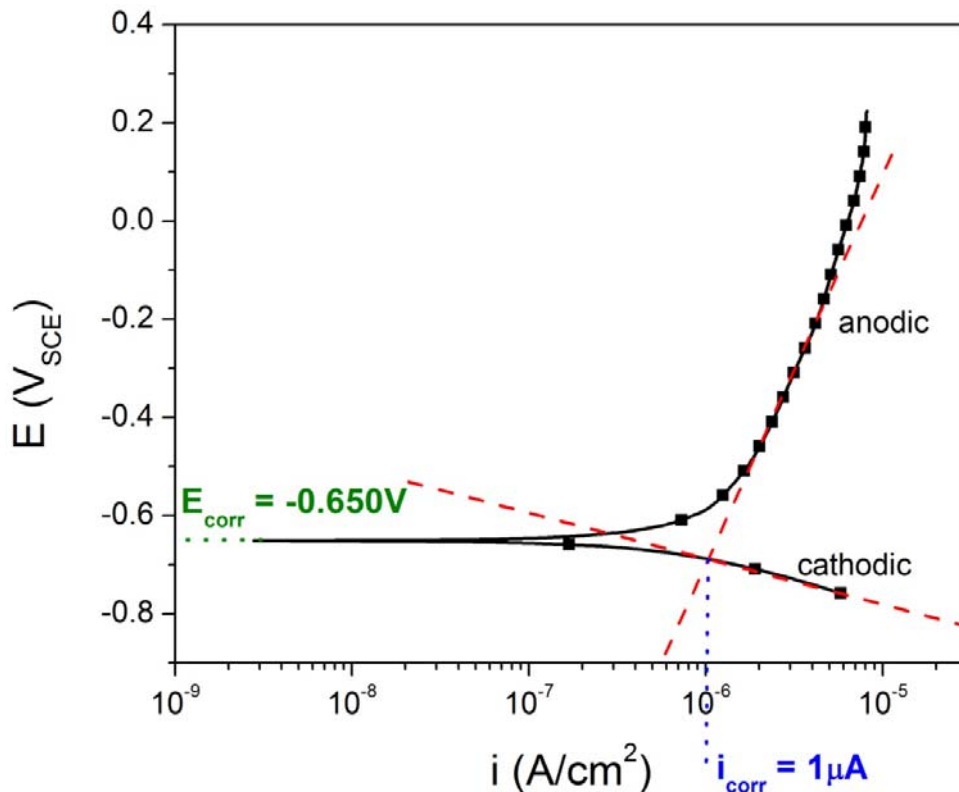

Figure 9. Electrochemical Potential vs. Current for i_{corr}

Linear Polarization Resistance (LPR) is similar to Potentiodynamic Polarization except a potential scan is limited to -15 mV from the cathodic region to +15 mV toward the anodic region which minimizes damage to the sample and quickly provides instantaneous corrosion rates. The i_{corr} and corrosion rates are calculated using the slope of the current vs. potential scans. Multiple scans can be conducted automatically to measure corrosion rate as function of time. An example of such a test, carried out at Battelle's laboratories, is shown in Figure 10.

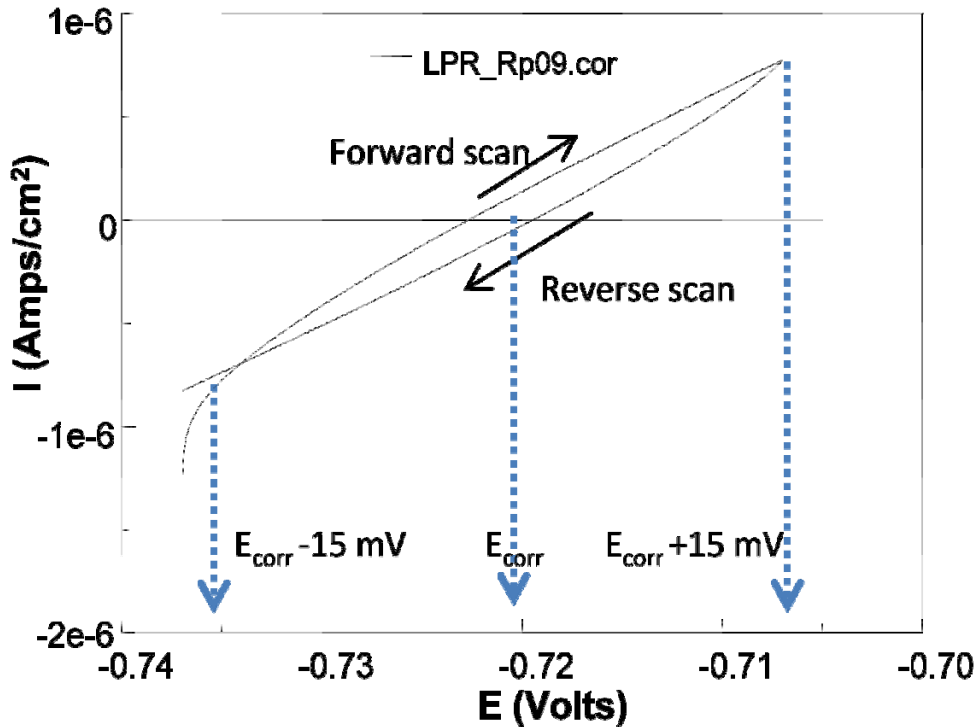

Figure 10. Typical LPR Curves for a Set of Forward and Reverse Scans

3.2.3 Foaming Test

According to AMS 1428 the fluid must not cause excessive foaming in its intended use; however, there is no standard test specified. Based on the experience with EcoFlo ADF, Battelle performed several tests to determine whether the fluid would be acceptable. The first test is to vigorously shake the fluid and note any foaming that might occur and observe how quickly the foam collapses if foam is produced. This test is also used on a fluid that has been diluted 1:1, by volume. Another valuable test includes pouring the AAF, neat, and in diluted concentrations, over aluminum metal panels after being subjected to a high shear mixing. Foam collapse is also noted in this test, as well as how well the fluid coats the panel to provide adequate protection against possible ice formations.

3.2.4 Hard Water Stability

This laboratory test closely follows the procedure dictated in AMS 1428, but does not include testing for WSET after hard water testing. The AAF is diluted 1:1 by volume with ASTM hard water and held at 95°C for 30 days. The appearance of insoluble deposits in the fluid, after set time periods, is considered a failure or a change in 1.0 units of pH compared to an unheated reference sample. In the laboratory tests at Battelle, the samples were typically held at 95°C for over about one week, even though any precipitation typically forms between a few hours to 1 to 2 days after heating. After the one week period the pH was also measured and compared to the unheated reference. If less than 1.0 units of pH change had not been reached after one week the sample was returned to the 95°C oven for the remainder of the 30 day period and re-tested.

3.2.5 Military Test Method Standard (MTMS)

Two preferred AAFs were tested by AFRL using different materials specific to the U.S. military. The material types and the procedures shown in Table 5, described further in Appendix B, were tested. This is not a full set of tests in MTMS testing; rather, these are the tests that Battelle and AFRL have previously found to be the critical ones.⁽³⁷⁾

Table 5. MTMS Testing Parameters

Test Category	Substrate Material	Testing Procedures (to be performed on each substrate)
Metallic Materials	A286 steel (AMS 5731)	<ul style="list-style-type: none"> • Alternate Immersion (ASTM G-44 Modified) • Stress Corrosion Cracking (ASTM G-44 Modified)
	Al-bronze C99300 (AMS 4640–close rep)	
	AZ91E-T6 cast Mg (AMS 4446A)	
	7075-T6 bare Al (AMS 4045H)	
	4140 steel (AMS 6395)	
Elastomeric Materials	Nitrile Sheet Material (MIL-R-6855 Class I)	<ul style="list-style-type: none"> • Ultimate Tensile Strength (SAE 5127/1) • Percent Elongation (SAE 5127/1) • 100% and 300% Modulus (SAE 5127/1) • Peel Strength (SAE 5127/1) • Shore A Hardness (ASTM D2240) • Percent Volume Swell (MTMS method)
	Neoprene Sheet Material (MIL-R-6855 Class II)	
	Polysulfide Sealant (MIL-S-8802 Type I)	
	Corrosion-Inhibiting Sealant (MIL-PRF-81733D)	
	Polythioether Sealant (AMS-3277)	
	High Temp Polysulfide Sealant (AMS-3276C)	
	Fluorosilicone Sealant (AMS-3375)	
Aircraft Wire Insulation	Polyimide (MIL-W-81381/11-20)	<ul style="list-style-type: none"> • Conductivity (MTMS method, EPA 120.1) • Immersion – Swell (SAE 4373, TM 601) • Bend Test (SAE 4373, TM 714) • Voltage Withstand Test (SAE 4374, TM 5.10, ASTM 3032)
	Teflon (MIL-W-22759/11-20)	
	Hybrid Construction (MIL-W-22759/86-20)	
	Cable-insulated twisted pair (MIL-W-22759)	
Infrared (IR) Window Materials	Aluminum Oxynitride (ALON)	<ul style="list-style-type: none"> • Change in Infrared Transmission (MTMS method)
	Sapphire – uncoated	

Table 5. MTMS Testing Parameters (continued)

Test Category	Substrate Material	Testing Procedures (to be performed on each substrate)
Low-Observable (LO) Coatings	MS-133 Outer Mold Line Primer – PRC	<ul style="list-style-type: none"> • Pencil Hardness (ASTM D3363) • Tape Adhesion (ASTM D3359, “A” and “B”) • Fluid Uptake (ASTM D570)
	MS-424 Inner Mold Line Primer – Deft	
	MS-484 Anti-Static Rain Erosion Urethane – CAAP CO	
	MS-485 Rain Erosion Urethane – CAAP CO	
Lubricants and greases	MIL-PRF-32014 (PAO-based grease)	Humidity Test (ASTM D1748)
	MIL-PRF-81322 (PAO-based grease)	
	MIL-PRF-27617 (PFPAE-based grease)	
	MIL-PRF-83261 (silicone oil-based grease)	
	MIL-PRF-87257 lubricant	
	MIL-PRF-83282 lubricant	
	MIL-PRF-5606 lubricant	
	MIL-PRF-7808 lubricant	
Cannon Electrical Plug Pins	MIL-STL-38999 Series III Subminiature Cylindrical Type Connectors	<ul style="list-style-type: none"> • Insulation Resistance (MIL-STD-1344A, 3003.1) • Shell-to-shell Conductivity (MIL-STD-1344A, 3007) • Immersion (MIL-STD-1344A, 1016) • Dielectric Withstanding Voltage Test (MIL-STD-1344A, 3001.1)
High Velocity Oxygen Fuel (HVOF) Coating	83% WC-17% Co HVOF-coated 4340 rods	<ul style="list-style-type: none"> • Alternate Immersion (ASTM G44 Modified) • Humidity Testing (ASTM D1748-02)
Standard Aircraft Coating	MIL-PRF-23377 primer	<ul style="list-style-type: none"> • Tape Adhesion (ASTM D3359) • Pencil Hardness (ASTM D570)
	MIL-PRF-85285 Type IV Advanced Performance Coating (APC)	

4.0 RESULTS AND DISCUSSION

During this project, a variety of freezing point depressants have been explored based on Battelle's patents using C₃-C₅ polyols.⁽⁹⁻¹⁰⁾ Using knowledge gained in previous research for the development of ADFs and runway deicing fluids (RDFs), several improved additives were identified and tested for AAFs. Initial exploration into understanding Type IV fluid properties and how to formulate an environmentally improved AAF proved challenging, as several components can simultaneously affect multiple properties of an AAF. By replacing alkylphenol ethoxylate (APE) type surfactants with more environmentally-friendly alternatives, such as alcohol ethoxylates, as well as replacing more toxic corrosion inhibitors, such as triazoles, the environmental friendliness of an AAF can be improved significantly.

4.1 AAF FORMULATION

The efforts in this project showed that only a handful of surfactants and corrosion inhibitors are suitable for balancing the various required properties of AAFs. These components have been incorporated into fluids and tested for properties such as corrosion rate, aerodynamics, and overall effectiveness as an anti-icer. Over three hundred different AAF formulations have been prepared and evaluated. This large number of tests was necessary to provide adequate parametric information on AAFs and was needed to screen a number of ingredients. All fluids prepared and evaluated were prepared as complete formulations, comprising of all needed additives; this was necessary since most additives affect multiple properties, sometimes in unpredictable ways. Table 6 shows the number of ingredients that have been evaluated since the beginning of the project.

Table 6. Screening List for Ingredients Other than Water

Ingredient	# Evaluated	# Acceptable	Selected for Final Testing
FPD	5	3	1 PG based and 1 non-glycol
Thickener	3	1	1
Surfactant	35	5	1 single and 1 mixed
Anti-precipitant	3	2	1
pH modifier	2	1	1
Corrosion Inhibitor	12	2	2
Anti-foamer	1	1	Eliminated since surfactant(s) were low-foaming
Colorant	1	1	1

We found early on that, out of the 50+ tests in AMS 1428, the three most critical ones were: (a) WSET, (b) aerodynamic acceptance, and (c) hydrogen embrittlement (HE). Furthermore, the WSET and the aerodynamic properties appeared to be highly dependent on the AAF rheology. Therefore, the first important test used in the laboratory was rheological testing or the generation of chill curves. A description of this test was provided in Subsection 3.2.1. Chill curve measurements were used to estimate how these potential fluids will perform relative to WSET and aerodynamics. Results from two different speeds were used: 0.3 RPM for WSET and 6 RPM for aerodynamics. While an acceptable WSET requires a high enough viscosity at 0.3 RPM, an acceptable aerodynamic performance requires a low enough viscosity at 6 RPM. In other words, the fluid viscosity needs to drop quickly with increasing shear rate. A desired chill curve shows a rapid increase in viscosity upon cooling that eventually levels off into stable viscosity readings or drops in viscosity at temperatures below -5°C . With focusing mainly on rheological affects, the overall viscosity, location of maximum viscosity, and break in the curve are all important factors when determining which formulations were to be explored further. The results showed that a small change in the composition of additives could have a large impact on viscosity vs. temperature curves.

A typical set of 0.3 RPM and 6 RPM viscosity (chill) curves are shown in Figure 11 and Figure 12. The drop in viscosity below about -5°C to -10°C is a result of the special properties of the surfactant and thickener combination we have discovered. Several fluids have been successful at passing both the WSET and aerodynamics testing. Other factors besides viscosity also have an effect on fluid performance. The results for WSET and aerodynamics are further described below.

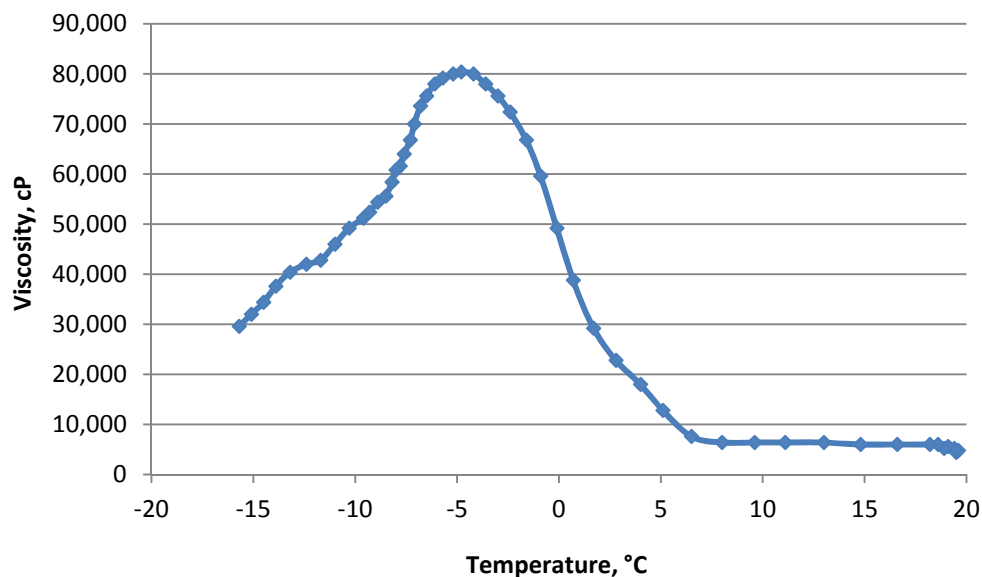

Figure 11. Typical 0.3 RPM Viscosity Curve for AAF

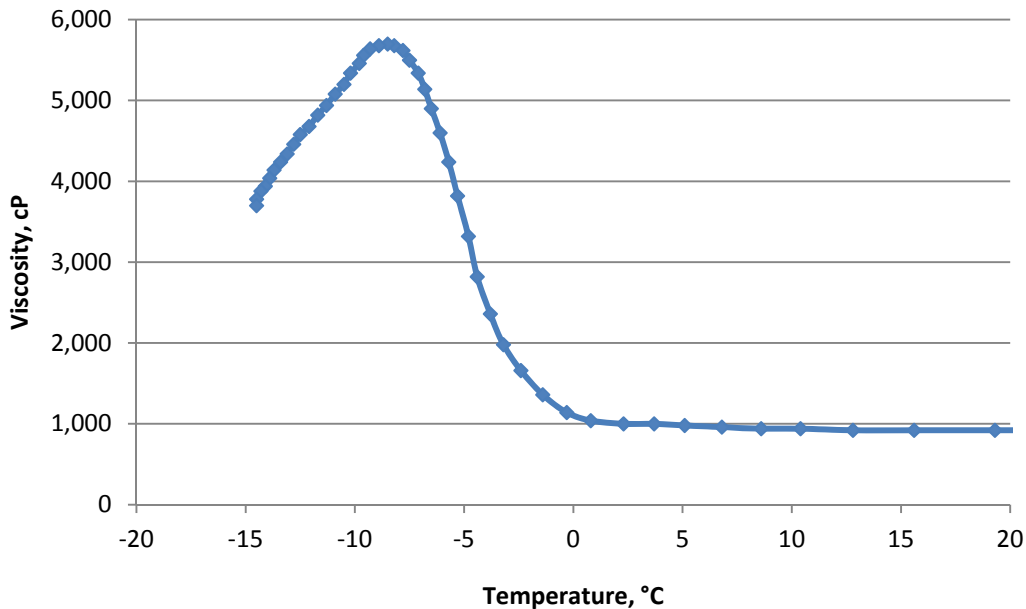

Figure 12. Typical 6 RPM Viscosity Curve for AAF

4.1.1 Water Spray Endurance Testing (WSET)

This test simulates precipitation exposure to an aircraft at temperatures below 0°C. The requirements of this test for a Type IV AAF are to have a first icing event (FIE) or “failure” above 80 minutes when measured at -5°C. A total of 24 AAF formulations were tested for WSET. Several formulations had FIE measurements above 100 minutes. The results suggest that, in order for our fluids to meet this WSET requirement, chill curve measurements are taken at 0.3 RPM and should have a peak viscosity between 0°C and -10°C and measure in at least 50,000 centipoise (cP) range, as shown in Figure 13. Any fluid with a viscosity greater than 70,000 cP can pass WSET testing, but tends to make passing the aerodynamic test more difficult and requires a fluid to be more pseudoplastic. The 0.3 RPM speed is used because it refers to the shear the fluid would be exposed to after being sprayed on the aircraft with the aircraft sitting on the runway.

4.1.2 Aerodynamic Acceptance Testing

Aerodynamic testing is a key requirement of AMS 1428. This test measures the Boundary Layer Displacement Thickness (BLDT), which simulates the lift loss during take-off, after most of the fluid has been sheared off. For research purposes, only three temperatures were measured: 0°C, -10°C, -20°C. For full certification, the AAF is additionally tested at the lowest temperature below -20°C that the fluid just passes at. A total of 23 AAF formulations were tested for aerodynamic acceptance. The results suggest that the maximum viscosity at 6RPM should be below about 5,000 cP at -20°C to pass the aerodynamic requirements, as shown in Figure 14. The 6 RPM speed simulates an aircraft take-off and is approximately the shear rate a fluid would be exposed to, which requires at least 75 percent of the fluid to shed from the wings.

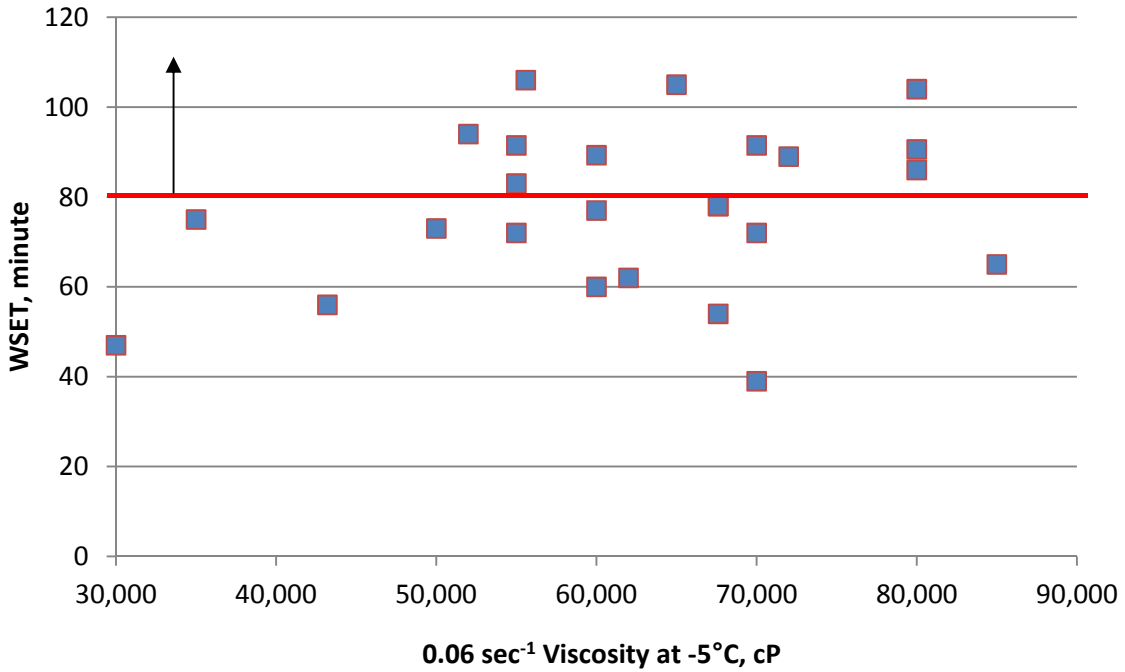

Figure 13. WSET vs. Viscosity at -5°C Relative to the 80 Minutes Minimum WSET for Type IV AAFs

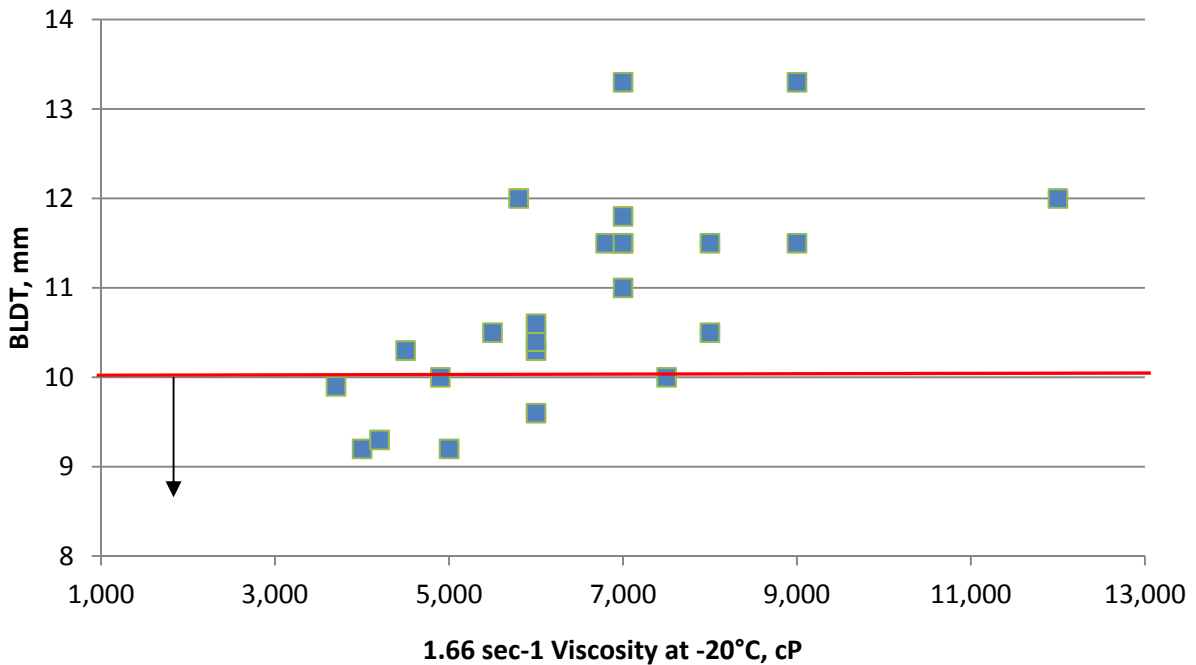

Figure 14. BLDT vs. 6 RPM (1.66 sec⁻¹ Shear Rate) Viscosity at -20°C Relative to the Maximum Specification Thickness

4.1.3 Freezing Point Depressants (FPDs)

The ADF and AAF formulations are water-based formulations wherein the vast majority (over 98 percent) of the non-water portion is comprised of freezing point depressants (FPDs) and the balance are a variety of additives. In commercially-available ADF/AAFs, which are petroleum-based, the FPDs contribute to nearly all of the BOD and the additives contribute to most of the toxicity and materials compatibility properties. By maximizing the use of bio-based ingredients, especially with the FPDs, we can not only minimize the carbon footprint of these fluids, but also create other benefits because such ingredients are generally less toxic, less corrosive, more easily biodegradable, and often are less expensive than petroleum-based ingredients.

Five FPDs were evaluated and the following four of these were tested:

- Petroleum-based propylene glycol (PG)
- Bio-based PG
- Bio-based 1,2-Propanediol (PDO)
- Bio-based non-glycol polyols.

Bio-based samples of glycerol, PG, and PDO were all found to have the same properties as their petroleum-based products. Our primary focus was on PG and PG/non-glycol polyol mixtures, referred to as “non-glycol FPD”; however, a small amount of testing was also performed on PG/PDO and PDO/non-glycol polyol.

Petroleum Based vs. Bio-based PG. Almost all currently used AAFs use PG, though some limited use of ethylene glycol (EG) persists. Therefore, the majority of the research in this project was performed using PG-based fluids. Early exploration showed that bio-based PG performed similar with respect to rheology. Furthermore, compositions supplied by potential sources showed that these were equivalent to their petroleum-based PG counterparts. Therefore, all subsequent testing was done with the easily available, petroleum-based PG.

PG/Non-glycol Mixture (Non-glycol FPD). Mixtures of FPDs sometimes provide a stronger non-ideal solution behavior, which leads to a lower FPt and therefore a lower COD/BOD for achieving the same FPt. Similarly, the initial rate of biodegradation, indicated by BOD₅, can be affected without affecting the theoretical (long-term) BOD. Therefore, mixtures of these polyols were also explored for compatibility in AAFs.

Non-glycol FPD mixtures were tested at different PG and non-glycol polyol concentration combinations to see how well the mixtures perform by comparing the chill curves, as shown in Figure 15. These fluids tested are fully formulated AAFs that contain the same ingredient concentrations for each additive, but alter only in FPD mixture ratios. As seen, the non-glycol FPD helps increase the viscosity. To take advantage of this observation, subsequent formulations utilized lower amounts of polymer and surfactant. Based on this optimization a non-glycol AAF, called AAF2 was prepared and used for HOT and MTMS testing, as discussed later.

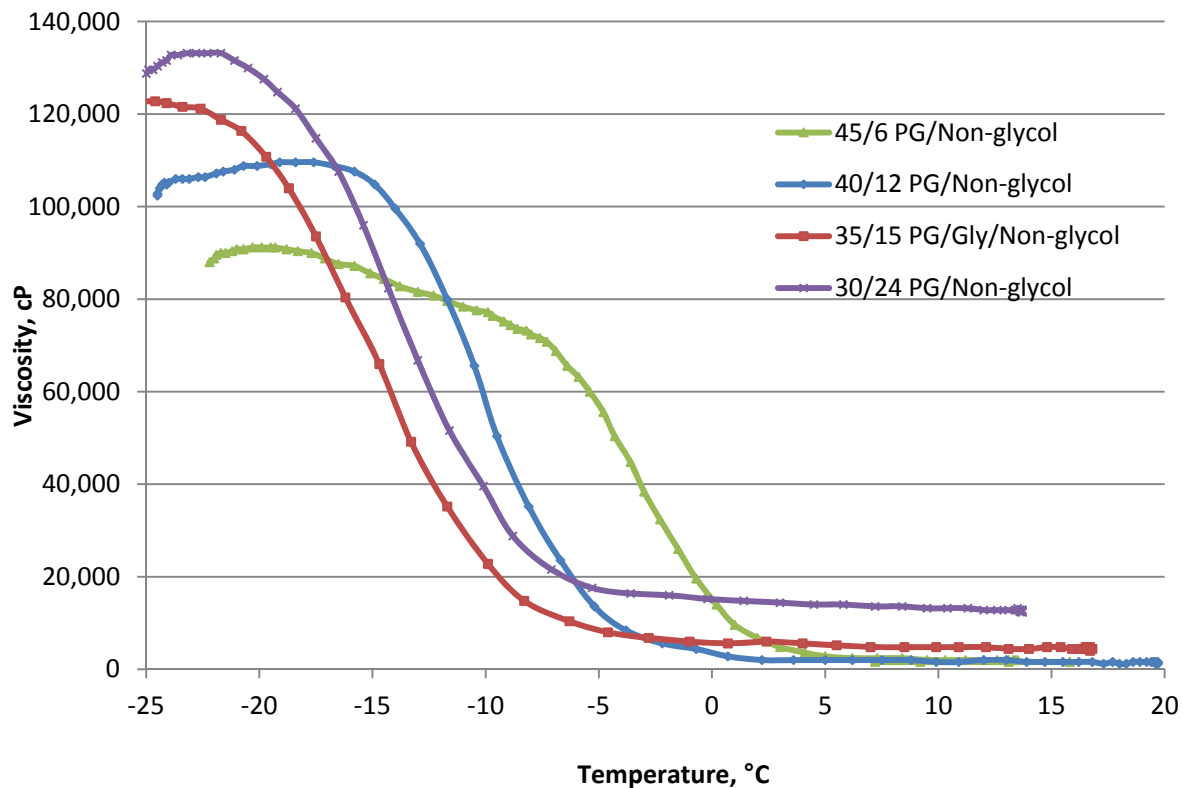

Figure 15. 0.3 RPM Viscosity vs. Temperature Curves for FPD Mixtures Containing Different Percentages of PG and Non-Glycol

Bio-based PDO. In other FPD screening, PG was replaced with PDO using the same series as shown in Figure 15 above. Chill curves for these fluids had lower, but acceptable maximum viscosities as compared to the curves containing PG, shown in Figure 16. By direct comparison, PDO-containing fluids appeared visually less stable at colder temperatures. Instances of the polymer dropping out of solution were noted, although from the progress made on PG and PG/non-glycol AAFs, a more stable fluid is possible with further exploration. However, there is no BOD/COD advantage with PDO, relative to PG, so PG was selected over PDO.

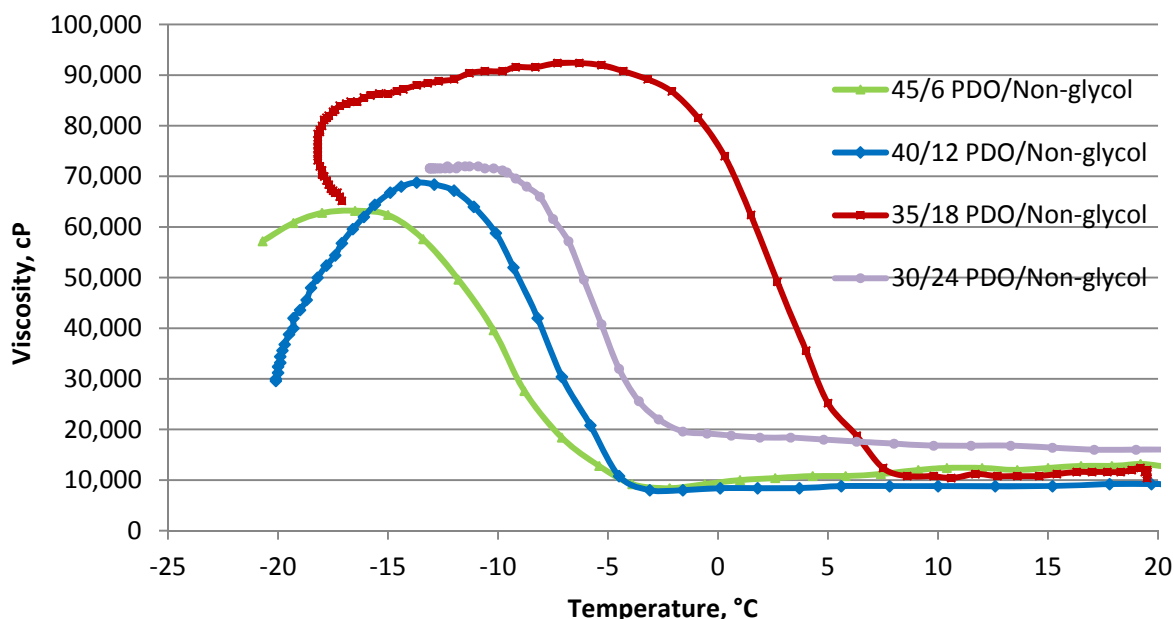

Figure 16. 0.3 RPM Viscosity vs. Temperature Curves for FPD Mixtures Containing Different Percentages of PDO and Non-Glycol

Freeze Point. The most important function of the FPD is to meet AMS 1428 specifications for freezing point which is below -32°C for neat fluid and below -10°C for fluid diluted 1:1, by volume. Based on freeze point (FPT) vs. FPD concentration models we have previously developed for PG and PG/non-glycol mixtures, we were able to select the right concentrations of FPD. Not surprisingly, all PG-based and PG/non-glycol based AAFs passed all requirements for FPT. Neat freezing points were measured from -32°C to -39°C (using a bit more FPD than necessary), while the 1:1 diluted samples were all at -10°C .

Carbon Footprint and COD. Both the PG-based and PG/non-glycol-based AAF formulations are more environmentally-friendly than currently available AAFs due to the absence of APE surfactants, triazole corrosion inhibition, and any defoamers as well as due to the replacement of the non-biodegradable anti-precipitant, as discussed in the following sections. Further, the PG/non-glycol-based formulations are expected to have a 45 percent lower carbon footprint and a 5 percent lower COD. A key additional advantage for these bio-based PG/non-glycol AAFs is that the non-glycol portion is half the price of PG.

4.1.4 PAA vs. Bio-based Thickeners

Three thickeners were evaluated for developing a new AAF. Thickeners provide different rheological behaviors as shown in Figure 17. Xanthan gums, two of which were tested in this project, were previously explored by NASA for Type II fluids, and produce relatively flat curves, while the viscosity curve for PAA-based polymer plus a preferred surfactant shows a rapid increase in viscosity upon cooling with a rapid drop-off at temperatures below -5°C . PAA plus

the associative surfactant, which did not associate with xanthan gum, was chosen for use because of its unique characteristics. Also, PAA is commonly used in other AAFs. Note the low viscosity at +20°C compared to the xanthan curve. This low viscosity allows the fluid to be easily pumped and transferred during formulation and handling, but provides a high enough viscosity at typical winter-time operating window to ensure adequate protection against freezing precipitation.

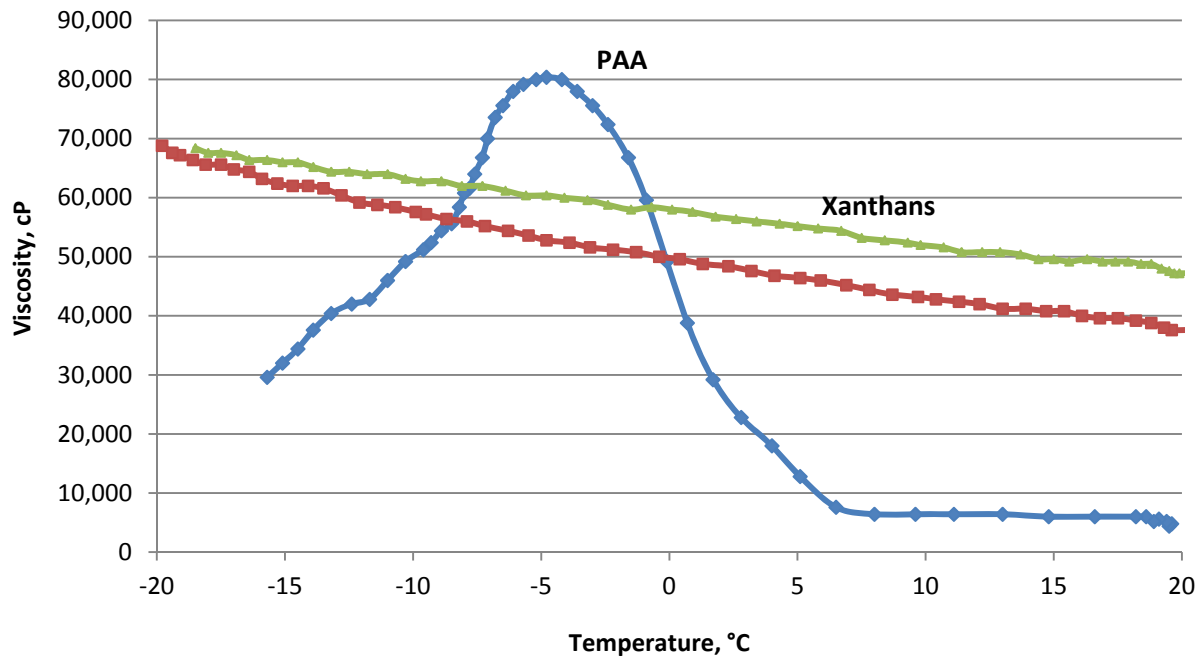

Figure 17. Viscosity vs. Temperature Profiles of Three Thickeners

Concentration of Thickener. The amount of thickener in a formulation has a pronounced effect on AAF Rheology. If the thickener concentration is too high, the fluid will be too thick at the operating range of the fluid for it to be easily removed from the aircraft during take-off. If the concentration is too low then it will not have sufficient anti-icing properties. An example of different thickener concentrations on AAF rheology can be seen in Figure 18. Notice the 50,000cP difference in the maximum viscosity by just a 0.04 percent increase.

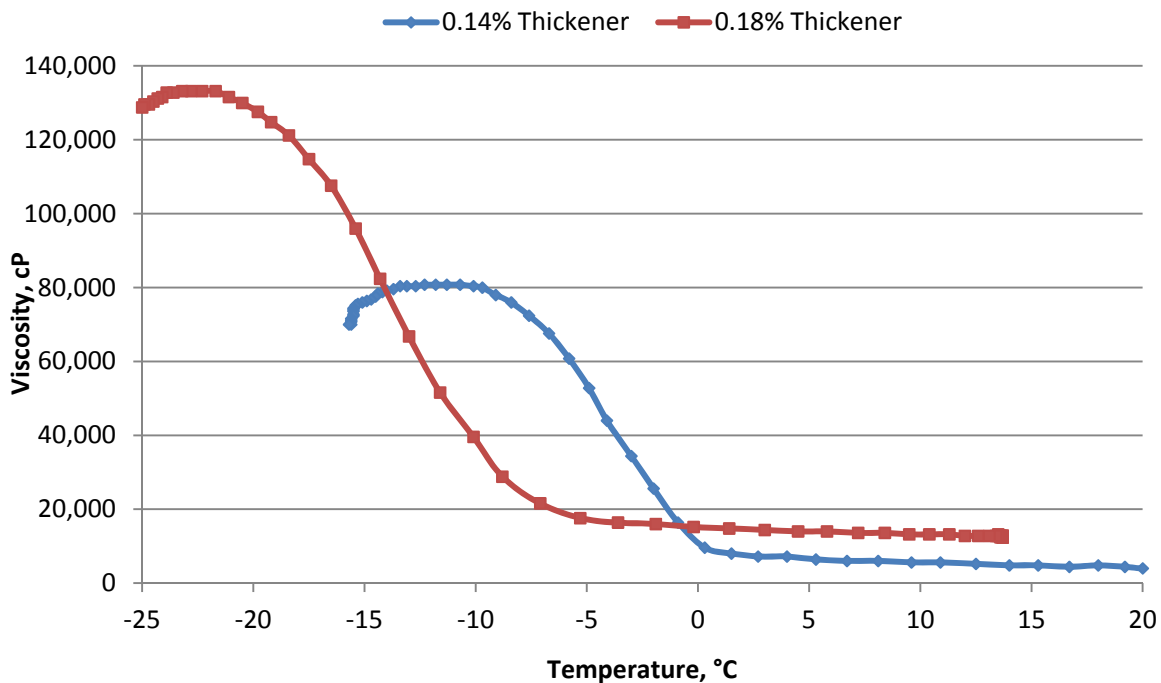

Figure 18. Effect of Thickener Concentration on Viscosity-temperature Profile for AAF-based on PG/Non-Glycol Mixture

Gel Residue. The use of a preferred combination of a thickener and an associative surfactant can not only improve thickening, but also can help reduce the gel-forming residues. The AAF rehydrated gel residue is a new test that is part of AMS 1428 (Appendix A). Gel residues occur as the result of repeated AAF application that leaves a powdery film upon dry out, and, when rehydrated, can swell up to over 600 times its weight.^(7, 38) When these gels collect on aircraft flight control surfaces in aerodynamically quiet areas and freeze, they can reduce aircraft performance. The test uses 5 cm x 10 cm aluminum plates that are repeatedly immersed in an AAF and then dried to determine weight of dry residue. The plates are then repeatedly rehydrated to determine weight of gel residue. The typical data are shown in Figure 19⁽³⁸⁾, which refers to three levels of gel forming potential (GFP). A maximum allowed value of 4.0 was recently adopted by the SAE G-12 Committee and this is to be included in future AMS 1428 specifications. A typical AAF prepared in this program was found to be a low-GFP fluid, as shown in Figure 20. The primary reason for low GFP for AAFs developed in this project is that we were able to greatly reduce the amount of polymer by utilizing the associative nature of the unique surfactants identified, as discussed in the next section.

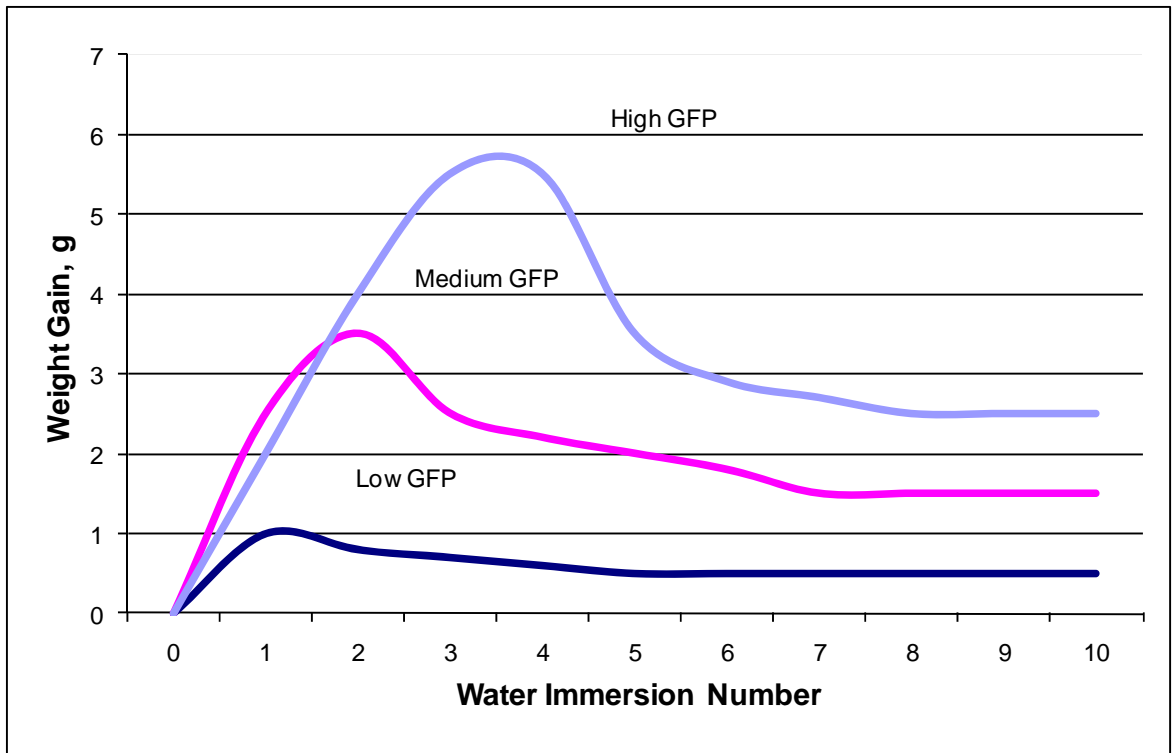

Figure 19. Typical Rehydrated Gel Residue Weight (Note: Dry Residue Weight =0.002g)

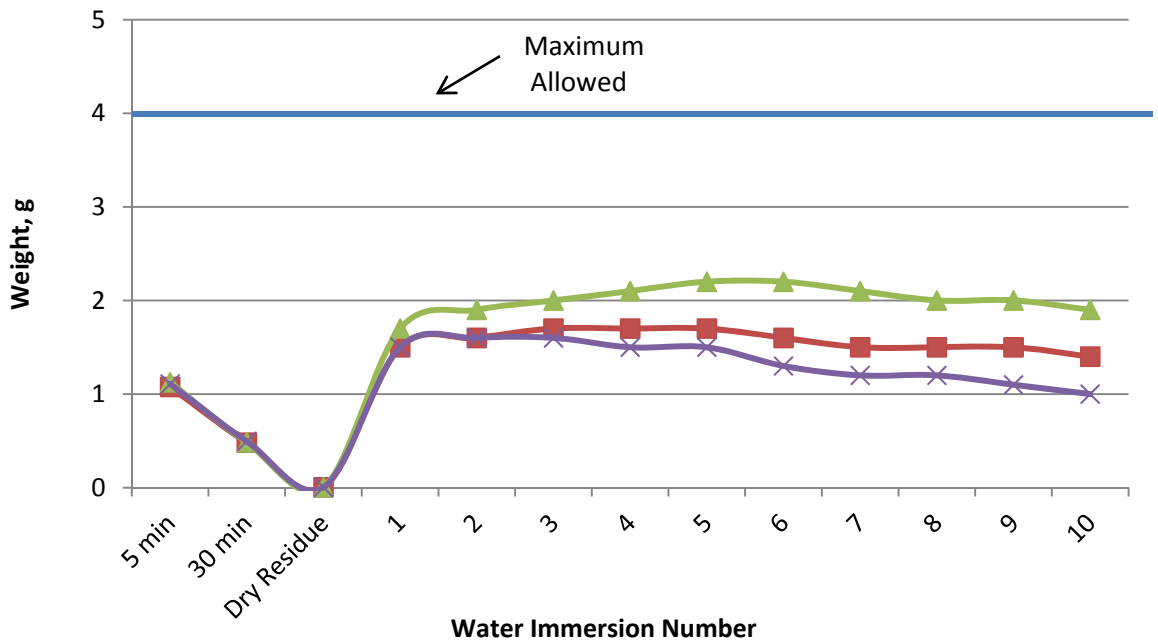

Figure 20. Results of AAF for Gel Residue Test

4.1.5 Replacement of Alkylphenol Ethoxylate (APE) Surfactant

As discussed earlier, APEs have biodegradation products that are suspected endocrine disrupters and have been banned in Europe.⁽¹⁾ A suitable replacement for APEs are alcohol ethoxylates; however, not all surfactants, even those listed as equivalent from different sources, will exhibit the same associative behavior in combination with the thickener used in AAFs.

The first important test used in the laboratory was rheological testing, by following the method described in Section 3.2.1. The rheological behavior of a fluid containing no surfactant shows no thickening affect upon cooling, as shown in Figure 21. A suitable surfactant provides a rapid increase in viscosity upon cooling, eventually leveling off or dropping in viscosity. This rapid increase in viscosity is the same property that the APE surfactants produced and which the vast majority of surfactants do not.

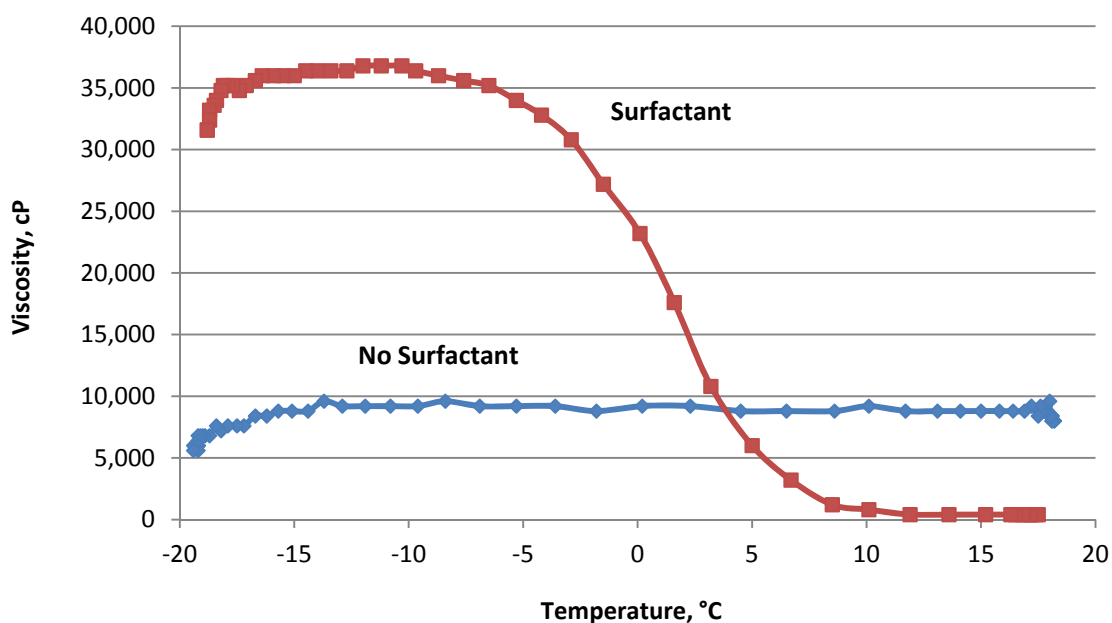

Figure 21. Rheological Behavior of No Surfactant vs. Associative Surfactant for AAFs at 0.3 RPM

The importance of this phenomenon is that it allows the fluid to be easily prepared and handled at warmer temperatures due to the lower viscosity. Also, the phenomenon provides adequate protection against ice formation, by having a higher viscosity at lower temperatures (in the typical 0°C to -10°C anti-icing operating window) and will not shear (or be removed) from the aircraft while the aircraft is awaiting take-off. Only a handful of alcohol ethoxylate surfactants were found to produce the desired thickening effect. Of these suitable candidates, only a small number (5) proved to be low-foaming when introduced to high shearing. The preferred surfactants also have a low surface tension and provide good coverage on metal panels.

One alcohol ethoxylate surfactant was chosen, from a choice of five, that had shown rheological behavior similar, if not exactly, to APEs. The preferred, proprietary surfactant of choice

produced adequate wetting on panels and was low foaming upon being subjected to high shear. This surfactant produced a low surface tension, measured at 29 dynes/cm². Early work showed the effects of viscosity achieved with surfactant concentration were significant, as shown in Figure 22. Several different concentrations were tested showing that surfactant concentration can significantly impact the maximum viscosity for a given thickener concentration.

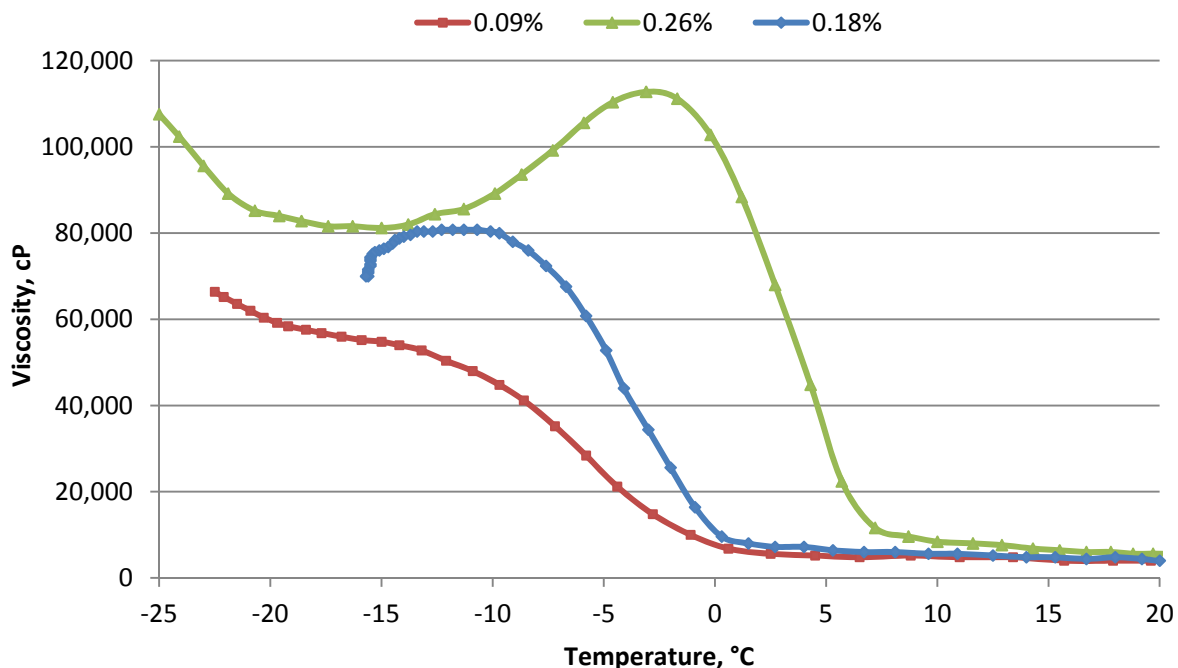

Figure 22. Effect of Surfactant Concentration on Viscosity at 0.3 RPM

Mixed Surfactants. In some of the early work the use of a second surfactant, in a much smaller concentration (<150ppm), was explored to see if it affected the location of the viscosity maximum relative to the temperature. According to patent 5,935,488 by Octagon Process, a second surfactant containing higher EO (ethoxylate units) can increase the onset temperature for thickening. Thus by varying the concentration of such a surfactant, various viscosity temperature profiles could be achieved. Using this theory, a couple of such surfactants were chill tested to see if this was in fact true with our fluids. Our results did show a small shift in the chill curve to the right but did not show a significant increase in maximum viscosity (see Figures 23 and 24).

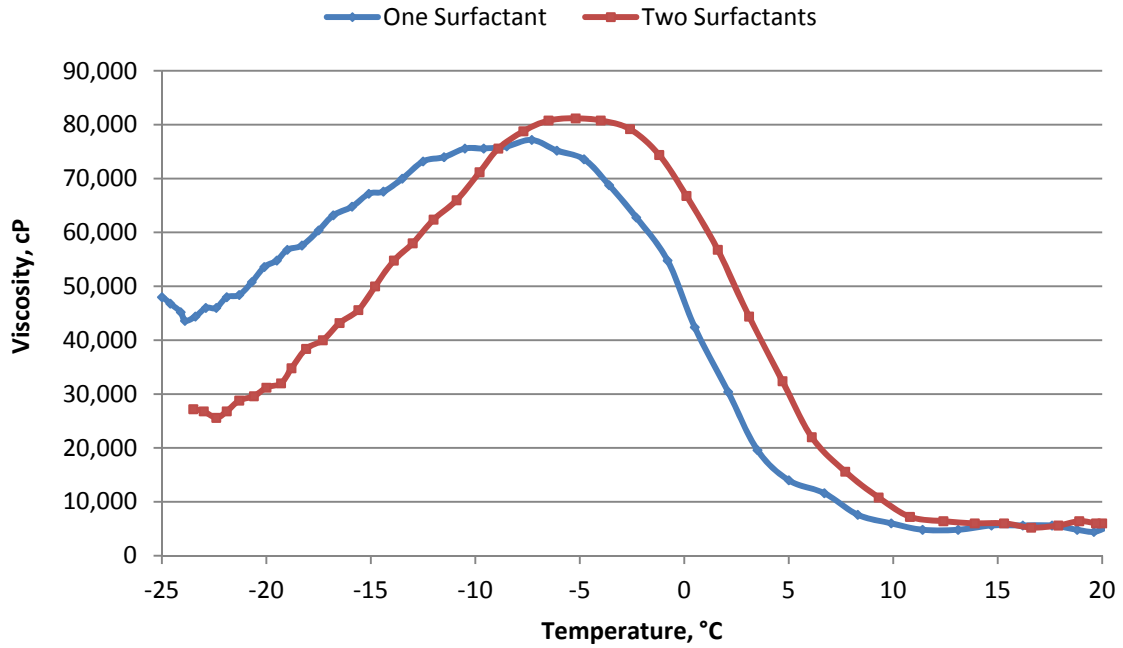

Figure 23. Effect of Addition of a Second Surfactant at 0.3 RPM Viscosity

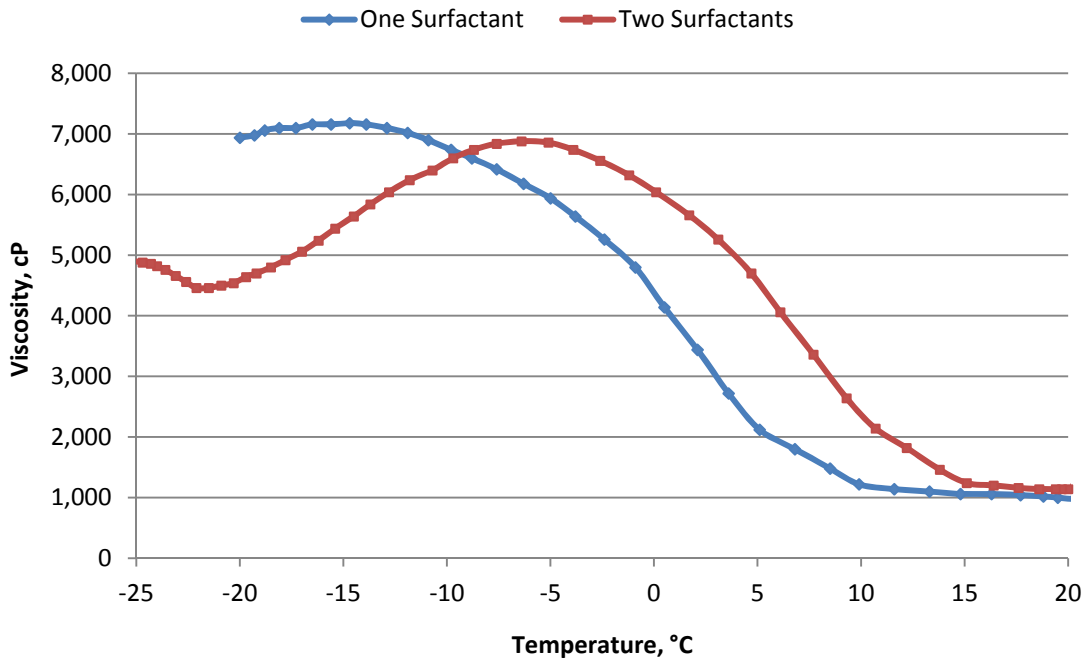

Figure 24. Effect of Addition of a Second Surfactant at 6 RPM Viscosity

In conclusion, surfactants play an important role in wetting the aluminum panel for effectiveness in WSET and protection against ice formation. A balance between good wetting and protection vs. a potential increase in ecotoxicity, even with the use of non-APE surfactants, is important. The lowest concentration of surfactant required to be effective is therefore the key. By optimizing the relative properties of several additives that affect the rheology, we were able to use the minimum possible amount of the two surfactants.

4.1.6 Biodegradable Anti-precipitant

All AAFs need an anti-precipitant to provide stability in the presence of hardness ions such as calcium. The hard water test in AMS 1428 is indicative of a suitable anti-precipitant performance. The currently used ethylenediaminetetraacetic acid (EDTA) type anti-precipitant, shown in Figure 25, works well but is not very biodegradable. Therefore, we looked at biodegradable anti-precipitants like the ones we tested in our previous work on ADFs.

Based on the review of information from several vendors, we selected two new anti-precipitants. One of these is an Acusol product, which is a lower molecular weight carboxylic acid. A second product, referred to as GL, is a chelating agent that is prepared from renewable resources and is based on a food-grade natural amino acid salt and is classified as “biodegradable”.

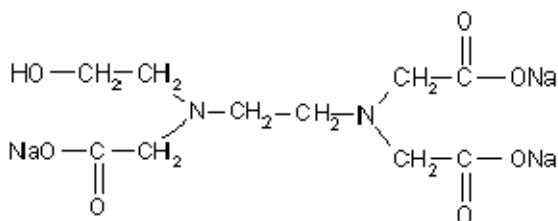

Figure 25. Molecular Structure of an EDTA

The inclusion of an anti-precipitant has a major effect on the overall viscosity, as shown in Figure 26. It was discovered that the higher the concentration used, the lower overall viscosity during chill curve testing as shown in Figure 27. However, the addition of an anti-precipitant contributes to the hydrogen embrittlement (HE). Therefore, various levels of thickener, GL, and corrosion inhibitors were tested to achieve the correct rheology, desired anti-precipitant effect, and the required materials compatibility.

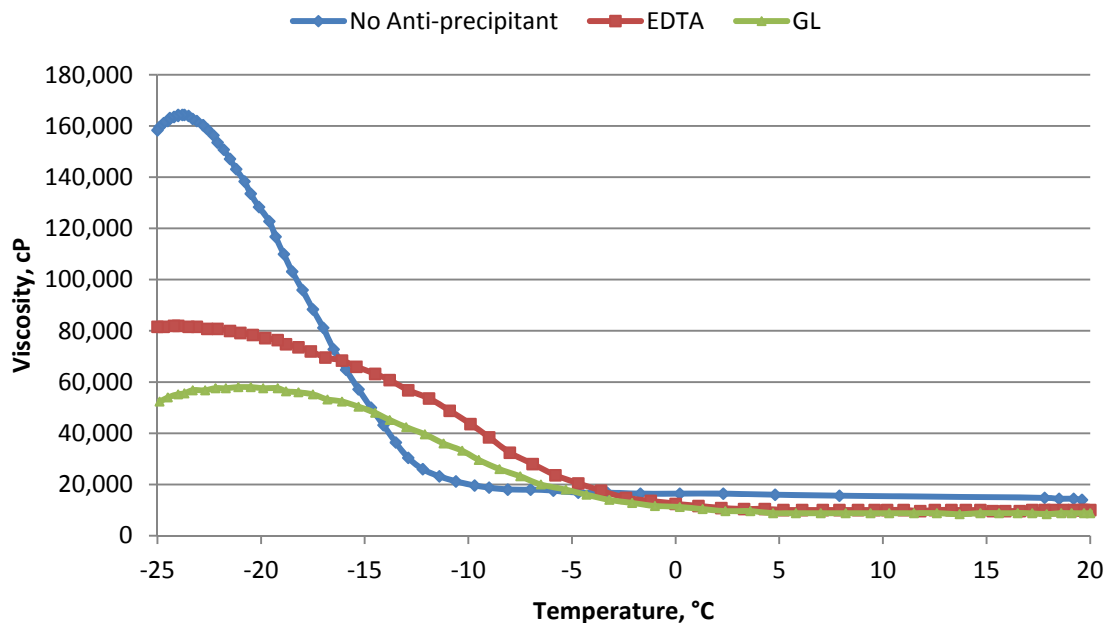

Figure 26. Effect of Anti-precipitant and Type on Rheology at 0.3 RPM

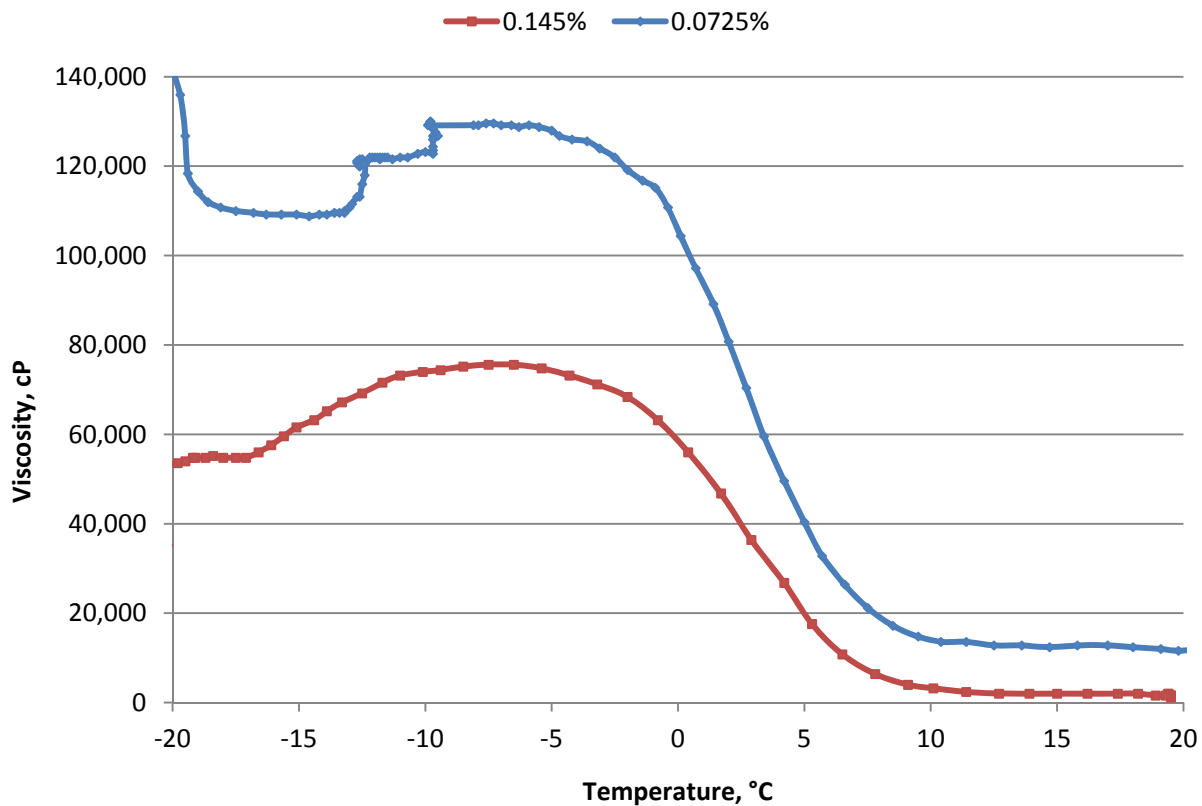

Figure 27. Effect of GL Concentrations on Rheology at 0.3 RPM

Several different concentrations were tested in the laboratory to see if they would pass hard water stability after 30 days. Fluids were diluted 1:1 by volume with hard water and placed in an oven at 95°C. These fluids were checked periodically for insolubles that might have developed. Results of the samples tested are shown in Table 7. Samples down to 181 ppm GL showed no sign of precipitate, but the pH change over the 30 day period was a problem for one type of corrosion inhibitor, called dimethyl glutarate (DMG). These samples with a large pH change all contained DMG and apparently went through hydrolysis at elevated temperatures. The low concentration of GL is beneficial for passing HE but makes passing performance testing, for aerodynamics, difficult as the lower the GL concentration the higher the viscosity that is obtained. The concentration of GL used in the final fluid formulation is based on the amount of thickener used and the FPD type. Regardless of the anti-precipitant type and concentration used, some corrosion inhibitor will be required to pass all corrosion type tests while maintaining the anti-icing and aerodynamic performance.

Table 7. Hard Water Testing Results at Various Anti-precipitant Levels

Sample ID	GL %	Acusol %	DMG %	10 day Aging			30 day Aging		
				pH Unaged	pH Aged	Difference	pH Unaged	pH Aged	Difference
53408-76	0.11	0	0	6.77	6.65	0.12	6.46	6.43	0.03
53408-82	0.11	0	0	6.64	6.64	0	6.75	6.23	0.52
53408-90	0.15	0	0	6.38	6.32	0.06	6.41	5.97	0.44
53408-91	0.07	0	0	6.46	6.44	0.02	6.47	5.96	0.51
53408-112	0.07	0	0.04	6.26	5.59	0.67	6.17	5.07	1.1
53563-1	0.04	0	0.04	6.29	5.74	0.55	6.27	5.1	1.17
53563-4	0.04	0	0.04	6.35	5.53	0.82	6.22	4.56	1.66
53563-6	0.04	0	0.04	6.35	5.58	0.77	6.22	4.88	1.34
53563-21	0.04	0	0.04	6.74	5.98	0.76	6.7	4.86	1.84
53563-24	0.00	0.02	0	6.26	6.27	-0.01	6.29	5.59	0.7
53563-30	0.02	0	0	6.22	6.15	0.07	6.19	5.32	0.87
53563-40	0.04	0	0	6.34	6.18	0.16			
53563-44	0.04	0	0.02	6.19	5.78	0.41			

During this project and prior to finding a successful corrosion inhibitor package for EDTA or GL, another chelating agent, Acusol was tested. Acusol, a polyacrylic acid sodium salt with a low molecular weight, was previously tested during ADF development. The same pattern was noted with Acusol concentration and overall viscosity as was seen with the EDTA or GL. The concentration of the chelating agent is inversely proportional to the maximum viscosity as shown in Figures 28 and 29.

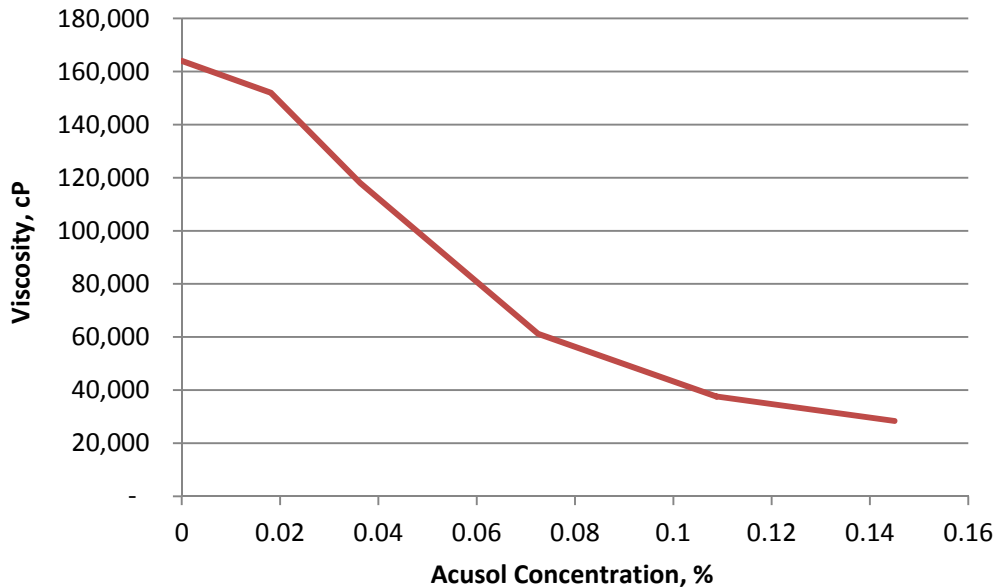

Figure 28. Effect of Acusol Concentration on Room Temperature Viscosity at 0.3 RPM

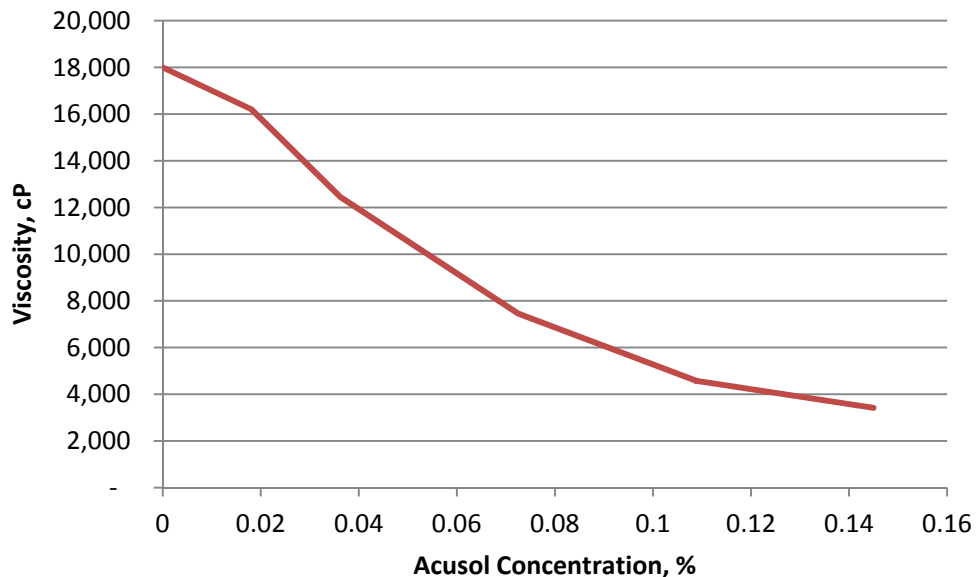

Figure 29. Effect of Acusol Concentration on Room Temperature Viscosity at 6 RPM

In summary, the anti-precipitant plays an important role not only in the hydrogen embrittlement and other corrosion tests, but also significantly alters the viscosity. The proper concentration of anti-precipitant must pass critical testing of WSET and aerodynamics as well as corrosion and hardwater stability requirements of AMS 1428. Based on a comparison of Acusol and GL, it was decided to use GL as an anti-precipitant as it gave a better rheology.

4.1.7 Selection of pH Modifier

As discussed earlier, the PAA thickener requires neutralization to build up viscosity. During initial testing, a pH modifier that contained potassium produced the desired chill curve, a rapid increase in viscosity upon chilling, and a drop in viscosity once a critical temperature was achieved. A modifier containing an amine compound, triethanolamine (TEA), which could also be suitable for corrosion inhibition, did not allow for the rapid increase in viscosity or the rapid decrease upon chilling. Figure 30 shows an example of the difference in rheologies produced by two different pH modifiers.

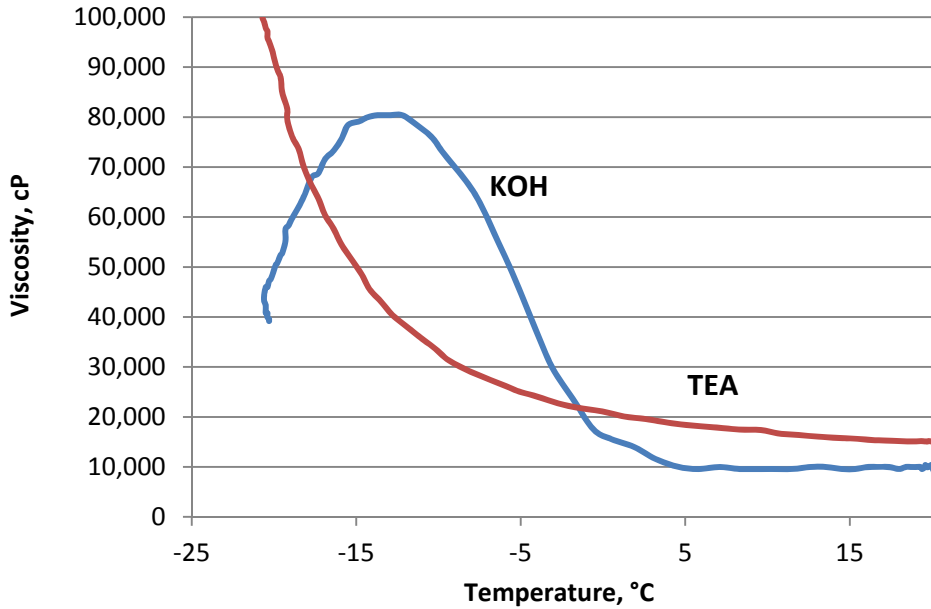

Figure 30. Effect of pH Modifier on Viscosity

To achieve this rapid increase then decrease of viscosity upon chilling, a particular combination of a thickener, a surfactant, anti-precipitant, and a pH modifier is required. A slightly crosslinked PAA in combination with potassium hydroxide (KOH), a biodegradable anti-precipitant, and a suitable alcohol ethoxylate surfactant allows for these characteristics. By balancing the fluids components, a superior AAF in terms of anti-icing performance, environmental friendliness, materials compatibility, and lower cost could thus be produced.

In addition to affecting the rheology, the pH also affects corrosion properties, especially HE. The higher the pH, the more likely it is to pass HE testing but it may also negatively affect the aerodynamic performance of the fluid. In our research, a pH range of 7.0 to 7.5 was found workable. The effect of pH on rheology is shown in Figure 31 and 32.

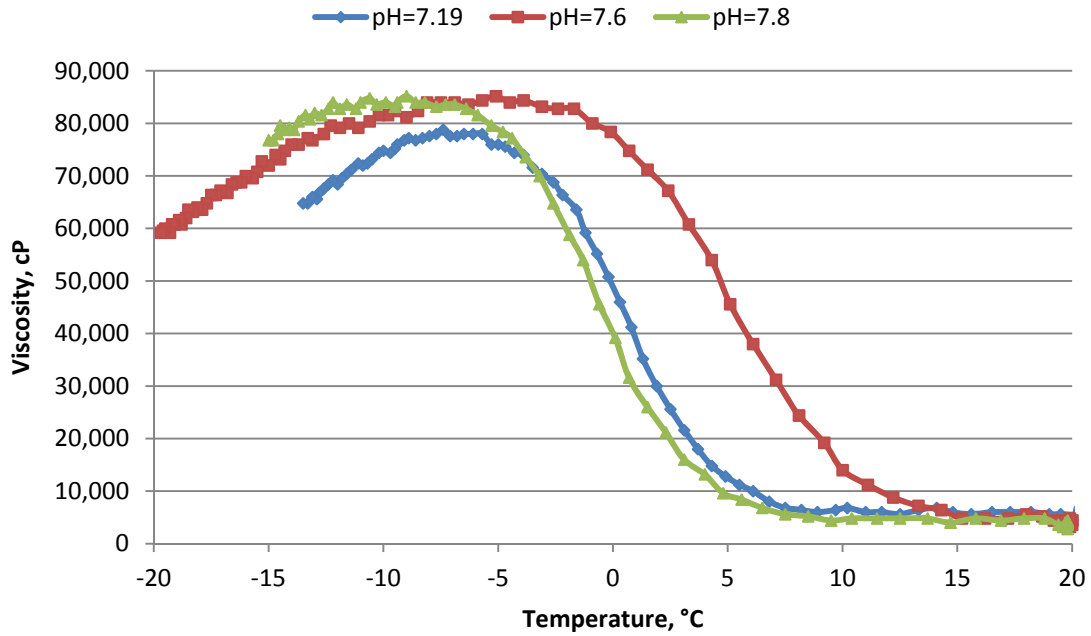

Figure 31. Effect of pH on Viscosity at 0.3 RPM

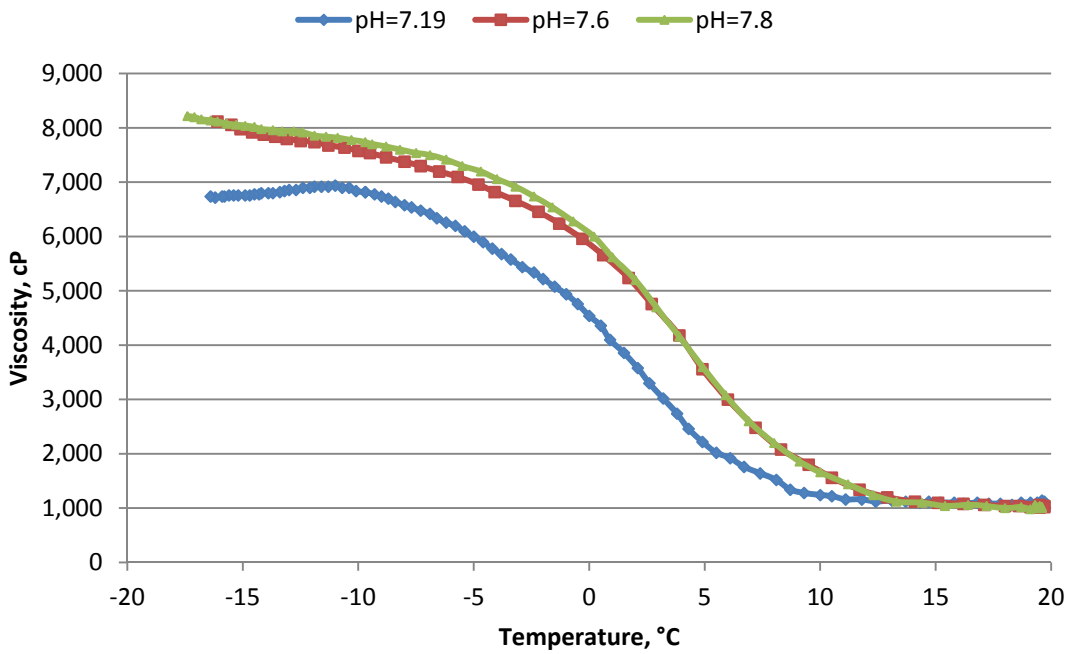

Figure 32. Effect of pH on Viscosity at 6 RPM

In summary, the pH modifier also is critical in obtaining the targeted rheology. Triethanolamine (TEA) distinctively shows that no break in the chill curve will be achieved when used solely as a pH modifier. The use of KOH to achieve a pH range of 7.0 to 7.5 is satisfactory.

4.1.8 Replacement of Triazole Corrosion Inhibitor

Corrosion inhibitors are necessary to protect the various metals on the aircraft. A series of corrosion tests are required for AMS 1428 certification, including sandwich corrosion, immersion corrosion, low-embrittling cadmium corrosion, and hydrogen embrittlement (HE). Previous work on aircraft deicing fluids (ADFs) and runway fluids (RDFs) showed that HE is the most sensitive and the most unpredictable test required. Passing this test requires a robust inhibitor(s) that will easily pass hydrogen embrittlement testing without affecting other AAF properties.

A commonly used corrosion inhibitor package contains a triazole compound, which is banned in Europe due to its toxicity and non-biodegradability. Based on joint literature research by Dr. Rudolph Buchheit at The Ohio State University and Battelle,⁽¹⁸⁻³⁶⁾ a number of non-triazole compounds were identified that might be compatible for use in AAFs. The classes of compounds are listed below:

- Carboxylates
- Phosphonates
- Sulfonates
- Amines
- Silicates
- Amides.

Electrochemical Screening. Further exploration was required to narrow down potential candidates. In the laboratory screening, which is much faster and cheaper than HE testing by an outside laboratory, electrochemical potential (E) was measured as a function of the log of the normalized current (i) or current density. The i_{corr} values (corresponding to the corrosion potential) were calculated by extrapolation on both the anodic and cathodic curves; where they intersect is i_{corr} . An example of the calculation was shown in Figure 9 in Section 3.2.2.

Based on electrochemical testing using cadmium (Cd) coupons, several candidates were chosen for further analysis. The following inhibitors were down-selected for further laboratory testing at Battelle following ASTM F 1111 protocol, used for testing for low-embrittling cadmium corrosion (see Appendix A):

- Methyl hexanoate
- Dimethyl glutarate (DMG)
- Dimethyl sebacate (DMS)
- Hydroxyquinoline
- 3-Methoxypropylamine (MPA).

Several observations were made regarding these corrosion inhibitors. Methyl hexanoate was not compatible with the AAF and hydroxyquinoline pitted the coupons in laboratory screening tests, but overall did not exceed the maximum weight loss of $0.3\text{mg}/\text{cm}^2/24\text{ hrs}$ specified in AMS

1428. All other candidates provided protection against weight loss and did not show to corrode the Cd-plated coupons.

In an attempt to correlate HE testing results to laboratory type results, LPR (linear polarization resistance) testing was performed at Battelle. This test was used to screen various corrosion inhibitors prior to sending out for HE testing. Several samples that showed to have low corrosion rates still did not pass HE testing. Examples of the results are shown in Figure 33. Tolytriazole (control), shows to have the lowest corrosion rate and does pass HE testing where as lignin sulfonate showed potential according to LPR, but showed failure within 24 hours. This test did not correlate as well as expected.

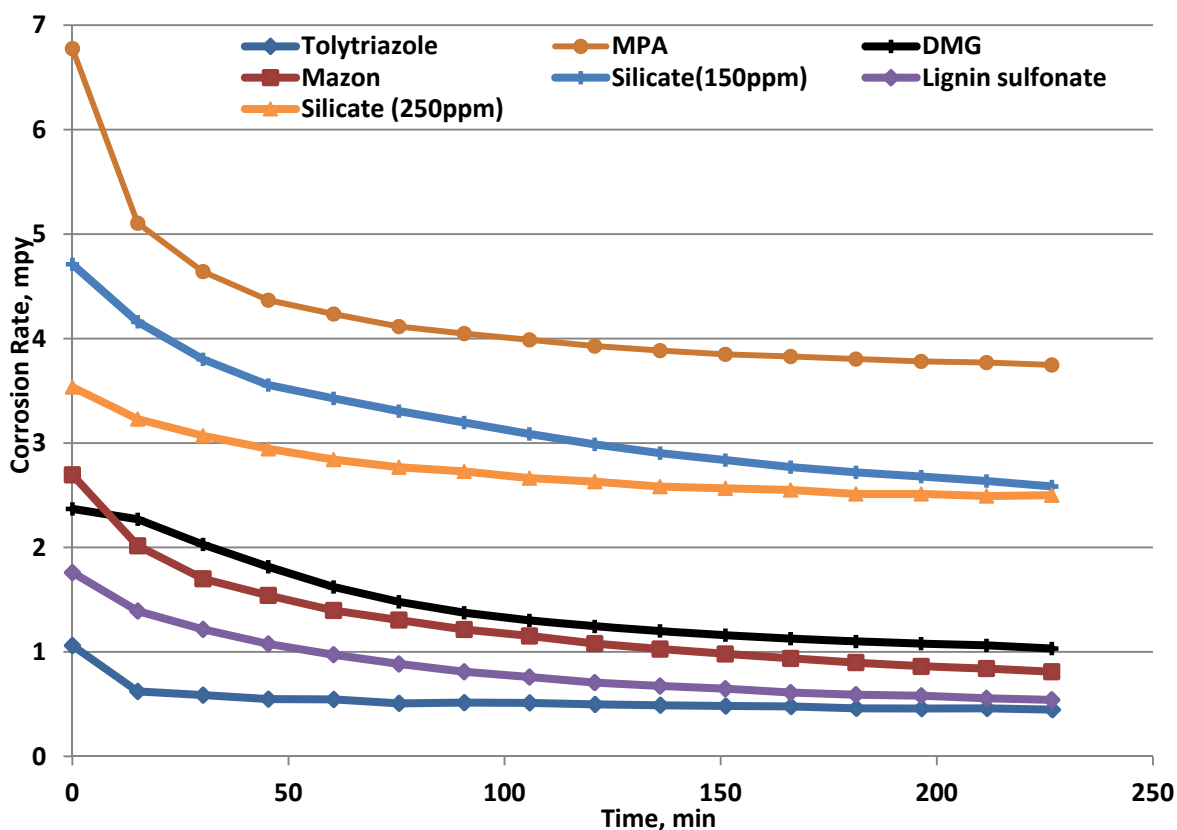

Figure 33. LPR Measurements for Several Corrosion Inhibitor Candidates

Rheological and Corrosion Testing. Based on the electrochemical screening as well as some additional inputs from vendors, several corrosion inhibitors were further tested for rheological and HE characterization. The results are summarized in Table 8.

Table 8. Summary of Results of Corrosion Inhibitor Testing

Corrosion Inhibitor	Effect on Rheology	Effect on HE	Comments
DMG	Significant decrease in viscosity	Passed at several anti-precipitant levels	<ul style="list-style-type: none"> • Need to limit concentration to pass hard water test
DMS	Negligible	Passed at selected anti-precipitant levels	<ul style="list-style-type: none"> • More difficult to formulate due to availability as solid
MPA	Significant increase in viscosity	Passed at selected anti-precipitant levels	<ul style="list-style-type: none"> • Need to limit concentration to pass aerodynamic acceptance
Proprietary Blend of Organics and Inorganics (Inhibitor A)	Significant decrease in viscosity	Passed at several anti-precipitant levels	<ul style="list-style-type: none"> • The electrolytes in this blend can be adjusted to fine-tune viscosity without affecting corrosion inhibition

After each successful rheological characterization the AAF was submitted for HE testing. A total of 55 AAF formulations were tested for HE evaluation. A total of 16 AAFs passed HE testing. Based on other AMS 1428 testing, the following two corrosion inhibitors were selected for detailed AMS 1428 certification, HOT, and MTMS testing of some AAFs:

- DMG (used in AAF1 and AAF2); at acceptable concentration to pass hard water test
- Inhibitor A (used in AAF3 and AAF4)

The results of the detailed testing are provided in Section 4.3.

4.2 AAF MANUFACTURING PROCEDURE DEVELOPMENT

After completing extensive parametric testing for AAF formulation, we began to look at the manufacturing cost of the AAF formulation. Here we determined that there were two different methods of preparing AAFs at commercial scale, regardless of the fluid composition. One method, which was utilized for most of the laboratory testing, was to mechanically shear the formulated fluid to obtain the desired viscosity. In the laboratory, we used a Waring blender for adjusting the final viscosity. The AAF1 and AAF2 samples were made using this method. This final viscosity control is essential since the AMS 1428 specification requires that production batches fall within upper and lower viscosity limits, measured at 20°C, for an approved fluid.

However, this production method of post-shearing was estimated to require more than one day with more capital cost to manage shearing.

A second manufacturing method, involving pre-shearing of just the thickener-water slurry was therefore investigated. This manufacturing method was estimated to allow a large-batch preparation to be made in about two hours, thus significantly reducing the manufacturing/blending cost. To simulate this method in the laboratory, we set up and tested a Silverson mixer/homogenizer.

A comparison of the two manufacturing methods showed that either method could be used to meet AMS 1428 requirements. However, pre-shearing method was selected for final AMS 1428 certification, which requires that the manufacturing method used for making certification samples be representative of the one to be used for commercial-scale production. Therefore, the AAF3 and AAF4 samples, which were prepared for final AMS 1428 certification tests were made using this method.

Using the pre-shearing method, the laboratory process was scaled-up to 200 L scale and the samples were sent for AMS 1428 and HOT testing

4.3 AAF PERFORMANCE TESTING

Based on the testing so far, at least two AAFs, are expected to pass all specifications in AMS 1428. Several different types of screenings were needed in order to optimize the AAF composition. Full certification testing costs about \$100K and one failure voids the fluid from being certifiable. Screening was therefore broken down into three different levels. Level I screening involved testing the critical components of a fluid to ensure the fluid is capable of performing well and choosing ingredients that will make a fluid that is environmentally-friendly, including biodegradable. Level II screening was the most important and required the most iterations to optimize the fluid composition. Level II screening focused on corrosion resistance, gel-formation, anti-icing testing, and aerodynamic acceptance testing, which have been described in detail in Section 4.1. The remaining testing, Level III, was for full screening and certification of the best AAFs.

After the standard anti-icing testing and aerodynamic acceptance testing, material and environmental testing was performed. Several specialized tests were also required. Spray testing will be performed in 2012/13 winter by one of Battelle's industrial partners. MTMS testing which evaluated the influence of the AAF on special DoD materials was performed by AFRL and CTC Corp. Details of testing are provided in Appendix B and summarized in Section 4.3.4. Lastly, Holdover Time (HOT) testing was performed by APS and Transport Canada to see how the fluids performed in a real environment and are summarized in Section 4.3.5.

4.3.1 Level I Screening Tests

Freezing Point. Several formulations exceeded the limits of -32°C for the neat fluid and -10°C for a 1:1 diluted, by volume. PG-based as well as PG/non-glycol FPD-based AAFs have met or exceeded this requirement.

BOD and COD. In commercially-available ADF/AAF, which are petroleum-based, the FPDs contribute nearly all of the COD. The COD and BOD₅ of the PG-based fluids (AAF1, AAF3, and AAF4) were expected to have COD and BOD₅ values similar to the ones for commercially-available PG-based fluids. However, for AAF1, the BOD₅ value was 0.37 kgO₂/kg, which is low compared to the typical 0.50+ values reported for commercial AAFs. Additionally, the PG-based AAFs developed in this project have better environmental and materials compatibility properties.

The PG/non-glycol-based fluid (AAF2) is expected to have a 45 percent lower carbon footprint and at least a 5 percent lower COD or BOD₅ compared to commercial PG-based AAFs. The non-glycol FPD in AAF2 is bio-based, is more biodegradable than PG, and has a 27 percent lower COD. It also has a better materials compatibility as discussed in Section 4.3.4.

Ecotoxicity. Additives contribute to most of the toxicity in AAFs. The AMS 1428 specifies reporting of acute toxicity to *Daphnia magna* (daphnid) and *Pimephales promeles* (fish) in terms of LC₅₀ values (concentration in mg/L at which 50 percent of organisms/fish die). Currently there is no standard for AAFs. The reported LC₅₀ values for PG-based commercial AAFs are typically 500 to 1,000 mg/L. Results for the Battelle AAF1 showed that the LC₅₀ for *Daphnia magna* was 1,125 and for *Pimephales promeles* it was 1,475 mg/L. The results for AAF3 and AAF4 will be available later.

Foaming. During surfactant screening, foaming was important. A low foaming type surfactant was desired to avoid using a defoamer in the formulation. This lack of defoamer could decrease the toxicity. Several quick screening tests were performed on selected surfactants for their tendency to foam. The major test that will determine if no defoamer is needed will be during spray testing. At this time no foam has been noted, and therefore no defoamers have been used for the down-selected AAFs.

4.3.2 Level II Screening

Hydrogen Embrittlement and other corrosion testing. This test requires a specimen not to fail within 150 hours of being submersed in an AAF. A total of 55 samples were tested and retested during corrosion inhibitor screening to find a robust inhibitor. After the optimized inhibitor package was determined samples consistently passed the HE test. AMS 1428 also requires several other corrosion tests including low-embrittling Cd, sandwich corrosion, and immersion corrosion. These tests were easy to pass and all samples tested were successful.

Gel-forming residue. Gel residues occur as the result of repeated AAF application that leaves a powdery film upon dry out, and when rehydrated, can swell up to over 600 times its weight.^(7, 38)

When these gels collect on aircraft flight control surfaces in aerodynamically quiet areas and freeze, they can affect reduced aircraft performance. A maximum allowed value of 4.0 was recently adopted by the SAE G-12 Committee and this is to be included in future AMS 1428 specifications. An AAF prepared in this program was found to be a low-GFP fluid as discussed in Section 4.1.4.

WSET. Water spray endurance testing is conducted at -5°C and in order to be an acceptable Type IV AAF a minimum of 80 minutes of protection against ice formation is required. During this project, a variety of WSET times were achieved as discussed in Section 4.1.1. Some were as low as 39 minutes with the initial formulation tested and up to 106 minutes. The major factor in determining how well the fluids will protect is based on 0.3 RPM (0.06sec^{-1} shear rate) viscosity at -5°C . The higher the viscosity, the higher the WSET. This viscosity cannot be too high or aerodynamic performance will suffer as discussed in Section 4.1.2. A balance to achieve the highest viscosity required to protect against ice formation and the lowest to be removed from plane during take-offs are needed.

4.3.3 Level III Screening

Four formulations AAF1, AAF2, AAF3, and AAF4 were selected for extended testing under AMS 1428 and HOT testing. Two of these fluids were also subjected to MTMS testing, as shown in Table 9. The results of testing by SMI on AAF1 are shown in Appendix C. Full AMS 1428 testing is currently being performed on AAF3 and AAF4 fluids. Other non-standard tests have also been performed. Spray testing will be performed in 2012/13 winter on AAF3. MTMS testing which tested the influence of the AAF on special DoD materials is described in Appendix B, and summarized in Subsection 4.3.4. Lastly, Holdover Time (HOT) testing was performed to see how the fluids performed in a real environment is described in Appendices D and E, and summarized in Subsection 4.3.5.

Table 9. AAF Formulations Down-Selected for Level III Testing

AAF Formulation	Type	FPD %	Water %	Additives Package %	Comments
AAF1 (53223-52)	PG-Based	50.20	49.12	0.68	<ul style="list-style-type: none">• AMS 1428 Tested• HOT Tested• MTMS Tested
AAF2 (53223-56)	Non-glycol	55.00	43.78	0.61	<ul style="list-style-type: none">• AMS 1428 Tested• HOT Tested• MTMS Tested
AAF3 (LNT 250)	PG-Based	51.54	47.89	0.57	<ul style="list-style-type: none">• AMS 1428 Testing Underway• HOT Tested
AAF4 (LNT 450)	PG-Based	51.54	47.89	0.57	<ul style="list-style-type: none">• AMS 1428 Testing Underway• HOT Testing Planned

4.3.4 Material Test Method Standard (MTMS) Testing

Test methods and materials for MTMS testing are described in detail in Appendix B. Two samples (PG-based AAF1 and non-glycol AAF2) were tested and performed similar to each other. The AFRL/CTC report concluded that “The two deicers performed slightly better than the previously tested Type II, III, and IV fluids investigated by AFRL/CTC for materials compatibility under a previous testing effort”. A summary of results is shown in Table 10. Materials with marginal failures showed some failures among the replicates but overall these passed. Only one fluid (AAF2) had a failure on the humidity testing for HVOF where more than three, 1mm rust spots were noted on the coupons. Adjustment in the corrosion inhibitor concentration should aid in increasing the compatibility with these HVOF coatings as fluid AAF1 did pass.

Table 10. Summary of Materials Compatibility Testing of Battelle’s AAF1 and AAF2 Compared to Previously Tested Commercial Type IV AAF

Material Category	Test Method	Battelle AAF1(53223-69) Results	Battelle AAF2 (53223-71) Results	Commercial Type IV Results⁽⁸⁾
Metallic Materials	Alternate Immersion	Pass	Pass	Failed 4140 and 4340 steel
	Stress Corrosion Cracking	Pass	Pass	Pass
Elastomeric Materials	Shore A Hardness	Pass	Pass	Pass
	Percent Volume Swell	Marginal Pass	Marginal Pass	Fail
	Peel Strength/% Cohesive Failure	Pass	Pass	NA
	UTS/Elongation	Pass	Pass	NA
	100% and 300% Modulus	Pass	Pass	Fail
Aircraft Wire Insulation	Conductivity	Pass	Pass	NA
	Bend Test	Pass	Pass	Pass
	Voltage Withstand	Pass	Pass	Pass
Infrared Windows	Change in Transmission	Pass	Pass	Pass
LO Coatings	Liquid Uptake	Pass	Pass	Pass
	Adhesion	Pass	Pass	NA
	Pencil Hardness	Pass	Pass	NA
Lubricants and Greases	Humidity	Pass	Pass	Failed 83261 grease
Cannon Plugs	Insulation Resistance	Pass	Pass	Pass
	Shell-to-shell Conductivity	Pass	Pass	Pass
	Voltage Withstand Testing	Pass	Pass	Pass
HVOF	Humidity Testing	Pass	Fail	Fail
	Alternate Immersion	Pass	Pass	Fail
Standard Aircraft Coating	Tape Adhesion	Pass	Pass	Pass
	Pencil Hardness	Pass	Pass	Some Failed

4.3.5 Holdover Time (HOT) Testing

The APS Aviation Inc. (APS), under the guidance from Transport Development Centre (TDC) of Transport Canada (TC) and the Federal Aviation Administration (FAA) performed endurance time or holdover time (HOT) testing on three Battelle fluids. Initially, APS carried out preliminary endurance time testing on AAF1 and AAF2, the same two fluids that were also subjected to MTMS testing. The full report for these test is provide in Appendix D. A summary of this is provided in Table 11. The data in Figures 34 and 35 are representative results that clearly show that endurance times for both AAF1 and AAF2 are superior to the current Type IV generic HOT times.

Table 11. Endurance Time Testing for AAF1 and AAF2

Test No.	Date	Fluid Name	Icing Intensity (g/dm ² /h)	Endurance Time (min)	Test Temp. (°C)	Test Surface	Precipitation Type
85	20-Jul-11	AAF1	13.6	87.5	-3.4	Al. Plate	Freezing Drizzle
87	20-Jul-11	AAF1	12.2	92.8	-3.4	Al. Plate	Freezing Drizzle
101	20-Jul-11	AAF1	12.6	103.7	-6.2	Al. Plate	Light Freezing Rain
113	20-Jul-11	AAF1	25.1	70.7	-6.2	Al. Plate	Light Freezing Rain
115	20-Jul-11	AAF1	24.9	70	-6.2	Al. Plate	Light Freezing Rain
125	21-Jul-11	AAF1	5.1	119.1	-10.4	Al. Plate	Freezing Drizzle
127	21-Jul-11	AAF1	5.2	119.2	-10.4	Al. Plate	Freezing Drizzle
137	21-Jul-11	AAF1	13.3	87.7	-10.1	Al. Plate	Freezing Drizzle
139	21-Jul-11	AAF1	13.7	83.4	-10.1	Al. Plate	Freezing Drizzle
149	21-Jul-11	AAF1	24.6	57.8	-10.2	Al. Plate	Light Freezing Rain
151	21-Jul-11	AAF1	24.6	59.8	-10.2	Al. Plate	Light Freezing Rain
88	20-Jul-11	AAF2	12.2	72.7	-3.4	Al. Plate	Freezing Drizzle
102	20-Jul-11	AAF2	12.8	106.5	-6.2	Al. Plate	Light Freezing Rain
114	20-Jul-11	AAF2	25.4	61.3	-6.3	Al. Plate	Light Freezing Rain
116	20-Jul-11	AAF2	24.9	66.8	-6.2	Al. Plate	Light Freezing Rain
126	20-Jul-11	AAF2	5.2	114.3	-10.4	Al. Plate	Freezing Drizzle
128	21-Jul-11	AAF2	5.2	117.4	-10.4	Al. Plate	Freezing Drizzle
138	21-Jul-11	AAF2	13.0	92.7	-10.1	Al. Plate	Freezing Drizzle
140	21-Jul-11	AAF2	13.7	80.7	-10.1	Al. Plate	Freezing Drizzle
150	21-Jul-11	AAF2	24.4	54.1	-10.2	Al. Plate	Light Freezing Rain
152	21-Jul-11	AAF2	24.6	63.2	-10.2	Al. Plate	Light Freezing Rain

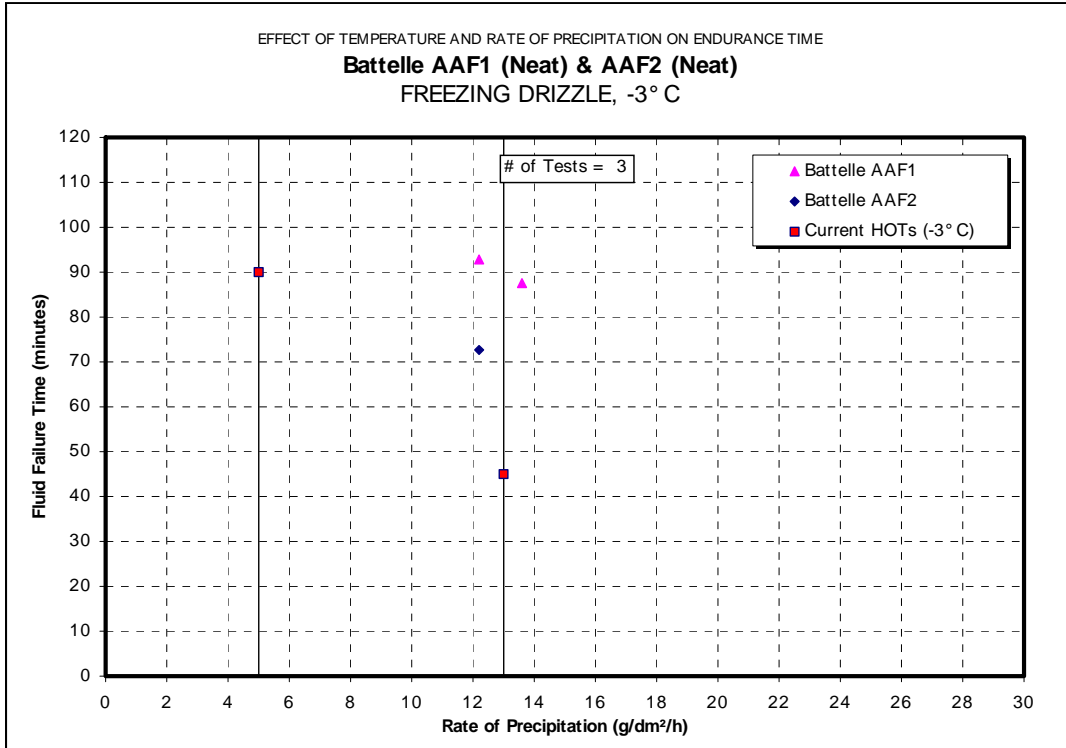

Figure 34. Endurance Testing of Battelle AAF1 and AAF2 Compared to a Generic Type IV Fluid

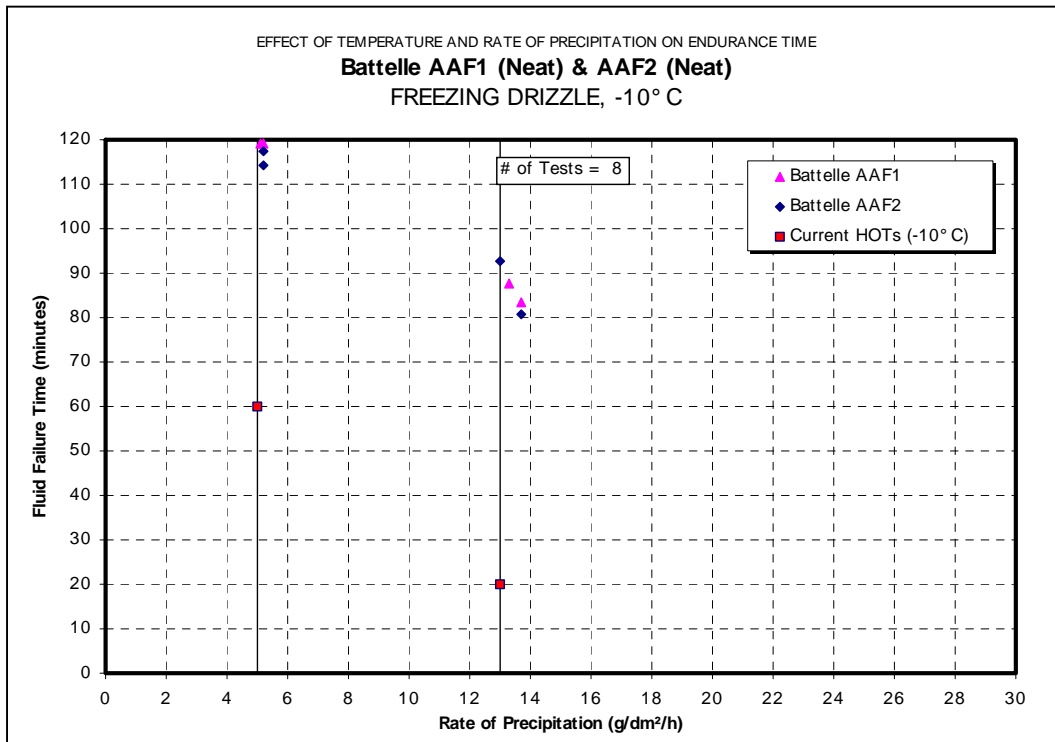

Figure 35. Endurance Testing of Battelle AAF1 and AAF2 Compared to a Generic Type IV Fluid

Subsequently, the full-scale HOT testing was done for AAF3. The full report for this testing is awaited, but the results were presented at the SAE G-12 meeting in Prague, Czech Republic, in May 2012.⁽³⁹⁾ The key results are proved in Appendix E. The summary of HOT times, which are generally better than for generic Type II AAFs, is provided in Table 12; the numbers in red for two cells indicate “no holdover time guidelines exist”. This fluid had a WSET exceeding 80 minutes, which is significant for Type IV qualification, but one of the cells for HOT tables showed a slightly lower value than for generic Type IV. Therefore, the fluid was HOT-certified as a Type II fluid. It is anticipated that AAF4 will be certified as a Type IV AAF, which required a small increase in viscosity. The AMS 1428 testing for AAF4 is underway.

Table 12. Type II Holdover Times

Outside Air Temperature ²		Type II Fluid Concentration Neat Fluid/Water (Volume %/Volume %)	Approximate Holdover Times Under Various Weather Conditions (hours:minutes)					
Degrees Celsius	Degrees Fahrenheit		Freezing Fog	Snow, Snow Grains or Snow Pellets ³	Freezing Drizzle ⁴	Light Freezing Rain	Rain on Cold Soaked Wing ⁵	Other ⁶
-3 and above	27 and above	100/0	1:45 – 3:00	0:50 – 1:10	1:20 – 1:40	0:40 – 1:05	0:20 – 1:30	CAUTION: No holdover time guidelines exist
		75/25	1:00 – 1:45	0:30 – 0:50	0:35 – 1:05	0:20 – 0:35	0:10 – 1:15	
		50/50	0:25 – 0:40	0:10 – 0:15	0:15 – 0:25	0:07 – 0:15		
below -3 to -14	below 27 to 7	100/0	0:45 – 2:35	0:15 – 0:30	0:30 – 1:40 ⁷	1:00 – 1:25 ⁷		
		75/25	0:25 – 1:20	0:10 – 0:20	0:25 – 1:15 ⁷	0:35 – 0:50 ⁷		
below -14 to TBD	below 7 to TBD	100/0	0:20 – 0:45	0:15 – 0:30				

4.4 DOWN SELECTION OF AAFs FOR FIELD TESTING

Based on the results to date, the following AAFs are characterized enough to serve as basis for field testing under ESTCP and commercial-airport testing:

- AAF4 (Type IV) – This is a tweak of AAF1 and is based on PG as FPD. It is currently in the process of AMS 1428 certification. One of Battelle’s industrial partners will spray test it before flight testing.
- AAF2 (Type IV) – A tweaked version of this AAF is likely to pass certification later in 2012, so as to be available for field testing in Winter of 2013/14. This AAF is a non-glycol fluid using a mixture of PG and a non-glycol polyol FPDs.
- AAF3 (Type II) – This fluid has been partly certified, under HOT testing. The rest of the certification is underway. The properties of AAF3 are similar to AAF4 but it barely misses the HOT requirement for a Type IV for one set of precipitation conditions, so it is currently certified as a Type II fluid. One of Battelle’s industrial partners plans to field test it in the coming 2012/13 Winter.

4.5 IMPROVED ADF DEVELOPMENT

Battelle, partly in support from ESTCP, has previously developed a patented ADF (Type I) fluid for aircraft deicing/anti-icing. This fluid has been in commercial use since Winter of 2008/09, and is sold by Octagon (now Clariant) under the brand name of EcoFlo. The majority of the FPD in this ADF is a non-glycol, bio-based, and a lower COD fluid. It also was found to have a lower ecotoxicity and a lower cadmium corrosion rate. However, it uses a phosphate buffer and it is desirable to minimize the use of phosphates in products that get into the water bodies.

Using the knowledge gained from the current project on AAF development, the composition of the EcoFlo was altered, by using a little less of the non-glycol FPD and by eliminating about 75 percent of the phosphates. The resulting product, called EcoFlo 2, was fully certified in this project. The AMS 1424 certification data are shown in Appendix F and the results from HOT testing are provided in Appendix G.

The changes allowed the ADF to maintain the freeze point performance at typical deicing conditions. However, the freeze point of the neat fluid was greatly reduced from -26°C to -41°C. This will allow long-term storage of the fluid under very cold climates.

A second major improvement was in the viscosity, which was significantly reduced as shown in Table 13. The reduced viscosity should help better shed the ADF during airplane take off.

Table 13. EcoFlo vs. EcoFlo 2 Viscosity as a Function of Temperature

Temperature °C	EcoFlo Viscosity cP	EcoFlo 2 Viscosity cP
0	215	170
-10	500	365
-20	1350	900

While the ADF properties were improved, as discussed above, the superior COD and ecotoxicity performance was maintained as shown in Figures 36 and 37.

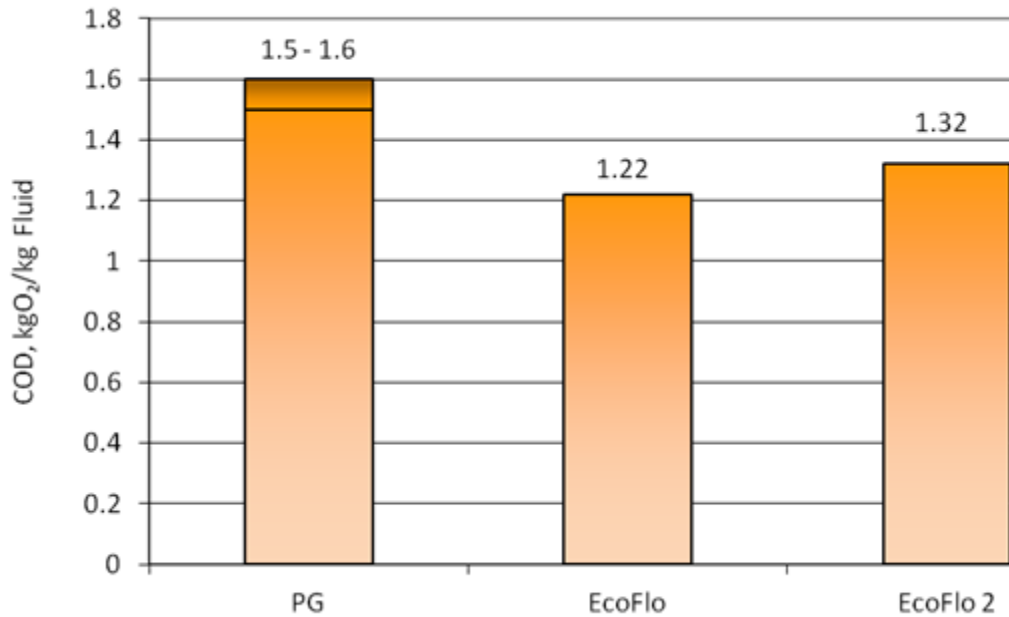

Figure 36. COD Comparison of Typical Range for PG ADF vs. EcoFlo and EcoFlo 2

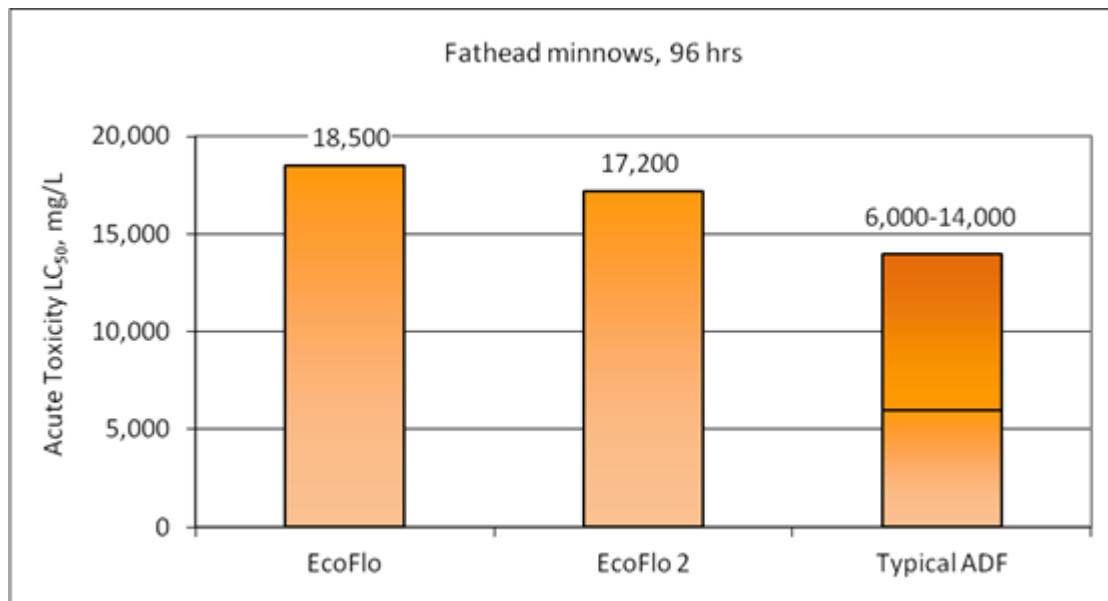

Figure 37. Acute Toxicity (LC₅₀) for Fathead Minnow, 96 hours, for EcoFlo, EcoFlo 2, and Typical Range for PG-based ADFs

As required for all non-glycol Type I fluids (ADFs), a complete set of HOT tests were performed by APS and Transport Canada. It was concluded by APS that “EcoFlo 2 could be used as a Type I fluid with the generic Type I HOT guidelines.” The detailed results are shown in Appendix G.

4.6 COST BENEFIT ANALYSIS FOR AAF

A cost comparison was conducted on two Battelle AAFs (AAF1, PG-based and AAF2, non-glycol-based) and a typical PG-based commercial formulation. The cost was determined by using average prices on raw materials and manufacturing. Both AAFs were less than the commercial fluid as shown in Table 14. The total costs for these fluids do not include any profit or shipping costs.

Table 14. Raw Material and Manufacturing Cost Comparison

	PG Based Fluid	AAF1	AAF2
Raw Materials Cost, \$/lb	4.71	4.54	4.14
Manufacturing Cost, \$/gal	0.83	0.57	0.57
Total Cost, \$/gal	5.55	5.11	4.70

Both AAF1 and AAF2 are suitable for drop-in replacements to PG-based fluids. Not only are they lower to manufacture but they have added benefits such as lower toxicity, lower corrosivity, and AAF2 has a lower COD. These benefits are more difficult to estimate and compare to a commercial fluid.

5.0 CONCLUSIONS AND IMPLICATIONS FOR FUTURE RESEARCH/IMPLEMENTATION

5.1 CONCLUSIONS

The primary focus of the proposed project was to develop and evaluate an environmentally-friendly and low-residue Type IV Aircraft Anti-icing Fluid (AAF) that is compatible with various Aircraft Deicing Fluids (ADFs), as well as aircraft materials. A second objective was to potentially further improve the performance of EcoFlo, a Battelle-developed ADF, based on the results from AAF development. This new AAF would be superior to currently available AAFs in terms of one or more properties: (a) reduced BOD and chemical oxygen demand (COD); (b) reduced ecotoxicity; (c) reduced carbon footprint by using bio-based ingredients; (d) reduced tendency for leaving gel-forming residues; (e) reduced corrosivity; (f) free of alkylphenol ethoxylate (APE) surfactants; and (g) free of benzotriazole corrosion inhibitor. Additionally, this new AAF would need to be cost effective, compatible with ADFs, and compatible with military-unique aircraft materials and components.

The project findings were very positive and the goals have been exceeded as most of the target properties were actually improved. As a result, the prospects for rapid commercialization of at least one AAF are excellent. Specific accomplishments included the following:

1. Against the Go/No-Go criterion of having developed at least one improved AAF with likelihood of AMS 1428 certification, three such AAFs with improved environmental and materials-compatibility properties were developed and are nearing certification. All are based on (a) replacement of APE surfactants, (b) replacement of triazole corrosion inhibitors, and (c) replacement of non-biodegradable anti-precipitant. In addition, one of three AAFs had a lower carbon footprint and a lower COD/BOD₅.
2. While the commercial PG-based AAFs have fish (*Pimephales promeles*) LC₅₀, which is inversely proportional to ecotoxicity, values in the range of 500 to 1,000 mg/L, the AAFs in this project have an LC₅₀ of 1,475 mg/L. This indicates roughly a 50 percent reduction in ecotoxicity, made possible by replacement of more toxic additives.
3. The new AAFs are all free of anti-foamers as the new surfactants were low foaming.
4. The new AAFs were found to have a “low” Gel Forming Potential (GFP).
5. The HOT testing of three AAFs showed that the endurance times were higher than those for generic fluids, especially for undiluted (neat) fluids.
6. Two AAFs were thoroughly tested under the MTMS protocol for U.S. Military aircraft materials and found to be better than for previously tested commercial Type II and IV AAFs.
7. A cost-benefit analysis was completed for one PG-based and one non-glycol AAF. Both AAFs turned out to be drop-in substitutes with a lower material and production

cost. While some benefits of lower ecotoxicity, lower corrosivity, and lower COD (for one AAF) were identified, the same were not so easy to quantify, hence the lower cost of the new fluids was judged to be the primary benefit in terms of economics.

8. A thorough analysis of various formulation parameters for AAFs was carried out and documented in this report. Previously, such work has not been published and maintained as a trade secret.
9. An improved Type I fluid (ADF) was developed and fully certified to support field testing under an ESTCP project.
10. The results of the HOT testing were presented at an SAE G-12 Committee Meeting in 2012⁽³⁹⁾, and a patent application, filed in 2010, was published in 2011⁽⁴⁰⁾.

5.2 FUTURE RESEARCH AND TECHNOLOGY TRANSITION/IMPLEMENTATION

Based on the results from this project, three AAFs, two Type IVs and one Type II, appear worthy of field testing on military and commercial aircrafts. Of the two Type IV fluids, one is based on use of PG, while the other one is a non-glycol. These three AAFs are candidates for potential commercial use at military and civilian airports. Several thousand gallons of these three AAFs will need to be manufactured with help from a commercial AAF vendor, who participated in this project, and then tested. Such a demonstration will likely involve various stakeholders, including military and commercial users, vendors, FAA, and U.S. EPA.

6.0 REFERENCES

1. Corsi, S.R., et al., "Aquatic Toxicity of Nine Aircrafts Deicer and Anti-icer Formulations and Relative Toxicity of Additive Package Ingredients Alkylphenol Ethoxylates and Benzotriazoles", Environmental Science and Technology, 40 (23), 749-7415 (2006).
2. "Holdover Time Guidelines", Transport Canada website <http://www.tc.gc.ca>.
3. Wyderski, M., "AFMC Aircraft and Runway Deicing/Anti-icing Initiatives," SAE G-12 Meeting, San Diego, CA (May 14, 2007).
4. McKinnon, L., and White, A., "C130 Hercules and CP140 Aurora Aircraft Anti-icing Fluid Flight Testing," paper presented at the SAE Aircraft & Engine Icing and Deicing International Conference, Seville, Spain (September 2007).
5. Draft of proposed "Airport Deicing Effluent Guidelines," Proposed Rule No. EPA-HQ-OW-2004-0038 (Dec 2009).
6. Mericas, D., and Corsi, S., "Airport Research Cooperative Program Update," SAE G-12 Meeting, San Diego, CA (May 14, 2007).
7. Dyer, K. P., "Anti-Icing Fluid Residues," Paper No. 2007-07-3301 presented at the SAE Aircraft & Engine Icing and Deicing International Conference, Seville, Spain (September 2007).
8. "Materials Compatibility Final Test Report", a report submitted to the NDCEE Program Office by Concurrent Technologies Corporation, Task No. 0462 AF1, January 2011.
9. Chauhan, S.P., et al., "Deicing/Anti-Icing Fluids," US Patent No. 7,105,105, September 12, 2006.
10. Chauhan, S.P., et al., "Bio-based Deicing/Anti-icing Fluid", US Patent NO. 7,169,321, January 30, 2007.
11. Conkle, H. N., et al., "Environmentally-Friendly, Non-Glycol Type I Aircraft Deicing Fluid," paper presented at the 2003 FAA In-Flight Icing and Ground Deicing International Conference, Chicago, IL (August 16-20, 2003).
12. Kirk Othmer, Encyclopedia of Chemical Technology
13. Whistler, R.L. and BeMiller, J.M., Industrial Gums: Polysaccharides and Their Derivatives (3rd Ed.), Academic Press, San Diego (1993).
14. Lockeyer, et al., "Environmentally-Friendly Anti-icing", U.S. Patent No. 5,772,912 (June 1998).
15. "Polymeric Emulsifiers", product literature from Noveon Specialty Chemicals Co., 2003.
16. ACRP Web-Only Document 3; "Aircraft Deicing and Airfield Anti-Icing Formulations: Aquatic Toxicity and BOD," report for ACRP project 02-01 (Nov 2008).
17. Unknown, <http://www.metalprotection.com/apps.htm>, in: 2009.
18. Castro, S., Davis, L. C., Erickson, L. E., Environmental Prog. 24 (2005) 26-33.
19. Cornell, J. S., Pillard, D. A., Hernandez, M. T., Environmental Toxicology and Chemistry, 19 (2000) 1465-1472.
20. Allam, N. K., Nazeer, A. A., Ashour, E. A., J. Appl. Electrochem. 39 (2009) 961-969.
21. Antonijevic, M. M., Petrovic, M. B., Int. J. Electrochem. Sci. 3 (2008) 1-28.
22. Hefter, G. T., North, N. A., Tan, S. H., Corrosion 53 (1997) 657-667.
23. Abdullah, M., Bulletin of Electrochemistry 13 (1997) 149-155.
24. Amirudin, A., Barreau, C., Hellouin, R., Thierry, D., Progress in Organic Coatings, 25 (1995) 339-355.

25. Lebrini, M., Fontaine, G., Gengembre, L., Traisnel, M., Lerasle, O., Genet, N., Corrosion Science, 51 (2009) 1201-1206.
26. Migahed, M. A., Azzam, E. M. S., Al-Sabagh, A. M., Materials Chemistry and Physics, 85 (2004) 273-279.
27. Rammelt, U., Koehler, S., Reinhard, G., Corrosion Science, 51 (2009) 921-925.
28. Georges, C., Rocca, E., P. Steinmetz, Electrochimica Acta, 53 (2008) 4839-4845.
29. Gunasekaran, G., Natarajan, R., Muralidharan, V. S., Palaniswamy, N., Appa Rao, B. V., Anti-Corrosion Methods and Materials, 44 (1977) 248-259.
30. To, X. H., Pebere, N., Pelaprat, N., Boutevin, B., Hervaud, Y., Corrosion Science, 39 (1997) 1925-1934.
31. Yamamoto, Y., Nishihara, H., Aramaki, K., J. Electrochem. Soc., 140 (1993) 436-443.
32. Maayta, A. K., Al-Rawashdeh, Corrosion Science, 46 (2004) 1129-1140.
33. El-Dahan, H. A., Soror, T. Y., El-Sherif, R. M., Materials Chemistry and Physics, 89 (2005) 260-267.
34. Li, P., Tan, T. C., Lee, J. Y., Corrosion, 53 (1997) 186-194.
35. Lamka, S. V., Zheludkevich, M. L., Yasakau, K. A., Montemor, M. F., Ferreira, M. G. S., Electrochimica Acta, 52 (2007) 7231-7247.
36. Hurley, B. L., McCreery, R. L., J. Electrochem. Soc., 151 (2004) B252-B259.
37. Chauhan, S.P., et.al., "Development of Environmentally Benign and Reduced Corrosion Runway Deicing Fluid", SERDP Project SI-1535 Final Reports (August 2009).
38. Beisswenger, A. and Perron, J., "Laboratory Testing of Aircrafts Anti-icing Fluid Rehydrated Gel Residues", Paper No. 2007-01-3303 presented at the SAE Aircraft & Engine Icing and Deicing International Conference, Seville, Spain (September 2007).
39. Benedickson, Stephanie, "Winter 2011-12 Aircraft De/Anti-icing Fluid Endurance Time Testing Results (for AAF3/LNT250 and EcoFlo2)", presented at SAE G-12 Committee Meeting, Prague, Czech Republic, May 8, 2012.
40. Chauhan, Satya P., et. Al., "Compositions for Deicing/Anti-icing", International Patent Application No. WO 2011/103295 A1, published August 25, 2011.

7.0 APPENDIX

7.1 SUPPORTING DATA

APPENDIX A: AMS 1428 Specifications

APPENDIX B: USAF Military Test Method Standard (MTMS) Testing
(prepared by AFRL and CTC)

APPENDIX C: AMS 1428 Certification by SMI for AAF1

APPENDIX D: Holdover Time (HOT) Report for AAF1 and AAF2

APPENDIX E: Selected Results for Holdover Time (HOT) Testing of AAF3

APPENDIX F: AMS 1424 Certifications for EcoFlo2 ADF

APPENDIX G: Holdover Time (HOT) Results for EcoFlo2 ADF

7.2 LIST OF TECHNICAL PUBLICATIONS

1. Benedickson, Stephanie, “Winter 2011-12 Aircraft De/Anti-icing Fluid Endurance Time Testing Results (for AAF3/LNT250 and EcoFlo2)”, presented at SAE G-12 Committee Meeting, Prague, Czech Republic, May 8, 2012.
2. Chauhan, Satya P., et. Al., “Compositions for Deicing/Anti-icing”, International Patent Application No. WO 2011/103295 A1, published August 25, 2011.

APPENDIX A
AMS 1428 Specifications

Fluid, Aircraft Deicing/Anti-Icing, Non-Newtonian
(Pseudoplastic), SAE Types II, III, and IV

RATIONALE

This specification has been revised to incorporate the following: A reference to ARP5718, Qualification Process for SAE AMS1428 Type II, III, and IV Fluids (1.5); changes to the inspection of the plates in the Dry-Out by Exposure to Cold Dry Air (3.2.2.3) and the Thin Film Thermal Stability (3.2.2.5) tests; changes to the Hard Water Stability (3.2.2.8) test to make it more consistent with the Thermal Stability (3.2.2.1) test; changes to the Lot Acceptance Tests (4.2.1) to allow viscosity to be tested at 0 °C or 20 °C; and changes to The Successive Dry-Out And Rehydration Test (Appendix A).

TABLE OF CONTENTS

1.	SCOPE.....	3
1.1	Form.....	3
1.2	Application.....	3
1.3	Precautions	4
1.4	Safety - Hazardous Materials.....	4
1.5	Fluid Qualification.....	4
2.	APPLICABLE DOCUMENTS.....	4
2.1	SAE Publications.....	5
2.2	ASTM Publications.....	6
2.3	U.S. Government Publications.....	7
2.4	APHA Publications.....	7
2.5	OECD Publications.....	7
3.	TECHNICAL REQUIREMENTS.....	7
3.1	Material	7
3.2	Physical Properties	8
3.3	Fluid Tested Both Neat and as a Diluted Solution.....	14
4.	QUALITY ASSURANCE PROVISIONS.....	16
4.1	Responsibility for Inspection	16
4.2	Classification of Tests	16
4.3	Sampling and Testing	17
4.4	Approval.....	17
4.5	Reports.....	18
4.6	Re-sampling and Retesting.....	18
5.	PREPARATION FOR DELIVERY.....	18
5.1	Packaging and Identification.....	18

SAE Technical Standards Board Rules provide that: "This report is published by SAE to advance the state of technical and engineering sciences. The use of this report is entirely voluntary, and its applicability and suitability for any particular use, including any patent infringement arising therefrom, is the sole responsibility of the user."

SAE reviews each technical report at least every five years at which time it may be reaffirmed, revised, or cancelled. SAE invites your written comments and suggestions.

Copyright © 2010 SAE International

All rights reserved. No part of this publication may be reproduced, stored in a retrieval system or transmitted, in any form or by any means, electronic, mechanical, photocopying, recording, or otherwise, without the prior written permission of SAE.

TO PLACE A DOCUMENT ORDER: Tel: 877-606-7323 (inside USA and Canada)
Tel: 724-776-4970 (outside USA)
Fax: 724-776-0790
Email: CustomerService@sae.org
http://www.sae.org

SAE WEB ADDRESS:

**SAE values your input. To provide feedback
on this Technical Report, please visit
<http://www.sae.org/technical/standards/AMS1428G>**

6.	ACKNOWLEDGMENT	19
7.	REJECTIONS	19
8.	SIMILAR SPECIFICATIONS.....	19
9.	NOTES	19
APPENDIX A	SUCCESSIVE DRY OUT AND REHYDRATION TEST FOR DEICING/ANTI-ICING FLUID	20
TABLE 1	CLASSIFICATION.....	3
TABLE 2	FLUID CYCLING PERIOD	12
TABLE 3	MINIMUM ANTI-ICING PERFORMANCE	13
TABLE 4	TOTAL IMMERSION CORROSION	15

1. SCOPE

1.1 Form

This specification covers three types of deicing/anti-icing material, each in the form of a non-Newtonian fluid.

1.1.1 Classification

Deicing/anti-icing fluids covered by this specification are classified as follows:

TABLE 1 - CLASSIFICATION

Fluid SAE Type	Anti-Icing Performance Use Table 3 (3.2.4.1)	Aerodynamic Performance Use SAE AS5900 (See Note)	Color Applicable if Requested
Type II	II	High Speed Ramp Test	Water white/pale straw
Type III	III	Low Speed Ramp Test	Bright Yellow
Type IV	IV	High Speed Ramp Test	Green

NOTE: As per 3.2.5.2, any fluid can be tested in accordance with the AS5900 high speed ramp test and/or low speed ramp test to demonstrate acceptable aerodynamic performance. The designations in Table 1 are for fluid classification purposes only. Consult the fluid manufacturer for complete aerodynamic test data.

1.1.2 Non-Newtonian

A fluid defined as non-Newtonian exhibits a different apparent viscosity value when tested at the same temperature, using the same viscometer and spindle in a predetermined volume when the only variant is the rotational speed of the spindle. Typically, the non-Newtonian fluid shear stress is not in direct proportion to its rate of flow.

1.1.3 Pseudoplastic

A fluid described as pseudoplastic shall exhibit reduced apparent viscosity values as the spindle speed is increased, and revert to original flow behavior when the shear stress is removed. This shall be demonstrable at the temperatures listed in 3.2.3.2.

1.2 Application

This fluid may be used as follows:

- a. Unheated and undiluted, or diluted for anti-icing
- b. Heated and undiluted for deicing/anti-icing as a one step process
- c. Diluted with water and heated for deicing/anti-icing, as a one step process
- d. Diluted with water and heated as the deicing stage in a two-step process, usually when used with the unheated and undiluted fluid as step two

CAUTION: SAE Type II, III and IV fluid, especially when used in a one step process or in the first step of a two step process, may cause residues to collect in aerodynamically quiet areas, cavities and gaps. These residues can affect flight safety. Refer to ARP4737.

- 1.2.1 Consult aircraft manufacturer's Aircraft Operations Manual, Aircraft Maintenance Manual and service letters to determine any restrictions relating to the use of deicing/anti-icing fluids meeting this specification for the type and model of aircraft being treated. Refer also to ARP4737.

1.3 Precautions

- 1.3.1 The lowest operational use temperature (LOUT) for a SAE Type II, III, and IV fluid shall be determined for the neat (undiluted) fluid or for each intended use dilution and is the lowest temperature at which the fluid has been tested and certified as acceptable in accordance with the appropriate aerodynamic acceptance test (3.2.5) while still maintaining the 7 °C (13 °F) freezing point temperature buffer (See ARP4737). The fluid manufacturers' literature shall clearly state the LOUT for the neat fluid and intended use dilutions.
- 1.3.2 The deicing/anti-icing formulation may be mildly toxic and contact with human skin and eyes should be avoided. Prolonged exposure to concentrations of vapor or windborne mists should be avoided. Consult the fluid manufacturers' Material Safety Data Sheet for further information.
- 1.3.3 Caution should be exercised in the use of glycol-water deicing/anti-icing solutions in and around electrical/electronic circuitry with noble metal coated wiring or terminals which could make contact with the fluid. Exothermic reactions, which may result in fire have been reported. This may occur where defectively insulated wires, switches, or circuit breakers carrying direct current are encountered. Fluids based on glycol shall contain an inhibitor to minimize this potential fire hazard.
- 1.3.4 A fluid meeting this specification is unique to each manufacturer and may be adversely affected by mixing with other aircraft deicing/anti-icing fluids.
- 1.3.5 Slippery conditions may exist on the ground, or equipment following the deicing/anti-icing procedure.
- 1.3.6 Deicing/anti-icing fluids should be compatible with carbon brake material. Refer to ARP4737 and the airplane manufacturer's maintenance and service documents for further information on fluid use. An industry standard test method for compatibility is under development.

1.4 Safety - Hazardous Materials

While the materials, methods, applications, and processes described or referenced in this specification may involve the use of hazardous materials, this specification does not address the hazards which may be involved in such use. It is the sole responsibility of the user to ensure familiarity with the safe and proper use of any hazardous materials and processes and to take necessary precautionary measures to ensure the health and safety of all personnel involved.

1.5 Fluid Qualification

It is not sufficient for a SAE type II, III, or IV fluid to meet all of the requirements of AMS1428 for airlines to be able to use it. For such a fluid to be used commercially, it must also have holdover time guidelines and be identified on a list of qualified fluids acceptable to regulators. For information on the qualification process of an AMS1428 fluid, refer to ARP5718.

2. APPLICABLE DOCUMENTS

The issue of the following documents in effect on the date of the purchase order forms a part of this specification to the extent specified herein. The supplier may work to a subsequent revision of a document unless a specific document issue is specified. When the referenced document has been cancelled and no superseding document has been specified, the last published issue of that document shall apply.

2.1 SAE Publications

Available from SAE International, 400 Commonwealth Drive, Warrendale, PA 15096-0001, Tel: 877-606-7323 (inside USA and Canada) or 724-776-4970 (outside USA), www.sae.org.

AMS2470	Anodic Treatment of Aluminum Alloys, Chromic Acid Process
AMS2475	Protective Treatments, Magnesium Alloys
AMS2825	Material Safety Data Sheets
AMS4037	Aluminum Alloy, Sheet and Plate, 4.4Cu - 1.5Mg - 0.60Mn (2024; -T3 Flat Sheet, -T351 Plate), Solution Heat Treated
AMS4041	Aluminum Alloy, Alclad Sheet and Plate, 4.4Cu - 1.5Mg - 0.60Mn, Alclad 2024 and 1-1/2% Alclad 2024, -T3 Flat Sheet; 1-1/2% Alclad 2024-T351 Plate
AMS4049	Aluminum Alloy, Sheet and Plate, Alclad, 5.6Zn - 2.5Mg - 1.6Cu - 0.23Cr (Alclad 7075; -T6 Sheet - T651 Plate), Solution and Precipitation Heat Treated
AMS4376	Plate, Magnesium Alloy, 3.0Al - 1.0Zn - 0.20Mn (AZ31B-H26), Cold Rolled and Partially Annealed
AMS4911	Titanium Alloy, Sheet, Strip, and Plate, 6Al - 4V, Annealed
AMS4916	Titanium Alloy Sheet, Strip, and Plate, 8Al - 1Mo - 1V, Duplex Annealed
AMS5045	Steel, Sheet and Strip, 0.25 Carbon, Maximum, Hard Temper
AMS5886	Alloy, Corrosion and Heat-Resistant, Bars, Forgings, and Rings, 50Ni - 20Cr - 20Co - 5.8Mo - 2.2Ti - 0.45Al, Consumable Electrode or Vacuum Induction Melted, 2100 °F (1149 °C) Solution Heat Treated
AMS-P-83310	Plastic Sheet, Polycarbonate, Transparent
AIR9968	Viscosity Test of Thickened Aircraft Deicing/Anti-icing Fluids
ARP1917	Clarification of Terms Used in Aerospace Metals Specifications
ARP4737	Aircraft Deicing/Anti-icing Methods
ARP5485	Endurance Time Tests for Aircraft Deicing/Anti-icing Fluids SAE Types II, III, and IV
ARP5718	Qualification Process for SAE AMS1428 Type II, III, and IV Fluids
AS5900	Standard Test Method for Aerodynamic Acceptance for SAE AMS 1424 and SAE AMS 1428 Aircraft Deicing/Anti-icing Fluids
AS5901	Water Spray and High Humidity Endurance Test Methods for SAE AMS1424 and SAE AMS1428 Aircraft Deicing/Anti-icing Fluids

2.2 ASTM Publications

Available from ASTM International, 100 Barr Harbor Drive, P.O. Box C700, West Conshohocken, PA 19428-2959, Tel: 610-832-9585, www.astm.org.

- ASTM C 672 Scaling Resistance of Concrete Surfaces Exposed to De-icing Chemicals
- ASTM D 93 Flash Point by Pensky-Martens Closed Cup Tester
- ASTM D 891 Specific Gravity, Apparent, of Liquid Industrial Chemicals
- ASTM D 1177 Freezing Point of Aqueous Engine Coolants
- ASTM D 1193 Reagent Water
- ASTM D 1331 Surface and Interfacial Tension of Solutions of Surface-Active Agents
- ASTM D 1568 Sampling and Chemical Analysis of Alkylbenzene Sulfonates
- ASTM D 1747 Refractive Index of Viscous Materials
- ASTM D 2196 Rheological Properties of Non-Newtonian Materials by Rotational (Brookfield Type) Viscometer
- ASTM D 3278 Flash Point of Liquids by Small Scale Closed Cup Apparatus
- ASTM D 4052 Density and Relative Density of Liquids by Digital Density Meter
- ASTM D 4177 Automatic Sampling of Petroleum and Petroleum Products
- ASTM E 70 pH of Aqueous Solutions with the Glass Electrode
- ASTM F 483 Total Immersion Corrosion Test for Aircraft Maintenance Chemicals
- ASTM F 484 Stress Cracking of Acrylic Plastics in Contact with Liquid or Semi-Liquid Compounds
- ASTM F 485 Effects of Cleaners on Unpainted Aircraft Surfaces
- ASTM F 502 Effects of Cleaning and Chemical Maintenance Materials on Painted Aircraft Surfaces
- ASTM F 519 Mechanical Hydrogen Embrittlement Evaluation of Plating Processes and Service Environments
- ASTM F 945 Stress Corrosion of Titanium Alloys by Aircraft Engine Cleaning Materials
- ASTM F 1105 Preparing Aircraft Cleaning Compounds, Liquid Type, Temperature-Sensitive, or Solvent-Based, for Storage Stability Testing
- ASTM F 1110 Sandwich Corrosion Test
- ASTM F 1111 Corrosion of Low-Embrittling Cadmium Plate by Aircraft Maintenance Chemicals

2.3 U.S. Government Publications

Available from the Document Automation and Production Service (DAPS), Building 4/D, 700 Robbins Avenue, Philadelphia, PA 19111-5094, Tel: 215-697-6257, <http://assist.daps.dla.mil/quicksearch/>.

MIL-PRF-25690 Plastic, Sheets and Formed Parts, Modified Acrylic Base, Monolithic, Crack Propagation Resistant

MIL-STD-870 Cadmium Plating, Low Embrittlement, Electrodeposited

2.4 APHA Publications

Available from American Public Health Association, 1015 Fifteenth Street, NW, Washington, DC 20005 or www.apha.org.

Standard Methods for the Examination of Water and Waste Water

2.5 OECD Publications

Available from OECD: 2, rue André Pascal, Cedex 16, 75016 Paris, FRANCE or www.oecd.org.

OECD Guidelines for Testing Chemicals

3. TECHNICAL REQUIREMENTS

3.1 Material

The composition of the fluid shall be optional to the manufacturer and shall be based on freezing point depressants with additives, such that the finished product shall meet the requirements of this specification.

3.1.1 Non-Glycol Based Fluid

A fluid based on non-glycol freezing point depressants shall be tested as follows: Two pieces of AMS5886 bar, 35 mm diameter and 15 mm long shall have one end of each machined flat. An 8.5 mm drill shall then be used to drill a centered hole 6.5 mm deep in one end to allow the milling of a cup shaped depression. A 12.5 mm bull nosed end mill shall be used to open up the drilled hole to produce a 7 mm deep depression. The cup shall then be finished by improving the surface with 600, 180, and 6 micrometers diamond paste. The cups shall be cleaned and degreased using a suitable solvent and allowed to dry. One cup shall be filled with the candidate test fluid, the other with water conforming to ASTM D 1193 Type IV, both test pieces shall then be placed in an oven at $105\text{ }^{\circ}\text{C} \pm 2$ ($221\text{ }^{\circ}\text{F} \pm 4$). The fluid shall then be allowed to evaporate by progressive increase in oven temperature at the rate of $10\text{ }^{\circ}\text{C}$ ($18\text{ }^{\circ}\text{F}$) per minute to a final temperature of $250\text{ }^{\circ}\text{C} \pm 5$ ($482\text{ }^{\circ}\text{F} \pm 9$) where they shall be maintained for 15 minutes ± 1 . Test pieces shall then be transferred to an air furnace set at $1040\text{ }^{\circ}\text{C} \pm 10$ ($1904\text{ }^{\circ}\text{F} \pm 18$) and maintained for 2 hours ± 5 minutes.

Test pieces shall be removed and allowed to cool to ambient temperature. Microscopic examination of the polished cups at 500X shall be undertaken. No corrosion worse than that of the control cup shall be evident in the candidate test fluid cup.

The report shall include photographs of both cups after testing and the candidate test fluid cup shall be identified.

3.1.2 Toxicity

The user shall ensure that the fluid meets all local, state, and/or federal toxicity regulations. The information to satisfy the federal, state, and provincial requirements shall be provided by the manufacturer, and for local requirements, upon request, from the user.

3.1.3 Appearance

The fluid, as received by purchaser, shall be homogeneous, uniform in color (See Table 1), and free from skins, lumps, and foreign materials which would be detrimental to usage of the product. The fluid may be clear or translucent - as described by the manufacturer.

3.1.4 Environmental Information

Formulated fluid shall be tested in accordance with APHA "Standard Methods for the Examination of Water and Waste Water". The manufacturer shall provide results for not less than the following:

3.1.4.1 Biochemical Oxygen Demand (BOD)

The fluid shall be incubated at 20 °C (68 °F) for 5, 15, 20, or 28 days dependent upon the method chosen, and the BOD determined.

3.1.4.2 Total Oxygen Demand (TOD) or Chemical Oxygen Demand (COD)

The TOD or COD of the fluid, expressed in kilograms of oxygen per kilogram of fluid, shall be determined.

3.1.4.3 Biodegradability

This characteristic can be approximated by determining the ratio of BOD to TOD or COD. The percent of fluid biodegraded can be calculated by dividing BOD by TOD or COD, and shall be reported for the incubation time periods specified in the chosen test method.

3.1.4.4 Aquatic Toxicity

The fluid shall be tested in accordance with EPA 40 CFR 797.1300 and 794.14, revised July 1, 1989, or OECD (Organization for Economic Cooperation and Development Guidelines for Testing of Chemicals), methods 202 and 203 using test species required by regulatory agencies for permitted discharges. Examples include fathead minnows, daphnia magna and rainbow trout. The LC50 concentration, (the highest concentration at which 50% of the organisms do not survive the test period) shall be stated in milligrams per liter.

3.1.5 Trace Contaminants

Report the presence, in percentages by weight or parts per million by weight, of sulfur, halogens, phosphate, nitrate, and heavy metals (lead, chromium, cadmium, and mercury). Report the test method used and detection limits.

3.2 Physical Properties

The fluid shall conform to the following requirements; tests shall be performed in accordance with the specified test methods.

3.2.1 Fluid as Received in Neat Form

3.2.1.1 Flash Point

Shall be not lower than 100 °C (212 °F) determined in accordance with ASTM D 93 or ASTM D 3278. In case of dispute, the flash point determined in accordance with ASTM D 93 shall apply.

3.2.1.2 Specific Gravity

Shall be within ± 0.015 units of the preproduction value, determined in accordance with ASTM D 891 or ASTM D 4052.

3.2.1.3 pH

Shall be within ± 0.5 units of the preproduction value, determined in accordance with ASTM E 70.

3.2.1.4 Refractive Index

Shall be within ± 0.0015 units of the preproduction value, determined in accordance with ASTM D 1747.

3.2.1.5 Surface Tension

Shall be within $\pm 10\%$ of the preproduction value at $20\text{ }^{\circ}\text{C} \pm 2$ ($68\text{ }^{\circ}\text{F} \pm 4$), determined in accordance with ASTM D 1331.

3.2.2 Fluid Stability

3.2.2.1 Thermal Stability-Accelerated Aging (to simulate long term heated storage without water loss)

Age sample as in 3.2.2.1.1 and examine as in 3.2.2.1.2.

3.2.2.1.1 Transfer $800\text{ ml} \pm 10$ of fluid to a 1 liter borosilicate bottle (e.g., Pyrex® brand or equivalent) fitted with a tight, heat-resistant plastic seal and tightly close. For the reference sample, also keep $800\text{ ml} \pm 10$ of the fluid in an identical bottle and store at room temperature until the completion of 3.2.2.1.2. Transfer the other closed bottle containing the test fluid to a circulating-air oven or heated oil or water bath. Elevate the temperature to $70\text{ }^{\circ}\text{C} \pm 2$ ($158\text{ }^{\circ}\text{F} \pm 4$) and maintain the test sample in this environment for 30 days.

3.2.2.1.2 After 30 days, remove the test sample from the heated environment and examine the contents for evidence of separation, precipitation or insoluble deposits. Report any evidence of these factors. Allow the test sample to cool to $20\text{ }^{\circ}\text{C} \pm 2$ ($68\text{ }^{\circ}\text{F} \pm 4$). Turn the test sample bottle upside down and then right side up. Repeat this rotation procedure three additional times, and then examine the contents for evidence of separation, precipitation or insoluble deposits versus the unheated reference sample. Report findings. Determine the refractive index of the test and reference samples as in 3.2.1.4. If the test and reference samples have a refractive index difference of greater than 0.0020, the test is invalid.

If the test is valid, measure viscosity at $0\text{ }^{\circ}\text{C} \pm 2$ ($32\text{ }^{\circ}\text{F} \pm 4$) as in 3.2.3.2 using a spindle speed of 0.3 rpm, and pH as in 3.2.1.3. Compare and record the results of the heat-aged test sample and the unheated reference sample. The viscosity shall neither be reduced by more than 20% nor be increased by more than 10%. The pH difference shall not be greater than 1.0 unit. The heat-aged test sample shall be tested according to AS5901 (WSET only) using one set of three plates. Report the results of the test.

3.2.2.2 Exposure to Dry Air (to simulate fluid behavior following overnight exposure to dry air)

The fluid shall be tested in accordance with 3.2.2.2.1. If the fluid, after losing 20% of its original weight, exceeds the viscosity limit defined in 3.2.2.2.1, the fluid shall then be tested in accordance with 3.2.2.2.2 to determine the percent weight loss and aerodynamic performance after exposure to a simulated dry air environment. Results from Successive Dryout and Rehydration (3.2.2.4) test should also be reviewed to ensure that any fluid that fails to meet the viscosity limit defined in 3.2.2.2.1 will not result in high levels of dried residue and/or gel formation.

3.2.2.2.1 The fluid, after exposure to a dry air environment which results in weight reduction of $20\% \pm 1$ shall have a viscosity not exceeding $500\text{ mPa}\cdot\text{s}$ when measured at 3.0 rpm and with spindle LV1 with sample at $20\text{ }^{\circ}\text{C} \pm 2$ ($68\text{ }^{\circ}\text{F} \pm 4$) using the method described in 3.2.3.2.1.

3.2.2.2.1.1 Pour approximately 800 ml of fluid into a pre-weighed glass tray with the following approximate dimensions $200\text{ mm} \times 200\text{ mm} \times 50\text{ mm}$. Weigh the tray and contents to the nearest 2 grams, record the weight. Place this tray with its contents into an environment with air temperature at $23\text{ }^{\circ}\text{C} \pm 3$ ($73\text{ }^{\circ}\text{F} \pm 6$) and the relative humidity not greater than 50% and preferably in the 30% to 45% range. Periodically weigh the tray and contents. When the weight of the fluid is $20\% \pm 1$ lower than its initial weight, pour $500\text{ ml} \pm 10$ of the fluid into a 600 ml beaker. Allow to cool to $20\text{ }^{\circ}\text{C} \pm 2$ ($68\text{ }^{\circ}\text{F} \pm 4$) and test for viscosity.

- 3.2.2.2.2 The fluid shall be tested to determine the percent weight loss obtained under simulated conditions defined in 3.2.2.2.2.1. Fluid at this percent weight loss shall meet aerodynamic performance requirements in accordance with AS5900 by performing three runs of the aerodynamic acceptance test (3.2.5.2) at $-5\text{ }^{\circ}\text{C} \pm 2$ ($23\text{ }^{\circ}\text{F} \pm 4$), and speed ramp(s) used for preproduction tests of the Neat fluid.
- 3.2.2.2.2.1 Place a 1 mm layer of fluid into a pre-weighed Petri dish cover with the approximate dimensions of 10 cm diameter \times 5 mm height. Record the weight to the nearest 0.02 grams. Place the Petri dish into a $55\% \pm 2$ relative humidity environment with air temperature at $0\text{ }^{\circ}\text{C} \pm 2$ ($32\text{ }^{\circ}\text{F} \pm 4$) and $4\text{ m/s} \pm 0.5$ horizontal air velocity for 12 hours ± 0.2 . Equilibrate the dish and its contents to $20\text{ }^{\circ}\text{C} \pm 2$ ($68\text{ }^{\circ}\text{F} \pm 4$) and record the final weight. The percent weight loss shall be reported from an average of at least 3 Petri dish tests.
- 3.2.2.2.2.2 Additional fluid at the percent weight loss obtained under the simulated conditions ($\pm 1\text{ wt}\%$) in 3.2.2.2.2.1 can be prepared at room temperature in pans under a fume hood to make the quantity required for aerodynamic testing.
- 3.2.2.3 Dry-out by Exposure to Cold Dry Air (to simulate fluid dry-out in cold air on the ramp and on the aircraft including aerodynamically quiet areas)

Test as per 3.2.2.3.1 and 3.2.2.3.2.

- 3.2.2.3.1 Using a cold chamber, position three plates, inclined at an angle of 2 degrees from the horizontal. Pour 100 ml to 150 ml of fluid on each plate. Set the air and plate temperatures at $1\text{ }^{\circ}\text{C} \pm 1$ ($34\text{ }^{\circ}\text{F} \pm 2$). Relative humidity less than 40%, and the air moving from the top over the surface towards the bottom of the plates at approximately 2.5 m/s (5.6 mph). Maintain these conditions until the fluid has dried or for 24 hours. Examine the remaining residues. A gel, gum (tacky feel), hard granular solid, or peelable film are not acceptable.
- 3.2.2.3.2 Remove the plates from cold chamber and allow them to warm to $5\text{ }^{\circ}\text{C} \pm 2$ ($41\text{ }^{\circ}\text{F} \pm 4$) and rinse each plate with 500 ml water, conforming to ASTM D 1193 Type IV, at $15\text{ }^{\circ}\text{C} \pm 10$ ($59\text{ }^{\circ}\text{F} \pm 18$) from a 1 liter squeeze bottle. Report the appearance of the plates after rinsing. Only plates free of residue are acceptable. After rinsing, allow the plates to dry at room temperature. Report the appearance of the plates after drying.
- 3.2.2.4 Successive Dry Out and Rehydration (to simulate the formation of dried residues and for such to form gels upon rehydration)

Fluid shall be tested in accordance with Appendix A and results reported. The weight on rehydration for all 10 dips must not be greater than 4 g.

- 3.2.2.5 Thin Film Thermal Stability (to simulate heated leading edge dry out)

Test as per 3.2.2.5.1, 3.2.2.5.2 and 3.2.2.5.3.

- 3.2.2.5.1 At ambient temperature, pour 40 ml to 50 ml of the fluid on to each of two unpainted aluminum or aluminum alloy test panels, approximately $152.5\text{ mm} \times 50\text{ mm}$ (6 inches \times 2 inches). After 5 minutes, place the panels, inclined at an angle of 10 degrees from the horizontal, in an oven maintained at $95\text{ }^{\circ}\text{C} \pm 2$ ($203\text{ }^{\circ}\text{F} \pm 4$). After 60 minutes ± 1 minute, remove the panels, allow them to cool to ambient temperature, and inspect. Report the appearance. A gel, gum (tacky feel), hard granular solid or peelable film are not acceptable.
- 3.2.2.5.2 Rinse each plate with 500 ml water conforming to ASTM D 1193 Type IV at $15\text{ }^{\circ}\text{C} \pm 10$ ($59\text{ }^{\circ}\text{F} \pm 18$) from a 1 liter squeeze bottle positioned not closer than 20 cm from the surface. Report the appearance of the plates after rinsing. Only plates free of residue are acceptable. After rinsing, allow the plates to dry at room temperature. Report the appearance of the plates after drying.
- 3.2.2.5.3 Repeat test as in 3.2.2.5.1 and 3.2.2.5.2 except that the oven temperature shall be at $48\text{ }^{\circ}\text{C} \pm 2$ ($118\text{ }^{\circ}\text{F} \pm 4$). Report results of both tests.

3.2.2.6 Storage Stability (to simulate storage in tanks)

Prior to the start of this test, the viscosity shall be determined at $20\text{ }^{\circ}\text{C} \pm 2$ ($68\text{ }^{\circ}\text{F} \pm 4$), in accordance with 3.2.3.2. The fluid shall be tested in accordance with ASTM F 1105, except that the sample shall be protected from exposure to UV light. Upon completion of the test, the fluid shall be retested for viscosity as before and the result compared to the original values. Both results shall fall within the limits determined in 3.2.3.3.

3.2.2.7 Shear Stability

The anti-icing performance tests as in 3.2.4 shall start within 2 hours after the product has been sheared, but not within the first 20 minutes after shearing using the laboratory method as in 3.2.2.7.1.

3.2.2.7.1 Run a laboratory blender (Waring model number 7012G or equivalent) with the 1 liter glass mixing container removed for a 5 minute warming period at $3000\text{ rpm} \pm 100$. Pour $500\text{ ml} \pm 5$ of fluid at $20\text{ }^{\circ}\text{C} \pm 2$ ($68\text{ }^{\circ}\text{F} \pm 4$) into the 1 liter mixing container. Mix for 5 minutes ± 10 seconds at 2000 rpm . The blender shall be calibrated using a non-contact optical tachometer to provide a mix speed of $2000\text{ rpm} \pm 100$ using 500 mL of water. This non-contact calibration can be performed by placing the blender on a stand and elongating the rotating shaft at the base to measure the rotation speed with the mixing container in place.

3.2.2.8 Hard Water Stability

The fluid, diluted 1:1 by volume with standard hard water made up as in 3.2.2.8.1 and aged as in 3.2.2.8.2, shall show no evidence of insoluble deposits after inversion, and the pH shall not vary by more than ± 1.0 unit from an unheated reference sample. If the refractive index has increased by more than 0.0020 at $20\text{ }^{\circ}\text{C} \pm 2$ ($68\text{ }^{\circ}\text{F} \pm 4$) from the reference sample, the test is invalid as water has been allowed to evaporate during the test. A sample of the diluted test fluid, after hard water stability testing, shall be tested in accordance with AS5901 (WSET only) using one set of three plates, and the results reported.

3.2.2.8.1 Composition of Hard Water

Dissolve $400\text{ mg} \pm 5$ calcium acetate dihydrate ($\text{Ca}[\text{C}_2\text{H}_3\text{O}_2]_2 \cdot 2\text{H}_2\text{O}$) or $363\text{ mg} \pm 5$ calcium acetate monohydrate ($\text{Ca}(\text{C}_2\text{H}_3\text{O}_2)_2 \cdot \text{H}_2\text{O}$) and $280\text{ mg} \pm 5$ magnesium sulfate heptahydrate ($\text{MgSO}_4 \cdot 7\text{H}_2\text{O}$), both of analytical reagent quality, in 1 liter of ASTM D 1193, Type IV, water.

3.2.2.8.2 Place $800\text{ ml} \pm 10$ of the diluted fluid into a 1 liter borosilicate bottle (e.g., Pyrex® brand or equivalent) fitted with a tight, heat-resistant plastic seal and tightly close. For the reference sample, also keep $800\text{ ml} \pm 10$ of diluted fluid in an identical bottle and store at room temperature until the completion of 3.2.2.8.3. Transfer the other closed bottle containing the diluted test fluid to a circulating-air oven or heated oil or water bath. Elevate the temperature to $95\text{ }^{\circ}\text{C} \pm 2$ ($203\text{ }^{\circ}\text{F} \pm 4$) and maintain the diluted test sample in this environment for 30 days.

3.2.2.8.3 After 30 days, remove the diluted test sample from the heated environment and allow it to cool to $20\text{ }^{\circ}\text{C} \pm 2$ ($68\text{ }^{\circ}\text{F} \pm 4$). Examine the contents for evidence of separation, precipitation or insoluble deposits versus the unheated reference sample. Report findings. Turn the test sample bottle upside down and then right side up. Repeat this rotation procedure three additional times. Inspect as in 3.2.2.8.

3.2.2.9 Tendency to Foam

At the option of the user, the vendor shall demonstrate that fluid as supplied or in intended use dilutions and heated to intended use temperatures, applied through commercial deicing/anti-icing vehicle systems to an inclined flat or curved surface, preferably an aircraft wing or horizontal stabilizer, at pressures and flow rates normal for the intended use, does not cause foam which does not rapidly collapse, and fluid surface shall not have the appearance of snow or slush.

3.2.2.10 Cold Storage Stability (to simulate the stability of the fluid cycling between cold temperature and room temperature)

Prior to the start of this test, the sample shall be visually examined to determine freedom from insoluble deposits. Report any evidence of these factors. Determine the pH in accordance with 3.2.1.3. Determine the refractive index in accordance with 3.2.1.4. Determine the viscosity in accordance with 3.2.3.2, ASTM D 2196, Method B, except the sample shall not be shaken, using a Brookfield LV viscometer or equivalent, fitted with the guardleg and appropriate spindle for the speed selected. Values shall be taken at a spindle speed of 0.3 rpm at $20\text{ }^{\circ}\text{C} \pm 2$ ($68\text{ }^{\circ}\text{F} \pm 4$). The report shall clearly state the size and type of spindle used.

3.2.2.10.1 Transfer 2.0 liters of fluid into an appropriate 2.5 liter container (ex: high-density polyethylene-HDPE, glass separatory funnel, etc.) with a well-closed cap. Transfer the closed container containing the sample of fluid to a freezer. Maintain the sample at $-20\text{ }^{\circ}\text{C} \pm 2$ ($-4\text{ }^{\circ}\text{F} \pm 4$) for 24 hours. After 24 hours, remove the closed container containing the fluid sample from the freezer. Allow the sample to stand at $20\text{ }^{\circ}\text{C} \pm 2$ ($68\text{ }^{\circ}\text{F} \pm 4$) for 24 hours. Repeat the cycling between $-20\text{ }^{\circ}\text{C}$ and $20\text{ }^{\circ}\text{C}$ for 5 complete cycles. An example of the cycling period is shown in Table 2.

TABLE 2 - FLUID CYCLING PERIOD

Day 1	Day 2	Day 3	Day 4	Day 5	Day 6	Day 7	Day 8	Day 9	Day 10
$-20\text{ }^{\circ}\text{C}$	$20\text{ }^{\circ}\text{C}$	$-20\text{ }^{\circ}\text{C}$	$20\text{ }^{\circ}\text{C}$	$-20\text{ }^{\circ}\text{C}$	$20\text{ }^{\circ}\text{C}$	$-20\text{ }^{\circ}\text{C}$	$20\text{ }^{\circ}\text{C}$	$-20\text{ }^{\circ}\text{C}$	$20\text{ }^{\circ}\text{C}$

3.2.2.10.2 Upon completion of the cycling, the fluid shall be visually examined for evidence of separation, precipitation, or insoluble deposits. Report any visual observations. Allow fluid to equilibrate to room temperature. Siphon/extract 1 liter from the top portion of the fluid sample, ensuring that the tip of the siphon hose remains 2 inches beneath the surface of the fluid, and transfer the top portion into a separate container (labeled top). Siphon/extract 1 liter from the bottom portion, ensuring that the tip of the siphon hose remains at the bottom of the container, and transfer the bottom portion into a separate container (labeled bottom). The top and bottom portions of the fluid sample shall be retested as before for pH, refractive index, and viscosity in accordance with 3.2.2.10 and the results compared to the original values.

3.2.3 Rheological Properties

The special rheological properties defined in 3.2.3.1 and 3.2.3.2 relate to thickened fluids which are classed as non-Newtonian, pseudoplastic as defined in 1.1.2 and 1.1.3 and are specified to ensure the flow of the film when sufficient shear stress is induced. The exposure of a film of the applied fluid to different environmental factors shall not impair this performance (either by buildup of film thickness due to consecutive applications or by forming a gel), when tested in accordance with 3.2.2.2 and 3.2.2.3. Fluids of all types shall be tested as in 3.2.3.2.

3.2.3.1 Viscosity

The fluid shall exhibit non-Newtonian flow behavior over the temperature range at which the fluid has been tested and certified as acceptable in accordance with the Aerodynamic Acceptance test (3.2.5). The viscosity of any neat fluid as supplied shall be measured as per 3.2.3.2 and fall within the limits defined in 3.2.3.3.

3.2.3.2 Viscosity Measurement

The sample will not be shaken prior to testing. Test at $20\text{ }^{\circ}\text{C} \pm 2$ ($68\text{ }^{\circ}\text{F} \pm 4$), $0\text{ }^{\circ}\text{C} \pm 2$ ($32\text{ }^{\circ}\text{F} \pm 4$) and in $10\text{ }^{\circ}\text{C}$ ($18\text{ }^{\circ}\text{F}$) increments down to the lowest usable temperature identified by the manufacturer. The viscosity shall be measured using a Brookfield LV viscometer at 0.3 rpm, 6 rpm and 30 rpm. The viscosity may be measured using the Brookfield small sample adapter or as specified in 3.2.3.2.1. The report shall state if the small sample adapter was used and shall detail the spindle size, container size, volume of fluid employed, and the rotation duration. In case of dispute the method described in 3.2.3.2.1 shall prevail.

3.2.3.2.1 Using a Brookfield LV viscometer fitted with the guard leg and using a sample of approximately 500 ml or sufficient quantity to accommodate the selected spindle and guard leg, contained in an 85 mm diameter, straight sided 600 ml beaker. The test shall be run using the appropriate spindle in accordance with ASTM D 2196, Method B, except the samples shall not be shaken. The reporting requirements are the same as in 3.2.3.2.

3.2.3.3 Viscosity Limits

The viscosity of any neat fluid as supplied shall fall within the limits of the high and low viscosity values defined by the pre-production samples (4.2.3) and the viscosity limits shall be reported. For quality control purposes the manufacturer shall specify the typical viscosity range a user can expect to obtain from fluid being delivered for use. The viscosity of the High Viscosity Preproduction Sample (4.2.3.1) shall be measured in accordance with AIR9968 and reported.

3.2.4 Anti-Icing Performance

3.2.4.1 Water Spray Endurance Test (WSET), and High Humidity Endurance Test (HHET)

When tested in accordance with AS5901, the neat fluid, sheared as in 3.2.2.7, shall form a film which will protect against the formation of frozen deposits within the failure zone depicted in Figure 1 of AS5901 for the times listed in Table 3. Similarly, if the fluid is intended to be diluted with water, it shall be diluted by volume to ratios of 75:25 and 50:50 with water conforming to 3.2.2.8.1 and sheared as in 3.2.2.7, and shall protect as in Table 3. Confirmation shall be obtained from 6 panels, 3 panels from each of two successive test runs.

TABLE 3 - MINIMUM ANTI-ICING PERFORMANCE

Fluid - SAE Type & Dilution	WSET Time - Minutes	HHET Time - Hours
II 100:00	30	4
75:25	20	2
50:50	5	0.5
III 100:00	20	2
75:25	Determine and report	Determine and report
50:50	Determine and report	Determine and report
IV 100:00	80	8
75:25	20	2
50:50	5	0.5

3.2.5 Aerodynamic Acceptance

3.2.5.1 Criterion to Shear or Not to Shear the Fluid

If after shearing in accordance with 3.2.2.7.1, the apparent viscosity increases by more than 15% when tested in accordance with 3.2.3.2 at $0\text{ }^{\circ}\text{C} \pm 2$ ($32\text{ }^{\circ}\text{F} \pm 4$) at spindle speeds of 6 rpm and 30 rpm, the fluid shall be sheared prior to testing. If the apparent viscosity increased by less than or equal to 15%, or decreased, the fluid shall be tested in the unsheared state.

3.2.5.2 Aerodynamic Test

The fluid shall demonstrate acceptable aerodynamic performance when tested in accordance with AS5900 High Speed Ramp Test and/or Low Speed Ramp Test. The High Speed Ramp Test is the approved aerodynamic test for fluids used on large transport type aircraft. The Low Speed Ramp Test is the approved aerodynamic test for fluids used on lower takeoff rotation speed commuter aircraft. Also see 1.2.1. A fluid and its volume/volume dilutions (defined in Table 3) shall be tested at temperatures ranging from $0\text{ }^{\circ}\text{C} \pm 2$ ($32\text{ }^{\circ}\text{F} \pm 4$) down to the lowest temperature requested by the fluid manufacturer, in approximately $10\text{ }^{\circ}\text{C}$ ($18\text{ }^{\circ}\text{F}$) intervals. For each fluid or dilution, a minimum of 3 tests shall be performed at each temperature.

3.2.5.3 Test with the Highest Viscosity Dilution

For the preproduction fluid, the dilution ratios which produce high viscosity at different temperature intervals shall be identified. Each dilution which exhibits a viscosity greater than that of the Neat, 75:25 or 50:50 dilution, by more than 15% at each temperature interval, shall demonstrate acceptable aerodynamic performance when tested in accordance with AS5900 as described in 3.2.5.3.1.

3.2.5.3.1 Prepare dilutions of the fluid in 5% volume increments using water conforming to ASTM D 1193 Type IV. The viscosity shall be measured using a Brookfield LV viscometer at 6 rpm and 30 rpm using the small sample adapter and appropriate spindle at $0\text{ }^{\circ}\text{C} \pm 2$ ($32\text{ }^{\circ}\text{F} \pm 4$), $-10\text{ }^{\circ}\text{C} \pm 2$ ($14\text{ }^{\circ}\text{F} \pm 4$) and $-20\text{ }^{\circ}\text{C} \pm 2$ ($-4\text{ }^{\circ}\text{F} \pm 4$). Measurements shall be made on dilutions with increasing water content until three consecutive decreasing viscosity measurements are obtained. Each dilution which exhibits a viscosity greater than that of the Neat, 75:25 or 50:50 dilution, by more than 15% at each temperature interval, shall be identified. Each of these identified dilutions shall be tested in accordance with AS5900 by performing three runs at the respective temperature interval, and speed ramp(s) used for preproduction tests of the Neat fluid.

3.2.5.4 Fluid Elimination

Fluid elimination shall be tested and calculated in accordance with AS5900 and shall be based on an initial thickness of 2 mm of fluid on the test duct floor. The elimination shall be not less than 74% at all tested temperatures for the High Speed Ramp Test. It shall not be less than 57% at all tested temperatures for the Low Speed Ramp Test.

3.3 Fluid Tested Both Neat and as a Diluted Solution

Tests shall be conducted using the neat fluid and using a solution comprised of the neat fluid diluted 1:1 by weight with ASTM D 1193, Type IV, water.

3.3.1 Freezing Point

For the neat fluid, the freezing point shall be not higher than $-32\text{ }^{\circ}\text{C}$ ($-26\text{ }^{\circ}\text{F}$). When diluted at a ratio of 1:1 by weight with ASTM D 1193, Type IV, water, the freezing point shall be not higher than $-10\text{ }^{\circ}\text{C}$ ($+14\text{ }^{\circ}\text{F}$), determined in accordance with ASTM D 1177. Report freezing points for both the neat and 1:1 diluted fluid.

3.3.2 Effect on Aircraft Materials

WARNING

This document includes cadmium as a plating material. The use of cadmium has been restricted and/or banned for use in many countries due to environmental and health concerns. The user should consult with local officials on applicable health and environmental regulations regarding its use.

3.3.2.1 Sandwich Corrosion

After testing in accordance with ASTM F 1110, the test specimens shall not show corrosion worse than controls, when control panels are tested using water conforming to ASTM D 1193.

3.3.2.2 Total Immersion Corrosion

The fluid, tested in accordance with ASTM F 483, shall neither produce evidence of corrosion of test panels nor cause a weight change of any test panel greater than shown in Table 4.

TABLE 4 - TOTAL IMMERSION CORROSION

Test Panel		Weight Change mg/cm ² per 24 Hours
AMS4037	Aluminum Alloy, anodized as in AMS2470	0.3
AMS4041	Aluminum Alloy	0.3
AMS4049	Aluminum Alloy	0.3
AMS4376	Magnesium Alloy, dichromate treated as in AMS2475	0.2
AMS4911 or MAM4911	Titanium Alloy	0.1
AMS5045	Carbon Steel	0.8

3.3.2.3 Low-Embrittling Cadmium Plate

Test panels, coated with low embrittling cadmium plate, shall not show a weight change greater than 0.3 mg/cm² per 24 hours, determined in accordance with ASTM F 1111. See 3.3.2.

3.3.2.4 Stress-Corrosion Resistance

The fluid shall not cause cracks in AMS4911 titanium specimens when tested in accordance with ASTM F 945, Method A.

3.3.2.4.1 Stress Corrosion Resistance

The fluid shall be tested in accordance with ASTM F 945, Method A, using AMS4916 specimens. The test report shall detail the effects of the fluid and of the control solution.

3.3.2.5 Hydrogen Embrittlement

The fluid shall be non-embrittling, determined in accordance with ASTM F 519, utilizing Type 1a, 1c or 2a specimens, cadmium plated in accordance with MIL-STD-870, Class 1, Type I. In case of dispute, the Type 1c bar shall be used. Type 1a and 1c specimens shall be loaded to 45% of the predetermined notch fracture strength, and Type 2a specimens loaded to 80% of the yield strength. The entire 2a stressed specimen, or just the notched area of the 1a and 1c stressed specimen, shall be immersed continuously in the fluid under test for 150 hours at a temperature of 25 °C ± 5 (77 °F ± 9). The test specimens shall be galvanically isolated. Galvanic reactions can be prevented by confining the test sample to the test specimen using a chemically inert cup. See 3.3.2.

3.3.2.6 Effect on Transparent Plastics

When heated to 65 °C ± 2 (149 °F ± 4), the fluid shall not craze, stain, or discolor MIL-PRF-25690 stretched acrylic plastic, determined in accordance with ASTM F 484.

3.3.2.6.1 Similarly fluid shall not craze, stain, nor discolor AMS-P-83310 polycarbonate plastic, determined in accordance with procedures in ASTM F 484 except that the specimens shall be stressed for 30 minutes ± 1 to an outer fiber stress level of 13.8 MPa (2000 psi).

3.3.3 Effect on Painted Surfaces

When heated to 65 °C ± 2 (149 °F ± 4) and applied to a painted surface having an initial surface temperature of 22 °C ± 2 (72 °F ± 4), the fluid shall not produce any streaking, discoloration, or blistering of the paint film, and shall not decrease paint film hardness by more than two pencil hardness numbers, determined in accordance with ASTM F 502.

3.3.4 Effect on Unpainted Surfaces

The fluid tested in accordance with ASTM F 485, shall neither produce streaking nor leave any stains, which require polishing to remove.

3.3.5 Pavement Compatibility

3.3.5.1 Runway Concrete Scaling Resistance

The condition of the runway concrete surface shall have a rating not greater than 1 for 50 freeze-thaw cycles, determined in accordance with ASTM C 672, except that the concrete shall be air-entrained with an air content as in ASTM C 672, have a minimum cement content of $302 \text{ kg/m}^3 \pm 4.5$ ($510 \text{ lb/yd}^3 \pm 10$) and a slump, $38 \text{ mm} \pm 13$ ($1.5 \text{ inches} \pm 0.5$). A 25% ± 1 by volume solution of the neat fluid prepared using tap water shall be substituted for the specified calcium chloride. Performing more than one freeze- thaw cycle per day is acceptable.

4. QUALITY ASSURANCE PROVISIONS

4.1 Responsibility for Inspection

The vendor of the fluid shall supply all samples for conformance testing and shall be responsible for obtaining independent laboratory confirmation of conformance to the requirements of this specification. Each fluid sample container shall be clearly identified with the vendor's name, fluid name or code number and lot number, and manufacturing site address. The purchaser or user reserves the right to sample and to perform any confirmatory testing deemed necessary to ensure that the fluid conforms to the requirements of this specification.

4.2 Classification of Tests

4.2.1 Lot Acceptance Tests

pH (3.2.1.3), refractive index (3.2.1.4), and viscosity at $20 \text{ }^\circ\text{C} \pm 2$ ($68 \text{ }^\circ\text{F} \pm 4$) or $0 \text{ }^\circ\text{C} \pm 2$ ($32 \text{ }^\circ\text{F} \pm 4$) at 0.3 rpm, 6 rpm, and 30 rpm are acceptance tests and shall be performed on each lot. Any Certificate of Analysis for a production lot shall contain these data.

4.2.2 Periodic Tests

Anti-icing performance (3.2.4), and Aerodynamic Acceptance (3.2.5) are periodic tests, and shall be performed on, or just prior to the second anniversary of initial testing, thereafter every two calendar years. Aerodynamic performance (3.2.5) shall be performed by an approved and autonomous test facility. Anti-icing performance (3.2.4) shall be performed by an autonomous facility, unless another facility is agreed upon between the purchaser or user and the vendor.

4.2.3 Preproduction Tests

Two preproduction samples shall be submitted and tested in accordance with 4.2.3.1 and 4.2.3.2. Tests shall be performed prior to or upon the initial shipment of the fluid to a purchaser (except for Storage Stability (3.2.2.6) which may be waived by the purchaser to permit entry of a new product), when a change in any ingredient or production method requires reapproval as in 4.4.2, and when purchaser deems confirmatory testing to be required.

4.2.3.1 High Viscosity Preproduction Sample

Tests for all technical requirements shall be performed on the High Viscosity sample. The High Viscosity sample shall define the maximum viscosity that complies with the aerodynamic acceptance test (3.2.5). This viscosity value will be reported as the maximum on-wing viscosity of the fluid.

4.2.3.2 Low Viscosity Preproduction Sample

The Low Viscosity sample shall have a viscosity value less than the High Viscosity sample and greater than or equal to the viscosity of the sample submitted for Endurance Time testing (ARP5485). The following tests shall be conducted on the Low Viscosity sample:

- a. Viscosity shall be measured at $20\text{ }^{\circ}\text{C} \pm 2$ ($68\text{ }^{\circ}\text{F} \pm 4$) and $0\text{ }^{\circ}\text{C} \pm 2$ ($32\text{ }^{\circ}\text{F} \pm 4$), at 0.3 rpm, 6 rpm, and 30 rpm in accordance with 3.2.3.2.
- b. WSET in accordance with 3.2.4.1.
- c. Aerodynamic Performance in accordance with AS5900. The test shall consist of one data point, three runs, using the neat fluid. The test shall repeat the lowest temperature $\pm 1\text{ }^{\circ}\text{C}$ ($2\text{ }^{\circ}\text{F}$), at which the High Viscosity sample met the Aerodynamic Performance requirements.

4.2.3.3 U.S. Military Procurement

For direct U.S. Military procurement, substantiating test data and, when requested, preproduction fluid shall be submitted to the cognizant agency as directed by the procuring activity, contracting officer, or request for procurement.

4.3 Sampling and Testing

Shall be in accordance with 4.3.1 or 4.3.2, as applicable. A lot shall be all fluid produced in one continuous manufacturing process using materials from the same batches of raw materials and presented for vendor's inspection at one time. Sufficient fluid from a single production lot shall be taken to perform all required tests.

4.3.1 Bulk Shipments

In accordance with ASTM D 4177.

4.3.2 Drum Shipments

In accordance with ASTM D 1568.

- 4.3.3 When a statistical sampling plan has been agreed upon by the purchaser and the vendor, sampling shall be in accordance with such plan in lieu of sampling as in 4.3.1 or 4.3.2, and the report of 4.5 shall state that such a plan was used.

4.4 Approval

- 4.4.1 A sample fluid shall be approved by the purchaser before fluid for production use is supplied, unless such approval is waived by purchaser. Results of tests on production fluid shall be essentially equivalent to those on the approved sample.
- 4.4.2 The vendor shall use ingredients, manufacturing processes, and methods of inspection for production fluid which are essentially the same as those used to produce the fluid which is presented for qualification to this specification. If it is necessary to make any change in ingredient or the manufacturing process, the vendor shall submit such fluid for re-approval. Production fluid made by the revised procedure shall not be shipped to the purchaser until full testing and approval has been received.
- 4.4.3 Whenever a fluid is to be produced at multiple locations, or by a licensee or subcontractor, all testing shall be required on fluid produced at each site, prior to initial shipment, as if the fluid were being initially qualified, unless the production method, materials, and handling are the same as the originally qualified vendor's production materials and methods. In any case, the fluid so produced shall initially be confirmed by the aerodynamic acceptance test (3.2.5), and by a single test run of three panels under WSET (3.2.4.1).

4.5 Reports

4.5.1 Preproduction and Periodic Test Reports

Before the initial shipment, the vendor of fluid shall furnish a report showing the results of tests to determine conformance to all the technical requirements of this specification. These tests shall be performed by an approved and/or independent testing facility/facilities (See 4.2.2). The aerodynamic acceptance test facility shall determine and report the following properties from the sample of fluid submitted for testing:

- a. Viscosity (3.2.3.2)
- b. Refractive Index (3.2.1.4)
- c. pH (3.2.1.3)
- d. Surface Tension (3.2.1.5)

4.5.1.1 The reports shall include the quantity, lot number, AMS1428 (latest revision) and manufacturer's product identification, date of manufacture, and manufacturing location.

4.5.1.2 Subsequent reports of the results of periodic recertifications shall compare the results obtained to the original fluid certification documents.

4.5.2 Material Safety Data Sheet (MSDS)

A material safety data sheet (MSDS) conforming to AMS2825, or equivalent for the countries in which the product will be sold, shall be supplied to each purchaser prior to or concurrent with the report of preproduction test results or, if the preproduction test be waived by purchaser, concurrent with the first shipment of fluid for production use. Modification of the fluid formulation or change in the reportable status of any of the raw materials used shall be accompanied by a revised MSDS.

4.6 Re-sampling and Retesting

If any sample used in the above tests fails to meet the specified requirements, disposition of the fluid may be based on the results of testing three additional samples for each original non-conforming sample. Failure of any retest sample to meet the specified requirements shall be cause for rejection of the fluid represented. Results of all tests shall be reported.

5. PREPARATION FOR DELIVERY

5.1 Packaging and Identification

5.1.1 The fluid shall be packaged in containers of a size and type acceptable to purchaser or shall be delivered in bulk.

5.1.1.1 A production lot of fluid may be packaged in several or various containers and be delivered under the basic approval provided that lot identification is maintained.

5.1.2 Except for bulk delivery, each container shall be legibly marked with not less than the manufacturer's identification, lot number, quantity, AMS1428 (latest revision), and, if requested, purchase order number and date of manufacture.

5.1.3 Containers of fluid shall be prepared for shipment in accordance with commercial practice and in compliance with applicable rules and regulations pertaining to the handling, packaging, labeling, and safe transportation of the fluid to ensure carrier acceptance and safe delivery.

5.1.4 For direct U.S. Military procurement, fluid shall be packaged, such that it is adequately protected from deterioration or physical damage during shipment from the source of supply to the procurement activity, or its designated receiving point, and (except for bulk delivery) for a minimum storage period of 30 days from the date of delivery (or a period defined by the purchaser) unless otherwise designated in the contract or purchase order (See also 9.2).

6. ACKNOWLEDGMENT

A vendor shall mention this specification number in all quotations and when acknowledging purchase orders.

7. REJECTIONS

Fluid not conforming to this specification, or to modifications approved by purchaser, shall be subject to rejection.

8. SIMILAR SPECIFICATIONS

ISO 11078 - Aerospace-Aircraft Deicing/Anti-icing non-Newtonian fluids, ISO Type II.

9. NOTES

NOTICE

This document references a part which contains cadmium as a plating material. Consult local officials if you have questions concerning cadmium's use.

9.1 A change bar (I) located in the left margin is for the convenience of the user in locating areas where technical revisions, not editorial changes, have been made to the previous issue of this document. An (R) symbol to the left of the document title indicates a complete revision of the document, including technical revisions. Change bars and (R) are not used in original publications, nor in documents that contain editorial changes only.

9.2 Terms used in AMS are clarified in ARP1917.

9.3 Dimensions and properties in SI units and the Celsius temperatures are primary; dimensions and properties in inch/pound units and the Fahrenheit temperatures are shown as the approximate equivalents of the primary units and are presented only for information.

9.4 Purchase documents should specify not less than the following:

AMS1428G

Type of fluid required or limitations (if applicable)

Size and type of containers desired

Quantity of fluid desired

Packaging requirements (See 5.1.3).

PREPARED BY SAE COMMITTEE G-12

APPENDIX A - SUCCESSIVE DRY OUT AND REHYDRATION TEST
FOR DEICING/ANTI-ICING FLUID

A.1 SCOPE

A.1.1 This document establishes the equipment list and test procedure to carry out multiple dryout and rehydration on SAE Type II, Type III and Type IV fluids according to the current material specification.

A.1.2 Units

The values stated in SI units are to be regarded as the standard.

A.1.3 Safety

While the materials, methods, applications, and processes described or referenced in this document may involve the use of hazardous materials, this document does not address the hazards that may be involved in such use. It is the sole responsibility of the user to ensure familiarity with the safe and proper use of any hazardous materials and processes and to take necessary precautionary measures to ensure the health and safety of all personnel involved.

A.2 APPLICABLE DOCUMENTS

A.2.1 SAE Publications

Available from SAE International, 400 Commonwealth Drive, Warrendale, PA 15096-0001, Tel: 877-606-7323 (inside USA and Canada) or 724-776-4970 (outside USA), www.sae.org.

AMS4037 Aluminum Alloy, Sheet and Plate, 4.4Cu - 1.5Mg - 0.6Mn, (2024; -T3 Flat Sheet, -T351 Plate) Solution Heat Treated

A.2.2 ASTM Publications

Available from ASTM International, 100 Barr Harbor Drive, P.O. Box C700, West Conshohocken, PA 19428-2959, Tel: 610-832-9585, www.astm.org.

ASTM D 1193 Reagent Water

ASTM D 1747 Refractive Index of Viscous Materials

ASTM D 2196 Rheological Properties of Non-Newtonian Materials by Rotational (Brookfield Type) Viscometer

A.3 EQUIPMENT REQUIRED FOR TEST

A.3.1 Three test plates per fluid to be tested. Each plate shall be marked for identification. Plates are fabricated from 2024-T3, aluminum sheet. Each plate shall be 100 mm \pm 3 long \times 50 mm \pm 2 wide \times 1 mm (0.040 inch) thick, with a hole 3 mm \pm 0.5 in diameter. The hole to be 12 mm \pm 2 from the upper (short) edge of the plate.

A.3.2 5 liters of Type II, III or IV fluid.

A.3.3 500 ml tall form beaker for immersion of the test plate in deicing/anti-icing fluid.

A.3.4 Oven with ventilation, for accelerated dry out.

A.3.5 Weighing scales (0.0001 g and 0.01 g precision).

A.3.6 Water conforming to ASTM D 1193 Type IV.

A.3.7 Device on which to hang the plate, for dry out and weighing (See Figure A1 Test Device).

A.3.8 Forceps for handling the plate and carrier.

A.3.9 Dipping device, capable of producing a linear movement with a stroke of 170 mm +/- 10 mm within 2 sec in a sinusoidal speed profile (See Figure A2) or equivalent (See Figure A3).

A.4 VISCOSITY AND REFRACTIVE INDEX CHECKS

At 20 °C ± 2 (68 °F ± 4), measure the viscosity at 0.3 rpm (in accordance with 3.2.3.2), and the refractive index (in accordance with ASTM D 1747) of the test fluid, and record the results.

The viscosity of the neat sample shall be equal to the High Viscosity Preproduction sample as defined in 4.2.3.1.

A.5 TEST PROCEDURE

A.5.1 For this test, the High Viscosity Preproduction sample, as defined in 4.2.3.1, shall be used.

A.5.2 A total of three test plate runs for each fluid, and each fluid dilution shall be carried out.

A.5.3 The surface of each plate shall be slightly etched to represent the aged surface of in service aircraft. This shall be simulated by immersing the plate, initially for 5 minutes in caustic soda solution (250 g NaOH per liter), followed by a rinse in tap water. The plate shall then be immersed for 30 seconds in nitric acid (concentrated HNO₃ diluted 1:1 by volume with water), followed by a rinse in tap water, with a final rinse in water conforming to ASTM D 1193 Type IV and air dry.

NOTE: For each test, new plates etched in accordance with A.5.3 shall be used in order to standardize the surface condition of the plates. Repeated etching of the same plate changes the condition of the surface.

A.5.4 Measure and record the weight (with 0.0001 g precision) of each test plate and its wire hanger using a weighing support.

NOTE: For all weighings, it is necessary to determine the weight of the test plate and its wire hanger without the weighing support. To accomplish this, place the weighing support on the scale and "zero" the scale before hanging the plate onto the support,

A.5.5 Immerse the test plate completely in 100:00 dilution of the fluid being tested. All immersions for the test plate shall be done in the same beaker of the fluid dilution being tested.

NOTE: This may be done either by hand or with the dipping device in accordance with paragraph A.3.9.

A.5.6 Within 4 seconds maximum, remove the plate from the fluid using a slow and steady movement, and hang it on a weighing support (See Figure A1 Test Device).

A.5.7 After 5 minutes draining time, weigh (with 0.01 g precision) the plate and hanger using the weighing support, and record the result.

A.5.8 After 30 minutes draining time re-weigh (with 0.01 g precision) the plate and hanger using the weighing support and record the result.

NOTE: Weighing of the plates when wet (A5.7 and A5.8) shall only be done after the first dipping in the fluid.

A.5.9 Place the plate and hanger onto a support which allows the plate to hang vertically, then place the support into a ventilated oven. For the oven support, a similar support as for weighing can be used. Set the oven temperature at 30 °C to 35 (86 °F to 95). Ensure that the placement of the plates and any movement from the ventilation in the oven does not permit the plates to touch each other

A.5.10 Let the fluid dry out completely (typically for 24 hours). Take the plate out of the oven. Wait for 30 minutes to stabilize the humidity of the dry residue and then place the plate and hanger on the weighing support and weigh using 0.0001 g precision. Record the result.

NOTE: The test is not valid if the fluid has not completely dried out before proceeding to paragraph A.5.11 and A.5.12. Only a dry residue is acceptable: ensure the fluid at the bottom of the plate is fully dried out. If it is necessary to extend the drying time, then the total drying time shall be recorded. The residue may be considered as dry when there is no visible moisture and the weight no longer decreases. The curve, plotted in accordance with paragraph A.6.2, shall be relatively steady and shall have no distinct peaks.

A.5.11 Repeat steps A.5.5, A.5.6, A.5.9 and A.5.10 an additional 5 times, recording the results each time, accumulating 6 sets of dried residue data for each test plate (18 sets of data in total).

A.5.12 Using the dipping device in accordance with paragraph A.3.9 (See Figure A2 or A3), immerse the test plate and hanger (with the dry residue from A.5.11) for 30 seconds \pm 2 in water conforming to ASTM D 1193, Type IV, remove, and allow to drain for 60 seconds \pm 2. Place the plate and hanger on the weighing support. Record the weight using 0.01 g precision and describe the wetted residue.

A.5.12.1 Repeat step A.5.12 for an additional 9 immersions and weighing cycles, accumulating 10 sets of data for each test plate (30 sets of data in total). Use the same water for all 10 dippings of each plate. Do not use this water for any other plate.

A.5.13 Repeat all steps from A.4 through A.5.12 (including A.5.12.1) using a 75:25 volume dilution of the fluid made with water conforming to ASTM D 1193, Type IV.

A.5.14 Repeat all steps from A.4 through A.5.12 (including A.5.12.1) using a 50:50 volume dilution of the fluid made with water conforming to ASTM D 1193, Type IV.

A.6 REPORTING THE TEST RESULTS

A.6.1 The weight of the fluid (in grams, using 0.01g precision) remaining after 5 minutes and 30 minutes of draining time from the initial fluid dip, (obtained from the procedure in A.5.7 and A5.8), shall be reported as both a table and as a graph.

A.6.2 The weights of the accumulated dried residues, per drying cycle, (in grams, using 0.0001g precision, obtained from the procedures in A.5.10 and A.5.11) shall be reported and presented both as a table and as a graph.

A.6.3 The weights of the accumulated gel residues, per water immersion step (in grams, using 0.01g precision, obtained from the procedures in A.5.12 and A.5.12.1) shall be reported and presented both as a table and as a graph.

NOTE 1: The reports from A.6.1 and A.6.3 shall be in a combined graph with the following scale:

- a. on the vertical axis the weight is shown in grams (up to 10) where 1 gram is 10 mm.
- b. on the horizontal axis the wet fluid weight after 5 and 30 min. draining (first dipping only, 2 points), the dry residue weight after 6 dry-out cycles (total, only 1 point) and the re-hydrated gel residue weight after each water immersion number (10 points) are shown where 1 number is 10 mm. An example of the curve is shown below:

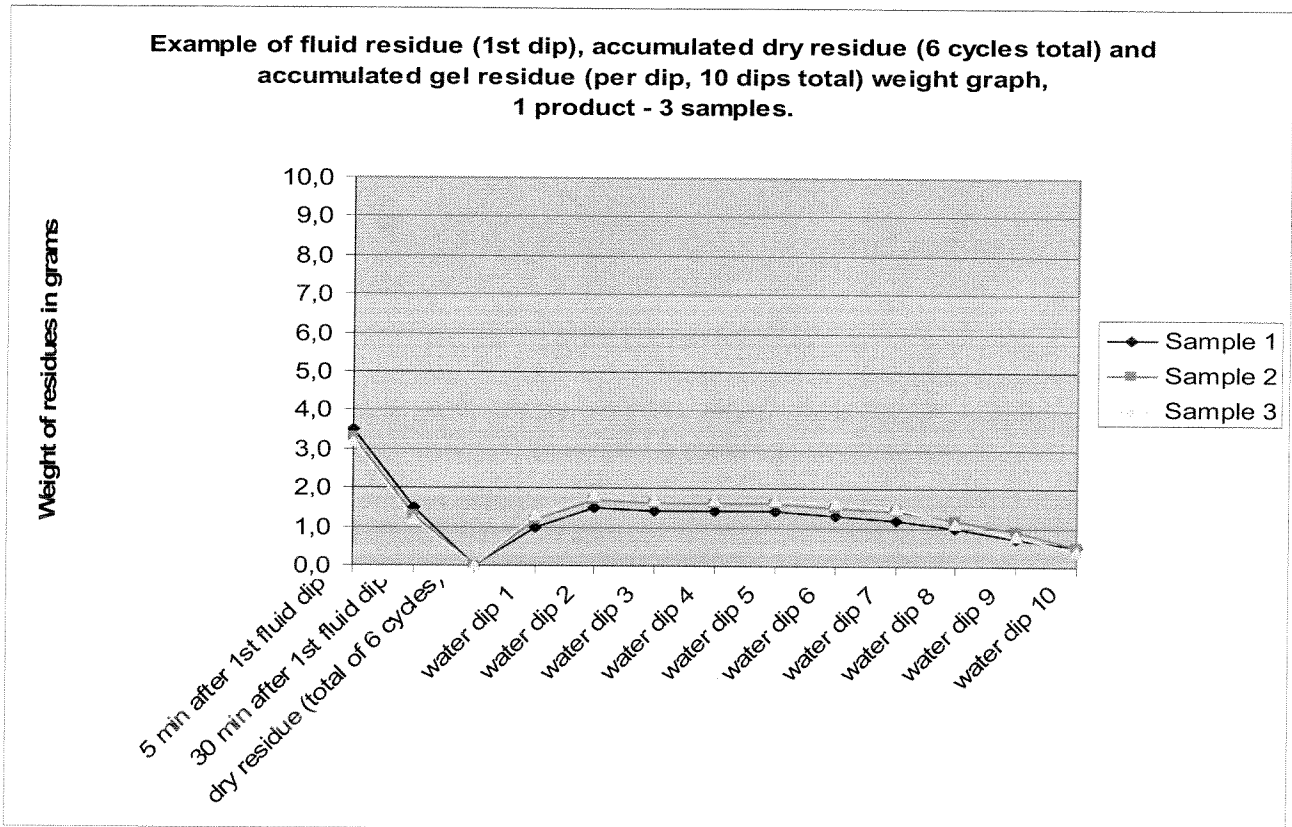

NOTE 2: The report from A.6.2 shall be in a different graph with the following scale:

- on the vertical axis the weight is shown in grams (up to 0,035) where 0,005 milligram is 10 mm.
- on the horizontal axis the drying numbers (6 times) are shown where 1 number is 30 mm. An example of the curve is shown below:

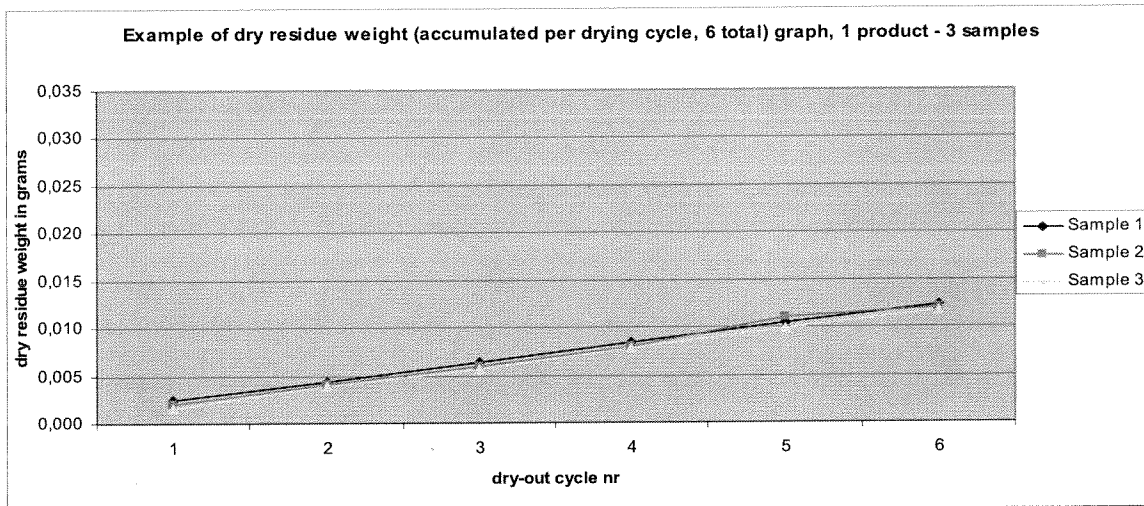

A.6.4 In order to more easily compare the results of fluids tested to this Appendix, the following samples must be submitted to the Anti-icing Materials International Laboratory (AMIL) in Chicoutimi, Quebec, Canada:

- A High Viscosity Preproduction sample as defined in section 4.2.3.1 of AMS 1428.
- A Lowest On Wing Viscosity sample as defined in ARP 5718, section 1.1 for Endurance Time testing per ARP 5485.

AMIL shall test these Neat (undiluted) fluids according to this Appendix and publish graphs on their website which contain the results.

AMIL will publish one graph containing the results of all neat fluids tested, as well as three graphs containing these results categorized by fluid type (type II, III, and IV, one graph for each).

The results for the High Viscosity Preproduction samples and the Lowest On Wing Viscosity samples will be presented on separate graphs (for a total of 2 sets of 4 graphs). The fluids will not be identified by their specific name or manufacturer's name.

A.6.5 Fluids that are removed from the qualified list of fluids according to ARP 5718, section 5.12, shall also be removed from the graphs published by AMIL.

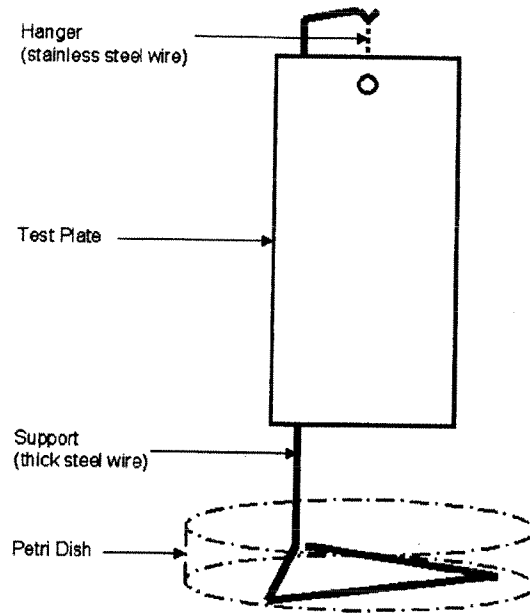

FIGURE A1 - TEST DEVICE

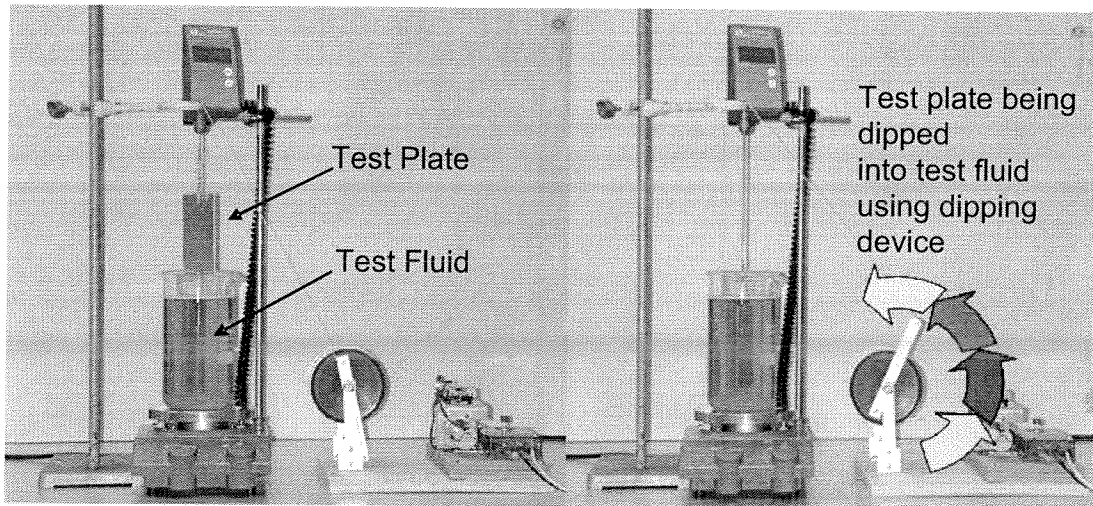

FIGURE A2 - DIPPING DEVICE EXAMPLE 1

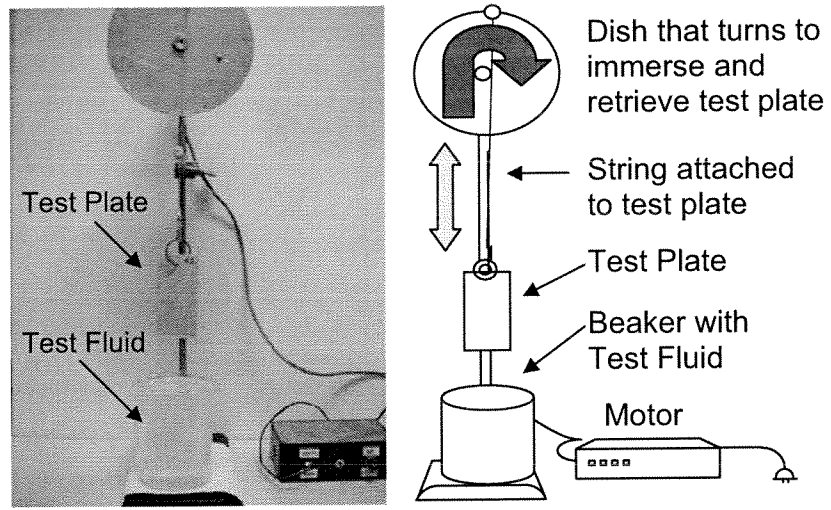

FIGURE A3 - DIPPING DEVICE EXAMPLE 2

This page intentionally left blank.

APPENDIX B

USAF Military Test Method Standard (MTMS) Testing (Prepared by AFRL and CTC)

NOTE: The distribution of this report is authorized to the U.S. Government agencies only. The report is available from Dr. Elizabeth S. Berman of AFRL, by contacting her at (937) 656-5700 or at Elizabeth.Berman@WPAFB.AF.MIL.

This page intentionally left blank.

APPENDIX C

AMS 1428 Certification for AAF3

SMI, Inc.

12219 SW 131 Avenue
Miami, Florida 33186-6401 USA

Phone: (305) 971-7047
Fax: (305) 971-7048

Attn: Melissa Roshon
Battelle Memorial Institute
505 King Avenue
Columbus, OH 43201-2693

Date: 07-Sep-2011

SMI/REF: 1106-510

Product: **BATTELLE AAF 53223-52** (received 28-Jun-2011)
Dilution: Per specification

Page 1 of 15

AMS 1428G

FLUID, AIRCRAFT DEICING/ANTI-ICING,
NON-NEWTONIAN, (PSEUDOPLASTIC), SAE TYPES II, III, AND IV

3.1.3	Appearance	<u>Conforms</u>
3.1.4	Environmental Information	
3.1.4.1	Biological Oxygen Demand (BOD)	<u>Informational</u>
3.1.4.2	Total Oxygen Demand (TOD)	<u>Informational</u>
3.1.4.3	Biodegradability	<u>Informational</u>
3.1.4.4	Aquatic Toxicity	<u>Informational</u>
3.1.5	Trace Contaminants	<u>Informational</u>
3.2	Physical Properties	
3.2.1	Fluid As Received in Neat Form	
3.2.1.1	Flash Point	<u>Conforms</u>
3.2.1.2	Specific Gravity	<u>Informational</u>
3.2.1.3	pH	<u>Informational</u>
3.2.1.4	Refractive Index	<u>Informational</u>
3.2.1.5	Surface Tension	<u>Informational</u>
3.2.2	Fluid Stability	
3.2.2.1	Thermal Stability - Accelerated Aging	<u>Conforms</u>
3.2.2.2	Exposure to Dry Air	<u>Conforms</u>
3.2.2.3	Dry-out by Exposure to Cold Dry Air	<u>Conforms</u>
3.2.2.4	Successive Dryout and Rehydration	<u>Conforms</u>
3.2.2.5	Thin Film Thermal Stability	<u>Conforms</u>
3.2.2.6	Storage Stability	<u>Not performed</u>
3.2.2.7	Shear Stability	<u>Not performed</u>
3.2.2.8	Hard Water Stability	<u>Conforms</u>
3.2.2.9	Tendency to Foam	<u>Not performed</u>
3.2.2.10	Cold Storage Stability	<u>Informational</u>

Client: Battelle Memorial Institute
 Product: **BATTELLE AAF 53223-52**
 Dilution: Per specification
AMS 1428G

Date: 07-Sep-2011
 SMI/REF: 1106-510

3.2.3	Rheological Properties	
3.2.3.1	Viscosity	<u>Informational</u>
3.2.4	Anti-icing Performance	<u>Not performed</u>
3.2.5	Aerodynamic Acceptance	<u>Not performed</u>
3.3	Fluid Tested Both Neat and as a Diluted Solution	
3.3.1	Freezing Point	<u>Conforms</u>
3.3.2	Effect on Aircraft Materials	
3.3.2.1	Sandwich Corrosion	<u>Conforms</u>
3.3.2.2	Total Immersion Corrosion	<u>Conforms</u>
3.3.2.3	Low Embrittling Cadmium Plate	<u>Conforms</u>
3.3.2.4	Stress-Corrosion Resistance	
	AMS 4911	<u>Conforms</u>
	AMS 4916	<u>Informational</u>
3.3.2.5	Hydrogen Embrittlement	<u>Conforms</u>
3.3.2.6	Effect on Transparent Plastics	
	MIL-P-25690	<u>Conforms</u>
	MIL-P-83310	<u>Conforms</u>
3.3.3	Effect on Painted Surfaces	<u>Conforms</u>
3.3.4	Effect on Unpainted Surfaces	<u>Conforms</u>
3.3.5	Pavement Compatibility	
3.3.5.1	Runway Concrete Scaling Resistance	<u>Conforms</u>

Respectfully submitted,



Patricia D. Viani, SMI Inc.

This page intentionally left blank.

APPENDIX D

Holdover Time (HOT) Report for AAF1 and AAF2

Aircraft Ground Anti-Icing Fluid Endurance Time Test Results

**Battelle AAF1 (Type IV) & Battelle AAF2 (Type IV)
*Neat Fluid***

Prepared for

Battelle Memorial Institute

by



These tests were made possible with the guidance, participation and contribution of the Transportation Development Centre of Transport Canada and the Federal Aviation Administration.

September 2012

Version 1.1

Report No. B-AAF1/2 2010-11

Aircraft Ground Anti-Icing Fluid Endurance Time Test Results

Battelle AAF1 (Type IV) & Battelle AAF2 (Type IV) Neat Fluid

Prepared for

Battelle Memorial Institute

Prepared by: 
Stephanie Bendickson
Project Analyst

Sept. 10, 2012
Date

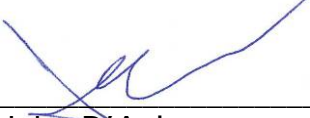
Reviewed by: 
John D'Avirro
Program Manager, Eng.

Sept. 10, 2012
Date



These tests were made possible with the guidance, participation and contribution of the Transportation Development Centre of Transport Canada and the Federal Aviation Administration.

September 2012
Version 1.1
Report No. B-AAF1/2 2010-11

FLUID IDENTIFICATION AND CHARACTERISTICS: SAMPLE AAF1

Manufacturer: Battelle Memorial Institute

Fluid Test Name: AAF1

APS Fluid Code: B1

Fluid Commercial Name: NOT COMMERCIALIZED

Fluid Type / Colour: Type IV / Green

Fluid Formulation: Propylene Glycol

Batch #: 53233-52

Date of Receipt: July 12, 2011

Brix (Measured): 35.0°

Freeze Point (Stated): not provided

LOUT (Stated): not provided

Viscosity: not provided / not measured

WSET (from AMIL): not provided

FLUID IDENTIFICATION AND CHARACTERISTICS: SAMPLE AAF2

Manufacturer: Battelle Memorial Institute

Fluid Test Name: AAF2

APS Fluid Code: B2

Fluid Commercial Name: NOT COMMERCIALIZED

Fluid Type / Colour: Type IV / Green

Fluid Formulation: Non-glycol

Batch #: 53223-56

Date of Receipt: July 12, 2011

Brix (Measured): 41.0°

Freeze Point (Stated): not provided

LOUT (Stated): not provided

Viscosity: not provided / not measured

WSET (from AMIL): not provided

SUMMARY

The objective of this project was to conduct preliminary endurance time testing with two experimental Type IV fluids, Battelle AAF1 and Battelle AAF2. Tests were carried out in select conditions encompassed by the Holdover Time (HOT) guidelines. This report contains the results of these measurements and was completed with the support of the fluid manufacturer, the Transport Development Centre (TDC) of Transport Canada and the Federal Aviation Administration (FAA).

The HOT test procedure consisted of pouring fluids onto clean aluminum and composite test surfaces inclined at 10°; the onset of failure was recorded as a function of time in simulated freezing precipitation. Tests were performed at the National Research Council Canada (NRC) Climatic Engineering Facility (CEF) located in Ottawa, Ontario.

The data collected indicates the endurance times of both AAF1 and AAF2 are superior to the current Type IV generic holdover times in select freezing precipitation conditions.

This page intentionally left blank.

TABLE OF CONTENTS

	Page
1. INTRODUCTION	1
2. METHODOLOGY	3
2.1 Test Site	3
2.2 Test Equipment	3
2.2.1 Environmental Chamber Equipment	3
2.2.2 Test Surface Structures	3
2.2.3 Test Surface Material	5
2.2.4 Test Stands.....	5
2.2.5 Collection Pans	5
2.2.6 NRC Sprayer Assembly	5
2.2.7 Calibration	6
2.3 Test Procedures	6
2.3.1 General Procedure (Type IV Freezing Precipitation Tests)	6
2.3.2 End Condition Definitions	7
2.3.3 Precipitation Rate Measurement Procedures	7
2.4 Precipitation Rate Limits in Type IV Endurance Time Testing	9
2.4.1 Freezing Fog.....	11
2.4.2 Freezing Drizzle.....	11
2.4.3 Light Freezing Rain	11
2.4.4 Rain on a Cold-Soaked Surface	12
2.4.5 Snow	12
2.5 Ambient Temperatures in Type IV Endurance Time Testing	12
2.6 Freezing Precipitation Droplet Sizes	12
2.7 Summary of Freezing Precipitation Test Conditions.....	14
3. DESCRIPTION OF DATA	19
3.1 Freezing Drizzle Tests	19
3.2 Light Freezing Rain Tests	19
3.3 Freezing Fog Tests	19
3.4 Rain on Cold-Soaked Surface Tests	20
3.5 Natural Snow Tests	20
3.6 Log of Tests	20
4. RESULTS AND DISCUSSION	21
4.1 Data	21
4.2 Discussion.....	21

This page intentionally left blank.

LIST OF FIGURES	Page
Figure 2.1: Standard Test Plate Schematic.....	4
Figure 2.2: Cold Soak Box Schematic.....	4
Figure 2.3: Test Stand Setup Schematic.....	5
Figure 2.4: Calculation of Outdoor Precipitation Rate	9
Figure 2.5: Precipitation Rate Limits Used in Endurance Time Testing.....	11
Figure 4.1: Freezing Drizzle, -3°C	22
Figure 4.2: Freezing Drizzle, -10°C	22
Figure 4.3: Light Freezing Rain, -6°C	23
Figure 4.4: Light Freezing Rain, -10°C	23

LIST OF TABLES	Page
Table 2.1: Definition of Weather Phenomenon.....	10
Table 2.2: Theoretical and Experimental MVDs.....	13
Table 2.3: Summary of Freezing Precipitation Test Conditions (Type I Fluids).....	14
Table 3.1: Summary of Tests Performed.....	20

LIST OF PHOTOS	Page
Photo 2.1: Outdoor View of NRC Climatic Engineering Facility	15
Photo 2.2: Inside View of NRC Climatic Engineering Facility.....	15
Photo 2.3: Cold-Soak / Leading Edge Thermal Equivalent Box	16
Photo 2.4: Collection Pans Used Indoors at the NRC	16
Photo 2.5: Sprayer Assembly	17
Photo 2.6: Sprayer Assembly in Use	17
Photo 2.7: Sprayer Nozzle	18

This page intentionally left blank.

GLOSSARY

APS	APS Aviation Inc.
ARP	Aerospace Recommended Practice
CEF	Climatic Engineering Facility
FAA	Federal Aviation Administration
HOT	Holdover Time
ISO	International Organization for Standardization
LOUT	Lowest Operational Use Temperature
LWC	Liquid Water Content
MVD	Median Volume Diameter
MANOBS	Manual of Surface Weather Observations
NCAR	National Center for Atmospheric Research
NRC	National Research Council Canada
SAE	Society of Automotive Engineers, Inc.
TDC	Transportation Development Centre

This page intentionally left blank.

1. INTRODUCTION

Aircraft ground de/anti-icing has been the subject of concentrated industry attention in recent years due to the occurrence of several fatal icing-related aircraft accidents. Notably, attention has been placed on the enhancement of anti-icing fluids in order to provide an extended period of protection against further contamination following initial deicing. This emphasis has led to the development of de/anti-icing fluid holdover time (HOT) tables. These tables, accepted by regulatory authorities, are used by aircraft operators for departure planning in adverse winter conditions. Specifically, they provide the duration of time that qualified fluids provide protection against ice formation under specific weather conditions.

New anti-icing fluid formulations continue to be developed by leading manufacturers with the specific objective of prolonging fluid holdover times without compromising the aerodynamic features of the airfoil. The purpose of the endurance time testing program is to measure the endurance times of these new fluids and develop fluid-specific HOT tables that provide guidance for their use. Flat plate tests, conducted in natural and simulated precipitation, are used to evaluate fluid endurance times. Society of Automotive Engineers (SAE) Aerospace Recommended Practice (ARP) ARP5485 provides the test procedures and requirements for measuring endurance times of Type II, III and IV fluids.

This report provides a detailed account of preliminary endurance time testing APS Aviation Inc. (APS) carried out with Battelle AAF1 and AAF2, two experimental Type IV fluids. It describes the test methodology used, data collected, and a brief analysis of the results.

This report has been created with the support of the fluid manufacturer, the Transport Development Centre (TDC) of Transport Canada and the Federal Aviation Administration (FAA).

This page intentionally left blank.

2. METHODOLOGY

ARP5485 provides the procedure and requirements for endurance time testing with Type II, III and IV fluids in natural and simulated conditions. This chapter summarizes some of aspects of the test methodology included in ARP5485, and some aspects which are not included in ARP5485. The chapter includes sections for test site, equipment, procedures, precipitation rates and ambient temperatures used in Type IV endurance time testing, and freezing precipitation droplet sizes.

2.1 Test Site

Tests were conducted under simulated precipitation conditions indoors at the National Research Council (NRC) Climatic Engineering Facility (CEF), where precipitation is artificially produced. Photo 2.1 provides an outdoor view of the facility giving a general indication of its size (30 m by 5.4 m, height 8 m). The facility was originally designed for the testing of locomotives; Photo 2.2 provides an interior view of the CEF set up for endurance time testing.

2.2 Test Equipment

The key equipment used in testing is described in this section, as are the calibration procedures APS follows for ensuring the accuracy of its equipment.

2.2.1 Environmental Chamber Equipment

The general environmental chamber equipment used during tests (including air temperature sensor, data acquisition system, temperature control equipment, etc.) was as stipulated in the requirements set out in ARP5485.

2.2.2 Test Surface Structures

The majority of testing with Type IV fluids is carried out on standard flat plates. A schematic of a standard flat plate is provided in Figure 2.1. It depicts the size and surface markings of a standard flat plate. Three parallel lines are positioned at 2.5 cm (1"), 15 cm (6") and 30 cm (12") from the top of the plate. The plates are marked with 15 crosshairs, which are used in determining when end conditions (see Subsection 2.3.2) are achieved.

Figure 2.2 shows a schematic of the sealed boxes used for rain on cold soaked surface tests (tests simulating a cold soaked wing). The top of the box consists of a flat plate identical to the standard flat plate. A box shaped reservoir is welded to the bottom of the plate. Photo 2.3 shows a picture of a sealed box.

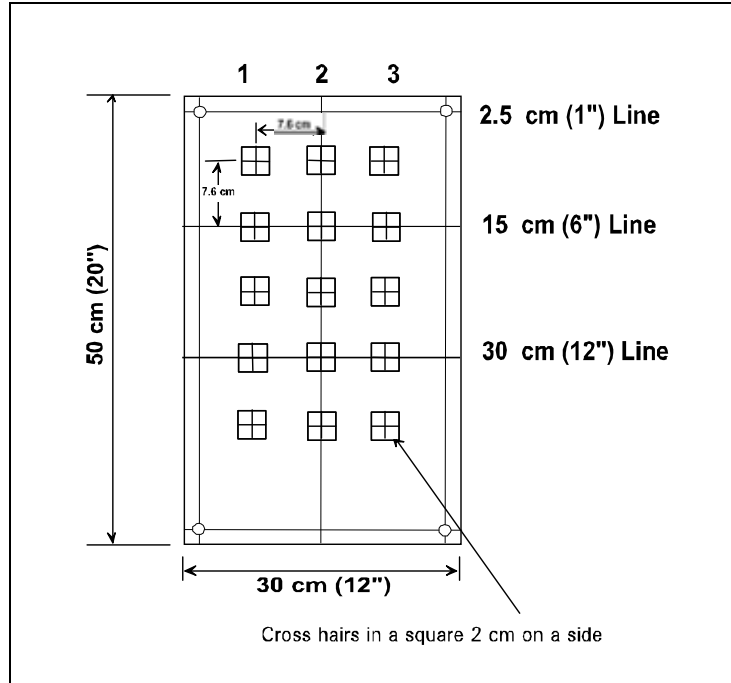

Figure 2.1: Standard Test Plate Schematic

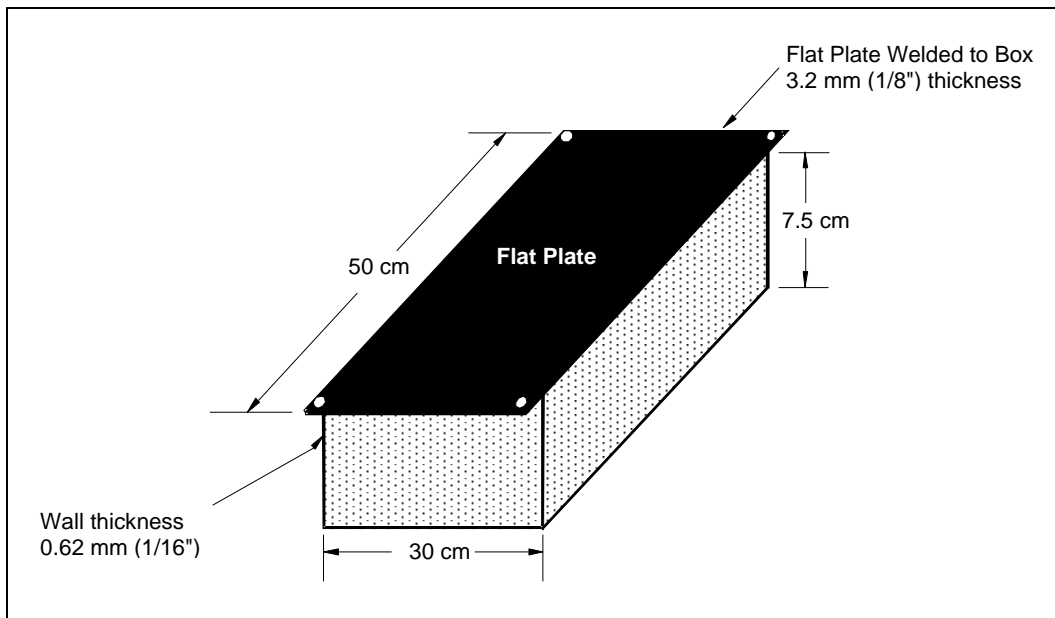

Figure 2.2: Cold Soak Box Schematic

2.2.3 Test Surface Material

All tests were conducted on the standard aluminum endurance time testing surface: 0.32 cm thick Alclad 2024 T3 aluminum.

2.2.4 Test Stands

Figure 2.3 shows a schematic of the test platform used for HOT testing. Each plate represents a flat plate test. For simulated freezing precipitation tests at the NRC, 12 plates are mounted on 2 six-position stands. Photo 2.2 shows the test stands set up for indoor testing.

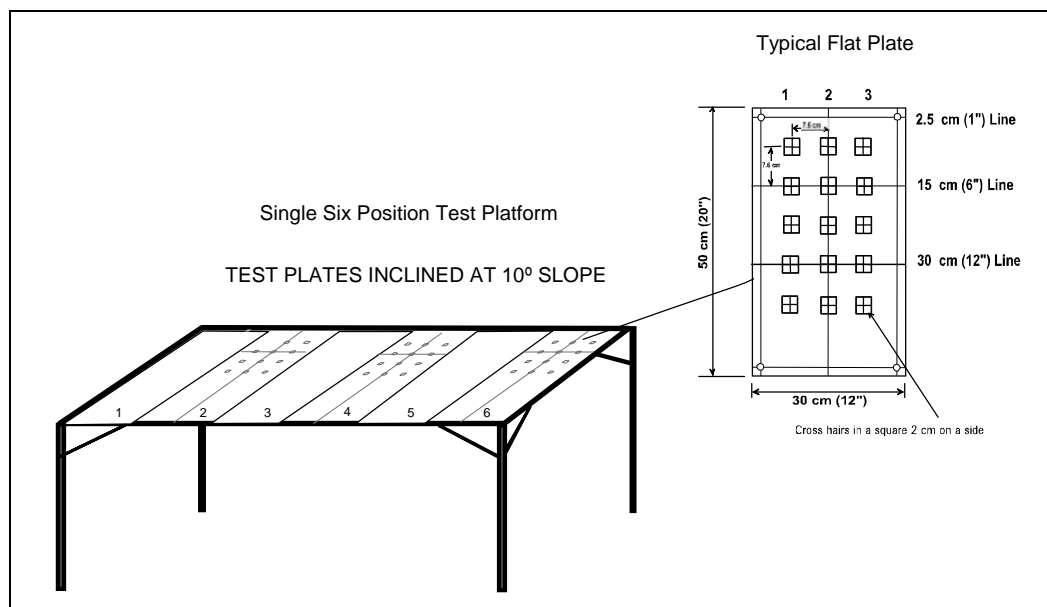

Figure 2.3: Test Stand Setup Schematic

2.2.5 Collection Pans

Photo 2.4 shows the collection pans used for measuring precipitation rates indoors at the NRC.

2.2.6 NRC Sprayer Assembly

NRC developed an improved sprayer assembly, shown in Photos 2.5 and 2.6, in 1997-98. The improved sprayer provides a larger scan area and improved spray uniformity over the test bed area. The scanner consists of a horizontal main

shaft supported by two bearings. The actual spray head assembly is shaft-mounted on a rotating scanner, so that one scan covers a lateral running strip of the test bed area. A stepper motor is synchronized to index the relative angle of the spray head between scans along an axis perpendicular to the scan axis. This provides two axes of rotation, essentially an x-y plane; one along each axis. Each scan is consecutively indexed in order to complete the precipitation coverage of the test bed area. This defines one cycle of the spray unit. The scan rate, index angle, and the number of scans per cycle are adjusted, along with the fluid delivery pressures (water and air) to obtain appropriate droplet sizes and precipitation rates. The spray nozzle is shown in Photo 2.7.

2.2.7 Calibration

APS measurement instruments and test equipment are calibrated and/or verified on an annual basis. This calibration is carried out according to a calibration plan based upon approved International Organization for Standardization (ISO) 9001:2000 standards, and developed internally by APS.

2.3 Test Procedures

ARP5485 provides the procedure for endurance time testing of Type IV fluids under natural precipitation and simulated freezing precipitation. The details of the procedure are summarized in this section.

2.3.1 General Procedure (Type IV Freezing Precipitation Tests)

The procedure for measuring endurance times of Type IV fluids in freezing precipitation consists of pouring de/anti-icing fluids onto clean flat plates exposed to various winter precipitation conditions, and recording the elapsed time for the test plate to reach the defined end condition (see Subsection 2.3.2), when a specified degree of freezing occurs. Key details of the procedure include:

- Freezing fog, freezing drizzle and light freezing rain tests are conducted on standard flat plates (see Section 2.2.2);
- Cold-soak surface tests are conducted on filled cold-soak boxes (see Section 2.2.2);
- Fluid is applied at ambient temperature; and

- 1 L of fluid is hand-poured onto the test surface.

2.3.2 End Condition Definitions

Failure is called when 30 percent (1/3) of the plate or 5 cross-hairs are covered with frozen contamination. Appearance of this frozen contamination includes, but is not limited to:

- a) Ice front;
- b) Ice sheet;
- c) Slush, in clusters or as a front;
- d) Disseminated fine ice crystals;
- e) Frost on surface;
- f) Clear ice pieces partially or totally imbedded in fluid; and
- g) Snow bridges on top of the fluid.

2.3.3 Precipitation Rate Measurement Procedures

The procedures for measuring and determining precipitation rates during simulated precipitation and natural precipitation conditions are provided below.

2.3.3.1 Simulated precipitation conditions

Prior to the start of the rate collection period, the proper needles and nozzles are installed in the spray unit, and both the air and water pressures are adjusted. Water spray calibration is performed by placing catch pans on the test stand, each pan marked with a number identifying the collection location on the test stand, and exposing the pans to a predetermined precipitation collection period.

The pans are weighed prior to exposure to precipitation and the weights are recorded. Prior to the start of the precipitation catch period, the exact time (hh:mm:ss) is recorded. The pans are re-weighed following this collection period and the precipitation rates over the area of the test stand are examined. If the rates are unacceptable, re-calibration of the water spray is necessary. If the rates are deemed to be acceptable, the pans are weighed and placed on the stand for a second collection period. After the second collection period has expired, the pans are again re-weighed and the rates computed.

Once two rates have been collected at each test location, the catch rates of the first and second collection are compared. If the average catch rate for any location is deemed to be acceptable for this condition, then the pouring of fluids may begin at this location.

Rates are continuously monitored at a minimum of two locations during a test in order to ensure there are no significant rate fluctuations. Pans will be placed at these locations and be re-weighed at fixed intervals (15 minutes, typically) during the course of a test. If a rate fluctuation occurs, the test is stopped.

Following the failure of a test plate, a rate collection pan is weighed and placed at the plate location for a predetermined time interval. It is then re-weighed and placed again on the stand to collect a minimum of two additional rates at this location.

The rate of precipitation for any location on the stand is calculated by averaging the two rates collected prior to the test and the two rates collected following the test.

2.3.3.2 *Natural precipitation conditions*

Two rate collection pans per test stand are used to determine precipitation rates in natural conditions. Prior to the rate collection period, both pans are marked (upper and lower), and the inner bottom and sides of the each pan are wetted with Type IV anti-icing fluid to prevent blowing snow from escaping the pan. The wetted pans are then weighed to the nearest gram. The start time of the rate collection period is recorded (h/min/sec) from the timepiece located near the rate station before leaving the trailer to place the pans on the test stand. The person responsible for collecting precipitation rate data take the time delay necessary to proceed outside from the rate station into consideration.

The pans are positioned in locations 6 and 7 (see Figure 2.3) and are allowed to collect precipitation for 10-minute intervals in normal conditions and 5-minute intervals in periods of high precipitation rates and high winds. Prior to removal of the plate pans from the test stand for re-weighing, any accumulated precipitation on the lips and outer sides of each plate pan is carefully removed. The plate pans are then carried to the rate station for re-weighing. Upon entering the trailer, the exact time is noted. The new weights of the plate pans are recorded and the pans are brought back outside. This procedure is continued until the final plate on the test stand has failed.

The rate for any HOT test in natural snow is obtained by computing the time-weighted average of the rates collected in the upper and lower pans over the duration of this particular test.

An example of the rate calculation method for tests in natural snow conditions is displayed in Figure 2.4. Typically, two collections pans are used for each test. The start and end times of the test are 10:15 and 10:45, respectively. Precipitation rates for one pan were collected at three periods during this test,

indicated by t1, t2, and t3 (minutes). The calculated rates for each collection period are indicated by R1, R2, and R3 (g/dm²/h). In order to calculate the average rate for this pan, the following formula is then used:

$$\frac{(R_1 \times t_1 + R_2 \times t_2 + R_3 \times t_3)}{t_1 + t_2 + t_3}$$

In the example shown in Figure 2.6, the rate is calculated as follows:

$$\frac{(25 \times 10 + 22 \times 8 + 34 \times 5)}{10 + 8 + 5}$$

The calculated average rate for this pan is 25.9 g/dm²/h. The average rate for the other collection pan is calculated in similar fashion, and the average of the two rates is then taken.

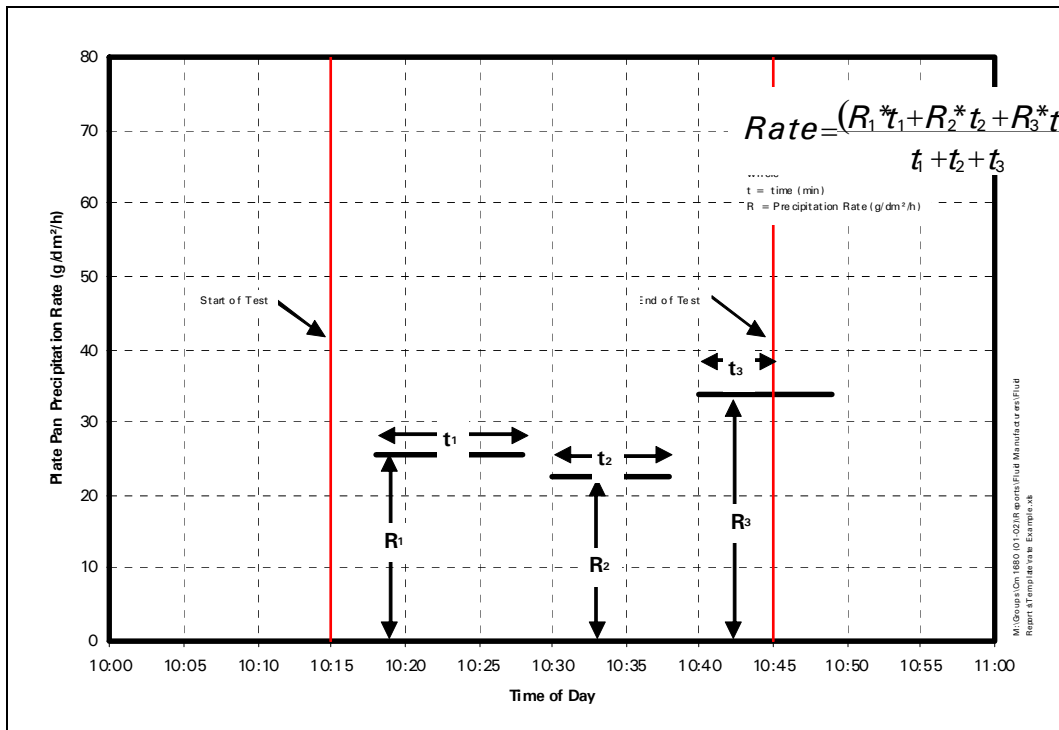

Figure 2.4: Calculation of Outdoor Precipitation Rate

2.4 Precipitation Rate Limits in Type IV Endurance Time Testing

Upper and lower precipitation rate limits are an important part of the test methodology for measuring fluid endurance times and developing holdover times from the data collected.

Table 2.1 provides the meteorologically accepted definitions of weather phenomenon / precipitation types. It also includes the criteria used to determine precipitation intensity. This table was compiled by the National Centre for Atmospheric Research (NCAR) from the *World Meteorological Organization Guide to Meteorological Instruments and Methods of Observation* (1983) and from the *American Meteorological Society, Glossary of Meteorology WSOH # 7 Manual of Surface Weather Observations (MANOBS)* (3/94).

Table 2.1: Definition of Weather Phenomenon

Weather Phenomenon*	Definition*	Intensity Criteria**																							
FROST (No METAR code) Note: No Intensity is assigned to FROST.	Ice crystals that form from ice-saturated air at temperatures below 0°C (32°F) by direct sublimation on the ground or other exposed objects.	<table border="1"> <thead> <tr> <th></th> <th>Snow(SN), Pellets(GS), Grains(SG), Frz Drizzle(FZDZ)</th> <th>Ice Pellets (PE)</th> </tr> </thead> <tbody> <tr> <td>Estimated Intensity</td> <td>Horizontal Visibility (statute mile)</td> <td>Liquid Equivalent Snow (S) Intensity***</td> <td>Definition and Horizontal Visibility</td> </tr> <tr> <td>Light (-)</td> <td>If visibility is: $\geq 5/8$ mi (≥ 1.0 km)</td> <td>Trace to 0.05 in/hr (≤ 1.0 mm or 10.0 gr/dm²/hr)</td> <td>Scattered pellets on the ground. Visibility not affected.</td> </tr> <tr> <td>Moderate</td> <td>If visibility is: $< 5/8$ to $5/16$ mi (< 1.0 to 0.5 km)</td> <td>> 0.05 to 0.10 in/hr (> 1.0 to 2.5 mm/hr) (> 10.0 to 25.0 gr/dm²/hr)</td> <td>Slow accumulation on the ground. Visibility reduced to less than 7 mi.</td> </tr> <tr> <td>Heavy (+)</td> <td>If visibility is: $< 5/16$ mi (< 0.5 km)</td> <td>More than 0.10 in/hr (> 2.5 mm or 25.0 gr/dm²/hr)</td> <td>Rapid accumulation on the ground. Visibility reduced to less than 3 mi.</td> </tr> </tbody> </table>					Snow(SN), Pellets(GS), Grains(SG), Frz Drizzle(FZDZ)	Ice Pellets (PE)	Estimated Intensity	Horizontal Visibility (statute mile)	Liquid Equivalent Snow (S) Intensity***	Definition and Horizontal Visibility	Light (-)	If visibility is: $\geq 5/8$ mi (≥ 1.0 km)	Trace to 0.05 in/hr (≤ 1.0 mm or 10.0 gr/dm ² /hr)	Scattered pellets on the ground. Visibility not affected.	Moderate	If visibility is: $< 5/8$ to $5/16$ mi (< 1.0 to 0.5 km)	> 0.05 to 0.10 in/hr (> 1.0 to 2.5 mm/hr) (> 10.0 to 25.0 gr/dm ² /hr)	Slow accumulation on the ground. Visibility reduced to less than 7 mi.	Heavy (+)	If visibility is: $< 5/16$ mi (< 0.5 km)	More than 0.10 in/hr (> 2.5 mm or 25.0 gr/dm ² /hr)	Rapid accumulation on the ground. Visibility reduced to less than 3 mi.	
	Snow(SN), Pellets(GS), Grains(SG), Frz Drizzle(FZDZ)	Ice Pellets (PE)																							
Estimated Intensity	Horizontal Visibility (statute mile)	Liquid Equivalent Snow (S) Intensity***	Definition and Horizontal Visibility																						
Light (-)	If visibility is: $\geq 5/8$ mi (≥ 1.0 km)	Trace to 0.05 in/hr (≤ 1.0 mm or 10.0 gr/dm ² /hr)	Scattered pellets on the ground. Visibility not affected.																						
Moderate	If visibility is: $< 5/8$ to $5/16$ mi (< 1.0 to 0.5 km)	> 0.05 to 0.10 in/hr (> 1.0 to 2.5 mm/hr) (> 10.0 to 25.0 gr/dm ² /hr)	Slow accumulation on the ground. Visibility reduced to less than 7 mi.																						
Heavy (+)	If visibility is: $< 5/16$ mi (< 0.5 km)	More than 0.10 in/hr (> 2.5 mm or 25.0 gr/dm ² /hr)	Rapid accumulation on the ground. Visibility reduced to less than 3 mi.																						
FREEZING FOG (FZFG) Note: No Intensity is assigned to FRZ FOG.	A suspension of numerous minute water droplets which freezes upon impact with ground or other exposed objects, generally reducing the horizontal visibility at the earth's surface to less than 1 km (5/8 mile).	<table border="1"> <thead> <tr> <th colspan="2">Drizzle Intensity (FZDZ)</th> </tr> </thead> <tbody> <tr> <td>Light(-)</td> <td>Trace to 0.01 in/hr (0.254 mm or 2.54 gr/dm²/hr)</td> </tr> <tr> <td>Moderate</td> <td>From 0.01 to 0.02 in/hr (2.54 to 5.08 gr/dm²/hr)</td> </tr> <tr> <td>Heavy(+)</td> <td>More than 0.02 in/hr (> 5.08 gr/dm²/hr) Note: Drizzle > 0.04 in/hr is usually in the form of rain.</td> </tr> </tbody> </table>				Drizzle Intensity (FZDZ)		Light(-)	Trace to 0.01 in/hr (0.254 mm or 2.54 gr/dm ² /hr)	Moderate	From 0.01 to 0.02 in/hr (2.54 to 5.08 gr/dm ² /hr)	Heavy(+)	More than 0.02 in/hr (> 5.08 gr/dm ² /hr) Note: Drizzle > 0.04 in/hr is usually in the form of rain.												
Drizzle Intensity (FZDZ)																									
Light(-)	Trace to 0.01 in/hr (0.254 mm or 2.54 gr/dm ² /hr)																								
Moderate	From 0.01 to 0.02 in/hr (2.54 to 5.08 gr/dm ² /hr)																								
Heavy(+)	More than 0.02 in/hr (> 5.08 gr/dm ² /hr) Note: Drizzle > 0.04 in/hr is usually in the form of rain.																								
SNOW (SN)	Precipitation of ice crystals, most of which are branched, star-shaped, or mixed with unbranched crystals. At temperatures higher than about -5°C (23°F), the crystals are generally agglomerated into snowflakes.	<table border="1"> <thead> <tr> <th colspan="2">Rain (RA), Freezing Rain (FZRA), Ice Pellets (PE)</th> </tr> </thead> <tbody> <tr> <td>Measured Intensity</td> <td>Up to 0.10 in/hr (2.5 mm or 25 gr/dm²/hr); Maximum 0.01 inch in 6 minutes</td> </tr> <tr> <td>Light (-)</td> <td>From scattered drops that, regardless of duration, do not completely wet an exposed surface up to a condition where individual drops are easily seen.</td> </tr> <tr> <td>Estimated Intensity</td> <td></td> </tr> <tr> <td>Measured Intensity</td> <td>0.11 in to 0.30 in/hr (7.6 mm or 76 gr/dm²/hr); More than 0.01 to 0.03 inch in 6 minutes</td> </tr> <tr> <td>Moderate</td> <td>Individual drops are not clearly identifiable; spray is observable just above pavement and other hard surfaces.</td> </tr> <tr> <td>Estimated Intensity</td> <td></td> </tr> <tr> <td>Measured Intensity</td> <td>More than 0.30 in/hr (7.6 mm or 76 gr/dm²/hr); More than 0.03 inch in 6 minutes</td> </tr> <tr> <td>Heavy (+)</td> <td>Rain seemingly falls in sheets; individual drops are not identifiable; heavy spray to height of several inches is observed over hard surfaces.</td> </tr> <tr> <td>Estimated Intensity</td> <td></td> </tr> </tbody> </table>				Rain (RA), Freezing Rain (FZRA), Ice Pellets (PE)		Measured Intensity	Up to 0.10 in/hr (2.5 mm or 25 gr/dm ² /hr); Maximum 0.01 inch in 6 minutes	Light (-)	From scattered drops that, regardless of duration, do not completely wet an exposed surface up to a condition where individual drops are easily seen.	Estimated Intensity		Measured Intensity	0.11 in to 0.30 in/hr (7.6 mm or 76 gr/dm ² /hr); More than 0.01 to 0.03 inch in 6 minutes	Moderate	Individual drops are not clearly identifiable; spray is observable just above pavement and other hard surfaces.	Estimated Intensity		Measured Intensity	More than 0.30 in/hr (7.6 mm or 76 gr/dm ² /hr); More than 0.03 inch in 6 minutes	Heavy (+)	Rain seemingly falls in sheets; individual drops are not identifiable; heavy spray to height of several inches is observed over hard surfaces.	Estimated Intensity	
Rain (RA), Freezing Rain (FZRA), Ice Pellets (PE)																									
Measured Intensity	Up to 0.10 in/hr (2.5 mm or 25 gr/dm ² /hr); Maximum 0.01 inch in 6 minutes																								
Light (-)	From scattered drops that, regardless of duration, do not completely wet an exposed surface up to a condition where individual drops are easily seen.																								
Estimated Intensity																									
Measured Intensity	0.11 in to 0.30 in/hr (7.6 mm or 76 gr/dm ² /hr); More than 0.01 to 0.03 inch in 6 minutes																								
Moderate	Individual drops are not clearly identifiable; spray is observable just above pavement and other hard surfaces.																								
Estimated Intensity																									
Measured Intensity	More than 0.30 in/hr (7.6 mm or 76 gr/dm ² /hr); More than 0.03 inch in 6 minutes																								
Heavy (+)	Rain seemingly falls in sheets; individual drops are not identifiable; heavy spray to height of several inches is observed over hard surfaces.																								
Estimated Intensity																									
FRZING DRIZZLE (FZDZ)	Fairly uniform precipitation composed exclusively of fine drops (diameter less than 0.5 mm (0.02 in.)) very close together which freezes upon impact with the ground or other exposed objects.	<p>Note: Horizontal visibility is only an estimation of snow and freezing drizzle intensity. Measurements and observations have shown that visibility and precipitation intensity are not always directly correlated.</p>																							
FREEZING RAIN (FZRA)	Precipitation of liquid water particles which freezes upon impact with the ground or other exposed objects, either in the form of drops of more than 0.5 mm (0.02 in.) or smaller drops which, in contrast to drizzle, are widely separated.																								
RAIN (RA)	Precipitation of liquid water particles either in the form of drops of more than 0.5 mm (0.02 in.) diameter or of smaller widely scattered drops.																								
SNOW PELLETS (GS)	Precipitation of white and opaque grains of ice. These grains are spherical or sometimes conical; their diameter is about 2-5 mm (0.1-0.2 in.). Grains are brittle, easily crushed; they bounce and break on hard ground.																								
SNOW GRAINS (SG)	Precipitation of very small white and opaque grains of ice. These grains are fairly flat or elongated; their diameter is less than 1 mm (0.04 in.). When the grains hit hard ground, they do not bounce or shatter.																								
HAIL (GR)	Precipitation of small balls or pieces of ice with a diameter ranging from 5 to > 50 mm (0.2 to 2.0 in.) falling either separately or agglomerated.																								
ICE PELLETS (PE) Note: Includes Sleet and Small Hail	Precipitation of transparent (sleet or grains of ice), or translucent (small hail) pellets of ice, which are spherical or irregular, and which have a diameter of 5 mm (0.2 in.) or less. The pellets of ice usually bounce when hitting hard ground.																								

* From World Meteorological Organization Guide to Meteorological Instruments and Methods of Observation (1983)
 ** From American Meteorological Society, Glossary of Meteorology WSOH #7 MANOBS (3/94)
 *** NCAR Proposed Definition for Liquid Equivalent Snowfall Intensity
 1) $1 \text{ gm/dm}^2 = 0.01 \text{ cm} = 0.1 \text{ mm} = 0.0039 \text{ in}$
 2) $1 \text{ in} = 2.54 \text{ cm} = 25.4 \text{ mm} = 254 \text{ gm/dm}^2$
 Compiled by Jeff Cole and Roy Rasmussen of NCAR/RAP June 17, 1997 (Updated for METAR codes)

The precipitation rate limits established for Type IV endurance time testing are provided in ARP5485 and are represented graphically in Figure 2.5. Subsections 2.4.1 to 2.4.4 provide detailed definitions and explanations of the precipitation types and rate boundaries used in Type IV endurance time testing. It should be noted that in many cases these limits are not the same as the meteorologically accepted definitions provided in Table 2.1.

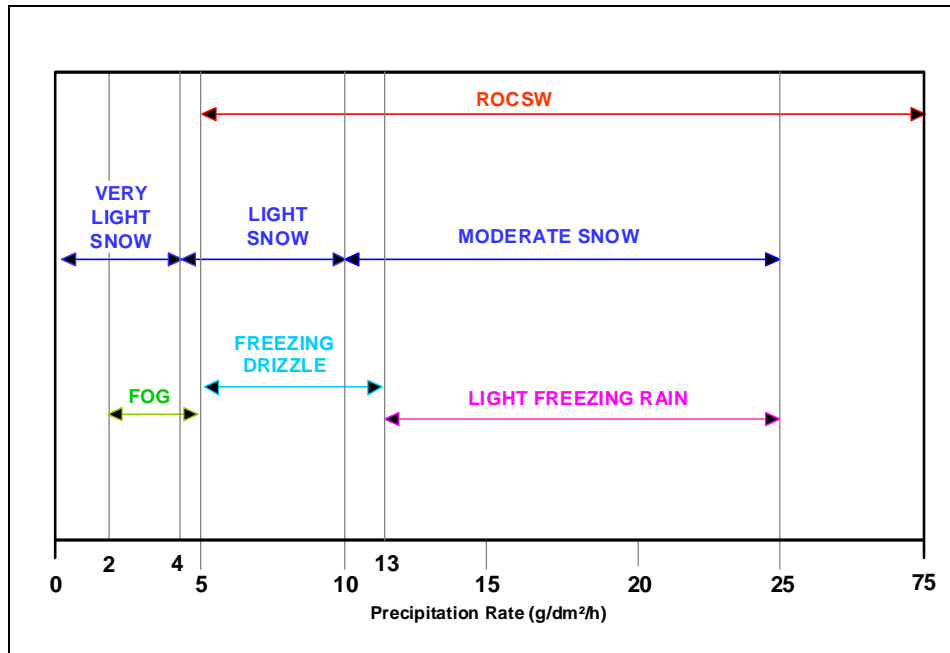

Figure 2.5: Precipitation Rate Limits Used in Endurance Time Testing

2.4.1 Freezing Fog

The precipitation rate limits for endurance time testing in freezing fog were set in 1997 at rates of 2 and 5 g/dm²/h. These limits were determined with input from NRC meteorologists, who helped define an important parameter in the study of fog referred to as the *Liquid Water Content* (LWC). This quantity, expressed in density terms as the mass of water in grams contained in one cubic meter of air, can generally assume values in the range of 0.2 to 0.6 g/m³.

2.4.2 Freezing Drizzle

The precipitation rate limits for endurance time testing in freezing drizzle are 5 and 13 g/dm²/h. The upper limit in this range was adopted based on discussions with meteorological experts and aircraft operators on the SAE G-12 HOT Committee. This range corresponds to heavy drizzle and has been chosen to provide aircraft operators with a greater margin of safety.

2.4.3 Light Freezing Rain

The precipitation rate limits for endurance time testing in light freezing rain are 13 and 25 g/dm²/h. This range corresponds to the category of light freezing rain and is the only freezing rain category considered, as operations in periods of moderate or heavy freezing rain are deemed unsafe.

2.4.4 Rain on a Cold-Soaked Surface

The precipitation rate limits for rain on cold soaked surface are 5 and 75 g/dm²/h. This range encompasses drizzle (5 to 13 g/dm²/h), light rain (13 to 25 g/dm²/h), and moderate rain (25 to 75 g/dm²/h).

2.4.5 Snow

The precipitation rate limits used to determine holdover times for Type IV fluids in snow are 10 and 25 g/dm²/h, which corresponds to moderate snow.

2.5 Ambient Temperatures in Type IV Endurance Time Testing

The Type IV holdover time guidelines are formatted to include four temperature rows:

- -3°C and above;
- Below -3 to -14°C; and
- Below -14 to LOUT.

Endurance time testing in natural precipitation conditions is carried out under a range of temperatures. Endurance time testing In simulated precipitation conditions is conducted at the lower temperature limit of each cell, as follows:

- Freezing Fog: -3°C, -14°C and -25°C
- Freezing Drizzle: -3°C and -10°C*
- Light Freezing Rain: -3°C and -10°C*
- Rain on Cold Soaked Surface: +1°C*

*Notes in the holdover time guidelines limit use of holdover times in these cells to temperatures above the lowest temperature in the temperature band. Endurance time testing for these cells is conducted at the lowest temperature at which the holdover times in the cell can be used.

2.6 Freezing Precipitation Droplet Sizes

Research has shown that median volume diameter (MVD) of rain droplets is related to rate of precipitation as follows:

$$\text{MVD} = (\text{precipitation rate}/10)^{0.23}, \quad \text{where MVD is in mm and rate of precipitation is in g/dm}^2/\text{h}$$

The theoretical MVDs for rain at various rates of precipitation were determined based on this equation. These values are listed in Table 2.2 beside the experimental MVDs for each precipitation condition.

Table 2.2: Theoretical and Experimental MVDs

Precipitation Condition	Experimental MVD (mm)	Theoretical MVD (mm)
Moderate Rain (High rate: 75 g/dm ² /h)	1.4	1.6
Light Rain (Low rate: 13 g/dm ² /h)	1.0	< 1.1
Light Rain (High rate: 25 g/dm ² /h)	1.0	1.2
Drizzle (Low rate: 5 g/dm ² /h)	0.25	< 0.5
Drizzle (High rate: 13 g/dm ² /h)	0.35	< 0.5
Fog		< 0.1

To determine whether droplets produced at the NRC resembled droplets from natural precipitation, a test was conducted during natural light freezing rain conditions in 1997-98 at the APS test site. The droplet sizes were compared to those obtained in simulated light freezing rain at the NRC. The results of these tests are shown below:

a) *For the outdoor test:*

Location: Montreal P.E.T. Airport
 Precipitation: Natural Light Freezing Rain
 Precipitation Rate: 20 g/dm²/h
 Calibrated MVD: 1.0 mm

b) *For the indoor test:*

Location: National Research Council
 Precipitation: Simulated Light Freezing Rain
 Precipitation Rate: 25 g/dm²/h
 Calibrated MVD: 1.0 mm

The MVD for both natural and simulated light freezing rain was 1 mm, indicating that the NRC produced droplets simulate natural precipitation.

As a result of this testing, the MVDs for freezing precipitation testing were established as follows:

- Freezing Fog, high precipitation rate (5 g/dm²/h): 30 μm
- Freezing Fog, low precipitation rate (2 g/dm²/h): 30 μm
- Freezing Drizzle, high precipitation rate (13 g/dm²/h): 350 μm
- Freezing Drizzle, low precipitation rate (5 g/dm²/h): 250 μm
- Light Freezing Rain, high precipitation rate (25 g/dm²/h): 1,000 μm
- Light Freezing Rain, low precipitation rate (13 g/dm²/h): 1,000 μm
- Rain on Cold-Soaked Surface, low precipitation rate (5 g/dm²/h): 250 μm
- Rain on Cold-Soaked Surface, high precipitation rate (75 g/dm²/h): 1,400 μm

2.7 Summary of Freezing Precipitation Test Conditions

The precipitation types and rates, ambient temperatures and droplet sizes used in endurance time testing of Type IV fluids in freezing precipitation were described in the previous subsections. In summary, testing in the 16 conditions listed in Table 2.3 is required for the complete evaluation of the endurance time performance of a Type IV fluid in simulated freezing precipitation.

Note: The testing documented in this report was preliminary and limited; tests were not carried out in all conditions specified in Table 2.3.

Table 2.3: Summary of Freezing Precipitation Test Conditions (Type I Fluids)

Precipitation Type	Ambient Temperature	Precipitation Rate (Droplet Size)
Freezing Fog	-3°C	2 g/dm ² /h (30 μm)
		5 g/dm ² /h (30 μm)
	-14°C	2 g/dm ² /h (30 μm)
		5 g/dm ² /h (30 μm)
	-25°C	2 g/dm ² /h (30 μm)
		5 g/dm ² /h (30 μm)
Freezing Drizzle	-3°C	5 g/dm ² /h (250 μm)
		13 g/dm ² /h (350 μm)
	-10°C	5 g/dm ² /h (250 μm)
		13 g/dm ² /h (350 μm)
Light Freezing Rain	-3°C	13 g/dm ² /h (1,000 μm)
		25 g/dm ² /h (1,000 μm)
	-10°C	13 g/dm ² /h (1,000 μm)
		25 g/dm ² /h (1,000 μm)
Rain on Cold-Soaked Surface	+1°C	5 g/dm ² /h (250 μm)
		75 g/dm ² /h (1,400 μm)

Photo 2.1: Outdoor View of NRC Climatic Engineering Facility



Photo 2.2: Inside View of NRC Climatic Engineering Facility

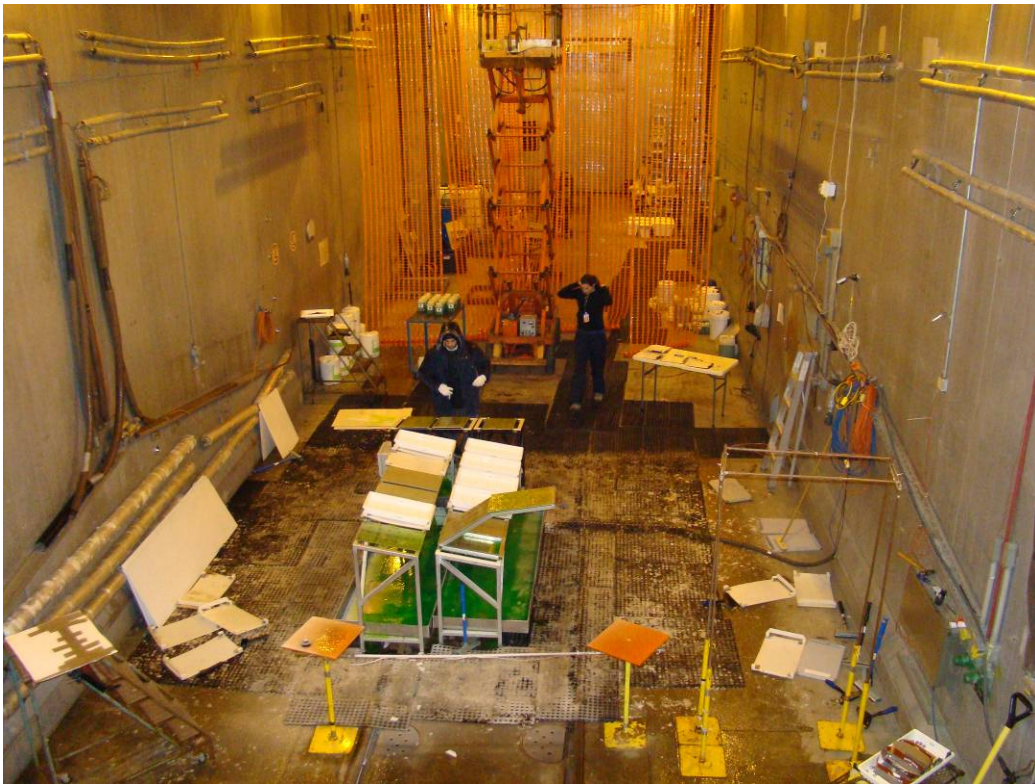

Photo 2.3: Cold-Soak / Leading Edge Thermal Equivalent Box

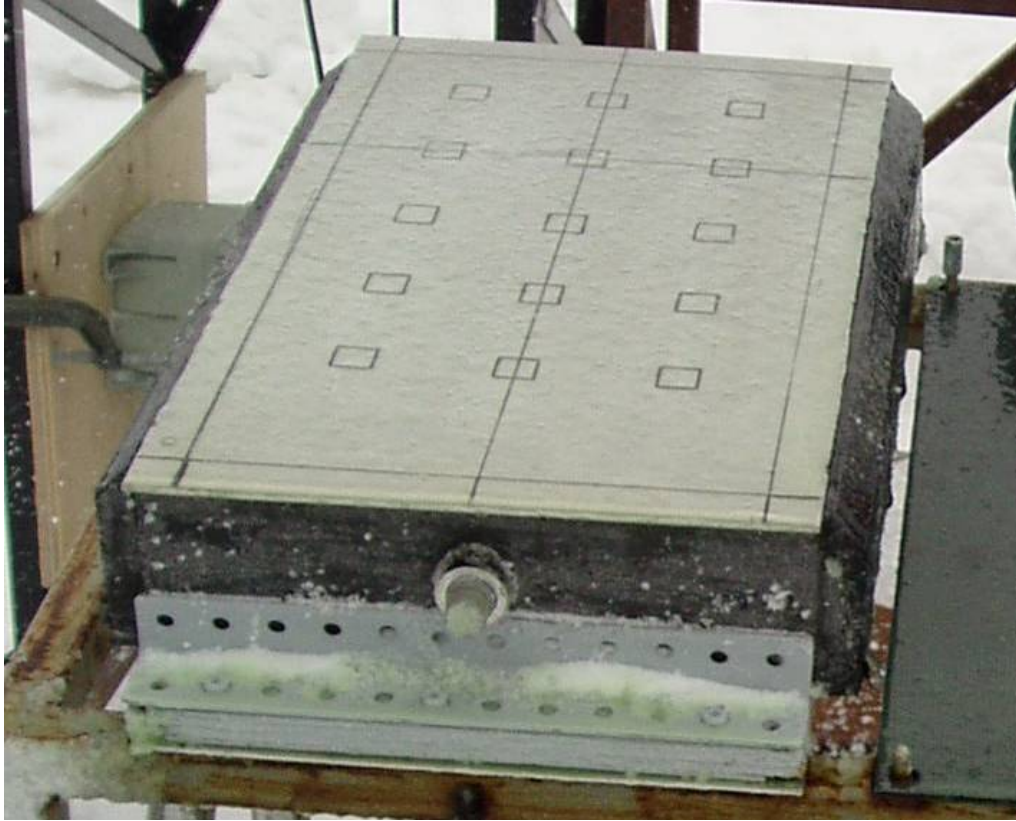

Photo 2.4: Collection Pans Used Indoors at the NRC



Photo 2.5: Sprayer Assembly



Photo 2.6: Sprayer Assembly in Use

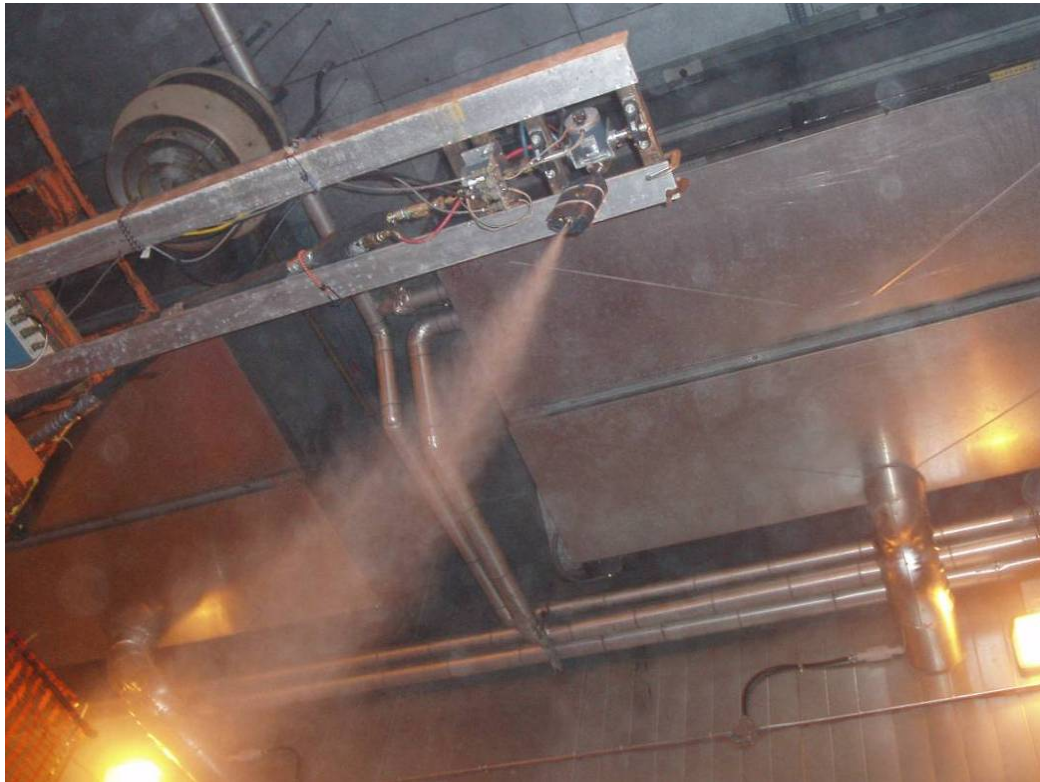
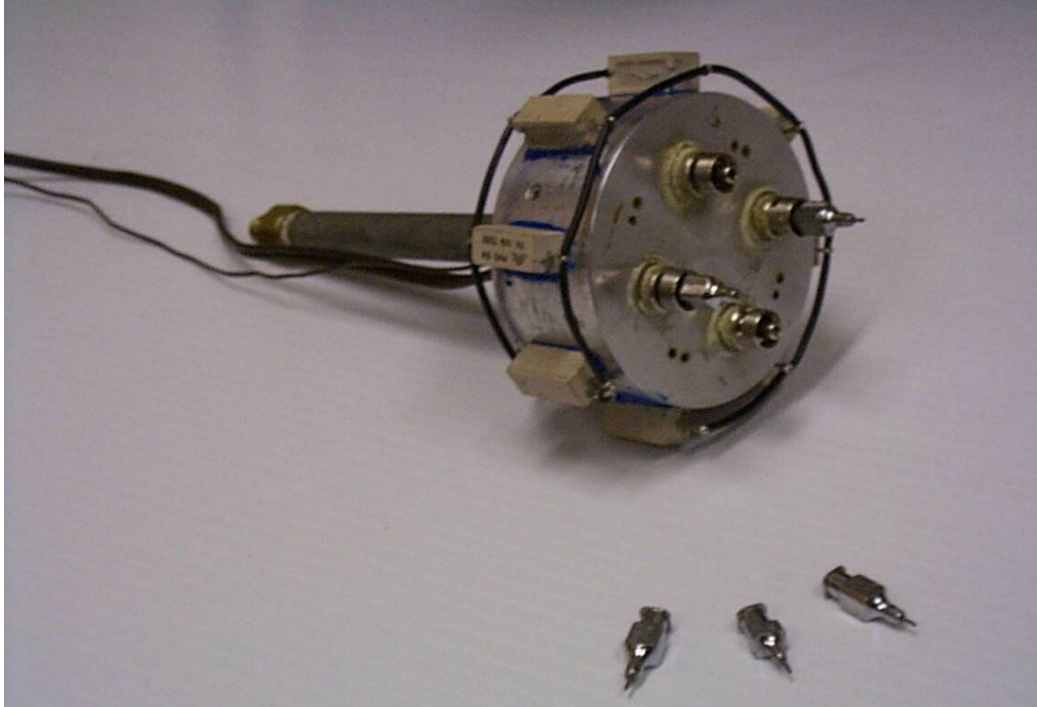

Photo 2.7: Sprayer Nozzle



3. DESCRIPTION OF DATA

This section provides a summary of the number of tests conducted. Breakdowns are provided for quantity of tests performed by precipitation type, ambient temperature, precipitation rate and fluid. A log of tests conducted is provided at the end of this section.

3.1 Freezing Drizzle Tests

Twelve tests were conducted in freezing drizzle. The distribution of tests by fluid, temperature and precipitation rate is shown below.

Ambient Temperature	Precipitation Rate	Tests Conducted	
		AAF1	AAF2
-3°C	13 g/dm ² /h	2	1
-10°C	5 g/dm ² /h	2	2
-10°C	13 g/dm ² /h	2	2

3.2 Light Freezing Rain Tests

Ten tests were conducted in light freezing rain. The distribution of tests by fluid, temperature and precipitation rate is shown below.

Ambient Temperature	Precipitation Rate	Tests Conducted	
		AAF1	AAF2
-6°C	13 g/dm ² /h	1	1
-6°C	25 g/dm ² /h	2	2
-10°C	25 g/dm ² /h	2	2

3.3 Freezing Fog Tests

No tests were conducted in freezing fog with these fluids.

3.4 Rain on Cold-Soaked Surface Tests

No rain on cold-soaked surface tests were conducted with these fluids.

3.5 Natural Snow Tests

No natural snow tests were conducted with these fluids.

3.6 Log of Tests

A log of the tests conducted with Battelle AAF1 and AAF2 is provided in Table 3.1.

Table 3.1: Summary of Tests Performed

Test No.	Date	Fluid Name	Icing Intensity (g/dm ² /h)	Endurance Time (min)	Test Temp. (°C)	Test Surface	Precipitation Type
85	20-Jul-11	AAF1	13.6	87.5	-3.4	Al. Plate	Freezing Drizzle
87	20-Jul-11	AAF1	12.2	92.8	-3.4	Al. Plate	Freezing Drizzle
101	20-Jul-11	AAF1	12.6	103.7	-6.2	Al. Plate	Light Freezing Rain
113	20-Jul-11	AAF1	25.1	70.7	-6.2	Al. Plate	Light Freezing Rain
115	20-Jul-11	AAF1	24.9	70.0	-6.2	Al. Plate	Light Freezing Rain
125	21-Jul-11	AAF1	5.1	119.1	-10.4	Al. Plate	Freezing Drizzle
127	21-Jul-11	AAF1	5.2	119.2	-10.4	Al. Plate	Freezing Drizzle
137	21-Jul-11	AAF1	13.3	87.7	-10.1	Al. Plate	Freezing Drizzle
139	21-Jul-11	AAF1	13.7	83.4	-10.1	Al. Plate	Freezing Drizzle
149	21-Jul-11	AAF1	24.6	57.8	-10.2	Al. Plate	Light Freezing Rain
151	21-Jul-11	AAF1	24.6	59.8	-10.2	Al. Plate	Light Freezing Rain
88	20-Jul-11	AAF2	12.2	72.7	-3.4	Al. Plate	Freezing Drizzle
102	20-Jul-11	AAF2	12.8	106.5	-6.2	Al. Plate	Light Freezing Rain
114	20-Jul-11	AAF2	25.4	61.3	-6.3	Al. Plate	Light Freezing Rain
116	20-Jul-11	AAF2	24.9	66.8	-6.2	Al. Plate	Light Freezing Rain
126	21-Jul-11	AAF2	5.2	114.3	-10.4	Al. Plate	Freezing Drizzle
128	21-Jul-11	AAF2	5.2	117.4	-10.4	Al. Plate	Freezing Drizzle
138	21-Jul-11	AAF2	13.0	92.7	-10.1	Al. Plate	Freezing Drizzle
140	21-Jul-11	AAF2	13.7	80.7	-10.1	Al. Plate	Freezing Drizzle
150	21-Jul-11	AAF2	24.4	54.1	-10.2	Al. Plate	Light Freezing Rain
152	21-Jul-11	AAF2	24.6	63.2	-10.2	Al. Plate	Light Freezing Rain

4. RESULTS AND DISCUSSION

The results of endurance time testing with Battelle AAF1 and AAF2 are presented in this section. To assess the performance of the fluid, the endurance times measured are compared to the Type IV generic holdover times.

4.1 Data

Figures 4.1 to 4.4 present the endurance time data collected with Battelle AAF1 and AAF2. There is one chart for each precipitation type / ambient temperature in which testing was conducted, as follows:

- Figure 4.1: Freezing Drizzle, -3°C
- Figure 4.2: Freezing Drizzle, -10°C
- Figure 4.3: Light Freezing Rain, -6°C
- Figure 4.4: Light Freezing Rain, -10°C

Each chart contains the Battelle AAF1 endurance times (represented with magenta triangles), Battelle AAF2 endurance times (represented with blue diamonds) and the current Type IV generic holdover times (represented by red squares).

4.2 Discussion

The data collected indicates the endurance times of both AAF1 and AAF2 are superior to the current Type IV generic holdover times in select freezing precipitation conditions.

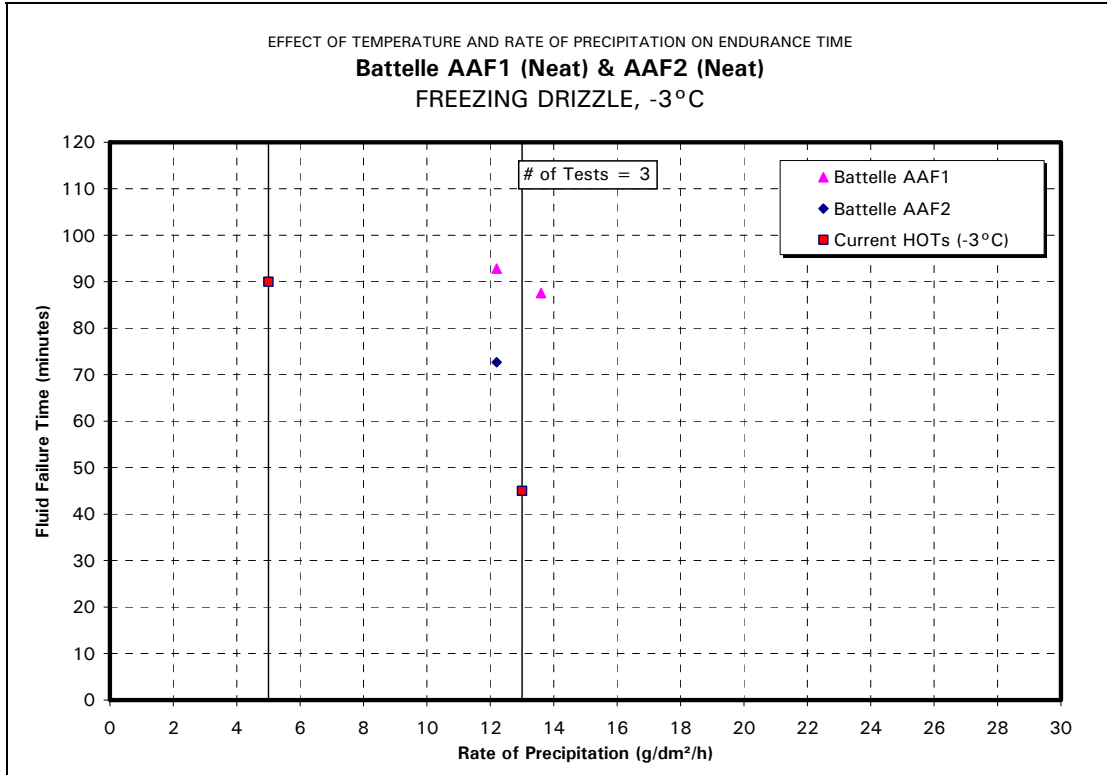

Figure 4.1: Freezing Drizzle, -3°C

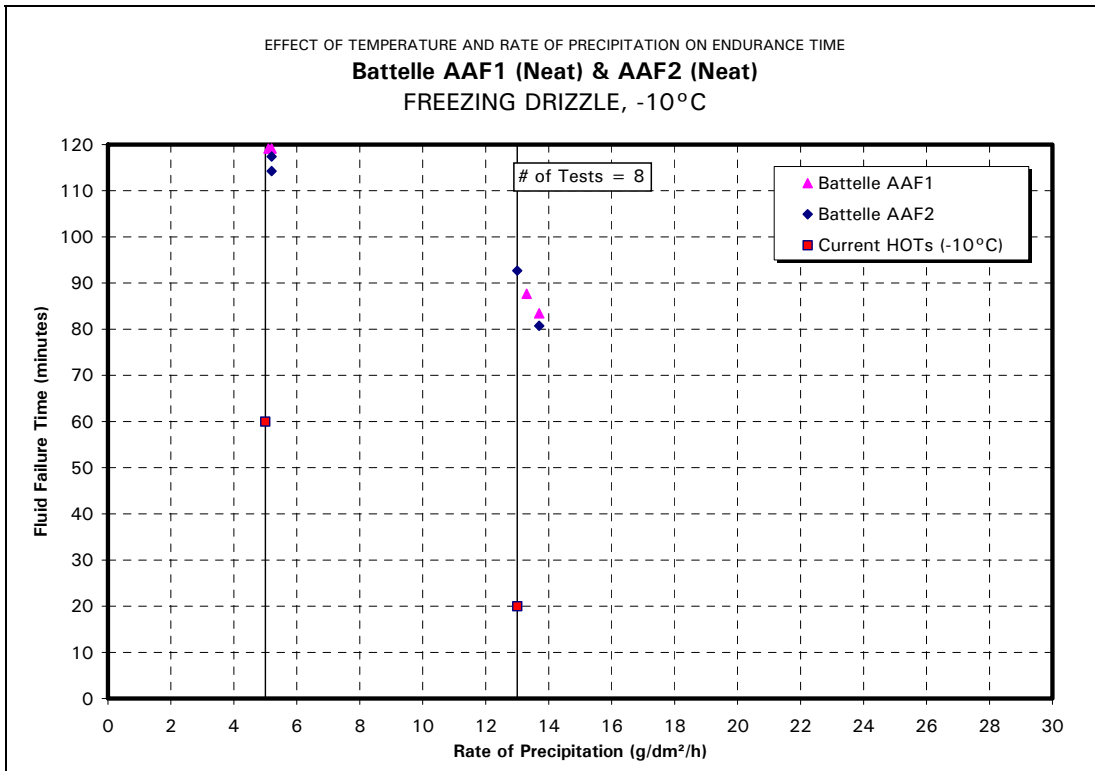

Figure 4.2: Freezing Drizzle, -10°C

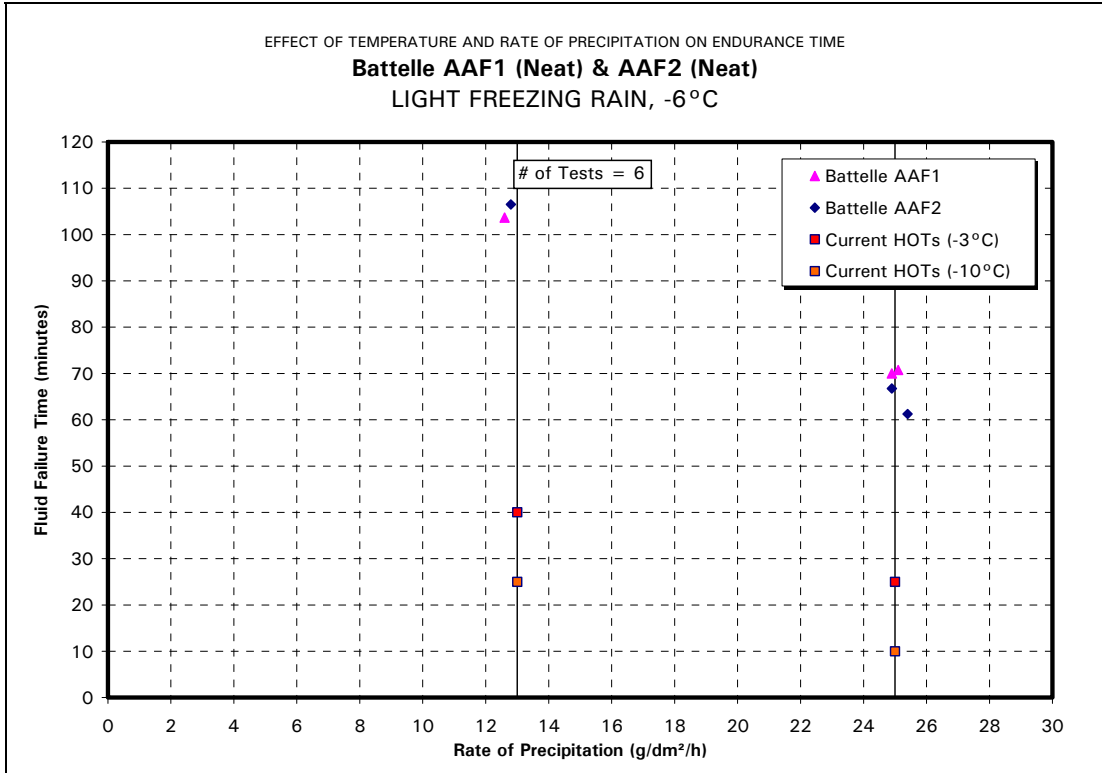

Figure 4.3: Light Freezing Rain, -6°C

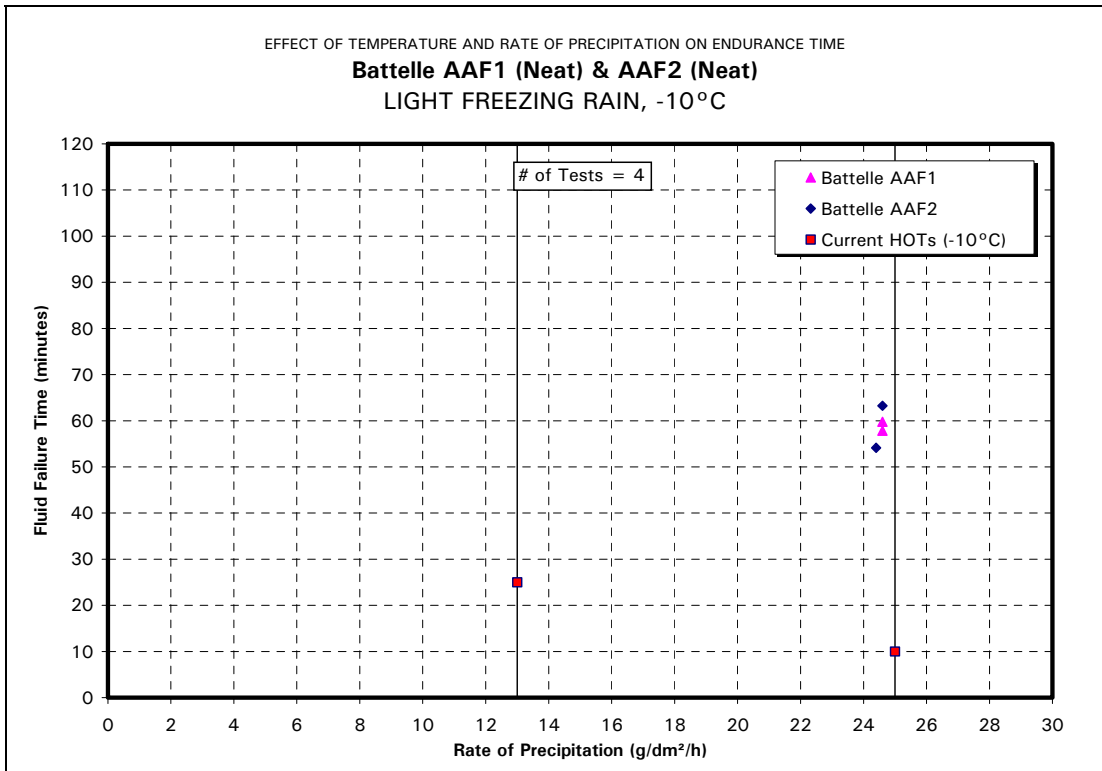
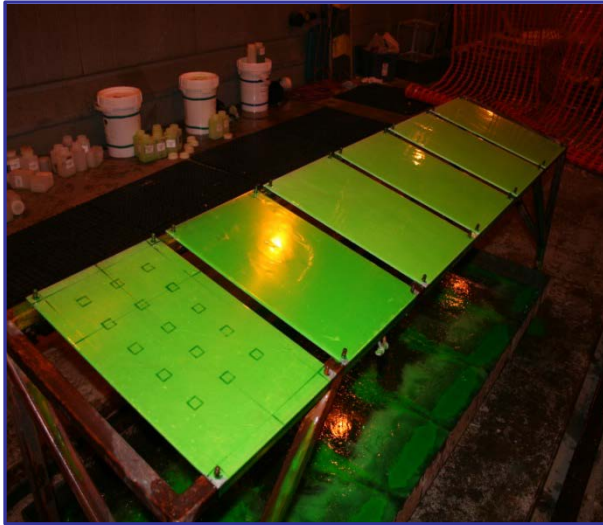

Figure 4.4: Light Freezing Rain, -10°C

APPENDIX E

Selected Results for Holdover Time (HOT) Testing of AAF3

WINTER 2011-12 AIRCRAFT DE/ANTI-ICING FLUID ENDURANCE TIME TESTING RESULTS



SAE G-12 HOT COMMITTEE MEETING
PRAGUE – MAY 8, 2012

Presented By: Stephanie Bendickson

Prepared and presented on behalf of:

TRANSPORTATION DEVELOPMENT CENTRE
TRANSPORT CANADA



AND

FEDERAL AVIATION ADMINISTRATION
WILLIAM J. HUGHES TECHNICAL CENTRE



PRECIPITATION RATE BOUNDARY CONDITIONS

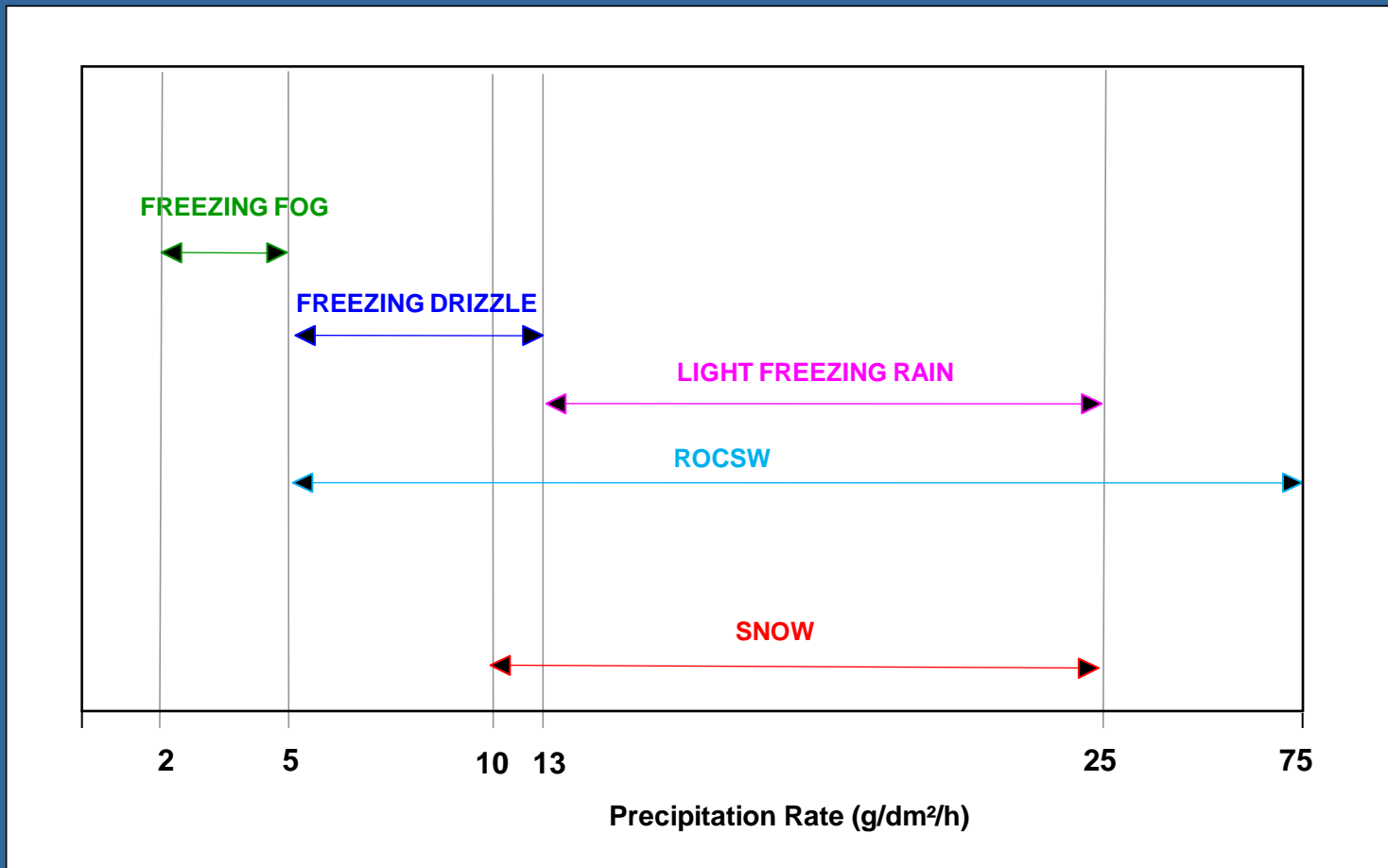

TESTS CONDUCTED – TYPE II

LNT P250	Freezing Fog	Natural Snow*	Freezing Drizzle	Light Freezing Rain	Cold-Soak Surface	Total
Neat	12	10	8	8	4	42
75/25	8	15	8	8	4	43
50/50	4	14	4	4	n/a	26
Total	24	39	20	20	8	111

*Limited data collected with Type II fluids in natural snow below -3°C

TYPE II 100/0

FREEZING FOG (-3°C AND ABOVE)

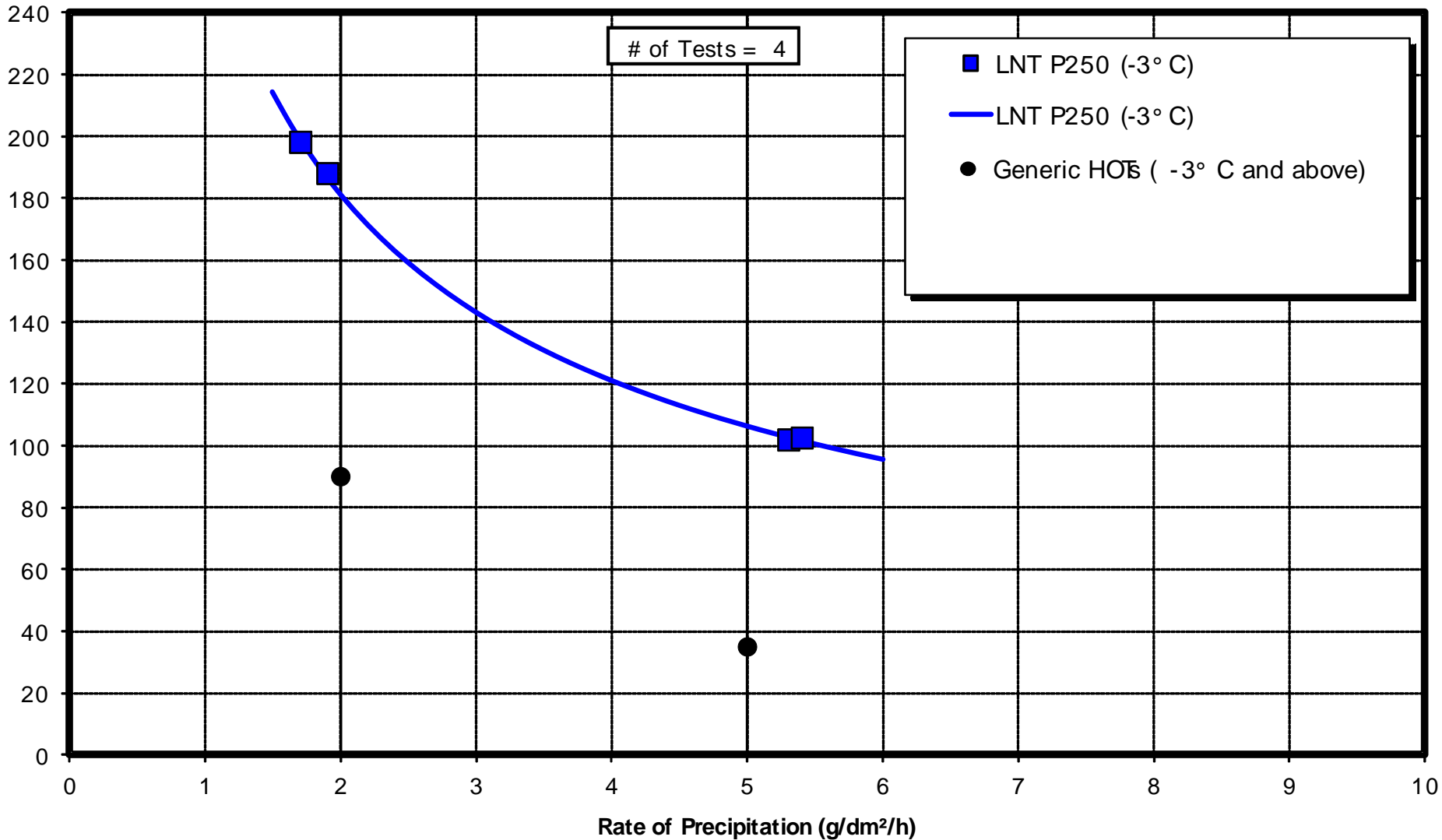

TYPE II 100/0

FREEZING FOG (BELOW -3 TO -14°C)

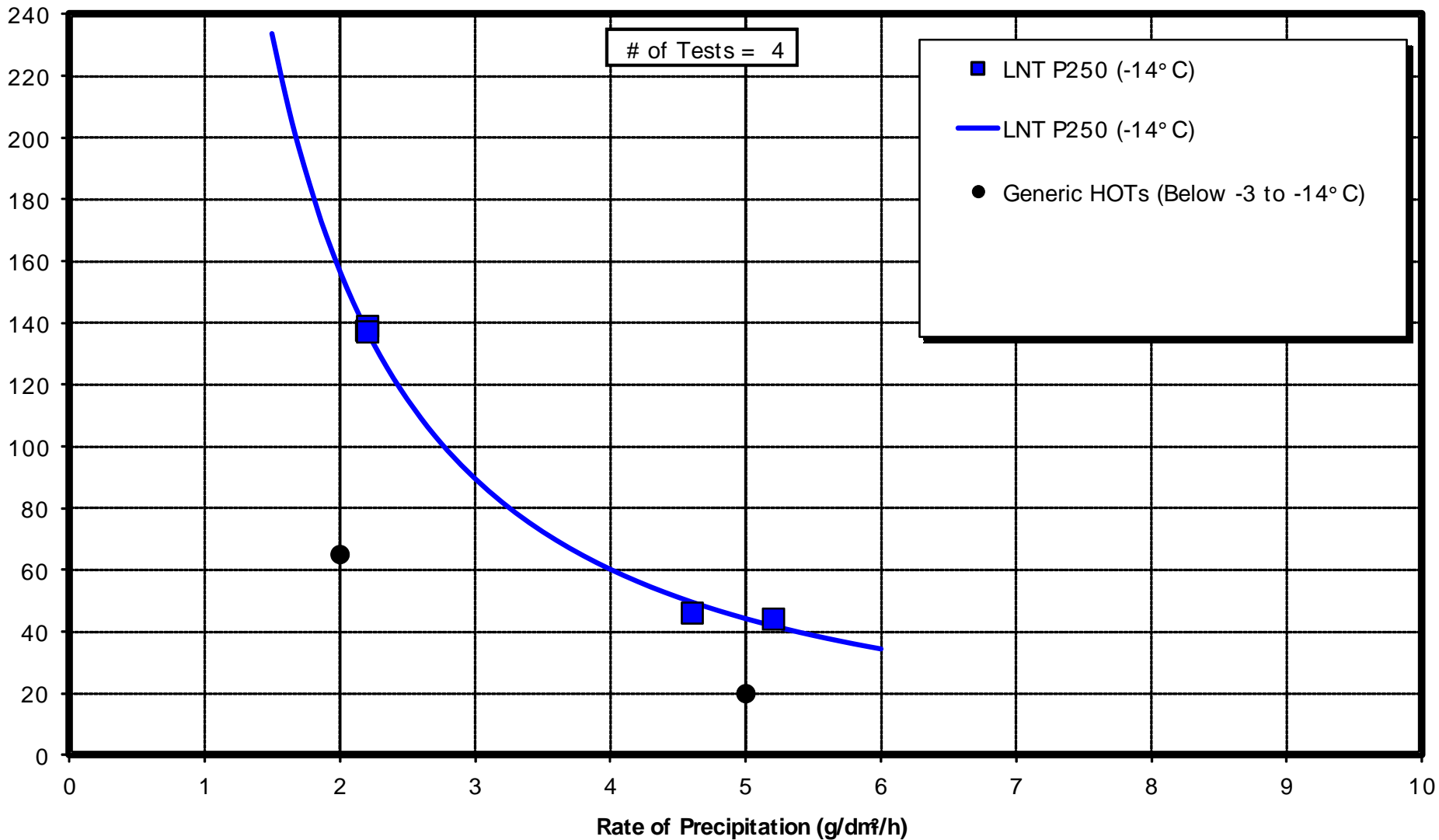

TYPE II 100/0

FREEZING DRIZZLE (-3°C AND ABOVE)

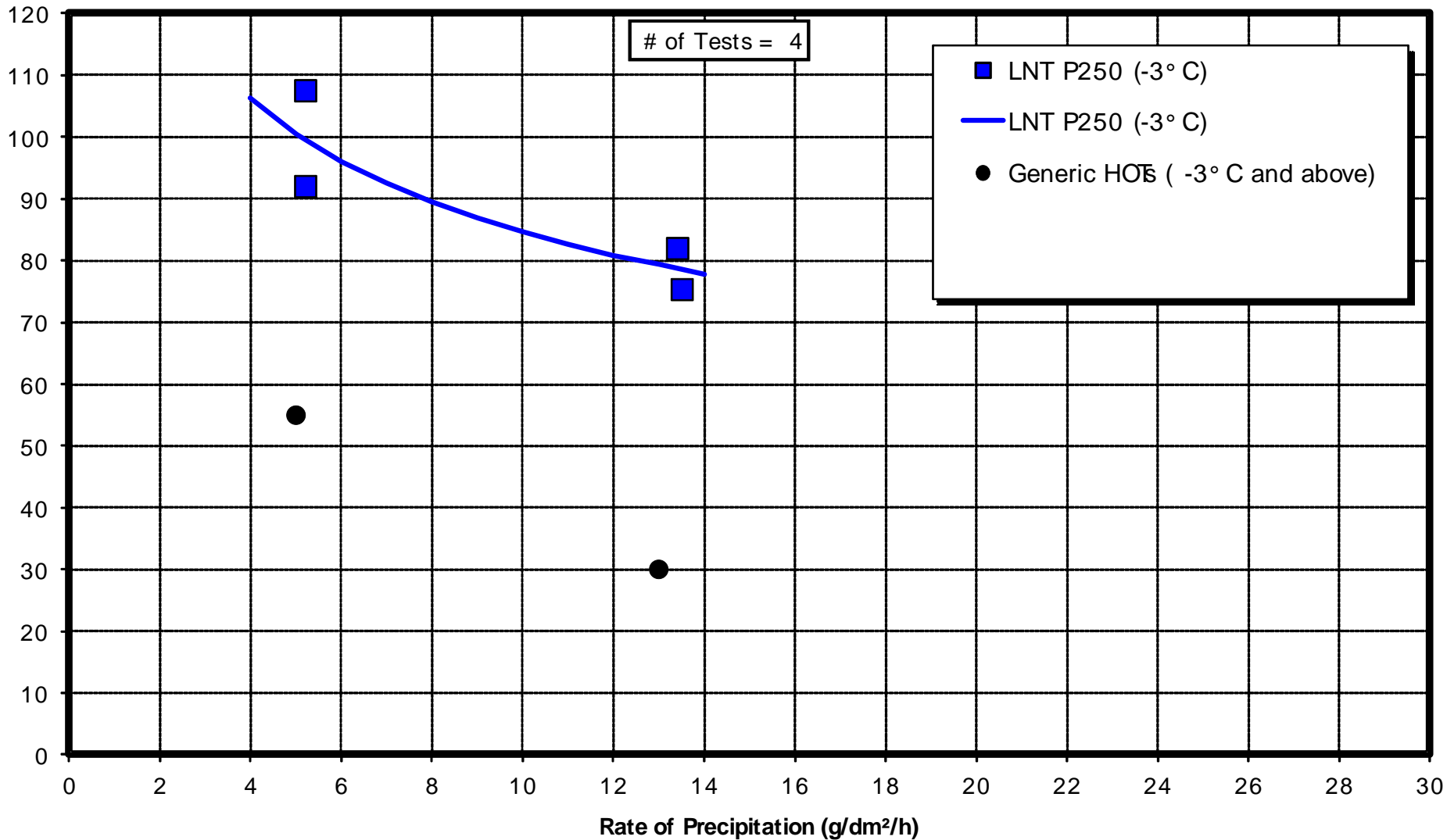

TYPE II 100/0

FREEZING DRIZZLE (BELOW -3 TO -10°C)

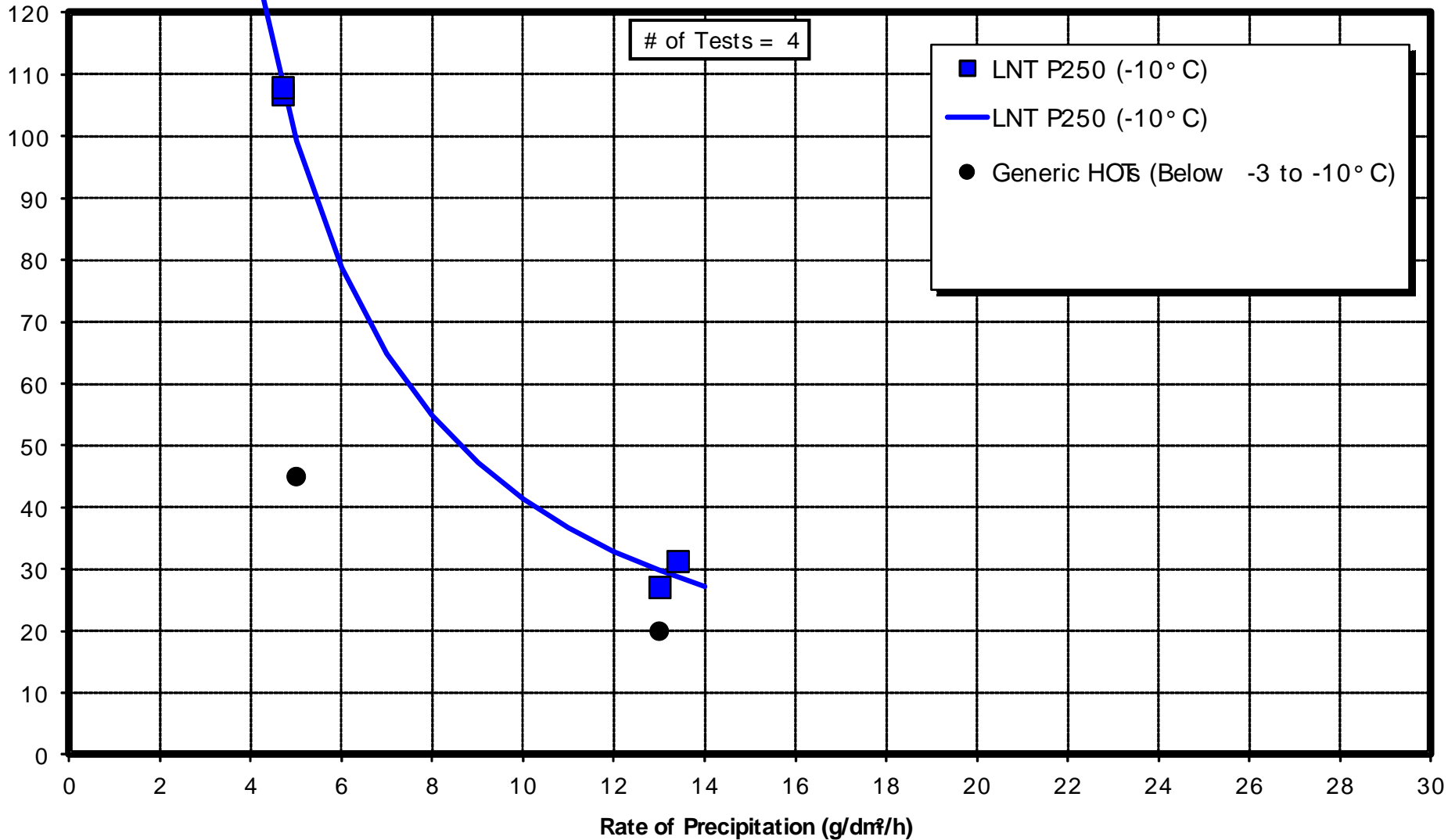

TYPE II 100/0

LIGHT FREEZING RAIN (-3°C AND ABOVE)

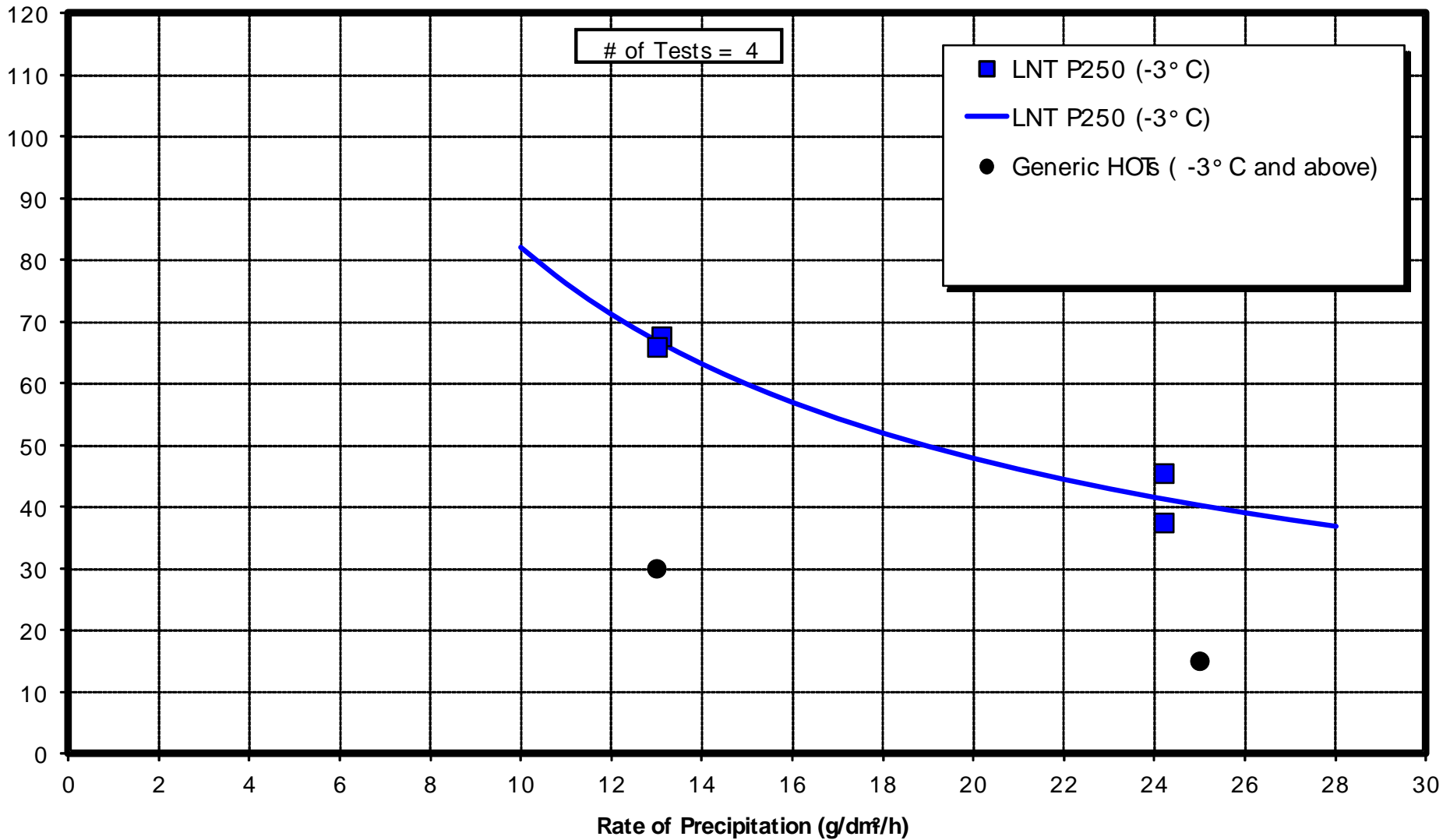

TYPE II 100/0

LIGHT FREEZING RAIN (BELOW -3 TO -10°C)

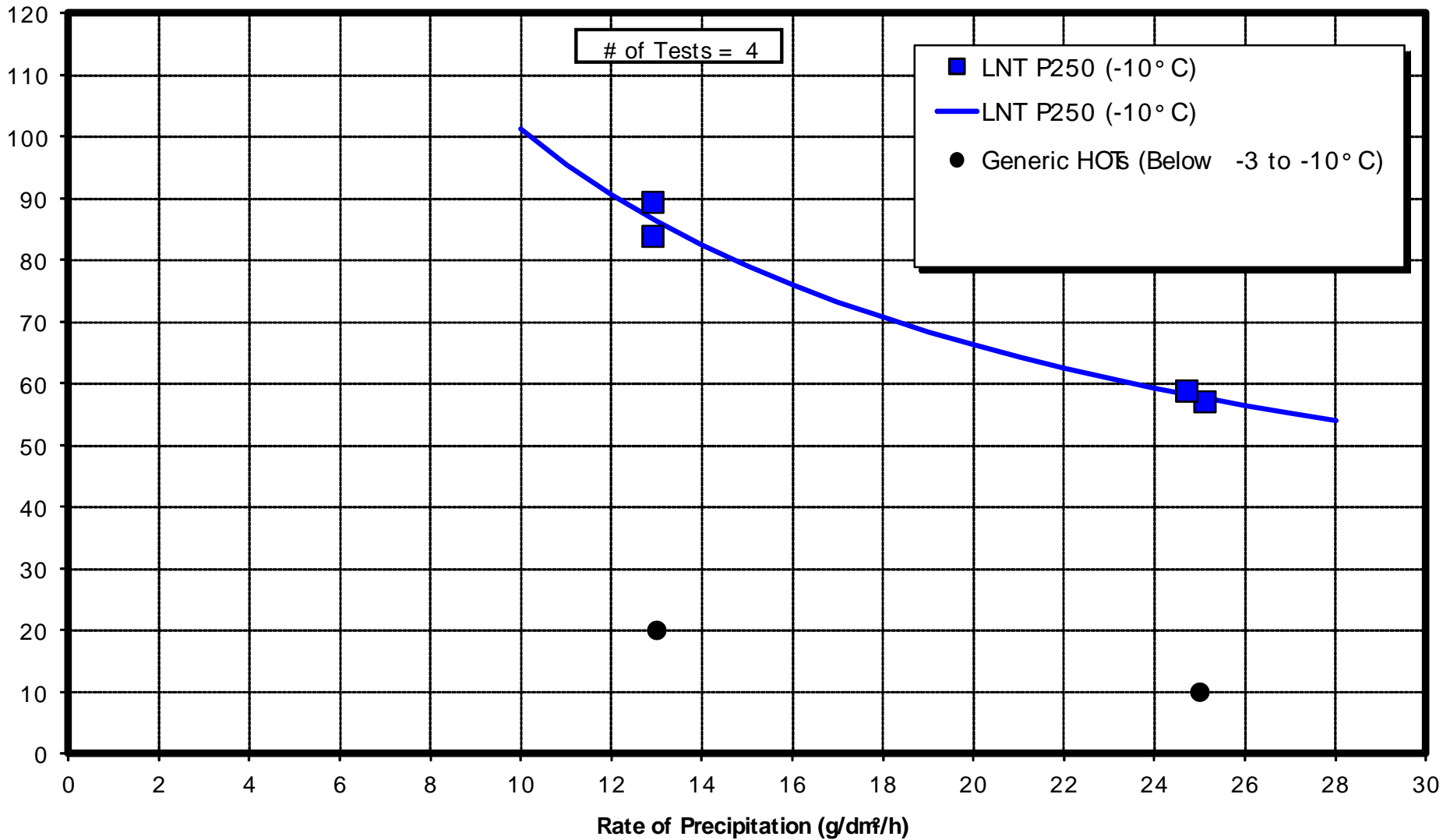

TYPE II 100/0

NATURAL SNOW (-3°C AND ABOVE)

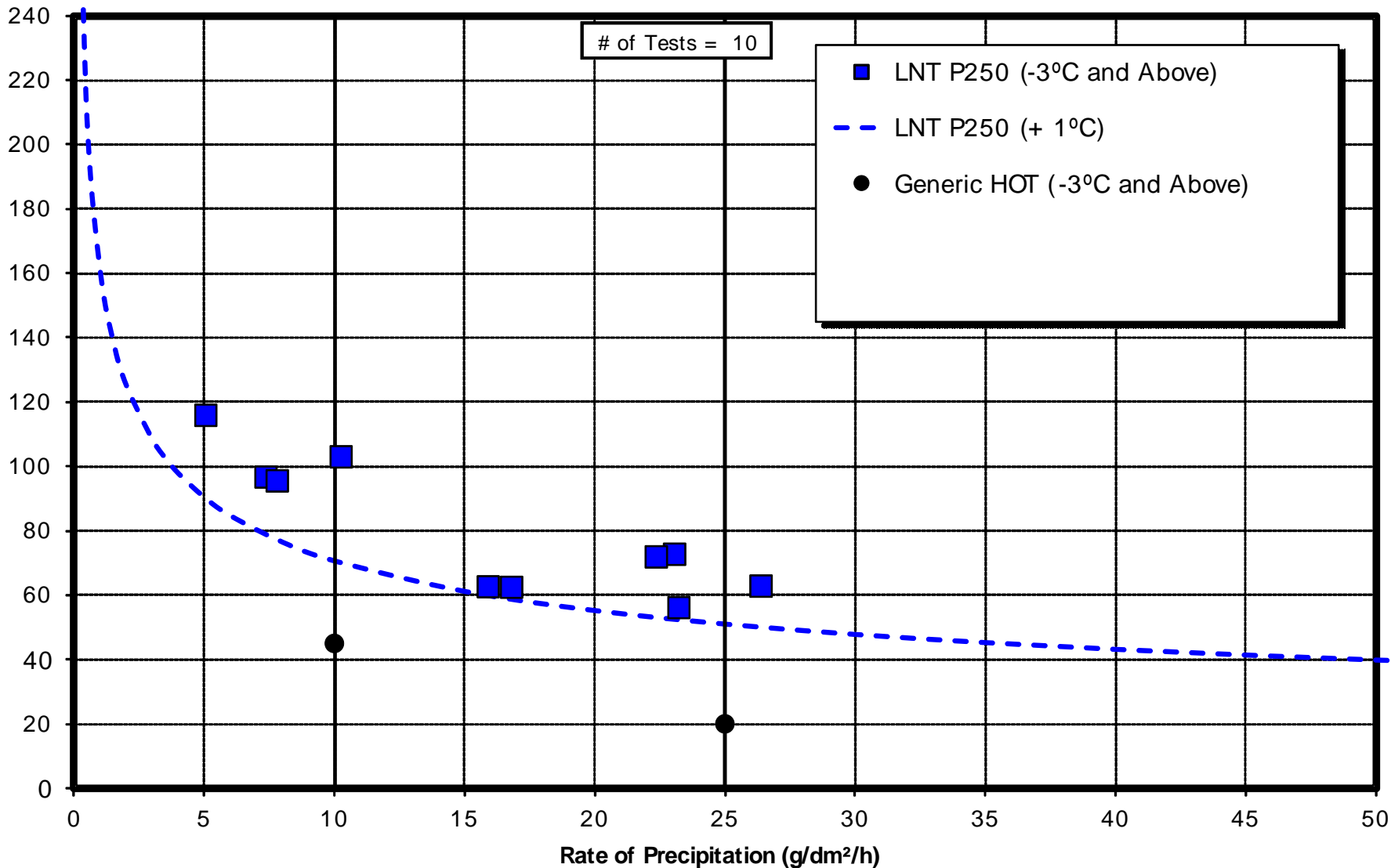

TYPE II 100/0

ARTIFICIAL SNOW (-14°C)

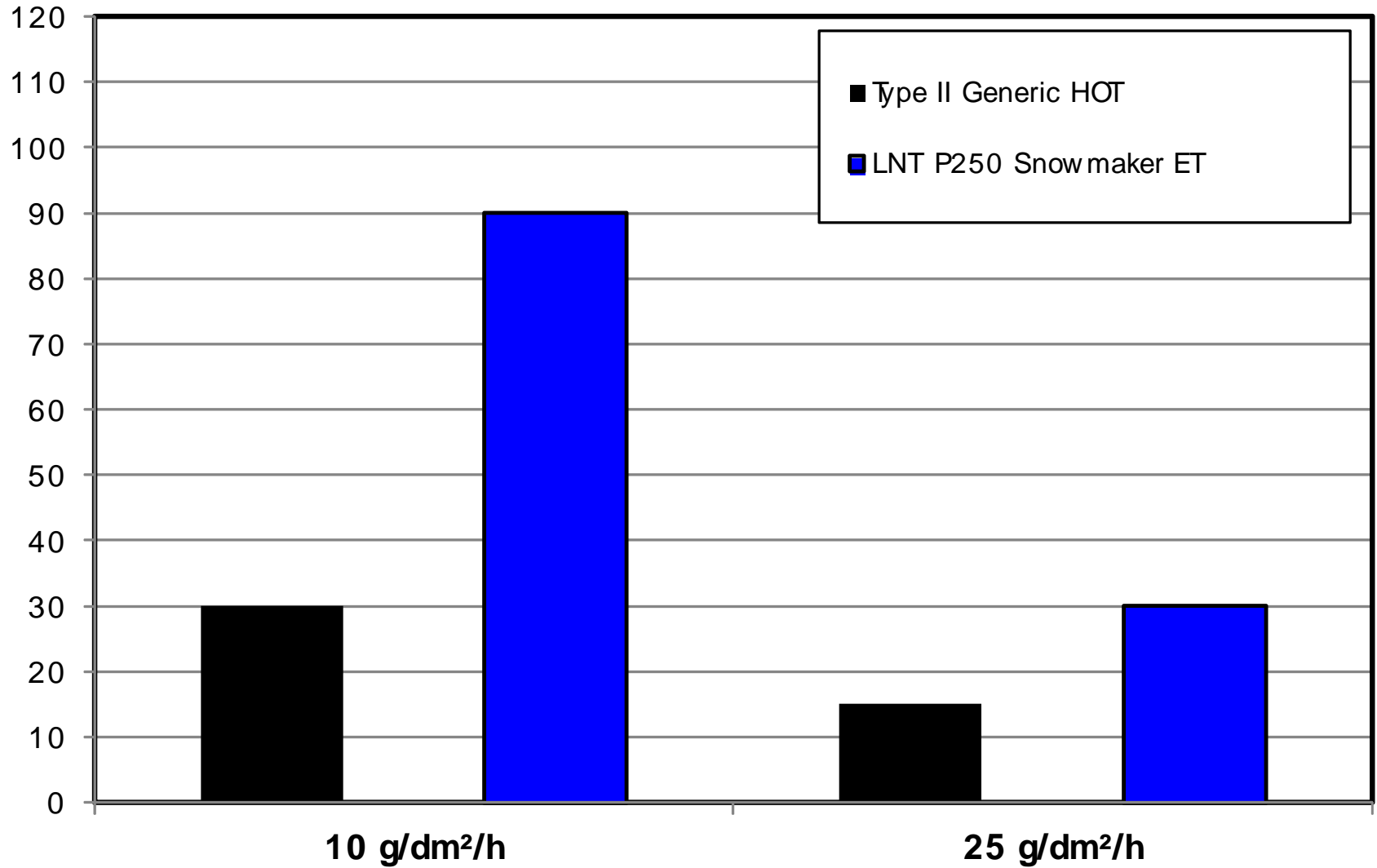

FLUID-SPECIFIC HOT TABLE

LNT P250

Outside Air Temperature ²		Type II Fluid Concentration Neat Fluid/Water (Volume %/Volume %)	Approximate Holdover Times Under Various Weather Conditions (hours:minutes)					
Degrees Celsius	Degrees Fahrenheit		Freezing Fog	Snow, Snow Grains or Snow Pellets ³	Freezing Drizzle ⁴	Light Freezing Rain	Rain on Cold Soaked Wing ⁵	Other ⁶
-3 and above	27 and above	100/0	1:45 – 3:00	0:50 – 1:10	1:20 – 1:40	0:40 – 1:05	0:20 – 1:30	CAUTION: No holdover time guidelines exist
		75/25	1:00 – 1:45	0:30 – 0:50	0:35 – 1:05	0:20 – 0:35	0:10 – 1:15	
		50/50	0:25 – 0:40	0:10 – 0:15	0:15 – 0:25	0:07 – 0:15		
below -3 to -14	below 27 to 7	100/0	0:45 – 2:35	0:15 – 0:30	0:30 – 1:40 ⁷	1:00 – 1:25 ⁷		
		75/25	0:25 – 1:20	0:10 – 0:20	0:25 – 1:15 ⁷	0:35 – 0:50 ⁷		
below -14 to TBD	below 7 to TBD	100/0	0:20 – 0:45	0:15 – 0:30				



APPENDIX F

AMS 1424 Certifications for EcoFlo 2 ADF

SMI, Inc.

12219 SW 131 Avenue
Miami, Florida 33186-6401 USA

Phone: (305) 971-7047
Fax: (305) 971-7048

Attn: Satya Chauhan Ph.D.
Battelle Memorial Institute
505 King Avenue
Columbus, OH 43201-2693

Date: 25-Jul-2011
SMI/REF: 1105-400_{RR}

Product: **ECOFLO 2 (Lot 52620-76)** (received 08-Jun-2011)

Dilution: Per specification Page 1 of 12

Partial testing in accordance with
AMS 1424J
Deicing/Anti-icing, Fluid, Aircraft SAE Type I
(FLUID CONCENTRATE)

3.1.1 Non-glycol Based Fluids (AMS 5886 alloy corrosion)	<u>Conforms</u>
3.1.2 Appearance	<u>Conforms</u>
3.1.3 Toxicity	<u>To be certified by manufacturer</u>
3.1.4 Environmental Information	
3.1.4.1 Biochemical Oxygen Demand (BOD)	<u>Informational</u>
3.1.4.2 Chemical Oxygen Demand (COD)	<u>Informational</u>
3.1.4.3 Biodegradability	<u>Informational</u>
3.1.4.4 Aquatic Toxicity	<u>Informational</u>
3.1.5 Trace Contaminants	<u>Informational</u>
3.2 <u>Properties</u>	
3.2.1 Flash Point	<u>Conforms</u>
3.2.2 Specific Gravity	<u>Informational</u>
3.2.3 pH	<u>Informational</u>
3.2.4 Refractive Index	<u>Informational</u>
3.2.5 Freezing Point	<u>Informational</u>
3.2.6 Surface Tension	<u>Informational</u>
3.2.7 Viscosity	<u>Informational</u>

Client:	Battelle Memorial Institute	Date:	25-Jul-2011
Product:	ECOFLO 2 (Lot 52620-76)	SMI/REF:	1105-400 _{RR}
Dilution:	Per specification		
AMS 1424J		Page 2 of 12	

3.3	<u>Fluid Stability</u>	
3.3.1	Storage Stability	<u>Not performed</u>
3.3.2	Thermal Stability (<i>WSET testing not performed</i>)	<u>Not performed</u>
3.3.3	Hard Water Stability (<i>WSET testing not performed</i>)	<u>Not performed</u>
3.3.4	Shear Stability	<u>Not performed</u>
3.3.5	Foam Stability	<u>Not performed</u>
3.4	<u>Effect on Aircraft Materials</u>	
3.4.1	Sandwich Corrosion	<u>Conforms</u>
3.4.2	Total Immersion Corrosion	<u>Conforms</u>
3.4.3	Low Embrittling Cadmium Plate	<u>Conforms</u>
3.4.4	Stress Corrosion Resistance	
	AMS 4911	<u>Conforms</u>
	AMS 4916	<u>Informational</u>
3.4.5	Hydrogen Embrittlement	<u>Conforms</u>
3.4.6	Effect on Transparent Plastics	<u>Conforms</u>
3.4.7	Effect on Painted Surfaces	<u>Conforms</u>
3.4.8	Effect on Unpainted Surfaces	<u>Conforms</u>
3.4.9	Runway Concrete Scaling Resistance	<u>Conforms</u>
3.5	<u>Performance Properties</u>	
3.5.1	Freezing Point (concentrates)	<u>Conforms</u>
3.5.1.1	Freezing Point (ready to use fluids)	<u>Not applicable</u>
3.5.2	Anti-icing Performance	<u>Not performed</u>
3.5.3	Aerodynamic Acceptance Test	<u>Not performed</u>

Respectfully submitted,

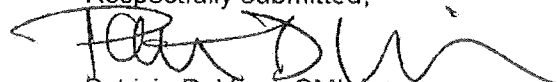

Patricia D. Viani, SMI, Inc.

QUALIFICATION TEST REPORT

**FP-11-16
LARGE TRANSPORT TYPE JET
AIRCRAFT AERODYNAMIC TESTING
OF THE CANDIDATE TYPE I FLUID**

**EcoFlo 2
lot # 52620-76**

Produced at Columbus, Ohio (USA)

for

**BATTELLE MEMORIAL INSTITUTE
505, King Avenue
Columbus, (Ohio) 43201-2693 U.S.A.**

by

**Arlene Beisswenger
Marc Mario Tremblay**



Laboratoire international
des matériaux antigivre

LIMA  AMIL

Anti-icing Materials
International Laboratory

July 2011

QUALIFICATION

This report presents results of high speed ramp aerodynamic acceptance tests, using Boundary Layer Displacement Thickness (BLDT) values, performed on samples of the candidate Type I fluid **BATTELLE MEMORIAL INSTITUTE EcoFlo 2 lot # 52620-76**, produced at **Columbus, Ohio (USA)**, evaluated diluted with ASTM D1193 TYPE IV water according to the latest revisions of the SAE AMS 1424J specification and AS5900B standard [1-3]. The tests were performed between 0°C and -32.7°C within a $\pm 2^\circ\text{C}$ range, using the flat plate set-up in the Luan Phan refrigerated wind tunnel at the Anti-icing Materials International Laboratory (AMIL) research laboratory. AMIL is independent of fluid manufacturers and was found qualified on September 11, 1997 (reconfirmed May 1, 2008) by the Performance Review Institute according to PRI document AC3001, "audit criteria for compliance to SAE AMS 1424 and AMS 1428".

On the basis of the acceptance criteria, the candidate Type I fluid BATTELLE MEMORIAL INSTITUTE EcoFlo 2 lot # 52620-76 qualifies according to AMS 1424J specification for use on large transport type jet aircraft in the following temperature ranges:

- above -32°C in the case of the 65/35 dilution,
- above -23.5°C in the case of the 50/50 dilution.

This fluid is qualified from 2011 July 25, for a two year period.



QUALIFICATION TEST REPORT

WH-11-16

**CLIMATIC CHAMBER EVALUATION OF THE
AIRCRAFT DEICING FLUID**

**EcoFlo 2
lot # 52620-76**

Produced at Columbus, Ohio (USA)

for

BATTELLE MEMORIAL INSTITUTE

505, King Avenue

Columbus, (Ohio) 43201-2693 U.S.A.

by

**Arlene Beisswenger
Marc Mario Tremblay**

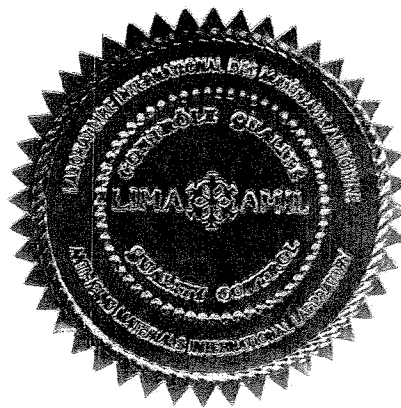

*Laboratoire international
des matériaux antigivre*

LIMA  AMIL

*Anti-icing Materials
International Laboratory*

July 2011

QUALIFICATION

This report presents the anti-icing endurance times pertaining to samples of the deicing fluid **BATTELLE MEMORIAL INSTITUTE EcoFlo 2 lot # 52620-76** produced at **Columbus, Ohio (USA)**, evaluated diluted with hard water, in Water Spray Endurance Tests (WSET) and High Humidity Endurance Tests (HHET) as per the latest revisions of the AMS 1424J specification and AS5901B standard [1, 2]. The tests were performed using the set-up in the climatic chamber at the Anti-icing Materials International Laboratory (AMIL) which is located at the Université du Québec à Chicoutimi (UQAC). AMIL is independent from fluid manufacturers. Fluids were at room temperature when they were applied to the plates. Fluid samples were sheared within two hours of the beginning of the test.

The required minimum anti-icing endurance time in WSET for a Type I fluid, concentrate or diluted, is 3 minutes. The required minimum anti-icing endurance time in HHET for a Type I fluid, concentrate or diluted, is 20 minutes.

The candidate fluid BATTELLE MEMORIAL INSTITUTE, EcoFlo 2 lot # 52620-76 anti-icing endurance time averages are as follows:

1. **EcoFlo 2, lot # 52620-76, 65/35 dilution**
 - 6 min 53 s \pm 27 s for WSET,
 - 36 min 13 s \pm 3 min 23 s for HHET.
2. **EcoFlo 2, lot # 52620-76, 50/50 dilution**
 - 4 min 56 s \pm 13 s for WSET,
 - 28 min 07 s \pm 4 min 05 s for HHET.

On the basis of the test data, the fluid **BATTELLE MEMORIAL INSTITUTE, EcoFlo 2 lot # 52620-76**, demonstrates acceptable anti-icing endurance time properties as required per SAE AMS 1424J specification with respect to a Type I fluid.

This fluid is qualified from 2011 July 25, for a two year period.



EVALUATION TEST REPORT

TS-11-42

THERMAL STABILITY TESTING

EcoFlo 2, lot # 52620-76

Produced at Columbus, Ohio (USA)

for

BATTELLE MEMORIAL INSTITUTE

505, King Avenue

Columbus, (Ohio) 43201-2693 U.S.A.

by

**Arlene Beisswenger
Marc Mario Tremblay**

Laboratoire international
des matériaux antigivre

LIMA  AMIL

Anti-icing Materials
International Laboratory

June 2011

THERMAL STABILITY EVALUATION

REPORT # TS-11-42

for SAE AMS 1424 Type I Deicing Fluid

Client : Battelle Memorial Institute
505, King Avenue
Columbus, (Ohio) 43201-2693 U.S.A.

Sample : EcoFlo 2, lot # 52620-76,
produced at Columbus, (Ohio) (see Table 1)

Reception Date : 2011-05-05

Procedure : This fluid was tested for "Thermal Stability" in accordance with AMS 1424J paragraph 3.3.2

Results : After the aging period

The candidate Type I fluid **EcoFlo 2, lot # 52620-76** showed no evidence of insoluble deposits.

After inverting the container four complete cycles (20°C)

The candidate Type I fluid **EcoFlo 2, lot # 52620-76** showed no evidence of insoluble deposits.

Furthermore, the sample had a pH difference of -0.3 units between the heat-aged fluid and the unaged reference fluid (see Table 2). The Water Spray Endurance Test was performed with this sample and the results are presented in Table 3.

This fluid was tested during May and June 2011.



Table 1 - Fluid Identification

Company Name	Product	Color	Manufacture Location	Manuf. Date	AMIL Label	Recep. Date
Battelle Memorial Institute	EcoFlo 2 lot # 52620-76 as received	Orange	Columbus, Ohio	11-02-05	I565	11-05-05

Table 2 - Thermal Stability Test Results (30 days at 80°C)

AMIL Label	Refractive index (20°C)			pH (50/50 dilution by volume with ASTM D1193 Water)				Requirement : $\Delta pH \leq 1.0$ <input checked="" type="checkbox"/> Pass <input type="checkbox"/> Fail	
	Unaged fluid	Aged fluid	ΔIR	Unaged fluid		Aged fluid			ΔpH
	Value	Value		T°C	Value	T°C	Value		
I565	1.4350	1.4350	0.0000	22	7.64	22	7.38	-0.26	

Comments	After aging / cooling period:	No evidence of insoluble deposits.
	After inverting of container (four complete cycles) 20°C	No evidence of insoluble deposits.

Table 3 - Water Spray Endurance Test

FLUID LABEL	TEST CODE	DATE y-m-d	ICE DATA		FLUID DATA		
			Plate	Intensity g/dm ² /h	Plate	FIE ¹ min:s	MIT ² min:s
I565	WS6187	11-06-15	P2	5.08 ± 0.06	P1	5:00	5:30
			P4	5.11 ± 0.02	P3	5:10	5:30
			P6	5.07 ± 0.08	P5	4:55	5:20

¹ FIE: First Ice Event: time for the first ice crystal to reach 25 mm in length.

² MIT: Mean Icing Time: time for the ice to reach a mean length of 25 mm.

EVALUATION TEST REPORT

HWST-11-42

HARD WATER STABILITY TESTING

EcoFlo 2, lot # 52620-76

Produced at Columbus, Ohio (USA)

for

BATTELLE MEMORIAL INSTITUTE

505, King Avenue

Columbus, (Ohio) 43201-2693 U.S.A.

by

Arlene Beisswenger

Marc Mario Tremblay

Laboratoire international
des matériaux antigivre

LIMA  **AMIL**

Anti-icing Materials
International Laboratory

June 2011

HARD WATER STABILITY TEST EVALUATION

REPORT # HWST-11-42

for SAE AMS 1424 Type I Deicing Fluid

Client : Battelle Memorial Institute
505, King Avenue
Columbus, (Ohio) 43201-2693 U.S.A.

Sample : EcoFlo 2, lot # 52620-76,
produced at Columbus, (Ohio) (see Table 1)

Reception Date : 2011-05-05

Procedure : This fluid was tested for "Hard Water Stability Test" in accordance
with AMS 1424J paragraph 3.3.3

Results : After the aging period

The candidate Type I fluid **EcoFlo 2, lot # 52620-76** showed no evidence
of insoluble deposits.

After inverting the container (20°C)

The candidate Type I fluid **EcoFlo 2, lot # 52620-76** showed no evidence
of insoluble deposits.

Furthermore, the sample had a pH difference of -0.2 units between the
heat-aged fluid and the unaged reference fluid (see **Table 2**). The Water
Spray Endurance Test was performed with this sample and the result is
presented in **Table 3**.

This fluid was tested during May and June 2011.

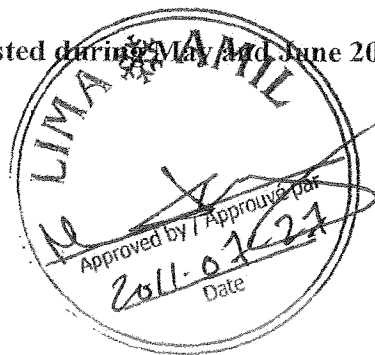

Table 1 - Fluid Identification

Company Name	Product	Color	Manufacture Location	Manuf. Date	AMIL Label	Recep. Date
Battelle Memorial Institute	EcoFlo 2 lot # 52620-76 50/50*	Orange	Columbus, Ohio	11-02-05	I567	11-05-05

* 50/50 Hard Water Dilution Fluid

Table 2 - Hard Water Stability Test Results (30 days at 95°C)

AMIL Label	Refractive index (20°C)			pH				Requirement : $\Delta pH \leq 0.5$ <input checked="" type="checkbox"/> Pass <input type="checkbox"/> Fail	
	Unaged fluid	Aged fluid	ΔIR	Unaged fluid		Aged fluid			ΔpH
	Value	Value		T°C	Value	T°C	Value		
I567	1.3871	1.3872	0.0001	20	7.44	20	7.28	-0.16	

Comments	After aging period	No evidence of insoluble deposits.
	After inverting of container (four complete cycles) 20°C	No evidence of insoluble deposits.

Table 3 - Water Spray Endurance Test

50/50 dilution (fluid aged 30 days at 95°C)

FLUID LABEL	TEST CODE	DATE y-m-d	ICE DATA		FLUID DATA		
			Plate	Intensity g/dm ² /h	Plate	FIE ¹ min:s	MIT ² min:s
I567	WS6188	11-06-15	P2	7.97 ± 0.06	P1	4:50	5:20
			P4	5.02 ± 0.09	P3	4:55	5:30
			P6	5.10 ± 0.11	P5	5:10	5:50

¹ FIE: First Ice Event: time for the first ice crystal to reach 25 mm in length.

² MIT: Mean Icing Time: time for the ice to reach a mean length of 25 mm.

This page intentionally left blank.

APPENDIX G

Holdover Time (HOT) Results for EcoFlo 2 ADF

Aircraft Ground Anti-Icing Fluid Endurance Time Test Results

**Octagon EcoFlo 2
(Type I)**

Prepared for

Battelle Memorial Institute

by



These tests were made possible with the guidance, participation and contribution of the Transportation Development Centre of Transport Canada and the Federal Aviation Administration.

June 2012
Version 2.0

Report No. B-O-E2 2011-12

Aircraft Ground Anti-Icing Fluid Endurance Time Test Results

Octagon EcoFlo 2 (Type I)

Prepared for

Battelle Memorial Institute

Prepared by: 
Stephanie Bendickson
Project Analyst

June 6, 2012
Date

Reviewed by: 
John D'Avirro
Program Manager, Eng.

June 6, 2012
Date



These tests were made possible with the guidance, participation and contribution of the Transportation Development Centre of Transport Canada and the Federal Aviation Administration.

June 2012
Version 2.0
Report No. B-O-E2 2011-12

FLUID IDENTIFICATION AND CHARACTERISTICS

Manufacturer: Battelle Memorial Institute

Fluid Test Name: E2

Fluid Commercial Name: Octagon EcoFlo 2

Fluid Type / Colour: Type I / Orange

Fluid Formulation: Non-glycol

Batch #: 52620-76

Date of Receipt: July 12, 2011

Brix (Measured): Concentrate: > 50°

LOUT (Stated) High Speed Test: -29°C (65/35 dilution)
Low Speed Test: not tested

WSET (from AMIL): 50/50: 4.9 minutes

SUMMARY

The primary objective of this project was to measure the endurance time performance of Octagon EcoFlo 2 over the entire range of conditions encompassed by the Type I Holdover Time (HOT) tables. This report contains the results of these measurements and was completed with the support of the fluid manufacturer, the Transport Development Centre (TDC) of Transport Canada and the Federal Aviation Administration (FAA).

The HOT test procedure consisted of pouring fluids onto clean aluminum and composite test surfaces inclined at 10°; the onset of failure was recorded as a function of time in natural snow, artificial snow and simulated freezing fog, freezing drizzle, light freezing rain, and rain on cold soaked wing. Endurance time tests were performed at the National Research Council Canada (NRC) Climatic Engineering Facility (CEF) located in Ottawa, Ontario and at the APS Aviation Inc. (APS) test facility located at the Pierre-Elliott-Trudeau International Airport in Montreal, Quebec.

Endurance time testing was conducted with this fluid in simulated freezing precipitation and artificial snow in July 2011. The endurance times measured with the fluid were similar or superior to Type I fluids tested in past years, and it was concluded that Octagon EcoFlo 2 could be used as a Type I fluid with the generic Type I HOT guidelines. Version 1.0 of this report documented the July 2011 testing and was submitted in August 2011.

In the winter of 2011-12, endurance time testing was conducted with Octagon EcoFlo 2 in natural snow to complete the testing and verify the indoor snow test results. The endurance times measured in natural snow were similar to Type I fluids tested in past years, confirming the indoor results. Version 2.0 of this report includes the entire set of endurance time test results, including those in natural snow.

3. DESCRIPTION OF DATA

This section provides a summary of the number of tests conducted. Breakdowns are provided for quantity of tests performed by precipitation type, fluid dilution, test surface and test temperature. A list of the tests conducted is provided in Table 3.2 at the end of this section.

3.1 Natural Snow Tests

Natural snow tests were conducted with this fluid in the winter of 2011-12 to verify the artificial snow test results. A total of 15 natural snow tests were conducted at the APS test site. The number of tests conducted is summarized below by temperature and test surface. For comparison purposes, simultaneous tests were conducted with a baseline Type I fluid.

Fluid Dilution	Test Surface	$\geq -3^{\circ}\text{C}$	-3 to -6°C	-6 to -10°C	$< -10^{\circ}\text{C}$
10°C Buffer	Aluminum	1	7	0	0
10°C Buffer	Composite	0	7	0	0

3.2 Artificial Snow Tests

Two tests were conducted with an artificial snowmaker at the APS test site in July 2011. Both tests were conducted on an aluminum surface at -3°C . For comparison purposes, the tests were repeated with a baseline Type I fluid.

Fluid Dilution	Test Surface	-3°C	-6°C	-10°C	-25°C
10°C Buffer	Aluminum	2	0	0	0

3.3 Freezing Fog Tests

Tests were conducted in freezing fog conditions at the NRC CEF in July 2011. The breakdown of tests conducted is summarized below by fluid dilution, test surface and test temperature.

Fluid Dilution	Test Surface	-3°C	-6°C	-10°C	-25°C
10°C Buffer	Aluminum	4	6	4	4
10°C Buffer	Composite	4	4	4	4

3.4 Freezing Drizzle Tests

Tests were conducted in freezing drizzle at the NRC CEF in July 2011. The breakdown of tests conducted is summarized below by fluid dilution, test surface and test temperature.

Fluid Dilution	Test Surface	-3°C	-6°C	-10°C
10°C Buffer	Aluminum	4	4	4
10°C Buffer	Composite	4	4	4

3.5 Light Freezing Rain Tests

Tests were conducted in light freezing rain conditions at the NRC CEF in July 2011. The breakdown of tests conducted is summarized below by fluid dilution, test surface and test temperature.

Fluid Dilution	Test Surface	-3°C	-6°C	-10°C
10°C Buffer	Aluminum	0*	4	4
10°C Buffer	Composite	0*	4	4

* Type I fluids are not tested in freezing rain at -3°C because the latent heat of freezing in calm test conditions produces artificially long endurance times.

3.6 Rain on Cold-Soaked Surface Tests

Tests were conducted in rain on cold-soaked surface conditions at the NRC CEF in July 2011. The breakdown of tests conducted is summarized below by fluid dilution, test surface and test temperature.

Fluid Dilution	Test Surface	+ 1°C
10°C Buffer	Aluminum	4
10°C Buffer	Composite	4

3.7 Fluid Thickness Tests

Fluid thickness tests were conducted at the NRC CEF in July 2011. The purpose of these tests was to measure the film thickness profile of Octagon EcoFlo 2

(mixed to a 10° buffer) under dry conditions. Two tests were performed at an ambient temperature of -3°C. The measurements are displayed in Table 3.1.

Table 3.1: Fluid Thickness Measurements

Measurement	Time After Application (mins)	Thickness (mm)	
		Run 1	Run 2
1	2	0.06	0.06
2	5	0.06	0.06
3	15	0.04	0.04
4	30	0.04	0.04

For each test, one litre of fluid was poured onto a flat plate mounted at 10° to the horizontal. Film thickness measurements were taken at the 15-cm (6") line at pre-selected time intervals over a 30-minute interval. The thickness after 30 minutes was 0.04 mm.

3.8 Summary of Tests Performed

A summary of the details of each test performed is provided in Table 3.2. The table includes the test number, date the test was conducted, fluid name and dilution, the precipitation type, the test surface, the air temperature, the measured precipitation rate and the measured endurance time.

Table 3.2: Summary of Tests Performed

Test No.	Date	Fluid Name	Fluid Dil.*	Precipitation Type	Test Surface	Test Temp. (°C)	Precip. Rate (g/dm ² /h)	Endurance Time (min)
1	19-Jul-11	Octagon EcoFlo 2	10°B	Freezing Fog	Aluminum	-3.2	2.3	19.3
2	19-Jul-11	Octagon EcoFlo 2	10°B	Freezing Fog	Aluminum	-3.1	1.9	20.1
3	19-Jul-11	Octagon EcoFlo 2	10°B	Freezing Fog	Composite	-3.2	2.1	18.8
4	19-Jul-11	Octagon EcoFlo 2	10°B	Freezing Fog	Composite	-3.1	1.7	20.5
5	19-Jul-11	Octagon EcoFlo 2	10°B	Freezing Fog	Aluminum	-3.3	5.5	12.7
6	19-Jul-11	Octagon EcoFlo 2	10°B	Freezing Fog	Aluminum	-3.3	5.0	12.8
7	19-Jul-11	Octagon EcoFlo 2	10°B	Freezing Fog	Composite	-3.3	5.1	11.5
8	19-Jul-11	Octagon EcoFlo 2	10°B	Freezing Fog	Composite	-3.3	4.9	9.7
9R	19-Jul-11	Octagon EcoFlo 2	10°B	Freezing Fog	Aluminum	-5.9	2.1	14.3
10	19-Jul-11	Octagon EcoFlo 2	10°B	Freezing Fog	Aluminum	-6.0	2.0	16.9
10R	19-Jul-11	Octagon EcoFlo 2	10°B	Freezing Fog	Aluminum	-5.9	1.9	15.8
11	19-Jul-11	Octagon EcoFlo 2	10°B	Freezing Fog	Composite	-6.1	1.8	13.4
12	19-Jul-11	Octagon EcoFlo 2	10°B	Freezing Fog	Composite	-6.1	2.1	12.9
13	19-Jul-11	Octagon EcoFlo 2	10°B	Freezing Fog	Aluminum	-5.9	4.7	7.9
13R	19-Jul-11	Octagon EcoFlo 2	10°B	Freezing Fog	Aluminum	-6.1	4.7	9.7
14	19-Jul-11	Octagon EcoFlo 2	10°B	Freezing Fog	Aluminum	-5.9	4.9	9.7
15	19-Jul-11	Octagon EcoFlo 2	10°B	Freezing Fog	Composite	-5.9	4.7	7.7
16	19-Jul-11	Octagon EcoFlo 2	10°B	Freezing Fog	Composite	-5.9	4.7	8.5
17	19-Jul-11	Octagon EcoFlo 2	10°B	Freezing Fog	Aluminum	-9.9	1.9	13.1
18R	19-Jul-11	Octagon EcoFlo 2	10°B	Freezing Fog	Aluminum	-10.2	2.2	11.7
19	19-Jul-11	Octagon EcoFlo 2	10°B	Freezing Fog	Composite	-9.9	2.2	10.5
20	19-Jul-11	Octagon EcoFlo 2	10°B	Freezing Fog	Composite	-9.9	1.8	10.6
21	19-Jul-11	Octagon EcoFlo 2	10°B	Freezing Fog	Aluminum	-9.8	5.3	8.7
22	19-Jul-11	Octagon EcoFlo 2	10°B	Freezing Fog	Aluminum	-9.8	4.9	9.3
23	19-Jul-11	Octagon EcoFlo 2	10°B	Freezing Fog	Composite	-9.8	5.0	7.3
24	19-Jul-11	Octagon EcoFlo 2	10°B	Freezing Fog	Composite	-9.8	4.6	7.0
25	19-Jul-11	Octagon EcoFlo 2	10°B	Freezing Fog	Aluminum	-25.0	1.9	12.7
26	19-Jul-11	Octagon EcoFlo 2	10°B	Freezing Fog	Aluminum	-25.0	1.7	13.6
27	19-Jul-11	Octagon EcoFlo 2	10°B	Freezing Fog	Composite	-24.9	1.9	11.7
28	19-Jul-11	Octagon EcoFlo 2	10°B	Freezing Fog	Composite	-25.0	1.8	12.1
29	19-Jul-11	Octagon EcoFlo 2	10°B	Freezing Fog	Aluminum	-24.6	5.0	5.2
30	19-Jul-11	Octagon EcoFlo 2	10°B	Freezing Fog	Aluminum	-24.6	5.1	5.6
31	19-Jul-11	Octagon EcoFlo 2	10°B	Freezing Fog	Composite	-24.6	4.9	4.3
32	19-Jul-11	Octagon EcoFlo 2	10°B	Freezing Fog	Composite	-24.6	4.6	4.5
33	20-Jul-11	Octagon EcoFlo 2	10°B	Light Freezing Rain	Aluminum	-6.5	13.5	8.1
34	20-Jul-11	Octagon EcoFlo 2	10°B	Light Freezing Rain	Aluminum	-6.5	13.4	7.8
35	20-Jul-11	Octagon EcoFlo 2	10°B	Light Freezing Rain	Composite	-6.4	13.2	7.3
36	20-Jul-11	Octagon EcoFlo 2	10°B	Light Freezing Rain	Composite	-6.2	13.5	7.3
37	20-Jul-11	Octagon EcoFlo 2	10°B	Light Freezing Rain	Aluminum	-5.9	25.4	9.1
38	20-Jul-11	Octagon EcoFlo 2	10°B	Light Freezing Rain	Aluminum	-6.2	25.1	9.0
39	20-Jul-11	Octagon EcoFlo 2	10°B	Light Freezing Rain	Composite	-6.3	24.9	7.1
40	20-Jul-11	Octagon EcoFlo 2	10°B	Light Freezing Rain	Composite	-6.0	24.7	7.3

* 10°B = Fluid diluted to a freeze point 10°C below test temperature

3. DESCRIPTION OF DATA

Table 3.2 (cont'd): Summary of Tests Performed

Test No.	Date	Fluid Name	Fluid Dil.*	Precipitation Type	Test Surface	Test Temp. (°C)	Precip. Rate (g/dm ² /h)	Endurance Time (min)
41	21-Jul-11	Octagon EcoFlo 2	10°B	Light Freezing Rain	Aluminum	-9.4	12.5	5.2
42	21-Jul-11	Octagon EcoFlo 2	10°B	Light Freezing Rain	Aluminum	-10.2	12.8	5.7
43	21-Jul-11	Octagon EcoFlo 2	10°B	Light Freezing Rain	Composite	-9.4	12.8	5.0
44	21-Jul-11	Octagon EcoFlo 2	10°B	Light Freezing Rain	Composite	-10.0	12.5	5.8
45	21-Jul-11	Octagon EcoFlo 2	10°B	Light Freezing Rain	Aluminum	-10.2	24.5	5.5
46	21-Jul-11	Octagon EcoFlo 2	10°B	Light Freezing Rain	Aluminum	-10.1	25.1	4.5
47	21-Jul-11	Octagon EcoFlo 2	10°B	Light Freezing Rain	Composite	-10.0	24.2	4.8
48	21-Jul-11	Octagon EcoFlo 2	10°B	Light Freezing Rain	Composite	-10.2	24.6	5.3
49	20-Jul-11	Octagon EcoFlo 2	10°B	Freezing Drizzle	Aluminum	-3.0	4.9	14.1
50	20-Jul-11	Octagon EcoFlo 2	10°B	Freezing Drizzle	Aluminum	-3.0	4.7	15.0
51	20-Jul-11	Octagon EcoFlo 2	10°B	Freezing Drizzle	Composite	-3.0	4.8	16.7
52	20-Jul-11	Octagon EcoFlo 2	10°B	Freezing Drizzle	Composite	-3.0	4.8	15.5
53	20-Jul-11	Octagon EcoFlo 2	10°B	Freezing Drizzle	Aluminum	-3.4	12.8	11.7
54	20-Jul-11	Octagon EcoFlo 2	10°B	Freezing Drizzle	Aluminum	-3.4	12.7	12.8
55	20-Jul-11	Octagon EcoFlo 2	10°B	Freezing Drizzle	Composite	-3.4	12.7	10.3
56	20-Jul-11	Octagon EcoFlo 2	10°B	Freezing Drizzle	Composite	-3.4	12.8	11.8
57	20-Jul-11	Octagon EcoFlo 2	10°B	Freezing Drizzle	Aluminum	-6.5	5.1	12.4
58	20-Jul-11	Octagon EcoFlo 2	10°B	Freezing Drizzle	Aluminum	-6.5	4.9	11.6
59	20-Jul-11	Octagon EcoFlo 2	10°B	Freezing Drizzle	Composite	-6.5	4.9	11.4
60	20-Jul-11	Octagon EcoFlo 2	10°B	Freezing Drizzle	Composite	-6.5	4.8	10.9
61	20-Jul-11	Octagon EcoFlo 2	10°B	Freezing Drizzle	Aluminum	-6.3	13.1	5.9
62	20-Jul-11	Octagon EcoFlo 2	10°B	Freezing Drizzle	Aluminum	-6.2	12.9	6.9
63	20-Jul-11	Octagon EcoFlo 2	10°B	Freezing Drizzle	Composite	-6.2	12.7	7.3
64	20-Jul-11	Octagon EcoFlo 2	10°B	Freezing Drizzle	Composite	-6.2	12.9	6.8
65	21-Jul-11	Octagon EcoFlo 2	10°B	Freezing Drizzle	Aluminum	-10.0	5.1	8.5
66	21-Jul-11	Octagon EcoFlo 2	10°B	Freezing Drizzle	Aluminum	-10.1	5.5	9.1
67	21-Jul-11	Octagon EcoFlo 2	10°B	Freezing Drizzle	Composite	-10.0	5.2	8.8
68	21-Jul-11	Octagon EcoFlo 2	10°B	Freezing Drizzle	Composite	-10.3	4.8	8.8
69	21-Jul-11	Octagon EcoFlo 2	10°B	Freezing Drizzle	Aluminum	-9.0	13.7	5.7
70	21-Jul-11	Octagon EcoFlo 2	10°B	Freezing Drizzle	Aluminum	-9.0	13.0	5.8
71	21-Jul-11	Octagon EcoFlo 2	10°B	Freezing Drizzle	Composite	-9.0	13.3	6.4
72	21-Jul-11	Octagon EcoFlo 2	10°B	Freezing Drizzle	Composite	-9.0	12.7	4.6
73	21-Jul-11	Octagon EcoFlo 2	10°B	Cold Soak Box	Aluminum	1.6	5.1	5.6
74R	21-Jul-11	Octagon EcoFlo 2	10°B	Cold Soak Box	Aluminum	0.6	4.8	6.3
75	21-Jul-11	Octagon EcoFlo 2	10°B	Cold Soak Box	Composite	1.5	4.9	6.4
76	21-Jul-11	Octagon EcoFlo 2	10°B	Cold Soak Box	Composite	0.9	5.2	7.0
77	21-Jul-11	Octagon EcoFlo 2	10°B	Cold Soak Box	Aluminum	1.1	74.7	1.6
78	21-Jul-11	Octagon EcoFlo 2	10°B	Cold Soak Box	Aluminum	1.2	76.8	1.6
79	21-Jul-11	Octagon EcoFlo 2	10°B	Cold Soak Box	Composite	1.2	75.6	1.8
80	21-Jul-11	Octagon EcoFlo 2	10°B	Cold Soak Box	Composite	1.2	75.6	2.4
S1	26-Jul-11	Octagon EcoFlo 2	10°B	Artificial Snow	Aluminum	-3.0	10.0	10.8
S2	26-Jul-11	Octagon EcoFlo 2	10°B	Artificial Snow	Aluminum	-3.0	25.0	5.5

* 10°B = Fluid diluted to a freeze point 10°C below test temperature

Table 3.2 (cont'd): Summary of Tests Performed

Test No.	Date	Fluid Name	Fluid Dil.*	Precipitation Type	Test Surface	Test Temp. (°C)	Precip. Rate (g/dm ² /h)	Endurance Time (min)
7	17-Jan-12	Octagon EcoFlo 2	10°B	Natural Snow	Aluminum Box	-4.3	11.8	7.4
10	17-Jan-12	Octagon EcoFlo 2	10°B	Natural Snow	Composite Box	-4.3	11.8	5.7
13	17-Jan-12	Octagon EcoFlo 2	10°B	Natural Snow	Aluminum Box	-3.7	10.5	7.7
16	17-Jan-12	Octagon EcoFlo 2	10°B	Natural Snow	Composite Box	-3.7	10.5	6.3
19	17-Jan-12	Octagon EcoFlo 2	10°B	Natural Snow	Aluminum Box	-3.6	19.6	5.6
22	17-Jan-12	Octagon EcoFlo 2	10°B	Natural Snow	Composite Box	-3.6	19.8	3.8
25	17-Jan-12	Octagon EcoFlo 2	10°B	Natural Snow	Aluminum Box	-3.5	6.2	11.5
28	17-Jan-12	Octagon EcoFlo 2	10°B	Natural Snow	Composite Box	-3.5	6.2	9.4
31	26-Jan-12	Octagon EcoFlo 2	10°B	Natural Snow	Aluminum Box	-5.3	7.1	11.4
34	26-Jan-12	Octagon EcoFlo 2	10°B	Natural Snow	Composite Box	-5.3	7.2	6.9
37	26-Jan-12	Octagon EcoFlo 2	10°B	Natural Snow	Aluminum Box	-5.8	6.6	11.9
40	26-Jan-12	Octagon EcoFlo 2	10°B	Natural Snow	Composite Box	-5.8	6.6	6.5
43	26-Jan-12	Octagon EcoFlo 2	10°B	Natural Snow	Aluminum Box	-5.8	5.7	12.3
46	26-Jan-12	Octagon EcoFlo 2	10°B	Natural Snow	Composite Box	-5.7	5.7	7.6
123	3-Mar-12	Octagon EcoFlo 2	10°B	Natural Snow	Aluminum Box	-0.3	23.0	11.6

* 10°B = Fluid diluted to a freeze point 10°C below test temperature

4. RESULTS AND DISCUSSION

The Octagon EcoFlo 2 endurance time test results with are presented in this section. To assess the performance of the fluid, the endurance time results are compared to historic Type I fluid endurance times.

4.1 Data

Figures 4.1 to 4.20 show the results of testing in simulated freezing precipitation. There is one chart for each freezing precipitation cell in the Type I generic holdover time tables, with the exception of the “-3°C and above” light freezing rain cells (see note in Subsection 2.5). Each chart contains the Octagon EcoFlo 2 endurance times (represented with solid diamonds), the endurance times of other Type I fluids (represented with hollow diamonds) and the current Type I generic holdover times (represented by solid squares).

Figures 4.21 to 4.23 show the results of testing in natural snow. There is one chart for each snow cell in the Type I generic holdover time tables under which testing was conducted. The charts contain the same information as the freezing precipitation charts.

Figure 4.21 shows the results of testing in artificial snow. The chart shows the endurance times of Octagon EcoFlo 2 along with the endurance times of the Type I reference fluid that was tested immediately following Octagon EcoFlo 2.

4.2 Discussion

The data collected shows the endurance times Octagon EcoFlo 2 are similar or superior to the endurance times of Type I fluids tested in past years and to the current Type I generic holdover times. These results indicate this non-glycol based fluid performs similarly to glycol based Type I fluids from an endurance time perspective and therefore can be used with the generic Type I HOT guidelines.

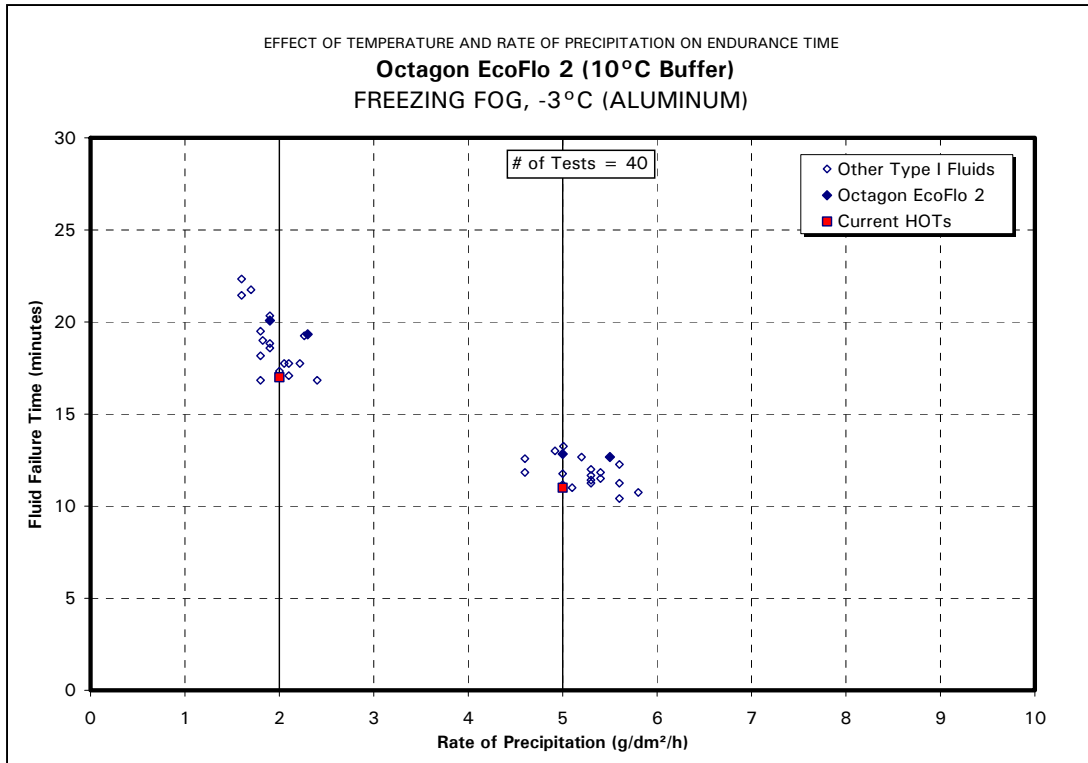

Figure 4.1: Freezing Fog, -3°C and Above, Aluminum Surface

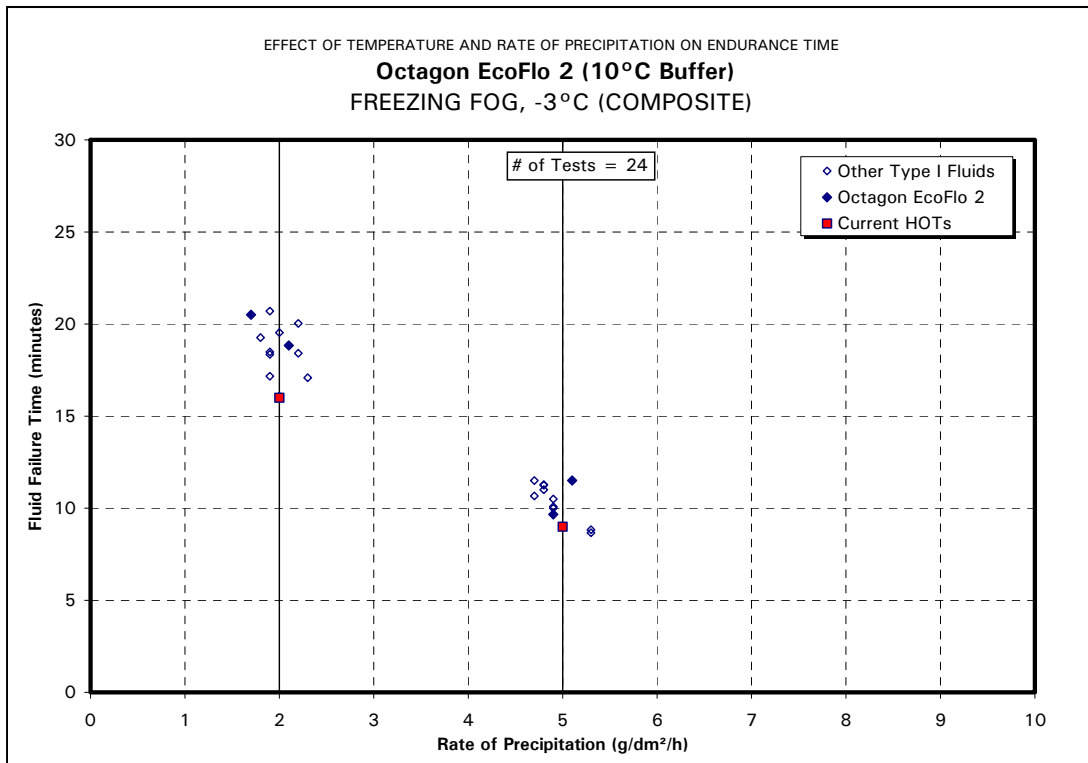

Figure 4.2: Freezing Fog, -3°C and Above, Composite Surface

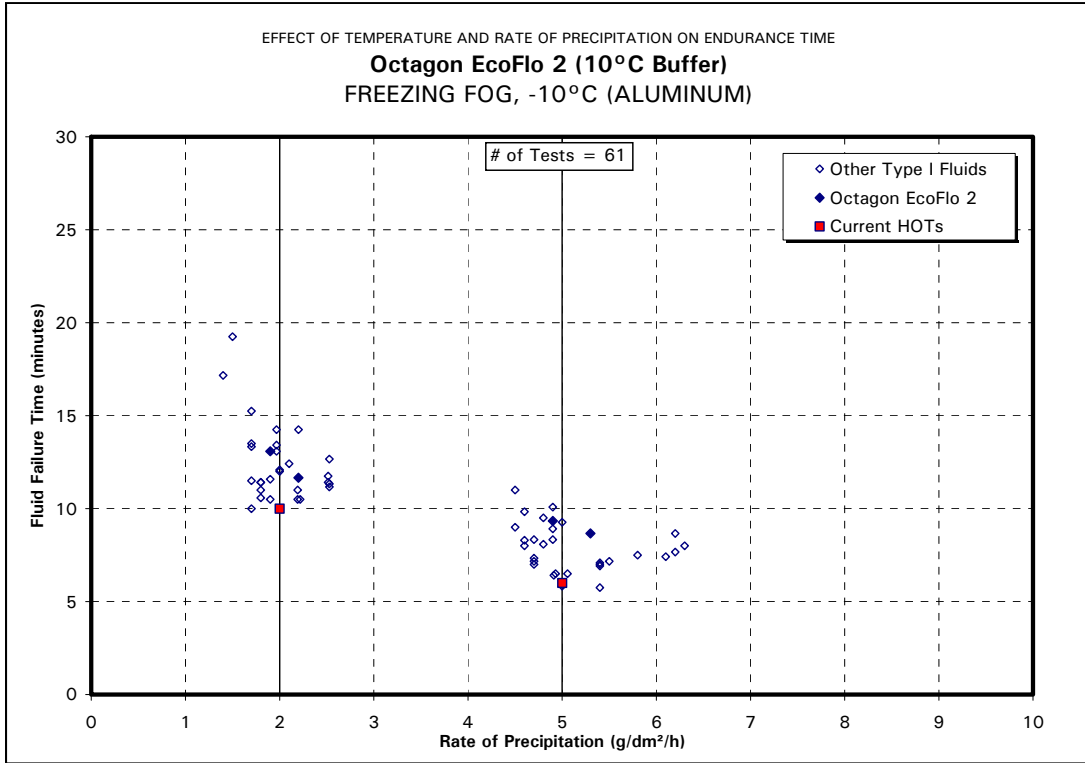

Figure 4.5: Freezing Fog, Below -6 to -10°C, Aluminum Surface

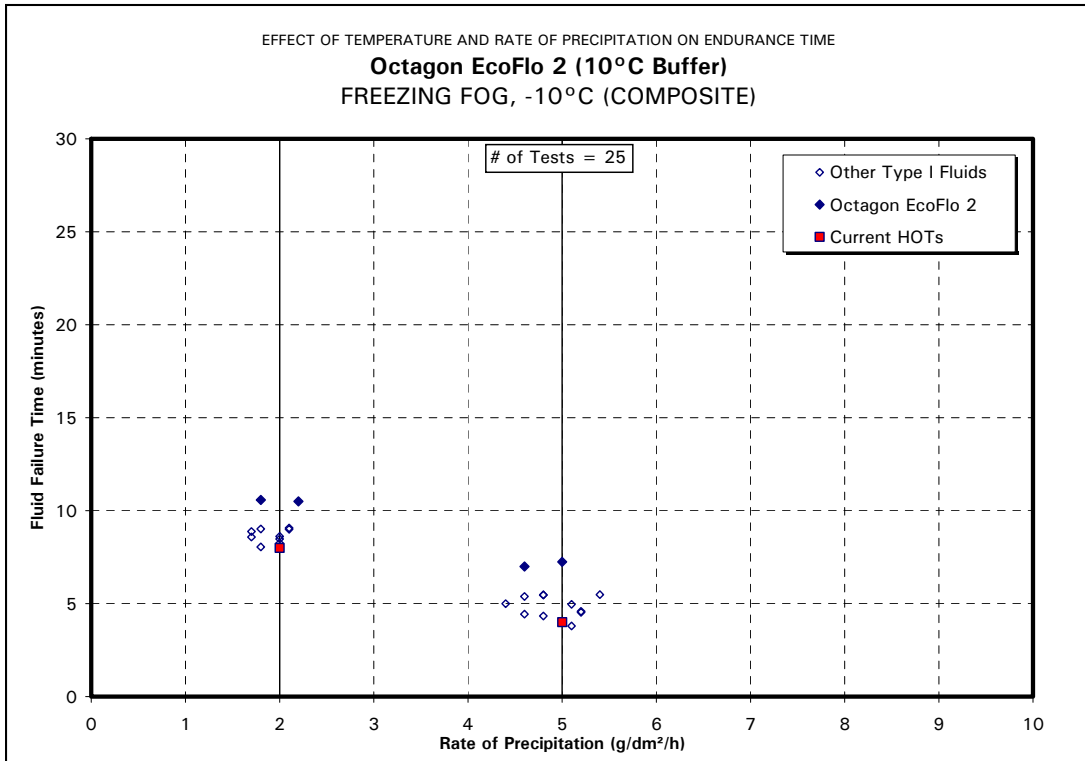

Figure 4.6: Freezing Fog, Below -6 to -10°C, Composite Surface

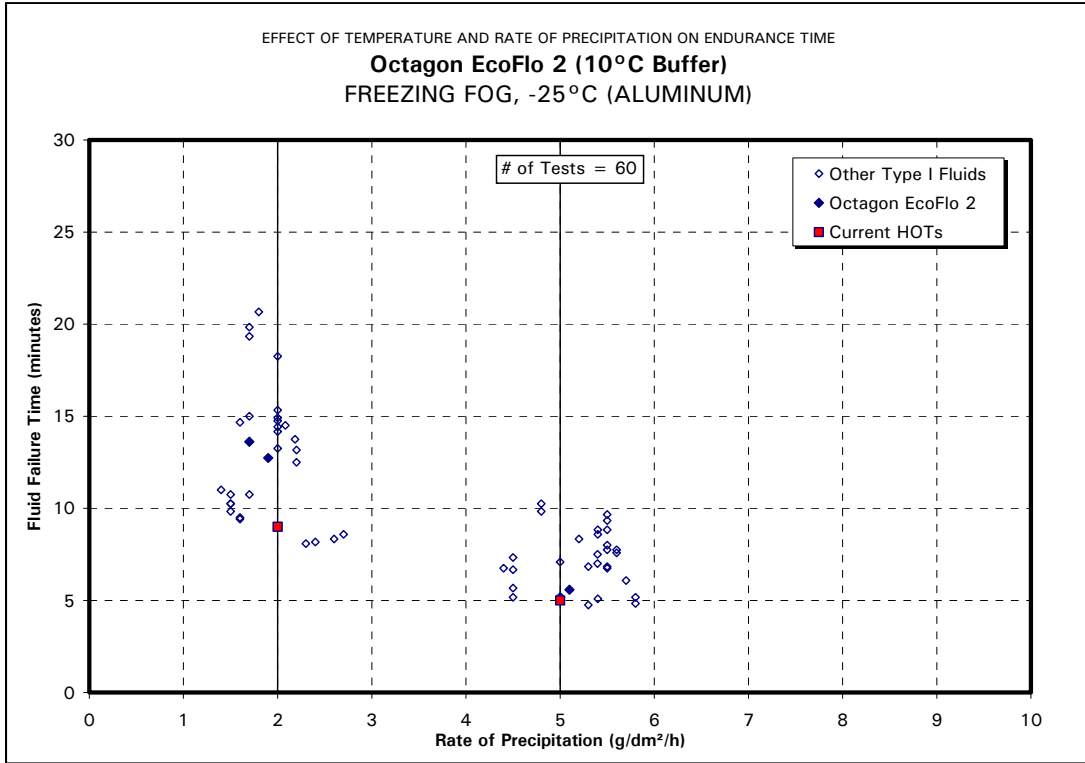

Figure 4.7: Freezing Fog, Below -10°C, Aluminum Surface

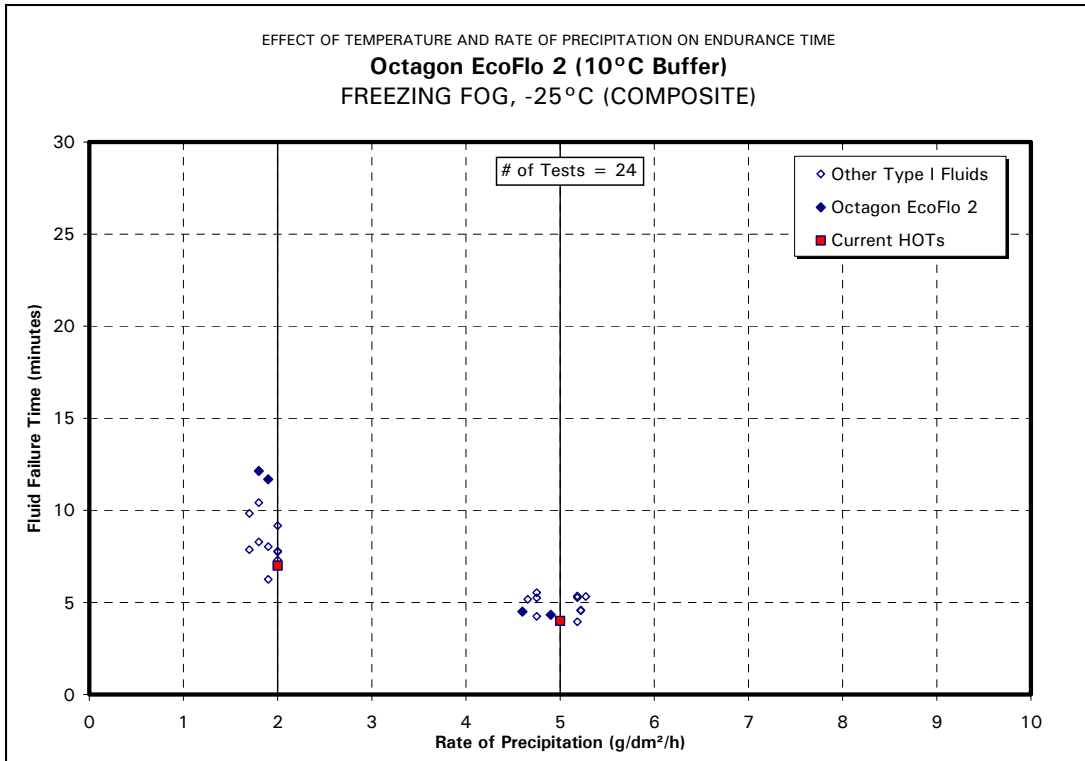

Figure 4.8: Freezing Fog, Below -10°C, Composite Surface

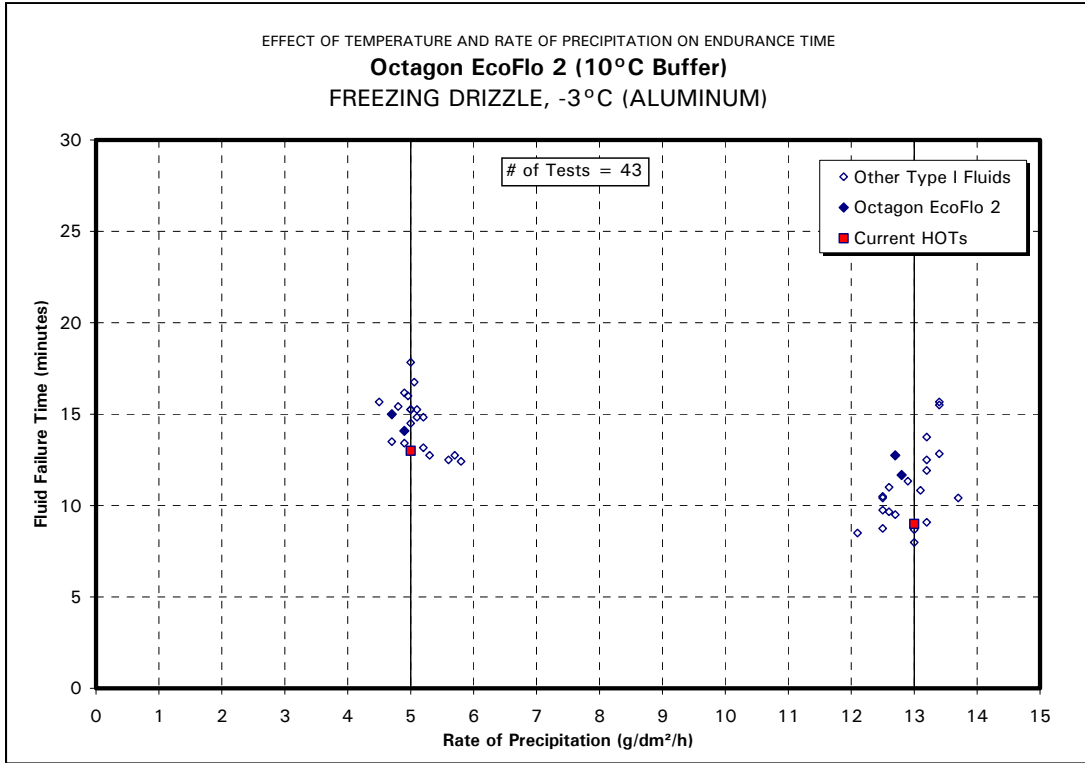

Figure 4.9: Freezing Drizzle, -3°C and Above, Aluminum Surface

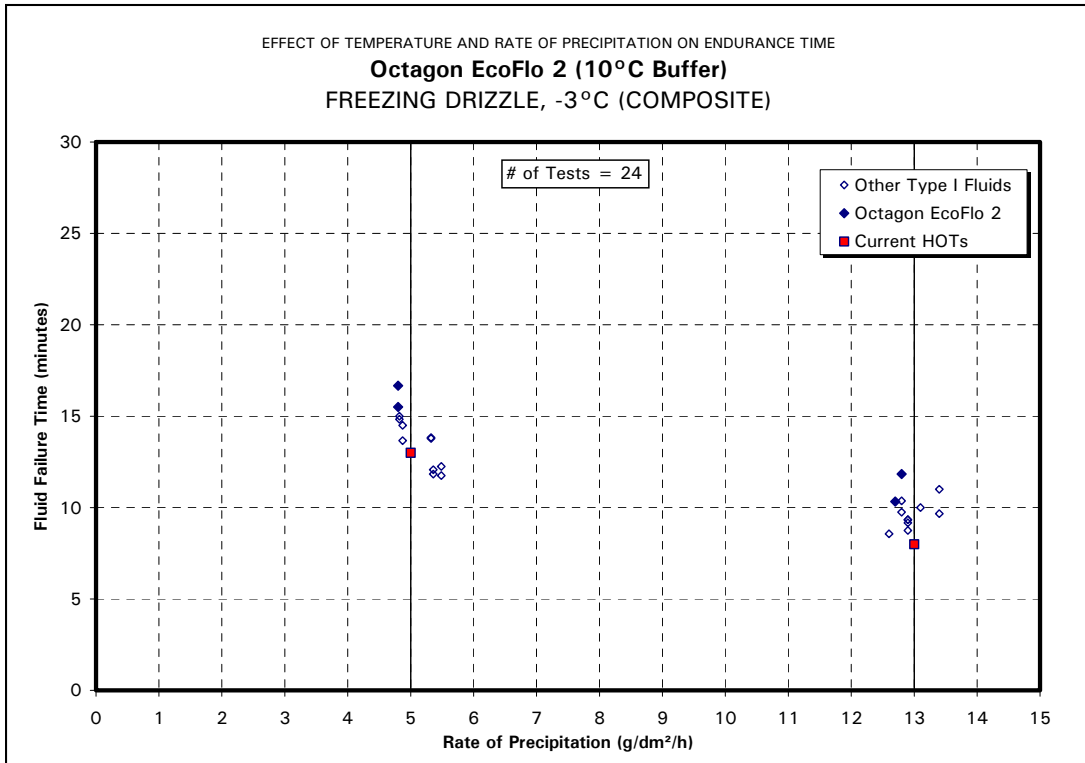

Figure 4.10: Freezing Drizzle, -3°C and Above, Composite Surface

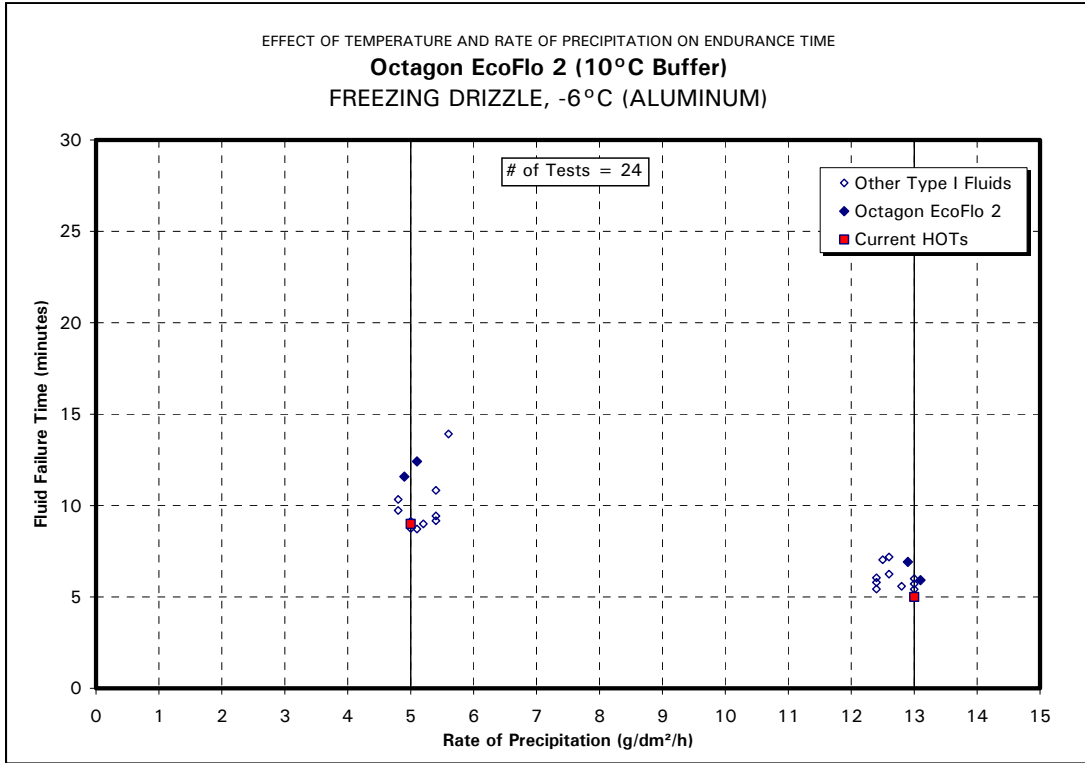

Figure 4.11: Freezing Drizzle, Below -3 to -6°C, Aluminum Surface

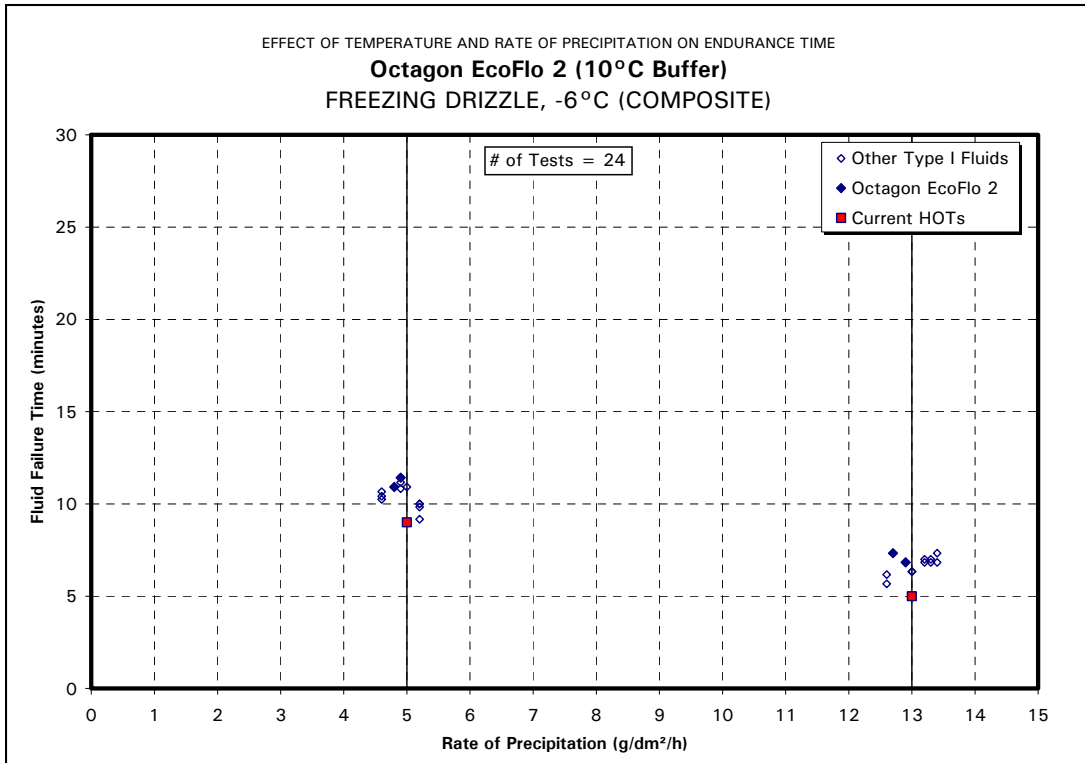

Figure 4.12: Freezing Drizzle, Below -3 to -6°C, Composite Surface

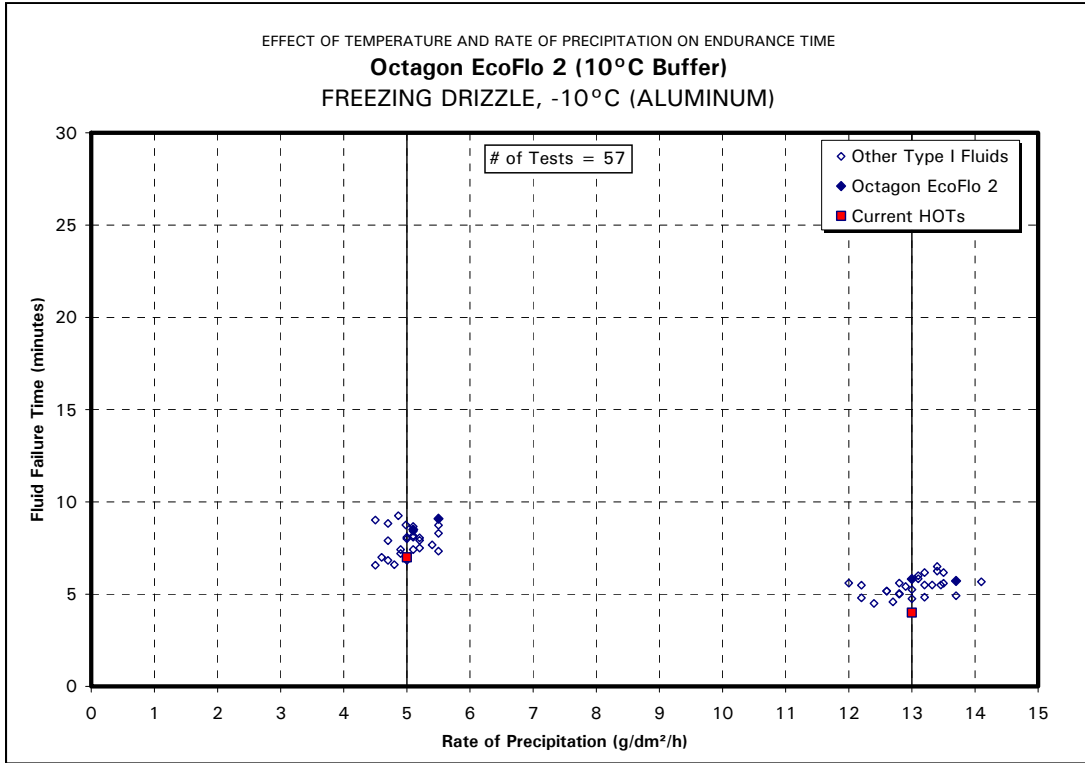

Figure 4.13: Freezing Drizzle, Below -6 to -10°C, Aluminum Surface

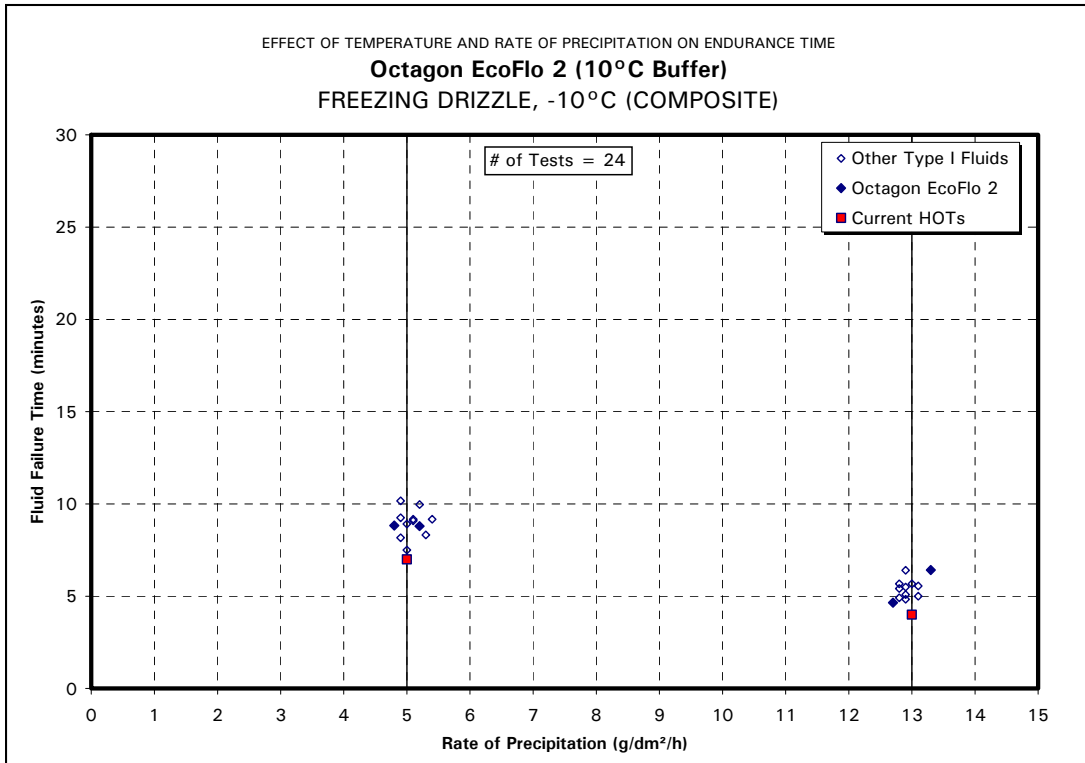

Figure 4.14: Freezing Drizzle, Below -6 to -10°C, Composite Surface

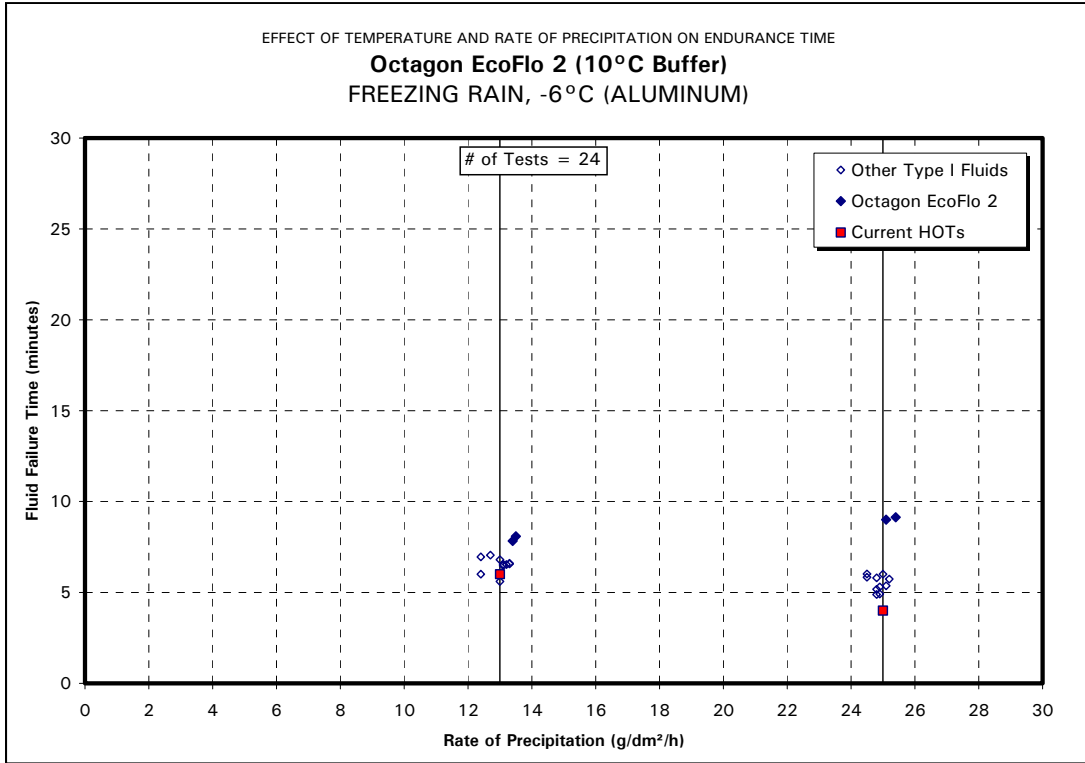

Figure 4.15: Light Freezing Rain, Below -3 to -6°C, Aluminum Surface

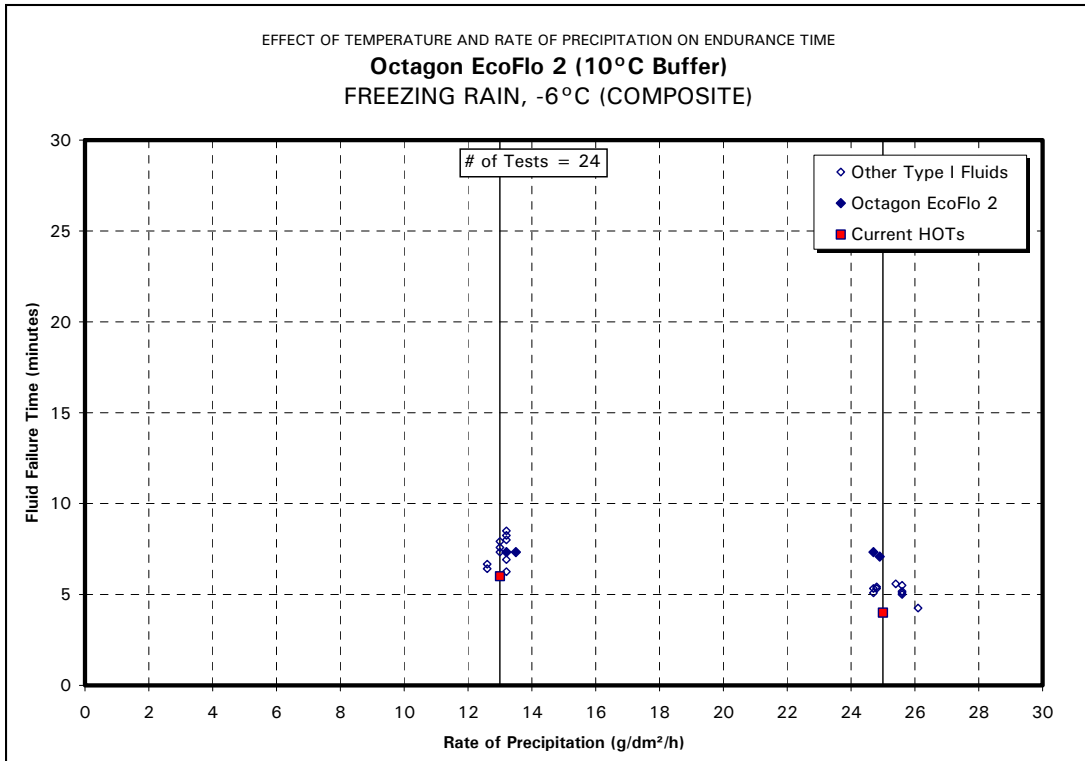

Figure 4.16: Light Freezing Rain, Below -3 to -6°C, Composite Surface

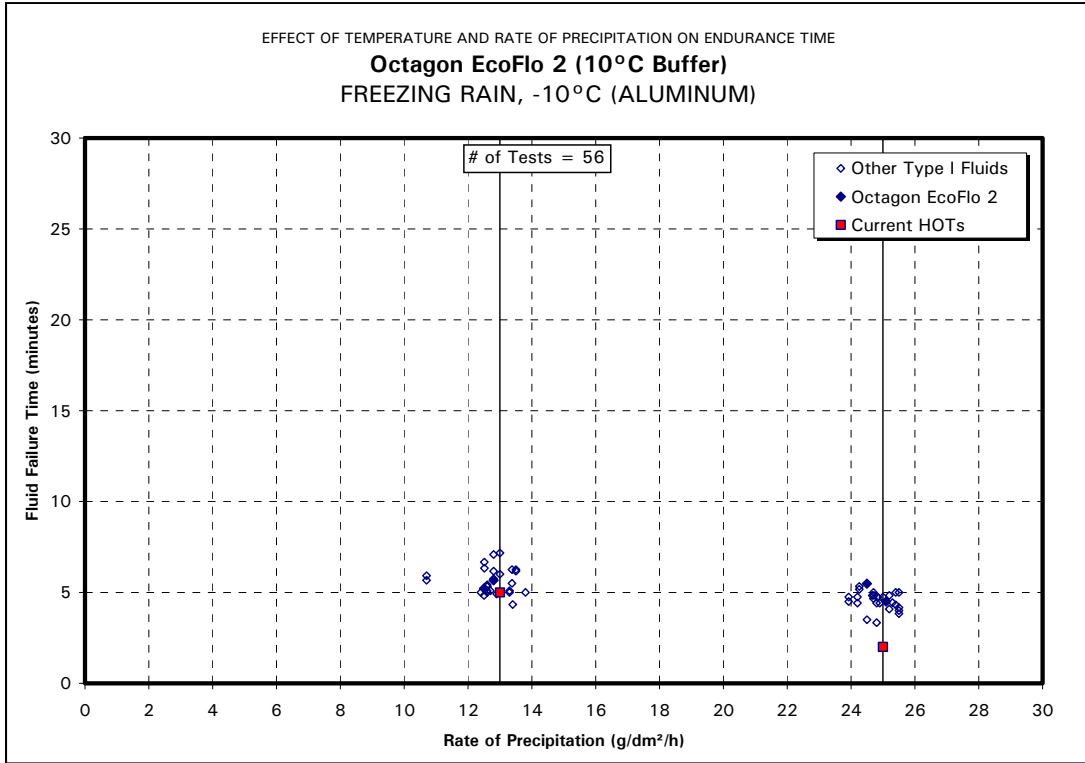

Figure 4.17: Light Freezing Rain, Below -6 to -10°C, Aluminum Surface

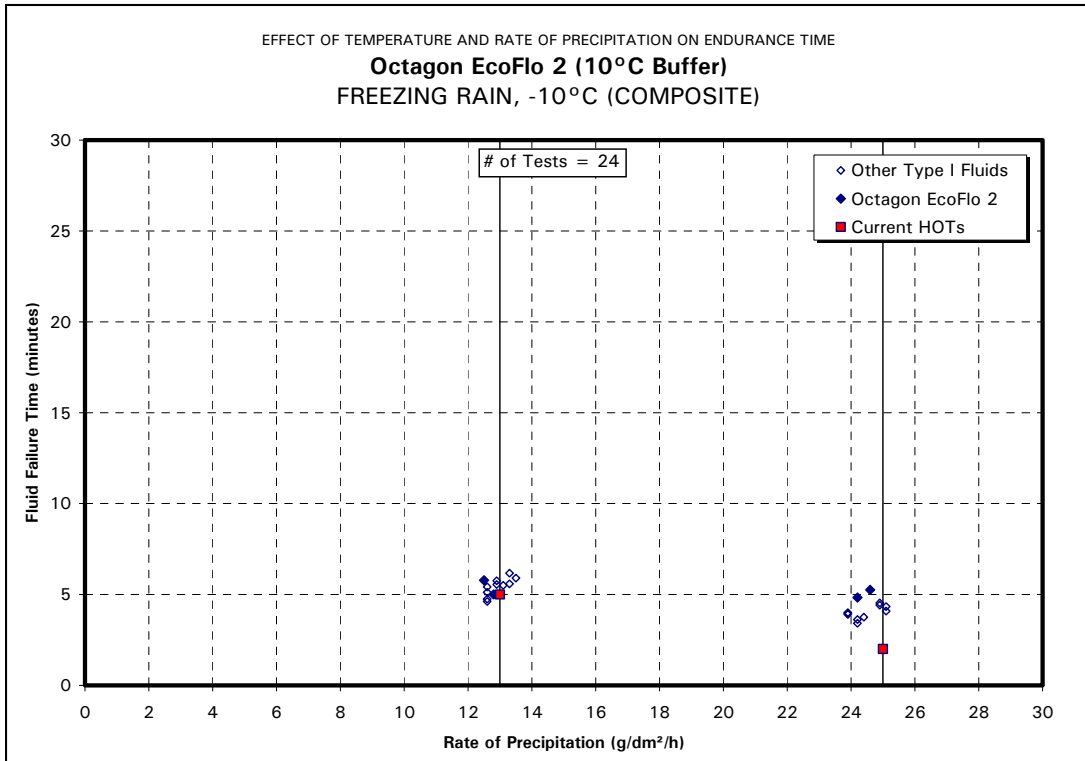

Figure 4.18: Light Freezing Rain, Below -6 to -10°C, Composite Surface

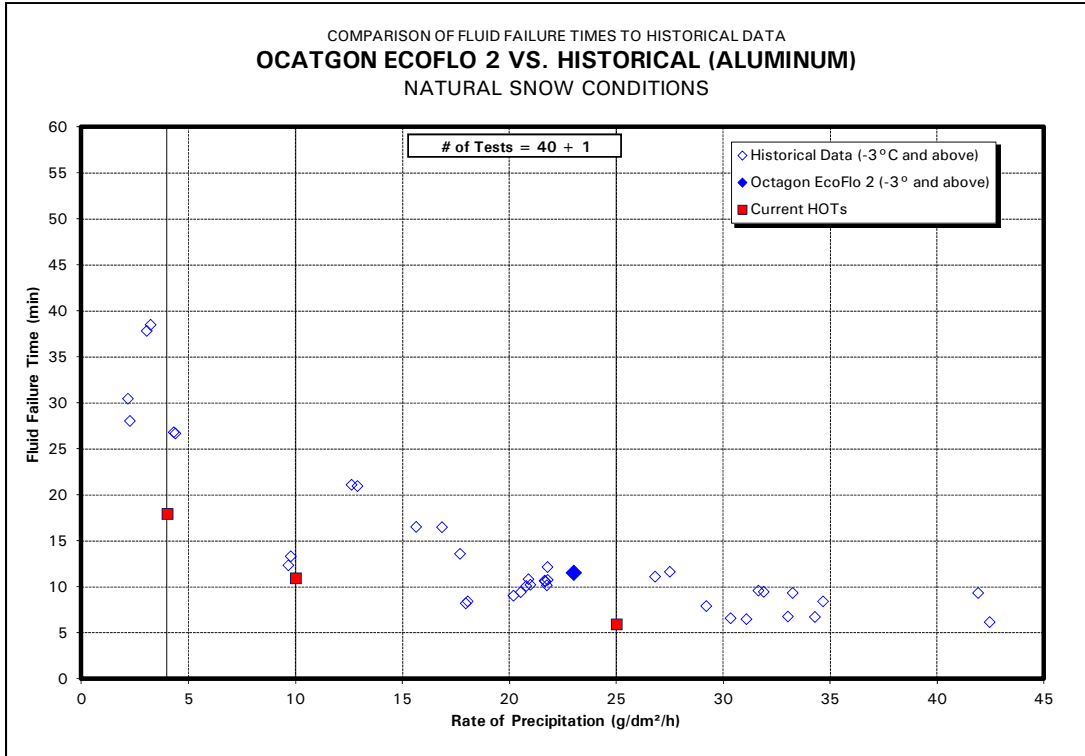

Figure 4.21: Natural Snow, -3°C and Above, Aluminum Surface

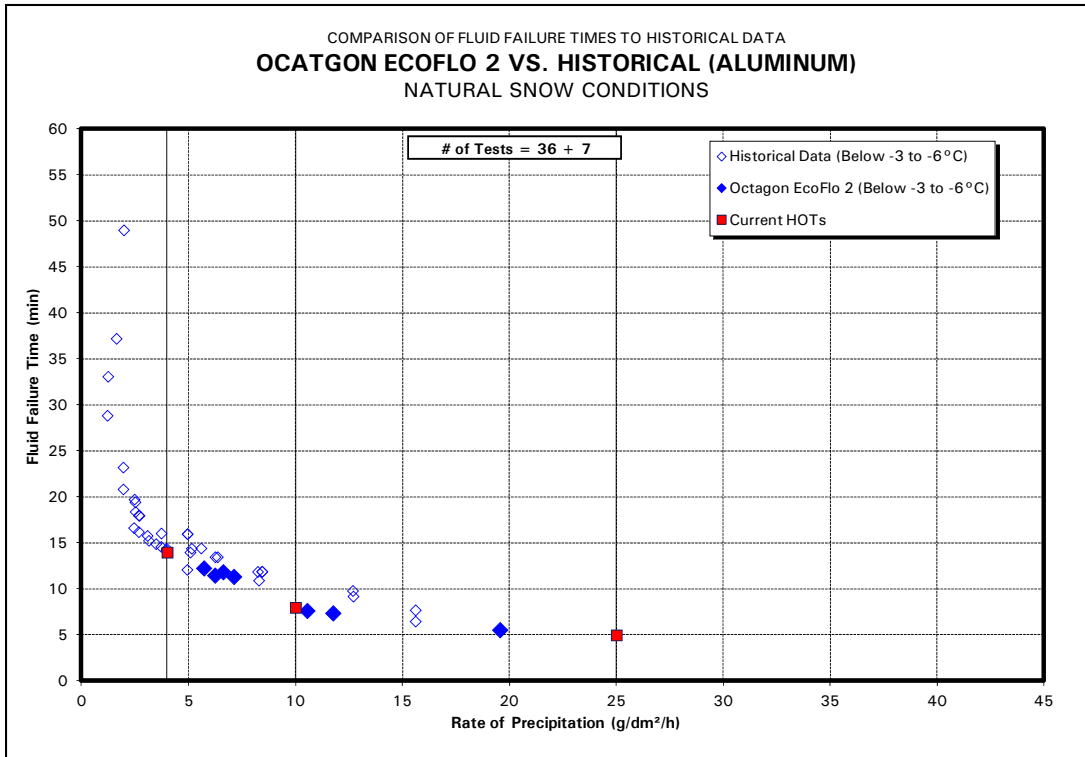

Figure 4.22: Natural Snow, Below -3 to -6°C, Aluminum Surface

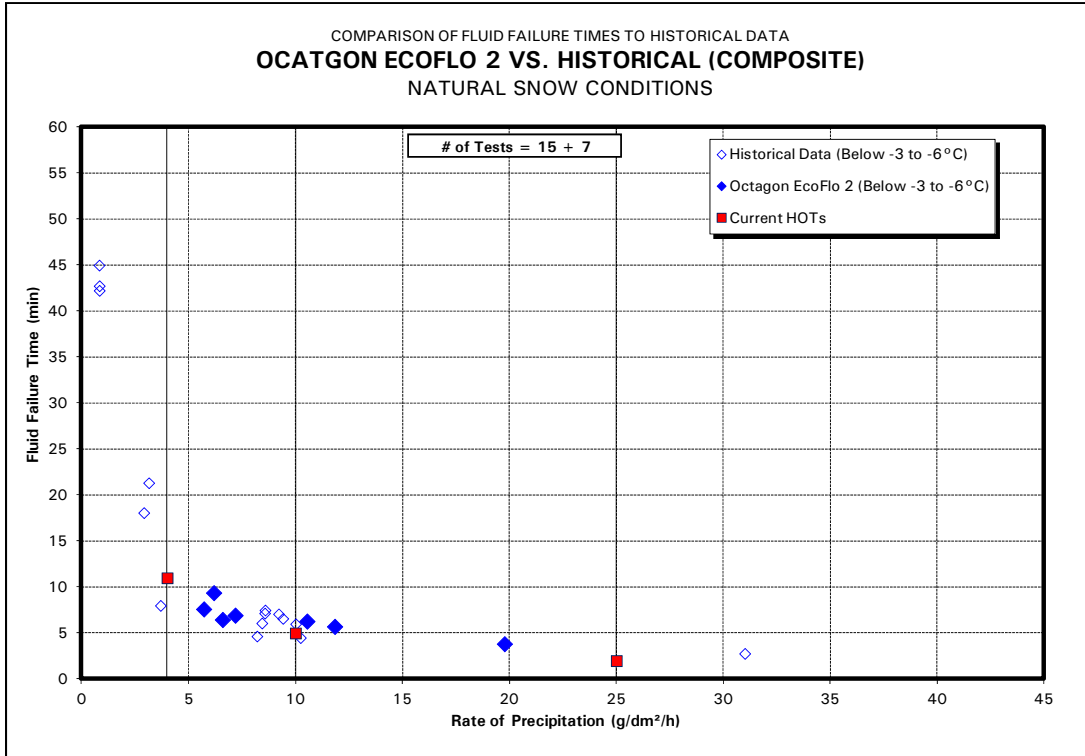

Figure 4.23: Natural Snow, Below -3 to -6°C, Composite Surface

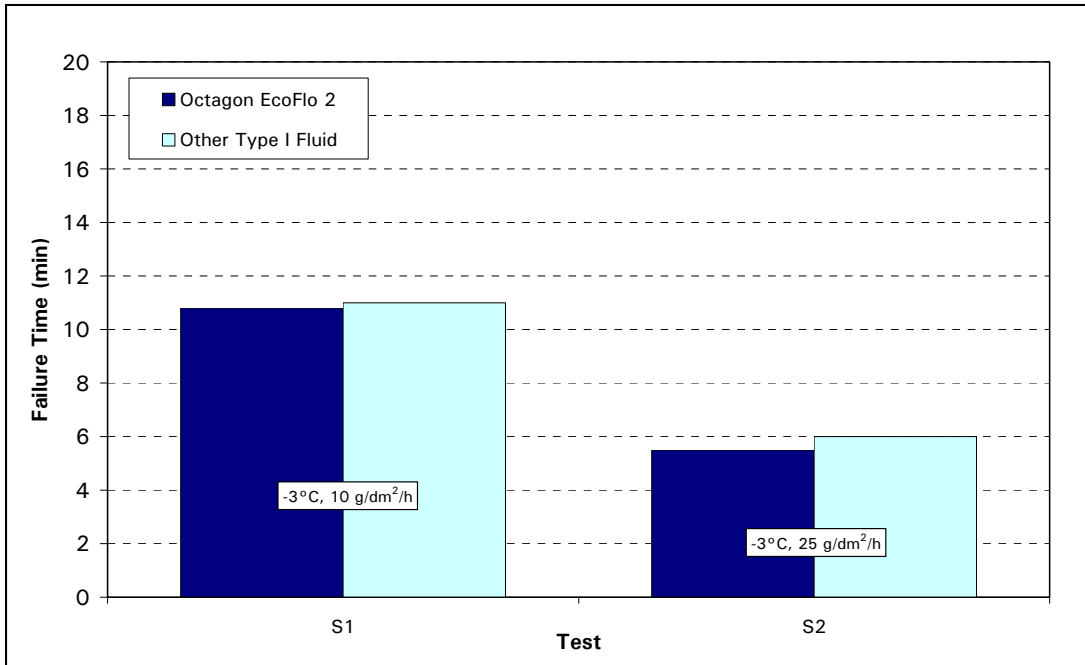

Figure 4.24: Artificial Snow, -3°C and Above, Aluminum Surface