

Repair Types, Procedures – Part I

Mohan M. Ratwani, Ph. D
 R-Tec
 28441 Highridge Road, Suite 530
 Rolling Hills Estates, CA 90274-4886
 USA

MohanR@verizon.net

1.0 INTRODUCTION

Battle damage repair (BDR) can play a key role in the outcome of a war. Promptness, reliability, and effectiveness of repairs affect the availability of aircraft for combat. In an air combat, an efficient Aircraft Battle Damage Repair (ABDR) is a key element in maintaining high sortie rates considering the limited availability of spares. Figure 1 (Ref. 1-2) shows the availability of aircraft for combat with and without ABDR. In Figure 1, excellent repair capability is defined as returning 50 percent of damaged aircraft to combat in 24 hours and 80 percent in 48 hours (Ref. 1). The figure shows that a good repair capability can quadruple the number of aircraft after 10 days of combat.

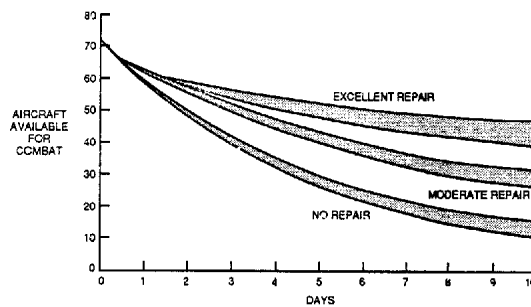

Figure 1: Aircraft Availability with and without Repairs.

The Israeli Air Force has developed an efficient system along with repair techniques for ABDR and demonstrated the effectiveness of their ABDR system in 1973 Yom Kippur War (Ref. 1). Figure 2 shows the effect of rapid repair on the availability of certain Israeli aircraft for combat. The use of rapid temporary repair techniques enabled Israeli Air Force to return 72 percent of the damaged aircraft to combat within 24 hours (Ref. 1).

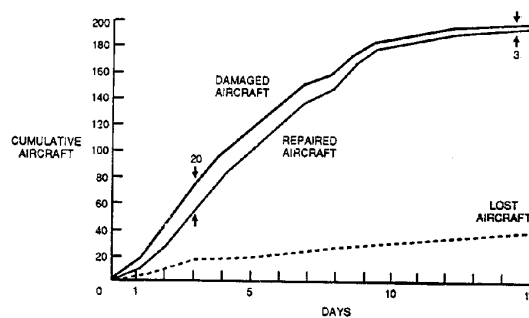

Figure 2: Battle Damage Repair Results of Israeli Air Force.

Report Documentation Page

Form Approved
OMB No. 0704-0188

Public reporting burden for the collection of information is estimated to average 1 hour per response, including the time for reviewing instructions, searching existing data sources, gathering and maintaining the data needed, and completing and reviewing the collection of information. Send comments regarding this burden estimate or any other aspect of this collection of information, including suggestions for reducing this burden, to Washington Headquarters Services, Directorate for Information Operations and Reports, 1215 Jefferson Davis Highway, Suite 1204, Arlington VA 22202-4302. Respondents should be aware that notwithstanding any other provision of law, no person shall be subject to a penalty for failing to comply with a collection of information if it does not display a currently valid OMB control number.

1. REPORT DATE MAY 2010	2. REPORT TYPE N/A	3. DATES COVERED -	
4. TITLE AND SUBTITLE Repair Types, Procedures Part I		5a. CONTRACT NUMBER	
		5b. GRANT NUMBER	
		5c. PROGRAM ELEMENT NUMBER	
6. AUTHOR(S)		5d. PROJECT NUMBER	
		5e. TASK NUMBER	
		5f. WORK UNIT NUMBER	
7. PERFORMING ORGANIZATION NAME(S) AND ADDRESS(ES) R-Tec 28441 Highridge Road, Suite 530 Rolling Hills Estates, CA 90274-4886 USA		8. PERFORMING ORGANIZATION REPORT NUMBER	
9. SPONSORING/MONITORING AGENCY NAME(S) AND ADDRESS(ES)		10. SPONSOR/MONITOR'S ACRONYM(S)	
		11. SPONSOR/MONITOR'S REPORT NUMBER(S)	
12. DISTRIBUTION/AVAILABILITY STATEMENT Approved for public release, distribution unlimited			
13. SUPPLEMENTARY NOTES See also ADA564486. Battle Damage Repair Techniques and Procedures on Air Vehicles - Lessons Learned and Prospects. RTO-EN-AVT-156			
14. ABSTRACT Battle damage repair (BDR) can play a key role in the outcome of a war. Promptness, reliability, and effectiveness of repairs affect the availability of aircraft for combat. In an air combat, an efficient Aircraft Battle Damage Repair (ABDR) is a key element in maintaining high sortie rates considering the limited availability of spares. Figure 1 (Ref. 1-2) shows the availability of aircraft for combat with and without ABDR. In Figure 1, excellent repair capability is defined as returning 50 percent of damaged aircraft to combat in 24 hours and 80 percent in 48 hours (Ref. 1). The figure shows that a good repair capability can quadruple the number of aircraft after 10 days of combat.			
15. SUBJECT TERMS			
16. SECURITY CLASSIFICATION OF:			17. LIMITATION OF ABSTRACT SAR
a. REPORT unclassified	b. ABSTRACT unclassified	c. THIS PAGE unclassified	
			18. NUMBER OF PAGES 22
			19a. NAME OF RESPONSIBLE PERSON

The requirements of Aircraft Battle Damage Assessment and Repair (ABDAR) Technical Manual are discussed in United States Military Specification MIL-PRF-87158B (Ref. 3). Various requirements of battle damage repair such as repair of structural components, electrical and mechanical systems, fuel system, wiring, etc., are discussed in the MIL spec. The present paper deals primarily with bonded structural repairs with emphasis on repair of aircraft structures.

2.0 AIRCRAFT BATTLE DAMAGE ASSESSMENT AND REPAIR (ABDAR) TECHNICAL MANUAL

Ref. 3 specifies the requirements of ABDAR technical manual so that users can efficiently and reliably take action on the disposition of the damaged aircraft. While it is not feasible to discuss all the requirements of the ABDAR manual as per Ref. 3, certain essential features and requirements from the reference are mentioned here.

2.1 Damage Assessment

Damage limits, repair guidelines, instructions, and references to applicable documents which enable an assessor to make the correct decision regarding deferment or repair shall be provided. Previous data from similar aircraft shall be included.

2.2 Structures Description

MIL Spec (Ref. 3) specifies that a brief description of the aircraft (rotary wing and fixed wing) structure shall be given with three dimensional illustrations of various zones. A brief explanation of zones shall be given. These zones shall be selected such that they are essentially repair-independent and physically distinct based on structural features/equipment commonality. Five separate categories shall be used to categorize all external and internal structural members as follows:

- Category I, primary airframe structure- These members shall include, but are not limited to: main longerons, bulkheads, spars and ribs; structural torque boxes in highly stressed areas; stress panels which serve to stabilize tension and compression loads between primary load carrying members; and any group of structural members in which a single failure may result in the immediate loss of an aircraft at the maximum expected load. For this category, limits shall be listed for all three damage classes.
- Category II, secondary structure- This structure serves to transfer aerodynamic and other loads to the primary structural members. This structure primarily consists of external skin panels that are not considered primary stress panels, intermediate ribs, stringers, and formers which only serve to transfer load to primary members. Repair of these structural members does not require restoration of original design strength and stiffness within the content of war time environment. Limits shall be listed for all damage classes.
- Category III, nonessential structure- Nonessential structure such as doors, panels, tips, fairings, etc., which may be extensively damaged or completely missing and no repair or replacement is required to maintain the airworthiness or mission capability. Limits shall be listed for all damage classes.
- Category IV, special structure- These are special structures which are non-structural, but essential for safe flight and aircraft performance. Repair requirements for these structures are based upon considerations other than strength; such as aerodynamics, pressurization or engine performance. Limits shall be listed for all damage classes.
- Category V, repair restrained structure- These structures are not feasible to repair under battle damage restraints due to design and shape. These structures include all complex machined or

forged parts and irregular shaped extrusions, channels, etc. Limits shall be listed for A and C damage classes.

2.3 Damage Categories

The damage is classified in the following 3 categories:

- Class A, degraded capability- damage limits that result in establishing operational restrictions when repair is not accomplished. The only purpose of this damage class is to permit the restricted use of the aircraft when time to repair is critical factor.
- Class B, repairable damage- damage limits which permit structural repairs within 24 hours or less, per single repair. Repairs to restore static strength and stiffness of damaged component for Category 1, II, and IV structures, shall restore full operational capability of the aircraft for at least one more flight.
- Class C, acceptable damage- Damage limits which do not impose any operational restrictions on the aircraft, when repair is not performed. A minimal cleanup of damage may be required (e.g., stop drill, stress reduction, etc.).

2.4 Damage Limitations

Damage limitations for all Categories I, II, IV, and V structures shall be provided. The limitations shall include the size and location for classes A, B, and C damage up to which repairs can be made under ABDAR constraints. The maximum number of repairs and the limits for the proximity of multiple damages to a given structural component shall be included. Guidelines, instructions and illustrations for accomplishing repair shall be provided.

2.5 Materials

Repairs shall be designed using ABDAR Tool/Material Kits Listings approved by authorities. Preferred materials required for special repairs shall be specified. A consolidated list by part numbers shall be included. Special materials such as bonding materials, primers, sealants, etc. shall be included. All items shall be identified using Military/Federal specifications

2.6 Typical Repairs

Typical repairs that are common to two or more zones shall be described. Typical ABDAR repairs include repairs that will provide full or partial mission capability. Such typical repairs shall be provided for all aircraft systems, subsystems, and components. Repair steps influencing survivability, vulnerability or radar cross-section characteristics shall be identified

2.7 Safety Factors

Analysis supporting battle damage structural repairs shall be based on ultimate strength. Repairs shall have stiffness compatible with original structure. However, service life, corrosion, and aesthetic considerations may be overlooked in exchange for a rapid repair procedure. Strength related calculations for un-repaired structure shall be made to obtain maximum utilization under war time conditions and accommodate worst case contingencies. Calculations shall be made to determine the static strength of the damaged and un-repaired structure. Operations of the aircraft should be restricted to two-thirds of that strength or to restriction engendered by damage tolerance residual strength considerations, whichever is lower. Safety of flight primary structure shall provide for adequate residual strength in the presence of cracks from damage remaining in the structure. The size and types of remaining damage that are to be assumed shall be established for each primary structural member in each zone for each damage category (Ref. 3). Structure

with assumed remaining damage shall be capable of sustaining limit load or 1.2 times that maximum load associated with any operating restriction. Care shall be exercised to assure that deformation that would degrade the load carrying or operating capability will not occur at the operational restriction.

3.0 REPAIR FACILITIES

Having proper repair facilities are perhaps the most important requirements for any repair operation. These requirements are governed by the type of repairs to be performed. For bonded composite repairs the facilities shall include- freezers, ovens, clean room areas, environmental control of the temperature and humidity, electrical and pneumatic power. Necessary equipment such as bonding fixtures, assembly jigs, machining tools, and vacuum pumps should be available. Facilities for handling hazardous materials are needed. Materials for repairs that need to be stocked include prepreg, adhesives, honeycomb core, bagging film, sealants, sheet metal, fasteners, etc. The most important aspect of any repair facilities is having right personnel with necessary knowledge and experience to perform reliable repairs efficiently to meet design requirements. The skills of personnel shall include- machining, bonding of composites, cutting, stacking, bagging, and curing of prepreg.

3.1 Material Handling and Storage

Polymer matrix prepreg materials have to be handled properly and stored in proper environments to assure the quality of the material. The storage requirement and shelf-life are established by the manufacturer based on the chemical composition, and mechanical properties at the time of storage in the controlled environments. Thermoset matrix composites and adhesives are stored in sealed bags at 00F (-180C). The storage process retards the “aging” or partial curing of polymer and extends the shelf-life. The sealed containers or bags prevent the condensation during the storage. When the prepreg is removed from the freezer for laminate fabrication, it is allowed to thaw in the sealed containers until it reaches ambient conditions.

Polymer matrix prepreg generally has a backing sheet that improves the handling quality and protects prepreg from handling damage. Non-woven unidirectional tapes can otherwise split between fibers. Clean, white lint-free cotton gloves are recommended when handling prepreg material to prevent transfer of skin oil to the material. Splinters are not present in the uncured prepreg; however, caution should be exercised to avoid penetration of small diameter fibers into the hand from prepreg edges.

A clean room environment similar to that for bonding process is required when prepreg is to be handled for fabricating laminates. Prepreg must be shielded from impurities and moisture. Fabrication area must be enclosed and doors to remain closed even when area is not in use. Temperature and humidity should be controlled within the limits shown in Figure 3 (Ref. 4).

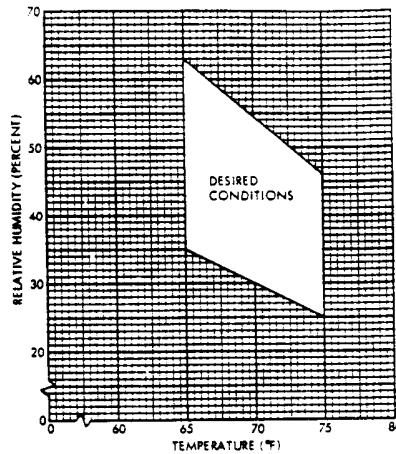

Figure 3: Composite Fabrication Area Requirements.

3.2 ABDR Trailer

United States has developed (Ref. 2) Combat Logistics Support Squadron (CLSS), designed to provide support in the areas of maintenance, transportation, and supply. CLSS teams train personnel to meet mission requirements irrespective of environmental conditions. To meet ABDR requirements CLSS has established trailers with a limited amount of specialized tools and equipment to support an authorized aircraft. These trailers have been developed with mobility in mind. A typical ABDR trailer, shown in Figure 4 (Ref. 2), has dimensions-L 122” (3.1 m) x W 84” (2.13m) x H 88” (2.24m). The weight is about 5,000 pounds (2,273 Kg) fully stocked plus a 1,300 pound (591 Kg) composite kit. A typical generic ABDR trailer has common hand/power tools, fasteners, hoses, tubing, metal sheets and angles. Composite kit in the trailer contain- hand/power tools, dust vacuum, heat repair bonder, surface treatment material, composite materials, and other materials required for fabrication of specific composite parts.

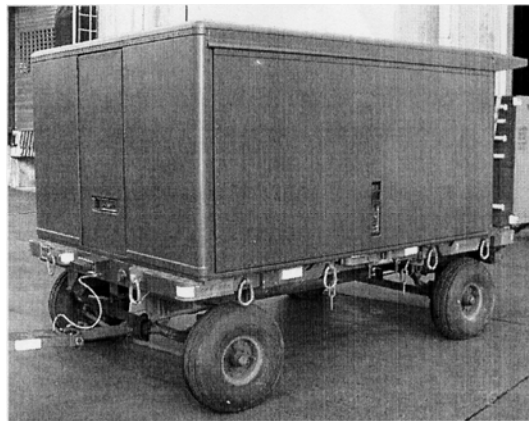

Figure 4: ABDR Trailer.

4.0 ABDAR SOFTWARE

Technology to enhance the ABDAR process is discussed in Ref. 5-7. An automated capability to provide aircraft battle damage assessors with technical data and assessment tools via a portable maintenance aid has been developed and demonstrated in the references. The system developed in the references was end-

to-end system, starting with the aircraft debrief and continuing through the ABDAR process to the final documentation of damage assessment on US Air Force Technical Order (AFTO) Form 97.

An expert system for designing battle damage repairs is discussed in Ref. 8. The expert system designs bolted and bonded repairs for battle damaged wing skins. The system requires input such as damage size and location, repair materials, and loads. The expert system uses the analyses software developed under US Air Force and Navy sponsorship. Bolted repair expert system uses BREPAIR program which uses boundary collocation techniques for analysis of stresses in skin and patch. Bonded repair expert system uses two programs namely PGLUE and BJSFM. The PGLUE program is a finite element-based program for analysis of bonded repairs. The BJSFM computes the stress field around a loaded or unloaded hole in a finite width plate.

5.0 BATTLE DAMAGE REPAIR STEPS

A typical battle damage repair process will involve the following steps:

5.1 Assess the Damage

Assessing the damage is the first step in any ABDAR process. When an aircraft is identified with ABDAR discrepancy, a Debrief Action and a Walk-around Action are created. During the Walk-around Activity zones that contain damage are identified by the walk-around assessor. The Damage Assessor (DA) will debrief the aircraft pilot, diagnose the extent of damage from reported symptoms, assess the physical evidence of the damage, and investigate any secondary damage that might have occurred. After completing the assessment, the DA makes the assessment report which includes repair instructions and priority.

In composite structures any non-visible damage present in the form of delaminations around holes or surface indentation is determined by nondestructive inspection. This damage is clearly identified so that it can be cleaned up before a repair is performed. Nondestructive inspection techniques such as tap test, ultrasonic techniques, or digital thickness gage may be used to determine the extent of non-visible damage around the visible damage.

5.2 Establish Repair Criteria

Next step is to establish criteria to which the repairs have to be designed. If the repair is not a standard repair as per ABDAR manual, the non-standard repair should meet the strength design requirements given in Ref. 3. If the repair is to be made to an aerodynamic surface, it should meet the aerodynamic smoothness requirements of the surface being repaired.

5.3 Select Suitable Repair

Depending on the damage category, standard repairs are described in ABDAR manual for an aircraft. If the assessed damage is within the damage category, the standard repairs are selected. However, if the repair to be performed is not a standard one, the type of repair to be performed is governed by several factors. Some of the factors to be considered are:

- Type of structural material to be repaired (metal, composite, sandwich construction).
- Type of structural component to be repaired (skin, spar, rib, longerons, etc.).
- Type and extent of the damage (e.g. cracks, corrosion, impact damage, etc.).
- Load levels and loads spectrum experienced by the structure.

- Material thickness to be repaired.
- Skill of the available labor.
- Availability of repair materials including tools from an established ABDR kit.
- Repair facility.

5.4 Repair Design/Analysis

Suitable materials are selected to accomplish the repairs. The non-standard repairs are designed to meet the requirements specified in MIL. Handbook (Ref. 3) and any other requirements based on aerodynamic smoothness, radar cross section, etc. A check on the integrity of the repair is done based on the static strength.

5.5 Perform Repair

The repairs are performed using the established materials and processes for the selected repair design. Prior to performing the repairs, the damage area is cleaned to remove jagged edges and stress concentrators. In composite structures any non-visible damage present in the form of delaminations around holes or surface indentation, identified by nondestructive inspection, is removed before a repair is performed.

5.6 Post-Repair Functional Checks

Nondestructive inspection of repair is carried out to verify the integrity of repair. The integrity of the aircraft structure to meet the operational usage requirement is verified. Any limitations on the aircraft, systems or performance are identified.

6.0 BONDED REPAIRS OF METALLIC STRUCTURES

The conventional mechanically fastened repair concept is not structurally efficient primarily due to the drilling of holes for additional fasteners that affect the structural integrity of the structure. In many cases, the parts have to be scrapped due to the repaired structure not meeting the fail safety requirements. The bonded composite repair concept has provided excellent opportunities to design more efficient repairs (Ref. 9-14) and in many cases has made it possible to repair damaged structures which could not be repaired with the conventional mechanical fastening and were scrapped. Composite patch repairs also result in reduced inspection requirements compared to mechanically fastened repairs.

In bonded composite repair concept a composite patch is bonded to the damaged metallic part instead of a conventional mechanically fastened patch. Bonded composite repair has many advantages over conventional mechanically fastened repair, namely: 1) More efficient load transfer from a cracked part to the composite patch due to the load transfer through the entire bonded area instead of discrete points as in the case of mechanically fastened repairs, 2) No additional stress concentrations and crack initiation sites due to drilling of holes as in the case of mechanically fastened repairs, 3) High durability under cyclic loading, 4) High directional stiffness in loading direction resulting in thinner patches, and 5) Curved surfaces and complex geometries easily repairable by curing patches in place or prestaging patches. The cross-section of a typical 16-ply T300/5209 graphite/epoxy patch bonded to an aluminum sheet is shown in Figure 5.

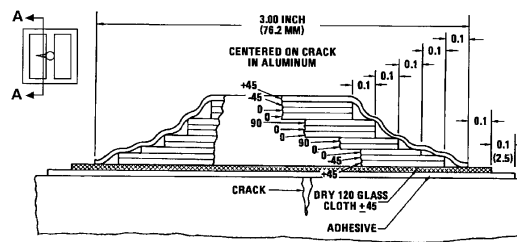

Figure 5: T300/5209 Graphite/Epoxy Repair.

6.1 Surface Preparation

Surface preparation is one of the most important steps in bonded repairs. Structural adhesives need to form chemical bonds to achieve desired strength. The following steps need to be followed:

- **Damage Cleaning**- Clean the damaged area by smoothening the jagged edges. Any cracks in the damaged area may be stop-drilled.
- **Paint Removal**- Abrade the area with 240 grit abrasive paper, using care not to gouge into the metal. Complete the abrading with 320 grit paper followed by Scotch Brite pads and Ajax cleanser to remove all organic coatings, anodic or chemical films, and corrosion products.
- **Solvent Cleaning**- Wipe with cheesecloth soaked in Turco 4460 or Methyl Ethyl Ketone (MEK). Immediately wipe dry with cheesecloth.
- **Joint Sealing**- Seal all faying surface joints adjacent to repair area with sealing compound or aluminum foil tape. Surface to be bonded must be masked to prevent contamination during sealing operation.
- **Verify Surface Cleanliness**- Surface cleanliness is verified by water-break test. The water-break test is performed by spraying, pouring or squirting distilled water on the clean surface such that the surface is covered by thin film of water. The film of water must remain intact for 30 seconds without breaking due to surface tension. If the cleaned area fails the water-break test, the surface is cleaned again till it passes the test. After water-break test the moisture from the surface is to be removed. Drying is generally done using hand held hot air gun or hot air blower with filters.
- **Chemical Treatment to Enhance Bond Durability**- After cleaning, metal surfaces require chemical modification to achieve proper adhesion. Both silane and phosphoric acid non-tank anodize (PANTA) have been found to be suitable. The silane process has the advantage of being non-acid process. Acidic treatment is used only after the approval of Engineering Authority for the aircraft being repaired.
- **Priming Surface**- Primer is applied to the aluminum surface after chemical treatment to prevent contamination and improve long-term durability. BR-127 primer has been found to be suitable.

6.2 Material Selection

6.2.1 Adhesive Material

Room temperature cure adhesives are not considered suitable due to service temperature requirements of 1800F (820C) in the majority of aircraft repair applications. A 3500F (1770C) cure film adhesive is not desirable, as the curing at such a high temperature is likely to cause undesirable high thermal stresses. Also, an aluminum structure exposed to a 3500F (1770C) temperature will undergo degradation in mechanical properties. A 2500F (1210C) cure adhesive system is considered suitable for the composite patch repair of aluminum structure. Ductile adhesives such as FM-73 are preferred over brittle adhesives

such as FM-400 due to the tendency of the brittle adhesives to disbond around the damage area, thereby reducing the load transfer to the repair.

In Ref. 15, paste adhesive Hysol EA9394 has been characterized for adhesive bonding. It is shown that EA9394 adhesive cured at $190\pm 100F$ ($88\pm 50C$) exhibits excellent shear strength at $-670F$ ($-190C$) to $2000F$ ($930C$). The adhesive has shelf life of one year at room temperature. At $750F$ ($240C$) storage shelf life of two years has been demonstrated in the reference.

6.2.2 Composite Repair Material

Both boron/epoxy and graphite/epoxy composites are suitable for the repairs. The choice between boron or graphite fibers is based on availability, handling, processing and the repair material thickness. Boron has higher modulus than graphite and would result in thin repair patches. Thin patches are more efficient in taking loads from damaged parts as compared to thick patches. For repairing relatively thick parts, boron may be preferred over graphite. When graphite/epoxy composite patches are used, a layer of glass is inserted between the patch and aluminum, as shown in Figure 5, to prevent galvanic corrosion. It is considered desirable to use highly orthotropic patches, having high stiffness in the direction normal to the crack, but with some fibers in directions at 45 and 90 degrees to the primary direction to prevent matrix cracking under biaxial loading and inplane shear loads which exist for typical applications. This patch configuration can be best obtained with unidirectional tape. Woven material has greater formability and could also be used, although it would not make a very efficient patch. Fiber orientations for unidirectional tape material and woven material are illustrated in Figure 6.

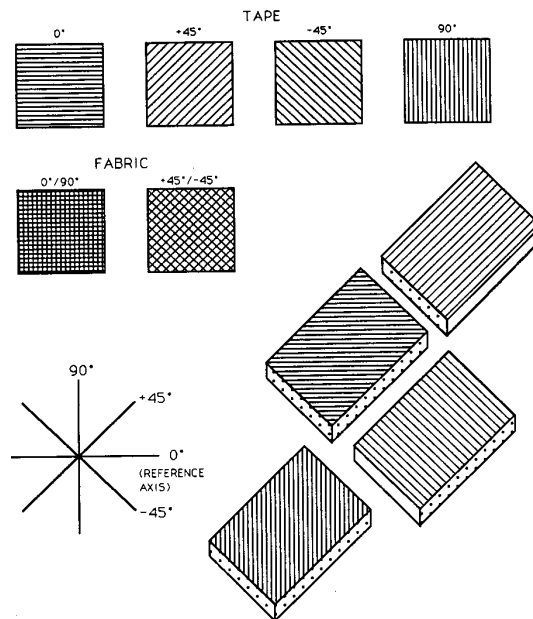

Figure 6: Lamina Fiber Orientation Code.

The composite patches may be precured, prestaged or cured in place. At locations where vacuum bagging is a problem, a precured patch may be prepared in an autoclave and then secondary bonded to the repair area. For relatively minor contours, a prestaged patch may be used. For curved surfaces the patch may be cured in place during the bonding operation.

6.3 Bonding Operation

Bonding of repair patches requires a proper temperature control within +100F (60C) and -50F (-30C) in the repair area. Thermal blankets to provide temperature in excess of 10000F (5380C) are available. A proper temperature control within tolerances is necessary for bondline to achieve required strength. A large aircraft structure compared to a small repair area may act as a heat sink and jeopardize maintaining desired temperature control for the required duration. Proper heat blankets for surrounding areas may be required for such cases. Hot bonding units (e.g. ATACS hot bonder) may be used for bonding process. Heat control is maintained by thermocouples in each zone.

A proper cure cycle is followed as prescribed by the adhesive manufacturer. For FM-73 adhesive cure at 2500F (1210C) for 120 minutes is desirable.

6.4 In-Service Applications of Composite Patch Repairs to Metallic Structures

Composite patch repair applications to in-service aircraft are found in T-38 wing skin (Ref. 16-19), C-141 weep holes (Ref. 20), and F-16 fuel access hole (Ref. 21). Composite patch repair of T-38 lower wing skin at “D” panel is shown in Figure 7 (Ref. 9-10).

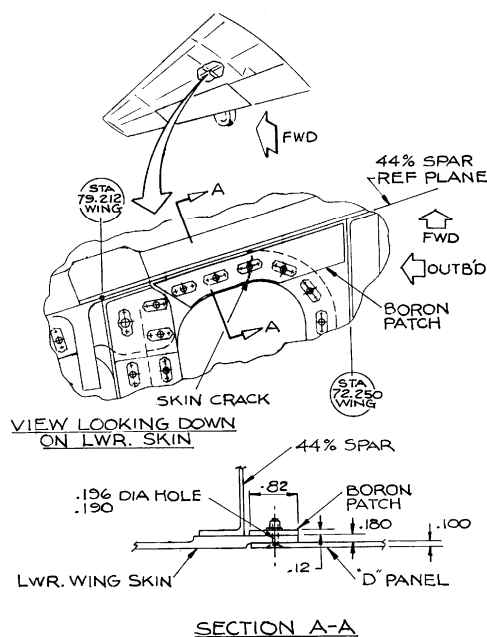

Figure 7: T-38 Lower Wing Skin Composite Patch Repair at “D” Panel.

A metallic lower wing skin damaged during landing is shown in Figure 8. The wing skin had jagged hole and was bent in the damaged area. A metallic patch would not restore the required strength of the wing; hence, it was decided to bond a composite patch.

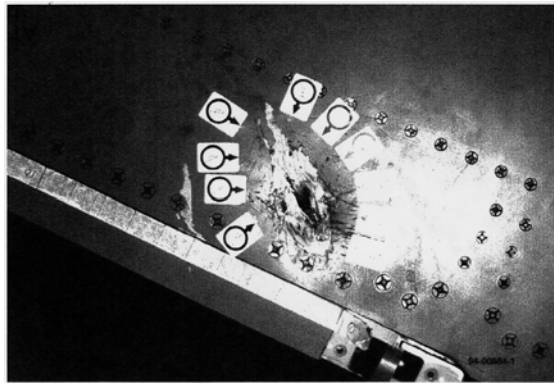

Figure 8: Lower Wing Skin Damage.

The damaged area was cleaned to make a nice circular hole and get rid of any severe stress concentrations. A fiberglass seal plug was installed in the hole as shown in Figure 9. The hole was filled with epoxy. The wing skin thickness in the damaged area required a much thicker graphite/epoxy patch as compared to boron/epoxy repair patch. Hence, it was decided to use a 38-ply boron patch. Due to the curvature of the damaged area a pre-cured patch could not be used. Hence, a staged patch was prepared and then bonded with FM73 adhesive to the damaged area. The wing skin with boron/epoxy patch is shown in Figure 10.

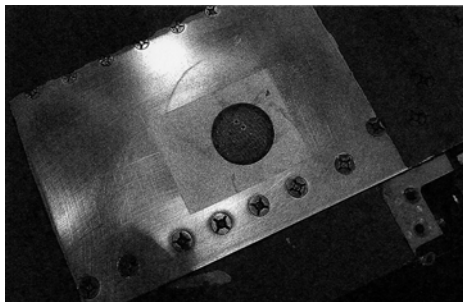

Figure 9: Installed Fiberglass Seal Plug.

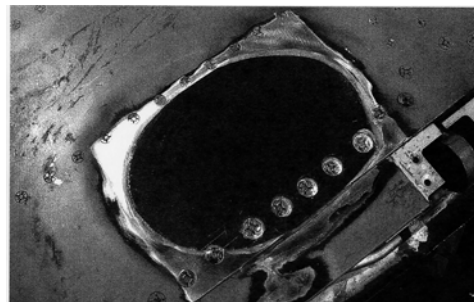

Figure 10: Wing Skin with Boron/Epoxy Patch.

7.0 BONDED REPAIRS OF COMPOSITE STRUCTURES

Repairs of composite materials are similar to those for metallic materials for mechanically fastened repairs. However, the repairs of composite materials are different from those of metals for bonded repairs. Bonded repairs are stronger than bolted repairs due to more uniform load transfer through the joint compared to bolted repairs where load transfer is at discrete points. Bonded repairs do not have stress concentrations as in bolted repairs, and are usually lighter. A bonded repair has more aerodynamic smoothness. Major advantages of using bolted repairs are- less equipment, facilities and personnel skills as compared to bonded repairs. The major steps involved in bonded repairs are discussed here

7.1 Selection of Repair Method

The selection of a repair method for a damage situation is matter of judgment due to variables such as damage size and shape, structural configuration, and accessibility (Ref. 22-23). The criteria to be met by a repair are based on the damaged component, capabilities of repair facility, availability of time and material, and personnel skills. Procedures discussed here are not intended to replace repair techniques discussed in Structural Repair Manuals (SRM) for a particular aircraft. Sometimes damage configurations

are not covered by SRM and maintenance engineering personnel have to make decisions on repairs. Guidelines provided here are intended to assist these personnel in making repair decisions

A check list is prepared to identify the repair criteria to be met. The following requirements provide the guidelines:

- Strength, stiffness, stability and durability.
- Aerodynamic smoothness
- Weight (or mass) balance for control surfaces.
- Service temperature of the component
- Service environment
- Effect of repair on operating systems such as fuel tank, sealing etc.

7.1.1 Flush Patch versus External Patch

External repairs are faster and cheaper than flush repairs. For large area repairs, a flush patch is desirable as load path eccentricity is minimized with a flush patch and maximum strength and durability are achieved. A flush repair minimizes changes in the stiffness of the repaired component and is smoother and lighter than external patch, hence, ideal for control surfaces. In honeycomb construction where skins are generally thin and are stabilized by the core, an external patch is acceptable.

7.1.2 Cured-in-Place versus Pre-cured Repair Patch

Tests have shown that cured-in-place or cocured patch results in significantly higher strength of the repaired part as compared to precured patch. Precured patches are easier to use but may have fit-up problems and are not suited for curved surfaces.

A cured-in-place patch must be staged or partially cured in advance to get a void free patch. Complex structural details or the presence of substructure can act as a heat sink and degrade the quality of cocured repair. However, for large area repairs cocured repairs are recommended.

7.1.3 Scarf Joints versus Step-Lap Joints

Well-made step-lap and scarf joints have similar strength. A typical scarf repair is shown in Figure 11. The patch material is within the thickness to be repaired, with additional external plies added for strength. This configuration can restore more strength than an external patch as it avoids the eccentricity of the load path and provides smooth load transfer through gradually sloping scarf joint. A properly designed scarf joint can usually develop the full strength of an undamaged panel. The patch material is usually cured in place, and therefore must be supported during cure. While the patch material can be cured and then later bonded in place, it is generally difficult to get a good fit between the precured patch and the machined opening.

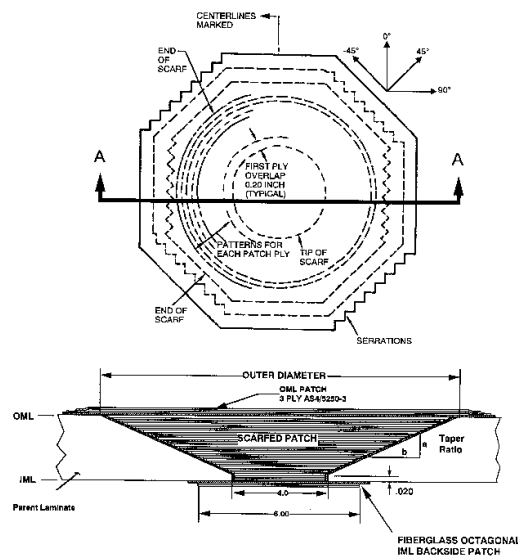

Figure 11: Scarf Joint Repair.

A step-lap joint has the advantage of idealized ply orientations on each step for maximum load transfer for a specified loading direction. The steps allow the load to be transferred between specific plies of the patch and parent material. This advantage increases the joint strength; however, it is offset by the peaks in the adhesive shear stress at the end of each step. This repair concept is shown in Figure 12. Additional external plies are added on the surface for strength.

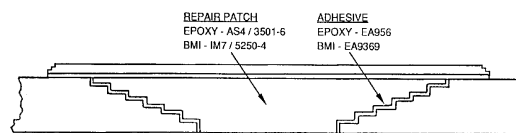

Figure 12: Step-Lap Repair.

A disadvantage of step-lap joint is the difficulty in machining the steps to the depth of the exact ply that is desired on the steps. This is a time consuming process and unrealistic for curved surfaces.

7.2 Repair Design and Analysis

Repair design involves selection of materials, repair configuration, analysis, and repair procedures. Design guidelines are briefly discussed here.

7.2.1 Design

The following guidelines are provided for the repair design (Ref. 22-23):

- Minimize the bending effects and peel stresses by avoiding the eccentricity in the load path. If possible an internal doubler may be used to balance the repair. A backside doubler provides a tool surface and a vacuum seal for a cocured patch for structures having access on one side only.
- Minimize the stress concentration at the edge of a patch by tapering the thickness of the patch to a minimum at the edge or serrating the ends of external plies which are oriented in the direction of the load.

Repair Types, Procedures – Part I

- Locally stiff or soft spots that would change the load distribution in the repair should be avoided in the design. Match ply orientations in the patch with those of the original part.
- Surface plies should be at 45° to the primary load direction.
- Corner radii should be at least 0.5 inch (13 mm) when removing damaged material from the skin to minimize stress concentrations.
- Length of machined scarf should be at least 0.1 inch/ply (2.5 mm/ply) for efficient load transfer while keeping the size of the repair to a minimum. For highly loaded skins or sandwich face sheets, length of scarf should be kept at 0.125 inch/ply (3.18 mm/ply).
- Gaps between adhesive strips, shown in Figure 13 are used as paths to remove trapped air in the bondline.
- Prestage thick patches in “books” of plies, as shown in Figure 14, to limit the maximum number of plies for good conformability.

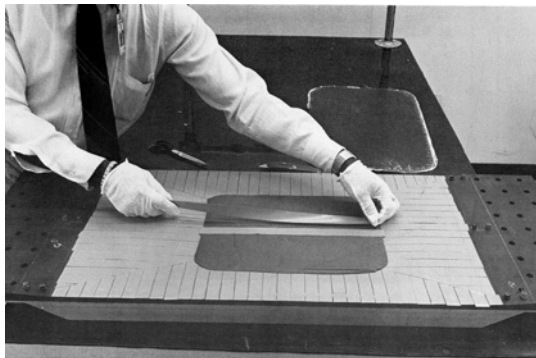

Figure 13: Gaps in Adhesive Strips.

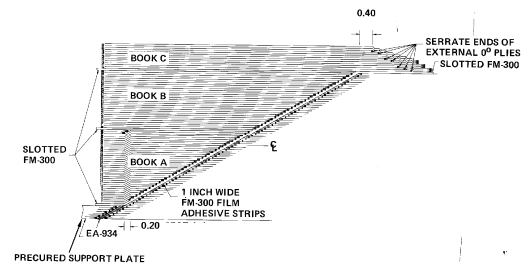

Figure 14: Books of Repair Patch Plies for Scarf Repair.

7.2.2 Analysis

The analysis methods for bonded joint repairs are not easy and are based on computational codes. These codes are not well suited for battle damage repair environments.

Step-lap joint analysis codes A4EG, A4EI, etc. are sometimes used to analyze a two-dimensional strip which is a cross-section through three-dimensional repair patch joint. These codes do not account for peel stresses in the analysis and adhesive is modeled as elastic-plastic material.

7.3 Repair Procedures

The following steps are adopted in performing repairs.

7.3.1 Damage Identification

In composites, the actual damage is generally larger than the visible damage due to matrix cracking and delaminations around the visible damage. The extent of actual damage is determined by NDI techniques as discussed in Subsection 5.1 and the extent of damage is clearly marked on the part for damage removal.

7.3.2 Damage Removal

Proper tools are necessary to remove the damage in composite without damaging any surrounding material or substructure. A clean opening is left after the damage removal. Figure 15 shows a hand held router used

to cut out damage material (Ref. 23). The operation on the aircraft may be done without a coolant. A carbide router bit with diamond shaped chisel-cut protrusions is effective at speeds of 1,000 to 6,500 surface feet (305m to 1981m) per minute. Diamond coated routers may also be used. Remove paint beyond scarfed surface for additional area to bond plies. Use light hand sanding with 80 grit paper and finish with 240 grit paper (Ref. 4)



Figure 15: Damage Removal with Hand Held Router.

7.3.3 Scarf Joint Machining

Scarf repairs are the most commonly used repairs. The material around the opening is machined to provide a scarfed surface which slopes from a feather edge at the opening to the full skin thickness at a specified distance from the opening edge. The distance from the opening edge is determined from the joint design.

Tools such as drum sander or disk sander can be used to machine a scarf surface. Machining of a scarf joint with a disk sander, attached to the end of an air-motor, is shown in Figure 16. Such an arrangement is especially useful for fairing in at corners.



Figure 16: Machining of Scarf Joint with Disk Sander.

7.3.4 Drying

Composite laminates with organic matrix materials absorb between 1 to 2 percent moisture by weight. Under normal service environment these materials are expected to have about 1 percent moisture. Moisture absorption causes reduction in the strength of composite materials. The presence of moisture can cause problems during the high temperature cure of a repair. If moisture is not removed, it may cause porosity in a bondline, in honeycomb construction it may cause skins to separate from the core, and it may

cause internal damage to the laminate. Drying before repair, which requires bonding at elevated temperature, is necessary. The amount of drying necessary before repair is not well established.

7.3.5 Patch Ply Preparation

A pattern of patch plies on vellum or Mylar is prepared as shown in Figure 11 (Ref. 4). The first patch ply should overlap the tip of the scarf by a minimum of 0.2 inch (5 mm). The patterns for the rest of the plies are traced from the machined surface of the joint. External plies are generally trimmed normal to the fiber direction with pinking shears to provide serrations for added strength (Figure 11).

Film adhesive is put on the surface of the patch that will be against the laminate being repaired. Do not trap air pockets between the adhesive and the patch. Adhesive is trimmed slightly larger than the largest patch ply

7.3.6 Bagging and Curing

For the repair of thick composite laminates or curved surfaces a prestage repair patch may be used. The cure cycle for prestage depends on the type of composite laminate and is developed from experience. A staged patch may be stored at room temperature in a sealed vacuum bag until cured in place on the damaged part.

Patch and adhesive are placed in position on the laminate being repaired, aligning the centerlines. Bleeder plies, breather plies and other layers are placed and vacuum bagged as per prescribed lay-up procedure. A typical bagging lay-up (Ref. 4) is shown in Figure 17. The patch and adhesive are cured using a heater blanket or an oven. For on the aircraft repair, care needs to be exercised to make sure that the temperature is maintained within specified limits for required duration. For large area repairs, surrounding structure acts as heat sink and separate heat blankets may be necessary. A typical cure cycle is shown in Figure 18.

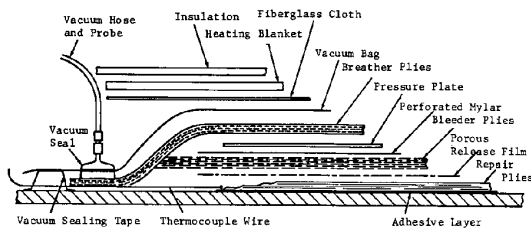

Figure 17: Schematic Cross-Section of a Bagging Lay-Up.

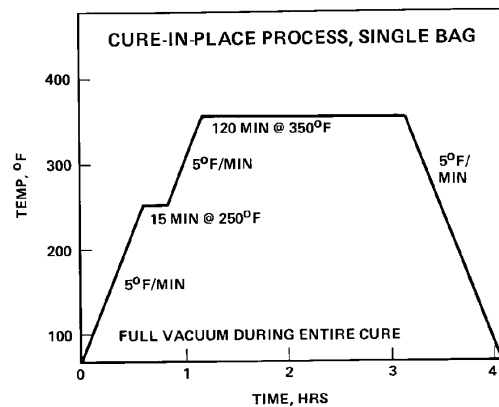

Figure 18: Typical Vacuum Bag Cure Cycle.

7.4 Repair Quality Acceptance

After a repair is completed, it is inspected to verify its integrity. An inspection is made to make sure that the repair is free of disbonds, blisters or other visually obvious defects. The bonded repairs are inspected by tap test by lightly tapping with a special hammer or a coin. A solid ringing indicates an acceptable repair, while a dead or flat sound generally indicates a disbond or delamination.

Nondestructive inspection of repairs can be made using the ultrasonic methods. The pulse echo A-scan is commonly used as it requires access from one side only. This technique is capable of locating disbonds,

delaminations and porosity (Ref. 4). The use of pulse echo A-scan technique requires the operator to interpret the results displayed on an oscilloscope. Hence, the accuracy of the results depends on the skill and experience of the operator. Standards with known disbond and flaw sizes are commonly used to interpret the results

8.0 REPAIR OF SANDWICH STRUCTURES

The repair of sandwich structure involves repair of core as well as repair of face sheets. The type of repair will depend on the extent of core damage i.e. if core is damaged to full depth or part-through the depth. The following steps are used in the repair of sandwich structures-

8.1 Drying

Honeycomb sandwich structures generally contain moisture in the form of liquid, vapor, or moisture absorbed in the composite face sheets and core. When heated for bonded repairs, the moisture trapped in cells can blow the skin off the core. The sandwich structures are dried before the repairs. The presence of liquid moisture can be identified using radiography

If liquid moisture is present in the cells, small holes are drilled to drain out the moisture (Ref. 4). The holes are then sealed with resin.

When no liquid moisture is present in the cells, drying of composite skins and removal of moisture vapor in the cells is recommended. The area to be heated is wrapped in coarse fiber glass cloth or any other suitable breather material. The area to be dried is enclosed in a vacuum bag and shop vacuum applied. The part is heated to 820C (1800F) and kept for about 48 hours depending on the part thickness.

8.2 Damage Removal

Damaged skin is removed with a router cutting slightly deeper than the face sheet thickness. The skin can be pulled away from the core with a plier or cut loose with a knife. The area of the core to be removed is then trimmed as shown in Figure 19. The section of the core to be removed is pulled away from the opposite side skin by pliers and the surface is made smooth with abrasive paper. A router may also be used to remove damaged core. After removing the core, the area is vacuumed and wiped with MEK.

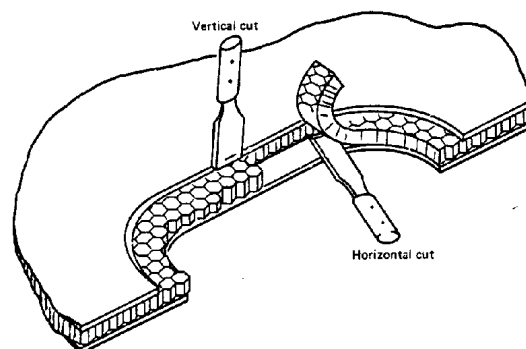

Figure 19: Removing Damage Core with Core Knife.

8.3 Core Repair

The new piece of core for the repair plug is cut from the stock with the ribbon thickness and cell size identical to the damaged core. The core plug should fit loosely, allowing room for foaming or paste

adhesive. The surface of the core plug which faces the skin should be potted with Epocast to a depth of 0.25 to 0.5 inch (6 to 12 mm) to prevent the dimpling of the face sheets to be bonded or cured in place.

The core plug is bonded to the inner skin with film adhesive such as FM-300 and the new core is bonded to the original core with a foaming adhesive such as FM-404 or paste adhesive such as EA-956MB as shown in Figure 20. Paste adhesive is used for thick sandwich structures as non-uniform foaming may occur with a heat source

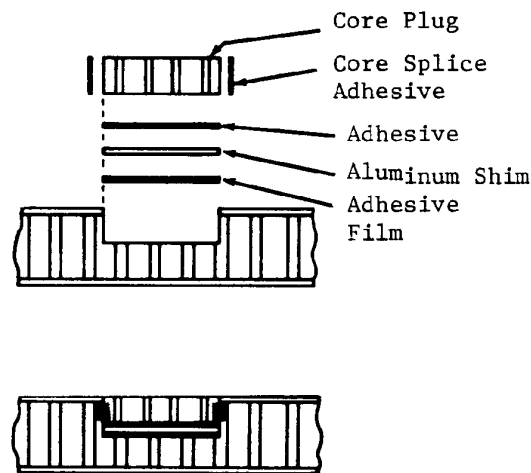

Figure 20: Core Repair (Partial Depth).

After bonding of the core, sand the surface of the plug with 320-grit abrasive paper until it is flush with the skin surface.

8.4 Bonding of Face sheets

The surface is cleaned properly for bonding of face sheets. The face sheets are bonded to the core plug by procedure outlined for composite repairs. Repair of full depth core damage and face skin is shown in Figure 21.

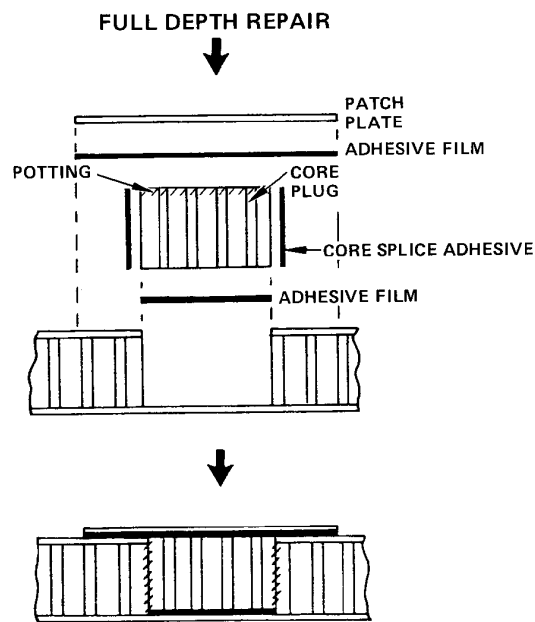

Figure 21: Full Depth Core and Skin Repair.

9.0 CONCLUDING REMARKS

Bonded repair techniques for monolithic and sandwich structures are discussed. The equipment required for the repairs is briefly described. Standard repairs are given in Structural Repair Manuals and guidelines given in these manuals should be followed. The procedures described here are intended to assist the repair personnel in carrying out non-standard repairs. It may be noted that not all the repair concepts, discussed here, may be suited for battle damage environment if necessary facilities, tools, and skilled personnel are not available.

Every step of repair process from damage identification to final inspection of a completed repair is important and can affect the integrity of a repair. It is important to follow each step precisely to assure high quality repairs.

10.0 REFERENCES

- [1] Holcomb D. H, "Aircraft Battle Damage Repair for 90s and Beyond", Research Report No. AU-ARI -93-4, CADRE/PT, Maxwell Air Force Base, Alabama 36112, March 1994.
- [2] Murray S. M, "Prepositioned Trailers for Aircraft Battle Damage Repair Support", Air Force Institute of Technology, Wright Patterson Air Force Base, Ohio, Report No. AFIT/GLM/ENS-04-13, March 2004.
- [3] Performance Specification- Technical Manuals: Aircraft Battle Damage Assessment and Repair, MIL-PRF-87158B, November 1996.
- [4] Ramkumar R. L, Bhatia N. M, Labor J. D and Wilkes J. S, "Handbook: An Engineering Compendium on the Manufacture and Repair of Fiber-Reinforced Composites", Prepared for Department of Transportation FAA Technical Center, Atlantic City International Airport, New Jersey, USA.

Repair Types, Procedures – Part I

- [5] Drieker R, Botello C, MacBeth S, and Grody J, “Aircraft Battle Damage Assessment and Repair (ABDAR), Vol. I: Executive Summary,” AFRL-HE-WP-TR-2002-0039, July 2000.
- [6] 6. Crum K, Drieker R, and Grody J, “Aircraft Battle Damage Assessment and Repair (ABDAR), Vol. II: Program Methodology,” AFRL-HE-WP-TR-2002-0039, July 2000.
- [7] Drieker R, Botello C, MacBeth S, and Grody J, “Aircraft Battle Damage Assessment and Repair (ABDAR), Vol. III: Field Test Report,” AFRL-HE-WP-TR-2002-0039, July 2000.
- [8] Dodd S. M, and Smith H. Jr., “Expert System for Design of Battle Damage Repairs”, Presented at 21st International SAMPE Conference, September 25-28, 1989.
- [9] Ratwani M. M, “Repair/Refurbishment of Military Aircraft” AGARD Lecture Series 206, Aging Combat Aircraft Fleets- Long Term Implications, 1996.
- [10] Ratwani M. M, “Repair Options for Airframes” AGARD Lecture Series 218, Aging Aircraft Fleets- Structural and Other Subsystem Aspects, Sofia, Bulgaria, November, 2000.
- [11] Ratwani M. M, Labor J. D, and Rosenzweig E, “ Repair of Cracked Metallic Aircraft Structures with Composite Patches,” Proceedings of the 11th International Conference on Aeronautical Fatigue, Holland, May 1981.
- [12] Baker A. A, “A Summary of Work on Applications of Advanced Fiber Composites at the Aeronautical Research Laboratory Australia,” Composites, 1978.
- [13] Belason E. B “Status of Bonded Boron/Epoxy Doublers for Military and Commercial Aircraft Structures,” AGARD Conference Proceedings 550, Composite Repair of Military Aircraft Structures, October 1994.
- [14] Heimerdinger M, Ratwani M. M, and Ratwani N. M, “Influence of Composite Repair Patch Dimensions on Crack Growth Life of Cracked Metallic Structures”, Proceedings of Third FAA/DoD/NASA Conference on Aging Aircraft, Albuquerque, New Mexico, September 1999.
- [15] Kuhbander R. J, “Characterization of EA9394 Adhesive for Repair Application”, Wright Laboratory Report No. WL-TR-92-4069, January 1994.
- [16] Ratwani M. M, Koul a. K, Immarigeon J. P, and Wallace W, “Aging Airframes and Engines”, Proceedings of Future Aerospace Technology in the Service of Alliance, Volume I-Affordable Combat Aircraft, AGARD-CP-600, 1997.
- [17] Helbling J, Grover R and Ratwani M. M “Analysis and Structural Test of Composite Reinforcement to Extend the Life of T-38 Lower Wing Skin”, Proceedings Aircraft Structural Integrity Conference, San Antonio, 1998.
- [18] Helbling J, Heimerdinger M and Ratwani M. M, “Composite Patch Repair Applications to T-38 Lower Wing Skin”, Proceedings of Second NASA/FAA/DoD Conference on Aging Aircraft, Williamsburg, Virginia, 1998.
- [19] Helbling J, Ratwani M. M and Heimerdinger M, “Analysis, Design, and Test Verification of Composite Reinforcement for Multi-site Damage “, Proceedings of 20th International Conference on Aeronautical Fatigue Symposium, Seattle, Washington, 1999.

- [20] Cockran J. B, Christian T and Hammond D. O, “C-141 Repair of Metal Structure by Use of Composites”, Proceedings of Aircraft Structural Integrity Conference, San Antonio, Texas, 1988.
- [21] Mazza J, “F-16 Fuel Vent Hole Repair Update”, Proceedings of Air Force Fourth Aging Aircraft Conference, Colorado, 1996.
- [22] Labor J. D, Button G. M, and Bhatia N. M, “Depot Level Repair for Composite Structures Development and Validation- Volume I”, Report No. NADC-79172-60, Volume I, March 1985.
- [23] Button G. M, and Labor J. D, “Depot Level Repair for Composite Structures Development and Validation- Volume II”, Report No. NADC-79172-60, Volume II, March 1985.

