



**NAVAL
POSTGRADUATE
SCHOOL**

MONTEREY, CALIFORNIA

THESIS

**THE IMPACT OF ARMOR ON THE DESIGN,
UTILIZATION AND SURVIVABILITY OF GROUND
VEHICLES: THE HISTORY OF ARMOR DEVELOPMENT
AND USE**

by

Chun Hong Kelvin Yap

September 2012

Thesis Co-Advisors:

Christopher Adams
Morris Driels

Approved for public release; distribution is unlimited

THIS PAGE INTENTIONALLY LEFT BLANK

REPORT DOCUMENTATION PAGE			<i>Form Approved OMB No. 0704-0188</i>
Public reporting burden for this collection of information is estimated to average 1 hour per response, including the time for reviewing instruction, searching existing data sources, gathering and maintaining the data needed, and completing and reviewing the collection of information. Send comments regarding this burden estimate or any other aspect of this collection of information, including suggestions for reducing this burden, to Washington headquarters Services, Directorate for Information Operations and Reports, 1215 Jefferson Davis Highway, Suite 1204, Arlington, VA 22202-4302, and to the Office of Management and Budget, Paperwork Reduction Project (0704-0188) Washington DC 20503.			
1. AGENCY USE ONLY (Leave blank)	2. REPORT DATE September 2012	3. REPORT TYPE AND DATES COVERED Master's Thesis	
4. TITLE AND SUBTITLE The Impact of Armor on the Design, Utilization and Survivability of Ground Vehicles: The History of Armor Development and Use		5. FUNDING NUMBERS	
6. AUTHOR(S) Chun Hong Kelvin Yap		8. PERFORMING ORGANIZATION REPORT NUMBER	
7. PERFORMING ORGANIZATION NAME(S) AND ADDRESS(ES) Naval Postgraduate School Monterey, CA 93943-5000		10. SPONSORING/MONITORING AGENCY REPORT NUMBER	
9. SPONSORING /MONITORING AGENCY NAME(S) AND ADDRESS(ES) N/A		11. SUPPLEMENTARY NOTES The views expressed in this thesis are those of the author and do not reflect the official policy or position of the Department of Defense or the U.S. Government. IRB Protocol number _____N/A_____.	
12a. DISTRIBUTION / AVAILABILITY STATEMENT Approved for public release; distribution is unlimited		12b. DISTRIBUTION CODE A	
13. ABSTRACT (maximum 200 words) Armor is a key component of ground vehicle survivability, as has been developed and redesigned throughout history in response to different threats and missions. This thesis aims to study and analyze the how armor has changed through major conflicts, from World War I to Operation Iraqi Freedom, and some of the driving factors that influenced those changes. This thesis would also do a discussion on the threats ground vehicles are expected to face and how they work, which has significant implications on how armor can be designed to defeat them or minimize the damage sustained as a result. Finally, this thesis would discuss the various aspects of armor design that can be looked at to reduce the vulnerability of a ground vehicle, and how they are characterized. This thesis also aims to set a foundation for the development of a ground vehicle survivability discipline in NPS in the future.			
14. SUBJECT TERMS Armor, Ground Vehicle Survivability		15. NUMBER OF PAGES 125	
		16. PRICE CODE	
17. SECURITY CLASSIFICATION OF REPORT Unclassified	18. SECURITY CLASSIFICATION OF THIS PAGE Unclassified	19. SECURITY CLASSIFICATION OF ABSTRACT Unclassified	20. LIMITATION OF ABSTRACT UU

THIS PAGE INTENTIONALLY LEFT BLANK

Approved for public release; distribution is unlimited

**THE IMPACT OF ARMOR ON THE DESIGN, UTILIZATION AND
SURVIVABILITY OF GROUND VEHICLES: THE HISTORY OF ARMOR
DEVELOPMENT AND USE**

Chun Hong Kelvin Yap
Military Expert 4, Army, Singapore Armed Forces
B.S., Cornell University, 2006

Submitted in partial fulfillment of the
requirements for the degree of

MASTER OF SCIENCE IN MECHANICAL ENGINEERING

from the

**NAVAL POSTGRADUATE SCHOOL
September 2012**

Author: Chun Hong Kelvin Yap

Approved by: Christopher Adams
Thesis Co-Advisor

Morris Driels
Thesis Co-Advisor

Knox T. Millsaps
Chair, Department of Mechanical and Aerospace Engineering

THIS PAGE INTENTIONALLY LEFT BLANK

ABSTRACT

Armor is a key component of ground vehicle survivability, as has been developed and redesigned throughout history in response to different threats and missions. This thesis aims to study and analyze the how armor has changed through major conflicts, from World War I to Operation Iraqi Freedom, and some of the driving factors that influenced those changes.

This thesis would also do a discussion on the threats ground vehicles are expected to face and how they work, which has significant implications on how armor can be designed to defeat them or minimize the damage sustained as a result.

Finally, this thesis would discuss the various aspects of armor design that can be looked at to reduce the vulnerability of a ground vehicle, and how they are characterized.

This thesis also aims to set a foundation for the development of a ground vehicle survivability discipline in NPS in the future.

THIS PAGE INTENTIONALLY LEFT BLANK

TABLE OF CONTENTS

I.	INTRODUCTION.....	1
A.	BACKGROUND - SURVIVABILITY.....	1
B.	IMPORTANCE OF ARMOR.....	1
C.	DEFINITION OF ARMOR.....	1
D.	AN OVERVIEW OF ARMORED VEHICLES.....	2
	1. Main Battle Tanks (MBTs).....	2
	2. Armored Personnel Carriers (APCs).....	3
	3. Infantry Fighting Vehicles (IFVs).....	4
	4. Self-Propelled Guns (SPGs).....	5
	5. Light Vehicles.....	5
	6. Other Platforms.....	6
II.	BEGINNINGS OF ARMOR DEVELOPMENT IN VEHICLES.....	7
A.	WORLD WAR I (WWI).....	7
	1. Need for Armor Development.....	7
	2. British Mk I Tank.....	8
B.	WORLD WAR II (WWII).....	9
	1. Anti-Tank Warfare.....	9
	2. German Armor Development.....	11
	3. Allied (British / American) Armor Development.....	12
	4. Soviet Armor Development.....	13
	5. Comparison of Armor vs Threats.....	14
C.	VIETNAM WAR.....	16
	1. Troop Protection and the M113 Armored Personnel Carrier.....	16
	2. The Effect of Mines.....	19
	3. Other Armor Battles.....	20
D.	ARAB-ISRAELI CONFLICT & 1982 LEBANON WAR.....	21
	1. Development of Explosive Reactive Armor (ERA).....	21
E.	OPERATION IRAQI FREEDOM / OPERATION ENDURING FREEDOM.....	23
	1. Improvised Explosive Devices (IEDs).....	23
	2. Protection of Light Vehicles (Humvees).....	23
	3. Protection of Heavy Vehicles (Strykers and M1 Abrams).....	24
F.	OTHER DEVELOPMENTS.....	26
	1. Composite Armor.....	26
	2. Applique Armor.....	27
G.	SUMMARY.....	27
III.	MISSION-THREAT ANALYSIS.....	29
A.	MISSIONS OF ARMORED VEHICLES.....	29
	1. Tactical Level.....	29
	2. Operational Level.....	29
	3. Support Operations.....	30

B.	OVERVIEW OF THREATS	30
1.	Small Arms	32
2.	Artillery	32
3.	Anti-Tank Weapons	33
4.	Armored Vehicles	34
5.	Aircraft	34
6.	Anti-Tank Mines	35
7.	Improvised Explosive Devices (IEDs)	35
C.	HOW KINETIC ENERGY WARHEADS WORK	35
1.	Armor Piercing, Composite, Rigid (APCR)	37
2.	Armor Piercing, Capped, and Ballistically Capped (APCBC)	37
3.	Armor Piercing, Discarding Sabot (APDS)	40
D.	HOW BLAST WARHEADS WORK	41
E.	HOW METALLIC JET WARHEADS (SHAPED CHARGES) WORK	41
1.	The Munroe Effect	41
2.	High Explosive, Anti-Tank (HEAT)	42
3.	High Explosive, Squash Head (HESH)	43
F.	PERFORMANCE OF MODERN ANTI-TANK WEAPONS	44
IV.	ANATOMY OF ARMORED VEHICLES	47
A.	CRITICAL TASKS AND KEY FUNCTIONAL AREAS	47
B.	PROPULSION COMPONENTS: POWERTRAIN, TRACKS / WHEELS	48
C.	CONTROL COMPONENTS: STEERING AND BRAKES	48
D.	FIREPOWER COMPONENTS: TURRET AND ARMAMENT	49
E.	PROTECTION COMPONENTS: HULL AND CHASSIS	49
F.	COMMUNICATIONS / NETWORKING	49
G.	KILL CRITERIA AND TYPICAL KILL TREE	50
H.	LOCATION OF ARMOR ON A GROUND VEHICLE	52
1.	Hull	52
2.	Turret	54
3.	Side Skirts	56
4.	Armor on Non-Traditional Armored Vehicles	57
V.	ARMOR DESIGN FOR VULNERABILITY REDUCTION	59
A.	OVERVIEW	59
B.	THREAT DIRECTION	60
C.	HULL DESIGN	62
1.	Thickness	62
2.	Sloping	64
3.	Material	66
4.	Explosive Reactive Armor (ERA)	68
5.	Slat Armor	70
D.	COMMON MODERN DAY STANDARDS	72
1.	MIL-STD 662F – V50 Ballistic Test for Armor	72

2.	NATO STANAG 4569 - Protection Levels for Occupants of Logistic and Light Armored Vehicles	73
VI.	CONCLUSION	75
A.	CONCLUSION	75
B.	WAY AHEAD	75
APPENDIX.	APPLICATION OF SURVIVABILITY ENHANCEMENT CONCEPTS IN GROUND VEHICLES	77
A.	OVERVIEW	77
B.	SUSCEPTIBILITY REDUCTION.....	77
1.	Noise Deceiving and Jamming	77
2.	Expendables.....	78
3.	Signature Reduction	78
4.	Threat Suppression.....	81
5.	Threat Warning	81
6.	Tactics	82
C.	VULNERABILITY REDUCTION	83
1.	Component Location	83
2.	Component Shielding.....	83
3.	Component Redundancy	85
4.	Component Elimination / Replacement	86
5.	Active Damage Suppression.....	86
6.	Passive Damage Suppression	87
D.	REPARABILITY ENHANCEMENT	88
1.	Overview	88
2.	Maintenance Sensing	90
3.	Forward Maintenance	91
4.	Recovery with Speed.....	92
5.	Modular Components.....	94
6.	Maintenance Supply Chain Resilience.....	96
7.	Component Repair	96
	LIST OF REFERENCES	97
	INITIAL DISTRIBUTION LIST	103

THIS PAGE INTENTIONALLY LEFT BLANK

LIST OF FIGURES

Figure 1.	M1A2 Abrams MBT (From IHS Jane’s 2011).....	3
Figure 2.	An M113A3 APC Used by the U.S. Army (From IHS Jane’s 2011).....	3
Figure 3.	An M2 Bradley IFV (From IHS Jane’s 2011).....	4
Figure 4.	M109A6 Paladin Self-Propelled Howitzer (From IHS Jane’s 2012).....	5
Figure 5.	A M1151 Mounted with the Frag Kit 6, an Example of an Up-Armored Light Vehicle (From IHS Janes’s 2012).....	6
Figure 6.	A Mk V Tank Crossing a Trench (From “Mk V Walkaround”).....	8
Figure 7.	Comparison of German Armor Thickness with Respect to Soviet Armament (After Hogg 1980 and Mackasey 1988).....	11
Figure 8.	Performance of Various Tanks / Field Guns Against Each Other (From Macksey 198, 78).....	14
Figure 9.	Performance of Various Tanks / Field Guns Against Each Other (From Macksey 1988, 102).....	15
Figure 10.	A Typical M113 Operated by the South Vietnamese Army (Shown without Gun Shield) (From Starr 1980, 23).....	17
Figure 11.	A M113 with a Gun Shield Modification (From Starr 1980, 74).....	18
Figure 12.	An M113 with Hits from a Viet Cong 57mm Recoilless Rifle (From Starr 1980, 46).....	19
Figure 13.	An Israeli Tank Column Led by a Magach Mounted with Explosive Reactive Armor (From Cooper et al 2003).....	22
Figure 14.	A Damaged Magach 6 During the 1982 Lebanon War (From Cooper et al 2003).....	22
Figure 15.	Armor Plate Doors Mounted on the Humvee as Part of the ASK (From U.S. Army (TACOM) 2004, 5).....	23
Figure 16.	A Stryker IFV Mounted with Slat Armor (From Defense Update Jan 2006).....	24
Figure 17.	A Husky Mk III. Notice the Sloped Bottom Hull, an Example of the V-Shaped Hull (From Critical Solutions International, 2012).....	25
Figure 18.	An M1 Abrams MBT Mounted with a TUSK (From Defense Update Dec 2006).....	26
Figure 19.	A Challenger 2 MBT (From IHS Jane’s 2012).....	27
Figure 20.	Graph Depicting Increase of Armor Thickness through Time (After Steeb, Brendley, Norton, Bondanella, Salter and Covington, 1991, 3).....	28
Figure 21.	Summary of Threats Faced by an Armored Vehicle (From a Abrams Tank System Survivability Briefing in Jan 2012).....	31
Figure 22.	Breakdown of Threats into Delivery Mechanisms, Propagators and Damage Mechanisms.....	32
Figure 23.	An RPG-7 Rocket Launcher (From IHS Jane’s 2011).....	33
Figure 24.	A Soldier Firing the Spike ATGM (From IHS Jane’s 2011).....	34
Figure 25.	Figure Showing the Composition of a APCBC Round (a) and how it Penetrates Armor (b) (From Weeks 1975, 13).....	38
Figure 26.	Normal Armor Penetration vs Range of Rounds Fired from the German 88mm L/71 Gun (From Ogorkiewicz 1968, 60).....	39

Figure 27.	Figure Showing the Structure of an APDS Round (a) and the Sabots Discarding at the Muzzle (b) (From Weeks 1975, 14)	40
Figure 28.	A Typical Metallic Jet Warhead (a) and the Metallic Jet Burning through Armor (b) (From Weeks 1975, 15)	41
Figure 29.	Armor Penetration of Shaped Charges versus Stand-off Distance (From Ogorkiewicz 1968, 65).....	42
Figure 30.	Armor Penetration Variation with Warhead Type (After Norris 1996)	45
Figure 31.	Key Functional Areas of M1A1 Abrams Tank (From Cooke 2008)	48
Figure 32.	Comparison of Tracked (Left) (From Cooke 2008) and Wheeled (Right) (From Cooke 2009) Propulsion Systems	48
Figure 33.	Illustration of Traditional Turret Mounted Gun (Left) (From Zimbio, n.d.) vs Remote Controlled Weapon Station (Right) (From Ministry of Defence, Singapore 2009)	49
Figure 34.	Example of Kill Tree for Mobility Kill.....	50
Figure 35.	Example Kill Tree for Firepower Kill	51
Figure 36.	A British Mk I Tank (From Kempf, n.d.)	52
Figure 37.	Side and Bottom Plan Drawings of British Mk I Tank (From Kempf, n.d.) ...	53
Figure 38.	Front and Rear Plan Drawings of British Mk I Tank (From Kempf, n.d.)	53
Figure 39.	An AMX-13 Light Tank (Note the Sloped Front Side of the Turret) (From IHS Jane's 2012).....	55
Figure 40.	A Merkava Mk 3 MBT (From IHS Jane's 2012)	56
Figure 41.	A Jordanian Centurion MBT (Note the Side Skirt) (From IHS Jane's 2012)	56
Figure 42.	A Challenger 2 MBT (Note the Thicker Side Skirt) (From IHS Jane's 2012)	57
Figure 43.	Figure Showing the Behaviour of Different Types of Warheads on Normal Armor (From Macksey 1988, 154)	59
Figure 44.	Vertical Threat Envelope (From a Abrams Tank System Survivability Briefing in Jan 2012)	60
Figure 45.	Hit Probability Variation with Angle from Front of Vehicle (From Steeb, Brendley, Norton, Bondanella, Salter and Covington, 1991, 12)	61
Figure 46.	Probability of Hit on Two-Man MBT from Tank Gun at 1km Range (From Steeb, Brendley, Norton, Bondanella, Salter and Covington, 1991, 21)	61
Figure 47.	Typical Hull Dimensions Model (From Steeb, Brendley, Norton, Bondanella, Salter and Covington, 1991, 15).....	63
Figure 48.	Effects of Inclining Armor on Effective Thickness (From Ogorkiewicz 1968, 83)	64
Figure 49.	A Demonstrator Model of the Marine Personnel Carrier (MPC). Notice the V-shaped Hull at the Bottom of the Vehicle. (From Lamothe 2010)	66
Figure 50.	Figure Showing the Behavior of Different Warheads on Chobham Armor (From Foss 1977, 430).....	68
Figure 51.	How Explosive Reactive Armor Works (From Berkholz 2009)	69
Figure 52.	How Slat Armor Defeats an RPG Round (From Novel Defence Engineering 2012).....	71

Figure 53.	A Rear View of the Merkava Mk III. Notice the Curtain of Chain Links Hanging from the Turret. (From Army-technology.com 2011)	72
Figure 54.	Smoke Concealment Using SGLs (Left, Circled) (From Army Recognition Magazine 2007) and Exhaust Systems (Right) (From DefenseImagery.mil, n.d.)	78
Figure 55.	Reduction of Visual Signature: M1A2 Abrams (left) in a Desert Environment (From U.S. Army 2011) vs Terrex Infantry Carrier Vehicle (Right) in a Jungle Environment (From Ministry of Defence, Singapore 2009).	79
Figure 56.	IR Signature of M1A1 Abrams MBT without (1) and with (2) Anti-Thermal Paint (From Crane 2005).....	80
Figure 57.	Crew Layout inside the M1A1 Abrams, Showing the Reclined Driving Position (From Cooke 2008).....	81
Figure 58.	T-72 Tank with Reactive Armor (From Federation of American Scientists 2000)	85
Figure 59.	An Example of Airless Tyre Installed on a Humvee (From Greenemeier 2008)	88
Figure 60.	Repair Process Chain	88
Figure 61.	A TMTV (Left) Performing Field Repairs (From Ministry of Defence, Singapore 2012).....	92
Figure 62.	The Buffel Armored Recovery Vehicle (ARV), a Variant of the Leopard 2 MBT (From IHS Jane's 2012)	93
Figure 63.	Recovery Variant of the Bionix IFV (From IHS Jane's 2011).....	93
Figure 64.	A Buffel ARV Hooking up an Incapacitated Leopard 2A4 MBT Using the Combat Recovery Device (From Ministry of Defence, Singapore 2012)	94
Figure 65.	Removal of a Leopard 2 MBT Turret (From The Armor Site, n.d.).....	95
Figure 66.	Buffel ARV Lifting a Leopard 2 MBT Engine (From Defense Industry Daily 2012)	95

THIS PAGE INTENTIONALLY LEFT BLANK

LIST OF TABLES

Table 1.	British Tank Casualties after First Day of Cambrai Offensive (After Macksey 1980, 34).....	8
Table 2.	Tank Production During WWII (After Ogorkiewicz 1968, 36)	9
Table 3.	Comparison of Major German and Soviet Tanks in WWII (After Hogg 1980 and Mackasey 1988)	10
Table 4.	Overview of German Tank Development During WWII (After Hogg 1980 and Mackasey 1988)	11
Table 5.	Overview of Allied Tank Development During WWII (After Hogg 1980 and Mackasey 1988)	12
Table 6.	Overview of Soviet Tank Development During WWII (After Hogg 1980 and Mackasey 1988)	13
Table 7.	Personnel Losses Comparison Between Viet Cong and South Vietnamese Army (2 M113 Companies) Between 11 Jun-30 Sep 1962 (After Starr 1980, 22)	16
Table 8.	Vehicle Losses Due to Mines (After Starr 1980, 79).....	19
Table 9.	Armored Vehicle Losses during Operation LAM SON 719 (After Starr 1980, 193)	20
Table 10.	Vehicle Losses Against AT3 Sagger Missiles (After Starr 1980, 210)	21
Table 11.	Penetration Depth by Shaped Charge through Typical Armor Materials.....	43
Table 12.	Summary of Warhead Type and Performance of Various Anti-Tank Weapons (After Norris 1996)	45
Table 13.	Critical Tasks and Key Functional Areas of Armored Vehicles.....	47
Table 14.	Armor Location Based on Vehicle Components	52
Table 15.	Tensile Strength and Brinell Hardness of Typical Armor Materials	67
Table 16.	Protection Level Criteria for STANAG 4569 (From CRAIG International Ballistics 2012)	73
Table 17.	Survivability Enhancement Concepts	77
Table 18.	Reparability Enhancement Concepts	90

THIS PAGE INTENTIONALLY LEFT BLANK

LIST OF ACRONYMS AND ABBREVIATIONS

ACAV	Armored Cavalry Assault Vehicle
AFES	Automatic Fire Extinguishing System
ALWCS	Advanced Laser Warning Countermeasure System
AP	Armor Piercing
APC	Armored Personnel Carrier
APCBC	Armor Piercing, Capped and Ballistically Capped
APCR	Armor Piercing, Composite, Rigid
APDS	Armor Piercing, Discarding Sabot
APFSDS	Armor Piercing, Fin Stabilized Discarding Sabot
ARL	Army Research Laboratory
ARV	Armored Recovery Vehicle
ASK	Armor Survivability Kit
ATGM	Anti-Tank Guided Missile
ATTC	All Terrain Tracked Vehicle
CBM+	Condition-Based Maintenance Plus
C3	Command, Control and Communications
ERA	Explosive Reactive Armor
HE	High Explosive
HEAT	High Explosive, Anti-Tank
HESH	High Explosive, Squash Head
IED	Improvised Explosive Device
IFV	Infantry Fighting Vehicle
IR	Infrared

LRU	Line Replacement Unit
MBT	Main Battle Tank
NATO	North Atlantic Treaty Organization
OEF	Operation Enduring Freedom
OIF	Operation Iraqi Freedom
RHA	Rolled Homogeneous Armor
RPG	Rocket Propelled Grenade
SGL	Smoke Grenade Launcher
SPG	Self-Propelled Gun
SRU	Shop Replaceable Unit
STANAG	Standard Agreement
TMTV	Tracked Maintenance Task Vehicle
TUSK	Tank Urban Survivability Kit
UAV	Unmanned Aerial Vehicle
WDS	Weapon Detection System
WWI	World War I
WWII	World War II

ACKNOWLEDGEMENTS

First and foremost, I would like to express my deepest gratitude to Professor Christopher Adams and Professor Robert Ball for giving me the opportunity to help lay a foundation for the discipline of ground vehicle survivability. Your support and guidance has provided me with the motivation and strength to achieve this task. This gratitude is extended to Professor Morris Driels, who provided me with the necessary guidance to make this thesis more robust.

Special thanks to the authors of various books and references, which have provided extremely useful information throughout the course of this thesis. Special mention goes out to Mr Christopher Cardine from General Dynamics Land Systems, whose experience and expertise in this field was evident during our discussions.

My gratitude is also extended to ME7 Hung Ching Pien and LTC Adrian Toh of the Singapore Armed Forces, who put their faith in me, providing me with the opportunity to further my knowledge for the good of the defence of Singapore.

Last, but not least, to my fiancée Carol, whose love and support willed me to put forth my best effort in the course of my studies.

THIS PAGE INTENTIONALLY LEFT BLANK

I. INTRODUCTION

A. BACKGROUND - SURVIVABILITY

The discipline of survivability has been an area of emerging interest in recent decades, particularly for the combat aircraft. For ground vehicles, however, there has been a rising interest in the survivability concepts-susceptibility reduction, vulnerability reduction and maintainability enhancement—and their influence on the design and functions of ground vehicles. One of the key tenets of ground vehicle survivability is component shielding, which is largely influenced by armor.

B. IMPORTANCE OF ARMOR

The importance of armor has been evident ever since Man was involved in conflicts and wars. In order to protect themselves against injury from the enemies' weapons, soldiers realized the need to protect themselves with clothing made from stronger materials. This need for protection has also been applied to equipment and vehicles. With the introduction of the British Mark I tank during World War I, armored operations have become an integral part of land warfare.

The development of new and more lethal weapons to defeat armor has resulted in developments in armor applications as well. Be it the choice of materials or the overall hull shape, armor development has and will continue to meet the threats of the day.

The purpose of this thesis is to provide a historical background of armor development and use on ground vehicles, and the way ahead in the future.

C. DEFINITION OF ARMOR

The Oxford English Dictionary defines armor as:

“The steel or other metallic protective sheathing of a warship, military fortification, vehicle or aircraft.”

In this thesis, the word “armor” shall essentially refer to the protective layer that is mounted on a vehicle to prevent damage to its components or injuries to its occupants.

With the advancement in materials science, especially the development of ceramics, armor may or may not be metallic in this sense.

D. AN OVERVIEW OF ARMORED VEHICLES

Despite the common use of the term “armored vehicles” in the thesis, it must be recognized it is a collective term that refers to automotive platforms that have additional armor protection mounted, beyond what is typically expected of a vehicle. In general, armored vehicles can be classified into main battle tanks, infantry fighting vehicles, armored personnel carriers and self-propelled guns. While the principal considerations for armor development and selection may apply for all these platforms, each class of armored vehicles may have its own set of special requirements due to its unique missions or threats.

1. Main Battle Tanks (MBTs)

MBTs provide the main firepower for an armored force on the battlefield. Since MBTs are usually employed to take out other enemy tanks or key installations, they are typically equipped with very heavy armament (greater than 90mm) and thick armor on all sides. In order to carry and operate the heavy armament and armor, an MBT requires a large engine and sizeable crew. Consequently, MBTs are very large in size and can thus present a significant visual and / or infrared (IR) signature on the battlefield.



Figure 1. M1A2 Abrams MBT (From IHS Jane's 2011)

2. Armored Personnel Carriers (APCs)

As the name implies, APCs are armored vehicles that provide troop transport capabilities for armies, similar to transport trucks, except that their armored skin allows for better troop protection than soft-skinned vehicles. APCs may be armed with some light armament, such as small-caliber cannons and machine guns, for self-protection.



Figure 2. An M113A3 APC Used by the U.S. Army (From IHS Jane's 2011)

APCs are usually designed with a compartment in the rear to house the fighting troops, while the actual operating crew of the vehicle is located in the front or in the turret (if any). Despite that, APCs are expected to be smaller in size when compared to MBTs, in order to reduce susceptibility and improve mobility through tight terrain.

3. Infantry Fighting Vehicles (IFVs)

IFVs provide the same function and support to combat troops as APCs, but differ in that they are designed to carry men about the battlefield and be a part of the tank / infantry team (Foss 1977, 190). Since IFVs typically provide fire support for the dismounted troops as well, they are usually equipped with heavier armament (>20mm cannons and possibly ATGMs). In terms of armor protection, both APCs and IFVs tend to be designed with not-so-heavy threats in mind, such as infantry weapons and, to an extent, anti-tank weapons. However, they must also balance the armor protection with the effects on mobility, as these vehicles are expected to be very mobile on the battlefield so that they can quickly transport troops.



Figure 3. An M2 Bradley IFV (From IHS Jane's 2011)

4. Self-Propelled Guns (SPGs)

SPGs are essentially artillery howitzers mounted on automotive platforms, typically based on existing MBT or IFV chassis. Since MBTs are already large and heavy to start with, the addition of even heavier armament, such as 155mm howitzer guns, SPGs are normally larger and heavier, thus resulting in a larger signature than normal.



Figure 4. M109A6 Paladin Self-Propelled Howitzer (From IHS Jane's 2012)

5. Light Vehicles

These vehicles refer to vehicles that were originally designed and built as soft-skinned platforms, and hence did not come with any form of armor protection to start with. However, they have become an emerging area of interest in recent conflicts, such as the Iraq / Afghanistan conflicts, due to their vulnerability to improvised explosive devices (IEDs). Such vehicles will tend to be retrofitted with armor (permanent or temporary) as an additional layer of protection against threats. Humvees make up a majority of such a class of vehicles.



Figure 5. A M1151 Mounted with the Frag Kit 6, an Example of an Up-Armored Light Vehicle (From IHS Janes's 2012)

6. Other Platforms

The previously mentioned classes of armored vehicles make up the majority of such vehicles today. However, there are also other classes of armored vehicles, such as anti-air platforms and reconnaissance vehicles, which are normally based on the same platform designs as existing vehicles. Such vehicles will not be discussed in depth in this thesis.

II. BEGINNINGS OF ARMOR DEVELOPMENT IN VEHICLES

More often than not, the development of armor in vehicles, and tanks in general, is in response to the threats of the day. Coupled with other factors such as the change in warfare and tactics, these resulted in a progressive development of armor through the ages. In order to understand the principles and considerations of armor selection and design, it is necessary to review the growth of armor through key conflicts in modern history.

A. WORLD WAR I (WWI)

1. Need for Armor Development

The large extent of trench warfare during WWI meant that very little ground could be gained with infantry forces despite the high attrition rates. Essentially, the battlefields of WWI posed two key challenges to the Allied forces:

- Protection. WWI marked the widespread use of the machine gun by the infantry. In land warfare, they were mainly deployed to provide defensive cover for against advancing troops. The Germans were known to be deploying the Maschinengewehr 08 (MG 08) machine gun, which fired 7.7mm rounds. The lethality of the machine gun thus provided an impetus to use armor for troop protection. However, it could not be simply an addition of armored plating on trucks, as they were met with another obstacle.
- Mobility. The trenches that soldiers fought in during that period were wide, and covered with barbed wire obstacles. This meant that wheeled simply could not cross the trenches.

Both the protection and mobility requirements thus resulted in the introduction of arguably the first modern iconic armored vehicle – the British Mk I tank and its variants.



Figure 6. A Mk V Tank Crossing a Trench (From “Mk V Walkaround”)

2. British Mk I Tank

The Mk I was known to have armor 10mm thick at the front, 8mm at the sides and 6mm on the top (Hogg 1980, 17). The survivability of the tank can be seen in the first tank offensive in Cambrai in November 1917, when 476 tanks of the British Tank Corps gained 4 miles of ground against 1,003 German artillery guns. The outcome of the offensive is as follows:

Total Tanks	476
Direct Hits from Artillery	65 (13.66%)
Ditching and Mechanical Failure	114 (23.95%)
Remaining Tanks	297 (62.39%)

Table 1. British Tank Casualties after First Day of Cambrai Offensive (After Macksey 1980, 34)

More significantly, the infantry losses were approximately 4000, as compared to 400000 casualties in a similar advance at Third Ypres, which demonstrates the importance of armor not just as an enhancement to vehicle survivability, but also soldier survivability.

At that point in time, the only weapon that was designed as an anti-tank gun was the Mauser 13mm rifle, although modifications made to 7.7cm and 7.62cm Russian field guns allowed them for anti-tank use as well (Haythornthwaite, 1993, 97).

B. WORLD WAR II (WWII)

1. Anti-Tank Warfare

WWII saw the rapid build-up of tank production by both the Allied and Axis forces, as illustrated below:

	Germany	Britain	USA	Russia
1939	249	969	?	?
1940	1,460	1,399	331	2,794
1941	3,256	4,841	4,052	6,590
1942	4,278	8,611	24,997	24,668
1943	5,966	7,476	29,497	20,000
1944	9,161	?	17,565	17,000

Table 2. Tank Production During WWII (After Ogorkiewicz 1968, 36)

The increasing production numbers as the war progressed was not just due to the need to replace destroyed tanks, but also due to rapid development and improvements in response to anti-tank threats from both sides.

- Anti-Tank Weapons. Other than artillery shells that resulted in tank kills in WWI, WWII also saw the widespread introduction of anti-tank guns and infantry anti-tank weapons. Just like how the forces in WWI needed to protect themselves from machine gun fire, the various nations had to redevelop their armor to survive hits.
- Heavier Tank Armament. A miniature arms race developed during WWII, where opposing sides improved their firepower to counter armor threats, resulting in the improvement of armor (in terms of thickness and design).

Looking at the size of the guns on the tanks on both sides, as well as the armor characteristics, we can see an increasing trend in both aspects.

Germany			Soviet Union		
Tank	Main Armament	Armor	Tank	Main Armament	Armor
Panzer I	2 x 7.92mm	7–13mm	T-26	45mm gun	6–15mm
Panzer II	2cm cannon	10–14mm then 15–35mm	T-34 Model 42	76.2mm gun	47–65mm
Panzer III	37/50mm gun	30–50mm	KV	76.2mm gun	90–120mm
Panzer IV	75mm gun	10–80mm	T-44	85mm gun	120mm
Panther	75mm gun	15–120mm	T-34/85	85mm gun	47–90mm
Tiger I	88mm gun	60–100mm	IS2	122mm gun	95–160mm
Tiger II	88mm gun	80–180mm			

Table 3. Comparison of Major German and Soviet Tanks in WWII (After Hogg 1980 and Mackasey 1988)

As can be seen from Table 3, there was a steady increase in both gun calibre and armor thickness, thus showing the development of armor as a response to more lethal threats.

2. German Armor Development

Tank	First Production	Total Produced	Remarks
Panzer I	1934	1500	
Panzer II	1935	1856?	
Panzer III	1935	5500+?	
Panzer IV	1936	8000+?	
Panther	1942	6000	Response to T-34
Tiger I	1942	1350	Response to T-34
Tiger II	1943	4380	

Table 4. Overview of German Tank Development During WWII (After Hogg 1980 and Mackasey 1988)

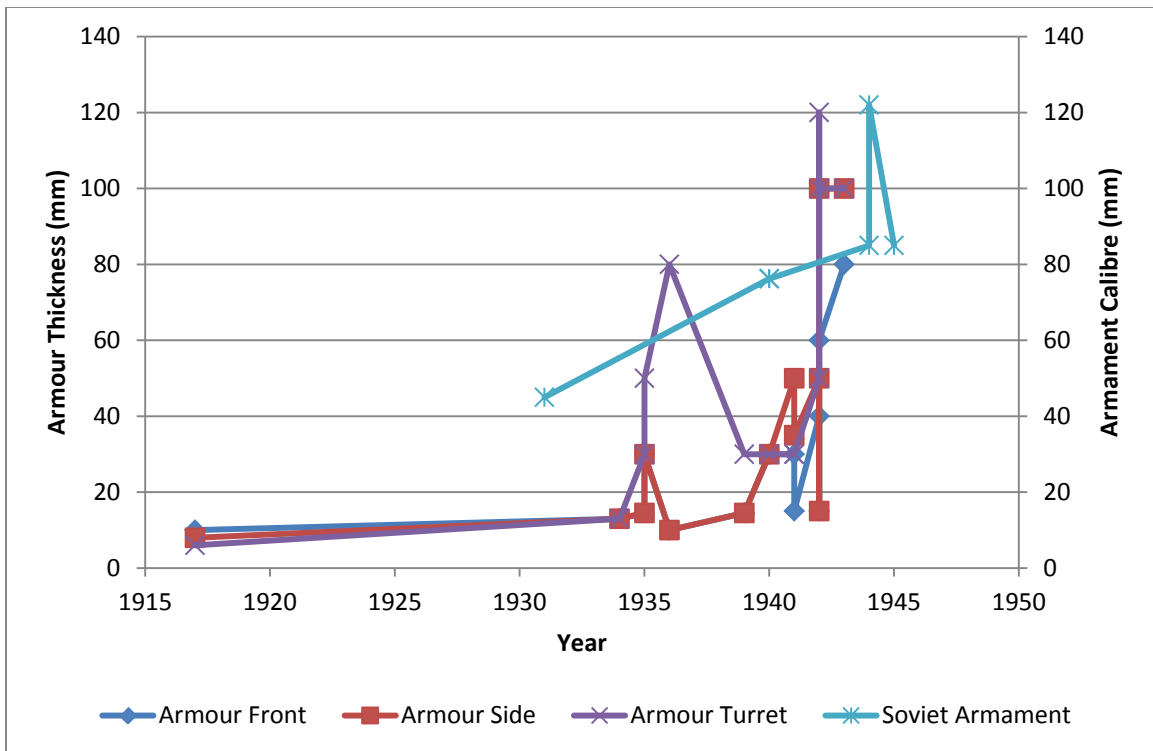

Figure 7. Comparison of German Armor Thickness with Respect to Soviet Armament (After Hogg 1980 and Mackasey 1988)

3. Allied (British / American) Armor Development

Country	Tank	First Production	Total Produced	Remarks
USA	M3 General Stuart	1941	14000	37mm gun
	M3 Lee	1941	7400	75mm gun
	M4 Sherman	1942	41530	75mm gun, 85mm armor (Macksey 1988, 103)
	M26 Pershing	1944	20?	90mm gun, comparable to Tiger II
UK	Matilda II	1939	2990	
	Crusader I	1941	4750	
	Crusader II	1941	?	
	Valentine II	1941	8280	
	Churchill VII	1942	5640	Mounted with 75mm gun
	Cromwell IV	1943	3000	
	Comet	1944	?	Mounted with 77mm gun

Table 5. Overview of Allied Tank Development During WWII (After Hogg 1980 and Mackasey 1988)

4. Soviet Armor Development

Tank	First Production	Total Produced	Remarks
T-26	1931	1660–1717	
T-34	1940	34780	
KV	1940	4515	T-35 Replacement
IS2	1943	4204	Response to Tiger II
T-44	1945	200	

Table 6. Overview of Soviet Tank Development During WWII (After Hogg 1980 and Mackasey 1988)

From the above table, one of the key areas of interest is the development of the IS2 as a response to the presence of the German Tiger II. First, it was recognized that the 122mm round would be more effective in penetrating the 80–180mm thick armor of the Tiger II, compared to the 76.2mm round. Next, it was also recognized that 47–90mm armor of the T-34 was no match for the 88mm round, hence resulting in the thickening of armor to a minimum of 95mm.

5. Comparison of Armor vs Threats

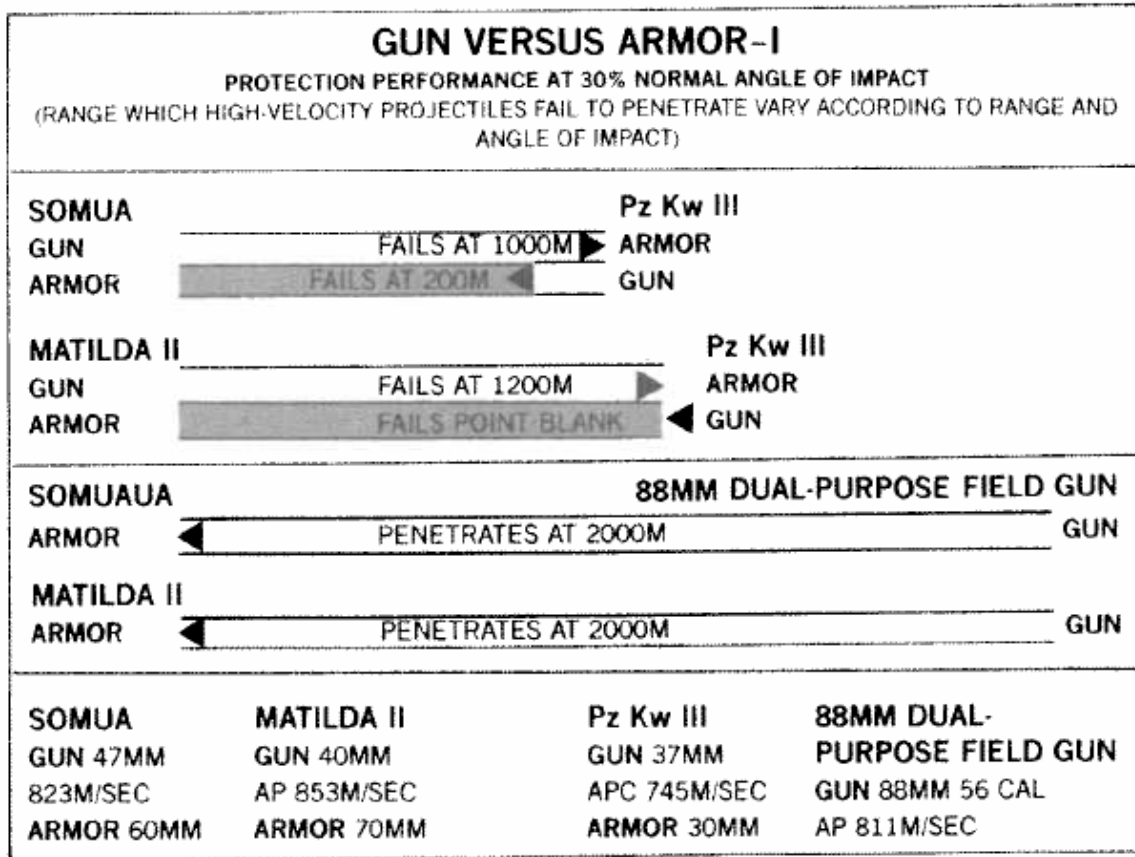

Figure 8. Performance of Various Tanks / Field Guns Against Each Other (From Macksey 198, 78)

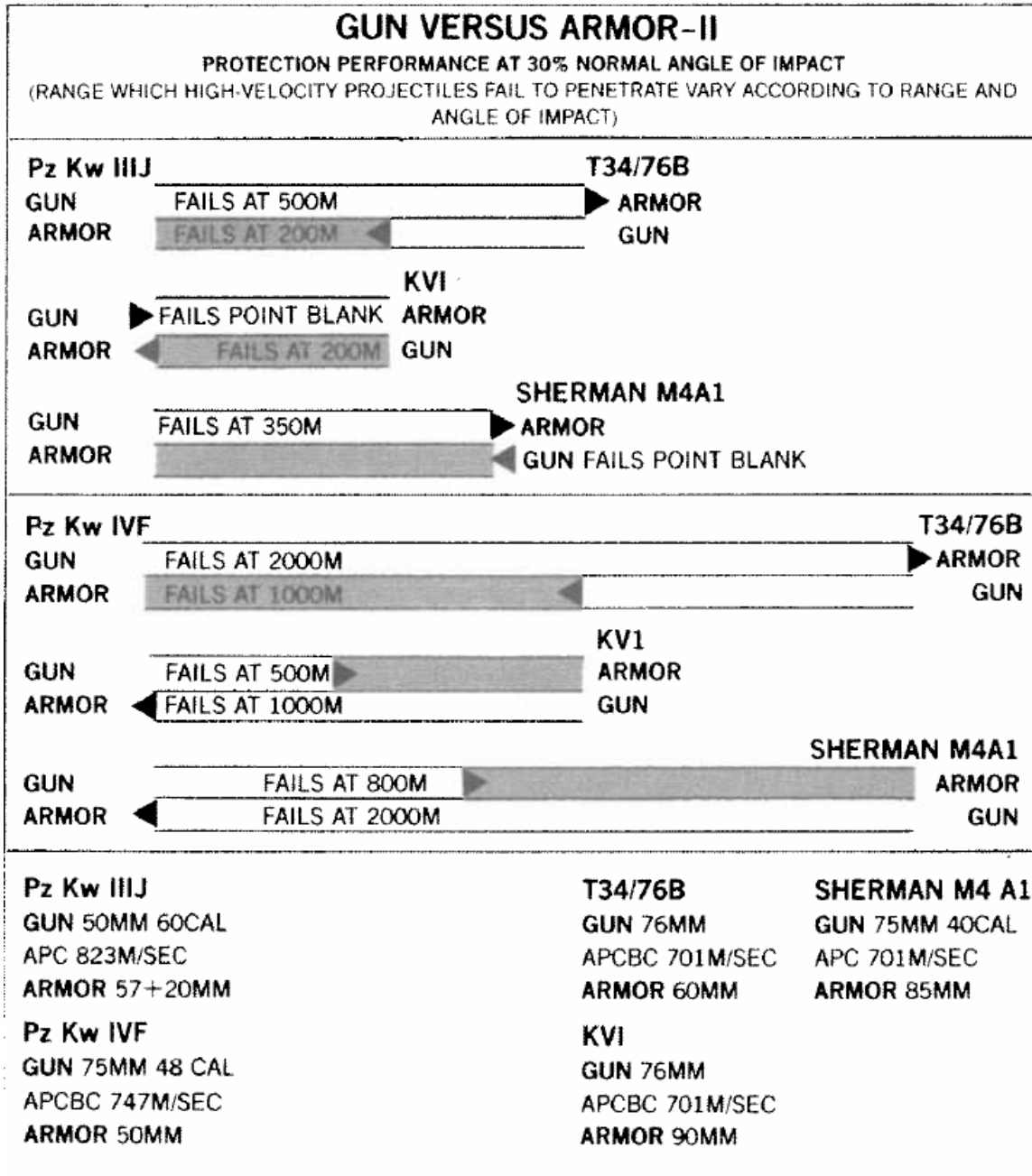

Figure 9. Performance of Various Tanks / Field Guns Against Each Other (From Macksey 1988, 102)

Overall, it can be seen from the development of tanks, as well as their performance against one another, that the key theme of armor development during WWII was developing thicker armor as a response to the heavier armaments that were developed during that period.

C. VIETNAM WAR

1. Troop Protection and the M113 Armored Personnel Carrier

The Vietnam War was primarily a war “dominated by infantry and firepower” (Macksey 1988, 167). However, just like in WWI, there was a need to protect the troops during transport, and hence the importance of APCs came into prominence.

The Vietnam War thus saw the first combat appearance of the M113 APC in the form of two companies in April 1962 (Starr 1980, 21), and it was responsible for the transportation and protection of infantry troops during battle. A good example of the effectiveness of the M113 was in the comparative personnel losses between the Viet Cong and the South Vietnamese Army:

	Killed	Captured	Wounded
Viet Cong	502	184	-
South Vietmanese Army	4	-	9

Table 7. Personnel Losses Comparison Between Viet Cong and South Vietnamese Army (2 M113 Companies) Between 11 Jun-30 Sep 1962 (After Starr 1980, 22)

Yet another testament to the effectiveness of the M113 in troop protection was the operation of a M113 company in the Vietnamese 7th Infantry Division on 25 September in the Plain of Reeds, when the troops were effectively fighting against the enemy, but reports indicated that as soon as the infantry troops dismounted the APCs, casualty counts increased significantly (Starr 1980, 24). This resulted in the M113 being used as “a combat vehicle, used almost as a light tank” (Starr 1980, 24).

Innovations and modifications made during the Vietnam War also improved the protection of the vehicle crew members. The machine gunners, being location above the hull, were exposed to enemy fire, and at least 14 gunners were killed at Ap Bac in early 1963 (Starr 1980, 38). This resulted in the development of the gun shield for the .50-

caliber machine gun, initially made out of soft steel, but later developed from the armor of salvaged vehicles (Starr 1980, 40).



Figure 10. A Typical M113 Operated by the South Vietnamese Army (Shown without Gun Shield) (From Starr 1980, 23)



Figure 11. A M113 with a Gun Shield Modification (From Starr 1980, 74)

Another modification was the installation of “closely spaced steel bars” on M113s in 1966, which is essentially a form of slat armor, for protection against anti-tank rockets and grenades (Starr 1980, 43). However, no conclusive results could be obtained during the evaluation period, but slat armor would prove to be an important armor development during more recent conflicts, as discussed in a later section.

It should be noted, however, that improvements made to the M113’s armor did not reduce the susceptibility of the vehicles. One example would be an escort mission that took place in May 1967, during which a platoon had been hit by a Viet Cong ambush. Seven M113s were each hit 10 times by antitank weapons and a tank was hit 14 times (Starr 1980, 108), which demonstrated a high hit probability from enemy fire.



Figure 12. An M113 with Hits from a Viet Cong 57mm Recoilless Rifle (From Starr 1980, 46)

2. The Effect of Mines

As part of the guerilla tactics employed by the Viet Cong, mines were used to cause damage to the armored vehicles of the South Vietnamese Army. Some key statistics include:

Period	Losses
June 1966	14 M113 in 8 days
June 1969 to June 1970	352 combat vehicles
November 1968 to May 1969	73% of tank losses 77% of APC losses
December 1970	75% of combat vehicles

Table 8. Vehicle Losses Due to Mines (After Starr 1980, 79)

Mines showed the vulnerability of the vehicle hull bottoms, which will also be shown in more modern day conflicts, such as OIF / OEF. The damage caused by mines tend to be greater on APCs than tanks, as APCs had thinner armor, and tend to be carrying more troops, resulting in more personnel injuries / deaths.

While effort was focused on detecting and avoiding mines, improvements were also made to vehicle armor to enhance their survivability against mines. “Belly armor” kits were developed and installed on M113s Sheridans in 1969 (Starr 1980, 82), improving their performance against mine blasts. This is an example of the concept of applique (add-on) armor, which will be discussed later.

3. Other Armor Battles

The Vietnam War also proved to be a battleground between the tanks of the South Vietnamese Army and the North Vietnamese. The South Vietnamese Army, equipped with M41 tanks, was able to outfight their North Vietnamese counterparts significantly, as shown during Operation LAM SON 719:

Date	South Vietnamese Army Losses	North Vietnamese Army Losses
19 Feb 1971	None	6 T-54 16 PT-76
27 Feb 1971	3 ACAV	3 T-54 12 PT-76
1 Mar 1971	6 ACAV	15 Tanks

Table 9. Armored Vehicle Losses during Operation LAM SON 719 (After Starr 1980, 193)

The performance of the North Vietnamese tanks’ armor against the HEAT rockets of the AH-1G Cobras was also apparent during the operation. Between 8 February and 24 March, 66 tanks were sighted, with 6 (9.09%) destroyed and 8 (12.12%) immobilized (Starr 1980, 194).

With the introduction of the Soviet AT3 Sagger missile, the vulnerability of the South Vietnamese Army vehicles can be seen as well:

Date	Losses
23 Apr 1972	1 M48A3 tank destroyed 1 ACAV destroyed 1 ACAV damaged
27 Apr 1972	3 out of 21 M48A3 tanks destroyed (14.28%)

Table 10. Vehicle Losses Against AT3 Sagger Missiles (After Starr 1980, 210)

D. ARAB-ISRAELI CONFLICT & 1982 LEBANON WAR

1. Development of Explosive Reactive Armor (ERA)

As a response to shaped charge warheads, explosive reactive armor was developed on the Israeli M60 Patton tanks (modified to become the Magach) during the 1982 Lebanon War. The armor, called Blazer, was developed by Rafael Armament Development Authority (Foss 1986, 51), and consisted of explosives sandwiched between armor plates (Hilmes 1987, 77). With the detonation of the explosives by the strike from the HEAT rounds, the shock waves and movements of the plate elements disrupt the shaped-charge jet from penetrating the armor (Hilmes 1987, 77).



Figure 13. An Israeli Tank Column Led by a Magach Mounted with Explosive Reactive Armor (From Cooper et al 2003)



Figure 14. A Damaged Magach 6 During the 1982 Lebanon War (From Cooper et al 2003)

E. OPERATION IRAQI FREEDOM / OPERATION ENDURING FREEDOM

1. Improvised Explosive Devices (IEDs)

Operations Iraqi Freedom and Enduring Freedom saw the exposure of troops and vehicles to not just conventional threats, but also to the new widespread threat of IEDs. Primarily shaped charges, their ease of manufacture meant the widespread damage of vehicles that were designed mainly for kinetic energy weapons. As a response to the threat of IEDs, innovations and developments were made to the vehicles deployed to reduce vulnerability and enhance occupant protection.

2. Protection of Light Vehicles (Humvees)

As mentioned previously, Humvees are soft-skinned vehicles and were never designed for protection against major threats such as IEDs. In order to protect them against the focused energy and shaped charge damage mechanisms, the Army Research Laboratory (ARL) at Aberdeen Proving Grounds developed and designed the Armor Survivability Kit (ASK) for the Humvees (U.S. Army (TACOM) 2004, 6). The fiberglass and canvas doors were replaced with armor plate doors with ballistic glass (U.S. Army (TACOM) 2004, 5)



Figure 15. Armor Plate Doors Mounted on the Humvee as Part of the ASK (From U.S. Army (TACOM) 2004, 5)

As of January 2005, more than 9,400 kits were fielded in Iraq and Afghanistan, resulting in a significant number of lives saved.

3. Protection of Heavy Vehicles (Strykers and M1 Abrams)

In order to better protect armored vehicles against IEDs, as well as rocket-propelled grenades (RPGs) which were widely used by insurgents, several improvements and upgrades were implemented on Strykers and the Abrams MBT:

- Slat Armor. Even though it was developed during WWII and used during the Vietnam War, slat armor (or cage armor) came into greater focus during OIF as a response to RPGs. On the Stryker, the cage is spaced 50cm ahead around the vehicle and detonates the RPG warhead away from the vehicle and prevents its hot chemical reaction from boring through the armor (Defense Update Jan 2006). The slat armor was reported to be effective against HEAT rounds.



Figure 16. A Stryker IFV Mounted with Slat Armor (From Defense Update Jan 2006)

- V-Shaped Hull. In an effort to reduce vulnerability of ground vehicles to the effects of an IED blast, vehicles such as the Stryker were modified with their underbellies having a distinct “V” shape rather than the traditional flat surface. The purpose of the V-shaped hull is to deflect the

impulse of the blast, so as to disperse the energy and prevent it from rupturing the hull. Apart from the Stryker, several other vehicles have adopted the V-shaped hull as well, such as the Husky Mk III. As a further development, Strykers are now being modified and developed with double V-shaped hulls to further strengthen the vehicle from blast effects.



Figure 17. A Husky Mk III. Notice the Sloped Bottom Hull, an Example of the V-Shaped Hull (From Critical Solutions International, 2012)

- Tank Urban Survivability Kit (TUSK). The TUSK was an add-on solution designed to enhance the M1 Abram's ability to meet the threats encountered in Iraq and Afghanistan. Essentially, it was a combination of previously used armor enhancements, including the installation of slat armor outside the engine compartment and mounting of reactive armor on the side skirts (Defense Update Dec 2006). Interestingly, the TUSK also includes the gun shield for the external coaxial machine gun, which was a key protection feature of the M113 during the Vietnam War.



Figure 18. An M1 Abrams MBT Mounted with a TUSK (From Defense Update Dec 2006)

F. OTHER DEVELOPMENTS

1. Composite Armor

In order to improve the performance of armor against threats while minimizing the weight increase of the vehicles, composite (or compound) armors were developed in the 1960s and 1970s. Such armors would consist of compact arrays with laminated elements, or spaced arrays (Hilmes 1987, 77). Perhaps one of the best-known composite armors is the “Chobham armor” developed by the British. Although the composition is still secret, it is known to be a part-laminated, part-spaced array with elements of steel, ceramics and aluminum (Hilmes 1987, 77). By combining the performance of ceramics with that of the metals, the Chobham armor allowed for better protection against both kinetic energy warheads and shaped charges. The Chobham armor was first used on the Vickers Valiant in 1976 (Hilmes 1987, 77) and is widely used on the M1 Abrams and British Challenger tanks.



Figure 19. A Challenger 2 MBT (From IHS Jane's 2012)

2. Applique Armor

Lighter alloy armors were used before to minimise the weight of vehicles, but they were not as effective due to their lack of hardness. In June 1980, the Vickers Valiant tank was the first tank to employ the use of mainly light alloy armor. However, in order to further harden the vehicle, it was also constructed with Chobham armor arrays on the front and sides (Hilmes 1987, 77), thus providing the first application of applique armor. This allowed the flexible configuration of armor thickness based on the threats expected in the area of operations.

G. SUMMARY

If one were to plot the relative performance of armor throughout history, it will look similar to what is shown in Figure 20:

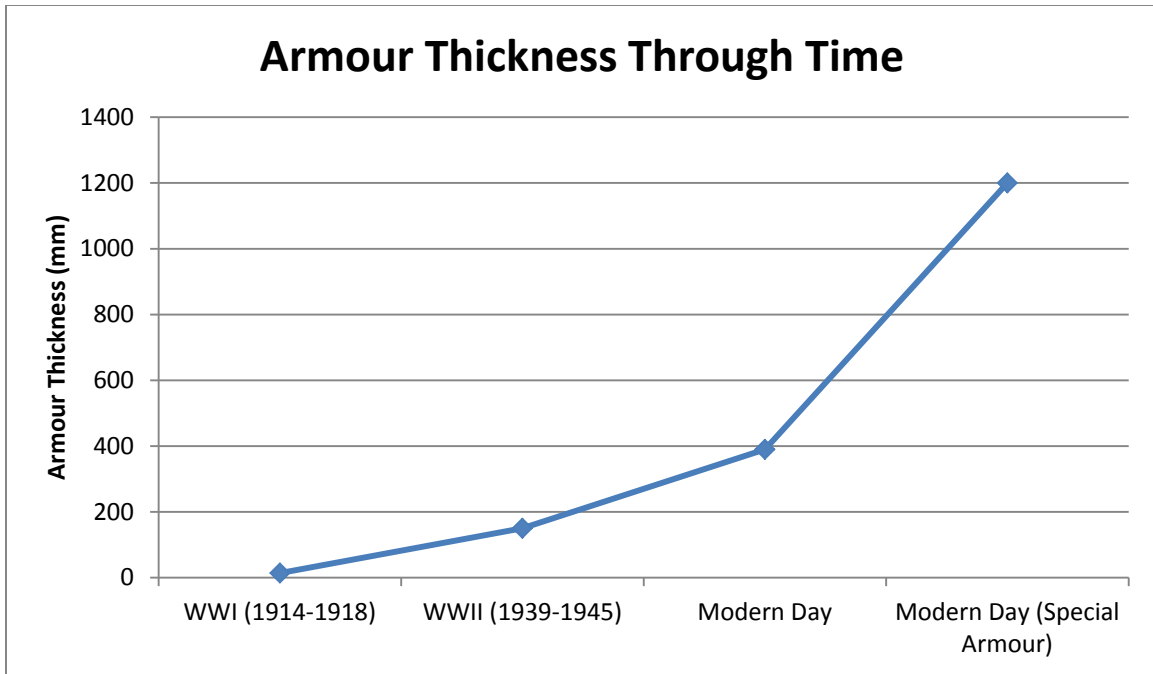

Figure 20. Graph Depicting Increase of Armor Thickness through Time (After Steeb, Brendley, Norton, Bondanella, Salter and Covington, 1991, 3)¹

While the thickness of armor has shown a steady increase up till the modern day, it has also come to a stagnation point, due to limitations in weight and space on the ground vehicle. However, with various innovations, such as ERAs and composite materials, the effective performance of armor has increased dramatically, ever since. The limitations and design considerations will be discussed in later sections.

¹ “Modern Day” armor refers to the equivalent thickness in rolled homogeneous steel armor (RHA).

III. MISSION-THREAT ANALYSIS

A. MISSIONS OF ARMORED VEHICLES

Due to their mobility and firepower, armored vehicles are expected to undertake a variety of missions ranging in scale and objective.

1. Tactical Level

Given the mobility and firepower that is available on just one platform, several armored vehicles within a tactical team can be employed to perform task force missions, such as to conduct an ambush on an enemy convoy or a tank-killing mission prior to a full-scale assault.

2. Operational Level

Within the framework of a combat team or an armor battle group, armored vehicles are expected to perform tasks that fulfill one or more operational mission objectives, such as:

- Offensive Operations. Offensive operations are operations “conducted to defeat and destroy enemy forces and seize terrain, resources and population centers” (Headquarters Department of the Army 2008, 3–6). The key advantages of armored vehicles are then well-suited to perform the primary tasks of movement to contact, attack, exploitation and pursuit (Headquarters Department of the Army 2008, 3–6).
- Defensive Operations. Defensive operations are operations “conducted to defeat an enemy attack, gain time, economize forces, and develop conditions favorable for offensive or stability operations” (Headquarters Department of the Army 2008, 3–8). Since most defensive operations are performed from a fixed defensive position, it is important to have a longer engagement range than the attacker for more effective defense. With the larger caliber armaments available onboard armored vehicles, they contribute by allow for a greater stand-off range.

- Retrograde Operations. Retrograde operations are withdrawal operations that trade space for time. With the importance placed on mobility and standoff range, armored vehicles are thus expected to perform a combination of the tasks required for both offensive and defensive operations.

3. Support Operations

Armored vehicles are usually produced as a suite of variants, with the same basic chassis mounted with different types of equipment in relation to their functions. Support variants of armored vehicles will include artillery, logistics and maintenance variants. Therefore, they will be expected to perform operations that support the combat operations list above, such as recovery, support fire and medical evacuation.

B. OVERVIEW OF THREATS

As the name implies, ground vehicles operate on the ground. However, they face a multitude of threats across a wide vertical envelope that spans 360 degrees. Not only do they have to contend against

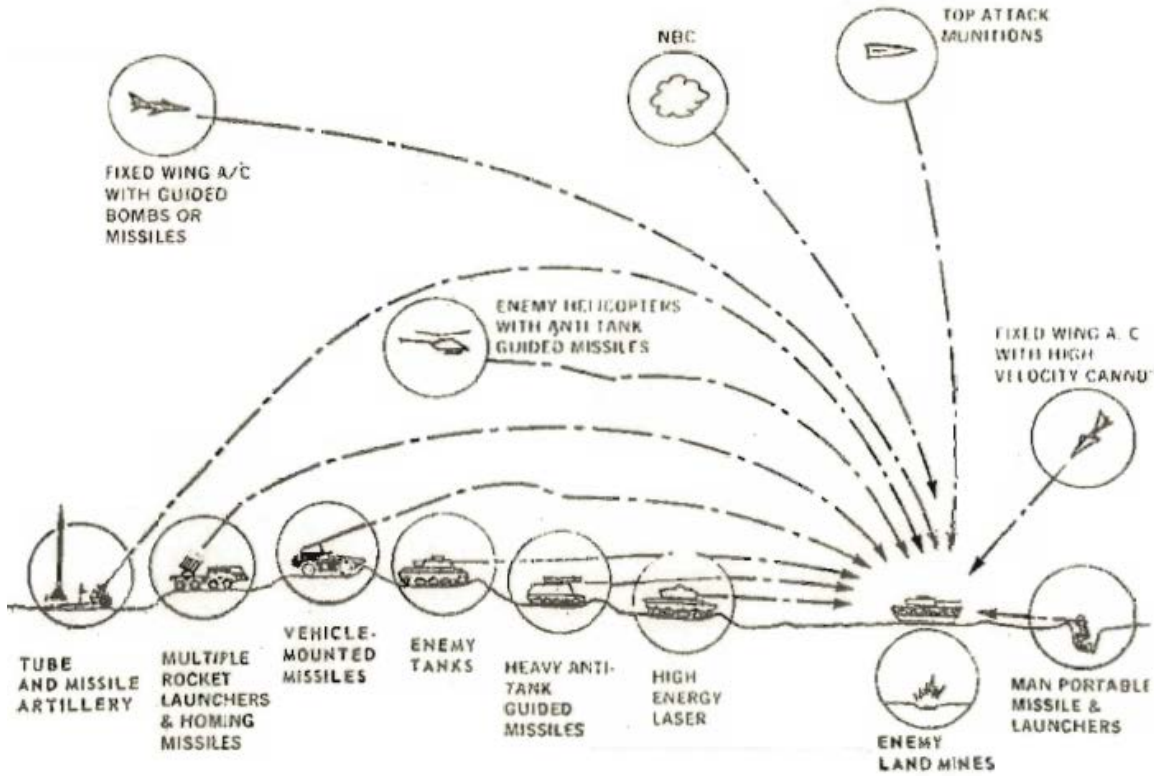

Figure 21. Summary of Threats Faced by an Armored Vehicle (From a Abrams Tank System Survivability Briefing in Jan 2012)

Despite the wide range of threats that ground vehicles face from all directions, the ways that they inflict damage on armor (ie the damage mechanism) can be essentially classified into four different types: metallic solids, metallic jets, fire and blast, with the differences only being in the propagators and delivery mechanisms. This can be seen in the breakdown shown in Figure 13:

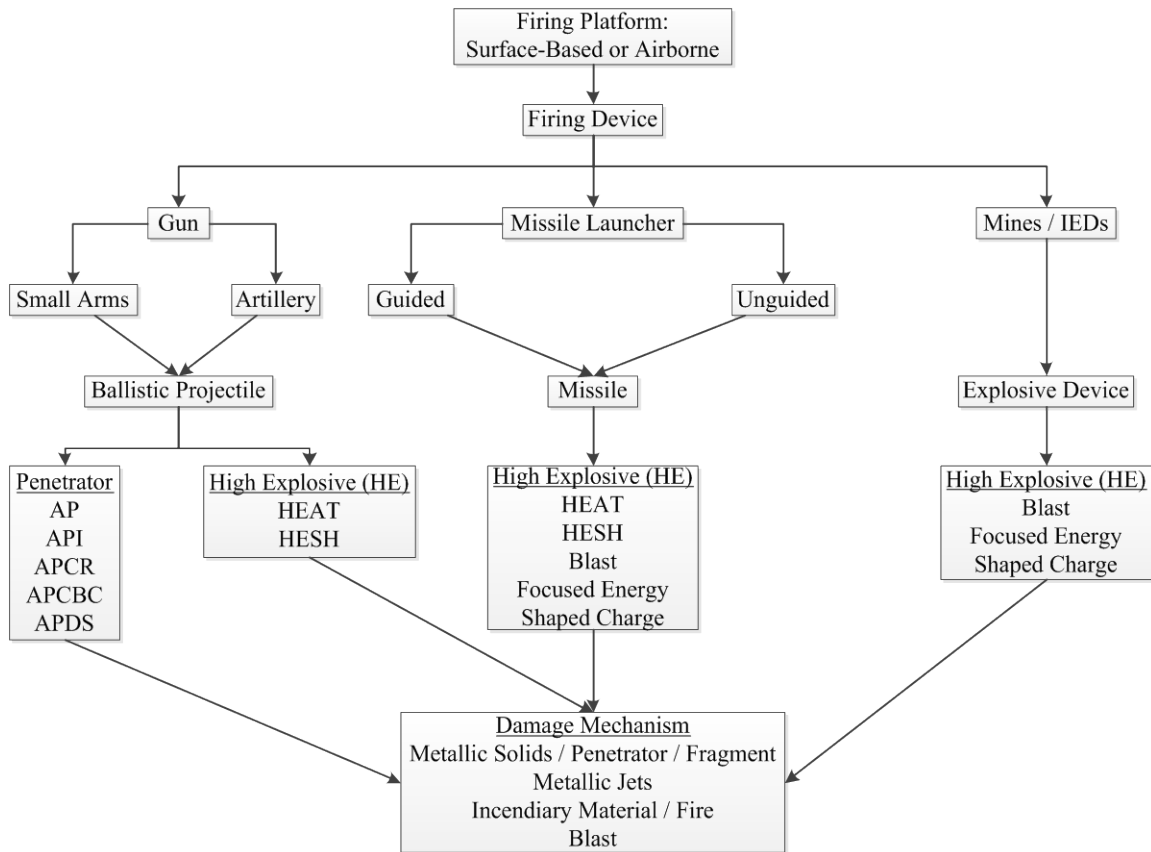

Figure 22. Breakdown of Threats into Delivery Mechanisms, Propagators and Damage Mechanisms

Some of the more common threats to armored vehicles are described below.

1. Small Arms

While armor was developed in WWI to offer protection against small arms fire from enemy infantry, the threats from small arms fire in today's context lies mostly with armor piercing (AP) rounds, which are specially designed to better penetrate armor than typical ball rounds. Such rounds are typically designed to be harder, usually manufactured from materials such as hardened steel core for AP machine gun rounds and depleted uranium for 50-calibre AP rounds fired from anti-materiel sniper rifles.

2. Artillery

During WWI, the majority of tank casualties were the result of hits from artillery fire. In today's context, they continue to pose a threat to armored vehicles, mainly

because armor is normally designed with thinner armor on the top. Hence, artillery shells are particularly effective when they directly hit armored vehicles from the top. Modern-day artillery is even more effective with the use of precision guided missiles, which provide greater accuracy to directly hit vehicles.

3. Anti-Tank Weapons

With the development of the tank in WWI, it was logical to develop weapons that are designed for the destruction of tanks. Armored vehicles of today face a multitude of anti-tank weapons that are capable of damaging and destroying them, including:

- Rocket Propelled Grenades (RPGs). RPGs are shoulder-fired weapons that fire high explosive (HE) warheads that mounted with rocket motors that propel them into flight over a long distance. The damage mechanisms that the warheads normally use are blast and fragmentation.

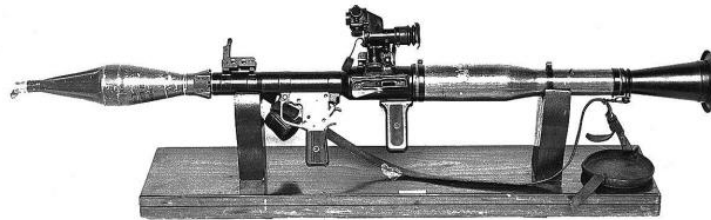

Figure 23. An RPG-7 Rocket Launcher (From IHS Jane's 2011)

- Anti-Tank Guided Missiles (ATGM). Missiles are another type of firing platforms that deliver the HE warheads to the armored vehicles. After firing, such missiles typically seek and track the target vehicles through visual or imaging IR seekers that are also installed within the missile. ATGMs may be soldier-carried or mounted on vehicles.



Figure 24. A Soldier Firing the Spike ATGM (From IHS Jane's 2011)

4. Armored Vehicles

With their mobility and firepower, enemy armored vehicles are well-suited to take out armored vehicles. While most tanks inflict damage through the main guns that are mounted on the turrets, some armored vehicles may do so through the use of ATGMs that are launched from the vehicle instead, such as the use of TOW missiles on the M2 Bradley IFV.

5. Aircraft

As mentioned previously, armored vehicles are normally designed with less armor on the top, making them vulnerable to threats from above. Apart from artillery fire, aircraft can also provide that overhead threat. They can inflict damage through:

- Projectiles. Aircraft can be mounted with machine guns that fire AP rounds similar to those fired by ground soldiers. With a higher payload capacity compared to soldiers, aircraft can thus deliver heavier and higher caliber rounds, thus increasing the probability of penetration in the armor. The A-10 Thunderbolt, for example, carries a 30mm cannon that can fire AP rounds. This is the similar caliber that can be found on light infantry fighting vehicles.

- HE Warheads. HE warheads inflict damage in a similar way as artillery shells and ATGMs. They can be delivered by means of bombs or guided missiles, such as those fired by the AH-64 Apache.

6. Anti-Tank Mines

Anti-tank mines anti-tank HE warheads that are packaged and designed to be deployed in the ground and to be detonated underneath armored vehicles as they rolled over them. Like HE warheads, they use blast and fragmentation damage mechanisms.

7. Improvised Explosive Devices (IEDs)

In the recent conflicts in Iraq and Afghanistan, vehicles have seen an increased threat from IEDs, which are essentially homemade “bombs.” Due to the homemade nature of these devices, their composition can vary and thus cause damage to armored vehicles in many ways. Other than the usual blast and fragmentation damage mechanisms, IEDs can also inflict damage through shaped charges and explosively formed penetrators.

C. HOW KINETIC ENERGY WARHEADS WORK

With the initial development of armored vehicles, one of the first damage mechanisms that were devised (as can be seen from the damage from artillery in WWI) was the penetration of armor using projectiles, ie through kinetic energy. The penetrating ability of a projectile is described by the de Marre formula (Ogorkiewicz 1968, 56):

$$wv^2 = kd^3 \left(\frac{t}{d} \right)^n$$

where w = weight of projectile, lbf
 v = velocity of projectile, ft/s
 d = diameter of projectile, in
 t = thickness of plate which the projectile only just perforates, in
 k = constant depending on projectile and target plate (typically 10⁶)
 n = 1.4

As can be seen from the de Marre formula, the thickness of the armor should be determined based on the type of projectiles that are expected to be fired within the hostile environment. Such information can be determined through intelligence gathering.

We can verify the validity of the de Marre formula by using it to analyze the effectiveness (or lack thereof) of certain projectiles against armored vehicles that we have seen in the earlier sections:

- WWI. Recall that the Germans were widely deploying the MG 08 machine gun on the battlefield, firing 7.7mm rounds. Assuming a muzzle velocity of 900 m/s (2,953 ft/s), projectile diameter of 0.318 in and weight of 12g (0.0264555 lbf),

$$t = d^n \sqrt{\frac{wv^2}{kd^3}} = (0.318)^{1.4} \sqrt{\frac{0.0264555(2953)^2}{10^6(0.318)^3}} = 0.251in = 6.3754mm$$

With considering the maximum thickness of plate that the rounds would penetrate, it is thus no surprise that the MG 08 was ineffective against the 10mm armor of the Mk I tanks, even at point blank range. Consider, instead, the 37mm Tankabwehrkanone, considered the world's first anti-tank gun (Hogg 1996, 67). With a muzzle velocity of 650 m/s (2,133 ft/s), projectile diameter of approximately 1.4567 in and weight of 176 lbf,

$$t = d^n \sqrt{\frac{wv^2}{kd^3}} = (1.4567)^{1.4} \sqrt{\frac{176(2133)^2}{10^6(1.4567)^3}} = 14.89in = 378.2mm$$

Considering that it can penetrate modern light armored vehicles, the effectiveness of the Tankabwehrkanone as an anti-tank gun is clearly evident.

- WWII. Recall that the German Panther and Tiger I tanks were developed in response to the heavy armament of the Soviet T-34 tanks with their 76.2mm guns. Deriving the penetrating power of the T-34 rounds yields

$$t = d^n \sqrt{\frac{wv^2}{kd^3}} = (3)^{1.4} \sqrt{\frac{13.23(1969)^2}{10^6(3)^3}} = 4.74in \approx 120mm$$

Once again, the penetrating power of the round shows the ineffectiveness of the Panzer IV's 80mm armor. Compared to the Panther and Tiger I,

however, the T-34 rounds thus become largely ineffective, as it was proven on the battlefield.

- Vietnam War. Consider a 7.62mm round from the AK-47 (a typical rifle used by the Viet Cong) on the armor of the M113 (which ranges from 12 to 38mm (Foss 1985, 181)):

$$t = d \sqrt[n]{\frac{wv^2}{kd^3}} = (0.312) \sqrt[1.4]{\frac{0.0176(2350)^2}{10^6(0.312)^3}} = 0.716in \approx 18.2mm$$

The de Marre formula shows that a typical rifle round would have been largely ineffective against the M113 APC, which was indeed the case during the Vietnam War, which resulted in the Viet Cong having to review their tactics and use anti-tank weapons to defeat the armor.

1. **Armor Piercing, Composite, Rigid (APCR)**

While the natural response to thicker armor would be to increase the weight and velocity of the projectile, there would come a point whereby the total recoil forces acting on the firing vehicle would be undesirable. Hence, the APCR round was developed. An APCR projectile, due to its lower density jacket, had a higher muzzle velocity, resulting in a higher penetrating ability compared to traditional AP rounds of the same caliber.

2. **Armor Piercing, Capped, and Ballistically Capped (APCBC)**

The APCBC is an improvement over the conventional AP projectile in two aspects. The first aspect is a soft metal cap added to the tip of the AP round to absorb the energy of impact with the target, thus reducing the probability of the AP round shattering upon impact and improving the penetration power. The second aspect is the streamlined ballistic cap over the soft metal cap to reduce in-flight energy loss, thus improving the range and accuracy of the AP round that was affected by the metal cap. Figure 25 shows the composition of the APCBC round, with the AP projectile (light grey), soft metal cap (black) and ballistic cap (white).

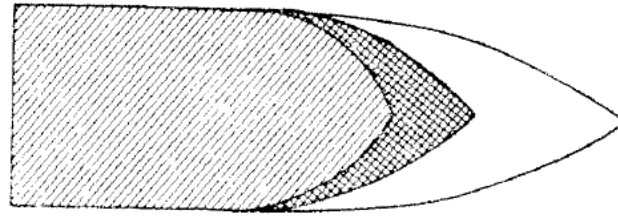

(a)

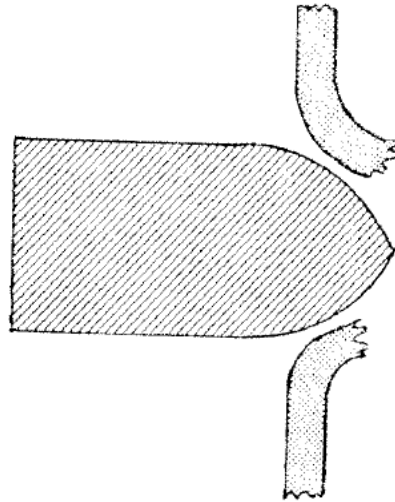

(b)

Figure 25. Figure Showing the Composition of a APCBC Round (a) and how it Penetrates Armor (b) (From Weeks 1975, 13)

However, APCBC rounds still had a lower penetration capability than APCR rounds, as shown below:

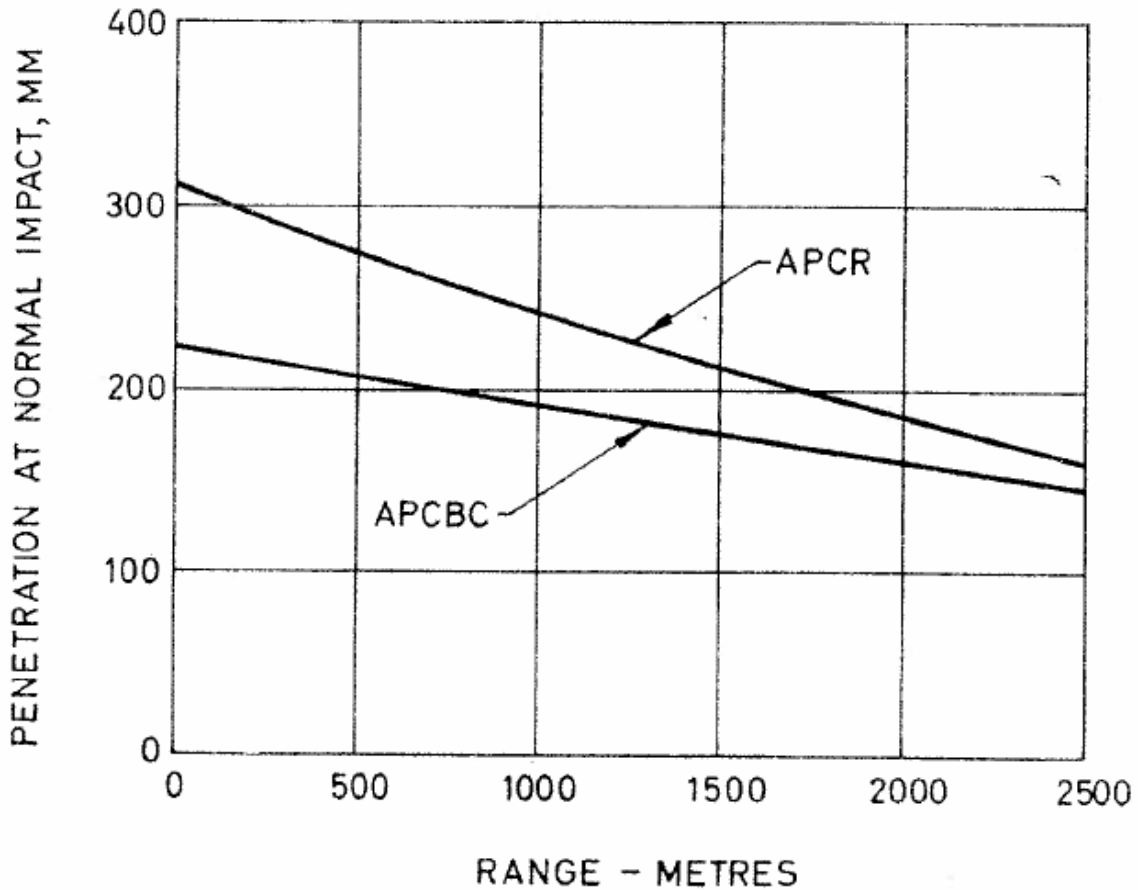

Figure 26. Normal Armor Penetration vs Range of Rounds Fired from the German 88mm L/71 Gun (From Ogorkiewicz 1968, 60)

Analysis of the American armor against German armament shows their performance or lack thereof. The 88mm APCBC ammunition used by the Tiger I tank yields a penetrating depth of

$$t = d^n \sqrt{\frac{wv^2}{kd^3}} = (3.464)^{1.4} \sqrt{\frac{22.48(2536)^2}{10^6(3.464)^3}} = 8.438in \approx 214mm$$

With such a high penetrating depth, it is evident that Tiger I tank had an extremely devastating effect on the 85mm armor of the M4 Sherman tanks that were deployed by the Americans. With a difficulty in developing tanks with armor greater than

214mm thickness, it was no surprise that the M4 Sherman tanks were unable to go up against the Tiger I on a 1-on-1 basis, and could only do so with changes in tactics.

3. Armor Piercing, Discarding Sabot (APDS)

In addition to the higher recoil forces acting on the firing vehicle, larger rounds also had the disadvantage of higher drag while travelling to the target, which meant larger velocity reduction in the air and hence less penetrating ability. In order to get around that, the APDS round was developed to separate the core from the rest of the projectile body upon exiting the bore, thus maintaining the advantage of a high muzzle velocity. With the lower weight, the round could thus retain accuracy and penetrating ability. Additional developments on the APDS round include the addition of fins, resulting in the Armor Piercing, Fin Stabilized Discarding Sabot (APFSDS) round, as well as the use of depleted uranium penetrators instead of tungsten alloys in the APFSDS rounds (Ogorkiewicz 1995, 3).

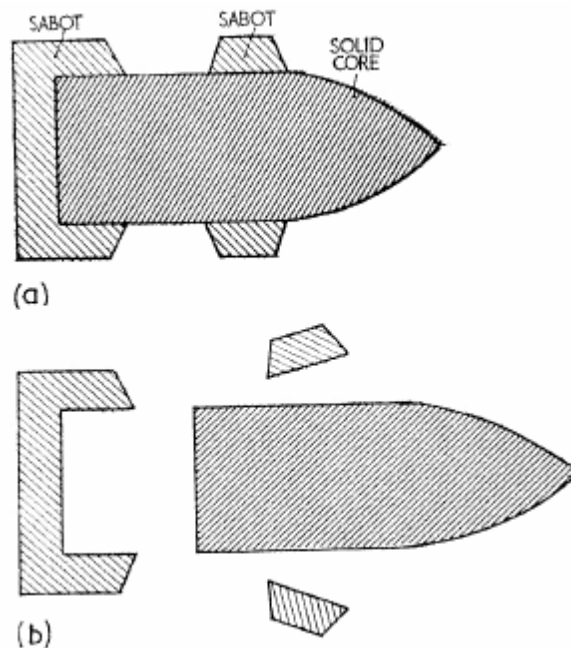

Figure 27. Figure Showing the Structure of an APDS Round (a) and the Sabots Discarding at the Muzzle (b) (From Weeks 1975, 14)

D. HOW BLAST WARHEADS WORK

The release of energy by high explosives within a warhead can generate a pressure wave in the air that can inflict damage on armor as well. This is known as the blast damage mechanism. Making use of the blast mechanism, other warheads have thus been developed.

E. HOW METALLIC JET WARHEADS (SHAPED CHARGES) WORK

1. The Munroe Effect

The Munroe effect is the fundamental basis with which metallic jet warheads operate by. The high explosive charge must have a cavity facing the target, as well as a metallic liner. Upon detonation of the explosive charge, the resulting wave collapses the liner and thus a high velocity metallic jet is formed that can penetrate armor (Global Security 2011).

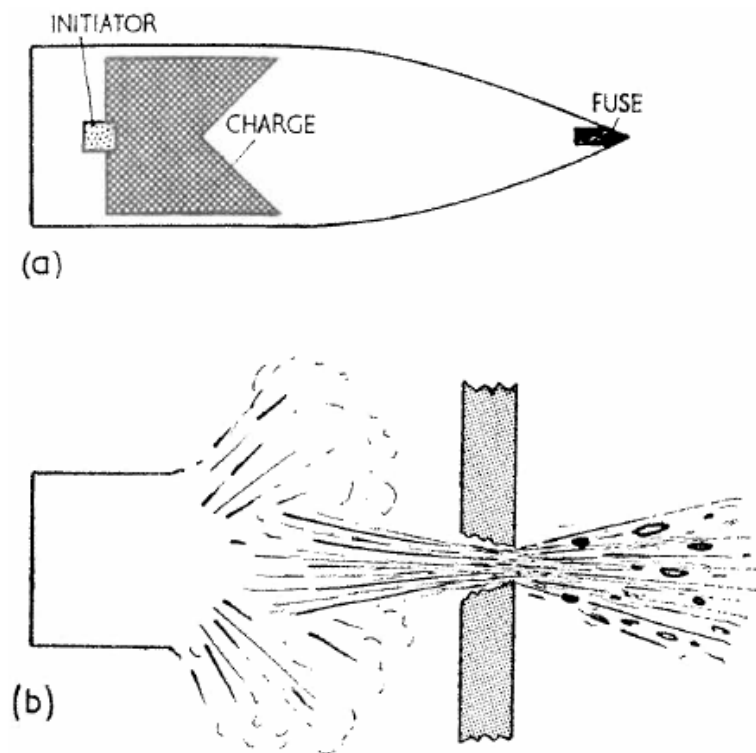

Figure 28. A Typical Metallic Jet Warhead (a) and the Metallic Jet Burning through Armor (b) (From Weeks 1975, 15)

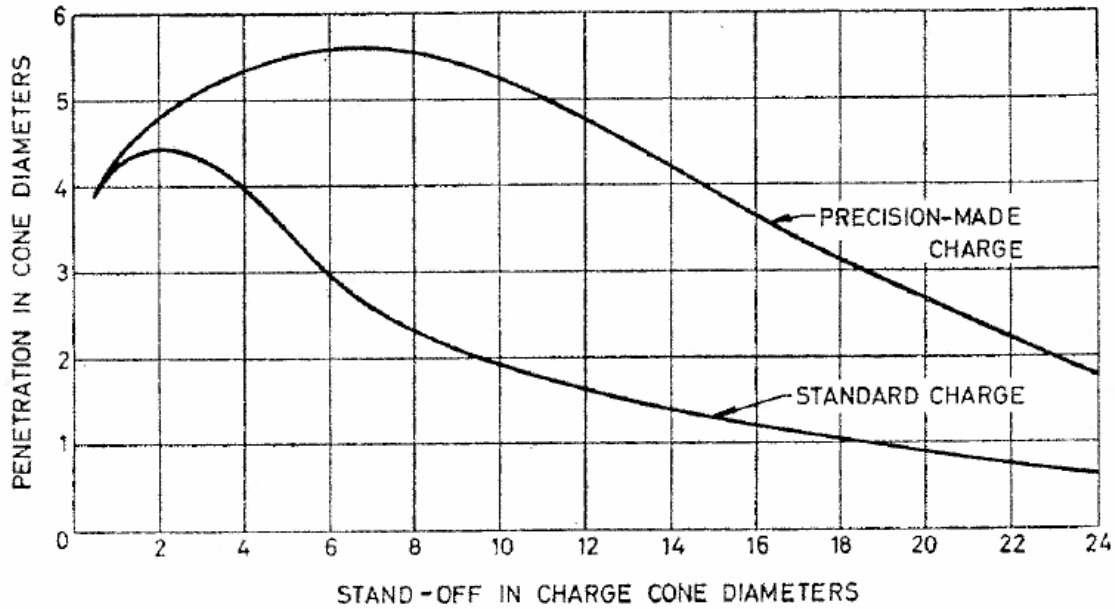

Figure 29. Armor Penetration of Shaped Charges versus Stand-off Distance (From Ogorkiewicz 1968, 65)

2. High Explosive, Anti-Tank (HEAT)

HEAT rounds make use of the explosion to generate the shaped charges, jets of metal (typically copper) that have high penetrating ability. The formula for depth of penetration is shown below (Ogorkiewicz 1968, 63):

$$t = L \sqrt{\frac{\rho_j}{\rho_a}}$$

where L = effective length of jet
 ρ_j = density of the jet
 ρ_a = density of the target material

This this indicates that, in order to minimize the penetration depth of the shaped charge, the density of the armor material should be significantly higher than that of the jet. Given a typical density of 8940 kg/m^3 for copper, armor materials can then be selected such that the density can limit the depth of penetration. Typical armor materials can thus fix the penetration depth as shown:

Material	Density (kg/m ³)	Penetration Depth (L)
Aluminum	2712	1.815615647
Light Alloy based on Al	2560	1.868739548
Steel	7850	1.067170794
Titanium	4500	1.409491634

Table 11. Penetration Depth by Shaped Charge through Typical Armor Materials

The formula for penetration depth thus helps explain the effectiveness of certain weapons against certain vehicles:

- Vietnam War. Consider the RPG-2 on the M113 APC, which had aluminum armor. From the table above, we can see that the penetration depth would be approximately 1.8 times that of the jet length. This meant that a M113 (with maximum armor thickness of 38mm) could only withstand an effective jet length of about 21mm, which is exceeded by the RPG-2 in real life. Hence, the RPG-2 would have been able to penetrate the M113 easily, which was the case in reality.

3. High Explosive, Squash Head (HESH)

The HESH projectile was developed in Britain for destroying concrete fortifications, but was subsequently adopted for use as tank ammunition (Ogorkiewicz 1968, 71). It differs from typical HE warheads in that its nose squashes upon impact with the target, resulting in an explosion close to the armor surface. This enhances the blast effect of the round, generating greater stress waves within the armor and causing fractures in the structure. However, what the HESH gains in blast effect, it loses in fragmentation and penetration. Therefore, an appropriate countermeasure against the HESH is the use of sandwich or layered armor.

F. PERFORMANCE OF MODERN ANTI-TANK WEAPONS

Table 12 summarizes the major anti-tank weapons from around the world, the types of warheads they carry and their performance in terms of the depth of armor that can be penetrated.

Country	Weapon	Type of Round / Warhead	Armor Penetration
UK	Swingfire Long Range ATGW	HEAT	?
	LAW 94	Shaped Charge	650mm
	120mm Wombat RR	HESH	400mm
USA	Hellfire	HEAT	?
	BGM-71D TOW-2	HEAT	800mm
	Shoulder-Launched Multi-Purpose Assault Weapon	HEAA	?
	M-47 "Dragon" ATGM	Shaped Charge / HEAT	?
	M40A2 RCL	HEAT	?
Russia	SPG-9 RCL 73mm Gun	HEAT	390mm
	B-11 107mm RCL Gun	HEAT	380mm
	T-12 Anti-Tank Gun	HEAT / APDS / APHE	?
	M-1945 (D-44) Anti-Tank Gun	HEAT / APHE / HVAP	108mm
	M-1955 Anti-Tank Gun	HEAT	380mm
	B-10 RCL 82mm	HEAT	240mm
	AT-2 "Swatter" ATGW	HEAT	400–500mm
	AT-3 "Sagger" ATGW	HEAT	400mm
	AT-4 "Spigot" ATGM	HEAT	500–600mm
	AT-5 "Spandrel" ATGM	HEAT	?
China	AT-14 "Kornet"	Shaped Charge / HEAT	?
	Type 51 90mm Anti-Tank Rocket Launcher	HEAT	267mm
	Type 52 RCL	HEAT	228mm
	Type 56 Anti-Tank Grenade Launcher	HEAT	265mm
	Type 65 Recoilless Gun	HEAT	240mm
Germany	Type 69 Anti-Tank Grenade Launcher	HEAT	320mm
	Armbrust LAW	HEAT	300mm
	Cobra Anti-Tank Missile	HEAT	500mm

Country	Weapon	Type of Round / Warhead	Armor Penetration
	Mamba Anti-Tank Missile	HEAT	475mm
	Panzerfaust 3 Anti-Tank System	HEAT / HESH	700mm
Israel	B-300 Light Anti-Armour Weapon	Shaped Charge / HEAT	550mm
	MAPATS	HEAT	800mm
Sweden	Miniman Launcher	HEAT	300mm
	PV-1110 RR	Hollow Charge	380mm
Belgium	MECAR 90mm Light Gun	HEAT	350mm
	RL-83 Blindicide	HEAT	?
	RLC-83 Compact Rocket Launcher	HEAT	300mm
France	Apilas	Shaped Charge	720mm
	HOT Anti-Tank Missile	?	?
	Individual Anti-Bunker Anti-Armour Weapon ABB	Shaped Charge	400mm
	SS11 / SS12 ATGM	HEAT	600mm
	Lance-Roquettes Anti=Char 89mm	HEAT	500mm
	WASP Individual Assault Weapon	?	400mm

Table 12. Summary of Warhead Type and Performance of Various Anti-Tank Weapons (After Norris 1996)

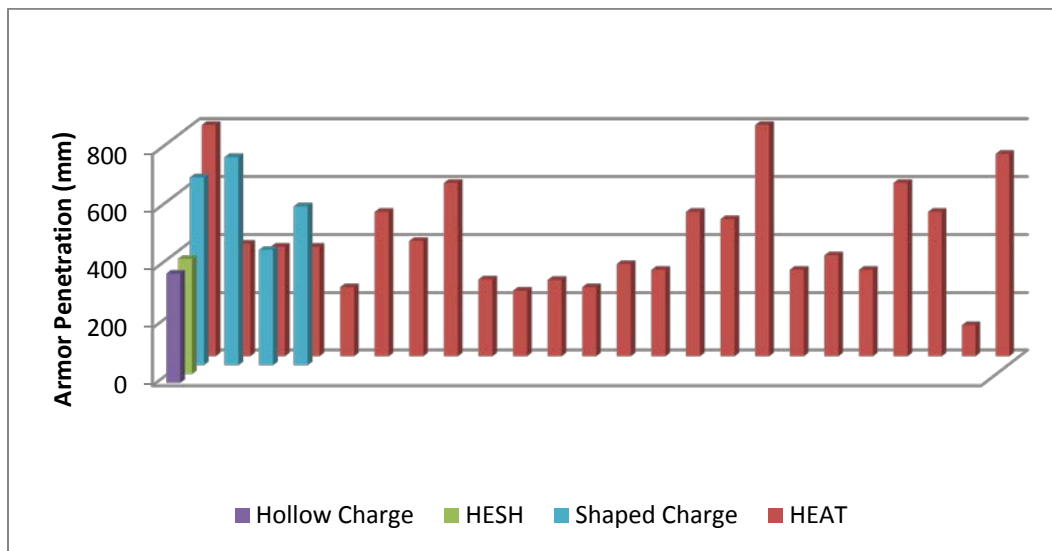

Figure 30. Armor Penetration Variation with Warhead Type (After Norris 1996)

The summary shown in Table 12 and Figure 30 shows two key trends:

- It can be seen that the most common type of round that is used in anti-tank weapon designs is the HEAT round.
- HEAT rounds tend to provide the best penetration capabilities.

IV. ANATOMY OF ARMORED VEHICLES

A. CRITICAL TASKS AND KEY FUNCTIONAL AREAS

The critical tasks of an armored vehicle are:

- Propulsion
- Control
- Firepower
- Protection
- Communication / Networking

Hence, the anatomy of an armored vehicle can be broken down into the following key areas based on those critical tasks:

Critical Task	Key Functional Area
Propulsion	Powertrain (Engine / Transmission)
	Tracks / Wheels
Control	Steering
	Brakes / Suspension
Firepower	Turret
	Armament
Protection	Hull / Chassis
Communication / Networking	Vetronics / C3 Systems

Table 13. Critical Tasks and Key Functional Areas of Armored Vehicles

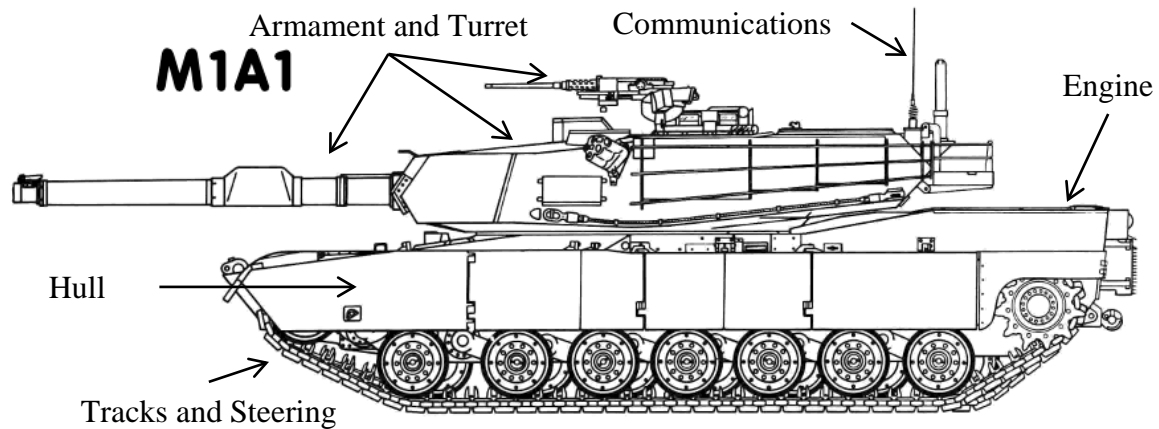

Figure 31. Key Functional Areas of M1A1 Abrams Tank (From Cooke 2008)

B. PROPULSION COMPONENTS: POWERTRAIN, TRACKS / WHEELS

The powertrain is responsible for providing power for the vehicle to propel itself during a mission. It consists of the engine, as well as the transmission system. The power generated must be transmitted to an interface between the vehicle and the surface that it is travelling on. While traditional armored vehicles have employed the use of tracks, more modern vehicles (such as the Stryker) use wheels for mobility and psychological reasons.



Figure 32. Comparison of Tracked (Left) (From Cooke 2008) and Wheeled (Right) (From Cooke 2009) Propulsion Systems

C. CONTROL COMPONENTS: STEERING AND BRAKES

Without any control over the vehicle, the operator of an armored vehicle cannot easily direct the vehicle to the desired speed and location. Hence, the ability to accelerate,

decelerate and steer are considered control functions. Components that are included in this category include the steering column / linkages as well as brakes.

D. FIREPOWER COMPONENTS: TURRET AND ARMAMENT

One of the key tenets of armor operations is shock, which is provided by firepower. On an armored vehicle, this is achieved by the integration of a mounted weapon, be it a 7.62mm machine gun or a 120mm cannon. While the simplest design is a weapon on a fixed mount, most armored vehicles' weapons are integrated into turrets, which provide a means of firing in a direction that is different from the direction of travel. In view of reducing gunner susceptibility, modern vehicles may employ the use of remote control weapon stations.



Figure 33. Illustration of Traditional Turret Mounted Gun (Left) (From Zimbio, n.d.) vs Remote Controlled Weapon Station (Right) (From Ministry of Defence, Singapore 2009)

E. PROTECTION COMPONENTS: HULL AND CHASSIS

With the key task of occupant protection, the importance of an armored vehicle's hull cannot be overemphasized. The hull may be of passive or active types. This will be further discussed in the application of component shielding in ground vehicles.

F. COMMUNICATIONS / NETWORKING

Armored vehicles rarely operate alone, and normally function within the framework of a combat team or battle group. Any information that can be shared from one vehicle to another can enhance the combat effectiveness of the higher entity, resulting in a more decisively victory.

G. KILL CRITERIA AND TYPICAL KILL TREE

A vehicle to assess the survivability of an armored vehicle, there is a need to understand the kill criteria (Deitz, Reed, Jr, Kloplic and Walbert 2009, 68):

- Mobility Kill. Loss of tactical mobility resulting from damage that cannot be repaired by the crew on the battlefield. A vehicle has sustained mobility kill when it is incapable of executing controlled movement on the battlefield. Mobility kill will occur when damage is inflicted upon any of the components that contribute the propulsion and control of the vehicle.

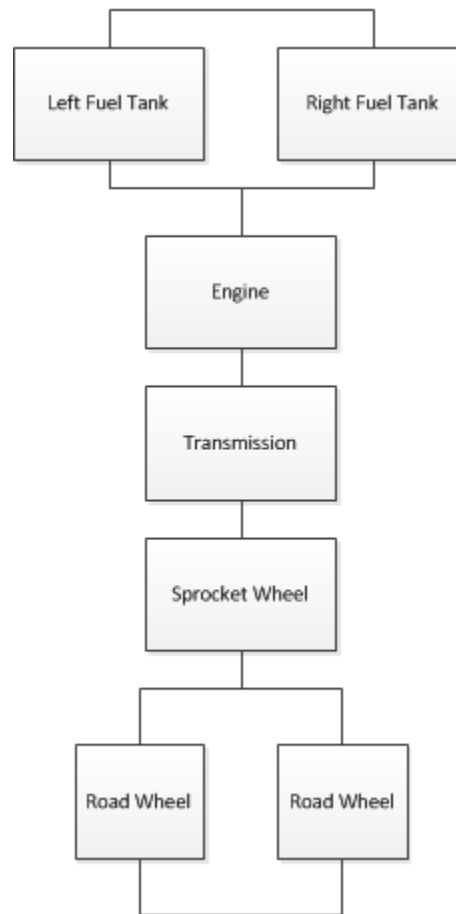

Figure 34. Example of Kill Tree for Mobility Kill

- Firepower Kill. Loss of tactical firepower resulting from damage that cannot be repaired by the crew on the battlefield. A vehicle has sustained firepower kill when it is incapable of directing controlled fire from its

main armament. This will occur when any components in the armament or turret systems are damaged and disabled.

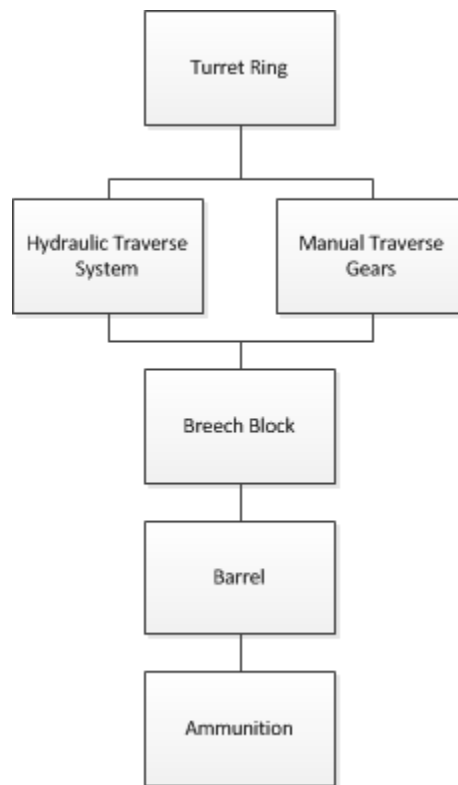

Figure 35. Example Kill Tree for Firepower Kill

- Total Kill. A vehicle has sustained total kill when both mobility kill and firepower kill occur and the damage is judged not to be economical to repair.
- Personnel Kill. While technically not part of a ground vehicle, personnel kill and attrition is still a key aspect of consideration in ground vehicle survivability design, since many ground vehicles function as troop carriers. Even if a vehicle survives the penetration of a round, the round may still be able to injure or kill personnel that are located behind the armor.

H. LOCATION OF ARMOR ON A GROUND VEHICLE

With a better understanding of the anatomy of a ground vehicle, and how it may be killed / damaged, it is easy to see where armor can be found on a ground vehicle. Recall that the purpose of armor is to provide protection to critical components from damage. Hence, armor is mounted in the following areas:

Key Components	Armor Location
Powertrain (Engine / Transmission)	Hull
Steering	
Hull / Chassis	
Vetronics / C3 Systems	
Occupants / Crew	
Turret	Turret
Armament	
Brakes / Suspension	Side Skirts
Tracks / Wheels	

Table 14. Armor Location Based on Vehicle Components

1. Hull

The example that best illustrates the concept of hull armor is the British Mk I tank that was introduced during WWI.

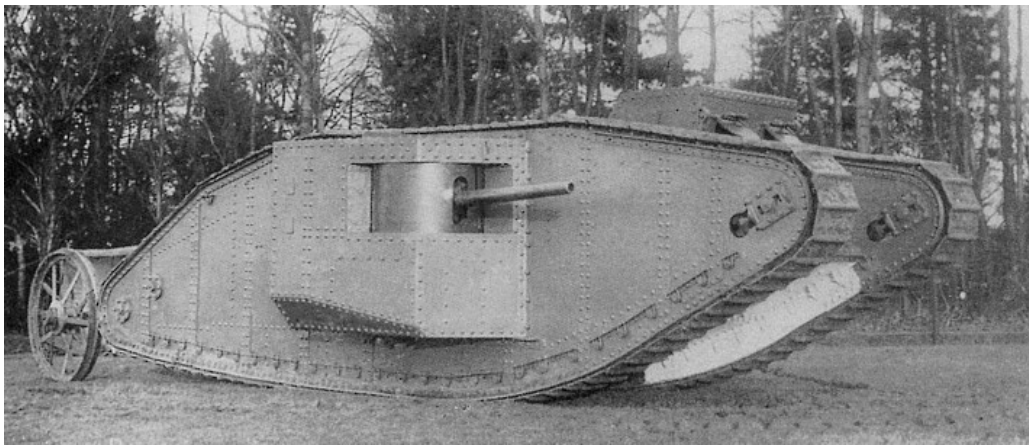

Figure 36. A British Mk I Tank (From Kempf, n.d.)

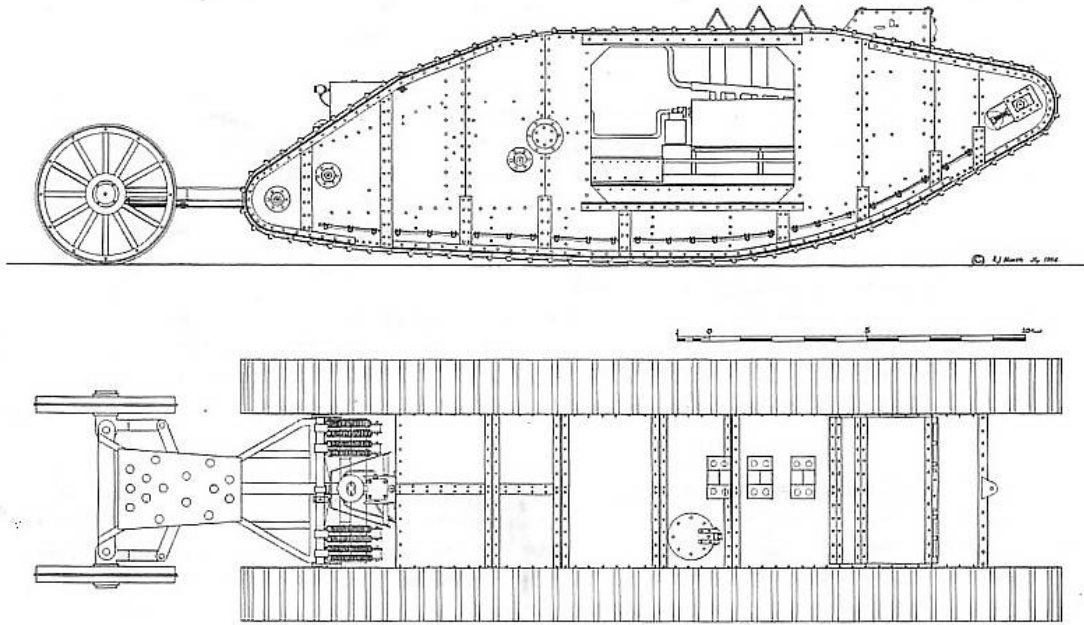

Figure 37. Side and Bottom Plan Drawings of British Mk I Tank (From Kempf, n.d.)

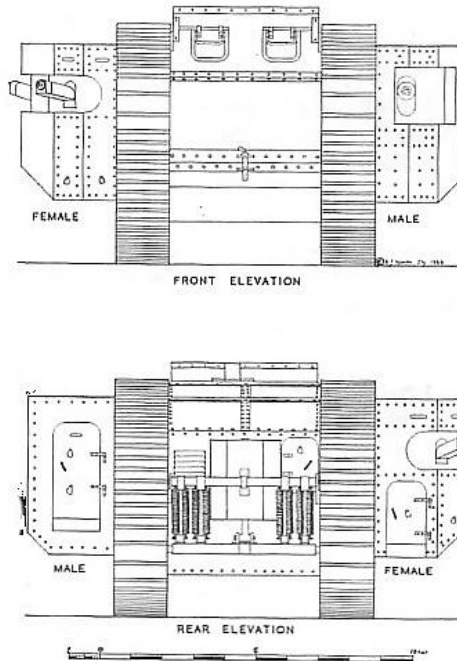

Figure 38. Front and Rear Plan Drawings of British Mk I Tank (From Kempf, n.d.)

As can be seen in the photograph and plan drawings above, the best way to describe the British Mk I tank is essentially a hardened “box,” which contains the propulsion system, armament systems as well as the tank crew. Compared to the ground vehicles of today, that fundamental function of hull armor has not changed. The hull armor must protect the vehicle contents as follows:

- Hull Front. Considering that a ground vehicle mostly engages its enemy target in the front due to the presence of the crew’s vision and sighting system, the hull front is responsible for protecting the crew (driver, gunner, loader, assistant) and the engine of the vehicle to ensure its continued mobility.
- Hull Rear. The importance of the hull rear lies in the fact that for most MBTs, the engine and transmission are located in the rear of the vehicle. However, armor thickness may be sacrificed in the rear to accommodate the vehicle exhaust systems, as well as other propulsion components that require space.
- Hull Side. Ground vehicles, especially armored vehicles, typically have larger side profiles than front profiles. Therefore, threats have a higher probability of hit if they engage the sides. Hence, the hull side is necessary to protect the contents of the vehicle. The armor thickness is likely to be comparable to that of the front, in view of the higher hit probability.
- Hull Top / Bottom. While threats from the top and the bottom were not traditionally major concerns for ground vehicles, the importance of the armor on the hull top and bottom has risen in recent times to protect the vehicle against increasing threats from those areas, particularly IEDs from the bottom.

2. Turret

With the turret providing the firepower capability to armored vehicles, the protection of the turret is extremely important to ensure mission effectiveness. The armor

protection for the turret is responsible for protecting the firing crew, armament components, sighting systems as well as ammunition. Therefore, armor can be expected to be found around the turret in the same way as it is found on the hull. Given that the turret traverses in all directions even when the vehicle is on the move, there is an equal probability of hit from all directions, resulting in armor thickness that is equivalent on all sides. Furthermore, the armor has to be particular effective against incendiary rounds to prevent the ammunition from catching fire and causing a catastrophic explosion.



Figure 39. An AMX-13 Light Tank (Note the Sloped Front Side of the Turret) (From IHS Jane's 2012)



Figure 40. A Merkava Mk 3 MBT (From IHS Jane's 2012)

3. Side Skirts

While they may seem insignificant, side skirts can be found in many modern day MBTs, as well as IFVs. The sides skirts are responsible for protecting the road wheels and suspension systems against threats.



Figure 41. A Jordanian Centurion MBT (Note the Side Skirt) (From IHS Jane's 2012)



Figure 42. A Challenger 2 MBT (Note the Thicker Side Skirt) (From IHS Jane's 2012)

4. Armor on Non-Traditional Armored Vehicles

The application of armor on non-traditional armored vehicles, such as wheeled vehicles, largely follows the same principles as for tanks. Basically, the armor is located over components that require protection from threats. Hence, armor can still be expected to be located on the hull and turret (if any).

THIS PAGE INTENTIONALLY LEFT BLANK

V. ARMOR DESIGN FOR VULNERABILITY REDUCTION

A. OVERVIEW

Recall the various types of threats against armored vehicles that were identified in Chapter III. Despite the different threats, the warheads that they deliver to the armored vehicles generally inflict damage through kinetic energy, blast warheads, metallic jets or a combination of either. There is thus a need to understand how the damage mechanisms can be characterized, thus influencing the design of the armor (in terms of thickness, density, etc.).

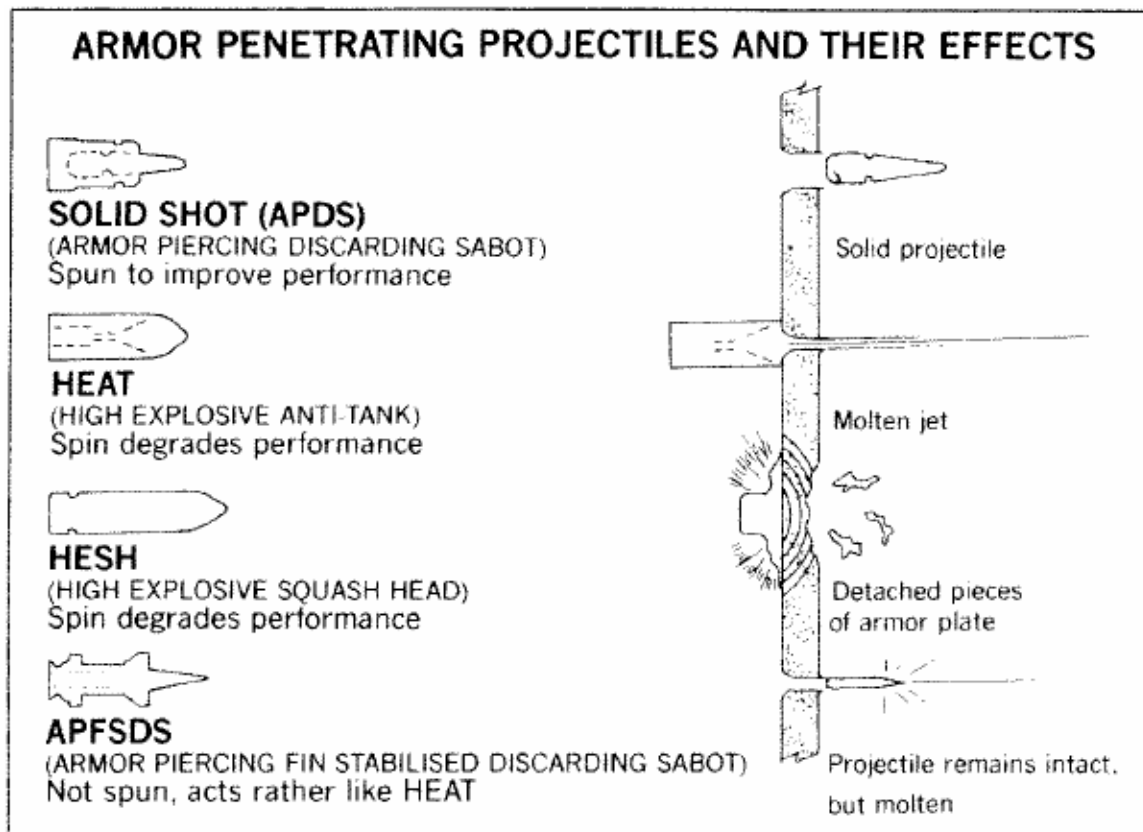

Figure 43. Figure Showing the Behaviour of Different Types of Warheads on Normal Armor (From Macksey 1988, 154)

B. THREAT DIRECTION

It must be recognized that an armored vehicle does not necessarily face the same threats in all directions. Therefore, prior to analyzing the effects of warheads on armor, there is a need to understand how the probability of hit varies on different sides of the vehicle. This, in turn, can affect the necessary protection to be designed. Recall the various angles at which the various threats can hit armored vehicles:

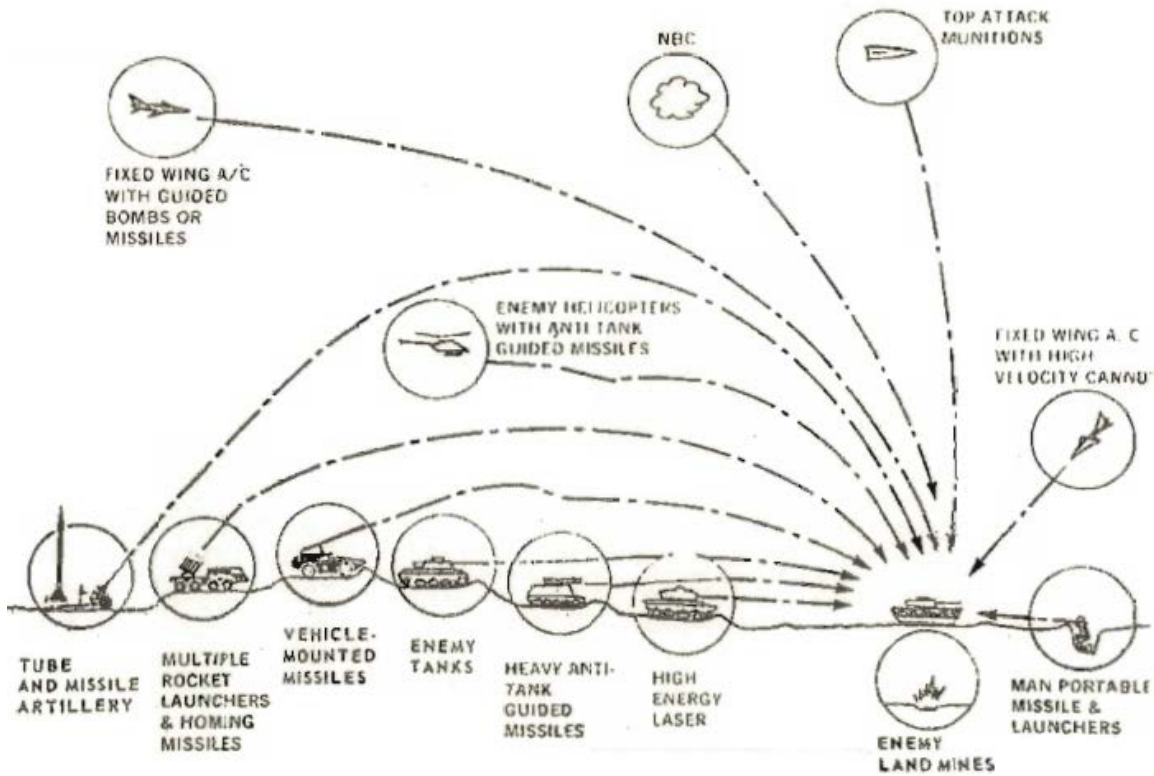

Figure 44. Vertical Threat Envelope (From a Abrams Tank System Survivability Briefing in Jan 2012)

Figure 45 shows the hit probabilities based on the horizontal angle from the front of the vehicle. It can thus be seen that the hit probability follows a cardioid distribution.

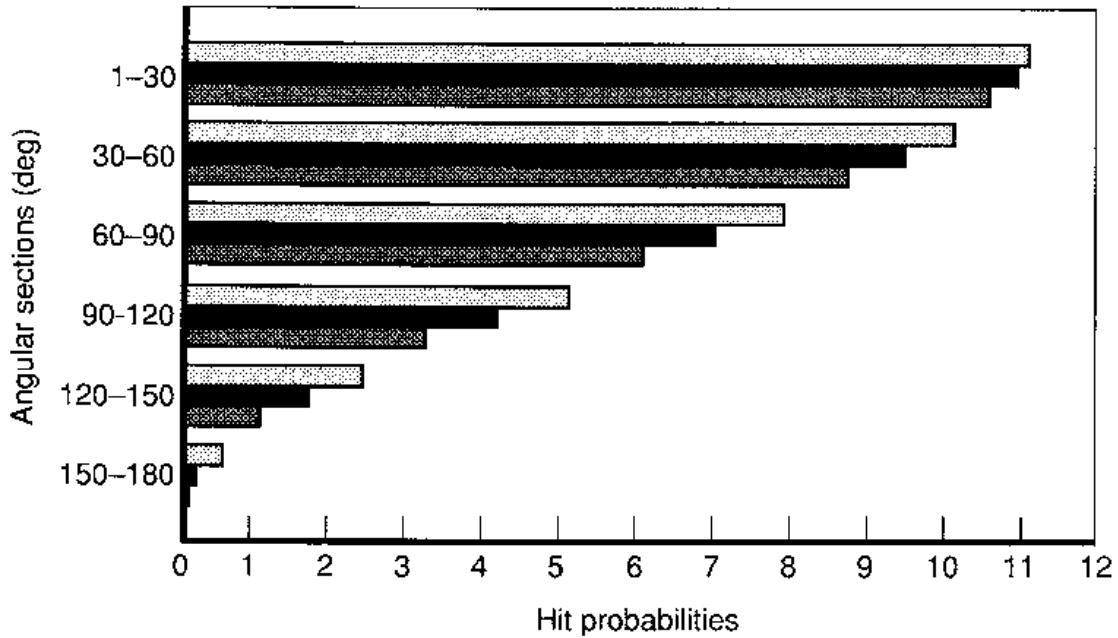

Figure 45. Hit Probability Variation with Angle from Front of Vehicle (From Steeb, Brendley, Norton, Bondanella, Salter and Covington, 1991, 12)

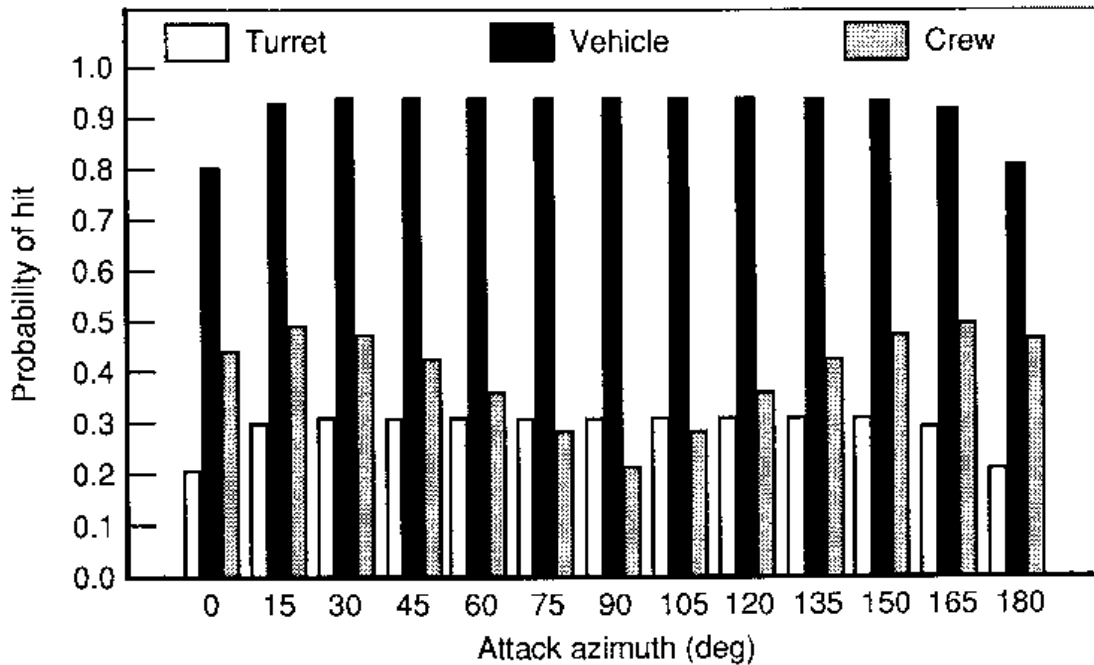

Figure 46. Probability of Hit on Two-Man MBT from Tank Gun at 1km Range (From Steeb, Brendley, Norton, Bondanella, Salter and Covington, 1991, 21)

Using a simple assumption of equal damage with each hit, this suggests that the armor should be designed to be more effective (either in terms of thickness or hardness) closer to the front of the vehicle and can be negligible at the rear of the vehicle. In reality, however, that is not necessarily true, as many ground vehicles have critical components located in the rear, such as engines and troops. Thus, the design of armor in response to hit probabilities may only change subtly, especially in today's non-linear battlefield, where threats are equally likely to be from any direction.

C. HULL DESIGN

1. Thickness

As can be seen from the formulae in the previous sections, an increase in the thickness of the hull's armor plating can reduce the ability of a projectile to penetrate completely. As of 1989, the frontal armor of the M1 tank has risen to 1000–1200mm RHA against shaped charge and 500–600mm against kinetic energy projectiles (Ogorkiewicz 1995, 11).

However, care must be taken not to have too thick an armor, as it will add unnecessary weight to the vehicle, thus increase fuel consumption and suspension requirements. To better understand the tradeoff between, it is convenient to calculate the marginal increase in weight with any marginal increase in armor thickness. In order to do so, a typical model of a tank has to be adopted. An appropriate model uses the dimensions that were adopted by RAND in the RAVUM analysis code in 1991, as shown below:

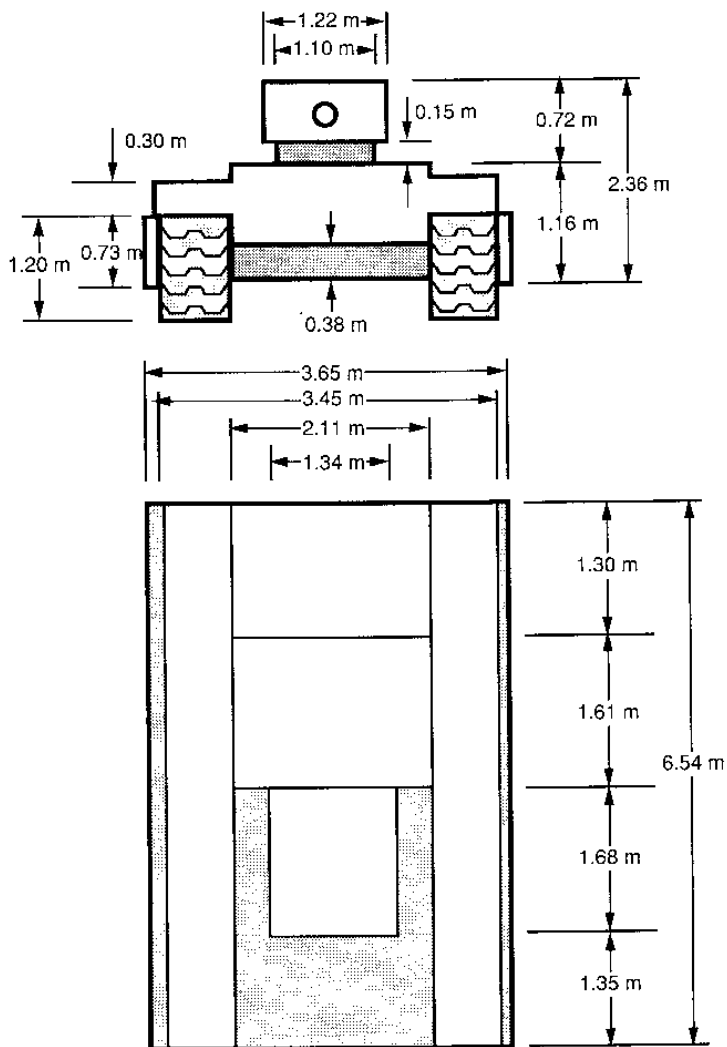

Figure 47. Typical Hull Dimensions Model (From Steeb, Brendley, Norton, Bondanella, Salter and Covington, 1991, 15)

As a calculation, an increase in 1mm of steel armor can increase the weight of a typical armored vehicle by at least 3,960 kg. Despite the considerations for tradeoff, the design of most modern armored vehicles allow for the installation of applique (or add-on) armor, which consists of additional protective plates that can be retrofitted onto the vehicle to increase the armor thickness and enhance the protection should the threats be able to penetrate the existing armor.

2. Sloping

As an alternative to increasing thickness, the sloping of armor can result in the simultaneous effects of increasing the effective thickness (in the horizontal) of the armor and deflection of AP projectiles and blasts.

- Effective Thickness. The effect of sloping armor on the effective thickness of the armor can be seen from a geometric point of view.

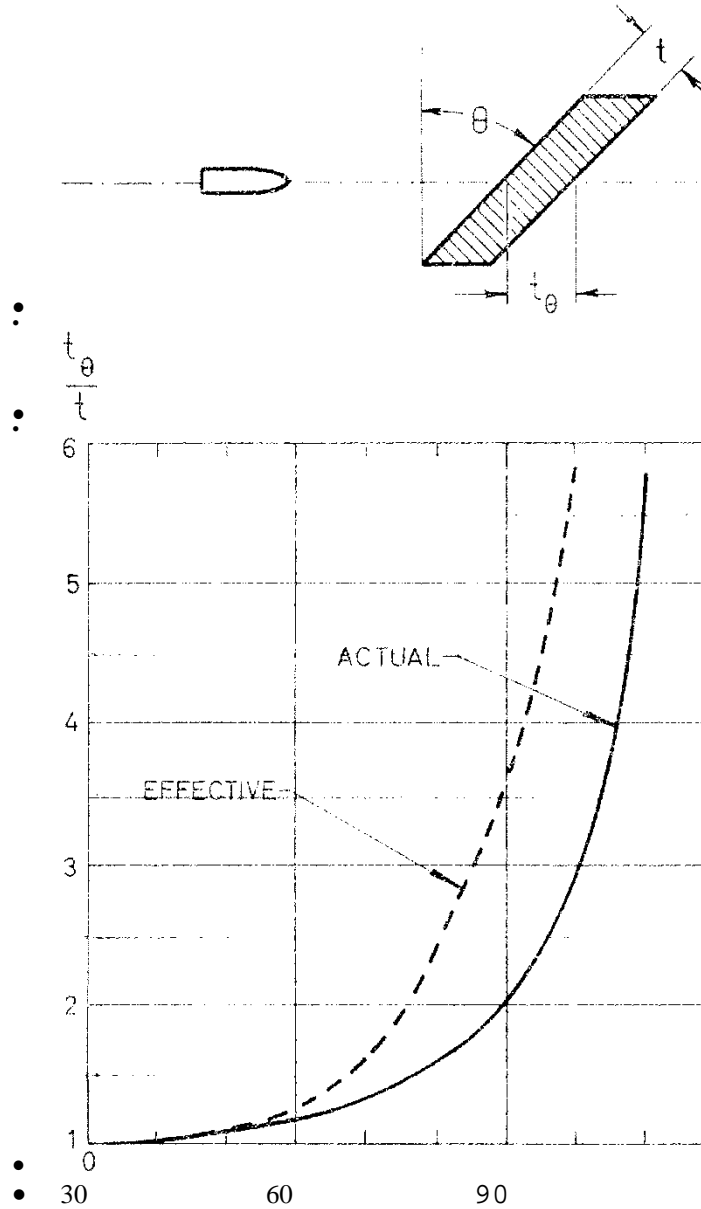

Figure 48. Effects of Inclining Armor on Effective Thickness (From Ogorkiewicz 1968, 83)

As can be seen from Figure 48, inclining armor can drastically increase the effective thickness. An incline of 60 degrees can, in actuality, provide protection equivalent to twice of the original thickness.

- Projectile Deflection. By hitting a surface in any way other than head-on, a projectile is more likely to be deflected. Increasing the armor sloping results in the loss of energy of projectile to change its velocity in the direction of the armor's slope, thus resulting in an inability to penetrate the armor. A simplified energy model (neglecting the effects of friction) would be:

$$\frac{E_d}{E_k} = \sin^2 \alpha$$

where E_d = energy transferred to armor
 E_k = incident energy of projectile
 α = armor slope angle

Since $|\sin \alpha|$ can never exceed 1, the energy transferred to the armor will always be lower than the incident energy.

Typically, projectile deflection is most effective at angles of 50° to 60°. However, it must be noted that deflection effects are more applicable to low-velocity projectiles that have a low length-to-width ratio. Hence, it is more likely for small arms rounds (such as from rifles) to be deflected than artillery shells or long rods.

- Blast Deflection. Apart from deflecting projectiles, hull sloping can dissipate the energy resulting from a blast, thus reducing the probability of rupturing the hull. This forms the basis behind V-shaped hulls on many modern vehicles, such as the Stryker and Husky Mk III.



Figure 49. A Demonstrator Model of the Marine Personnel Carrier (MPC). Notice the V-shaped Hull at the Bottom of the Vehicle. (From Lamothe 2010)

3. Material

As mentioned earlier, the armor must be able to withstand penetration by projectiles / fragments and damage through blast. Hence, the key properties of armor materials are tensile strength to withstand blast and hardness to resist penetration (Ogorkiewicz 1968, 83). Right until the 1960s, the most common materials used for armor were as follows (Ogorkiewicz 1968):

Material	Tensile Strength (MPa)	Brinell Hardness	Density (kg/m³)
Nickel-Chrome-Molybdenum Steel	965–1103	300	7700–8030
Cast Steel	370	130–235	7700–8030
Aluminum Alloy 5083	317	87	2650

Table 15. Tensile Strength and Brinell Hardness of Typical Armor Materials

Comparing aluminum alloy to cast steel, it can be seen that aluminum offers lower tensile strength and hardness, which results in poorer performance as an armor material. However, recall the earlier discussion on weight penalty of increasing armor. While a 1mm increase in cast iron armor thickness results in a 3,960kg increase in weight, a similar increase in aluminum alloy armor thickness merely results in a weight increase of 1,337kg. This equates to a 16.7% improvement in performance with a 196% greater weight increase. To better improve the tradeoff between performance and weight, nickel, chrome and molybdenum are added to steel to increase the hardness and strength of the steel. While the weight increase remains the same as with cast steel, the performance is 204% better.

Alternatively, in order to exploit the various properties of different materials without incurring too much of a weight penalty, armored vehicles have adopted the use of sandwich armor plating, such as layers of ceramics or polymeric materials with basic steel (Ogorkiewicz 1995, 12). Such an arrangement has thus resulted in the development of composite armor that is “two to three times” as effective as RHA of the same weight (Ogorkiewicz 1995, 12). Chobham armor, which was mentioned earlier, is an example of such armor. Recall from an earlier section that the M1 Abrams, which utilizes Chobham armor, has 1000–1200mm RHA against shaped charge and 500–600mm against kinetic energy projectiles.

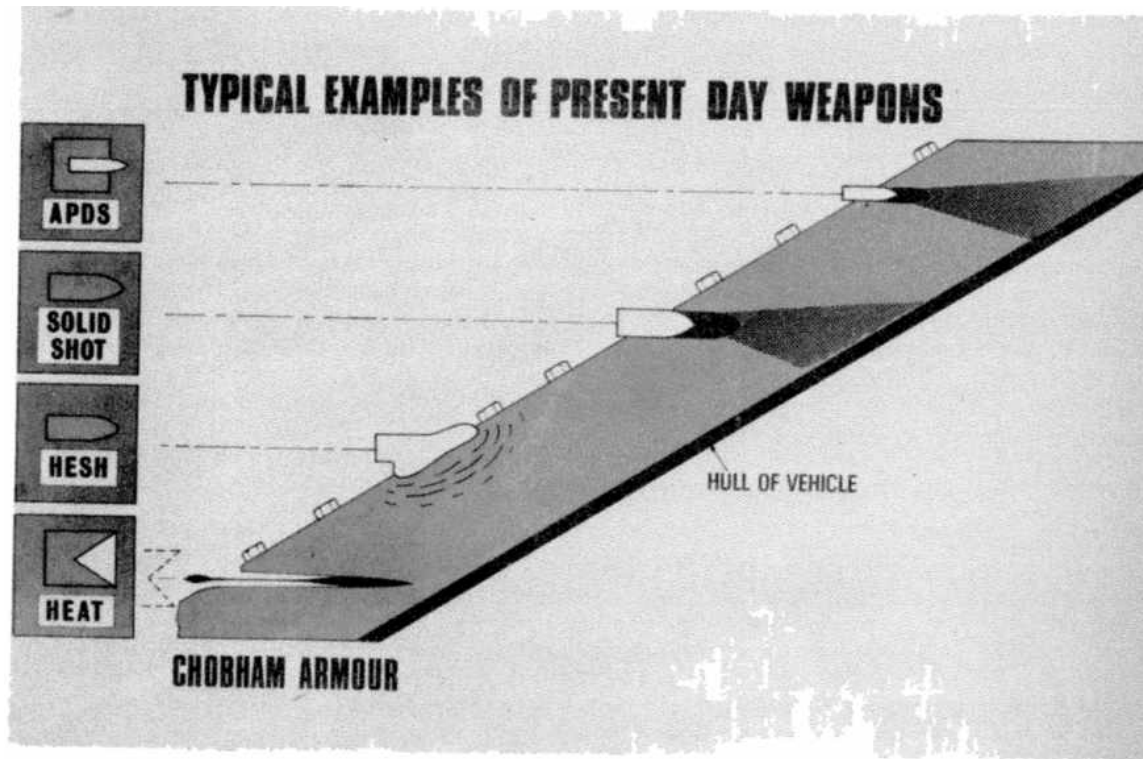

Figure 50. Figure Showing the Behavior of Different Warheads on Chobham Armor (From Foss 1977, 430)

4. Explosive Reactive Armor (ERA)

Originally used on a large scale on Soviet T-64BV, T-72B and T-80BV tanks (Ogorkiewicz 1995, 12), ERA consists of an explosive liner that is sandwiched by two metal plates and is mounted on the hull of a vehicle, usually at locations which are more susceptible to hits.

Recall that metallic jet warheads penetrate armor by the rapid extension of a molten jet of metal (usually copper). Upon the impact of a warhead, the explosive liner in the ERA explodes, thus creating energy that dissipates the energy of the forming metallic jet. This prevents the metallic jet from forming properly, thus reducing its effectiveness.

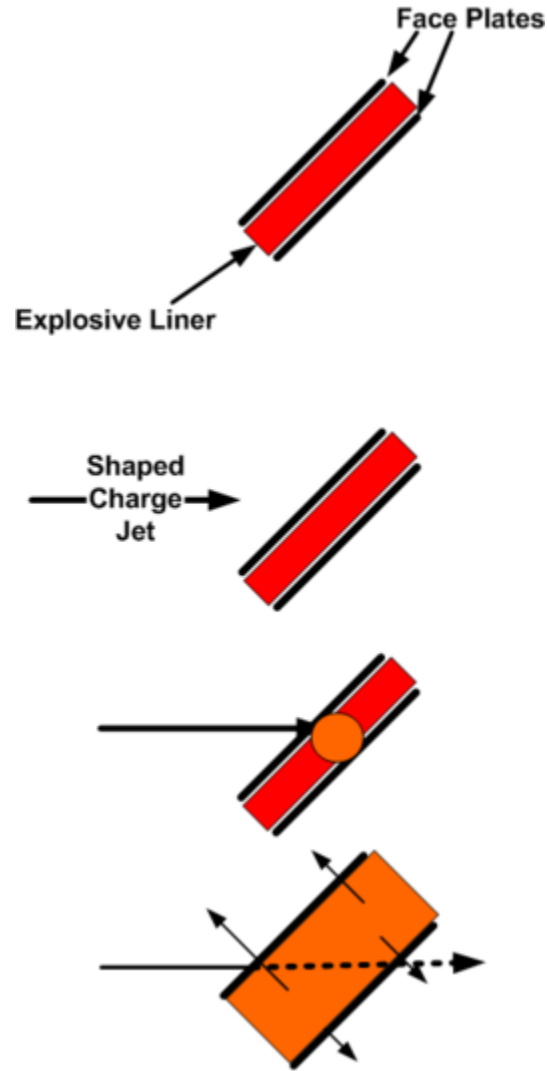

Figure 51. How Explosive Reactive Armor Works (From Berkholz 2009)

It is important to note that an exploded segment of the ERA can is not regenerative, and thus cannot protect the same area against a second shot. Therefore, in the design of the ERA in terms of composition, it is necessary to design it such that it is not reactive to kinetic energy projectiles or fragments (such as from artillery shells). Typically, this is achieved by having a thicker or harder outer face plate, similar to designing armor against projectiles.

Another key point to note about ERA is how the blast from the ERA explosion can potentially injure the vehicle's occupants. Therefore, ERA cannot be mounted on

vehicles whose hulls are made of softer materials such as aluminum, which cannot withstand the impact of a blast. A way to get around such a problem would be to mount an additional layer of steel over the aluminum hull prior to mounting the ERA. The Bradley IFV is an example of a vehicle that employs such a technique, with about an inch of steel between the ERA and hull.

5. Slat Armor

Despite being very effective against RPGs, slat armor is simply achieved by the mounting of a cage or fence around the vehicle. It defeats RPG rounds by two means:

- Stand-off. The first method that slat armor protects a vehicle is by providing a physical barrier between the shaped charge and the vehicle hull. This allows most of the metal jet to be formed outside of the vehicle, and thus it is unable to penetrate the armor. Therefore, when designing the slat armor, it must be placed at a distance that is greater than or equal to the effective jet length of the threat that the vehicle is expected to face.
- Prevention of Trigger. Slat armor also defeats RPG rounds by preventing the triggering of the fuze. When a RPG round is caught between two bars of the slat armor, the nose deforms and is bent inwards, resulting in a short circuit of the triggering system. Hence, any signals from the fuze cannot reach the detonator, thus preventing the round from exploding.

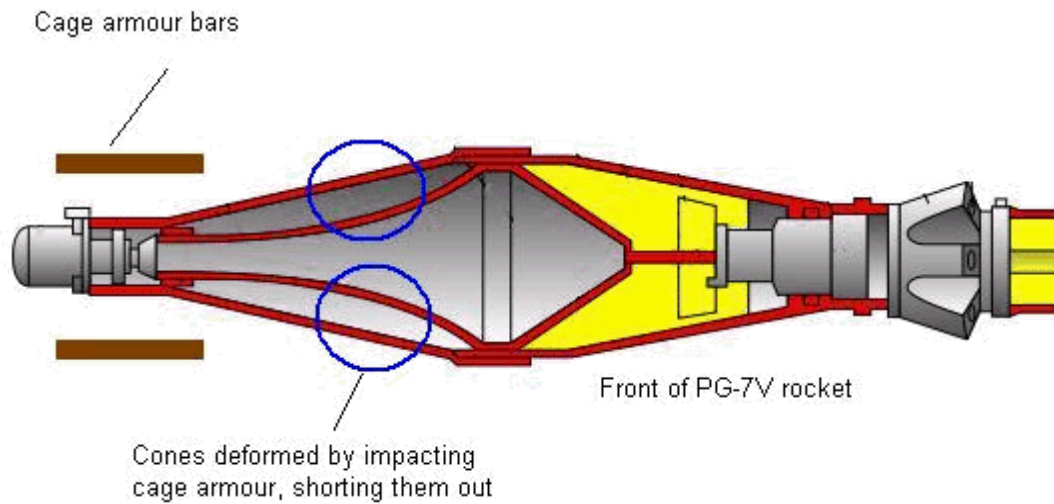

Figure 52. How Slat Armor Defeats an RPG Round (From Novel Defence Engineering 2012)

This method of defeating shaped charges thus dictates a key aspect of the slat armor design: the cage spacing. In order to maximize the probability of effectiveness, the cage spacing must be less than the diameter of a typical RPG round. We can notice that most slat armor have a cage spacing of approximately 72mm, which is smaller than the 85mm diameter of the common RPG-7 round.

Another method of applying slat armor is demonstrated by the chain links that are installed under the turrets of the Merkava MBT. They function in the same way as the cage armor does on the Strkyer. Similarly, the spacing between each chain link is approximately 78mm, smaller than the diameter of a RPG-7 round.



Figure 53. A Rear View of the Merkava Mk III. Notice the Curtain of Chain Links Hanging from the Turret. (From Army-technology.com 2011)

D. COMMON MODERN DAY STANDARDS

With regard to the effectiveness of armor in performing its tasks, there are some standards that are referred to by many armor developers and nations to assist in the design and development of ground vehicles.

1. MIL-STD 662F – V50 Ballistic Test for Armor

The purpose of this testing standard is to provide general guideline for procedures, equipment, physical conditions, and terminology for determining the ballistic resistance of metallic, nonmetallic and composite armor against small arms projectiles (From Department of Defense 1987, 1).

2. NATO STANAG 4569 - Protection Levels for Occupants of Logistic and Light Armored Vehicles

Level	KE Threat			Grenade & Mine Blast	Artillery
	Bullet	Distance	Velocity		
I	7.62 x 51 NATO Ball (Ball M80) 5.56 x 45 NATO SS109 5.56 x 45 M193	30m	833m/s (M80) 900m/s (SS109) 937m/s (M193)	Hand grenades, unexploded artillery fragmenting submunitions	
II	7.62 x 39 API BZ	30m	695m/s	6kg Blast AT Mine	
III	7.62 x 51 AP (WC core) 7.62 x 54R B32 API (Dragunov)	30m	930m/s (51 AP) 854m/s (54R)	8kg Blast AT Mine	
IV	14.5x114AP / B32	200m	911m/s	10kg Blast AT Mine	155mm HE at 30m
V	25mm APDS-TM-791 or TLB 073	200m	1258m/s		155mm HE at 25m

Table 16. Protection Level Criteria for STANAG 4569 (From CRAIG International Ballistics 2012)

THIS PAGE INTENTIONALLY LEFT BLANK

VI. CONCLUSION

A. CONCLUSION

Having looked the development of armor over a period of almost a century, it can be seen that the protection of ground vehicles is a function and response to the threats that they face. While the simplest way of improving armor is by making it thicker or stronger, such a solution will reach a saturation point where it is no longer practical. Already, with the development of shaped charges that are capable of penetrating thick armor, armor development has to go beyond that of just thickness or materials. This requires the constant innovation, as well as a strong understanding of the physics behind threat-armor interaction.

B. WAY AHEAD

In order to further develop this area of study, there must be more information made available to analyze the success or failure of different armor developments. By studying the probability of hit and / or kill, the effectiveness of armor can be better characterized. Specifically, data from more recent conflicts, such as OIF / OEF would be immensely useful and can provide better in-depth analysis.

Furthermore, studies can be made into the development of armor for susceptibility reduction. While this may not have been traditionally a key aspect for ground vehicles, emphasis should be place on it in the future to prevent vehicles from being hit to start with.

THIS PAGE INTENTIONALLY LEFT BLANK

APPENDIX. APPLICATION OF SURVIVABILITY ENHANCEMENT CONCEPTS IN GROUND VEHICLES

A. OVERVIEW

The purpose of survivability enhancement is to increase the capability of the ground vehicle to avoid, withstand and / or recover from damage in a hostile man-made environment (Deitz, Reed, Jr, Kloplic and Walbert 2009, 3). Hence, survivability enhancement concepts can be classified under Susceptibility Reduction, Vulnerability Reduction and Reparability Enhancement.

Susceptibility Reduction	Vulnerability Reduction	Reparability Enhancement
Noise Deceiving and Jamming	Component Location	Maintenance Sensing
Expendables	Component Shielding	Forward Maintenance
Signature Reduction	Component Redundancy	Recovery with Speed
Threat Suppression	Component Elimination / Replacement	Modular Components
Threat Warning	Passive Damage Suppression	Maintenance Supply Chain Resilience
Tactics	Active Damage Suppression	Component Repair

Table 17. Survivability Enhancement Concepts

B. SUSCEPTIBILITY REDUCTION

1. Noise Deceiving and Jamming

Jamming techniques are rare, but do exist in the form of infrared (IR) jamming systems designed to jam the IR seekers / trackers that are employed by

certain anti-tank missiles. One such armored vehicle that utilizes the IR jamming method is the Indian Arjun tank.

2. Expendables

In order to provide concealment during missions, armored vehicles can employ smoke screens. This can be done either through

- Smoke Grenade Launchers (SGLs). SGLs are usually found mounted on the top of vehicles, or at the side of the turrets of armored vehicles. The shells are normally launched by means of an electrical switch that is triggered from within the vehicle.
- Exhaust Systems. A smoke screen can also be generated by vaporizing the fuel and introducing the vapor into the exhaust system. The main advantage of this method is that the smoke screen can be kept for as long as required, until there is insufficient fuel left.



Figure 54. Smoke Concealment Using SGLs (Left, Circled) (From Army Recognition Magazine 2007) and Exhaust Systems (Right) (From DefenseImagery.mil, n.d.)

3. Signature Reduction

Despite their relative large size amongst ground forces, armored vehicles still employ several techniques to reduce their signature, thus reducing the probability of detection:

- Visual. Armored vehicles are usually painted in the same color as the environments that they are expected to operate in. Similarly, some countries paint their armored vehicles in a camouflage pattern, similar to military uniforms. Such a technique aims to blend the vehicle with the background, thus reducing the probability of detection by visual means.



Figure 55. Reduction of Visual Signature: M1A2 Abrams (left) in a Desert Environment (From U.S. Army 2011) vs Terrex Infantry Carrier Vehicle (Right) in a Jungle Environment (From Ministry of Defence, Singapore 2009).

- Infrared. Many modern anti-tank weapons (such as the Javelin anti-tank missile) employ IR systems as targeting methods or seekers, making use of the high temperature regions of armored vehicles (exhaust, engine, solar radiation) to track them for the hit. In order to reduce the probability of being targeted or tracked, there is a need to reduce the IR signature of these vehicles. Methods include painting a vehicle with anti-IR / anti-thermal paint and covering with a camouflage layer that has a low absorption of solar radiation. In general, these methods aim to reduce the amount of IR radiation absorbed and emitted by the vehicle, so as to blend it with its surroundings.



Figure 56. IR Signature of M1A1 Abrams MBT without (1) and with (2) Anti-Thermal Paint (From Crane 2005)

- Acoustic. The amount of noise generated by armored vehicles is something that can be used by enemy soldiers to detect their presence within the vicinity. The main sources of an armored vehicle's acoustic signature are its engine, exhaust as well as metal tracks. Hence, the acoustic signature can be reduced by utilizing wheels instead of tracks, replacement of metal tracks with rubber tracks, as well as the installation of sound-absorbing materials in the engine compartment to reduce the generated noise.
- Physical Profile. The height, length and width of an armored vehicle can influence its visual signature, and thus its probability of detection. While most components of an armored vehicle is of a standard size, there have been several techniques of reducing the physical profile. One such method is to adopt a reclining position for the driver, instead of an upright sitting position. This allows the driver compartment to adopt a lower height, thus reducing visual signature. Many modern tanks, such as the Chieftain tank and M1A1 Abrams adopt such a measure. Another key change in design that has influenced the height of armored vehicles is the method of cartridge disposal. Modern tanks tend to dispose of empty cartridges out of

the vehicle immediately after firing, thus reducing the size required for the turret and hence physical profile.

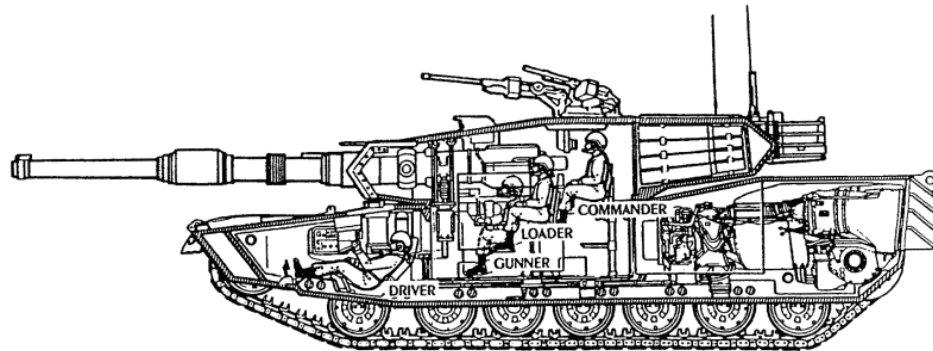

Figure 57. Crew Layout inside the M1A1 Abrams, Showing the Reclined Driving Position (From Cooke 2008)

4. Threat Suppression

Since most armored missions have the end state of overcoming an enemy within a hostile environment, the ability of an armored vehicle to suppress enemy threats is closely linked to its lethality as an offensive weapon. On the individual platform level, it is thus important for the vehicle to establish firepower superiority over its threats by having more effective armament in terms of range and lethality. This is translated into the need to have larger caliber guns than the enemy, or the installation of guided weapons, such as TOW missiles on the M2 Bradley. On the tactical / operational level, the importance of tactics will be crucial as well. See *Tactics* for more details.

5. Threat Warning

Threat warning can identify both potential and incoming threats, so as to allow the armored vehicle operator to take the appropriate action to counter such threats. The key enablers for both types of threat warning are:

- Potential Threats. The main method of identifying potential threats is through the use of reconnaissance. This can be done through the employment of scouts or other reconnaissance technologies such as unmanned aerial vehicles (UAVs) to capture imagery of the hostile

environment for analysis prior to the mission. While such information was traditionally reviewed prior to the mission, the pace of modern day warfare requires up-to-date information and intelligence to be relayed to fighting units. Hence, the use of a battlefield management system allows for fighting vehicles achieve better situational awareness and avoid potential threats within a hostile environment.

- Incoming Threats. The use of sensors onboard armored vehicles can allow the crew to sense and identify the source of threats. Sensors can make use the various signatures of the threats, such as IR or acoustics. For example, the Terrex ICV employs a Weapon Detection System (WDS) consisting of microphones to detect the location of snipers based on the sound from prior shots fired. Similarly, the Arjun tank employs an Advanced Laser Warning Countermeasure System (ALWCS) to warning it against incoming threats.

6. Tactics

Proper planning prior to a mission can help identify potential areas of higher susceptibility within the area of operations. Mission planning can also reduce susceptibility in the following ways:

- Support Fire. The employment of support fire, such as artillery strikes and close air support, prior to the introduction of fighting vehicles into the hostile environment can result in managed attrition of enemy forces. This, in turn, will reduce the probability of engagement on the vehicles, enhancing survivability.
- Relative Combat Power. Proper mission planning will also identify the combat strengths and weaknesses of both forces, thus allowing tactics to be adjusted accordingly. In an armor-on-armor scenario, should the enemy's firepower be superior (either in terms of caliber or range), the tactics can then make up for it by increasing the relative combat power. An example of such a tactic was the employment of three to four M4

Sherman tanks to engage German Tiger tanks during WWII to make up for the Tiger's one-on-one superiority.

C. VULNERABILITY REDUCTION

1. Component Location

With protection being one of the critical tasks of armored vehicles, it is thus paramount that components are situated within the confines of the armor protection to reduce their vulnerability without sacrificing mission effectiveness. The location of the crew and troops within an armored vehicle is an example of how component location can enhance a vehicle's survivability. Furthermore, critical components contributing to the same function on the vehicle are usually located together to reduce the vulnerable area. In the propulsion subsystem, for example, the engine and transmission gearbox are normally located next to each other to give a compact power train package. Its location in the front of the vehicle can also help protect the driver.

2. Component Shielding

The key to component shielding in armored vehicles lies in the protection that is provided by the armor hull / chassis itself. In general, the armor protection must provide adequate protection against both blast and penetration effects, which are the most common kill modes caused by anti-armor threats. The main aspects of armor selection that influence its effectiveness are:

- Material. The main material properties of interest when it comes to armor design are tensile strength and hardness, which affect its ability to withstand penetration from a round. Prior to the Vietnam War, armor was usually manufactured from steel, which is known to be a very hard material. However, with the need to transport more and to produce airlift capabilities, many armored vehicles have since been fitted with aluminum armor, with the M113 being the first to do so (Macksey 1980, 218). Other materials that have been used in armor include titanium, ceramics,

plastics and fiberglass. It should also be noted that different materials can also be used together to reinforce and strengthen the armor against variable types of threats.

- Thickness. With increasing thickness, the armor can provide an increasing barrier against penetrators and blast warheads. As shown in the WWII example, tank designers normally increase the armor thickness as a first step to counter the stronger firepower of enemy threats. In the modern battlefield, in order to strike a balance between protection and mobility, vehicles can be designed to have add-on armor mounted in scenarios whereby the threats are beyond what the vehicles are originally designed for.
- Hull / Chassis Design. As a substitute for increasing armor thickness, designers can also adjust the slope of the armor in order to increase the effective thickness of protection. It is shown that plates inclined at 50 to 60 degrees to the vertical can provide the same level of protection as vertical plates of much greater thickness (Ogorkiewicz 1968, 82). Other than increasing effective thickness, incorporating sloped armor in a hull / chassis design can also allow for deflection of projectiles and shrapnel away from critical areas, thus reducing vulnerability. Examples of such application are the sloping of armor on the German Panther tank in WWII and the use of the V-hull on the Stryker, which has provided much improved protection against Improvised Explosive Devices (IEDs) in recent conflicts.
- Reactive Armor. In response to the threats provided by shaped charges, reactive armor has been developed in order to reduce the penetration power of the penetrator. Reactive armor normally consists of explosive charges placed over the body of an armored vehicle, being metal plates. Upon penetration from a shaped charge, these explosive charges will

detonate, creating fragments and blast effects that can either disrupt the penetrator or reduce its energy available for penetration.



Figure 58. T-72 Tank with Reactive Armor (From Federation of American Scientists 2000)

3. Component Redundancy

Given the relative small size of armored vehicles compared to aircraft and ships, the application of component redundancy with separation can be quite limited. Despite this, there are still some key redundant features that can be found on many armored vehicles. Some examples of these include:

- Fuel Tanks. Vehicles such as the Bionix IFV are designed with two fuel tanks that are located on both sides of the vehicle. While such a measure not only increases the fuel capacity, it also allows reduces the probability of critical failure in the event that one fuel tank is hit.
- Road Wheels. Tracked armored vehicles have multiple road wheels to allow a better weight distribution on the tracks and ground. This also provides a limited form of redundancy whereby if one or two of the road wheels on one side are damaged, the vehicle still remains mobile, albeit with possible degraded capability.

- Turret Traverse / Elevation System. The turrets on modern day armored vehicles are controlled using electronic and / or hydraulic systems. However, in the event that the electronic and / or hydraulic circuits are damaged, the turrets are usually designed to allow the crew to manually control the turrets using hand cranks and gears, albeit at a slower rate.
- Crew. Tank crews consist of the driver, gunner, commander and loader. While most tank crew members are trained for their specialized functions, they are usually equipped with basic training in other functions as well. This allows certain members to replace others in the event of a member of the crew being incapacitated. For example, a commander would have undergone gunnery training so as to replace the gunner. However, it must also be noted that while there is redundancy, performance will still be degraded because of the reduction in overall manpower to perform the same number of tasks.

4. Component Elimination / Replacement

The speed and ease at which damaged components can be replaced influence the turnover rate of damaged vehicles. Fast and effective component replacement can thus become a combat multiplier, and improve the overall campaign survivability. This effectiveness can be influenced at both the micro and macro levels. At the micro level, it is dependent on the design of the vehicle, which in turn influences the location of critical components. In the Leopard 2A4 tank, for example, the power pack is designed to be removed within 30 minutes, which allows for an extremely fast turnover of vehicles. At the macro level, it is affected by the maintenance support concept supporting the vehicles (ie level of maintenance, location of maintenance echelons and tools / spares made available during the mission).

5. Active Damage Suppression

Active damage suppression requires the installation of sensors and systems to identify and then reduce or eliminate the effects of the damage that is inflicted on the

vehicles. Due to the power requirements of additional sensors and automatic systems, they are generally less common than passive damage suppression techniques on vehicles which are already facing space and power limitations. One active damage suppression technique is the implementation of automatic fire extinguishing systems (AFES) in the engine compartments of armored vehicles, which can detect the presence of a fire (due to weapon impact or engine malfunction) and thus activate a fire extinguisher within the compartment. Also, since the tank crew is considered as a component of an armored vehicle, first aid that is applied to injured crew members is also an important active damage suppression technique. This emphasizes the importance of crew training to manage and deal with scenarios during which the vehicle is hit.

6. Passive Damage Suppression

As mentioned previously, in order to minimize power consumption through additional sensors and automatic systems, it is generally preferable to incorporate damage suppression measures into the overall existing structure of the armored vehicle. Some of these measures include:

- Armor Material Selection. As mentioned before, the choice of material for the armor can affect the vulnerability of the vehicle. However, material selection must also take into account of any side effects when hit. For example, aluminum, while strong, produces fumes that are harmful for the occupants of the vehicle when inhaled. Hence, selection of alternative materials such as titanium can easily prevent such a scenario from occurring.
- Run-Flat Tyres. For wheeled vehicles, the tyres are considered critical components since they transmit the power generated by the engines to the ground for propulsion. Deflation of tyres by shrapnel or fragments can thus result in lack of propulsion as well as control. The hardening of tyres can thus allow them to continue functioning despite any damage. Run-flat tyres can take on two possible forms: hardening foam used to inflate tyres instead of air, as well as solid tyres that do not require inflation.



Figure 59. An Example of Airless Tyre Installed on a Humvee (From Greenemeier 2008)

- Self-Sealing Fuel Tanks.** The main damage mechanism that results from the penetration of a fuel tank is fire that is perpetuated by the leaking fuel. In addition, the loss of fuel can cause vehicles to lose range and hence effectiveness. Self-sealing fuel tanks consist of multiple layers of rubber that can expand upon absorption of fuel, thus sealing any holes produced by projectiles. The Jackal armored wheeled vehicle used by the British Army is one such vehicle that utilizes such fuel tanks.

D. REPARABILITY ENHANCEMENT

1. Overview

In order to understand the various concepts that can enhance the reparability of armored vehicles, it is necessary to establish the entire repair process chain within a battlefield:

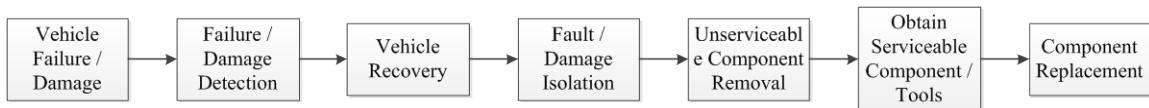

Figure 60. Repair Process Chain

The various stages of the field repair process are as described:

- Vehicle Failure / Damage. This stage refers to the act of the vehicle failing to perform one or more of its intended functions due to either failure or damage inflicted on one or more of its components.
- Failure / Damage Detection. This refers to the ability of the vehicle to detect the presence of a component failure or damage, with or without the knowledge of the operator.
- Vehicle Recovery. This stage refers to the retrieval of an unserviceable vehicle from its current breakdown location to another location which is more suited for repairs to take place. That suitable location can either be another more sanitized location in the area of operations or a maintenance depot that is outside the area of operations.
- Fault / Damage Isolation. Whenever a fault occurs, it can be a symptom of an underlying fault or damage. This stage in the repair process aims to identify the exact location and extent of the unserviceable component(s) within the vehicle.
- Unserviceable Component Removal. In order to rectify any faults or damages to the vehicle, there is a need to replace the affected relevant component. As a first step towards the component replacement, the unserviceable component must be detached and removed from the rest of the vehicle.
- Obtain Serviceable Component / Tools. In order to perform the actual component replacement, both the spare serviceable component and necessary tools must be made available. Hence, this stage refers to the steps required to deliver the necessary components and tools to the location of repair. The serviceable component can be obtained either through a maintenance supply chain or component repairs.

- Component Replacement. This stage refers to the final action of replacing the unserviceable component with a serviceable one that is obtained from the previous stage. Upon the completion of this stage, the vehicle is considered to be serviceable, and is ready to be deployed to action again.

Having understood the various stages of the vehicle repair process, the reparability enhancement concepts can be deduced and formulated:

Stage	Reparability Enhancement Concepts
Vehicle Failure / Damage	
Failure / Damage Detection	Maintenance Sensing
Vehicle Recovery	Forward Maintenance Recovery with Speed
Fault / Damage Isolation	Maintenance Sensing
Unserviceable Component Removal	Modular Components
Obtain Serviceable Component / Tools	Maintenance Supply Chain Resilience Component Repair
Component Replacement	Modular Components

Table 18. Reparability Enhancement Concepts

2. Maintenance Sensing

Maintenance sensing refers to the use of onboard sensors within a vehicle and / or its components that can detect the presence of any faults or damages to the system. The purpose of maintenance sensing is twofold:

- Early Detection and Corrective Action. With constant health monitoring, the presence of any faults or damages can be detected as soon as possible (preferably upon the onset of the damage). With that, the operator can be aware of the damage at the earliest opportunity, thus allowing the

necessary corrective actions to be conducted as soon as possible and minimizing the vehicle's effectiveness downtime.

- Minimizing Compounding Faults / Damages. Any faults or damages present in a component within the vehicle can possibly result in the subsequent accelerated deterioration of other components that are linked to it. As a result, faults and damages can be compounded within a vehicle if left unchecked. With the early detection and rectifications, such compound damages can be prevented, further reducing vehicle downtime.

Enablers of maintenance sensing include Condition-Based Maintenance Plus (CBM+) that allows “real-time assessment of weapon system condition obtained from embedded sensors and / or external tests and measurements using portable equipment” (Acquisition Community Connection).

3. Forward Maintenance

One of the contributing factors to the turnaround time of a vehicle is the vehicle recovery stage. This is particularly so if the area of operations is large, and thus the vehicle must be recovered over a long distance. One way to reduce the recovery time is to adopt a forward maintenance concept, whereby higher level maintenance capabilities (in terms of skillset and spare parts) are deployed forward closer to the frontline instead of at the depot level. In order to enable the forward maintenance concept, there must be a high maintenance supply capacity and the necessary tools for higher level maintenance (such as cranes) must be mobile and ruggedized for the field. An example of such an enabler is the Tracked Maintenance Task Vehicle (TMTV) that is deployed by the Singapore Armed Forces. Based on the Bronco ATTC, it has a mobile crane and generator, as well as a trailer to carry the necessary spare components for effective higher level repairs in the field.



Figure 61. A TMTV (Left) Performing Field Repairs (From Ministry of Defence, Singapore 2012)

4. Recovery with Speed

Should the capabilities or tools required to repair the vehicle be difficult to take out into the area of operations, then the recovery of the vehicle must be done in as fast a manner as possible to minimize turnaround time. This can be achieved through several ways:

- Wide Recovery Coverage. In order to provide a fast response to any recovery needs, there should be a sufficiently wide coverage of recovery vehicles such that any damaged vehicle can be reached within a short time. This, however, means that there must a large fleet size for recovery vehicles.
- High Speed Recovery Vehicle. Another way to facilitate fast recovery response is to design the recovery vehicle to have sufficient high speed so that it can keep up with the speed of operations. Hence, most MBTs and IFVs usually have recovery variants that have the same automotive specifications and speed performance. Examples are shown below:



Figure 62. The Buffel Armored Recovery Vehicle (ARV), a Variant of the Leopard 2 MBT (From IHS Jane's 2012)



Figure 63. Recovery Variant of the Bionix IFV (From IHS Jane's 2011)

- Automated Recovery Systems. Automated or remote recovery systems can allow the recovery crew to perform recovery on damaged vehicles without leaving the recovery vehicle itself. This can save precious time from the dismounting / mounting action, as well as to allow the recovery crew to perform its tasks quickly even in a hostile environment. The Buffel ARV,

a variant of the Leopard 2 MBT, employs the Combat Recovery Device to perform automated recovery.



Figure 64. A Buffel ARV Hooking up an Incapacitated Leopard 2A4 MBT Using the Combat Recovery Device (From Ministry of Defence, Singapore 2012)

5. Modular Components

As discussed earlier, an armored vehicle consists of various subsystems which, in turn, are made up of numerous line replacement units (LRUs) which are composed of shop replaceable units (SRUs). Normally, the component replacement stage of the repair process involves the replacement of LRUs. Therefore, in order to minimize repair and turnaround time, the LRUs should be designed to be modular, such that their removal requires minimal disconnections, as well as removal of other LRUs which do not need to be replaced. Examples of such a modular design can be seen in the Leopard 2 MBT, whose turret and engine can be easily disconnected and removed from the vehicle within a short time.



Figure 65. Removal of a Leopard 2 MBT Turret (From The Armor Site, n.d.)



Figure 66. Buffel ARV Lifting a Leopard 2 MBT Engine (From Defense Industry Daily 2012)

6. Maintenance Supply Chain Resilience

In order to ensure that the right quantity of the right components / tools is made available at the right time, the supply chain for maintenance supplies must be well planned and resilient.

- Pre-Operation Planning. In order to plan for the right quantity of spare parts to be held by the various echelons of maintenance entities, there is a need to plan prior to the operation, making use of past kill / damage data as well as simulations to determine the correct numbers.
- Replenishment Speed. If the same type of components is being held at various locations and / or entities, then the supply chain between each location must be robust, so as to allow for the components to be transferred and delivered as quickly as possible.

7. Component Repair

An alternative to the maintenance supply chain for the replenishment of serviceable components is the concept of component repair in the field. The premise of this concept is to undertake the repairs of the LRUs (replacement of SRUs, etc) in the field, albeit at another echelon instead of sending back to the manufacturer for repairs. However, it should be noted that component repair will require more specialized tools, skills as well as a larger logistics footprint. Therefore, the implementation should balance with any tactical and logistic considerations.

LIST OF REFERENCES

- Ball, Robert E. *The Fundamentals of Aircraft Combat Survivability Analysis and Design*, 2nd edition. American Institute of Aeronautics and Astronautics, Inc., 2003.
- Deitz, Paul H., Reed, Jr, Harry L., Klopacic, J. Terrence and Walbert, James N. *Fundamentals of Ground Combat System Ballistic Vulnerability / Lethality*. American Institute of Aeronautics and Astronautics, Inc., 2009.
- Department of Defense. *V50 Ballistic Test for Armor*. Aberdeen Proving Ground, MD: U.S. Army Research Laboratory, 1987.
- Ellis, John. *World War II: A Statistical Survey*. Facts on File, Inc., 1993
- Foss, Christopher F. *Jane's Armoured Personnel Carriers*. Jane's Publishing Company Limited, 1985.
- Foss, Christopher F. *Jane's Main Battle Tanks*, Second Edition. Jane's Publishing Company Limited, 1986.
- Foss, Christopher F. *Jane's World Armored Fighting Vehicles*. St. Martin's Press, 1977.
- Haythornthwaite, Philip J. *The World War One Sourcebook*. Arms and Armor Press, 1993
- Headquarters, Department of the Army. February 2008. *FM 3-0: Operations*.
- Hilmes, Rolf. *Main Battle Tanks: Developments in Design since 1945*. Brassey's Defence Publishers, 1987.
- Hogg, Ian V. *Armor in Conflict*. Jane's Publishing Company Limited, 1980.
- Hogg, Ian. *Tank Killing: Anti-Tank Warfare by Men and Machines*. Sarpedon, 1996.
- Mackasey, Kenneth. *Tank vs Tank: The Illustrated Story of Armored Battlefield Conflict in the Twentieth Century*. Salem House Publishers, 1988
- Macksey, Kenneth. *The Guinness Book of Tank Facts and Feats: A Record of Armored Fighting Vehicle Achievement*. Guinness Superlatives Limited, 1980.
- Norris, John. *Brassey's Modern Military Equipment: Anti-Tank Weapons*. Brassey's (UK) Ltd, 1996.
- Ogorkiewicz, R.M. *Design and Development of Fighting Vehicles*. Doubleday, 1968.

- Ogorkiewicz, R.M. *Trends in Armored Fighting Vehicle Design: Special Report Summary*. Jane's Armor and Artillery, 1995.
- Starry, Donn A. *Armored Combat in Vietnam*. Arno Press Inc, 1980.
- Steeb, Randall, Brendley, Keith, Norton, Dan, Bondanella, John, Salter, Richard and Covington, Terrell G. *An Exploration of Integrated Ground Weapons Concepts for Armor / Anti-Armor Missions*. RAND National Defense Research Institute, 1991.
- U.S. Army (TACOM). *Supply Chain Council Award for Supply Chain Operational Excellence: Manufacture and Distribution of High Mobility Multipurpose Wheeled Vehicle (HMMWV) Armor Survivability Kits (ASK) in Support of the Global War on Terrorism (GWOT) and Operation Iraqi Freedom (OIF)*. Bynum, AL: Anniston Army Depot, February 2004.
- Weeks, John S. *Men Against Tanks: A History of Anti-Tank Warfare*. Mason / Charter Publishers, Inc, 1975.

Online References

- “Mk V Walkaround,” (n.d.),
http://www.landships.freeservers.com/Mk5_walkaround.html.
- Acquisition Community Connection, “Condition Based Maintenance (CBM+),”
<https://acc.dau.mil/CommunityBrowser.aspx?id=32444&view=w>
- Army Recognition Magazine, “SINGAPOUR Army Military Equipment Vehicle (Armored Vehicle), Aug 3, 2007,
<http://www.armyrecognition.com/forum/viewtopic.php?t=1033>
- Army-technology.com, “Merkava Mk3 Baz Main Battle Tank, Israel,” 2011,
<http://www.army-technology.com/projects/merkava/>
- Berkholz, Nicholas Adam, “PBWorks: How Reactive Armor Works,,” Jun 8, 2009,
<http://eng3060.pbworks.com/w/page/18918895/How%20Reactive%20Armor%20Works>
- Cooke, Gary W., “M1 Abrams Main Battle Tank,” *Gary's Combat Vehicle Reference Guide*, May 3, 2008, <http://www.inetres.com/gp/military/cv/tank/M1.html>
- Cooke, Gary W., “M1126 Stryker Infantry Carrier Vehicle,” *Gary's Combat Vehicle Reference Guide*, Nov 15, 2009,
<http://www.inetres.com/gp/military/cv/inf/M1126.html>

Cooper, Tom and el-Abed, Yaser, "Syrian Tank-Hunters in Lebanon, 1982," *Air Combat Information Group*, Sep 26, 2003,
http://www.acig.org/artman/publish/article_279.shtml

CRAIG International Ballistics, "NIJ EN STANAG Ballistic Standards," 13 Aug 2012,
<http://www.ballistics.com.au/technical/ballisticandstabstandards.php#MILSTD>

Crane, David, "Intermat Stealth Anti-Thermal/IR Camouflage Tech for Infantry and Special Operations Forces," *Defense Review*, Apr 22, 2005,
<http://www.defensereview.com/intemat-anti-thermalir-camo-tech-for-infantry-and-special-operations-forces/>

Critical Solutions International, "Husky MK III Vehicle Mounted Mine Detector (VMMD)," 21 Aug 2012, <http://www.c-s-i.com/vehicles/husky-mk-iii/>

DefenseImagery.mil, (n.d.),
<http://www.defenseimagery.mil/imagery.html;jsessionid=61B2399F0489BEBD08DB50D54B9A8FAE#guid=cdad11327376aa040199848322fb8f8b68b8870d>

Defense Industry Daily, "Tanks for the Lesson: Leopards, too, for Canada,," Jan 9, 2012,
<http://www.defenseindustrydaily.com/tanks-for-the-lesson-leopards-too-for-canada-03208/>

Defense Update, "Slat Armor for Stryker," 2 Jan 2006, <http://www.defense-update.com/products/s/slat-stryker.htm>

Defense Update, "Tank Urban Survivability Kit," 10 Dec 2006, <http://defense-update.com/products/t/tusk.htm>

Engineering Toolbox, "Metal and Alloys – Densities,"
http://www.engineeringtoolbox.com/metal-alloys-densities-d_50.html

Federation of American Scientists, "T72 Tank Characteristics," Jan 16, 2000,
<http://www.fas.org/man/dod-101/sys/land/row/t72tank.htm>

Greenemeier, Larry, "Airless Tire Promises Grace Under Pressure for Soldiers," *Scientific American*, Aug 11, 2008,
<http://www.scientificamerican.com/article.cfm?id=tires-that-dont-need-air>

Global Information System, "Ground Force System Record: M-113 Armored Personnel Carrier series," 31 Jul 2012,
<http://128.121.186.46.libproxy.nps.edu/gis/online/GroundWeapons/M113APC.htm>

- Global Security, "Shaped Charge," 7 Jul 2011,
<http://www.globalsecurity.org/military/systems/munitions/bullets2-shaped-charge.htm>
- Global Security, "Soldier Survivability Highlighted at 24th Army Science Conference," January 2005, <http://www.globalsecurity.org/military/library/report/2005/050100-survivability.htm>
- IHS Jane's, "Jane's Armor and Artillery: BAE Systems, Global Combat Systems Challenger 2 MBT," Apr 3, 2012,
http://www4.janes.com.libproxy.nps.edu/subscribe/jaa/doc_view.jsp?K2DocKey=/content1/janesdata/yb/jaa/jaa_0075.htm@current&Prod_Name=JAA&QueryText=
- IHS Jane's, "AM General High Mobility Multipurpose Wheeled Vehicle (HMMWV)," Mar 28, 2012,
http://www4.janes.com.libproxy.nps.edu/subscribe/jmvl/doc_view.jsp?K2DocKey=/content1/janesdata/yb/jmvl/jmvl0785.htm@current&Prod_Name=JMVL&QueryText=
- IHS Jane's, "Jane's Armor and Artillery: BAE Systems U.S. Combat Systems M109A6 Paladin Integrated Management (PIM) 155 mm self-propelled howitzer," Mar 26, 2012,
http://www4.janes.com.libproxy.nps.edu/subscribe/jaa/doc_view.jsp?K2DocKey=/content1/janesdata/yb/jaa/jaa_a078.htm@current&Prod_Name=JAA&QueryText=
- IHS Jane's, "Jane's Armor and Artillery: BAE Systems, U.S. Combat Systems M113 armored personnel carrier family," Nov 30, 2011,
http://www4.janes.com.libproxy.nps.edu/subscribe/jaa/doc_view.jsp?K2DocKey=/content1/janesdata/yb/jaa/jaa_0249.htm@current&Prod_Name=JAA&QueryText=
- IHS Jane's, "Jane's Armor and Artillery: BAE Systems, U.S. Combat Systems M2 Infantry Fighting Vehicle/M3 Cavalry Fighting Vehicle," Nov 30, 2011,
<https://janes.ihc.com.libproxy.nps.edu/CustomPages/Janes/DisplayPage.aspx?DocType=Reference&ItemId=+++1327906&Pubabbrev=JAA>
- IHS Jane's, "Jane's Armor and Artillery: Centurion MBT," Apr 3, 2012,
http://www4.janes.com.libproxy.nps.edu/subscribe/jaa/doc_view.jsp?K2DocKey=/content1/janesdata/yb/jaa/jaa_0079.htm@current&Prod_Name=JAA&QueryText=#toclink-j0010010017690

- IHS Jane's, "Jane's Armor and Artillery: General Dynamics Land Systems M1/M1A1/M1A2 Abrams MBT," Apr 1, 2011,
http://www4.janes.com.libproxy.nps.edu/subscribe/jaa/doc_view.jsp?K2DocKey=/content1/janesdata/yb/jaa/jaa_0084.htm@current&Prod_Name=JAA&QueryText=
- IHS Jane's, "Jane's Armor and Artillery: Krauss-Maffei Wegmann Leopard 2 MBT," Mar 28, 2012,
http://www4.janes.com.libproxy.nps.edu/subscribe/jaa/doc_view.jsp?K2DocKey=/content1/janesdata/yb/jaa/jaa_0021.htm@current&Prod_Name=JAA&QueryText=#toclink-j3351205492288479
- IHS Jane's, "Jane's Armor and Artillery: Merkava Mk 1, Mk 2 and Mk 3 MBTs," Mar 28, 2012,
http://www4.janes.com.libproxy.nps.edu/subscribe/jaa/doc_view.jsp?K2DocKey=/content1/janesdata/yb/jaa/jaa_0034.htm@current&Prod_Name=JAA&QueryText=
- IHS Jane's, "Jane's Armor and Artillery: Nexter Systems AMX-13 Light Tank," Mar 26, 2012,
http://www4.janes.com.libproxy.nps.edu/subscribe/jaa/doc_view.jsp?K2DocKey=/content1/janesdata/yb/jaa/jaa_0092.htm@current&Prod_Name=JAA&QueryText=
- IHS Jane's, "Jane's Armor and Artillery: Singapore Technologies Kinetics Bionix Infantry Fighting Vehicle," Oct 24, 2011,
http://www4.janes.com.libproxy.nps.edu/subscribe/jaa/doc_view.jsp?K2DocKey=/content1/janesdata/yb/jaa/jaa_0228.htm@current&Prod_Name=JAA&QueryText=#toclink-j0010010048046
- IHS Jane's, "Jane's Infantry Weapons: RPG-7 Knut 40 mm Portable Rocket Launchers," Dec 29, 2011,
http://www4.janes.com.libproxy.nps.edu/subscribe/jiw/doc_view.jsp?K2DocKey=/content1/janesdata/yb/jiw/jiw_0770.htm@current&Prod_Name=JIW&QueryText=
- IHS Jane's, "Jane's Infantry Weapons: Spike Multi-Purpose Precision Weapon Systems," Dec 29, 2011,
[http://www4.janes.com.libproxy.nps.edu/subscribe/jiw/doc_view.jsp?K2DocKey=/content1/janesdata/yb/jiw/jiw_0758.htm@current&Prod_Name=JIW&QueryText=%3CAND%3E%28%3COR%3E%28%28\[80\]spike+%3CIN%3E+body%29%2C+%28\[100\]+%28\[100\]spike+%3CIN%3E+title%29+%3CAND%3E+%28\[100\]spike+%3CIN%3E+body%29%29%29%29](http://www4.janes.com.libproxy.nps.edu/subscribe/jiw/doc_view.jsp?K2DocKey=/content1/janesdata/yb/jiw/jiw_0758.htm@current&Prod_Name=JIW&QueryText=%3CAND%3E%28%3COR%3E%28%28[80]spike+%3CIN%3E+body%29%2C+%28[100]+%28[100]spike+%3CIN%3E+title%29+%3CAND%3E+%28[100]spike+%3CIN%3E+body%29%29%29%29)
- Kempf, Peter, "Landships: British Mark I-III Tank,"
http://www.landships.freeservers.com/mark1-3_info_walkaround.htm

- Lamothe, Dan, "Marine Corps Times: Marine Personnel Carrier delay is possible,," Apr 6, 2010,
http://www.marinecorpstimes.com/news/2010/04/marine_personnelcarrier_040610w/
- Ministry of Defence, Singapore, "cyberpioneer: Fix it in the Field,," Mar 12, 2012,
http://www.mindef.gov.sg/imindef/publications/cyberpioneer/weapon/2012/mar12_weapon.html
- Ministry of Defence, Singapore, "cyberpioneer: Networked Infantry Carrier Vehicle Gives SAF Sharper Edge in Urban Warfare,," Sep 3, 2009,
http://www.mindef.gov.sg/imindef/publications/cyberpioneer/news/2009/September/03sep09_news.html
- Ministry of Defence, Singapore, "cyberpioneer: Terrex ICV,," Aug 24, 2009,
<http://www.flickr.com/photos/cyberpioneer/3886864812/>
- Ministry of Defence, Singapore, "cyberpioneer: Wallaby by the Numbers,," Feb 7, 2012,
http://www.mindef.gov.sg/imindef/publications/cyberpioneer/features/2012/feb12_fs3.html
- Novel Defence Engineering, "Analysis of the RPG defeat mechanism by cage armor,," Aug 29, 2012, http://www.noveldefence.com/cage_armour_analysis.html
- Oxford English Dictionary, "armour | armor,," Jul 17 2012,
<http://www.oed.com.libproxy.nps.edu/view/Entry/10882?rskey=Ev5h2M&result=1#eid>
- The Armor Site, "Kampfpanzer Leopard 2,,"
<http://ciar.org/ttk/mbt/tank.german.leopard2.thorough-description.1.html>
- U.S. Army, "'Black Knight' Troops Deliver Accuracy on Range,," Aug 8, 2011,
<http://www.army.mil/media/215679>
- Zimbio, "World War 2 Tanks Sherman," (n.d.),
<http://www.zimbio.com/M4+Sherman/articles/JJV7O7NvfVU/world+war+2+tanks+sherman>

INITIAL DISTRIBUTION LIST

1. Defense Technical Information Center
Ft. Belvoir, Virginia
2. Dudley Knox Library
Naval Postgraduate School
Monterey, California
3. Christopher Adams
Director of the Center for Survivability and Lethality, Department of Mechanical
and Aerospace Engineering, Naval Postgraduate School (caadams@nps.edu)
Monterey, California
4. Professor Morris Driels
Department of Mechanical and Aerospace Engineering, Naval Postgraduate
School
Monterey, California
5. Professor Yeo Tat Soon
Director, Temasek Defence Systems Institute
National University of Singapore, Singapore
6. Ms. Tan Lai Poh
Senior Manager, Temasek Defence Systems Institute
National University of Singapore, Singapore
7. COL Lim Soon Chia
Deputy Chief Research and Technology Officer, Defence Research and
Technology Office (DRTech)
Ministry of Defence, Singapore
8. Professor Robert E. Ball
Distinguished Professor Emeritus, Department of Mechanical and Aerospace
Engineering, Naval Postgraduate School
Monterey, California
9. Christopher V. Cardine
Scientist for Tank Technologies, Engineering, Development and Technology,
General Dynamics Land Systems
Sterling Heights, Michigan