

# High Performance Polymer-Bonded Explosive Containing PolyNIMMO for Metal Accelerating Applications

Ron Hollands and Virgil Fung  
BAE SYSTEMS, Land Systems UK, Munitions & Ordnance

Karen S. Burrows  
Naval Surface Warfare Center, Indian Head Division

# Report Documentation Page

Form Approved  
OMB No. 0704-0188

Public reporting burden for the collection of information is estimated to average 1 hour per response, including the time for reviewing instructions, searching existing data sources, gathering and maintaining the data needed, and completing and reviewing the collection of information. Send comments regarding this burden estimate or any other aspect of this collection of information, including suggestions for reducing this burden, to Washington Headquarters Services, Directorate for Information Operations and Reports, 1215 Jefferson Davis Highway, Suite 1204, Arlington VA 22202-4302. Respondents should be aware that notwithstanding any other provision of law, no person shall be subject to a penalty for failing to comply with a collection of information if it does not display a currently valid OMB control number.

1. REPORT DATE <b>NOV 2004</b>		2. REPORT TYPE		3. DATES COVERED <b>00-00-2004 to 00-00-2004</b>	
4. TITLE AND SUBTITLE <b>High Performance Polymer-Bonded Explosive Containing PolyNIMMO For Metal Accelerating Applications</b>				5a. CONTRACT NUMBER	
				5b. GRANT NUMBER	
				5c. PROGRAM ELEMENT NUMBER	
6. AUTHOR(S)				5d. PROJECT NUMBER	
				5e. TASK NUMBER	
				5f. WORK UNIT NUMBER	
7. PERFORMING ORGANIZATION NAME(S) AND ADDRESS(ES) <b>Naval Surface Warfare Center, Indian Head, MD, 20604</b>				8. PERFORMING ORGANIZATION REPORT NUMBER	
9. SPONSORING/MONITORING AGENCY NAME(S) AND ADDRESS(ES)				10. SPONSOR/MONITOR'S ACRONYM(S)	
				11. SPONSOR/MONITOR'S REPORT NUMBER(S)	
12. DISTRIBUTION/AVAILABILITY STATEMENT <b>Approved for public release; distribution unlimited</b>					
13. SUPPLEMENTARY NOTES <b>Presented at the Insensitive Munitions &amp; Energetic Materials Symposium, November 14-17, 2004</b>					
14. ABSTRACT					
15. SUBJECT TERMS					
16. SECURITY CLASSIFICATION OF:			17. LIMITATION OF ABSTRACT <b>Same as Report (SAR)</b>	18. NUMBER OF PAGES <b>36</b>	19a. NAME OF RESPONSIBLE PERSON
a. REPORT <b>unclassified</b>	b. ABSTRACT <b>unclassified</b>	c. THIS PAGE <b>unclassified</b>			



- Objective of Study
- Rationale & Methodology
- Energetic Polymer & Plasticisers
- Candidate Selection
- Candidate Assessment
  - Thermal Properties
  - Physical & Mechanical Properties
  - Hazard Properties
  - Shock Sensitiveness
  - Performance
- Summary
- Acknowledgements

- To develop new explosive compositions for metal accelerating applications which possess improved performance and lower vulnerability in comparison with currently available military explosives
- To develop and utilise fully energetic binder systems based on polyNIMMO
- Specifically, to at least match the performance of Octol 75/25 in terms of detonation pressure and metal accelerating ability whilst demonstrating reduced vulnerability

- HMX chosen as energetic filler to maximise performance
  - Readily available
  - Higher density, detonation velocity & pressure
  
- Fully energetic binder systems evaluated
  - i.e. energetic polymer with energetic plasticiser
  - Binder contributes towards performance
  - Allows more latitude with level of solids loading to achieve trade-offs
    - eg performance vs hazard vs processing
  
- Programme addressed castable formulations
  - Ease of processing for medium to large warhead filling operations
  - Castable PBXs generally demonstrate better IM compliance
  - More binder present so better mechanical properties
  - Established processing technique

# Rationale & Methodology - Formulation & Assessment Methodology

- PolyNIMMO binders plasticised with a range of energetic plasticisers
  - Butyl NENA
  - ROWANITE 8001 (K10)
  - GAPA
- Performance modelling to identify trends and narrow field of formulation and processing activities
- Series of initial compositions prepared on the small scale to investigate the effect of formulation variables and to screen in small scale tests:
  - Processing, hazard, thermal behaviour, mechanical properties
- Leading candidate down selected then manufactured on intermediate scale for further assessment:
  - Shock sensitiveness
  - Performance



# Energetic Polymer and Plasticisers

## ■ PolyNIMMO Pre-polymer

- a homopolymer of 3-nitratomethyl-3-methyl oxetane (NIMMO) possessing reactive terminal primary hydroxyl groups
- can be cured using isocyanates to give rubbers
- manufactured by ICI in the UK

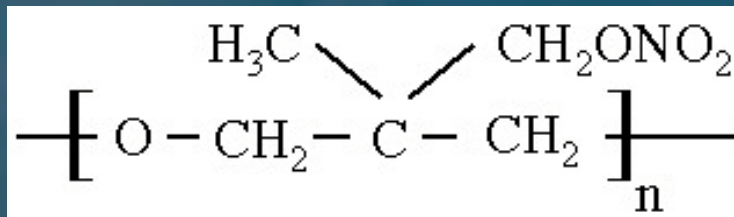

$$n = 22$$

Viscosity at 40° C (poise)	560
Viscosity at 60° C (poise)	100
Hydroxyl value (mg KOH/g)	18-22
Molecular Weight (notional)	5500
Density (g/cm <sup>3</sup> )	1.26
Glass transition (° C)	-25
Heat of Formation (kCal/m ol)	-73.9
Heat of Explosion (kCal/m ol)	28.8
Temperature of Ignition (° C)	no less than 165° C



## ■ Butyl NENA

- The nitrate ethylnitramine family (NENAs) contain both nitrate ester and nitramine functionalities
- Traditionally used as plasticisers in gun and rocket propellants
- Manufactured by NSWC Indian Head Division

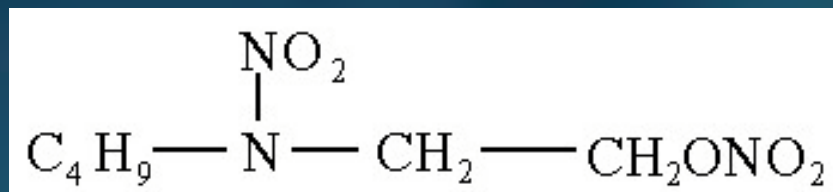

Appearance	Yellow Liquid
Composition	Butyl-NENA: 60-100% Methyl-nitroaniline: 0-1%
Density (g/cm <sup>3</sup> )	1.2
Molecular Mass	207
Temperature of Decomposition (°C)	210
Melting Point (°C)	-27
Heat of Formation (kJ/mol)	-192
Heat of Explosion (J/g)	1083

# Energetic Plasticisers (2)

## GAPA

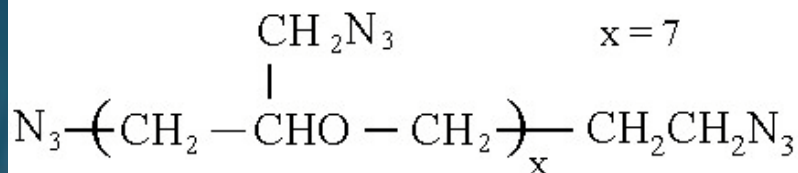

Glycidyl azide polymer azide oligomer

Appearance	Pale Yellow Liquid or slightly ambered
Density (g/cm <sup>3</sup> )	1.27
Molecular Mass	805
Glass Transition (°C)	-69
Melting Point (°C)	-27
Heat of Formation (kJ/mol)	-227
Solubility	miscible with acetone and chlorinated solvents not miscible with water and aliphatic hydrocarbons

## ROWANITE 8001 (K10)

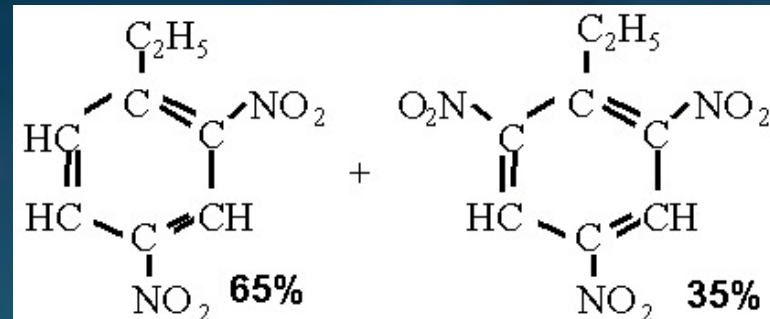

Appearance	Clear, yellow to medium orange liquid
Composition	Dinitroethylbenzene: 65% Trinitroethylbenzene: 35%
Density (g/cm <sup>3</sup> )	1.363 ± 0.003
Molecular Mass	209
Temperature of Ignition (°C)	240
Melting Point (°C)	-40
Oxygen Balance (%)	-53
Heat of Formation (kJ/mol)	-402
Viscosity at 20° C (mPa.s)	38.5



# Candidate Selection



- Performance parameters modelled with In-house EXPERT computer programme based on the Kamlet Model
  - Determines detonation characteristics of energetic materials which consist of C, H, N and O only
  - Model predicts:
    - heat of detonation, gas evolved on detonation and average molecular mass of the evolved gaseous products
  - Model then gives predicted
    - Velocity of detonation and detonation pressure
- Modelling conducted on formulations with:
  - Solids loading range of 74 to 77% v/v
  - Plasticiser/polyNIMMO ratios of 70/30, 60/40 and 50/50
  - Three different plasticiser types (ButylNENA, K10 and GAPA)
- Comparisons made with predictions for Octol 75/25 and PBXN-110

## Expert Code Performance Modelling (50/50 PolyNIMMO / plasticiser ratio)

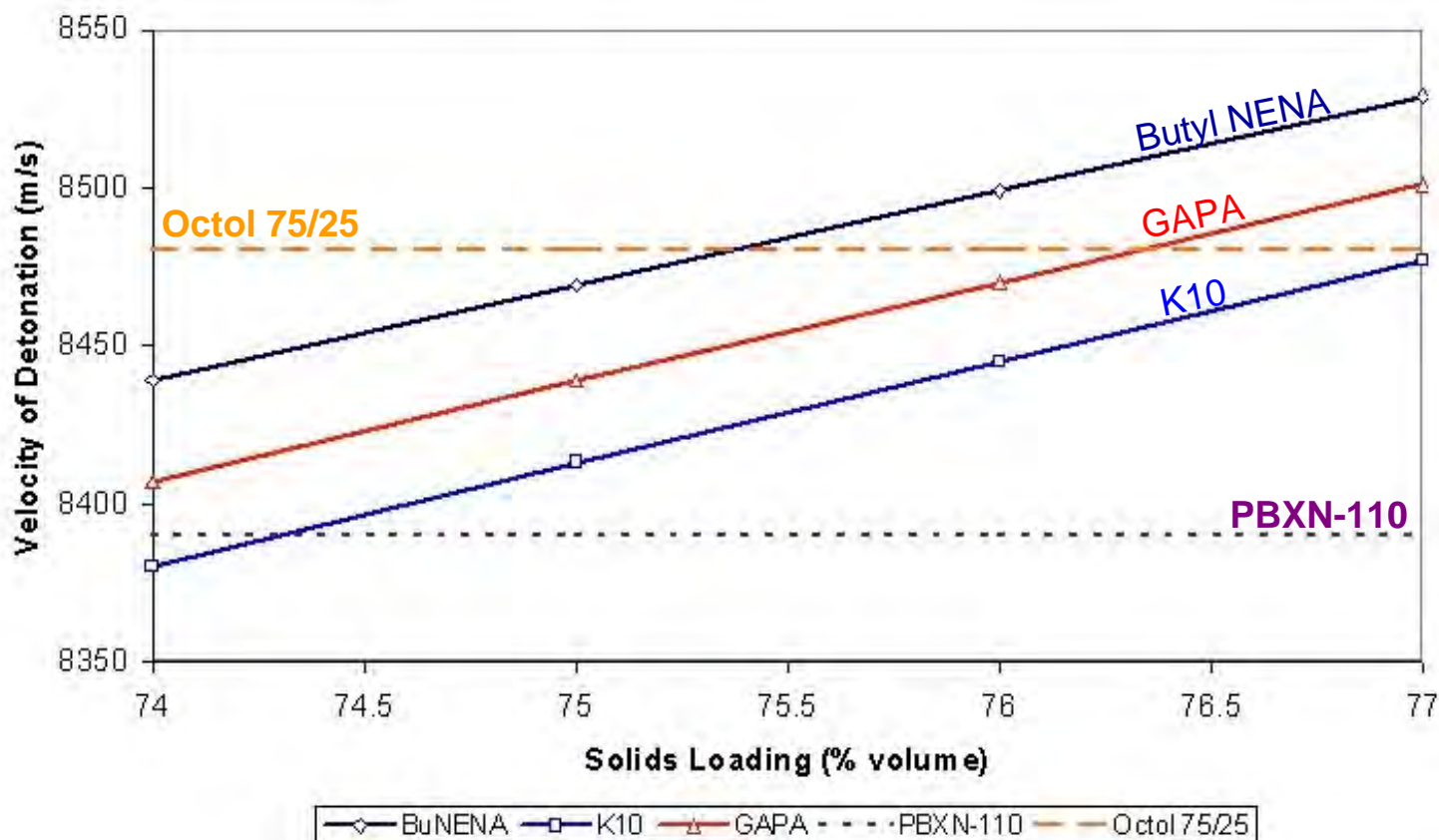

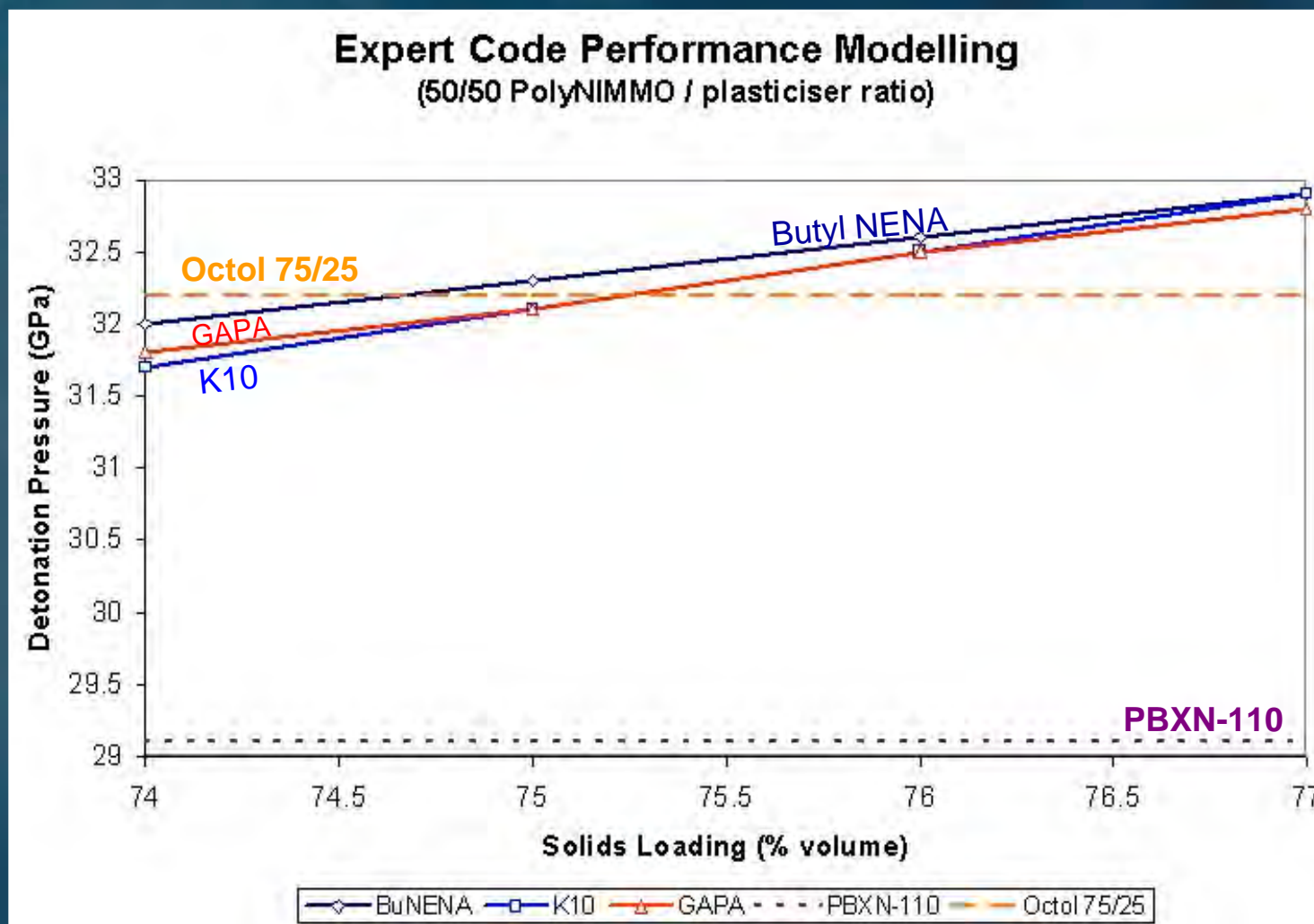



- All other factors (solids loading, polymer/plasticiser ratio) being equal predicted performance in terms of and follows following trend:
  - V of D: Butyl NENA > GAPA > ROWANITE 8001
  - $P_{cj}$ : Butyl NENA > GAPA = ROWANITE 8001
- Conclusion (all other factors being equal) target performance level can be achieved with lower HMX solids loading with a Butyl NENA binder than with GAPA or ROWANITE 8001 binders
- Modelling results used to scope small scale formulation, processing and assessment programme
  - Different HMX blends evaluated and solids loading increased incrementally
  - Plasticiser/polymer ratio assessed for each plasticiser



- GAPA plasticiser quickly eliminated as binders too viscous
  - Resultant solids loading too low to achieve desired performance level
- Field of study reduced to Butyl NENA and ROWANITE 8001 formulations
- Candidate formulations taken forward for screening tests
  - Butyl NENA plasticised Research Formulation designated RF-67-43
    - Solids loading level = 77% v/v (83.92% m/m) HMX
    - Predicted V of D = 8531 m/s
    - Predicted Detonation Pressure = 32.9 GPa
  - ROWANITE 8001 plasticised Research Formulation designated RF-67-49
    - Solids loading level = 76% v/v (82.17% m/m) HMX
    - Predicted V of D = 8437m/s
    - Predicted Detonation Pressure = 32.4 Gpa
- Focus on assessment of Butyl NENA plasticised PBX designated RF-67-43





# Processing



- Small scale mixes were prepared using vertical incorporator
  - initially 1.6Kg increasing to 5Kg
- Effect of formulation variables on process behaviour and end-of-mix (EOM) viscosity (all other factors being equal)
  - Solids loading level - higher the solids loading, higher the EOM viscosity
  - Plasticiser type - lower viscosity plasticiser yields a lower EOM viscosity
  - Polymer/plasticiser ratio
    - lower polymer/plasticiser yields a lower EOM viscosity
    - lower polymer/plasticiser ratio reduces mechanical strength
    - too high a plasticiser level can give rise to migration and exudation
  - Mixing temperature - higher the mixing temperature, the lower the EOM viscosity (but must consider pot-life issues)
- Assessment criteria
  - End of mix viscosity (Brookfield viscometer)
  - Pot-life; time taken to reach 20 kPoise (2kPa.s)
  - Cure Time; time to reach constant Shore A hardness
  - Cured charge quality; density & % Theoretical Maximum Density (TMD)
  - Thermal stability; DSC with sample maintained at 80°C for 4 hours

# Processing Assessment (2)

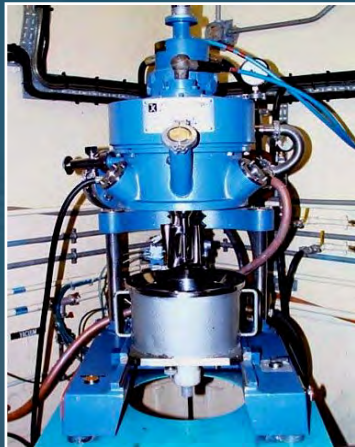

HKV5 High Shear Mixer



Viscosity Measurement

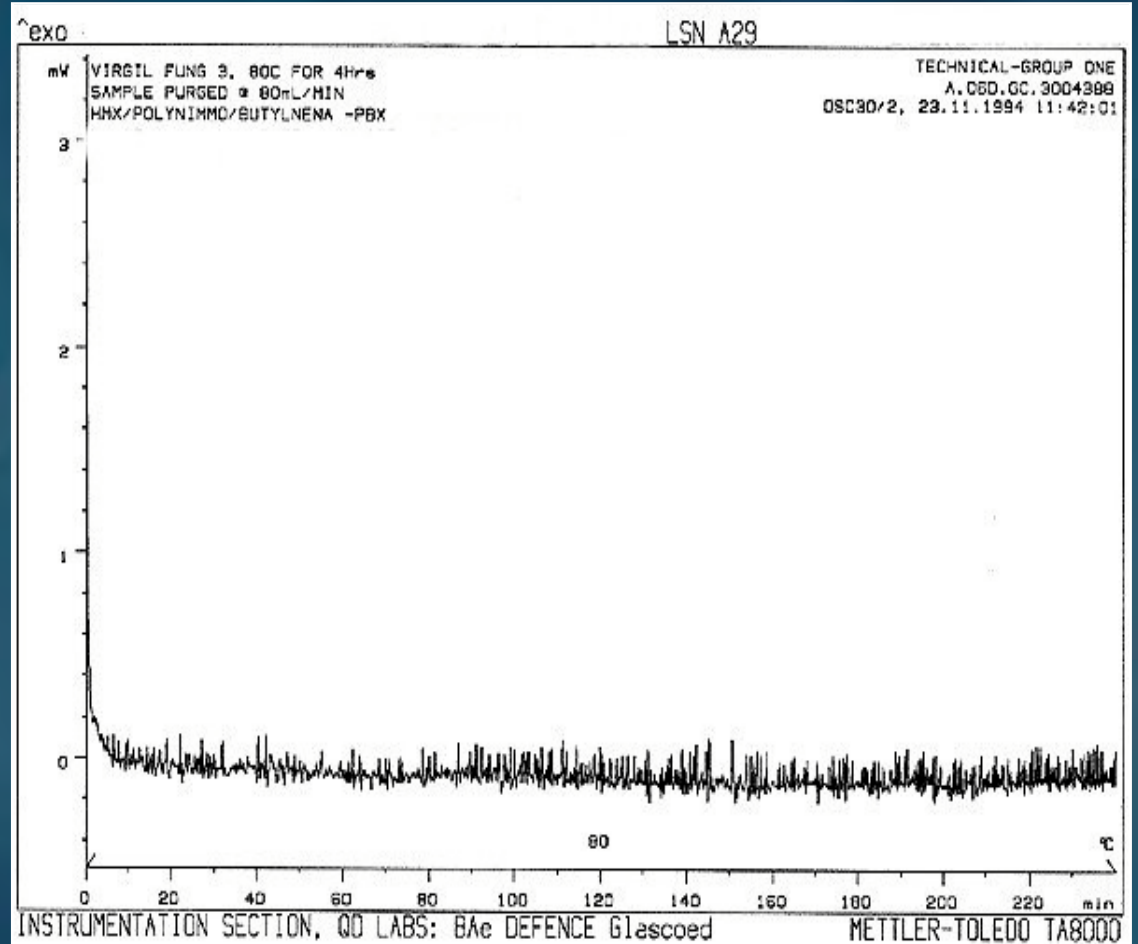

DSC trace

### Viscosity vs Time Plot on Lead Candidates

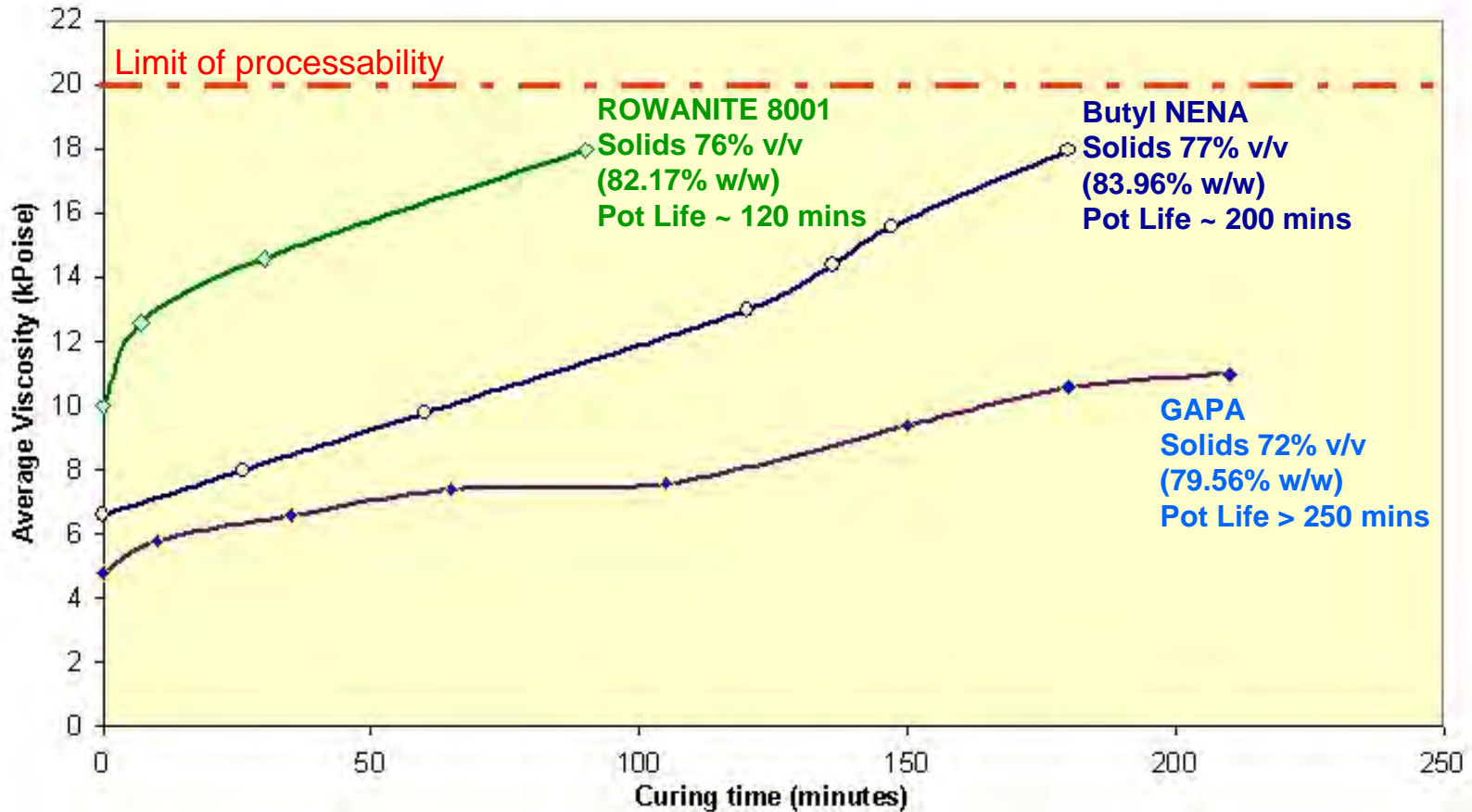

# RF- 67- 43 Thermal Properties

- Vacuum Stability

- 100°C for 48 hours (MIL-STD-1751A method 1061)
- Pass criterion: 2 ml of gas / gram of sample maximum  
Result = 0.16 ml of gas / gram of sample

- DSC

- Heating samples from 30°C to 400°C at a rate of 10°C per minute
  - Major Exotherm = 275.84°C
  - Minor Exotherm = 185.48°C

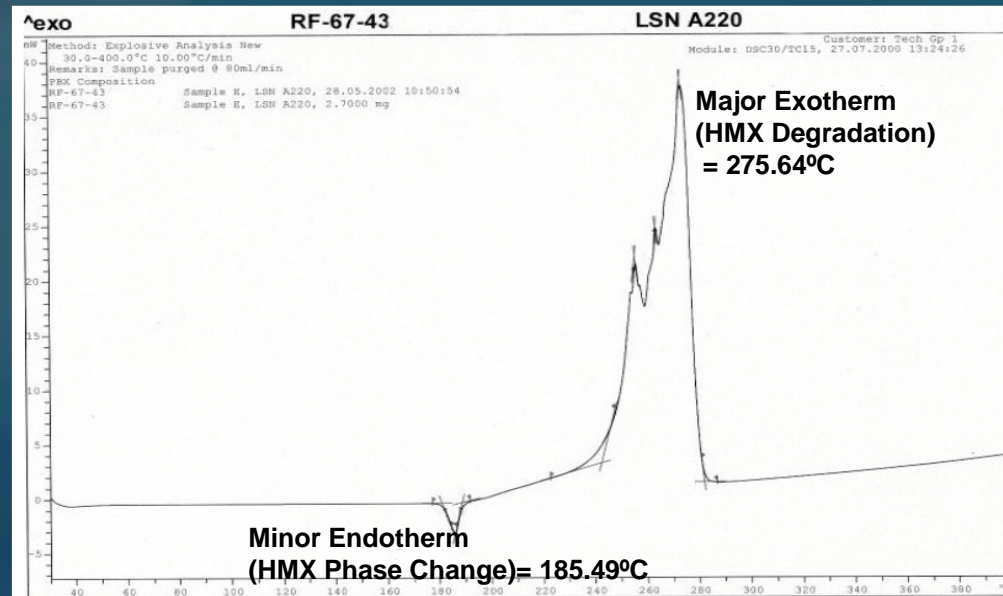

- Glass Transition Temperature using DSC
  - Heating samples from  $-150^{\circ}\text{C}$  to  $30^{\circ}\text{C}$  at a rate of  $10^{\circ}\text{C}$  per minute
  - PBX below this temperature will become Hard and Brittle
  - Glass Transition Temperature,  $T_g \sim -69.0^{\circ}\text{C}$  ( $92.9^{\circ}\text{F}$ )

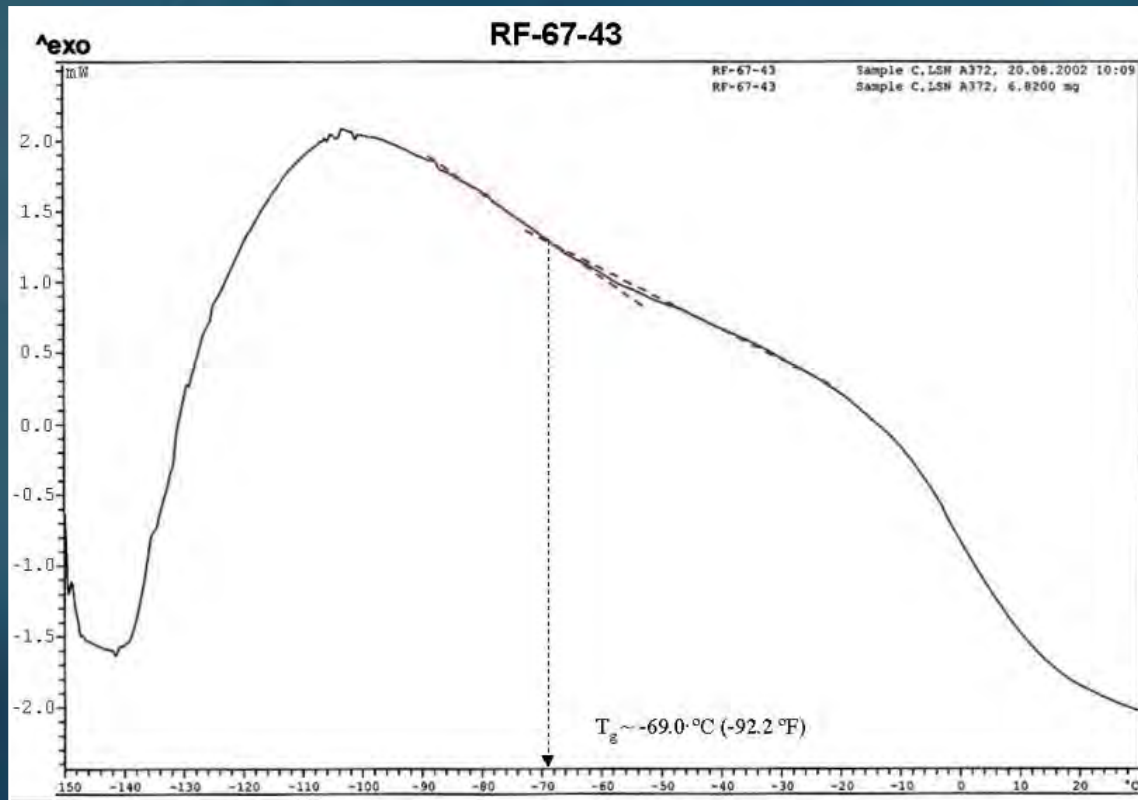

# RF- 67- 43 Physical & Mechanical Properties



## ■ Density

- Density of cured explosive is measured using the oil displacement method
- Density of RF-67-43 = 1.74 g/cm<sup>3</sup> (99.6% TMD)

## ■ Shore A Hardness

- Shore A Hardness of RF-67-43 = 20-25

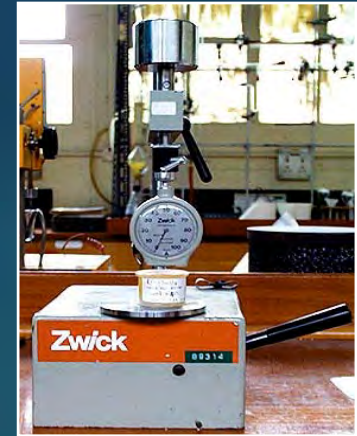

## ■ Mechanical Properties

- Maximum load (N), maximum stress (N/mm<sup>2</sup>), strain at maximum load (%), load at break (N), stress at break (N/mm<sup>2</sup>)
- 10 test pieces tested at ambient temperature to obtain an average result



Max Load (N)	Max Stress (N/mm <sup>2</sup> )	Strain at Max Load (%)	Load at Break (N)	Stress at Break (N/mm <sup>2</sup> )
10.32	0.0839	25.15	5.419	0.0442



# RF- 67- 43 Small Scale Hazard Properties

## ■ Rotter Impact Test (EMTAP Test No.1A)

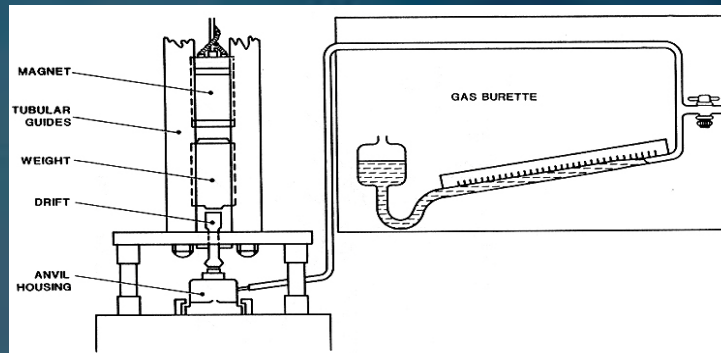

Rotter Impact Testing Apparatus

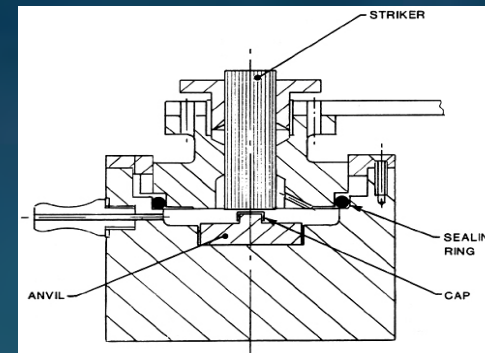

Testing Mechanism

## Mallet Friction Test (EMTAP Test No.2)

- Strike HE sample on steel surface with steel-tipped mallet (100 strikes); record Ignition (sparks or flame; a “crack” as some or all trace reacts)
- Sentencing criteria
  - No ignition = 0% (frictionally insensitive)
  - Up to six ignitions = 50% (frictionally insensitive)
  - More than six ignitions = 100% (very sensitive)

# Summary of Small Scale Hazard Properties

Test	EMTAP Test No.	Result
Sensitiveness to Mechanical Impact	1A	F of I = 90
Mallet Friction	2	50%
Rotary Friction	33	F of F = 5
Ignition by Electrostatic Spark	6	NO IGNITION AT 4.5J
Temperature of Ignition	3	200°C
Ease of Ignition	4	FAIL TO IGNITE
Behaviour on Inflammation	5	IGNITES AND SUPPORTS TRAIN STEADILY THROUGHOUT

# RF- 67- 43 Shock Sensitiveness

# Comparative US/UK Shock Sensitiveness Assessment

- Shock sensitiveness as measured in the large scale gap test (LSGT) conducted as an initial assessment of vulnerability
- Both UK and US test methods were carried out as they are not identical
- Both tests were performed in the Fast Event Facility (FEF) at RO Defence, Chorley with NSWC Indian Head personnel in attendance
- NSWC supplied major hardware and booster pellets for the US test which were flown in from the US
- Parallel approach allowed comparative assessment of US and UK large scale gap tests techniques on the same explosive composition filled under identical conditions
- Close co-operation between US and UK assessment teams established

# Comparison of UK and US Large Scale Gap Test Configurations

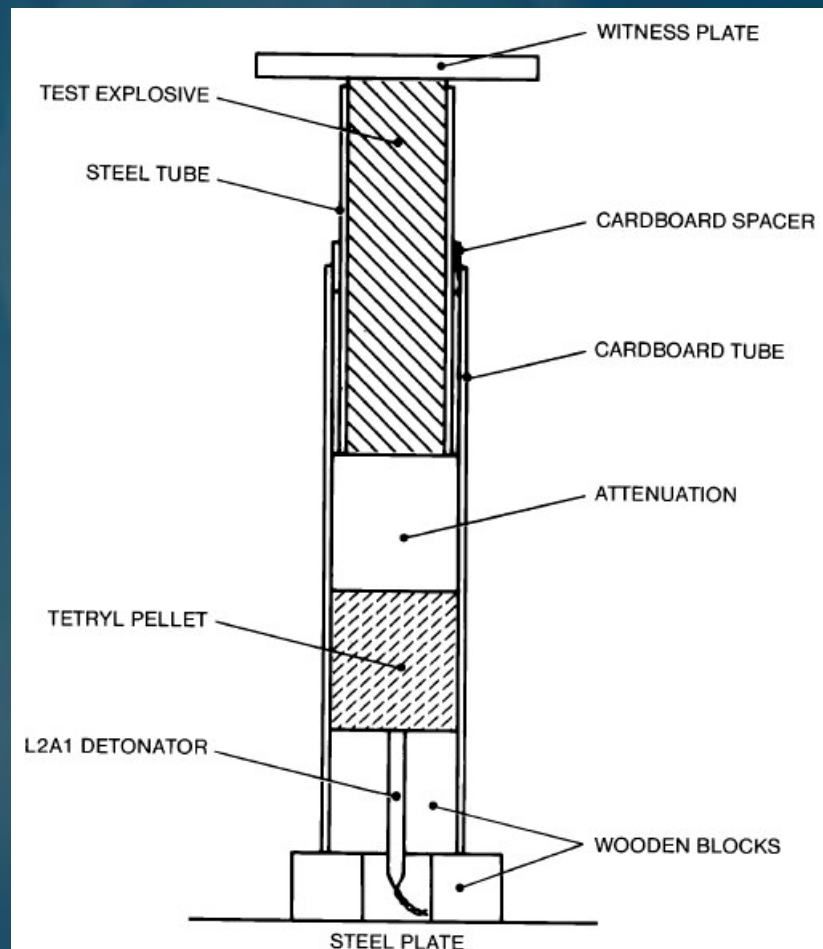

UK: EMTAP Test No.22

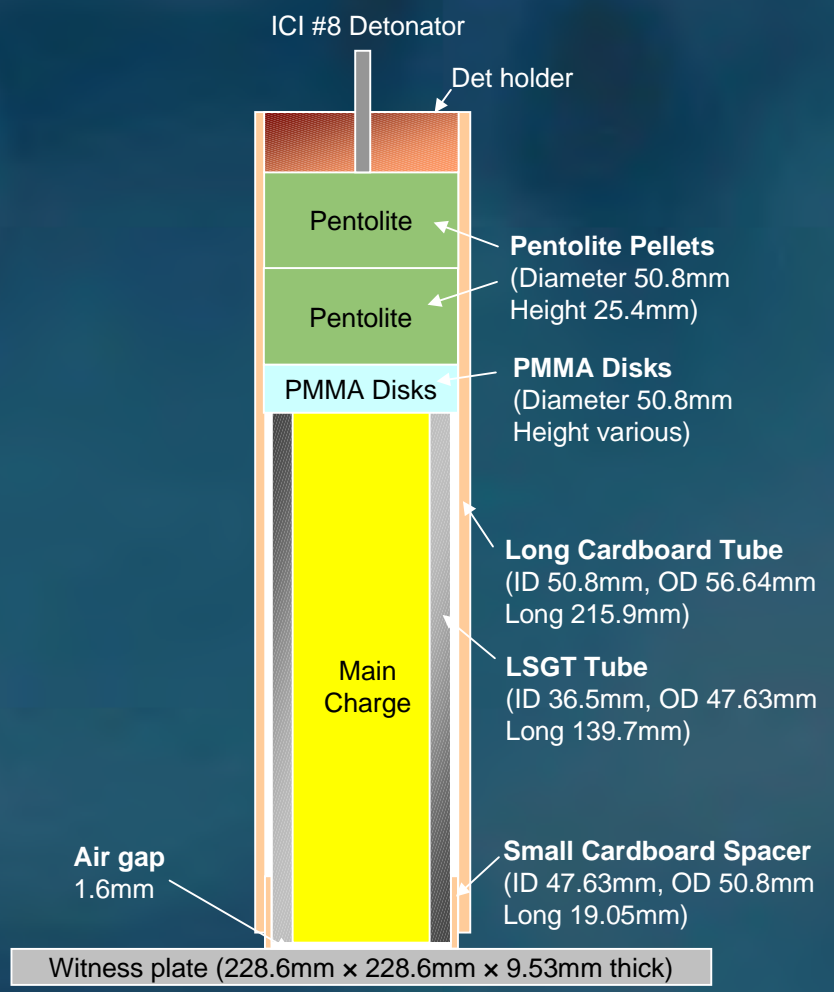

US: MIL-STD-1751A Method 1041 (NOL)

# Comparison of UK and US Large Scale Gap Test Results for RF-67-43

	UK EMTAP Test No.22	MIL-STD-1751A Method 1041 (NOL)
Detonator	L2A1	ICI #8
Donor Pellet	1 off Tetryl (density = 1.5 g/cm <sup>3</sup> )	2 off Pentolite (density = 1.56 g/cm <sup>3</sup> )
Attenuator	PMMA	PMMA
Witness Plate	Mild Steel (10.00mm thick)	Mild Steel (9.53mm thick)
Sample Density	1.74 g/cm <sup>3</sup>	1.74 g/cm <sup>3</sup>
Result (50% Point)	39.4mm (155 cards)	41.1mm (162 cards)
Result (P <sub>g</sub> )	~ 33.8 kbar	33.1 kbar
Other results for comparison	RDX/TNT Type A, 50% point ~ 199 cards P <sub>g</sub> = 20 kbar	PBXN-110, 50% point ~ 154-178 cards P <sub>g</sub> = 27.0-36.8 kbar  Octol 85/15 50% point = 236 cards P <sub>g</sub> = 14.5 kbar
Reference	EMTAP Manual Test No.22	NIMIC Excel Spreadsheet on Gap Tests version 1.3





# RF- 67- 43 Performance

## ■ Velocity of Detonation (unconfined)

- Test sample dimension = 25.4mm diameter × 227mm long
- density = 1.74 g/cm<sup>3</sup>
- V of D measured by triggering ionisation probes (8 off - 25mm apart)
- 6 firings carried out
- Mean Velocity of Detonation of RF-67-43
  - = 1% above PBXN-110\*
  - = 0.2% below Octol 75/25\*
- Predicted Detonation Pressure using the Cook Equation,  $P = 0.00987 \times r \times D^2 / 4$ 
  - = 5.8% above PBXN-110\*
  - = 4.3% below Octol 75/25\*

\* NIMIC EMC version 3.0

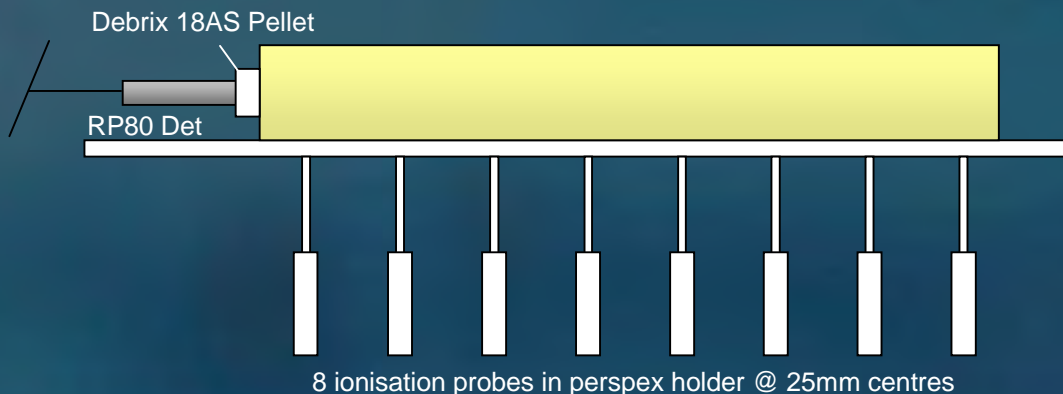

## ■ Cylinder Expansion

- MIL-STD-1751 (USAF) Method 16
- 5 firings carried out
- Density = 1.75 g/cm<sup>3</sup>
- Mean Gurney Velocity (19mm) of RF-67-43
  - = 7% above PBXN-110\*
  - = 5.4% above Octol 75/25\*

\* NIMIC EMC version 3.0

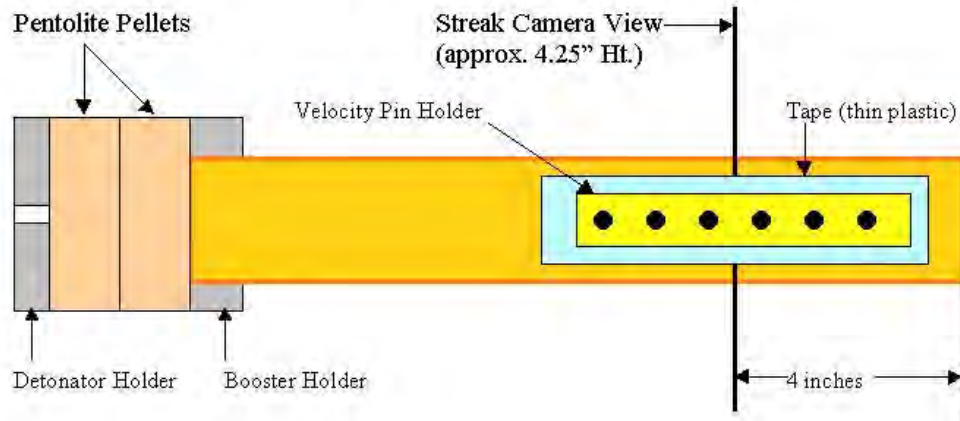



- Close US/UK co-operation has been established on comparative testing techniques and assessment criteria for secondary explosives
- A comparison has been made of the properties and processing behaviour of a series of castable PBXs with polyNIMMO binder systems plasticised with butyl NENA, ROWANITE 8001 (K10) and GAPA
- A candidate PBX, designated RF-67-43, utilising a polyNIMMO binder plasticised with butyl NENA was down selected and has been successfully scaled up to 5kg batch size for assessment
- Processability and cure behaviour satisfactory
- Mechanical properties adequate
- Small scale hazard properties and thermal stability satisfactory
- Shock sensitiveness (from LSGT) on a par with PBXN-110, significantly lower than Octol
- Performance encouraging
  - Improvement over PBXN-110
  - Approaching that of Octol 75/25



This work package was conducted under the sponsorship of the US Navy's Insensitive Munitions Advanced Development - High Explosives (IMAD-HE) Program

- NSWC Indian Head



- Karen Burrows
- Anh Duong
- Heather Gokee
- Al Gillis
- John O'Connor

- BAE SYSTEMS Land Systems



- Dr Ian Murray
- Alan Watkins
- Gwyn Sayce
- Glascoed Laboratory
- Summerfield Laboratory
- Fast Event Facility

