

# ADAPTIVE NEURO-FUZZY MODELING OF UH-60A PILOT VIBRATION

Heidar A. Malki  
University of Houston  
Houston, Texas

Sesi Kottapalli  
Army/NASA Rotorcraft Division  
NASA Ames Research Center  
Moffett Field, California

Reza Langari  
Texas A&M University  
College Station, Texas

## Abstract

Adaptive neuro-fuzzy relationships have been developed to model the UH-60A Black Hawk pilot floor vertical vibration. A 200 point database that approximates the entire UH-60A helicopter flight envelope is used for training and testing purposes. The NASA/Army Airloads Program flight test database was the source of the 200 point database. The present study is conducted in two parts. The first part involves level flight conditions and the second part involves the entire (200 point) database including maneuver conditions. The results show that a neuro-fuzzy model can successfully predict the pilot vibration. Also, it is found that the training phase of this neuro-fuzzy model takes only two or three iterations to converge for most cases. Thus, the proposed approach produces a potentially viable model for real-time implementation.

## Notation

MEF	Maneuver effect factor <sup>4</sup>
N	Number of main rotor blades, N = 4 for the UH-60A
N/rev	Integer (N) multiple of main rotor speed
PVV	Peak, 4P pilot floor vertical vibration, g's

## Introduction

The reduction of vibration and noise in helicopters is still of high priority. The analytical development and implementation of control procedures that can efficiently minimize vibration and noise is thus very important. The first step in the analytical development of such control procedures is to come up with accurate models that represent the helicopter vibration and noise. Real time implementation considerations dictate that these representations would have to be created quickly, or, if need be, existing representations would have to be updated quickly.

The present study is, to the best of our knowledge, the first effort of its kind that develops a neuro-fuzzy, numerical identification model for helicopter vibration that is potentially suitable for on-line control. As background to the present study, Yen and Langari have considered various types of fuzzy control systems<sup>1</sup>. In the present study, neuro-fuzzy theory as implemented in the MATLAB Fuzzy Logic Toolbox<sup>2,3</sup> is used to model the vertical component of the N/rev vibration at the UH-60A pilot floor location. The particular tool used in this study from the above Toolbox is "ANFIS" (Adaptive-Network-based Fuzzy Inference System)<sup>2</sup>, which is described in the next section.

# Report Documentation Page

Form Approved  
OMB No. 0704-0188

Public reporting burden for the collection of information is estimated to average 1 hour per response, including the time for reviewing instructions, searching existing data sources, gathering and maintaining the data needed, and completing and reviewing the collection of information. Send comments regarding this burden estimate or any other aspect of this collection of information, including suggestions for reducing this burden, to Washington Headquarters Services, Directorate for Information Operations and Reports, 1215 Jefferson Davis Highway, Suite 1204, Arlington VA 22202-4302. Respondents should be aware that notwithstanding any other provision of law, no person shall be subject to a penalty for failing to comply with a collection of information if it does not display a currently valid OMB control number.

1. REPORT DATE <b>2003</b>		2. REPORT TYPE		3. DATES COVERED <b>00-00-2003 to 00-00-2003</b>	
4. TITLE AND SUBTITLE <b>Adaptive Neuro-Fuzzy Modeling of UH-60A Pilot Vibration</b>				5a. CONTRACT NUMBER	
				5b. GRANT NUMBER	
				5c. PROGRAM ELEMENT NUMBER	
6. AUTHOR(S)				5d. PROJECT NUMBER	
				5e. TASK NUMBER	
				5f. WORK UNIT NUMBER	
7. PERFORMING ORGANIZATION NAME(S) AND ADDRESS(ES) <b>U.S. Army Research, Development and Engineering Command, Army/NASA Rotorcraft Division, Ames Research Center, Moffett Field, CA, 94035</b>				8. PERFORMING ORGANIZATION REPORT NUMBER	
				10. SPONSOR/MONITOR'S ACRONYM(S)	
9. SPONSORING/MONITORING AGENCY NAME(S) AND ADDRESS(ES)				11. SPONSOR/MONITOR'S REPORT NUMBER(S)	
12. DISTRIBUTION/AVAILABILITY STATEMENT <b>Approved for public release; distribution unlimited</b>					
13. SUPPLEMENTARY NOTES					
14. ABSTRACT <b>Adaptive neuro-fuzzy relationships have been developed to model the UH-60A Black Hawk pilot floor vertical vibration. A 200 point database that approximates the entire UH-60A helicopter flight envelope is used for training and testing purposes. The NASA/Army Airloads Program flight test database was the source of the 200 point database. The present study is conducted in two parts. The first part involves level flight conditions and the second part involves the entire (200 point) database including maneuver conditions. The results show that a neuro-fuzzy model can successfully predict the pilot vibration. Also, it is found that the training phase of this neuro-fuzzy model takes only two or three iterations to converge for most cases. Thus the proposed approach produces a potentially viable model for real-time implementation.</b>					
15. SUBJECT TERMS					
16. SECURITY CLASSIFICATION OF:			17. LIMITATION OF ABSTRACT	18. NUMBER OF PAGES	19a. NAME OF RESPONSIBLE PERSON
a. REPORT <b>unclassified</b>	b. ABSTRACT <b>unclassified</b>	c. THIS PAGE <b>unclassified</b>			

Previous studies<sup>4,5</sup> on the representation of UH-60A pilot vibration have used only neural networks, i.e., fuzzy logic considerations were not included. It has been shown that neural network based representations can be obtained for the UH-60A pilot vibration and the hub accelerations<sup>4,5,6</sup>. Similarly, tilt-rotor performance and noise were considered using only neural networks, without any fuzzy logic considerations<sup>7,8</sup>. On-line or real-time implementation considerations were not addressed in<sup>4,5</sup> because the backpropagation training algorithm is very slow and cannot be used on-line.

The present modeling study involving adaptive neuro-fuzzy logic theory addresses the rapid generation of an identification model for the UH-60A pilot vibration. A 200 point database that approximates the entire UH-60A flight envelope, and which was used in<sup>4,5,6</sup> is used here also for training and testing purposes. The NASA/Army Airloads Program flight test database<sup>9</sup> was the source of the above 200 point database. The present study is conducted in two parts. The first part involves level flight conditions and the second part involves the entire (200 point) database including maneuver conditions.

### **Proposed Neuro-Fuzzy Model**

The block diagram of the proposed neuro-fuzzy model for predicting vibration is shown in Fig. 1. The inputs for the ANFIS are the same parameters that were used earlier<sup>4</sup> for training the neural networks and details are given later in the Results section. The single output of ANFIS is the predicted peak, 4P pilot floor vertical vibration, PVV, of UH-60A helicopter.

The advantages of the proposed neuro-fuzzy model are as follows:

1. **Transparency**: the ability to see and understand the relationship between the inputs and outputs.
2. **Flexibility**: the ability to enhance and refine the fuzzy rule base and the membership functions by adding new rules and modifying the membership functions.
3. **Design improvements**: the ability to use rule base knowledge in modifying the helicopter and its operation for low vibration.

4. **Control capability**: the ability to design and build intelligent controllers for controlling and reducing vibration in the helicopter.

Subsequent to the completion of the vibration prediction phase of the present effort, it is planned that a real-time adaptive fuzzy logic controller to control the vibration will be developed.

### **Description of ANFIS**

ANFIS stands for adaptive neuro-fuzzy inference system developed by Roger Jang<sup>2</sup>. It is a part of the fuzzy logic toolbox in MATLAB software of the Math Works Inc.<sup>3</sup>. ANFIS is a fuzzy rule-based model using neural network like structure (i.e., involving nodes and links)<sup>2</sup>. It consists of five layers implementing fuzzy inference systems as shown schematically in Fig. 2. Note that the square nodes are adaptive nodes and the circle nodes are fixed ones. Figure 2 shows a simple ANFIS model with two inputs (x and y), two membership functions (A's and B's) for each input, and two rules.

In general, a fuzzy system consists of three stages:

**Fuzzification**: the process of labeling the crisp value of a numerical input with linguistic terms and assigning a membership value for the input.

**Fuzzy inference system**: determination of the conclusions or the generation of hypotheses based on a given input state using the expert knowledge.

**Defuzzification**: the process of calculating a crisp value from the fuzzy inference system.

The first layer of ANFIS determines the degree to a fuzzy condition involving the given input by using membership functions ( $A_i$  and  $B_i$ ). The second layer evaluates the truth value (matching degree) of the premise of each rule in the rule base. The third layer normalizes these truth values. The fourth layer computes the consequent of each rule. Finally, the fifth layer computes the aggregate output of all the rules.

The activities of these five layers are similar to the three steps of fuzzification, fuzzy inference system, and defuzzification mentioned above.

Since ANFIS employs gradient descent to fine-tune the parameters of membership functions and uses the least squares method to identify the coefficient of each output, hence, it is an adaptive and hybrid model<sup>3</sup>.

### **Description of Pilot Vibration Database**

The 200 point database that was created in<sup>4-6</sup> is used in this study. The source of this 200 point database was the NASA/Army Airloads Program flight test database<sup>9</sup>. The following categories of flights were included: Steady and Maneuvering Airloads and Maneuvers. The following flight conditions were included: level flight, rolls, pushovers, pull-ups, autorotations, and landing flares. These conditions approximate the entire UH-60A flight envelope. A static-mapping approach involving the peak vibration level was used in creating the 200 point database<sup>6</sup>. This implies that each flight condition is characterized by its peak vibration. Such a quasi-static approach will not capture all dynamic effects, and may miss the prediction of relevant maximums during unsteady, dynamic maneuvers.

### **Results**

In this work two sets of data are considered. The first data set includes only steady level flight conditions and the second set includes the entire database, including maneuver conditions. In both cases, the 4P peak, pilot vertical vibration (PVV) is the single output of the ANFIS. The results shown in Figs. 3, 4, and 6 are testing (validating) flight test data points that were not included in the training of ANFIS model. The testing data are chosen randomly from flight tests.

#### **Level Flight**

This case involves level flight conditions with varying advance ratio and gross weight (constant RPM). The two inputs are the advance ratio and the gross weight, and the single output is the PVV. There is very little hover information in the database (the hover data points form less than 4% of the total data). Also, it has been presently observed that these hover points involve higher vibration values, and consequently, without adequate flight tests, the proposed neuro-fuzzy model has difficulty in modeling the hover points. After removing three

hover points, the level flight case involves 78 flight data points, of which 39 are used for training and the remaining 39 are used for testing (validating) the neuro-fuzzy model. For this case, the subtractive clustering option in the ANFIS toolbox is used. For each input, two membership functions are used along with the two fuzzy rules. After training for 3 epochs, the average training error is 0.026 and the average testing error is 0.029. The successful predicted vibration is shown in Fig. 3. The prediction error is mostly within  $\pm 0.05$  g's.

#### **All-Flights (Entire Database)**

This involves all flight conditions. The following flight conditions were included: level flight, rolls, pushovers, pull-ups, autorotations, and landing flares. There are 206 flight data points, of which half are used for training, and the other half for testing. Two cases are considered. In the first case, 5 inputs are used to train ANFIS. The 5 inputs are as follows: advance ratio, gross weight, RPM, density ratio, and maneuver effect factor (MEF)<sup>4</sup>. For this 5 input case, the subtractive clustering option in the ANFIS model is used. The results are shown in Fig. 4. For a 3 epoch training, the average training error is 0.035 and the average testing error is 0.044. Figure 4 shows that the present neuro-fuzzy approach produces an acceptable model of the UH-60A pilot floor vertical vibration, PVV. A schematic of ANFIS model for the above results (for 5 inputs, two membership functions for each input, two fuzzy if-then-rules, and single output) is shown in Fig. 5.

In the second case, 6 inputs are used to train ANFIS model. The ascent/descent rate is added to the above 5 inputs. For the present 6 input case, the subtractive clustering option in the ANFIS model is used. For each input, five membership functions are used along with the five fuzzy rules. For a 3 epoch training, the average training error is 0.022 and the average testing error is 0.055. The results are shown in Fig. 6. This result suggests that adding the ascent/descent rate does not improve the vibration prediction.

### Conclusions

An adaptive neuro-fuzzy model is used to represent the vibration in the UH-60A helicopter. The results indicate that neuro-fuzzy modeling can be successfully used to model and predict the UH-60A vibration to less than 0.05 g's (average error). Since the proposed model converges very fast, it can be potentially used for real time predictions and to identify additional system identification parameters. The results also indicate that by including the ascent/descent rate as an additional input, the prediction accuracy is not improved.

### References

1. Yen, J. and Langari, R., *Fuzzy Logic: Intelligence, Control, and Information*, Prentice Hall, 1999.
2. Jang, J-S. Roger, "ANFIS: Adaptive-Network-Based Fuzzy Inference Systems," *IEEE Transactions on Systems, Man, and Cybernetics*, Vol. 23, No. 03, pp. 665-685, May 1993.
3. Anonymous, *Fuzzy Logic Toolbox User's Guide*, The Math Works, Version 2, 1995-1998.
4. Kottapalli, S., "Neural Network Based Representation of UH-60A Pilot and Hub Accelerations," *Journal of the American Helicopter Society*, Vol. 47, No. 1, January 2002, pp. 33-41.
5. Kottapalli, S., "Modeling of UH-60A Hub Accelerations with Neural Networks," American Helicopter Society Aerodynamics, Acoustics, and Test and Evaluation Technical Specialists' Meeting, San Francisco, California, January 2002.
6. Kottapalli, S., "Neural-Network-Based Modeling of Rotorcraft Vibration for Real-Time Applications," AIAA Modeling and Simulation Technologies Conference, AIAA-2000-4305, Denver, Colorado, August 2000.
7. Kottapalli, S. "Neural Network Research on Validating Experimental Tilt-Rotor Performance," *Journal of the American Helicopter Society*, Vol. 45, No. 3, pp. 199-206, July 2000.
8. Kottapalli, S. and Kitaplioglu, C., "Neural Network Representation of External Tilt-Rotor Noise," *Journal of the American Helicopter Society*, Vol. 47, No. 2, April 2002, pp. 109-114.
9. Kufeld, R.M. and Bousman, W.G., "UH-60A Helicopter Rotor Airloads Measured in Flight," *The Aeronautical Journal of the Royal Aeronautical Society*, May 1997.

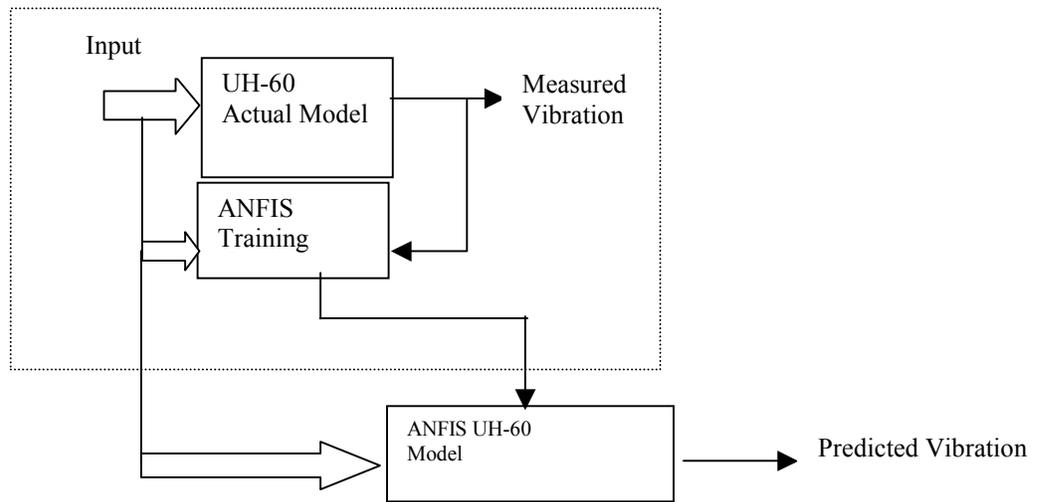

Figure 1. The proposed neuro-fuzzy vibration prediction model.

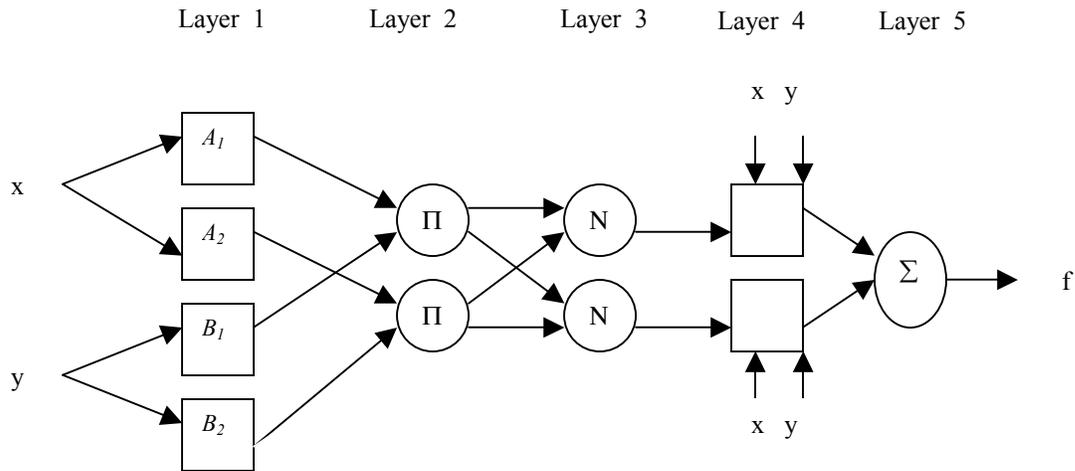

Figure 2. Architecture of two inputs with two membership functions of the ANFIS model.

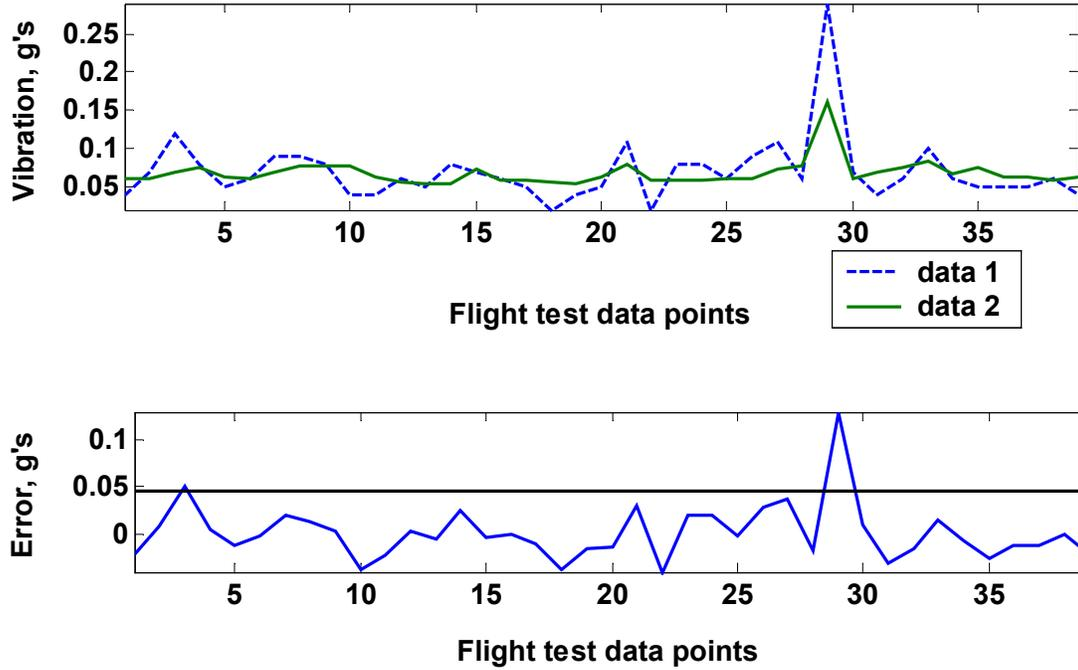

Figure 3. The result of level flight. Data 1 is the ANFIS predicted vibration and data 2 is the actual vibration. The error is the difference between actual vibration and the predicted vibration.

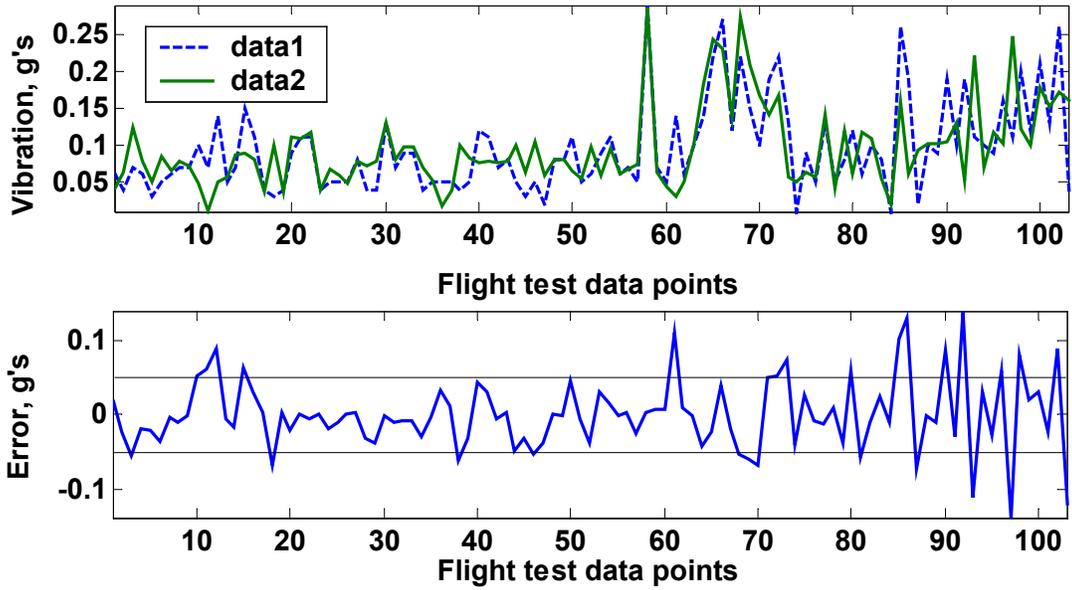

Figure 4. The result of all flights using 5 inputs. Data 1 is the ANFIS predicted vibration and data 2 is the actual vibration. Error is the difference between the actual and predicted vibration.

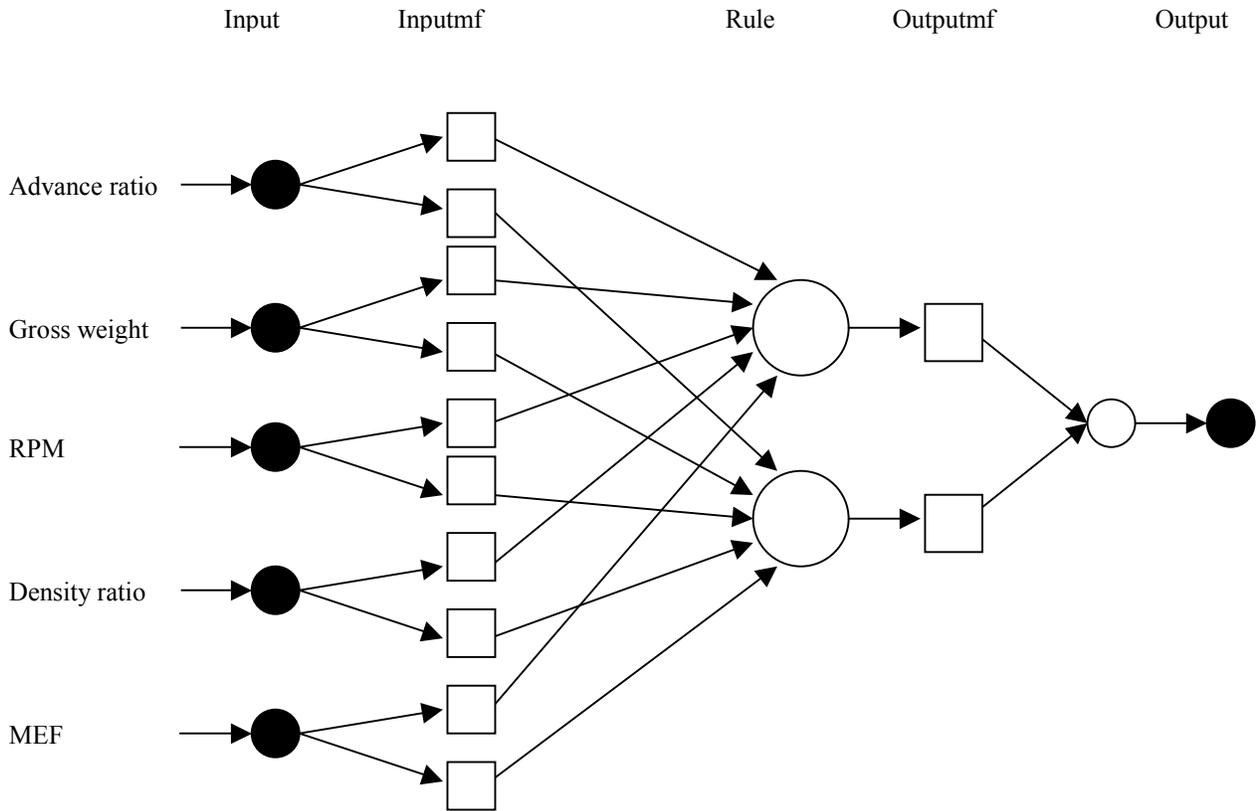

Figure 5. Architecture of ANFIS for 5 inputs vibration prediction. The function of each layer is the same as in Fig. 2.

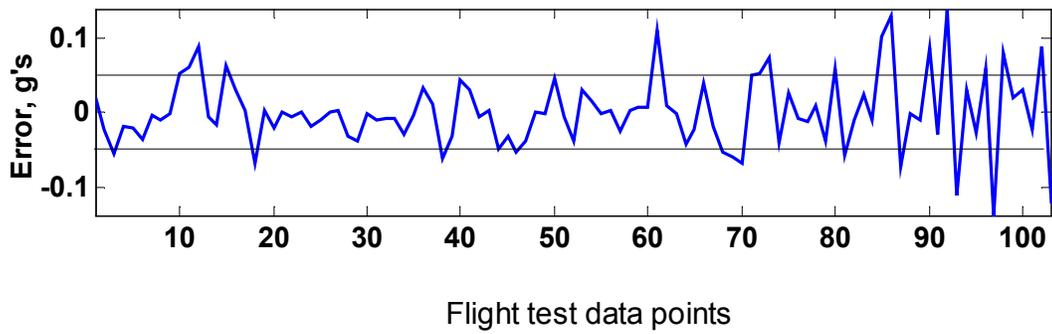
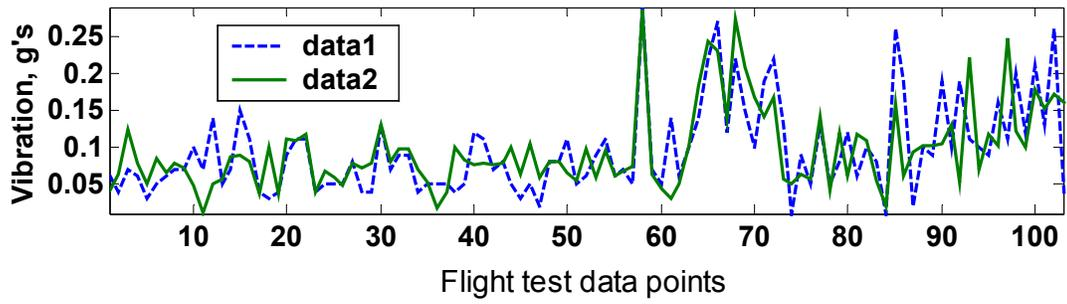

Figure 6. The result of all flight using 6 inputs. Data 1 is the ANFIS predicted vibration and data 2 is actual vibration. Error is the difference between the actual and the predicted vibration.