

## THE DEVELOPMENT OF RISK-NL V5.0 AND ITS APPLICATIONS

*Martijn van der Voort<sup>#</sup>, Reinier Sterkenburg<sup>§</sup>,  
Ruud van Amelsfort<sup>#</sup>, Philip van Dongen<sup>#</sup>*

*<sup>#</sup>TNO Defence, Security and Safety, P.O. Box 45, 2280 AA Rijswijk, The Netherlands,  
Phone: +31-(0)15-284 3462, Fax: +31-(0)15-284 3991,*

*[martijn.vandervoort@tno.nl](mailto:martijn.vandervoort@tno.nl)*

*<sup>§</sup>TNO Built Environment and GeoSciences, P.O. Box 80015, 3508 TA Utrecht, The  
Netherlands, Phone: +31(0)8886 62077, Fax: +31(0)8886 62050,*

*[reinier.sterkenburg@tno.nl](mailto:reinier.sterkenburg@tno.nl)*

Key words: software, external safety, ammunition storage, risk, explosion

### Abstract

Risk-NL is a Quantitative Risk Assessment (QRA) software tool for the external safety of ammunition storage sites. The Netherlands MoD has asked TNO to upgrade Risk-NL with improved models that have recently been developed, and a new user interface.

The new models implemented in Risk-NL v5.0 are more physics-based, and have a higher level of detail resulting in a better quantitative discrimination of risks for different scenarios. The most important improvement is the possibility to distinguish between debris from walls and the roof of RC magazines, and between debris and primary fragments from cased ammunition. Also the new model for window failure is a major improvement and has a more sound basis than its predecessor.

The combination of the new user interface and the new models in Risk-NL v5.0 give unique possibilities to analyze risk, and to investigate options for risk reduction. Risk-NL v5.0 also provides possibilities for optimization in the design of new types of magazines and ammunition storage sites.

The paper gives a description of the new features and the new possibilities are illustrated with a case study.

### 1. Introduction

Risk-NL is a Quantitative Risk Assessment (QRA) software tool for the external safety of the storage of explosives and ammunition. From 2001 to 2007 Risk-NL v4.1 has been used to analyse the external safety of about 50 NLD military sites where activities with explosives and ammunition take place. In this period Risk-NL v4.1 has been kept unchanged. The Netherlands MoD has asked TNO to upgrade Risk-NL with improved models that have been recently developed, and a new user interface. This has led to an upgrade of Risk-NL v4.1 to Risk-NL v5.0. A detailed description of the new features is given by (Van der Voort, 2009) and in (AASTP-4, 2008), while a brief overview is given in Section 2, 3 and 4 of this paper. The new possibilities are illustrated with a case study in Section 5.

Dutch regulations (MP 40-21, 2006) demand that an analysis of the external safety of ammunition storage sites consist of the following three sequential steps:

## Report Documentation Page

*Form Approved*  
*OMB No. 0704-0188*

Public reporting burden for the collection of information is estimated to average 1 hour per response, including the time for reviewing instructions, searching existing data sources, gathering and maintaining the data needed, and completing and reviewing the collection of information. Send comments regarding this burden estimate or any other aspect of this collection of information, including suggestions for reducing this burden, to Washington Headquarters Services, Directorate for Information Operations and Reports, 1215 Jefferson Davis Highway, Suite 1204, Arlington VA 22202-4302. Respondents should be aware that notwithstanding any other provision of law, no person shall be subject to a penalty for failing to comply with a collection of information if it does not display a currently valid OMB control number.

1. REPORT DATE <b>JUL 2010</b>	2. REPORT TYPE <b>N/A</b>	3. DATES COVERED <b>-</b>	
4. TITLE AND SUBTITLE <b>The Development Of Risk-NI V5.0 And Its Applications</b>		5a. CONTRACT NUMBER	
		5b. GRANT NUMBER	
		5c. PROGRAM ELEMENT NUMBER	
6. AUTHOR(S)		5d. PROJECT NUMBER	
		5e. TASK NUMBER	
		5f. WORK UNIT NUMBER	
7. PERFORMING ORGANIZATION NAME(S) AND ADDRESS(ES) <b>TNO Defence, Security and Safety, P.O. Box 45, 2280 AA Rijswijk, The Netherlands</b>		8. PERFORMING ORGANIZATION REPORT NUMBER	
9. SPONSORING/MONITORING AGENCY NAME(S) AND ADDRESS(ES)		10. SPONSOR/MONITOR'S ACRONYM(S)	
		11. SPONSOR/MONITOR'S REPORT NUMBER(S)	
12. DISTRIBUTION/AVAILABILITY STATEMENT <b>Approved for public release, distribution unlimited</b>			
13. SUPPLEMENTARY NOTES <b>See also ADM002313. Department of Defense Explosives Safety Board Seminar (34th) held in Portland, Oregon on 13-15 July 2010, The original document contains color images.</b>			
14. ABSTRACT <b>Risk-NL is a Quantitative Risk Assessment (QRA) software tool for the external safety of ammunition storage sites. The Netherlands MoD has asked TNO to upgrade Risk-NL with improved models that have recently been developed, and a new user interface. The new models implemented in Risk-NL v5.0 are more physics-based, and have a higher level of detail resulting in a better quantitative discrimination of risks for different scenarios. The most important improvement is the possibility to distinguish between debris from walls and the roof of RC magazines, and between debris and primary fragments from cased ammunition. Also the new model for window failure is a major improvement and has a more sound basis than its predecessor. The combination of the new user interface and the new models in Risk-NL v5.0 give unique possibilities to analyze risk, and to investigate options for risk reduction. Risk-NL v5.0 also provides possibilities for optimization in the design of new types of magazines and ammunition storage sites.</b>			
15. SUBJECT TERMS			
16. SECURITY CLASSIFICATION OF:			17. LIMITATION OF ABSTRACT <b>SAR</b>
a. REPORT <b>unclassified</b>	b. ABSTRACT <b>unclassified</b>	c. THIS PAGE <b>unclassified</b>	
			18. NUMBER OF PAGES <b>37</b>
			19a. NAME OF RESPONSIBLE PERSON

*Internal Safety*

First the internal safety is analysed. For an internally safe military storage site sympathetic reactions can be excluded; a detonation in one magazine cannot cause a sympathetic detonation in another. If necessary, changes need to be made to guarantee internal safety. The remaining part of the analysis is based on the condition that the storage site is internally safe.

*ABC Zoning*

The A, B and C zone are determined next. These zones correspond to certain effect levels. Regulations in the Netherlands (MP 40-21, 2006) state which external objects are not allowed to be present within these zones. Zone A stands for Public Traffic Route Distance (PTRD), Zone B stands for Inhabited Building Distance (IBD), and Zone C is usually twice Zone B. If a conflicting situation exists a QRA has to be carried out in order to quantify the risk.

*QRA*

Risk is determined by the frequency of an accidental explosion, its consequences in terms of the probability of lethality, and the exposure. When a QRA is carried out both the Individual Risk and Societal Risk are determined. The Individual Risk is defined as the risk experienced by an unprotected person that is continuously present in the free field. The Societal Risk is a more realistic measure, which takes into account the actual location and presence of persons. The Societal Risk is expressed in a so-called FN-curve. The last step in a QRA is the comparison of the Individual Risk and Societal Risk with criteria.

**2 Internal Safety**

The analysis of the Internal Safety is carried out by default with the QD tables from (MP40-21, 2006). Dependent on the relevant combinations of PES (Potentially Explosive Sites) or ES (Exposed Sites) magazine types, these QD-tables give the required inter-magazine distances (Figure 1). PES and ES are also referred to as ‘donor’ and ‘acceptor’.

MP 40-21  
(8-97) B9 - 4

Voorschrift opslag gevaarlijke stoffen  
Bijlage 9. Veiligheidsafstanden op munitiecomplexen

Veiligheidsafstanden voor munitie van de gevarenklasse 1.1

		DONOR, dat is het magazijn waarin het ongeval te weten brand en/of detonatie plaatsvindt							
ACCEPTOR, dat is het magazijn waarvan de inhoud is beschermd mits aan de daaraan veiligheidsafstand is voldaan.		x	b/c <sup>(1)</sup>	x	x	b/c <sup>(1)</sup>	x	x	b/c <sup>(1)</sup>
		b/c <sup>(1)</sup>	b/c <sup>(1)</sup>	b/c <sup>(1)</sup>	b/c <sup>(1)</sup>	b	b/c <sup>(1)</sup>	b/c <sup>(1)</sup>	b/c <sup>(1)</sup>
		x	b/c <sup>(1)</sup>	x	x	b/c <sup>(1)</sup>	x	x	b/c <sup>(1)</sup>
		b/c <sup>(1)</sup>	b/c <sup>(1)</sup>	b/c <sup>(1)</sup>	b/c <sup>(1)</sup>	b	b/c <sup>(1)</sup>	b/c <sup>(1)</sup>	b/c <sup>(1)</sup>
		b/c <sup>(1)</sup>	b/c <sup>(1)</sup>	b/c <sup>(1)</sup>	b/c <sup>(1)</sup>	b/c <sup>(1)</sup>	c/x <sup>(2)</sup>	c/x <sup>(2)</sup>	b/c <sup>(1)</sup>
		x	b/c <sup>(1)</sup>	x	x	b/c <sup>(1)</sup>	x	x	b/c <sup>(1)</sup>
		b/c <sup>(1)</sup>	b/c <sup>(1)</sup>	b/c <sup>(1)</sup>	b/c <sup>(1)</sup>	b/c <sup>(1)</sup>	c/x <sup>(2)</sup>	c/x <sup>(2)</sup>	b/c <sup>(1)</sup>
		x	b/c <sup>(1)</sup>	x	x	b/c <sup>(1)</sup>	x	x	b/c <sup>(1)</sup>
		b	b	b	b	a	b	b	b
		x	b/c <sup>(1)</sup>	x	x	b/c <sup>(1)</sup>	x	x	b/c <sup>(1)</sup>
		x	b/c <sup>(1)</sup>	x	x	b/c <sup>(1)</sup>	x	x	b/c <sup>(1)</sup>
		b/c <sup>(1)</sup>	b/c <sup>(1)</sup>	b/c <sup>(1)</sup>	b/c <sup>(1)</sup>	b/c <sup>(1)</sup>	c/x <sup>(2)</sup>	c/x <sup>(2)</sup>	b/c <sup>(1)</sup>

Figure 1. Internal Safety Table from (MP40-21, 2006)

With Risk-NL v5.0 the analysis can additionally be conducted with other QD tables, such as those given in (AASTP-1, 2006). The number of magazine types is much larger in the latter

case (33 instead of 11) which enables the user to account more specifically for different storage structures.

### 3 ABC Zoning

In general, the IBD (B-Zone) for HD1.1 is determined by either blast or debris. The blast IBD given by AASTP-1 is based on a 5 kPa blast overpressure criterion (dashed black curve in Figure 2). For debris, AASTP-1 poses a criterion of 1 lethal piece of debris per 56 m<sup>2</sup>, resulting in a minimum IBD of 400 m. This implies that for small NEQ the IBD is determined by a fixed (debris) IBD of 400 m.

Improved QD relations have been derived within the precursor project ‘Small Quantities NEQ’ (Verolme, 2006). These are the solid lines in Figure 2. The improved QD relations are data fits to experimentally determined debris IBDs for HD1.1 ammunition, also shown in Figure 2. The data is partly based on (Swisdak, 2002), and has been extended with more recent test data. The data set contains trials with brick and reinforced concrete (RC) magazines, ISO containers, earth covered magazines (ECM), and hardened aircraft shelters (HAS). The debris IBDs have been determined according to the PTN (Pseudo Trajectory Normal) method described by (Gould, 1998).

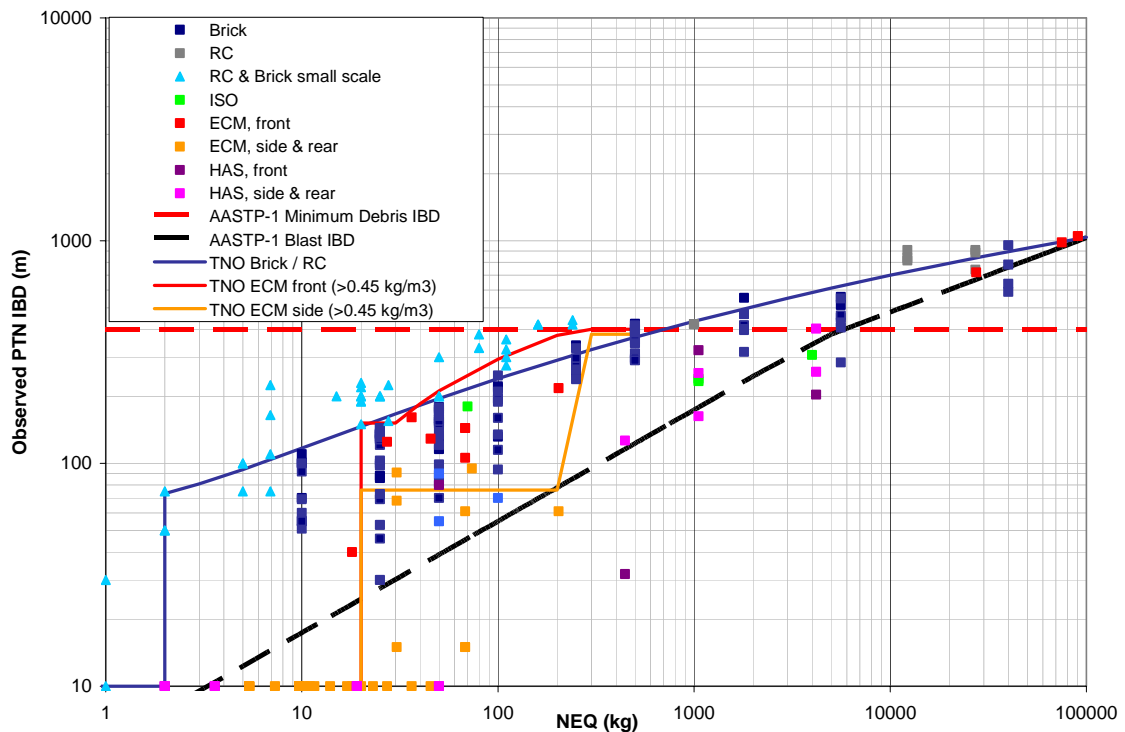


Figure 2. Experimentally determined Debris IBDs plotted together with QD relations

A comparison between AASTP-1 and the dataset leads to the following conclusions:

- The observed debris IBDs typically supersede the AASTP-1 blast IBD. It should however be realized that the debris IBDs given in Figure 2 have been determined in the wall normal direction, i.e. the direction in which the debris throw is largest. As a result the blast IBD will gain importance in of-normal directions.
- For small NEQ (<500 kg) experimentally observed debris IBDs are significantly smaller than 400 m. The largest observed debris IBDs are for small scale experiments with brick and RC magazines (typical size 1-2 m). The small volume of these

structures leads to relatively high loading densities, debris velocities and hence IBDs. This data has however not been used as input for the improved QD relation for Brick/RC, because these tests are not representative for ammunition magazines in the Netherlands. The improved QD relation for Brick/RC has been based on UK and US full scale testing.

- Other data fits are used for the front and sides of ECMs, for which trials show containment below 20 kg. The debris IBD at the sides of an ECM is significantly smaller as compared to its front in the small NEQ regime. Figure 2 also shows data for HASs which exhibit even smaller debris IBDs. No data fit has been obtained for this structure type.

With Risk-NL v5.0 the calculation of the ABC Zoning is carried out with the improved QD relations.

#### 4 Quantitative Risk Assessment (QRA)

The QRA calculations in Risk-NL have been improved with new models which have been developed within the research program V402 'Safety of Personnel'. This section gives a general overview of the QRA calculations in Risk-NL v5.0.

##### 4.1 The Risk equation

The basis of the QRA calculations is the Risk equation:

$$Risk = P_{event} \cdot P_{lethal} \cdot P_{exposure} \quad (1/year) \quad (1)$$

Risk consists of a multiplication of three equally important contributions;

- The event frequency (1/year)
- The probability of lethality given the event (-)
- The probability of exposure (-)

The event takes place at a Potentially Explosive Site (PES). In a Quantitative Risk Assessment (QRA) for the external safety, an Exposed Site (ES) is a location outside the storage site to which persons are associated. Examples are persons in the free field, in buildings, or in vehicles.

From the risk equation follows that if any of the contributions equals zero, the risk is also equal to zero. As a result three ways to reduce the risk can be identified;

- Prevention (reduction of the event frequency). This can be achieved by following safety procedures, for example those specified in the (MP40-21, 2006).
- Mitigation (reduction of the consequences of an event). This can be achieved by taking measures at the PES. An example is to reduce the NEQ. Another possibility is to take measures at the ES. Examples are a reinforced construction or a protective barrier.
- Reduction of the exposure to the event. If possible the presence of persons in the vicinity of a PES can be minimized.

The risk equation also makes clear that an event with a large event frequency but a small consequence, might lead to the same risk as an event with a small event frequency but a large consequence. In other words, the three contributions in the risk equation are interchangeable. If the event frequency is set to '1' we are performing a consequence analysis. In this case we calculate the probability of lethality given a certain scenario.

The probability of lethality consists of contributions from various explosion effects and lethality mechanisms. The explosion effects (blast, fragment and debris throw, and thermal radiation), and as a result also the probability of lethality, strongly depend on the location relative to the event. The varying risk in the vicinity of a PES is also called the risk field.

In practice, many explosion events (scenarios) are important, each with their own frequency of occurrence. Within a PES, scenarios may vary from a deflagration of a number of items to a mass detonation of the entire contents. Furthermore various PES's are often present at an ammunition storage site. The overall risk consists of a summation over all relevant scenarios.

#### 4.2 *Risk-NL Scenarios*

With Risk-NL only one scenario per PES is taken into account. This is the Maximum Credible Event (MCE), for which it is assumed that:

- The NEQ involved in the MCE (explosive reaction or detonation) is equal to the licensed NEQ for each of the three hazard divisions.
- The probability of lethality at a certain location is the maximum value of the contributions from the three hazard divisions.
- The explosion effects take place instantaneously, leaving no time for escape.

Furthermore it is important to note that the mixing and aggregation rules from (AASTP-1, 2006) apply. This means that if HD1.1 and HD1.2 are stored simultaneously, the total NEQ has to be considered as HD1.1. This total amount can not exceed the licensed amount of HD1.1.

The event frequency has been based on a study of available accident data from several NATO countries covering the time period 1960-1980. A distinction is made between regular storage, irregular storage and storage in vehicles on the site, and workshop ammunition activities. The results are not presented in the current paper.

#### 4.3 *Probability of lethality*

The probability of lethality consists of contributions from various explosion effects and related lethality mechanisms. Results are generated for persons in the free field (FF), in buildings (HS) and in vehicles (RD). An overview is given in Table 2.

##### *Blast*

All explosives and ammunition with the potential for a mass detonation are classified as HD1.1. Only these substances can cause a major blast wave. For most magazine types the blast wave has no directional dependence. For earth covered magazines the blast wave is reduced in the rear and side direction of the magazine, while it is enhanced at the front side.

An important blast related lethality mechanism is lung rupture, caused by blast loading of the thorax. Head and body impact takes place after acceleration of the human body, primarily by the blast wind. For persons residing in buildings and vehicles the blast loading is more complex. The blast wave first reflects at the structure and only partly enters after window failure. The reduced blast wave then reflects at walls, giving rise to local high overpressures. Taking the various phenomena into account it is assumed that the blast loading of a person in the free field is also representative for persons in buildings and vehicles.

Additional lethality mechanisms for persons in buildings are glass shard lacerations due to window failure and building collapse. A reflected blast loading is assumed for windows, because usually at least one side of a building will be facing the PES. The new window failure and lethality model is described in another paper by (van Doormaal, 2010). It is assumed that during an explosion event 25 % of all persons in a building are exposed to glass shards from

window failure. The percentage has been based on the typical locations of persons within rooms that have a line of sight more or less perpendicular to windows.

*Table 2 Explosion effects, hazard divisions, lethality mechanisms, and relevancy for persons in the free field, in buildings, and in vehicles. Assumptions about blast loads, debris and fragments and thermal radiation are also indicated.*

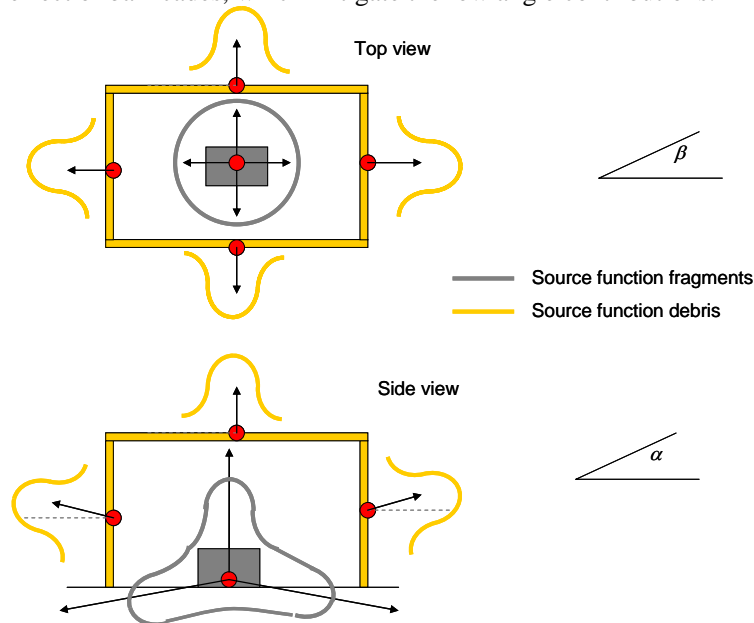
Explosion effect	Hazard division	Explosion effect relevant IF	Lethality mechanism	Relevant for persons in		
				Free Field (FF)	Building (HS)	Vehicle (RD)
<b>Blast</b>	HD1.1		Lung rupture	YES, Side-on blast load plus dynamic pressure (blast wind)		
			Head and body impact	YES, Dynamic pressure (blast wind)		
			Window failure	NO	YES, Reflected blast load	NO
			Building collapse	NO	YES, Based on Side-on blast load	NO
<b>Fragments Horizontal</b>	HD1.1	Cased AND No Barricade	Penetration	YES	YES, after penetration of 230 mm concrete/ 300 mm brick or window pane	YES, after penetration of 2 mm mild steel or window pane
	HD1.2	Cased AND No Barricade	Penetration			
<b>Fragments Vertical</b>	HD1.1	Cased	Penetration			
	HD1.2	Cased	Penetration			
<b>Debris Horizontal</b>	HD1.1	No Barricade	Penetration			
			Blunt body			
<b>Debris Vertical</b>	HD1.1		Penetration			
			Blunt body			
<b>Thermal</b>	HD1.3		Skin burn	YES	YES, Reduction of thermal radiation by factor 2	YES, Reduction of thermal radiation by factor 2

#### *Debris and fragments*

For cased HD1.1 and HD1.2, primary fragments contribute to the hazard. For HD1.1 (cased and bare explosives) debris generated by the storage structure forms an additional threat. A new model for fragment and debris throw has been implemented in Risk-NL v5.0. It is based on available open literature on full scale explosion trials, and is more physics-based than its predecessor.

Based on the geometry of the storage structure and the NEQ, distributions of the debris and fragment mass, launch velocity, and angle are specified. All fragment and debris contributions are expressed in the 10 Sci Pan mass bins. Impact locations are calculated using an analytical solution to the equations of motion; the horizontal drag approximation and the vertical drag approximation (Van der Voort, 2008-2). The source function theorem is an efficient method to calculate the resulting debris density in horizontal and vertical planes (Van der Voort, 2008-1).

A distinction has been made between fragments and debris launched around the horizontal direction (low angle) and around the vertical direction (high angle). The angular distribution (source function) has been illustrated in Figure 3 (Side view and Top view). The distinction between 'horizontal' and 'vertical' debris can be made because preferred launch directions are more or less perpendicular to structural elements (walls and roof). For fragments the distinction is related to the shell placement, which is mostly vertical. Low angle fragments originate from shells at the sides of the stack, while high angle fragments are launched from shells in the bulk of the stack (TP16, 2009). The distinction enables the user to quantify the effect of barricades, which mitigate the low angle contributions.



**Figure 3.** Schematic illustration of the initial angular distribution for fragments and debris

The new model for fragment and debris throw has been validated against a large number of trials. An example is shown in Figures 4 and 5 for a trial with stacked artillery shells (NEQ of 5 tonnes) in an ISO container surrounded by barricades.





Figure 4. Overview of the 5 tonnes trial (Van der Voort, 2008-1)

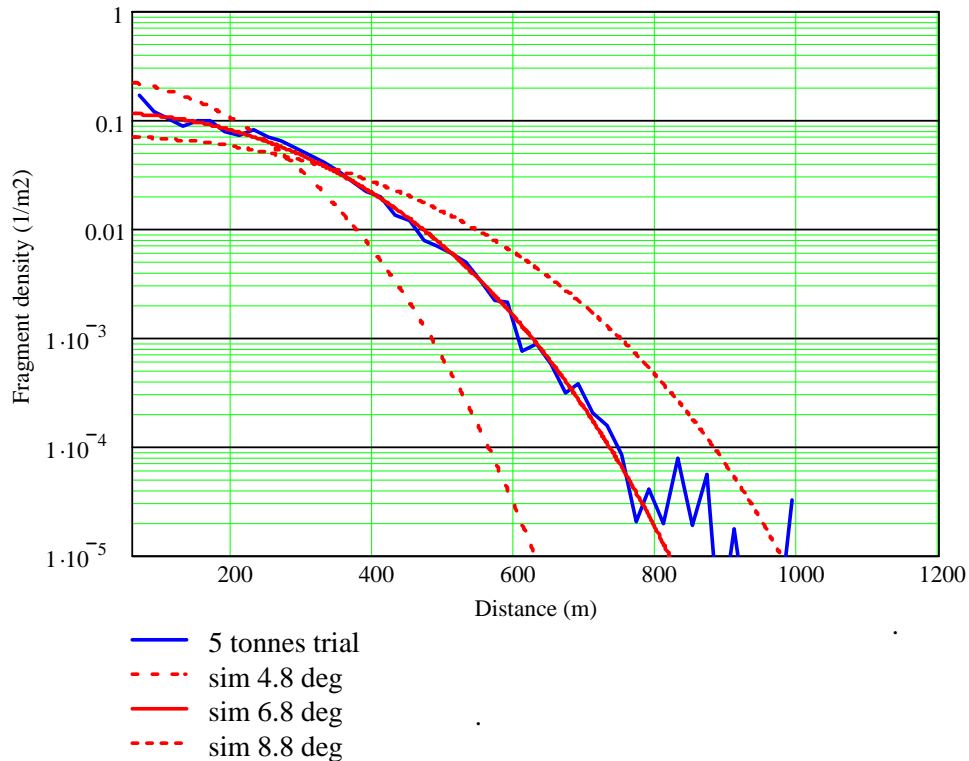


Figure 5. Fragment density in the horizontal plane versus distance (Van der Voort, 2008-1). Experimental data and calculation results.

The fragment pick-up comprises mainly high angle fragments, because the low angle fragments have been blocked by the barricades. A good match is obtained between model predictions and trial data, if an appropriate choice is made for the fragment launch angle distribution (standard deviation 6.8°). This model has also been used to develop a consequence analysis method for field storage in AASTP-5. This is described in another paper (Van der Voort, 2010-1) and (Van der Voort, 2010-2).

The probability of lethality due to fragment and debris throw consists of two parts; the hit probability, and the probability of lethality given a hit.:

$$P_{lethal} = P_{hit} \cdot P_{lethal, hit} \quad (2)$$

The hit probability of a person strongly depends on its orientation. Initially a standing orientation is assumed for persons in the free field and in buildings. This is the worst case situation for the low angle fragments and debris. High angle fragments and debris impact much later (after 10's of seconds). By that time it is likely that persons have a laying orientation, either because they are turned over by the blast wave or because they tend to hide at the ground level. This is the worst case situation for the vertical fragments and debris. The area of the human body (laying or standing) is taken equal to 0.56 m<sup>2</sup> (AASTP-1, 2006).

Persons in buildings have ballistic protection from concrete or brick walls. It is determined which fragments and debris are able to perforate a wall. No ballistic protection exists when fragments and debris enter the building through windows. The same reasoning is applied for persons in vehicles. The probability of lethality depends on mass and impact velocity, and is assessed according to (PGS 1, 2003).

#### *Thermal radiation*

The last contribution to the probability of lethality is the thermal hazard, primarily caused by HD1.3. This hazard consists of a fireball for light structures, while for heavy structures a jet flame at the front (doorside) can be expected. Persons present within the fireball radius or flame jet have a 100 % probability of lethality. At a distance persons are exposed to thermal radiation. This effect is reduced for persons in buildings and vehicles.

#### *4.4 Exposure and Risk measures*

The last term in the risk equation is the exposure.

The exposure is set to 100% for the calculation of the Individual Risk, which is defined as the risk experienced by an unprotected person that is continuously present in the free field (FF). The Individual Risk is presented with risk contours to the Individual Risk field. These contours can be compared with criteria. In the Netherlands the criterion for existing situations is 10<sup>-5</sup> / year, while the criterion for new situations is 10<sup>-6</sup> / year (MP40-21, 2006). Likewise risk contours can be calculated and presented for persons in buildings (HS) and in vehicles (RD), but these have no formal status.

For the calculation of the Societal Risk, more realistic values of the exposure are used in order to match the actual presence of the population. Assumptions about the presence are made in accordance with (PGS 3, 2005) and (Handreiking verantwoordingsplicht groepsrisico, 2007). For each scenario the total number of fatalities at the ESs is calculated. The scenarios are then ordered by increasing frequency and a diagram of cumulative frequency versus the number of fatalities is presented next. This is the F/N curve which represents the probability of a certain number of fatalities versus the yearly probability of an accident with that number of fatalities or less. In the Netherlands, the probability of accidents must be inversely proportional to *the square of the number of fatalities* (MP40-21, 2006). The criterion for existing situations is 10<sup>-4</sup> for a group of 10 persons, while for new situations it is 10<sup>-5</sup> for a group of 10 persons.

#### *4.6 RiskCurves*

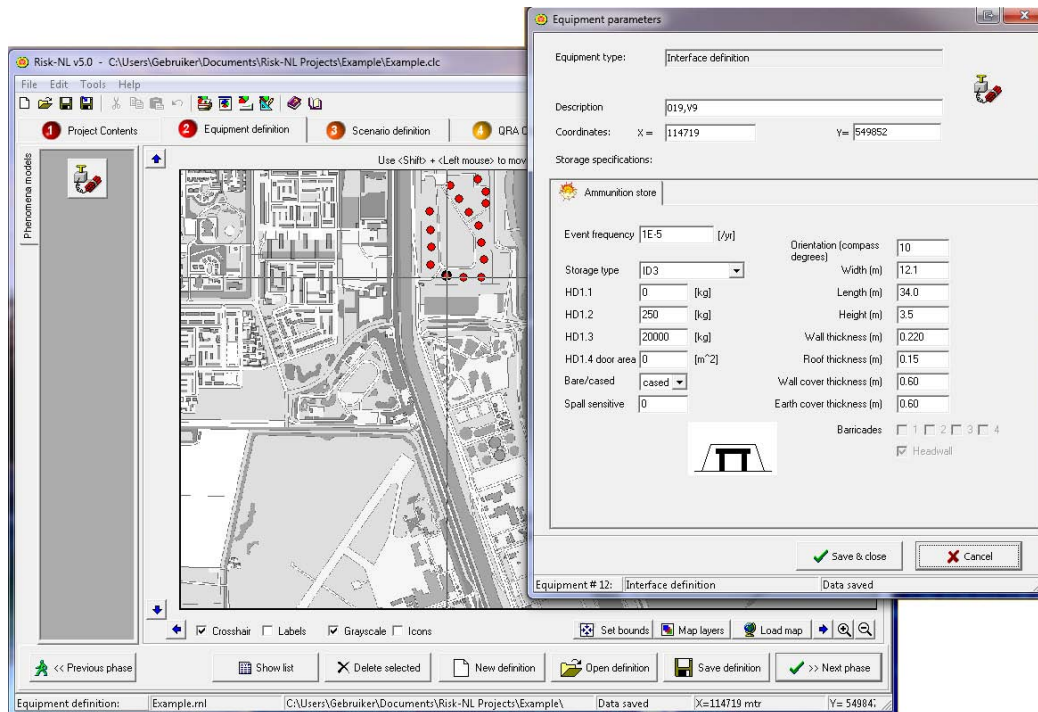
RiskCurves is a user friendly risk assessment software tool developed by TNO Built Environment for the field of Industrial Safety (RiskCurves user manual, 2008). In cooperation with TNO Built Environment and GeoSciences, a special version of RiskCurves has been developed that is dedicated to Risk-NL calculations (Sterkenburg, 2009).

RiskCurves functions as a user-interface through which an input file for Risk-NL can be set up. Using a map as background, the ‘donor’ locations and other properties like the NEQ of stored explosives and geometry of the storage building can be entered in easy to use dialogs. RiskCurves also facilitates a number of ways to enter population in an area, either permanently or temporarily. There are map based editors for population grids for day time and night time presence, for road segments (transportation units) with their associated traffic intensities and velocities, and an editor for short duration events with high population concentrations like concerts or sports events. The program generates a text based input file for the Risk-NL calculation kernel and, after completion, reads its output to process it further into maps and charts.

Furthermore, calculation and presentation of the ABC Zoning, Individual Risk contours and Societal Risk (FN-curve) is carried out with RiskCurves.

## 5. Case study

In this section Risk-NL v5.0 is illustrated with a case study. The case study concerns a (fictitious) storage site with a few dozen ammunition magazines. After starting up the program, the operator creates a new project and chooses a background map. Various commonly used types of map file formats are supported, vector based as well as raster based. Population grids, traffic data and population concentrations can also be entered now.



**Figure 6.** *Entering storage locations and parameters in the map based user interface.*

The first step is to enter the individual storage buildings into the project. New locations for buildings can be dragged onto the map upon which the dialog appears in which the properties for the individual buildings can be entered, as illustrated in Figure 6.

After completing the input data, the model calculations can be started. Running these typically takes a few seconds up to one minute for a very large storage site (> 50 buildings).

The calculation module will signal whether the storage site is internally safe or not (see also Section 2). For an internally safe military complex, sympathetic reactions must be excluded; a detonation in one magazine may not cause a sympathetic detonation in another. If necessary, changes need to be made to guarantee internal safety. Whether or not the site is internally safe will be presented on each map, chart and printout.

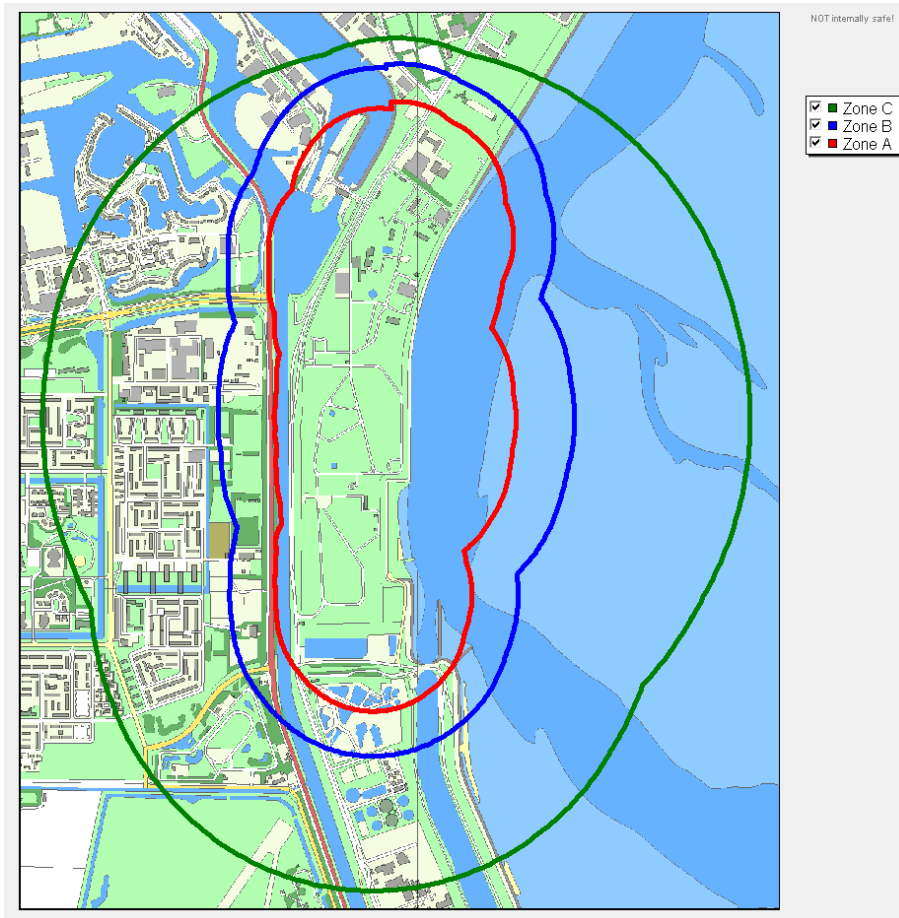


Figure 7. ABC zones for the storage site.

The second step in the analysis is the determination of the ABC zoning (see also Section 3). The overall zones for the site are calculated as the unions of the zones of the individual storage buildings. The ABC zoning for the present case study is shown in Figure 7. If a conflicting situation exists, a QRA has to be carried out in order to quantify the risk. This is clearly the case, because some external objects are present within zone B at the east side of the storage site. As a result the Individual Risk and Societal Risk have to be determined.

Figure 8 shows the Individual Risk contours: lines on the map which represent points with an equal Individual Risk value. Values of  $10^{-4}$ ,  $10^{-5}$ ,  $10^{-6}$ ,  $10^{-7}$ ,  $10^{-8}$ , and  $10^{-9}$  per year are shown. The rather irregular shapes of the contours are mainly caused by the strong directional dependence of wall debris, associated with the new fragment and debris throw model. The location of external objects has to be compared with the  $10^{-5}$  and  $10^{-6}$  contour, depending on existing or new situations respectively.

Figure 9 compares Risk-NL v5.0 with Risk-NL v4.1 for the  $10^{-5}$  per year contour. On average the distance from both contours to the storage site is comparable. Local differences are caused by the new fragment and debris throw model.

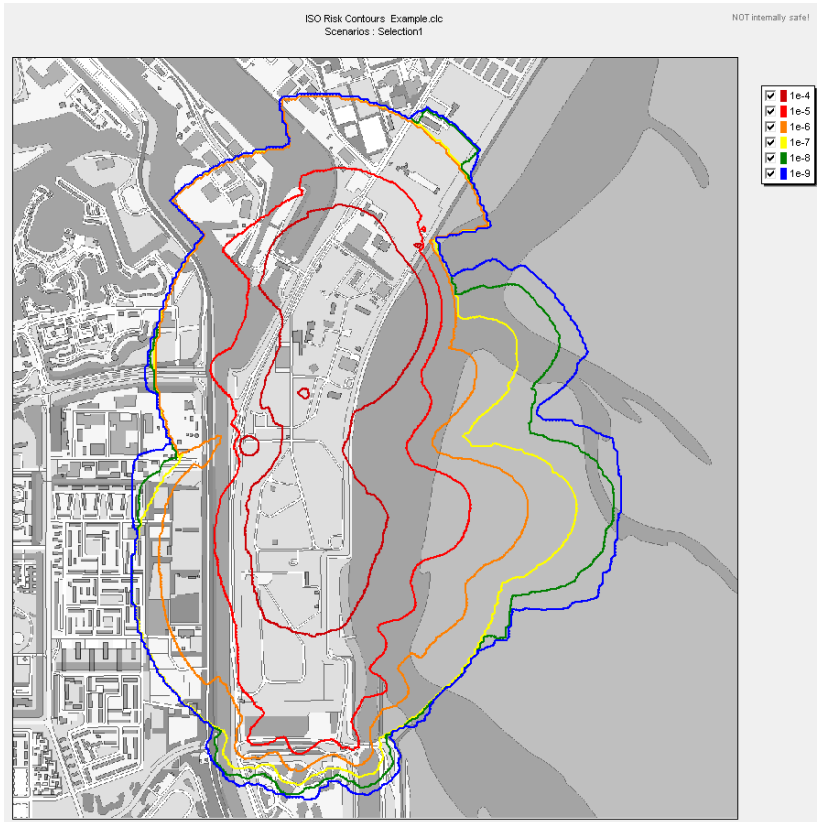


Figure 8. Risk contours for the Individual Risk (1/year) for various values.

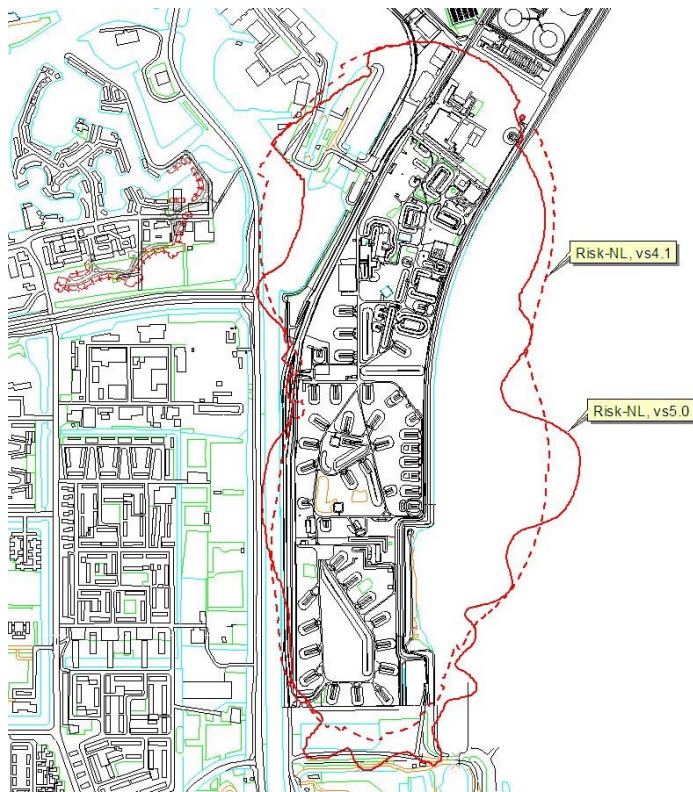
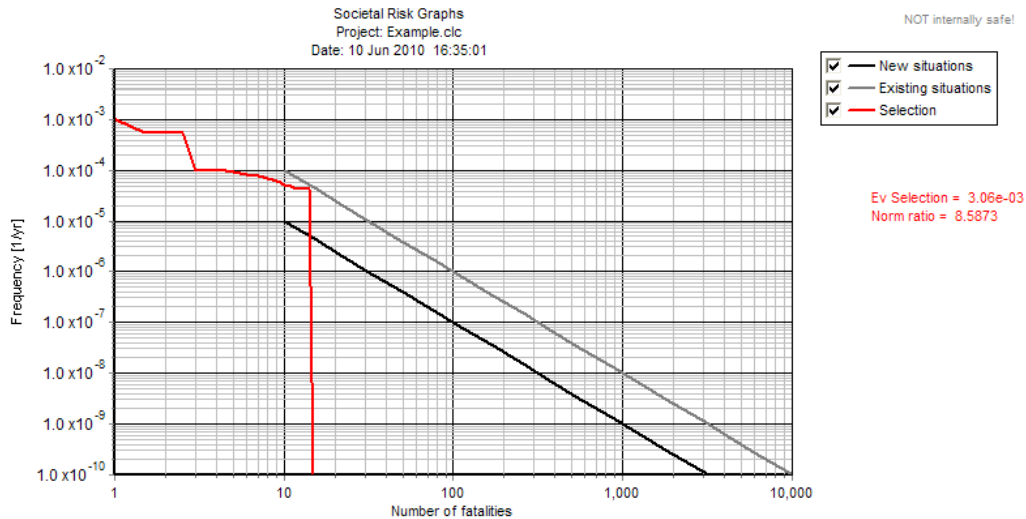


Figure 9. Risk contours for the Individual Risk (1/year)  $10^{-5}$  contour. Comparison between Risk-NL v5.0 and Risk-NL v4.1.

Figure 10 shows the FN-curve together with the criteria for existing and new situations. The FN-curve just satisfies the criterion for existing situations.



**Figure 10.** *Societal Risk, represented by the FN curve. The numbers of fatalities are the combined numbers of people inside buildings, on roads and in the 'free field'.*

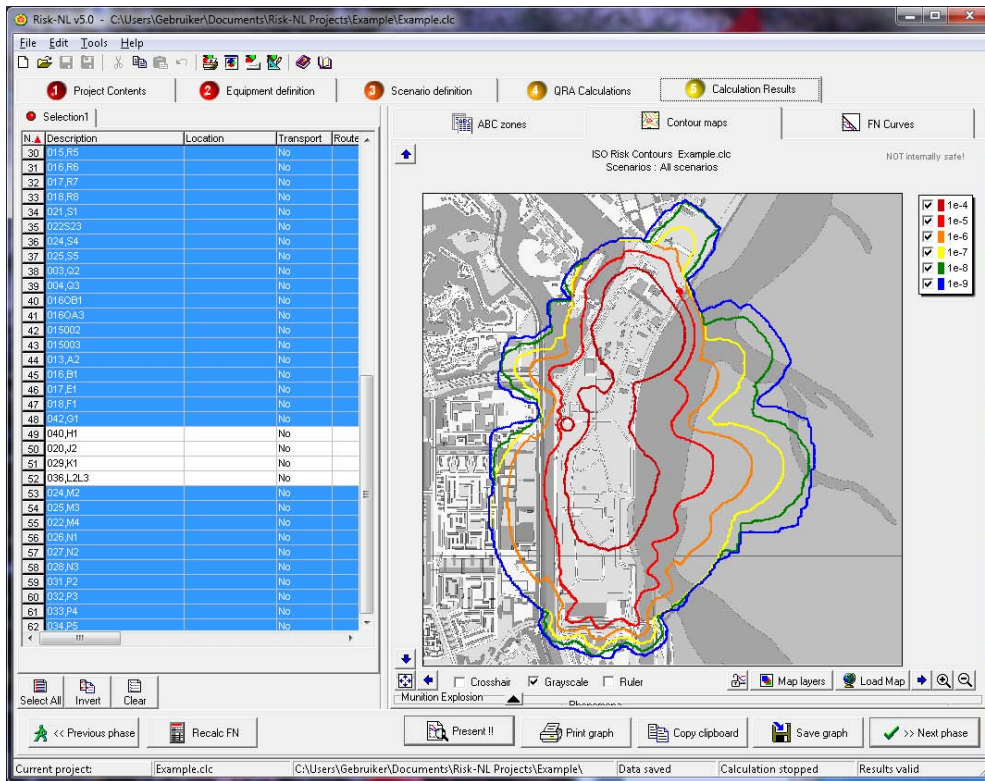
When situations change, e.g. when there are building plans or there is an increase of population or traffic somewhere near the site, or when changes in types or quantities of stored ammunition or explosives are considered, there may be a danger of exceeding the allowed risk limits. In such cases, a detailed study of which storage buildings and which mechanisms make the most significant contributions to the risks is worthwhile, so that cost effective measures can be taken to reduce the risks.

Risk-NL provides extensive functionality for a detailed analysis of the causes of exceedance of risk levels at certain locations, and of the contributions of individual storage buildings to the Individual Risk as well as the Societal Risk.

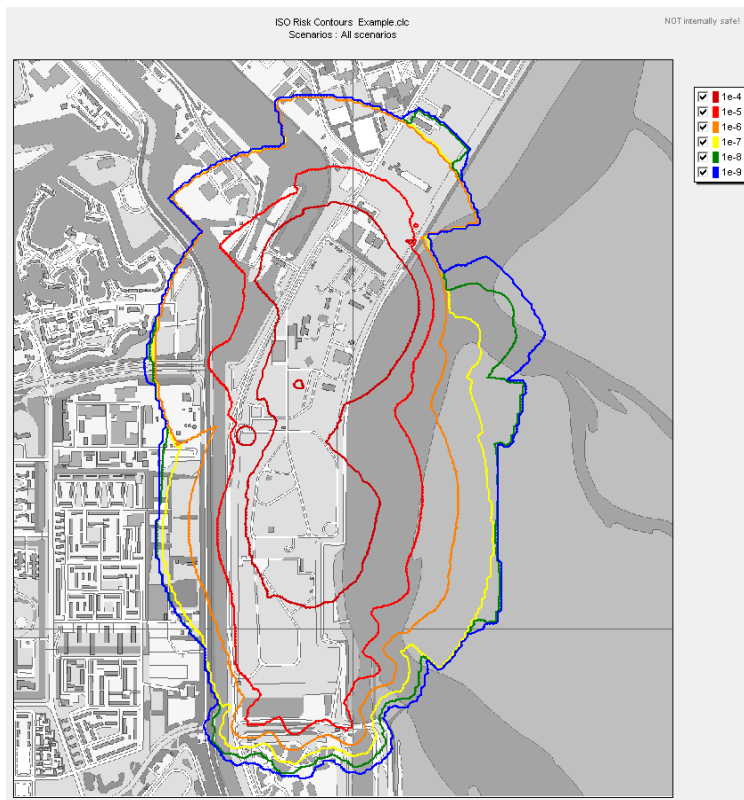
Two examples are discussed below:

1. Reduction of the quantity of stored ammunition. Figure 11 shows the effect of removing four storage buildings from the storage site. The result can be compared to Figure 8. A significant reduction of the Individual Risk can be observed at the north and west sides of the storage site. The stored ammunition can of course also be reduced continuously.
2. Adding barricades to storage buildings. Figure 12 shows the effect of adding barricades to a selected set of storage buildings in the southern part of the site. Compared to Figure 8 the Individual Risk is significantly reduced in the southern-west part of the map. Besides the addition of barricades also other structural measures can be taken into account like increasing wall thicknesses or building dimensions, or adding earth cover.

The various risk reducing measures can be accounted for easily and quickly.

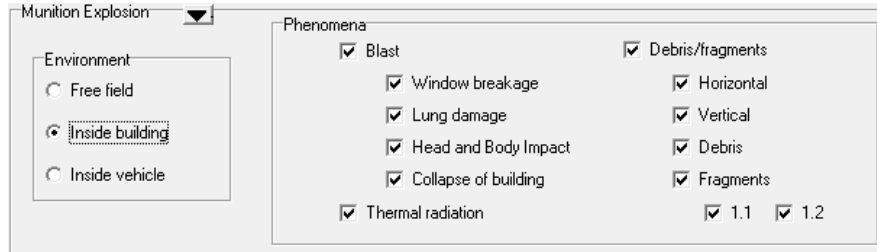


**Figure 11.** Risk contours for the Individual Risk (1/year) for various values. The effect of leaving out certain storage buildings.



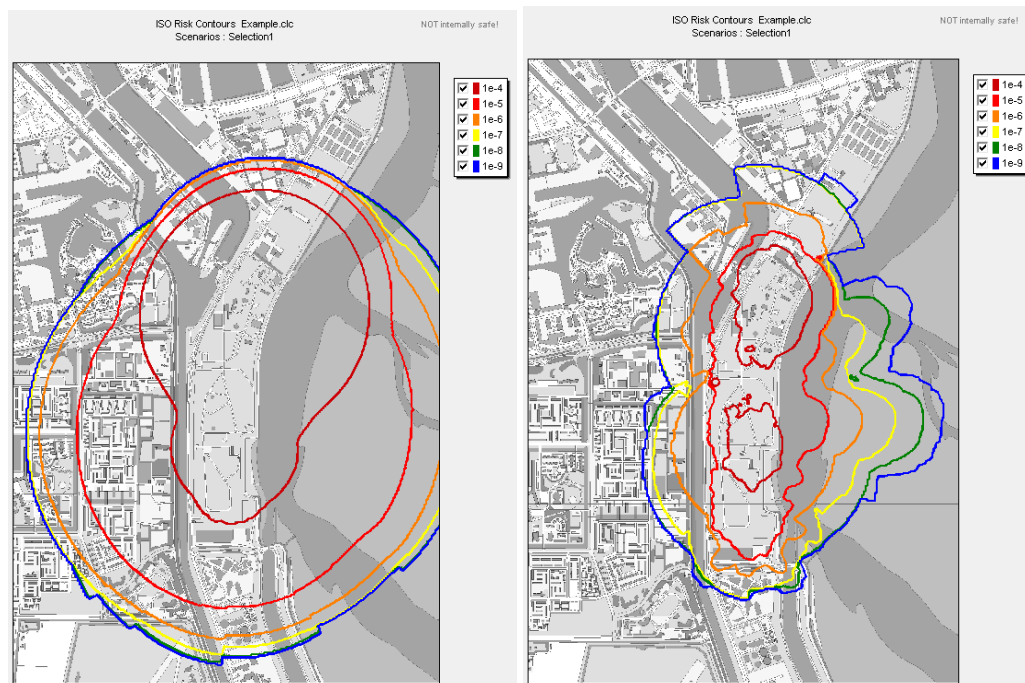
**Figure 12.** Risk contours for the Individual Risk (1/year) for various values. The effect of adding barricades to a number of storage buildings.

Another approach to reduce the risk, is to look more specifically at the risks to people in the free field, in vehicles and in buildings to find out which risk reducing measures could be useful at the acceptor locations. Using Risk-NL it is easy to distinguish between the risks from blast, thermal radiation, debris and fragments and see whether risks are higher to people inside or outside buildings or vehicles.



**Figure 13.** Possibility to choose which phenomena and which type of acceptors should be taken into account. ‘Window breakage’ and ‘Collapse of building’ are only available for the ‘Inside building’ situation.

Figure 13 shows the possibilities to choose which phenomena and which type of acceptors should be taken into account. Figure 14 shows the risks for people inside buildings. Note that the risk for persons inside buildings influences the Societal Risk, but not the Individual Risk.



**Figure 14.** Risk for persons inside buildings. Left (a): including window breakage; Right (b): window breakage excluded.

Compared to Figure 8, it illustrates clearly that the probability of fatalities due to blast effects reaches a greater distance than the debris and fragment effects in the free field. Comparison between Figure 14a and Figure 14b shows that the difference is entirely due to the relatively long range effect of window breakage.



## 6. Conclusions

An upgrade of Risk-NL v4.1 to Risk-NL v5.0 has been carried out which involved the implementation of a large number of improved models, and the combination of Risk-NL with RiskCurves.

The new models implemented in Risk-NL v5.0 are more physics-based, and have a higher level of detail. The most important example is the possibility to distinguish between wall and roof debris and between debris and fragments. The combination of the new models in Risk-NL v5.0 and RiskCurves give unique possibilities to analyse risk, and to investigate options for risk reduction. Risk-NL v5.0 also provides possibilities for optimization in the design of new types of magazines and magazine complexes.

Risk-NL v5.0 has been illustrated with a case study. The results showed that the Individual Risk contours locally differ from those calculated with Risk-NL v4.1. The differences can be explained well by the improved models. Often the differences are caused by the directionality of debris throw. The new window failure model in Risk-NL v5.0 has a significant influence on the Societal Risk.

## 7. References

Van Doormaal, 2010

Ans van Doormaal, Martijn van der Voort, *Methodology to determine probits for glazing failure and hazard*. 34th DDESB Explosives Safety Seminar 2010.

Van der Voort, 2010-1

Martijn van der Voort, Peter Kummer, Rolf van Wees, Philip van Dongen. *A consequence analysis method for Out of Area field storage*, 34th DDESB Explosives Safety Seminar 2010.

Van der Voort, 2010-2

Martijn van der Voort, Yoeng Sin Khoe, Wim van der Sluijs, Clarel Smit, *Development of a cost-benefit analysis method for compound protection and survivability*, European Survivability Workshop 2010, Aalesund, Norway.

Sterkenburg, 2009

Sterkenburg, R.P. *User manual Risk-NLv5.0*. TNO-B&O 2009

TNO Safety software, RISKCURVES, Version 7, *User and reference manual*, <http://www.tno.nl/riskcurves>, 2008

TP 16, 2009

Technical Paper 16, rev 3, *METHODOLOGIES FOR CALCULATING PRIMARY FRAGMENT CHARACTERISTICS*, Department of Defense Explosives Safety Board, 2009.

Van der Voort, 2009-1

Martijn van der Voort, Ruud van Amelsfort, Rolf van Wees, Ans van Doormaal, *A description of Risk-NL v5.0*, TNO-DV 2009 A315, December 2009, Restricted.

AASTP-4, 2008

*Allied Ammunition Storage and Transport Publication 4 (AASTP-4). Part II "Explosive Safety Risk Analysis"*, Draft Edition 2. AC/326(CHE)(SG6)IWP 072-08, 22 August 2008.

Van der Voort, 2008-1

M.M. van der Voort, J.C.A.M. van Doormaal, E.K. Verolme, J. Weerheijm, *A universal throw model and its applications*. Int J Impact Eng 35 (2008) 109-118, doi:10.1016/j.ijimpeng.2007.01.004.

Van der Voort, 2008-2

Voort, Martijn van der, Verolme, Ellen, Weerheijm, Jaap (2008). *The application of debris and fragment throw models in risk assessment methodologies*. Presented at the DDESB seminar 2008

AASTP-5, 2007

AASTP-5 EDITION 1 - NATO GUIDELINES FOR THE STORAGE, MAINTENANCE AND TRANSPORT OF AMMUNITION ON DEPLOYED MISSIONS OR OPERATIONS, 2007.

MP 40-21, 2006

MP 40-21, *Voorschrift opslag en behandeling gevaarlijke stoffen Defensie*, Ministerie van Defensie, 's Gravenhage, 2006.

Verolme, 2006

AC326/SG5-SG6 NLD IWP 01-2006, *Prediction models for small quantities net explosive Weight*, Verolme, Dr. E.K., Van der Voort, M.M., Van Doormaal, J.C.A.M., van Wees, R.M.M., Wentzel, C.M.

AASTP-1, 2006

*Manual of NATO safety principles for the storage of military ammunition and explosives*, AASTP-1, Change 2, Brussel, May 2006.

Swisdak, 2002

Michael M. Swisdak, Michael J. A. Gould, Jonathan Henderson, *Proposed Inhabited Building Distances based on debris for above ground structures*, Presented at the DDESB seminar 2002.

Gould, 1998

Gould, M. J. A. and Swisdak, M. M., *Procedures For the Collection, Analysis and Interpretation of Explosion-Produced Debris*, Presented at the DDESB seminar 1998.

PGS 1-2A, 2003

*Effecten van explosie op personen, 'Green book'*. Publication Series on Dangerous Goods (PGS 1-2A). Published by the Dutch Ministry of Housing Spatial Planning and the Environment (VROM), December 2003.

PGS 3, 2005

*Guidelines for quantitative risk assessment, 'Purple Book'*, Publication Series on Dangerous Goods (PGS 3). Published by the Dutch Ministry of Housing Spatial Planning and the Environment (VROM).

*Handreiking verantwoordingsplicht groepsrisico, versie 1.0*. Published by the Dutch Ministry of Housing Spatial Planning and the Environment (VROM), November 2007.

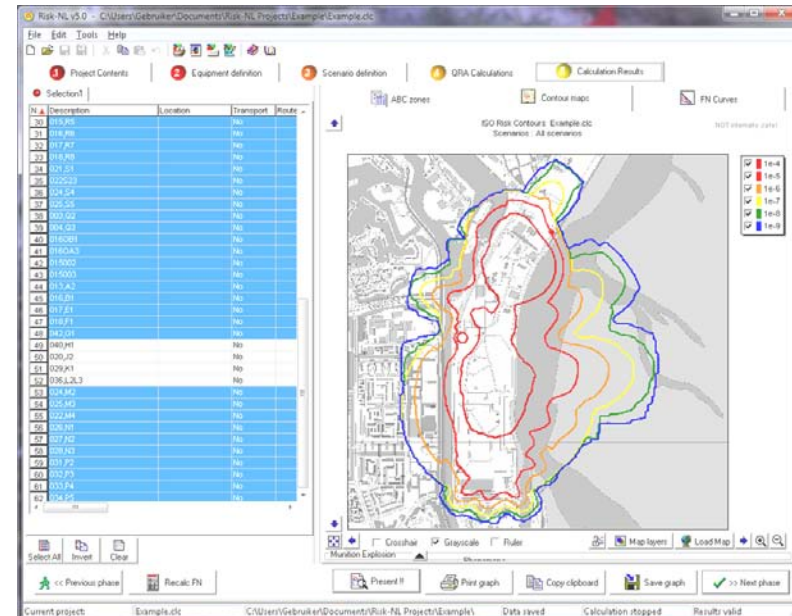
# THE DEVELOPMENTS OF RISK-NL V5.0 AND ITS APPLICATIONS

*DDESB seminar  
July 14, Portland (Oregon)*

**TNO | Defence, Security and Safety**




Martijn van der Voort  
Reinier Sterkenburg



# Contents

- Introduction
- Internal Safety
- ABC Zoning
- Quantitative Risk Assessment (QRA)
  - Individual Risk
  - Societal Risk
- Case study
- Conclusions

# Introduction

- Risk-NL
  - Quantitative Risk Assessment (QRA) software tool
  - External safety of the storage of explosives and ammunition
  - About 50 NLD storage sites analysed between 2001-2007
- Upgrade Risk-NL
  - Project sponsored by NLD MoD
  - Risk-NL v4.1  Risk-NL v5.0
  - Improved models
  - New user-interface
- Risk-NL performs three sequential steps
  - Internal Safety
  - ABC Zoning
  - QRA calculations
    - Individual Risk
    - Societal Risk

# Internal Safety

- Analysis of the Internal Safety
  - Exclusion of sympathetic detonation
  - NLD regulations: MP40-21
    - 11 magazine types
- New option:
  - According to adjusted AASTP-1
  - 33 magazine types

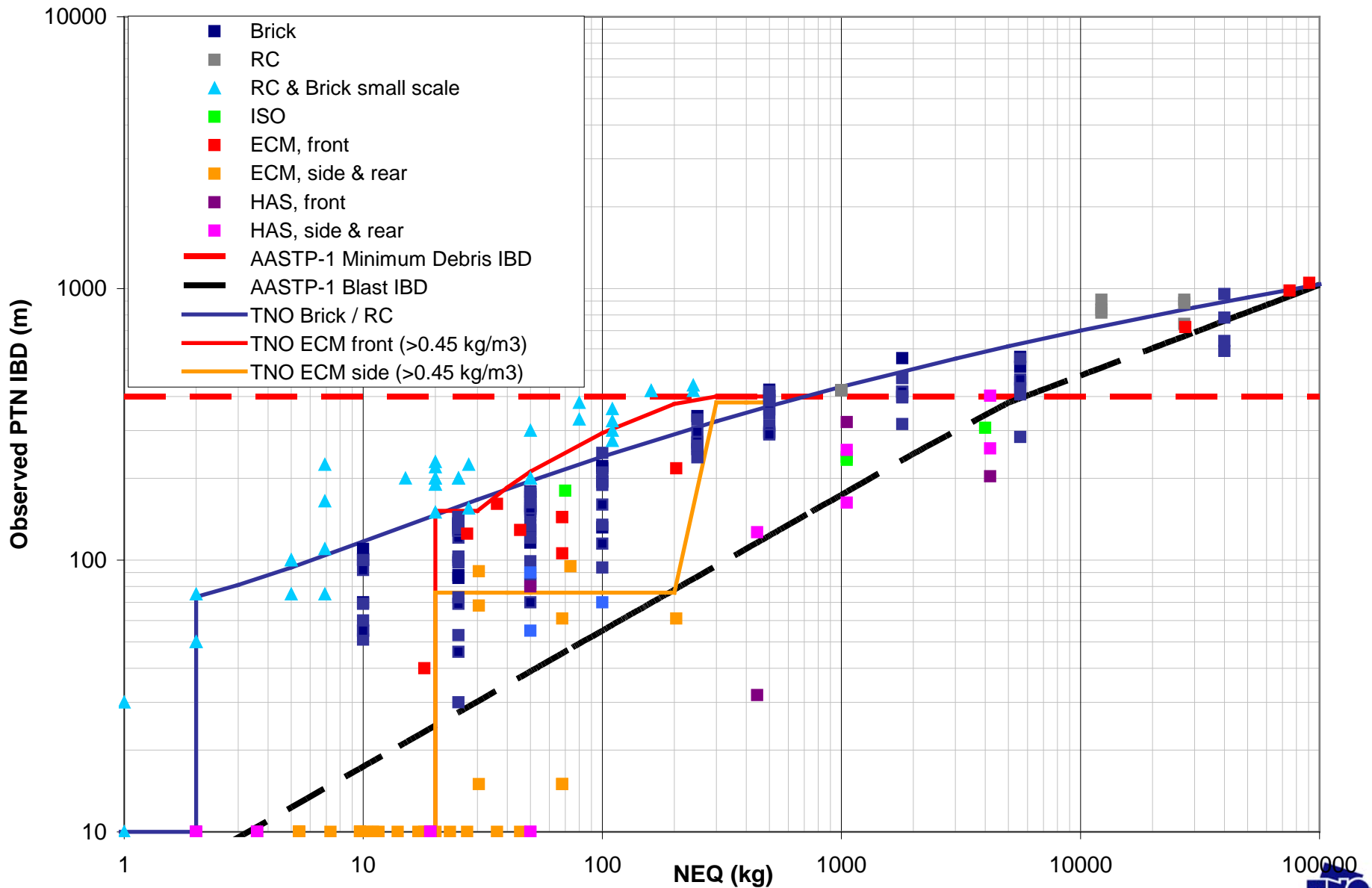
Voorschrift opslag gevaarlijke stoffen MP 40-21  
 Bijlage 9. Veiligheidsafstanden op munitiecomplexen (8-97) B9 - 4

Veiligheidsafstanden voor munitie van de gevarenklasse 1.1

		DONOR, dat is het magazijn waarin het ongeval te weten brand en/of detonatie plaatsvindt							
ACCEPTOR, dat is het magazijn waarvan de inhoud is beschermd mits aan de daarnaast veiligheidsafstand is voldaan.		x	b/c <sup>(1)</sup>	x	x	b/c <sup>(1)</sup>	x	x	b/c <sup>(1)</sup>
		b/c <sup>(1)</sup>	b/c <sup>(1)</sup>	b/c <sup>(1)</sup>	b/c <sup>(1)</sup>	b	b/c <sup>(1)</sup>	b/c <sup>(1)</sup>	b/c <sup>(1)</sup>
		x	b/c <sup>(1)</sup>	x	x	b/c <sup>(1)</sup>	x	x	b/c <sup>(1)</sup>
		b/c <sup>(1)</sup>	b/c <sup>(1)</sup>	b/c <sup>(1)</sup>	b/c <sup>(1)</sup>	b	b/c <sup>(1)</sup>	b/c <sup>(1)</sup>	b/c <sup>(1)</sup>
		b/c <sup>(1)</sup>	b/c <sup>(1)</sup>	b/c <sup>(1)</sup>	b/c <sup>(1)</sup>	b/c <sup>(1)</sup>	c/x <sup>(2)</sup>	c/x <sup>(2)</sup>	b/c <sup>(1)</sup>
		x	b/c <sup>(1)</sup>	x	x	b/c <sup>(1)</sup>	x	x	b/c <sup>(1)</sup>
		b/c <sup>(1)</sup>	b/c <sup>(1)</sup>	b/c <sup>(1)</sup>	b/c <sup>(1)</sup>	b/c <sup>(1)</sup>	c/x <sup>(2)</sup>	c/x <sup>(2)</sup>	b/c <sup>(1)</sup>
		x	b/c <sup>(1)</sup>	x	x	b/c <sup>(1)</sup>	x	x	b/c <sup>(1)</sup>
		b	b	b	b	a	b	b	b
		x	b/c <sup>(1)</sup>	x	x	b/c <sup>(1)</sup>	x	x	b/c <sup>(1)</sup>
		x	b/c <sup>(1)</sup>	x	x	b/c <sup>(1)</sup>	x	x	b/c <sup>(1)</sup>
		b/c <sup>(1)</sup>	b/c <sup>(1)</sup>	b/c <sup>(1)</sup>	b/c <sup>(1)</sup>	b/c <sup>(1)</sup>	c/x <sup>(2)</sup>	c/x <sup>(2)</sup>	b/c <sup>(1)</sup>

# ABC Zoning

## Implementation of QDs for Small Quantities



# Quantitative Risk Assessment (QRA)

- The basis of the QRA calculations is the risk equation:

$$Risk = P_{event} \cdot P_{lethal} \cdot P_{exposure} \quad (1/year)$$

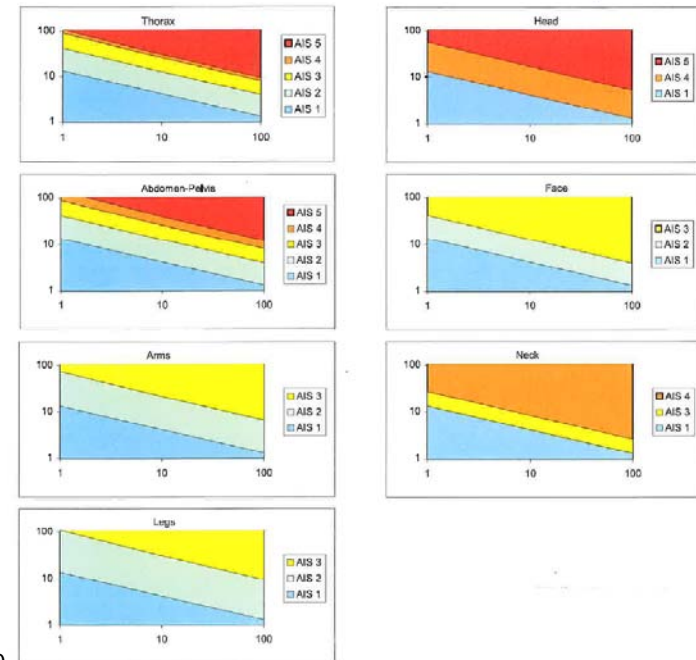
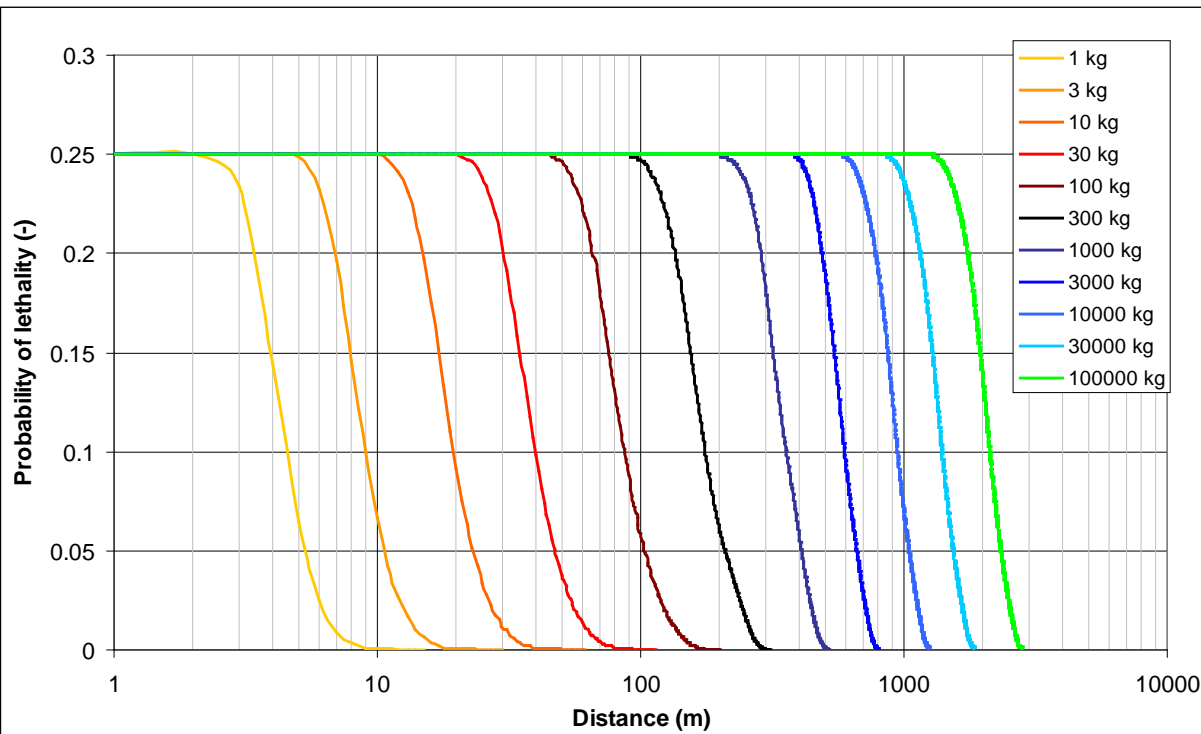
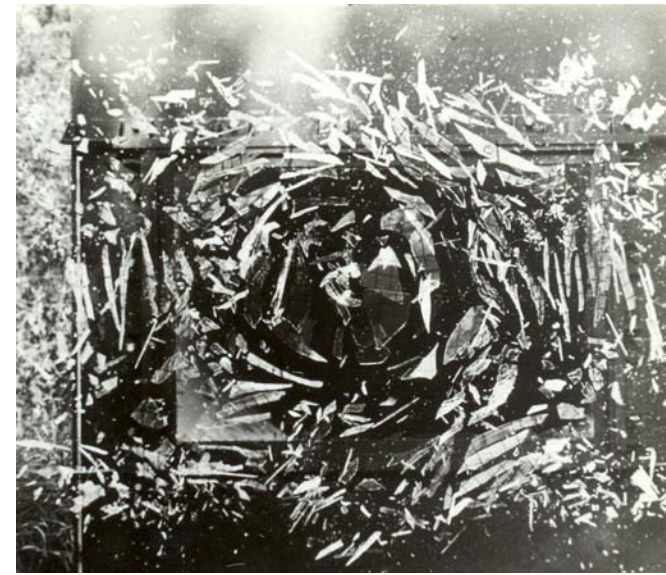
- Assumptions
  - One scenario per PES
  - Maximum Credible Event (MCE)
  - Mixing and Aggregation rules from AASTP-1
  - No escape behaviour
- The event frequency (1/year)
  - Based on accident data 1960-1980
  - Regular storage, irregular storage, storage in vehicles
- The probability of lethality given the event (-)
  - See next slides
- The probability of exposure (-)
  - Individual risk (100 % exposure, unprotected)
  - Societal risk (more realistic measure)



Explosion effect	Hazard division	Explosion effect relevant IF	Lethality mechanism	Relevant for persons in		
				Free Field (FF)	Building (HS)	Vehicle (RD)
<b>Blast</b>	HD1.1		Lung rupture	YES, Side-on blast load plus dynamic pressure (blast wind)		
			Head and body impact	YES, Dynamic pressure (blast wind)		
			Window failure	NO	YES, Reflected blast load	NO
			Building collapse	NO	YES, Based on Side-on blast load	NO
<b>Fragments Horizontal</b>	HD1.1	Cased AND No Barricade	Penetration	YES	YES, after penetration of 230 mm concrete/ 300 mm brick or window pane	YES, after penetration of 2 mm mild steel or window pane
	HD1.2	Cased AND No Barricade	Penetration			
<b>Fragments Vertical</b>	HD1.1	Cased	Penetration			
	HD1.2	Cased	Penetration			
<b>Debris Horizontal</b>	HD1.1	No Barricade	Penetration			
			Blunt body			
<b>Debris Vertical</b>	HD1.1		Penetration			
			Blunt body			
<b>Thermal</b>	HD1.3		Skin burn	YES	YES, Reduction of thermal radiation by factor 2	YES, Reduction of thermal radiation by factor 2

# Window failure

- New window failure model (Doormaal)
  - Based on representative NLD windows
  - Double and single glazing
  - AIS (Abbreviated Injury Score) prediction
  - New probit function for lethality



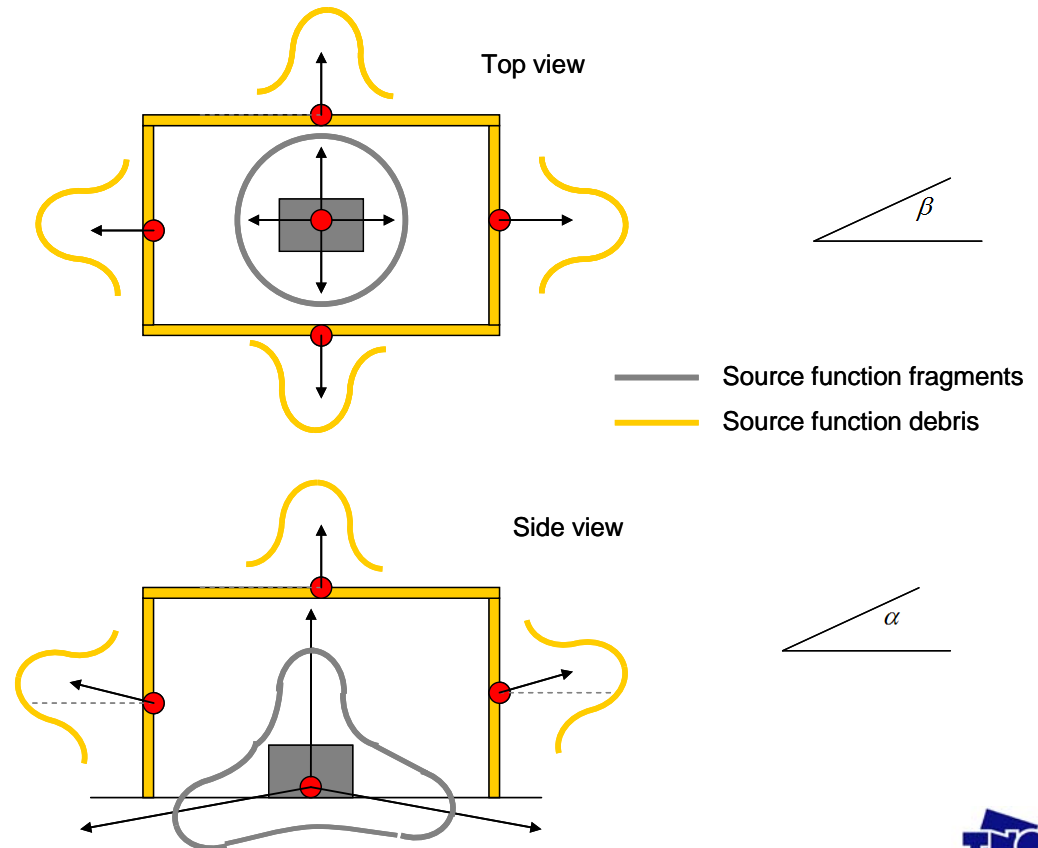
# Debris and fragment throw

- New debris and fragment throw model distinguishes between
  - Wall and roof debris  *Barricades*

- Debris and (primary) fragments  *Bare vs. Cased*

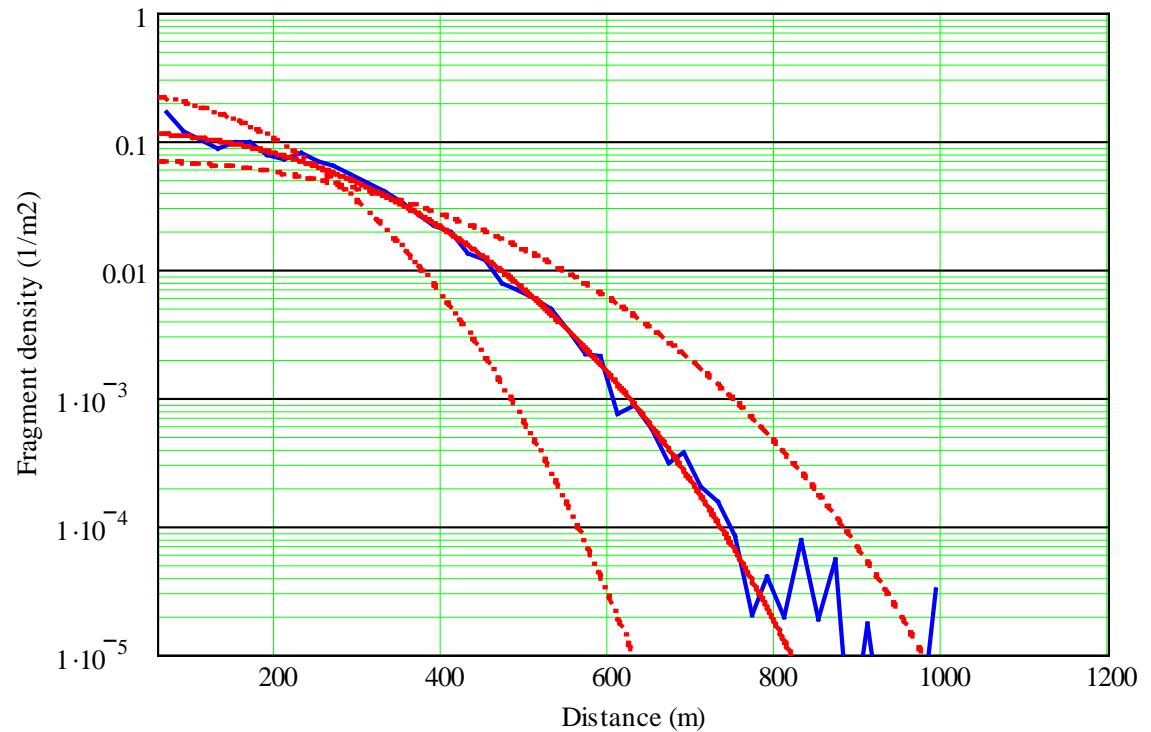
- Distributions of:
  - Mass (10 bins)
  - Velocity
  - Angle

- Trajectory calculations
  - Analytical approach
  - Penetration relations
  - Number of hits
  - Lethality prediction



# Debris and fragment throw

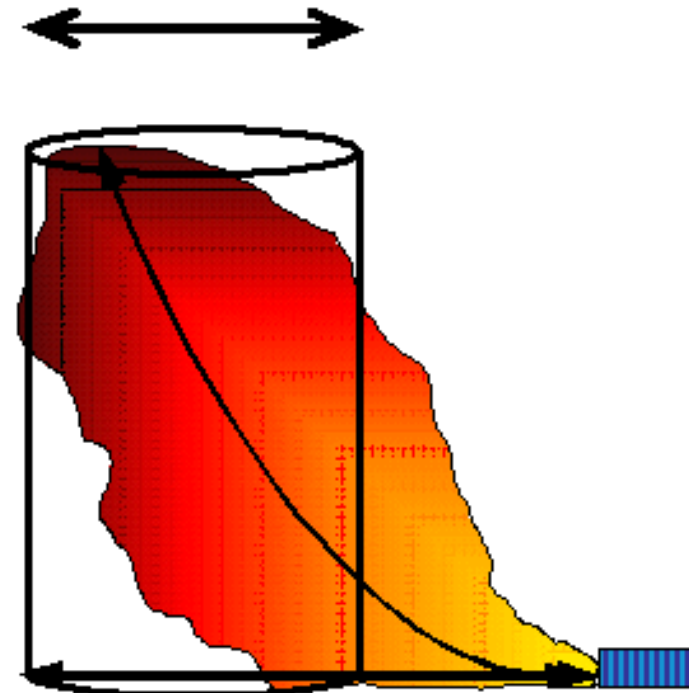
- Validation against large number of trials
  - Example: 5 tonnes trial



- 5 tonnes trial
- sim 4.8 deg
- sim 6.8 deg
- - - - sim 8.8 deg

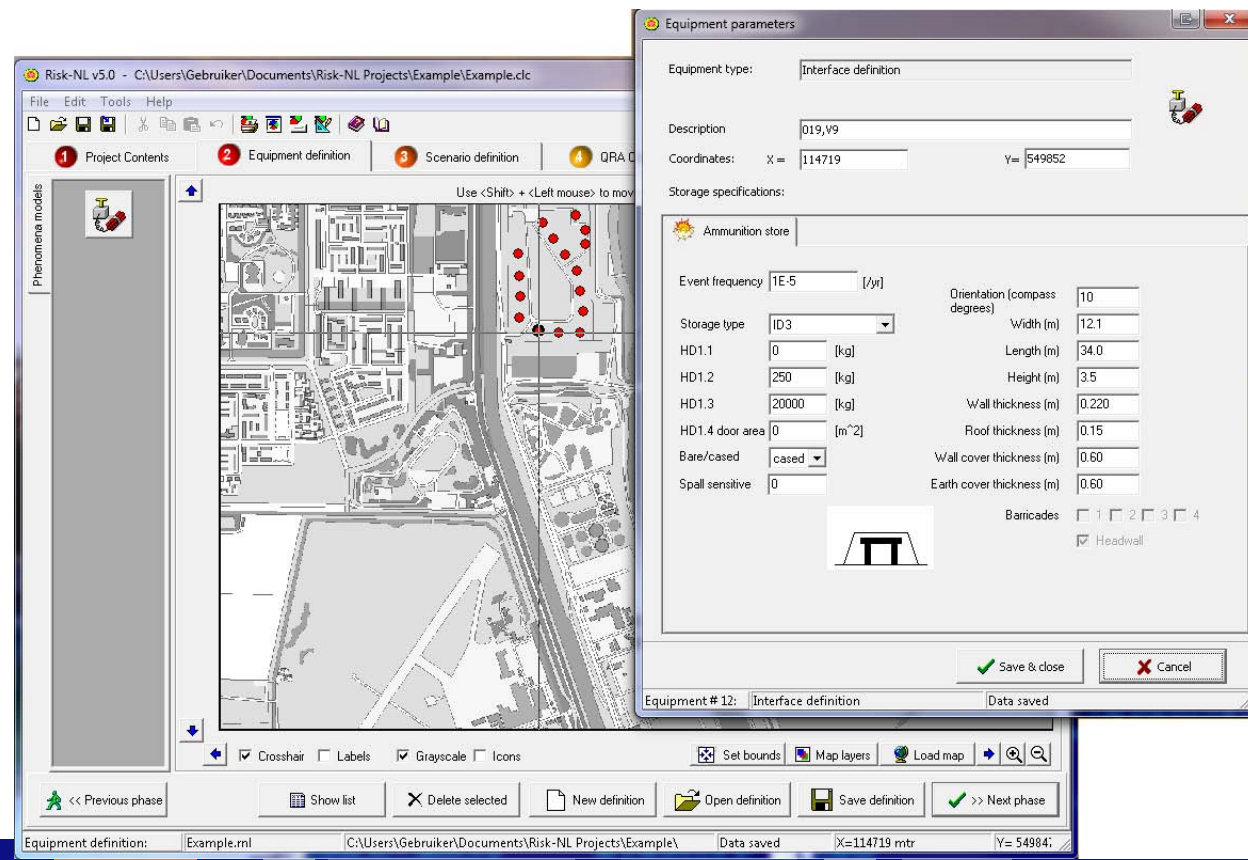
# Thermal radiation

- HD1.3 event; mass fire
- Risk-NL v5.0:
- Nieuw model with distinction between
  - Light structures: fire ball
  - Heavy structures: flame jet through doors/openings
- Fire ball
  - Model for fire ball radius and duration
  - Model for irradiance
- Flam jet
  - Model for flame jet length and duration
  - Model for radiation irradiance



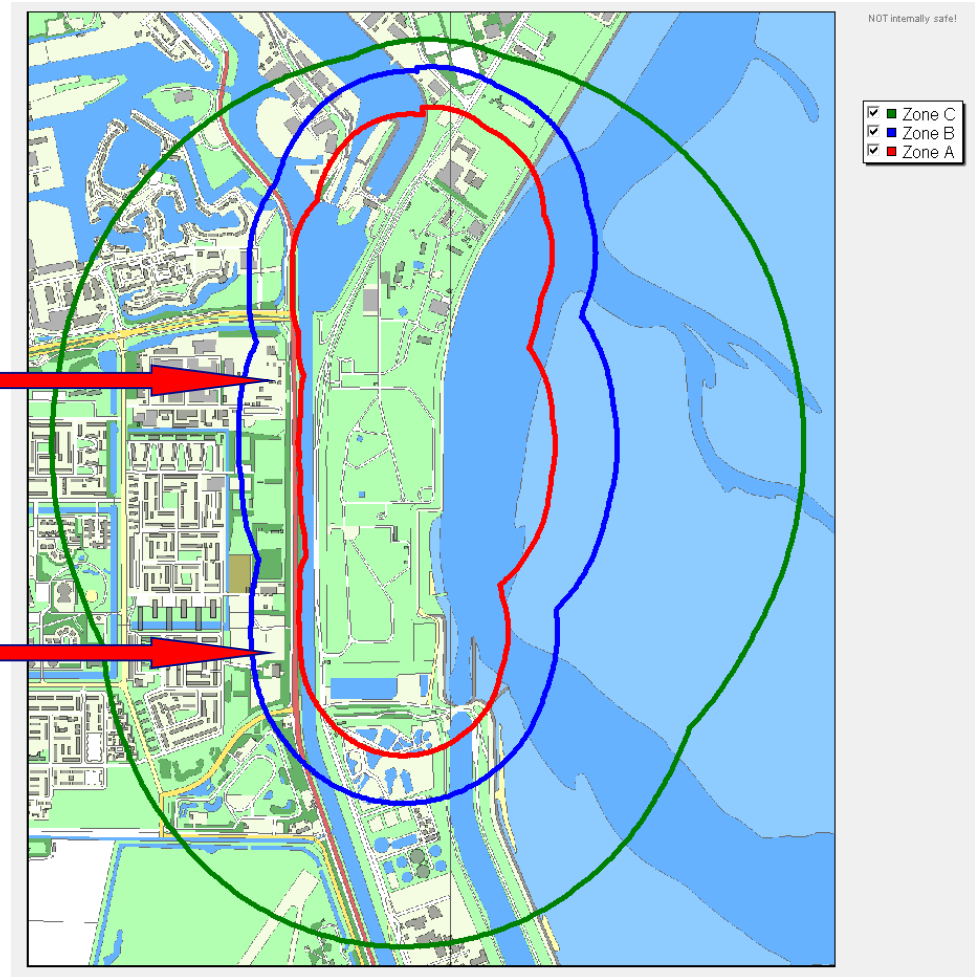
# Case study

- Fictitious storage site
- Selection of:
  - Background map
  - Population grid / population concentrations (day/night/temporarily)
  - Traffic data
  - Storage buildings



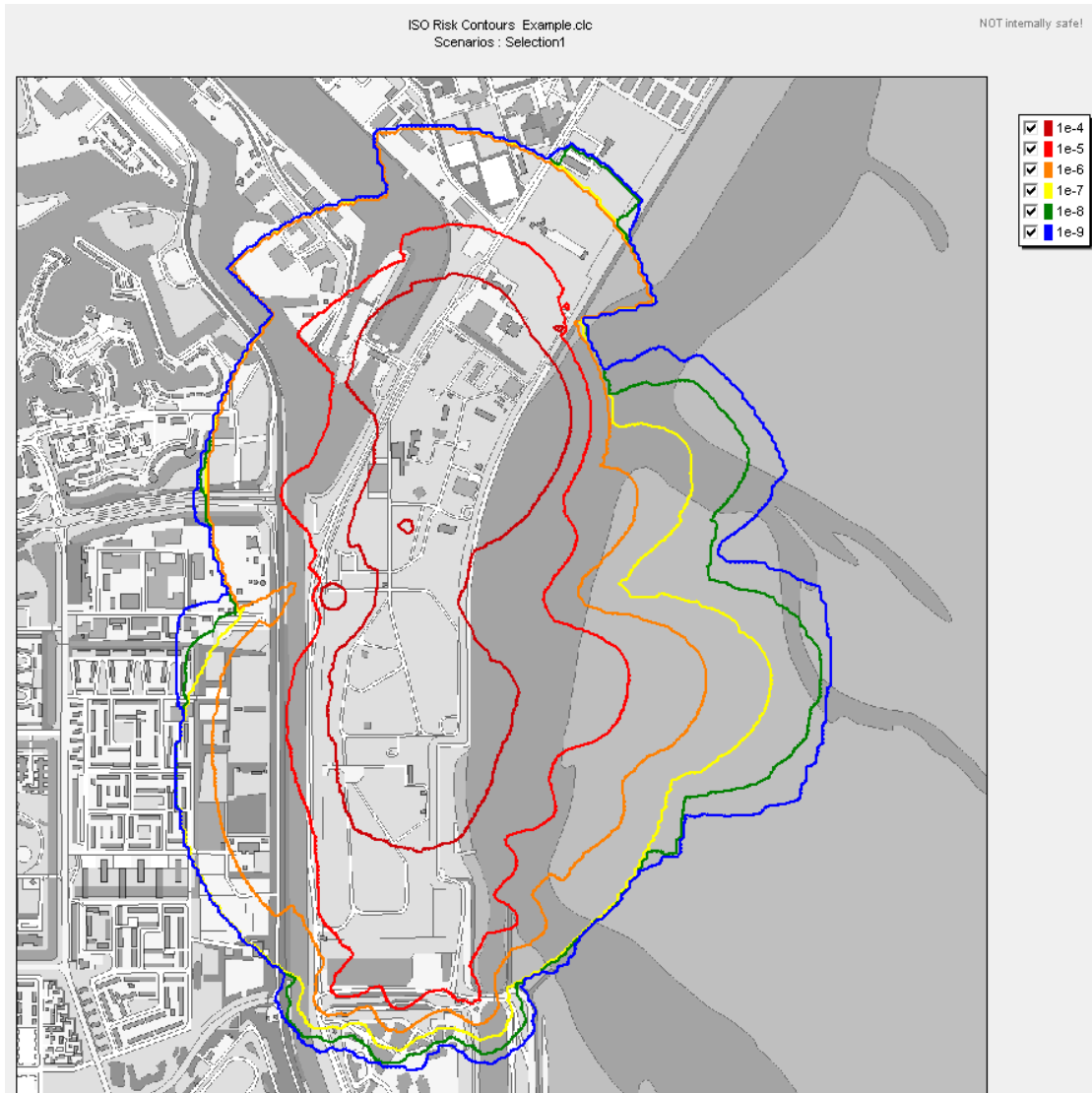
# Case study

- Internally Safe (Y/N)
  - Displayed on maps and charts
  - Changes may be required
- ABC Zoning
  - Union of individual zones
- Comparison with regulations
  - Objects within zones
  - QRA is required !



# Case study

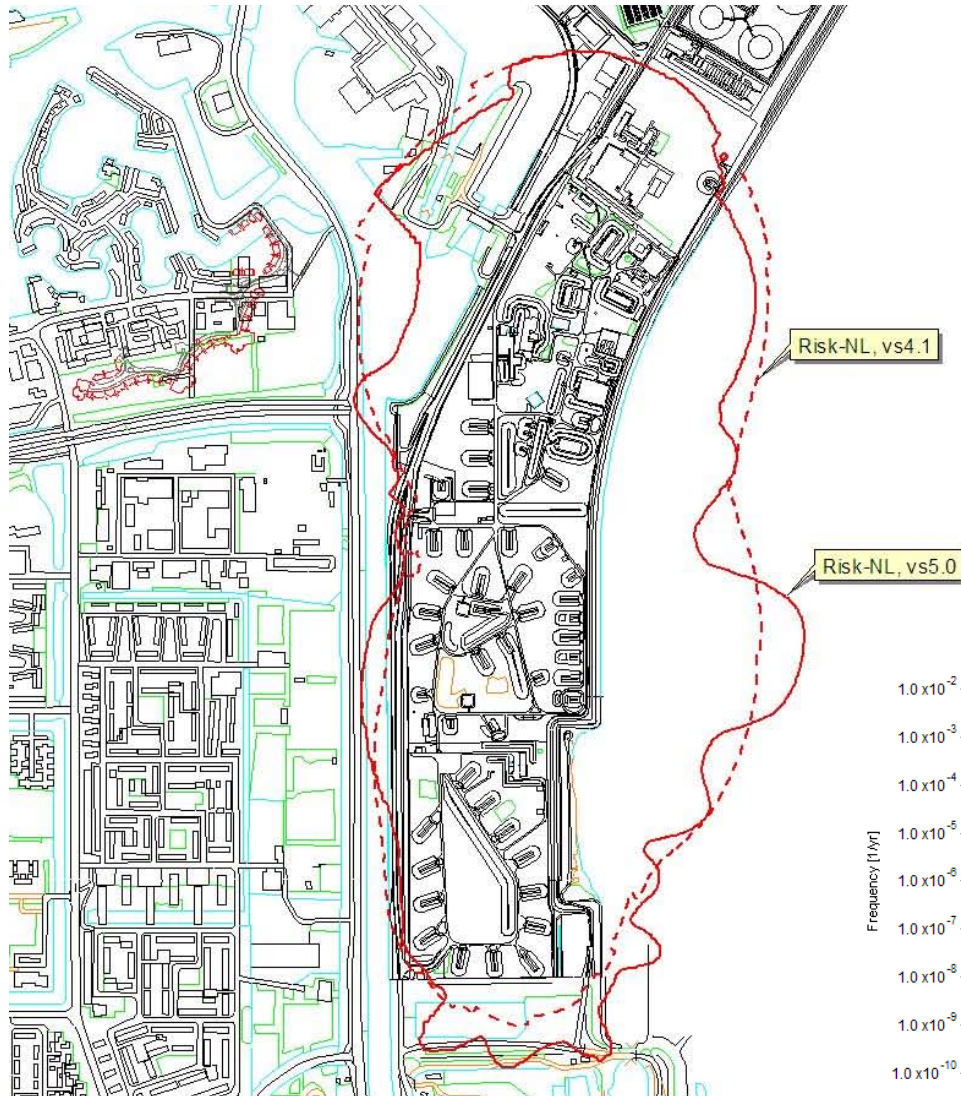
- Individual Risk
  - Contours for  $10^{-4}$ ,  $10^{-5}$ ,  $10^{-6}$ ,  $10^{-7}$ ,  $10^{-8}$ , and  $10^{-9}$



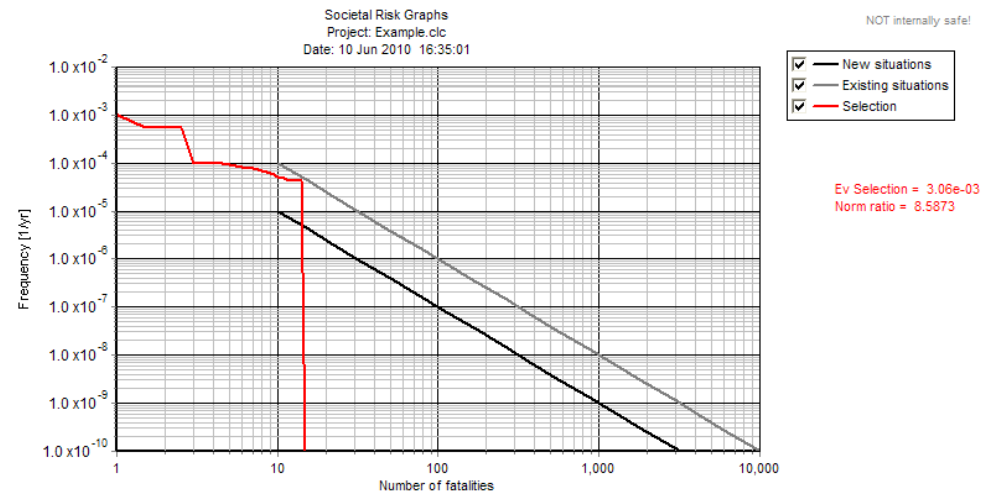


# Case study

- Individual Risk
  - Comparison between Risk-NL v4.1 and Risk-NL v5.0

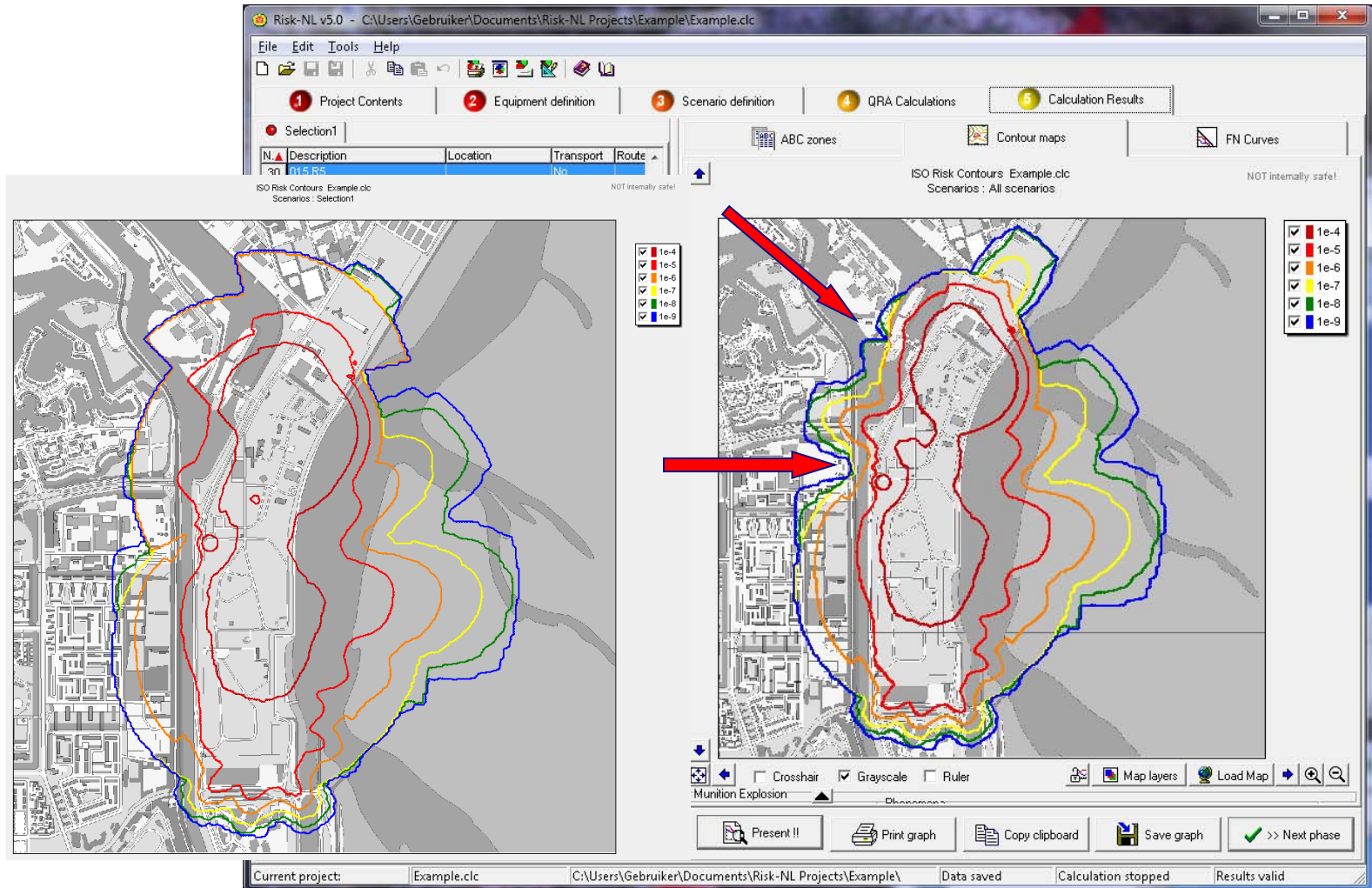


- Societal Risk
  - F/N Curve



# Case study

- Risk Reduction
  - Leaving storage buildings empty
  - Reducing the NEQ

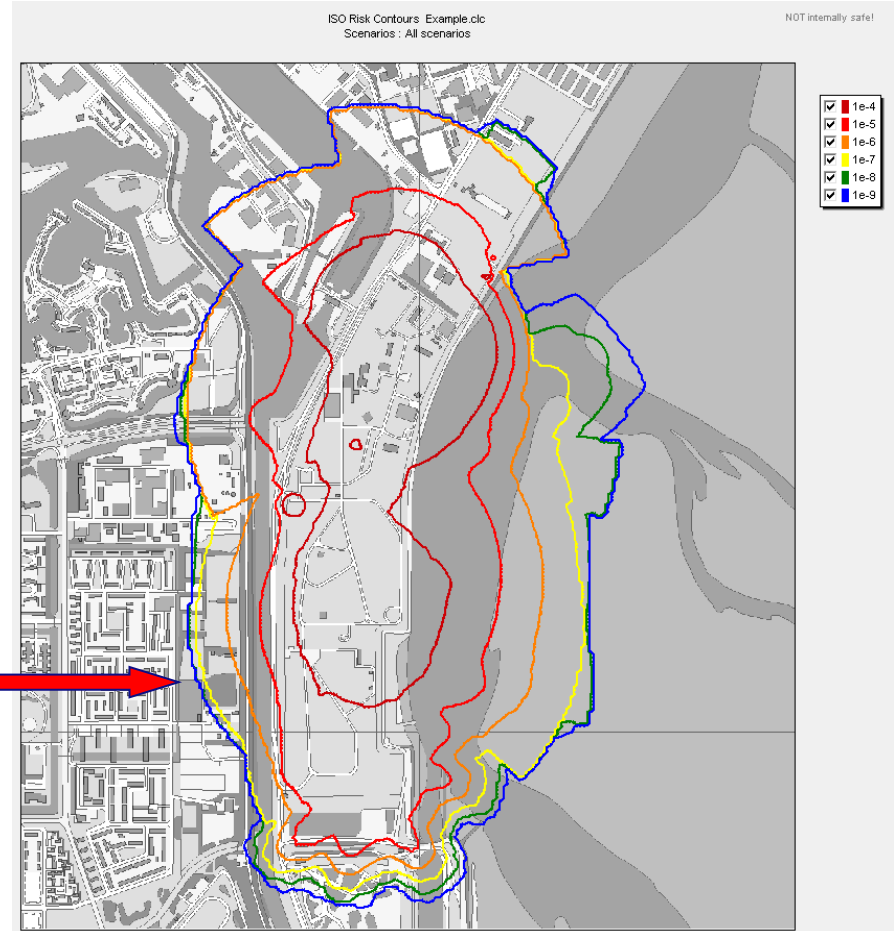


# Case study

- Risk Reduction
  - Adding barricades to a number of storage buildings (south)



Without barricades



With barricades

# Case study

- Individual Risk Contours

Munition Explosion

Environment

- Free field
- Inside building
- Inside vehicle

Phenomena

- Blast
  - Window breakage
  - Lung damage
  - Displacement
  - Collapse of building
- Heat radiation
- Debris/fragments
  - Horizontal
  - Vertical
  - Debris
  - Fragments
    - 1.1
    - 1.2

- Risk contours for persons in buildings (or vehicles)

Munition Explosion

Environment

- Free field
- Inside building
- Inside vehicle

Phenomena

- Blast
  - Window breakage
  - Lung damage
  - Head and Body Impact
  - Collapse of building
- Thermal radiation
- Debris/fragments
  - Horizontal
  - Vertical
  - Debris
  - Fragments
    - 1.1
    - 1.2

- Or: User defined selection of lethality mechanisms

# Case study

- Risk contours for persons in buildings
  - Without window failure (left)
  - With window failure (right)

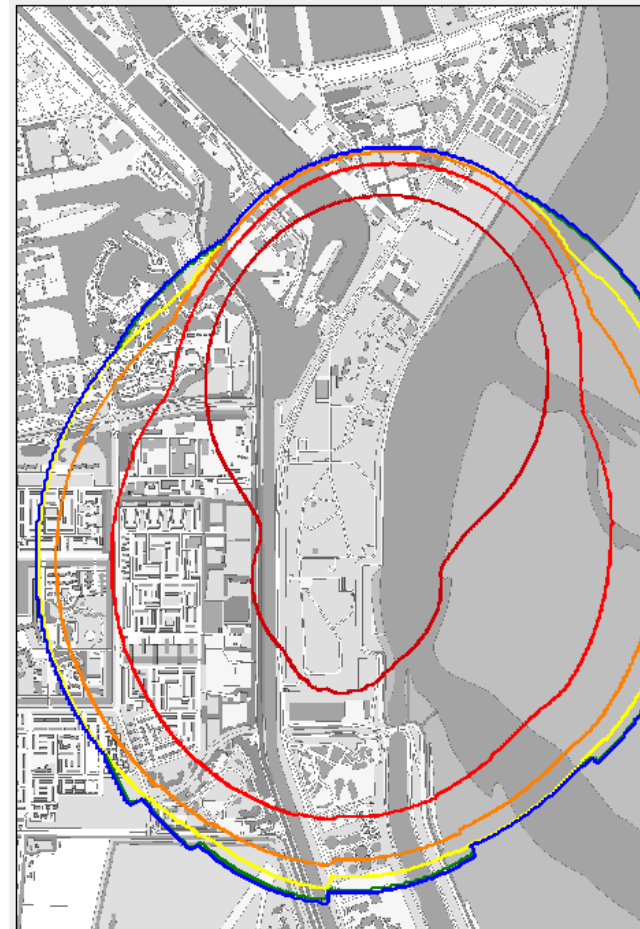
ISO Risk Contours Example.clc  
Scenarios : Selection1

NOT internally safe!



ISO Risk Contours Example.clc  
Scenarios : Selection1

NOT internally safe!



# Conclusions

- Upgrade of Risk-NL v4.1 to Risk-NL v5.0
  - Large number of improved models
    - More physics-based
    - Higher level of detail
  - Combination of Risk-NL with RiskCurves.
- New debris and fragment throw model distinguishes between:
  - Wall and roof debris
  - Debris and fragments
- New window failure model
- Differences between Risk-NL v5.0 and Risk-NL v4.1
  - Individual Risk (debris and fragment throw)
  - Societal Risk (window failure)
- Possibilities to
  - Analyse risk reduction
  - Optimise design of magazines and storage sites