

UFC 4-171-05  
1 January 2005  
Including Change 3, 1 February 2010

# **UNIFIED FACILITIES CRITERIA (UFC)**

## **ARMY RESERVE FACILITIES**



**APPROVED FOR PUBLIC RELEASE; DISTRIBUTION UNLIMITED**

# Report Documentation Page

Form Approved  
OMB No. 0704-0188

Public reporting burden for the collection of information is estimated to average 1 hour per response, including the time for reviewing instructions, searching existing data sources, gathering and maintaining the data needed, and completing and reviewing the collection of information. Send comments regarding this burden estimate or any other aspect of this collection of information, including suggestions for reducing this burden, to Washington Headquarters Services, Directorate for Information Operations and Reports, 1215 Jefferson Davis Highway, Suite 1204, Arlington VA 22202-4302. Respondents should be aware that notwithstanding any other provision of law, no person shall be subject to a penalty for failing to comply with a collection of information if it does not display a currently valid OMB control number.

1. REPORT DATE <b>01 FEB 2010</b>		2. REPORT TYPE		3. DATES COVERED <b>00-00-2010 to 00-00-2010</b>	
4. TITLE AND SUBTITLE <b>Unified Facilities Criteria (UFC) Design Guide. Army Reserve Facilities</b>				5a. CONTRACT NUMBER	
				5b. GRANT NUMBER	
				5c. PROGRAM ELEMENT NUMBER	
6. AUTHOR(S)				5d. PROJECT NUMBER	
				5e. TASK NUMBER	
				5f. WORK UNIT NUMBER	
7. PERFORMING ORGANIZATION NAME(S) AND ADDRESS(ES) <b>Department of Defense, Office of the Under Secretary of Defense for Installations and Equipment, Director, Installation Requirements and Manpower, Washington, DC</b>				8. PERFORMING ORGANIZATION REPORT NUMBER	
9. SPONSORING/MONITORING AGENCY NAME(S) AND ADDRESS(ES)				10. SPONSOR/MONITOR'S ACRONYM(S)	
				11. SPONSOR/MONITOR'S REPORT NUMBER(S)	
12. DISTRIBUTION/AVAILABILITY STATEMENT <b>Approved for public release; distribution unlimited</b>					
13. SUPPLEMENTARY NOTES					
14. ABSTRACT					
15. SUBJECT TERMS					
16. SECURITY CLASSIFICATION OF:			17. LIMITATION OF ABSTRACT <b>Same as Report (SAR)</b>	18. NUMBER OF PAGES <b>248</b>	19a. NAME OF RESPONSIBLE PERSON
a. REPORT <b>unclassified</b>	b. ABSTRACT <b>unclassified</b>	c. THIS PAGE <b>unclassified</b>			

**UNIFIED FACILITIES CRITERIA (UFC)**

**DESIGN GUIDE: ARMY RESERVE FACILITIES**

Any copyrighted material included in this UFC is identified at its point of use. Use of the copyrighted material apart from this UFC must have the permission of the copyright holder.

U.S. ARMY CORPS OF ENGINEERS (Preparing Activity)

NAVAL FACILITIES ENGINEERING COMMAND

AIR FORCE CIVIL ENGINEER SUPPORT AGENCY

Record of Changes (changes are indicated by \1\ ... /1/)

<b>Change No.</b>	<b>Date</b>	<b>Location</b>
<b>1</b>	1 Jan 2005	Multiple criteria and editorial adjustments
<b>2</b>	25 Oct 2006	Multiple criteria adjustments. Multiple unmarked formatting and editorial adjustments
<b>3</b>	1 Feb 2010	Multiple criteria adjustment. Multiple unmarked formatting and editorial adjustments.

Note: This 1 February 2010 edition of UFC 4-171-05 is the 25 October 2006 edition of UFC 4-171-05 with multiple marked criteria adjustments and unmarked editorial adjustments. Note change marks incorporated in this edition include changes from the 1 January 2005 edition.

---

**This UFC supersedes UFC 4-171-05, Design: Guide For Army Reserve Facilities dated 1 January 2005 and incorporates the above listed changes.**

## FOREWORD

The Unified Facilities Criteria (UFC) system is prescribed by MIL-STD 3007 and provides planning, design, construction, sustainment, restoration, and modernization criteria, and applies to the Military Departments, the Defense Agencies, and the DoD Field Activities in accordance with [USD\(AT&L\) Memorandum](#) dated 29 May 2002. UFC will be used for all DoD projects and work for other customers where appropriate.

UFC are living documents and will be periodically reviewed, updated, and made available to users as part of the Services' responsibility for providing technical criteria for military construction. Headquarters, U.S. Army Corps of Engineers (HQUSACE), Naval Facilities Engineering Command (NAVFAC), and Air Force Civil Engineer Support Agency (AFCESA) are responsible for administration of the UFC system. Defense agencies should contact the preparing service for document interpretation and improvements. Technical content of UFC is the responsibility of the cognizant DoD working group. Recommended changes with supporting rationale should be sent to the respective service proponent office by the following electronic form: [Criteria Change Request \(CCR\)](#). The form is also accessible from the Internet sites listed below.

UFC are effective upon issuance and are distributed only in electronic media from the following source:

- Whole Building Design Guide (WBDG) web site <http://dod.wbdg.org>.

Hard copies of UFC printed from electronic media should be checked against the current electronic version prior to use to ensure that they are current.

### AUTHORIZED BY:



DONALD L. BASHAM, P.E.  
Chief, Engineering and Construction  
U.S. Army Corps of Engineers

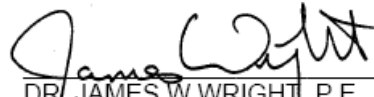

DR. JAMES W. WRIGHT, P.E.  
Chief Engineer  
Naval Facilities Engineering Command

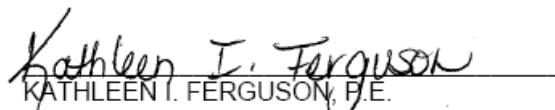

KATHLEEN I. FERGUSON, P.E.  
The Deputy Civil Engineer  
DCS/Installations & Logistics  
Department of the Air Force



DR. GET W. MOY, P.E.  
Director, Installations Requirements and  
Management  
Office of the Deputy Under Secretary of Defense  
(Installations and Environment)

## CONTENTS

	<u>Page</u>
<b>CHAPTER 1 INTRODUCTION AND GENERAL INFORMATION</b>	
1-1 PURPOSE OF THE DESIGN GUIDE .....	1
1-2 SCOPE OF THE DESIGN GUIDE .....	1
1-3 ARMY RESERVE CADD PLATFORM .....	2
1-4 FORMAT OF THE DESIGN GUIDE .....	3
1-5 PROJECT PARTICIPANT RESPONSIBILITIES .....	3
1-6 PURPOSE OF THE ARMY RESERVE .....	5
1-7 QUALITY OF DESIGN .....	6
1-8 PROJECT DELIVERY .....	7
1-9 PROGRAM SYNOPSIS .....	7
1-10 USAR PROJECT FUNDING .....	10
1-11 CONSTRUCTION CONTRACT AWARD .....	11
<b>CHAPTER 2 PLANNING GUIDELINES</b>	
2-1 INTRODUCTION .....	12
2-2 DESIGN AND REGULATORY CRITERIA AND THEIR APPLICATION	12
2-3 ENVIRONMENTAL .....	14
2-4 SITE SELECTION AND PLANNING .....	15
2-5 ANTITERRORISM/FORCE PROTECTION (AT/FP) .....	20
2-6 LANDSCAPE .....	21
2-7 BUILDINGS .....	22
2-8 FIRE PROTECTION/LIFE SAFETY .....	32
2-9 INTERIOR DESIGN .....	32
2-10 INFORMATION TECHNOLOGY .....	33
2-11 SIGNAGE .....	34
2-12 ACCESSIBILITY .....	35
2-13 SECURITY .....	35
<b>CHAPTER 3 GENERAL DESIGN CONSIDERATIONS</b>	
3-1 INTRODUCTION .....	36
3-2 CIVIL AND UTILITIES .....	36
3-3 LANDSCAPE ARCHITECTURE .....	47
3-4 FIRE PROTECTION / LIFE SAFETY .....	48
3-5 ARCHITECTURAL .....	50
3-6 INTERIOR DESIGN .....	55
3-7 STRUCTURAL .....	59
3-8 MECHANICAL .....	63
3-9 PLUMBING .....	66
3-10 ELECTRICAL .....	66
3-11 SPECIFICATIONS .....	76
3-12 COST ESTIMATING .....	78
3-13 ENERGY CONSERVATION .....	79
3-14 ANTITERRORISM FORCE PROTECTION .....	80
3-15 ACCESSIBILITY .....	81
3-16 ENVIRONMENTAL .....	81

## CONTENTS Continued

	<u>Page</u>
<b>CHAPTER 4</b>	<b>INDIVIDUAL SPACE CRITERIA</b>
4-1	GENERAL.....85
4-2	TRAINING CENTER BUILDING .....86
4-2.1	Full-time Offices .....86
4-2.2	Unit Exclusive Offices .....87
4-2.3	Unit Commons .....88
4-2.4	Recruiting/Retention Office .....89
4-2.5	Family Support Office .....90
4-2.6	Administrative Support.....91
	4-2.6.1 Mail Room.....91
	4-2.6.2 Reproduction.....92
4-2.7	Information Technology (IT) Spaces .....93
	4-2.7.1 IT Spaces - General Information.....93
	4-2.7.2 Entrance Facility (EF) .....94
	4-2.7.3 Telecommunications Equipment Room (TER).....95
	4-2.7.4 Telecommunications Room (TR).....97
	4-2.7.5 IT Work Space .....98
4-2.8	Lobby .....99
4-2.9	Assembly Hall .....100
4-2.10	Chair and Table Storage .....102
4-2.11	Kitchen .....103
4-2.12	Arms Vault.....104
4-2.13	Armorer's Room.....107
4-2.14	Classrooms .....108
4-2.15	Library Reading Room .....111
4-2.16	Library Storage .....112
4-2.17	Learning Center .....112
4-2.18	Training Aids Storage.....113
4-2.19	COMSEC Storage.....114
4-2.20	Unit/Individual Storage.....115
4-2.21	Staging Area .....117
4-2.22	Supply Office.....118
4-2.23	Janitorial.....119
4-2.24	Flammable Storage.....120
4-2.25	Controlled Waste Storage .....120
4-2.26	Facility Maintenance Storage.....120
4-2.27	Weapons Simulator.....121
4-2.28	Band Room .....123
4-2.29	Medical Section.....123
4-2.30	Physical Exam Wing .....124
4-2.31	Secure Compartmented Information Facility (SCIF) .....124
4-2.32	Soils Testing Lab .....124
4-2.33	Conference Room.....124
4-2.34	Drafting Room.....126
4-2.35	Physical Readiness Training.....127

**CONTENTS Continued**

	<u>Page</u>
4-2.36 Army Global Command Control System (AGCCS ).....	128
4-2.37 Distance Learning Center .....	129
4-2.38 Male and Female Toilets and Showers .....	130
4-2.39 Accessible Unisex Toilet .....	131
4-2.40 Male and Female Locker Rooms .....	131
4-2.41 Vending Alcove .....	133
4-2.42 Break Area .....	133
4-2.43 Mechanical.....	134
4-2.44 Electrical .....	135
4-2.45 Circulation .....	136
4-2.46 Stairs.....	137
4-2.47 SIPRNET Cafe.....	138
4-2.48 EOC - Emergency Operations Center .....	141
4-3 ORGANIZATIONAL MAINTENANCE SHOP .....	142
4-3.1 Shop Office .....	142
4-3.2 Male and Female Toilets .....	143
4-3.4 Storage Room.....	144
4-3.5 Special Equipment Alcove .....	145
4-3.6 Battery Room.....	146
4-3.7 Flammable Storage.....	146
4-3.8 Controlled Waste Storage.....	147
4-3.9 Workbays .....	148
4-3.10 Mechanical/Electricall .....	152
4-3.11 Information Technology .....	153
4-3.12 Custodial/Janitorial.....	153
4-5 AREA MAINTENANCE SUPPORT ACTIVITY (AMSA) .....	154
4-5.1 General .....	154
4-5.2 AMSA Workbays .....	154
4-5.3 Small Arms Shop and Vault .....	155
4-5.4 Supply .....	155
4-5.5 Electrical/Communications Repair .....	156
4-5.6 Breakroom .....	156
4-5.7 Male and Female Locker Rooms .....	156
4-5.8 Male and Female Toilets and Showers .....	157
4-5.9 Battery Room.....	157
4-6 DIRECT SUPPORT/GENERAL SUPPORT (DS/GS) .....	158
4-7 DEPLOYABLE MEDICAL SETS (DEPMEDS) .....	159
4-8 WAREHOUSE.....	159

**CONTENTS Continued**

	<u>Page</u>
<b>APPENDICES</b>	
APPENDIX A References.....	161
APPENDIX B Acronyms and Military Rank Designations.....	167
APPENDIX C OMAR-Funded Items .....	173
APPENDIX D Sample 1390, 1391, AND 5034R - Functional Space Detail.....	175
APPENDIX E Standard Kitchen Plan and Equipment List.....	199
APPENDIX F Toilet Room Fixture Counts.....	201
APPENDIX G Band Room .....	205
APPENDIX H Secure Compartmented Information Facilities (SCIF) .....	207
APPENDIX I Physical Exam Wing .....	209
APPENDIX J Equipment Concentration Site (ECS).....	212
APPENDIX K Roof Systems for Army Reserve Projects.....	214
APPENDIX L Physical Readiness Room Equipment Matrix .....	219
APPENDIX M Sample Projects and Photography Credits .....	220



**FIGURES**

<u>Figure</u>	<u>Title</u>	<u>Page</u>
1-1	USARC, Ft Dodge, Iowa.....	1
1-2	Project Guidance.....	2
1-3	USARC, Camp Parks, California.....	2
1-4	ARRTC VOQ, Ft. McCoy, Wisconsin.....	4
1-5	Total Systems Design.....	6
1-6	USARC, Camp Parks, California.....	7
1-7	OMS/DS-GS, Arden Hills, Minnesota.....	9
2-1	Project Design Development.....	12
2-2	USARC, Green Bay, Wisconsin.....	13
2-3	Site Access.....	15
2-4	Typical Reserve Center Site Plan.....	15
2-5	Typical AMSA Site Plan.....	16
2-6	Typical ECS Site Plan.....	16
2-7	Landscape Planting.....	21
2-8	ARRTC VOQ, Ft. McCoy, Wisconsin.....	23
2-9	Flexibility for Future.....	23
2-10	Training Center Adjacencies.....	25
2-11	USARC, Green Bay, Wisconsin.....	25
2-12	Lobby and Full-time Office.....	26
2-13	Office/Unit Common Relationship.....	26
2-14	Multiple Unit Commons.....	26
2-15	USARC, Ft. Dodge, Iowa.....	27
2-16	Assembly Hall Adjacencies.....	27
2-17	Janitorial and Toilets.....	28
2-18	Conference Room.....	29
2-19	OMS Schematic Diagram.....	30
2-20	Shop Office Views.....	31
2-21	AMSA Schematic Diagram.....	31
2-22	ARRTC VOQ, Ft. McCoy, Wisconsin.....	33
2-23	USARC, Ft. Knox, Kentucky.....	34
3-1	ARRTC VOQ, Ft. McCoy, Wisconsin.....	36
3-2	ARRTC VOQ, Ft. McCoy, Wisconsin.....	37
3-3	USARC, Camp Parks, California.....	41
3-4	USARC, Camp Parks, California.....	43
3-5	USARC, Sacramento, California.....	47
3-6	AFRC, Greenville, North Carolina.....	50
3-7	ARRTC VOQ, Ft. McCoy, Wisconsin.....	53
3-8	Duffel Bag Cage Layout.....	54
3-9	USARC, Camp Parks, California.....	56
3-10	USARC, Arden Hills, Minnesota.....	62
3-11	Janitor's Closet.....	66
3-12	USARC, Camp Parks, California.....	69
3-13	USARC, Arden Hills, Minnesota.....	79
3-14	USARC, Arden Hills, Minnesota.....	81

**FIGURES Continued**

<u>Figure</u>	<u>Title</u>	<u>Page</u>
4-1	Single Office .....	87
4-2	Shared Office - A .....	87
4-3	Shared Office - B .....	87
4-4	Unit Commons .....	88
4-5	Unit Commons .....	88
4-6	Recruiting / Retention Office.....	90
4-7	Mail Room .....	91
4-8	Copy Room.....	93
4-9	IT Work Space .....	98
4-10	Lobby .....	99
4-11	Assembly Hall and Kitchen.....	100
4-12	Chair and Table Storage.....	102
4-13	Armorer's Room and Arms Vault .....	105
4-14	Classroom .....	109
4-15	Classroom with Operable Partition .....	110
4-16	Library Reading Room.....	111
4-17	Library Storage .....	112
4-18	Learning Center .....	112
4-19	Training Aids Storage .....	113
4-20	Unit Storage with Supply Office.....	116
4-21	Unit Storage with Staging and Supply Office.....	117
4-22	Janitorial .....	119
4-23	Facility Maintenance Storage .....	120
4-24	Weapons Simulator .....	121
4-25	Conference Room .....	125
4-26	Physical Readiness Training Room.....	127
4-27	AGCCS.....	129
4-28	Shower Room.....	130
4-29	Unisex Toilet .....	131
4-30	Locker Room .....	132
4-31	Vending Alcove .....	133
4-32	Break Area.....	134
4-33	Typical Small SIPRNET Cafe .....	139
4-34	Typical Large SIPRNET Cafe .....	140
4-35	Shop Office.....	142
4-36	Unisex Toilet .....	143
4-37	Tools and Parts Storage Room .....	144
4-38	Flammable Storage .....	146
4-39	Controlled Waste Storage.....	148
4-40	Workbays.....	150
4-41	Small Arms Repair Room with Arms Vault.....	155
4-42	Electric / Comm. Repair.....	156
4-43	Break Area.....	156
4-44	Battery Room and Toilet .....	157

**FIGURES Continued**

<u>Figure</u>	<u>Title</u>	<u>Page</u>
E-1	Kitchen Equipment Plan .....	199
G-1	Standard Band Room Plan.....	206
I-1	Typical Medical Section Plan.....	209
J-1	Typical ECS Layout .....	212

## CHAPTER 1

### INTRODUCTION AND GENERAL INFORMATION

#### 1-1 PURPOSE OF THE DESIGN GUIDE

**1-1.1** This Design Guide contains design criteria and general requirements to be used in the development of designs for new construction and additions/alterations of U.S. Army Reserve (USAR) facilities. Its purpose is to serve as one means for the Using Service to convey functional and other criteria for Military Construction Army Reserve (MCAR) projects to the Design Agency charged with the planning and design of a facility. This Guide is also intended to aid in the formulation of project documentation for inclusion in military construction programs.

**Figure 1-1**  
**USARC, Ft Dodge,**  
**Iowa**



**1-1.1.1** The Using Service is the Assistant Chief of Staff for Installation Management- Operations Division Reserve (ACSIM-ODR). An ACSIM-ODR representative, the Project Officer, is typically assigned to each project.

**1-1.1.2** The USAR Installation includes the USAR unit(s) that will utilize the facility (Tenants) and the USAR Regional Support Command (RSC), which supports the unit(s). ~~3\ /3/~~

**1-1.1.3** The Design Agency is the Corps of Engineers (COE) or other engineering command, which acts as USAR's agent for obtaining design and construction services. The Design Agency may develop project designs utilizing their in-house design personnel, or may contract with private-sector architecture and engineering firms (A/Es) to provide design services. The in-house personnel or private-sector A/E team will be referred to as "designer" or "design team" in this Guide.

**1-1.2** This Guide should also be used as a benchmark of acceptable quality for USAR Full Facility Restoration (FFR), Real Property Exchange (RPX), Minor Maintenance and Repair (MMR) and other projects. See Paragraph below for additional information on such programs and their funding.

**1-1.3** This Guide should be considered to provide guidance representing an 80% solution; the information should apply at least 80% of the time, and address at least 80% of the issues. The Design Agency should always obtain Using Service approval when departing from the guidance herein.

#### 1-2 SCOPE OF THE DESIGN GUIDE

**1-2.1** This Guide is applicable to all new construction projects for Army Reserve facilities, and as a general guide in the modernization or restoration of existing facilities. Only the more common or typical features associated with Army Reserve facilities are addressed. The Guide deals primarily with training center buildings and vehicle maintenance shops, both of which directly support a training facility or group of facilities.

**1-2.2** The intent of the Guide is to provide a portion of the general information and guidance required for the successful preparation of project designs. Additional information and guidance must be obtained from the Using Service, the USAR Installation, the Design Agency, and designer investigations on such matters as project scope, local codes and site constraints. Typical project-specific and general documentation to be made available to the designers is listed below. Additional listings of criteria are in [Appendix A](#).

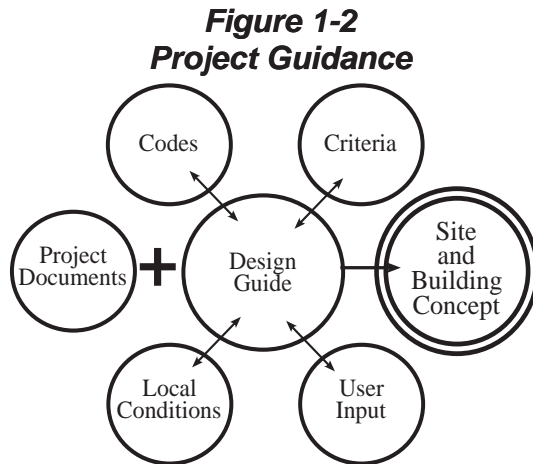

**1-2.2.1** Project Documents  
 DD Forms 1390 and 1391 – project authorization documentation.  
 DD Form 5034R – Functional Space Worksheet (with notes). (Sample of Forms in [Appendix D](#))  
 Project Scope of Work for design team.

**1-2.2.2** Additional Design Criteria  
 USAR Design Process and Submittal Requirements.  
 Design Criteria, Technical Manuals, Technical Letters, Unified Facilities Criteria (UFC), and other design guidance. Unified Facility Guide

Specifications (UFGS). \3\

### 1-3 ARMY RESERVE CADD PLATFORM

**1-3.1** The Army Reserve CADD platform is Bentley’s MicroStation TriForma. A USAR Building Information Model (BIM) dataset has been developed utilizing the TriForma workspace. The USAR BIM Dataset is available upon request to the Louisville District Army Reserve Support Team to designers under contract to perform Army Reserve designs. The USAR BIM dataset is coordinated and has relationships built so that information can be easily extracted in the form of drawings, details, schedules, quantity takeoffs, renderings, animations, and other formats needed during the design and/or construction process. The BIM dataset provides the level of quality expected by the Army Reserve. The Bentley Microstation TriForma platform was selected by the Army Reserve and Louisville District to provide consistency and ease in updating, maintaining, and reviewing the BIM dataset.

**Figure 1-3  
USARC, Camp  
Parks, California**



**1-3.2** Along with the USAR BIM Dataset, the Army Reserve developed its “USAR Design Process and Submittal Requirements” document to define its desired design process and submittals to be made at each step of the design process. All Army Reserve projects should follow the “USAR Design Process and Submittal Requirements” document, unless otherwise directed by the Using Service or the Design Agency.

**1-3.3** The previous Army Reserve CADD platform, Modular Design System (MDS), was a unique MicroStation-based computer aided design software program used to complete USAR facility designs. This program contained the level of quality expected by the Army Reserve. MDS had the unique capability to streamline the design and review process, offer more uniform construction quality and produce a reliable cost estimate early in the design process. However, with the recent moves in design towards a three dimensional modeling approach and generational changes to Bentley's MicroStation requiring updates to the MDS program, maintaining the program was cost prohibitive to the Army Reserve, thus MDS was retired./3/

## **1-4 FORMAT OF THE DESIGN GUIDE**

**1-4.1** The Design Guide format is intended to facilitate the development of project requirements and designs by dealing with major criteria on both a general and specific level.

**1-4.2** Chapter 1 provides general information about the Army Reserve, and its facilities program and process. Chapter 2 provides information and guidance on overall planning of Army Reserve sites and buildings, with emphasis on site and building organization, functionality, adjacencies and esthetics. Chapter 3 contains information and guidance on systems and materials applicable to all Army Reserve facilities, site design, and the design of the various buildings – large-scale, total building or facility issues. Chapter 4 contains specific requirements for the design of each type of typical space in an Army Reserve facility. Additional information is included in the Appendices.

**1-4.3** Illustrations in this Guide represent possible applications of the criteria and are not intended to be definitive. The Design Agency is encouraged to be creative throughout the design process. Local conditions, codes and specific project requirements are major design considerations in the development of a total, integrated facility.

## **1-5 PROJECT PARTICIPANT RESPONSIBILITIES**

**1-5.1** The Using Service (ACSIM-ODR) is responsible for the following:

**1-5.1.1** Determining functional requirements from USAR criteria.

**1-5.1.2** Approving functional requirements or Tenant requests that extend beyond the scope of this Guide.

**1-5.1.3** Preparing and submitting project documentation (DD Forms 1390 and 1391 and supporting data) in accordance with Army Regulation 140-483 (AR 140-483), and providing any updates of these documents as the project progresses.

**1-5.1.4** Approving concept and later designs to certify compliance with functional requirements.



**1-5.1.5** Developing additional information, as required, such as telephone needs, special electrical requirements and equipment specifications.

**1-5.2** The Design Agency is responsible for the following:

**1-5.2.1** Preparing a design that provides for a complete and usable facility, including all equipment, fixtures and furnishings except those specifically designated as Government-furnished.

**1-5.2.2** Incorporating the functional requirements of the Using Service and USAR Installation into the project design.

**1-5.2.3** Developing a design responsive to the criteria in this Guide and the project documentation, and preparing all submittals required by the USAR Design Process and Submittal Requirements, and the project Scope of Work.

**1-5.2.4** Justifying, in the project Design Analysis, any issues of design which do not follow this Guide and other project documentation.

**1-5.2.5** Incorporating the quality standards for the overall design as described in this Guide and other criteria for the project.

**Figure 1-4**  
**ARRTC VOQ,**  
**Ft. McCoy,**  
**Wisconsin**



**1-5.2.6** Identifying the applicable codes and regulations, and ensuring that the design is in compliance with them.

**1-5.2.7** Preparing cost estimates, and ensuring that the design will provide a fully functional facility within the project construction cost limit (CCL). Optional bid items may be required to ensure that a base bid within the construction cost limit can be achieved. Any such options must be planned such that the facility is complete and usable without their inclusion.

**1-5.2.8** Preparing a draft of DD Form 1354, Transfer and Acceptance of Military Real Property.

**1-5.2.9** Preparing any surveys and/or geotechnical, environmental, sustainable design or other investigations identified in the project Scope of Work.

**1-5.2.10** Developing design analyses, calculations, and other information that supports and explains the project design.

**1-5.2.11** Identifying issues that will deserve special attention during project construction.

**1-5.2.12** Preparing a draft of specification **12** Section 00 80 00.00 06 **12** for the use of the constructing entity, and reviewing and commenting on the remainder of the “front-end” specifications. **12** Specification section available at the USACE Louisville District

Web-Site. /2/

**1-5.2.13** Complete coordination of A/E discipline interfaces, and checking for architectural, structural, HVAC, electrical, plumbing and fire protection conflicts.

**1-5.2.14** Preparing a submittal register for inclusion in the specifications, coordinated with the construction entity.

**1-5.3** The USAR Support Installation is responsible for the following:

**1-5.3.1** Providing the Design Agency with as-built drawings of existing construction.

**1-5.3.2** For alteration projects, providing a copy of all outstanding maintenance and repair work orders.

**1-5.3.3** Providing a copy of the current Full Facility Assessment.

**1-5.3.4** Providing a condition survey for any existing facilities affected by the proposed work, along with a list of any red or amber conditions noted in the Installation Status Report.

**1-5.3.5** Reviewing and commenting on Design Agency submittals, and providing input to the Design Agency as requested.

**1-5.3.6** Ensuring that any required real estate purchase is accomplished in a timely manner.

**1-5.3.7** Providing a threat assessment that identifies the level of risk for the facility to be designed.

**1-5.3.8** If real estate was purchased for the project, providing a copy of the Real Estate Planning Report (REPR) and any Engineering Feasibility Study done during the real estate acquisition.

**1-5.3.9** Performing any required environmental investigations, and preparing any required environmental documentation, such as environmental baseline surveys (EBS) and/or environmental assessments (EA). The USAR Installation may contract with the Design Agency or design team for performance of these tasks.

## **1-6 PURPOSE OF THE ARMY RESERVE**

**1-6.1** The purpose of the Army Reserve is to provide trained units and qualified individual soldiers for active duty in time of need.

**1-6.2** The Army Reserve spends most of its drill time in training. Therefore, a Reserve Center is a training center.



**1-6.2.1** The individual soldier is given hands-on training in the skills of his/her job with particular emphasis on the operation and maintenance of equipment.

**1-6.2.2** Unit training is accomplished by progressively larger and larger elements to perform the mission as a team.

**1-6.3** Every functional space in a Reserve Center is intended to be primarily a training space. For example:

**1-6.3.1** The primary purpose of a kitchen is to allow cooks to train. The secondary purpose is to feed the troops.

**1-6.3.2** The primary purpose of the organizational maintenance shop (OMS) is to allow the training of mechanics. The secondary purpose is to maintain vehicles.

**1-6.3.3** The primary purpose of office space is to allow the training of staff and clerical personnel. The secondary purpose is to perform administrative functions associated with the unit's mission.

**1-6.4** A Reserve Center is an institutional building with both community and national significance. The center is the home station for the local unit composed of individuals sharing experiences of personal action on behalf of the community, much in the same way as a volunteer fire department. At the same time, as a Government installation of the U.S. Army, it represents the entire Army. Thus the design of the building must reflect the Reservists' feelings of patriotism, pride and community participation as well as a sense of the purpose of the U.S. Army: to keep the peace by maintaining a strong and capable organized military force.

## **1-7 QUALITY OF DESIGN**

**1-7.1** The Design Agency must seek design excellence through commitment to high standards. Success in achieving this objective lies not in the repetition of previous design solutions but in relating to the Using Service and USAR Installation project-specific requirements, and responding to their unique needs.

**1-7.2** The concept of total systems design will be emphasized in promoting the development of a functional, energy efficient and esthetically pleasing building. Design concepts must evolve in a multidisciplinary manner with regard to architectural, civil, structural, electrical and mechanical systems.

**1-7.3** In evaluating the cost impact of design decisions, the designer will consider the life cycle cost effectiveness, not just the initial cost.

**Figure 1-5**  
**Total Systems Design**

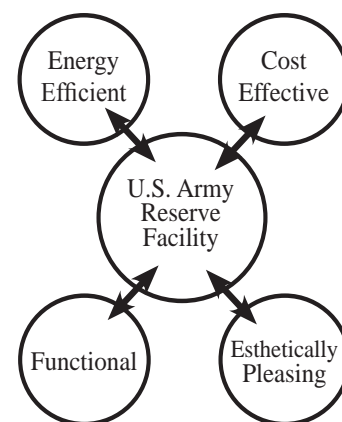

## 1-8 PROJECT DELIVERY

**1-8.1** Design/Bid/Build Delivery Process: The majority of USAR facility projects are delivered through the design/bid/build (D/B/B) process. The Design Agency prepares a comprehensive and detailed set of construction documents; interested construction contractors use these documents to prepare competitive “hard” bids for Government evaluation; and the qualified bidder with the lowest proposed construction price is awarded the contract for construction at the proposed price.

**1-8.1.2** Under the D/B/B delivery method it is critical that the Design Agency provides construction documents that clearly define all construction requirements, so that the Using Service gets the benefit of best possible bids. No issues should remain vague or be left in a state to be resolved during construction; this could result in differing assumptions among bidders, bid protests and contractor claims for price increases during construction.

**1-8.1.3** The designer must also keep in mind that bidders are not required to visit the construction site prior to bidding. The construction documents must allow for preparation of bids without the necessity of a site visit. Any items identified as options to the base bid must likewise be fully defined. Both the base bid condition and the option condition must be adequately illustrated, detailed and specified.

**1-8.2** Design/Build Delivery Process: Some USAR projects may be delivered through a design/build (D/B) process. Under this delivery method the Design Agency develops a D/B Request for Proposal (RFP) solicitation package. Interested D/B teams respond with statements of qualifications as well as their proposed construction price. The proposals are evaluated on price, qualifications, and other items or information requested in the RFP. The highest-ranked proposing team is awarded a contract to complete the project design and perform the construction.

**Figure 1-6**  
**USARC, Camp**  
**Parks, California**



**1-8.2.1** The Using Service, the USAR Installation, and the Design Agency must determine the scope and content of the D/B RFP. The goal is to provide sufficient project information and criteria to ensure that the resulting facility will meet standard USAR requirements for quality, functionality, performance and esthetics. The facility program and USAR standards must be defined, and specific Tenant requirements identified. Qualifications for selection must be described, along with design completion requirements and submittals.

**1-8.2.2** The D/B RFP may include conceptual site and building plans, conceptual image sketches, and outline specifications.

## 1-9 PROGRAM SYNOPSIS

**1-9.1** A typical facility consists of two major components: the training center and related maintenance facilities.

**1-9.2** Chapter 4 delineates the functional and environmental requirements for most individual spaces within the training center and maintenance buildings. Not all projects will include all of the spaces, nor are all of the possible types of spaces included in this Design Guide. Specific information on the types and sizes of spaces authorized is determined by the project documentation. The Design Agency will supplement the information in this Guide in the project documentation and at the initial design conference.

**1-9.3** The Army Reserve Center or training center (TC) generally consists of five main functional groups: administrative, assembly/kitchen, weapons, educational, and storage. Supporting these main functional groups are the special training and support areas. Within each group are subordinate functional areas that contribute to the operation of the group. Circulation and structural space are allocated to each project based on the size of the other authorized spaces.

**1-9.3.1** The administrative group consists of spaces for offices, recruiting/retention, information technology, administrative support, and a lobby.

**1-9.3.1.1** Full-time and unit exclusive office space is dedicated space for full-time employees and unit supervisors. These may be single or shared offices.

**1-9.3.1.2** Unit common office space is shared space for use by non-supervisory unit personnel. The unit common workstations are available for use by the various Tenant units on their assigned drill weekends.

**1-9.3.1.3** Supporting spaces include such functions as the mailroom, administrative support rooms, information technology, recruiting/retention offices, family support office, and the lobby.

**1-9.3.2** The assembly/kitchen group consists of the assembly hall, table and chair storage, and the kitchen.

**1-9.3.2.1** The main element of the assembly group is a multipurpose space for assembly. The hall serves as a large classroom, a practical training area, a dining room, and as an area for drills and ceremonies.

**1-9.3.2.2** The kitchen serves as a training space for cooks, and is also used to prepare and serve meals for drills and other events.

**1-9.3.3** The weapons group consists of the arms vault, for storage of the Tenants' weapons, and the armorer's room, for weapon distribution/return and repair.

**1-9.3.4** The educational group consists of classrooms, library reading and storage rooms, learning center, training aids storage, and communications security (COMSEC) training and storage rooms. These areas provide instructional space for Reservists during weekend training periods and testing areas for potential unit members.

**1-9.3.5** The storage group consists of unit/individual storage areas, staging area, supply offices, and storage spaces for janitorial, facility maintenance, flammables and controlled waste. The unit/individual storage space is closely related to the assembly group, which provides a training space for use of the equipment issued from the storage group.

**1-9.3.6** Special training areas, when authorized, include such spaces as physical training, weapons training, drafting rooms, medical wings, band areas and photo labs. General-use conference rooms, when authorized, are included as special training spaces.

**1-9.3.7** Support areas are allocated in proportion to the number of soldiers, or the size of the other authorized spaces in the facility. They include toilets, showers, locker rooms, vending, breakroom, and space for mechanical, electrical, and telephone equipment.

**1-9.3.8** A privately-owned vehicle parking area (POV) is typically associated with the training center.

**Figure 1-7**  
**OMS/DS-GS,**  
**Arden Hills,**  
**Minnesota**



**1-9.4** Maintenance facilities consist of organizational maintenance shops (OMS), direct support and general support maintenance shops (DS/GS), area maintenance support activity shops (AMSA), and maintenance shops of equipment concentration sites (ECS).

**1-9.4.1** These facilities may be collocated with a training center and with each other. When collocated, the maintenance workbays will be shared. Military equipment parking areas (MEP) are also associated with these facilities.

**1-9.4.2** OMS and DS/GS Shops are used primarily to train Reserve mechanics, although some full-time employees may be assigned to these facilities.

**1-9.4.3** AMSA and ECS maintenance facilities have the same requirements and will both be referred to as AMSA. These shops are used primarily to service vehicles, using a full-time staff. The bulk of maintenance work is performed in these shops.

**1-9.4.4** An ECS is a large storage site with outdoor parking areas and enclosed warehousing of military equipment, typically located at a larger Government installation. The ECS is designed not only to store equipment but also to efficiently issue and return equipment used in training exercises. Facilities which may be associated with an ECS, if included in the project documentation, are an MEP, fuel dispensing system, loading ramp, wash platform, indoor equipment storage warehouse, combat vehicle arms vault, fencing, security lighting and an AMSA.

#### **1-9.4.5 Common OMS/AMSA/ECS Configurations**

**1-9.4.5.1** As a separate location, supporting USAR units in a geographical area, a typical AMSA will consist of an AMSA building with POV area and MEP.

**1-9.4.5.2** When collocated with an OMS, and supporting USAR units in a geographical area, there will typically be an OMS/AMSA building with shared workbays, a shared POV area, and an MEP.

**1-9.4.5.3** If in a separate location, and supporting only an ECS, there will typically be an AMSA building, POV area, MEP, and any other ancillary facilities as provided for in the project documents.

### **1-10 USAR PROJECT FUNDING**

**1-10.1** The Government generally utilizes two sources of funding for new and add/alter USAR projects: MCAR, and Operation and Maintenance Army Reserve (OMAR) funds. The construction documents must identify all OMAR-funded items so that the bidders can provide separate pricing. Cost estimates must also differentiate the two types of funds, and OMAR items must be further divided into furniture and collateral equipment. A list of OMAR-funded collateral equipment is in [Appendix C](#).

**1-10.1.1** All fixed site and building construction is typically MCAR funded. Unless otherwise directed, all required built-in equipment and furnishings are also MCAR funded and will be included in the design of the project, to be furnished and installed by the construction contractor.

**1-10.1.2** Moveable equipment (items not built into the construction or hard-connected to utilities, and which could be relocated to another facility for reuse) and some specialty items are OMAR-funded. They will also be included in the design, to be furnished and installed by the construction contractor. Finally, furnishings and some specialty equipment are OMAR-funded, and will be included for information only in the design documents, but will typically be furnished by the Using Service under a separate contract. The Design Agency will prepare a separate package for furniture acquisition.

**1-10.2** The ~~3~~Full Facility Restoration (FFR)~~3~~, Minor Maintenance and Repair (MMR), and other programs are also OMAR-funded. These programs generally use simplified design methods to design and construct projects within annual OMAR funding cycles; utilize the Design Guide as the starting point for project designs.

**1-10.2.1** In the FFR program, all building components in the affected buildings, and the utility infrastructure, are evaluated for remaining useful life, and for compliance with current building and life safety codes. Systems and components that are at or near failure, or in serious need of modernization, are replaced with current products approved by the Using Service.

**1-10.2.2** FFR projects are further evaluated against Plant Replacement Value (PRV),

as defined by AR 420-10, and cannot exceed 50% of PRV without specific approval of the appropriate Deputy Assistant Secretary of the Army.

**1-10.2.3** The majority of FFR projects consist of maintenance and repair (M&R), or health/life safety work. These projects are funded from different subsets of the OMAR “K” account.

**1-10.2.4** FFR projects may include some incidental new Minor Construction work in order to provide complete and usable USAR facilities. This work is funded from the OMAR “L” account; the current limits on the allowable construction cost must be verified and not exceeded.

**1-10.2.5** Cost estimates for FFR projects must differentiate the amounts to be funded from different OMAR accounts, as directed by the Using Service.

**1-10.3** Real Property Exchange (RPX) projects involve the exchange of Army Reserve property and/or facilities for property or facilities owned or built-to- suit by other Governmental units or the private sector. The entity with which the USAR makes such an exchange is the “exchange partner.” The exchange partner typically provides the funding for any facility design and construction to be acquired by the USAR in such exchanges, and often provides both the design and construction of the facility, transferring ownership to the USAR when the project is ready for occupancy.

## **1-11 CONSTRUCTION CONTRACT AWARD**

**1-11.1** The construction contracts for many of the USAR projects are awarded solely on the basis of lowest bid, after an open, competitive bidding process. Other contracts may be awarded on the basis of price among other qualifications, and some contracts may be set-aside for award to small or small, disadvantaged businesses, on the basis of price, or price among other qualifications.

**1-11.2** The construction documents must be complete and comprehensive to ensure, to the extent possible, that all work required is shown or described. No details or other parts of the work should be left for resolution during construction. This will help ensure that all prospective construction contractors are basing their bids or proposals on the same construction work effort.



## CHAPTER 2

### PLANNING GUIDELINES

#### 2-1 INTRODUCTION

**2-1.1** The goal of the site and building planning process is to develop one or more site/building concepts for a functional and efficient facility. In addition to meeting USAR criteria and standards, the facility should fit well into the surrounding environment, and accommodate existing and future development to the extent possible.

**2-1.2** A wide variety of factors must be considered in the site and building planning process; this Chapter identifies and discusses some of them. The Design Agency must ensure that all appropriate factors are considered, including those that are specific to the project site.

**2-1.3** The two main documents submitted to the designer, prior to beginning design for a facility, are the project documents (see 1-2.2.1) and this Guide. The project documents lists the authorized spaces and their respective areas for a specific project. This Guide provides design criteria and application guidelines which will be used in the development of the project. Use of these two documents will help the designer to quickly produce the schematic design and design development of the proposed facility.

#### 2-2 DESIGN AND REGULATORY CRITERIA AND THEIR APPLICATION

**2-2.1** The Design Agency must become familiar with the following design and regulatory criteria and apply them to the planning, and later the design process. It is important that applicable criteria be identified early in the planning process to avoid revisions being required at a later point. In cases where criteria are in conflict, the more stringent criteria generally applies; questions concerning conflicting criteria should be presented to the Using Service for resolution.

##### 2-2.1.1 USAR Standards and Criteria:

Project Documents,  
This Design Guide, and  
USAR Design Process and Submittal  
Requirements

##### 2-2.1.2 Engineering, Design and Other Guidance Criteria See [Appendix A](#).

##### 2-2.1.3 Codes, Regulations and Utility Requirements

**2-2.1.3.1** The Using Service has identified UFC 1-200-01 as guidance for the use of model building codes for design and construction of Army Reserve Facilities. This UFC

**Figure 2-1**  
**Project Design Development**

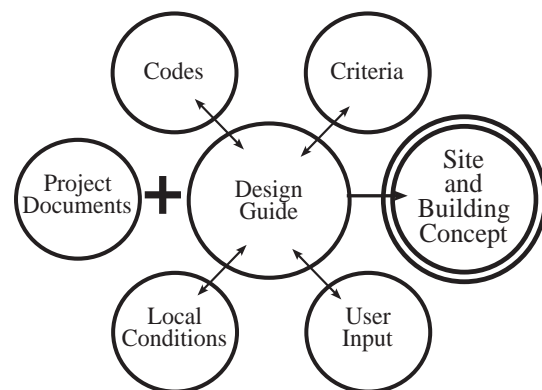

references the International Building Code (IBC) as the basis for building design. The UFC contains specific instructions regarding application of IBC chapters, and for fire protection and life safety requirements refer to UFC 3-600-01 “Fire Protection Engineering For Facilities”. UFC 3-600-01 governs fire protection requirements and includes National Fire Codes and other specific NFPA criteria, such as NFPA 101 for exiting requirements and NFPA 30A for maintenance shops.

**2-2.1.3.2** For facilities not located on federal military installations, the Design Agency must identify local (state, county, city, etc.) codes, regulations, and utility requirements which would be applicable to a typical building project at the site, and determine their applicability to the USAR project. The criteria identified in paragraph 2-2.1.3.1 generally takes precedence over local code requirements unless local code requirements are more stringent.

**2-2.1.3.2.1** If the project site is owned by the Federal Government, it may be a “Federal reservation,” and compliance with all local codes and regulations is not necessarily required under the Doctrine of Supremacy. However, USAR strives to be a “good neighbor” in the communities of its citizen soldiers, and prefers to comply with local codes and regulations, unless such compliance would be particularly onerous or costly or reduce the level of safety within this facility. Using Service encourages the Design Agency to meet with local code and regulatory officials to review the project and the local requirements, and to present any recommendations for non-compliance with local regulations to the Using Service for resolution.

**2-2.1.3.2.2** Property owned by the Federal Government may also be under concurrent jurisdiction of the local and Federal Government, by agreement. If so, compliance with local codes and regulations is generally required. However, the Using Service still encourages the Design Agency to meet with local code and regulatory officials to review the project and the local requirements, and to present any recommendations for noncompliance with local regulations to the Using Service for resolution.

**Figure 2-2**  
**USARC, Green**  
**Bay, Wisconsin**



**2-2.1.3.3** In general, on a Federal reservation, Federal Supremacy Doctrine applies. The local building and zoning codes do not apply; no building permit will be required, nor will construction inspections be performed by local building officials. Local fire codes and utility requirements generally do apply, since these organizations will be the likely service providers to the facility. Other local requirements also generally apply, such as those governing environmental, drainage, traffic, and similar issues.

**2-2.1.3.4** The Design Agency must identify any submittal or permitting requirements, and address them. This can be achieved either by the Design Agency making required submittals and applications, or by incorporating the requirement into the construction documents for contractor implementation. If application and permitting responsibilities are assigned to the construction contractor, the Design Agency must obtain and fill out applications as completely as possible, and convey them to the COE construction



district for contractor use and completion. The Design Agency must also identify any fees the contractor will be required to pay, and include them in the cost estimate and construction documents.

**2-2.1.3.5** On a non-Federal reservation USAR facility, such as a leased facility, local codes and regulations apply as they would for any private-sector project, and building permits and inspections will be required.

#### **2-2.1.4 Installation Design Guidance**

**2-2.1.4.1** If the USAR project site is on a larger Government installation, it is likely the property owner will have installation design guidance applicable to the project, such as an Installation Design Guide. The Design Agency must identify any such guidance, and work with the Using Service to determine its applicability.

**2-2.1.4.2** On a larger Government installation, there typically will also be a public works or similar department, which is likely to have its own requirements for construction on the installation. This department may also control some or all of the utility services. The Design Agency should coordinate its design with the appropriate department personnel.

#### **2-2.1.5 Corps of Engineers Design Guidance**

**2-2.1.5.1** The Corps of Engineers design or construction District may have design guidance, such as Architect/Engineering Instructions, District Design Guides, or construction details that may be applicable. The Design Agency and the Using Service must determine their applicability.

**3\3/**

**2-2.2** **3\ Sustainable Development and Design (SDD)** - DA policy requires all new vertical construction projects with climate controlled facilities be designed using the US Green Building Council (USGBC) Leadership in Energy and Environmental Design for New Construction and Major Renovations (LEED-NC) rating tool to score and assign a rating level (certified, Silver, Gold or Platinum) to the projects. The Design Agency will visit the USGBC website ([www.usgbc.org](http://www.usgbc.org)) to become familiar with the program and obtain the rating tool. All projects after FY08 shall achieve a minimum LEED-NC rating of Silver. The processes for achieving this policy may be found in the "USACE Army LEED Implementation Guide" ([https://eko.usace.army.mil/\\_kd/go.cfm?destination=\)ShowItem&Item\\_ID=47308./3/](https://eko.usace.army.mil/_kd/go.cfm?destination=)ShowItem&Item_ID=47308./3/))

## **2-3 ENVIRONMENTAL**

**2-3.1** In general, an Environmental Baseline Study (EBS) and an Environmental Assessment (EA), with a finding of no significant impact (FONSI), must be completed for each USAR project. Preparation of these documents is the responsibility of the RSC, but the design team must become familiar with any requirements from the studies which are to be included in the design, such as erosion control measures.

2-3.2 See Paragraph 2-2.1.3.4 above for environmental permitting requirements.

## 2-4 SITE SELECTION AND PLANNING

### 2-4.1 General Selection and Planning Criteria

2-4.1.1 In most cases, the project site will have already been selected, based on the following characteristics. If the Design Agency is involved in site selection, the factors below, along with the budget, are important factors to be considered. For additional site selection considerations, see Section 2-5, Antiterrorism/Force Protection.

2-4.1.1.1 A relatively level site, suitable for the parking of military training vehicles.

2-4.1.1.2 A high public visibility of the training center building.

2-4.1.1.3 A buffered area of the site should be available to mask the noise and disruption caused by exterior training exercises and military equipment usage.

2-4.1.1.4 An easily accessible site.

**Figure 2-3**  
**Site Access**

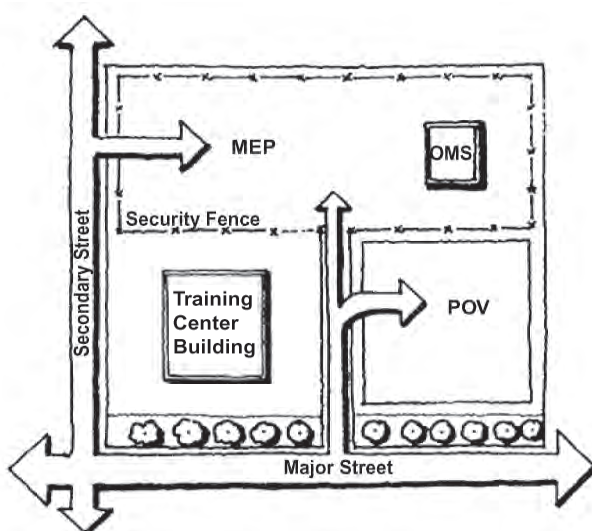

**Figure 2-4**  
**Typical Reserve Center Site Plan**

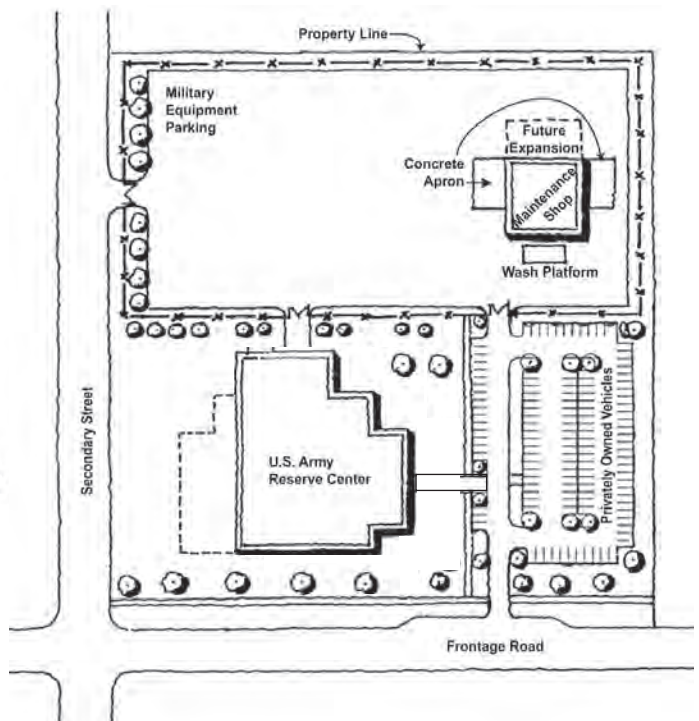

2-4.1.2 The standard USAR training facility consists of the training building, the organizational maintenance shop (OMS) with military equipment parking (MEP) area, and the privately-owned vehicle (POV) parking area. The interrelationship of these spaces and their appropriate site orientation require careful study. As the major point of activity and public access, the training center building should dominate the community

interface of the entire facility and must be visible from adjacent public areas. The MEP and OMS also should be located relatively near the training center building for economical accessibility and to afford a showcase for public relations purposes. The location of the OMS and MEP, and whether community concerns necessitate visual screening of these functions, should be reviewed with the Tenants.

**2-4.1.3** As a general rule, the training center building, due to its high usage and the desire to provide high community visual presence, will be located on the most visible side of the site. The POV parking area is best located behind or adjacent to the training center building. The OMS/AMSA is an individual structure located away from the training center building to minimize noise and disruption. Most Tenants prefer that the administrative portions of any OMS/AMSA building be nearest the training center.

**2-4.1.4** The general direction above tends to divide the site into two zones: an administrative zone for the training center and the POV, and a more utilitarian zone for the OMS and MEP. If possible, without duplication of roadways, a site design should be developed to minimize vehicle circulation interference between traffic for the two zones

**2-4.1.5** Site access must be direct, safe and efficient to minimize the environmental impact of military vehicle traffic. The design should minimize access points but provide adequate acceleration and deceleration lanes at the primary entrance(s). Standard traffic planning practices will be adhered to. To the extent practical, keep POV and military traffic separated. Avoid, if possible, restrictions for site entrance and exit, such as “right-in, right-out” access only.

**2-4.1.6** The schematic design concepts for both the site and the buildings should be based on a simple, logical idea which satisfies the requirements of the program, site, Tenant functions and long life maintenance. Each project is individual and requires a concentrated effort to develop the appropriate solution.

**Figure 2-5**  
**Typical AMSA Site Plan**

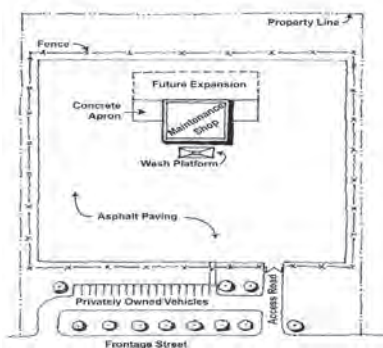

**Figure 2-6**  
**Typical ECS Site Plan**

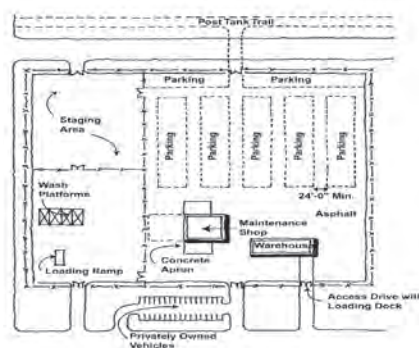

**2-4.1.7** The building and main facility entrance should be apparent to passing traffic while meeting Antiterrorism/Force Protection (AT/FP) requirements, to ensure community visibility and ease of access. Visitor parking and the main entry to be used by building visitors should also be readily identifiable.

**2-4.1.8** AMSA and/or ECS sites, when not collocated with a training center or OMS, should be arranged for functionality and vehicle access with consideration for future expansion.

**2-4.1.9** When practical, orient the longest sides of buildings along an east-west axis. This orientation will generally result in most windows facing north and south to minimize solar heat gain. At extreme latitudes, energy savings may be better with different building orientations.

## **2-4.2** Availability of Utilities

**2-4.2.1** It is the Design Agency's responsibility to verify availability and capacities of all utilities required for the project. Contacts will be made with the utility providers, and records of all discussions should be made and copied to the provider. Any required applications, permits, reviews, fees, design/construction requirements, or service upgrades should be identified, and their impacts on design and construction costs and schedules should be calculated. If alternative providers exist for any utility, the designer should identify the alternatives to the Design Agency as early in the design process as possible, and verify whether a formal study of the alternatives is desired to provide comparative costs, benefits, and drawbacks.

**2-4.2.2** It is obviously preferable that utilities be available at or near the boundaries of the site. Extension of off-site utilities to the site will likely require third party (utility company, municipality, utility district) engineering and/or construction, and possibly acquisition of additional utility easements. Any such off-site work will require additional lead time, and may require formal requests or petitions for approval.

**2-4.2.3** Development of on-site systems is not generally desirable; additional land may be required to prevent interference with on-site water supply and waste water disposal systems. In addition, development of sufficient on-site water supply or storage for fire protection and waste water treatment capabilities will add appreciably to typical project costs.

**2-4.2.4** Gas, electric and telecommunications utilities operate in a competitive environment in many locations, and more than one source of service may be available to the site. Service area agreements between utilities may also be in effect that will limit which utility will service the site and need to be investigated. Information regarding standard rates for utility connection fees, capacity charges or area assessments and their method of payment should be collected.

**2-4.2.5** Many Government installations have "privatized" the utility systems which were formerly under the ownership and operational control of the installation's Department or Directorate of Public Works. The privatized utility system owner should be determined and the necessary information gathered as outlined above. Utilities brought onto the site and constructed by the utility owner may also require that an easement be designated over the utility line to allow the utility company access to maintain and service its line(s). The Government generally prefers to avoid easements

where practical.

**2-4.2.6** On some Government installations, the installation may be a potential utility provider. The design team must verify that the Government has sufficient utility capacity, and also what entity would be responsible for the design, construction and funding of any required upgrades or extensions to the utility service.

### **2-4.3 Existing Jurisdictional Agreements**

**2-4.3.1** Some training centers or Government installations have written agreements with local jurisdictions which govern fire service, utilities, roadways, and similar issues. The designer must verify whether such agreements exist, and ensure that any requirements they impose are incorporated into the project planning.

**2-4.3.2** If the facility is located near a civilian or military airport, the designer must verify the airport authority's requirements, which may not be written into any agreement but will still apply to project construction and operation. There may be height restrictions affecting both construction operations and the finished building(s), other airspace envelope restrictions, and requirements for noise insulation which must be a part of the planning process.

### **2-4.4 Floodways**

**2-4.4.1** All sites will be investigated to verify whether they contain designated floodways; this is typically a part of the EBS/EA effort. The information is normally available from local planning and zoning officials, or from public works water resources or planning sections on Government installations that have a public works directorate or department. The Federal Emergency Management Agency (FEMA) publishes maps of formally studied and designated floodways; their information is normally available through the state agencies responsible for the implementation of the state's flood plain or flood protection program.

**2-4.4.2** The U.S. Army Corps of Engineers District (Civil Works) in which the site is located will also have information as to whether or not the site is protected by a Corps flood protection project.

**2-4.4.3** Not all sites that flood are documented as part of a formal flood plain study or shown on floodway maps; this is usually referred to as small localized flooding, but may have a significant effect on any one site. Therefore, investigation of local reports of flooding on the sites may be needed. Many times, these reports are verbal or included in local newspapers. A preliminary hydrology/hydraulic analysis may be needed to determine the relative frequency and level of flooding that will need to be mitigated by design of the site.

**2-4.4.4** Floodway areas cannot normally be developed. Filling of flood fringe areas is restricted and will require re-analysis of floodway hydraulics if fill depths are exceeded; such filling may not be allowed.



## 2-4.5 Traffic Impacts

**2-4.5.1** The development of an Army Reserve Center will normally result in additional traffic to the existing roadways at the site access point(s). As noted above, such access points should be minimized. The roadway from which access is gained will generally be under the jurisdiction of a public agency (state Department of Transportation, county, township or municipality). A Government installation with a public works department will be responsible for the installation roadways.

**2-4.5.2** The responsible agency for the accessed roadway should be identified and contacted to review the project traffic planning. The designer should verify that the responsible agency has not delegated roadway use and planning to a subordinate agency or level (i.e., a state highway for which the state Department of Transportation is allowing the local municipality to determine turn lane requirements). As with utilities, any required applications, permits, reviews, fees, design/construction requirements, or service upgrades should be identified, and their impacts on design and construction costs and schedules should be calculated.

**2-4.5.3** An estimate of the traffic generation information for the facility should be developed for the review with the responsible agency. It is not unusual for such agencies to limit the number and location of access points, or to require directional access (left- and right-hand turns), turn lanes, acceleration/deceleration lanes, or alignment and spacing in relation to existing access points.

**2-4.5.4** Work on the accessed roadway is normally off-site construction and the responsible agency may or may not allow construction by another agency or “private” party within its right-of-way. The procedures for designing, permitting and implementing this roadway work and associated fees must be identified. The responsible roadway agency may also require a performance bond in its name for the value of the work in their right-of-way, if the construction is accomplished as part of the Government’s site construction contract.

## 2-4.6 Military Vehicle Information

**2-4.6.1** The designers should verify what types of vehicles the Tenants will employ, and design site circulation and parking to accommodate them. These may include commercial delivery vehicles as well as the military vehicles operated and maintained by the unit(s). Site roadways and MEP areas are typically designed with turning radii to accommodate commercial over-the-road trucks, unless the Tenants indicate that they have vehicles which require larger maneuvering allowances.

**2-4.6.2** The Tenants can provide a list of their vehicles and the delivery vehicles they anticipate, and should be able to provide vehicle specifications. Specifications for military vehicles can also be found in the technical bulletin TB 55-46-1, “Standard Characteristics for Transportability of Military Vehicles”, available online at the web site [www.tea.army.mil/](http://www.tea.army.mil/) (Permission required from web site to view publications). This TB lists weights, but does not include turning radii; the designer will verify maximum anticipated

turning radius vehicle with the Tenants, and ask them to provide the specs for that vehicle.

## **2-5 ANTITERRORISM/FORCE PROTECTION (AT/FP)**

**2-5.1** Terrorist attacks have demonstrated the vulnerability of U.S. military and civilian personnel, and the facilities in which they work. To address this vulnerability, the Department of Defense (DoD) established standards to ensure that force protection measures are incorporated into the budgeting, planning, design and construction of Military Construction (MILCON) funded facilities. The standards address both new construction and major renovation projects. They include minimum construction requirements, as well as measures that can be applied where higher threat levels are identified by the USAR Installation. The Design Agency must request that a threat assessment be provided to identify the threat level at the proposed project site.

**2-5.2** AT/FP criteria applies to the design of all USAR facilities, and UFC 4-010-01 provides the mandatory guidance. The design team must verify what is applicable to the specific project and the appropriate USAR installation security personnel must be involved in discussions and design of AT/FP features/considerations.

**2-5.3** This criteria mandates measures to be taken in both site and building design, and can have appreciable impact on site and building planning, and on construction cost. Designers are advised to incorporate AT/FP requirements at the earliest stages of design. A brief summary of some of the minimum construction requirements:

**2-5.3.1** The AT/FP site criteria require, at a minimum, provision of standoff zones to separate buildings from parking, roadways, and other buildings. The standoff zones increase the minimum amount of land required to provide a compliant and functional site layout, and should be considered during site selection. For elevated threat levels, vehicle barriers might be required.

**2-5.3.2** Several building design/construction measures address structural design and the threat of progressive collapse in the event of a bomb blast. These measures discourage building designs of more than two stories due to the associated costs.

**2-5.3.3** Other measures address locations of certain spaces, exterior glazing, utility locations/routing, locations of HVAC air intakes, landscaping, etc.

**2-5.4** ~~V1~~ Mass Notification Systems in Military Construction Projects. To reduce the risk of mass casualties, there must be a timely means to notify building occupants of threats and what should be done in response to those threats. Mass notification is defined as the capability to provide real-time information to all building occupants, or personnel in the immediate vicinity of a building, during emergency situations. UFC 4-021-01 provides additional guidance on mass notification systems.**/1/**

## 2-6 LANDSCAPE

**2-6.1** Landscaping must be an integral part of the facilities design process. Good landscape planning affords many valuable benefits. Planting design reflects an understanding of facilities goals and objectives, an appreciation for existing site conditions and an ability to enhance the outdoor environment through the integration of natural and cultural conditions in a sensitive and pragmatic manner.

**Figure 2-7**

### **Landscape Planting**

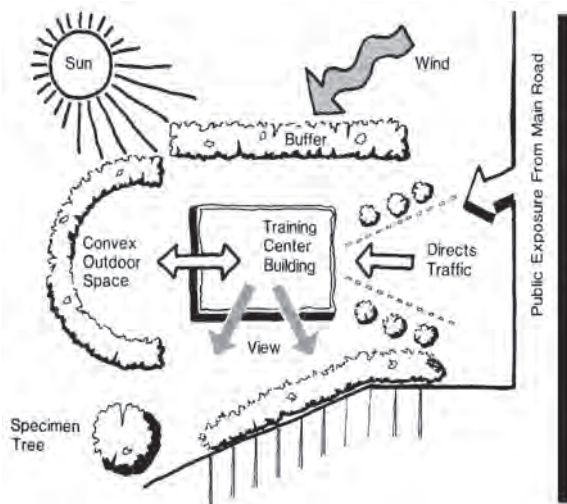

**2-6.2** Architectural character and sense of place is supported by proper landscape design, which introduces aspects of scale, color, texture, form, etc., to the living environment.

**2-6.3** Traffic direction influenced by design of planted areas and strategic location of plant materials can support aspects of wayfinding and reduce the need for supplemental site graphics. Good design encourages safety and assists in the resolution of conflicts between the automobile and the pedestrian.

**2-6.4** Appropriate selection and location of plants reduces water erosion, emphasizes ecological control, lessens proximate environmental impact and promotes clean water through the introduction of natural filtration methods.

**2-6.5** Landscaping provides environmental buffers from harsh winds and intense solar conditions. Strategically located windbreaks minimize the effects of wind erosion and snow disposition upon the outdoor environment. Proper selection and location of tree species promote energy savings and create more comfortable and habitable outdoor places.

**2-6.6** Plant materials provide focus and reinforce positive views. Proper landscape treatment can screen unsightly structural elements and buffer poor visual panoramas.

**2-6.7** Quality, usable outdoor spaces are created through an understanding of existing conditions, programmatic needs and well-developed landscape architectural concepts. Landscape design and the selection of materials must reflect the mission of the facility and Tenants' needs. Planting must be functionally and esthetically appropriate and reflect aspects of safety and security as outlined in the Department of Defense Antiterrorism/Force Protection Standards.

**2-6.8** Plant material selection will afford permanent, low maintenance appropriate to the facility's location. Vegetation must be able to be maintained with a minimum effort, be vandal resistant, hardy and disease resistant. The use of drought tolerant, indigenous vegetation that incorporates aspects of sustainability is strongly encouraged.



**2-6.9** Trees, shrubs and groundcovers must be hardy to the region in which the facility is located and must be horticulturally appropriate to the site specific location in which they are planted. Consideration should be given to adjacent structures and improvements such that the landscaping does not adversely impact them. On some Government installations, the Department of Public Works (DPW) may have a list of preferred plant materials.

**2-6.10** Trees and shrubs should be carefully selected to prevent clogged gutters and drains by leaves and blocked sewer lines due to root damage.

**2-6.11** Refer to UFC 3-210-05FA for comprehensive landscape design considerations.

## **2-7 BUILDINGS**

**2-7.1** General Design Considerations.

**2-7.1.1** Esthetics – Architectural Style and Character

**2-7.1.1.1** The military facility, by its presence, represents national security, strength, austerity, efficiency, professionalism and pride in country and community.

**2-7.1.1.2** Each facility is also the home and workplace of the soldiers it houses, and should provide them with a feeling of pride and ownership. An attractive facility can enhance the Tenants' sense of identity, and serve as one tool for the recruitment of new soldiers.

**2-7.1.1.3** The architecture should be sensitive to the style, scale and materials of the local region not only for esthetics but also for function. Many local building forms and design statements are a direct outgrowth of a region's environmental and cultural characteristics.

**2-7.1.1.4** The facility's style should blend into the existing architecture of the surroundings. Although trendy designs should be avoided, a facility distinctive in appearance can enhance the Tenants' sense of identity and pride of ownership. The character should also evoke a sense of pride in the nearby neighbors as well as the entire community. The USAR wants to be a good neighbor, and a solid member of the community.

**2-7.1.1.5** Materials should be selected to be esthetically pleasing, easily maintained, and cost effective. Standard exterior finish materials approved by the Using Service are described in Chapter 3.

**2-7.1.1.6** Many training center spaces will not have windows, for security reasons or by Tenant preference, such as unit storage, COMSEC training and storage, AGCCS, SCIF, and others. The designer may want to locate these spaces away from major facades to allow use of fenestration on those elevations.

**Figure 2-8**  
**ARRTC VOQ,**



**2-7.1.2 Flexibility and Economy**

**2-7.1.2.1** Internal flexibility should be planned as much as possible to absorb much of the growth and change of the facility over its life as units change their training emphasis. For example, a facility may be designed to accommodate infantry training and then, after a period of time, may need to be changed to accommodate a medical unit. This may require additional maintenance/shop space and a decrease in the unit storage area. If a facility is designed with internal flexibility of building systems, it can accommodate change more economically.

Therefore, the design of office areas should not be too closely tailored to the units currently assigned but should be more generic in design, providing a balanced ratio of exclusive office space to common office space.

**2-7.1.2.2** External flexibility should also be planned to accommodate the potential for growth of the facility. This requires proper siting and utility planning, and a building systems approach to design, universally applied to the facility.

**2-7.1.2.3** Economy of design will be taken in its broadest sense: initial cost, maintenance, and building system flexibility. Consider the following flexible building systems:

**2-7.1.2.3.1** Architectural: Durable and easily maintainable finishes,  $\sqrt{2}$  carpet tile/ $\sqrt{2}$ , detailing which largely avoids custom fabrication, use of standard doors and windows, etc.

**2-7.1.2.3.2** Structural: Strive for a regular column spacing layout, preferably at 32 feet (9600 mm) each direction, to provide remodeling and interior space planning flexibility and economical structural systems.

**Figure 2-9**  
**Flexibility for Future**

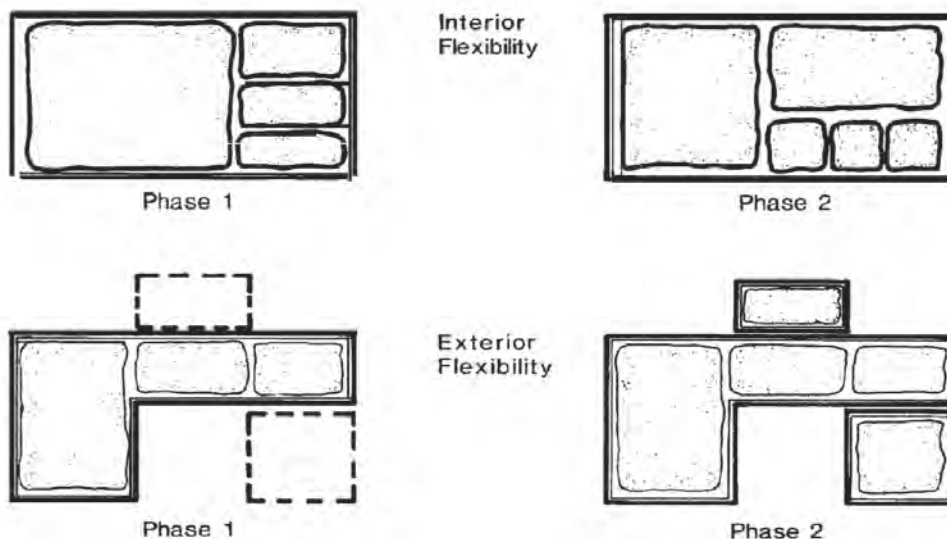

**2-7.1.2.3.3** Mechanical: For large reserve centers, use VAV or fan coil systems which allow simple relocation or addition of zones to meet future zoning requirements. Design of systems shall be integrated within the SDD considerations.

**2-7.1.2.3.4** Electrical: Manufactured flexible wiring for light fixtures in lay-in ceilings, warehouse and storage area ceilings. Main electrical room and electrical closets located adjacent to load centers. Telephone rooms and IT rooms located in the center of the building within 150 feet (50 meters) of the most remote outlet. Spare capacity in distribution equipment for future expansion or additional loads. Run empty conduits for future expansion areas. Run cable trays for communication wiring. To extend power supply and communication system to electrified partitions, use power poles in existing buildings and use flush floor boxes/poke-through boxes in new facilities. ~~3/3/~~

**2-7.1.2.4** Provisions for future expansion must be designed into each project, especially new centers. In the training center buildings, expansion will primarily consist of administrative, classroom and unit storage spaces. The OMS will be sited to allow for the construction of additional workbays. MEP and POV areas will be sited to accommodate increased parking requirements associated with increases in personnel and equipment.

### **2-7.1.3** New Construction, Alterations and Additions

**2-7.1.3.1** The criteria and requirements contained within this Guide pertain to all three types of projects: new construction, alterations and additions. It is recognized, however, that due to the architectural configuration of the existing facilities and the remaining life of its systems and other considerations, it may not be feasible in alteration projects to meet all new construction standards. Professional judgment is required to design a building which combines old and new portions into a harmonious finished design to provide a complete and usable facility at the lowest life cycle cost. As soon as possible after design initiation, the Design Agency should conduct a detailed facility investigation to establish the limits of construction. These limits will be stated in narrative form along with a checklist of required repairs/demolition to be included with the Project Engineering, preconcept (10 percent), or charrette submission. Investigations will include the following:

**2-7.1.3.1.1** Review required real property maintenance and repair work. Consult the facility manager and the USAR Installation (BMAR) list.

**2-7.1.3.1.2** Verify accuracy of as-built drawings.

**2-7.1.3.1.3** Determine adequacy of supporting utilities.

**2-7.1.3.1.4** Determine the status of the following building components: structural, fire protection, electrical, plumbing, and HVAC systems; windows; roof; exterior and interior walls; doors and hardware; stairways; insulation.

**2-7.1.3.1.5** Based on the above and the Project Documents, recommendations as to

the extent of the demolition and remodeling, including reuse or replacement of existing equipment, for the consideration of the Using Service.

**2-7.1.3.2** The Government will perform any studies required to verify economic viability or remaining life of existing facilities (AR PAM 415-3) considered for alterations or additions.

**2-7.2 Training Center (TC) Functional Relationships**

**2-7.2.1 General**

**2-7.2.1.1** The training center spaces are organized into the following groups: Administrative, Assembly/Kitchen, Weapons, Educational, Storage, Special Training and Support.

**2-7.2.1.2** As a general rule, the TC should be organized so that the spaces in each group are adjacent or in close proximity; i.e., administrative spaces should be grouped to the extent possible, possibly in one wing of the building. This is not necessarily true of all the storage, special training, and support group spaces.

**2-7.2.1.3** The janitorial, facility maintenance, support and similar spaces should be distributed throughout the building. The special training spaces should be located near spaces similar in function, or near the specific Tenants that utilize them most. In some cases, such as a band room, the spaces may function best if they can be somewhat isolated from other functions. Tenant preferences should always be considered, along with overall flexibility.

**Figure 2-10  
Training Center Adjacencies**

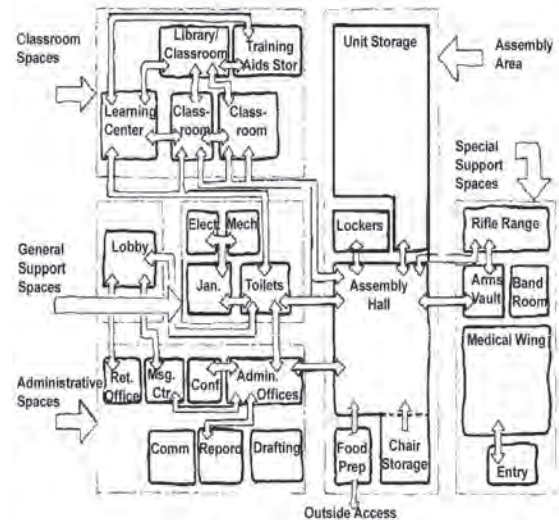

**Figure 2-11  
USARC, Green  
Bay,  
Wisconsin**



**2-7.2.1.4** The training center typically functions efficiently when organized around a central lobby space, so that circulation distances are minimized. The elevator and a stair should be adjacent to the lobby in multistory training centers.

**2-7.2.1.5 Administrative Adjacencies**

**2-7.2.1.5.1** Some of the administrative spaces should be adjacent to the lobby. There is no receptionist, so a full-time office or the recruiting/retention office should be located to monitor the lobby.

**2-7.2.1.5.2** Full-time offices should be clustered around unit common space, and located on exterior walls to allow windows to the extent possible. Full-time offices that cannot be placed around



the unit common should generally be located on main corridors. Multiple, smaller unit commons areas with offices surrounding them are typically preferable to a single, large unit common, for reasons of flexibility. It is preferable that all administrative areas are within 50 feet (15 meters) of a restroom.

**2-7.2.1.5.3** Exclusive offices require the same adjacencies as full-time offices.

**Figure 2-12**  
**Lobby and Full-time Office**

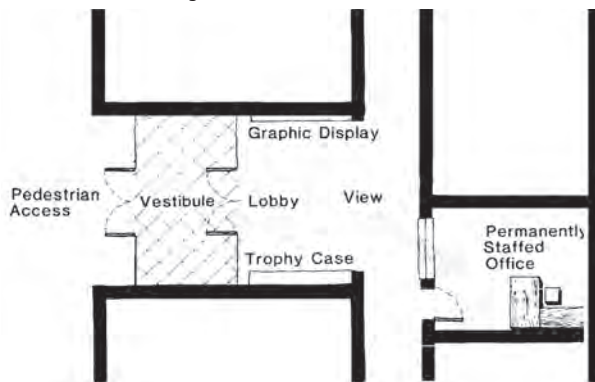

**2-7.2.1.5.4** Unit common space should be adjacent to full-time and exclusive offices, and to administrative support spaces.

**2-7.2.1.5.5** The recruiting retention office should be adjacent to the lobby for both monitoring and ease of location by potential recruits and existing soldiers.

**2-7.2.1.5.6** The message center/ mailroom should be located away from heavily populated areas and critical

infrastructure of the building, and on an outside wall, as AT/FP measures. The travel distance to other administrative areas should be as short as possible while maintaining AT/FP criteria.

**Figure 2-13**  
**Office/Unit Common Relationship**

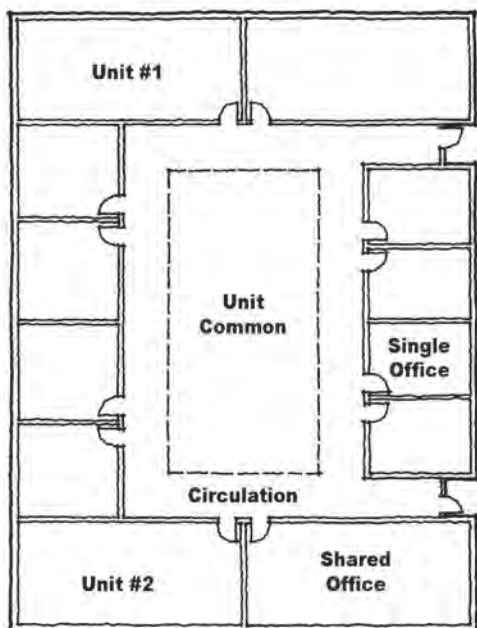

**Figure 2-14**  
**Multiple Unit Commons**

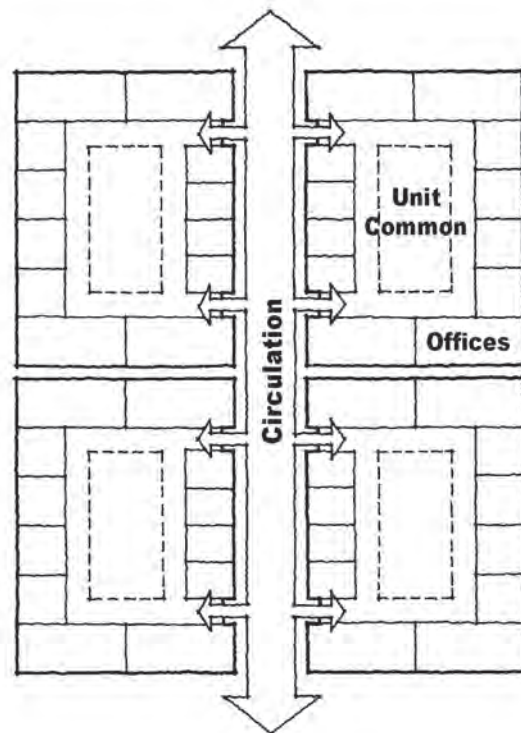

2-7.2.1.5.7 \3\ Family support office should be adjacent or near to the lobby to allow easy access for visiting family members./3/

2-7.2.1.6 Assembly/Kitchen Adjacencies

**Figure 2-15**  
**USARC, Ft. Dodge,**  
**Iowa**



2-7.2.1.6.1 The kitchen and the chair and table storage spaces will always be adjacent to the assembly hall; the meals from the kitchen are served in the assembly hall, and the storage space is the location for the assembly hall furniture when it is not in use.

2-7.2.1.6.2 The assembly hall should also be adjacent to the arms vault and armorer; weapons are issued from the armorer, and weapons training sometimes occurs in the assembly hall.

2-7.2.1.6.3 An adjacency with the lobby should be considered; the lobby can provide the gathering and dispersal space required for large numbers of people.

2-7.2.1.6.4 The kitchen is best located at the rear of the building; the equipment and refuse associated with the kitchen should not be on a building visitor's entry path.

**Figure 2-16**  
**Assembly Hall Adjacencies**

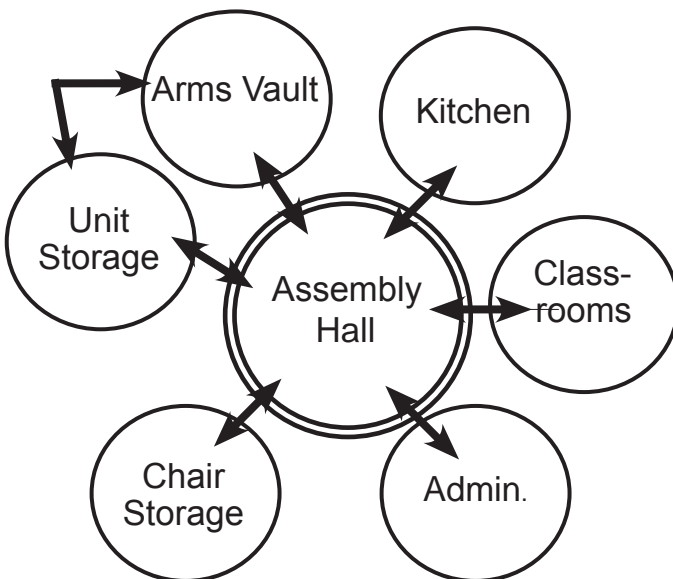

2-7.2.1.7 Weapons Adjacencies

2-7.2.1.7.1 The armorer is always located immediately adjacent to the arms vault; entry to the arms vault must be through the armorer's space for control of the weapons.

2-7.2.1.7.2 The weapons area should also be near, or open directly into, the assembly hall, as weapons training sometimes occurs in the assembly hall.

2-7.2.1.7.3 The weapons area should also be near the staging area for ease of moving all weapons onto transport for maneuvers.

2-7.2.1.7.4 The weapons area should be on a circulation route that is frequently used to provide additional security against attempted theft.

2-7.2.1.7.5 The vault should not be located on an outside wall for security reasons.

### 2-7.2.1.8 Educational Adjacencies

**2-7.2.1.8.1** The educational group of spaces is preferably located away from the administrative areas to minimize noise as soldiers come and go, and near an exit. Classrooms should be grouped together, off a single corridor if possible, and with training aids storage adjacent.

**2-7.2.1.8.2** The library reading, library storage, and learning center should be grouped together. These spaces are generally used for individual study, and need not be immediately adjacent to the classrooms.

**2-7.2.1.8.3** The COMSEC training and storage rooms should be adjacent with entry to the storage room from the training room. They should be located near the classrooms.

### 2-7.2.1.9 Storage Adjacencies

**2-7.2.1.9.1** Unit/individual storage should be located near the assembly hall, which may be used for training with or maintaining the equipment.

**2-7.2.1.9.2** Supply offices are typically located in the unit storage space, and overlooking the staging area, to provide the supply officers with visual monitoring capability of the stored materials. An exterior wall location, with a window overlooking the service drive access to the staging area is generally preferred.

**2-7.2.1.9.3** The staging area is also located in the unit storage space, with an overhead door to an exterior driveway, to allow efficient marshaling of the equipment and transfer onto transport. Some Tenants prefer a depressed loading dock arrangement outside the staging area if site conditions allow.

**Figure 2-17**  
**Janitorial and Toilets**

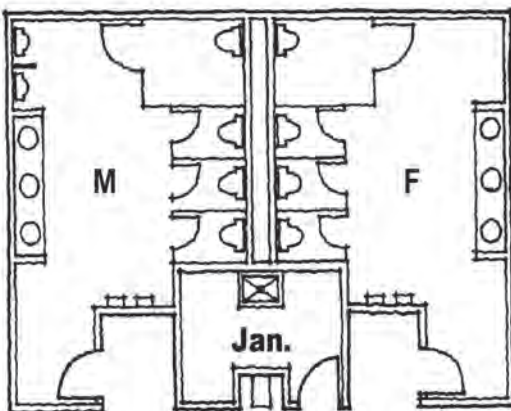

**2-7.2.1.9.4** The janitorial and facility maintenance spaces should be centrally located to be convenient for maintenance of the building, off a main corridor for easy access. In larger buildings, it is desirable to use the authorized space to create multiple rooms throughout the building for maintenance convenience. Janitorial spaces should be located near toilets, where practical, for plumbing efficiency.

**2-7.2.1.9.5** A portion of the facility maintenance space should be dedicated to recycling, with an area to sort and store recyclable materials awaiting pick up. This area should be located near an exit for easy transfer, preferably an exit that is accessible to vehicles.

**2-7.2.1.9.6** Flammable storage and controlled waste storage are not typically authorized for training center buildings collocated with an OMS. If authorized, these spaces should be on an exterior wall with only an exterior access. They should also be near a vehicle access for easy transfer to transport for delivery to and removal from the facility.

**2-7.2.1.10** Special Training Adjacencies

**2-7.2.1.10.1** Medical section, physical exam, photo lab, soils testing lab, drafting room, GCCS, and some less common special training spaces have no specific adjacencies. They should be located near the unit that has the mission they support, and some should be separated from noisier activities.

**2-7.2.1.10.2** The weapons training space now utilizes an electronic simulator, the ~~V2~~ Laser Marksmanship Training System (LMTS) ~~/2/~~, or Engagement Skills Trainer (EST) and has no specific adjacencies. The electronic weapons used can be stored in the secure storage room; they need not be in the arms vault. Weapons training could be located near the classrooms for possible occasional use as a classroom.

**2-7.2.1.10.3** The band room is often located near the assembly hall; however, the main criteria for its location is minimizing sound transmission to other parts of the building, especially to administrative and classroom areas.

**2-7.2.1.10.4** The physical readiness space should be located adjacent to toilets, showers and lockers, and remote from the main entry and formal spaces. The space should have a short route of access to the exterior, since many of the soldiers will run as part of their training – a door directly to the exterior is desirable, if practical, but should avoid the main entry path to the building.

**Figure 2-18**  
**Conference Room**

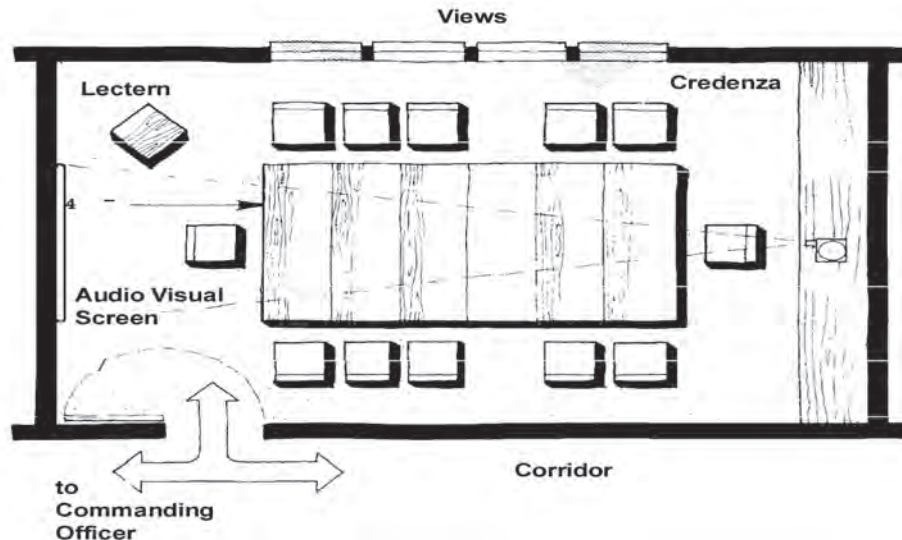



**2-7.2.1.10.5** A conference room for a training center is almost always associated with a General officer, and should be located within 50 ft (15 m) of the General's office, and adjacent to full-time staff. In most instances, it will be located within the General's suite.

### 2-7.2.1.11 Support Adjacencies

**2-7.2.1.11.1** Toilets should be centrally located for the Tenants' convenience, and toilets should be provided on each floor of multistory buildings. In larger buildings, consider splitting the space authorization not only between floors, but to provide more than one set of toilets per floor.

**2-7.2.1.11.2** Locker and shower rooms should always have a portion of the toilet space authorization located with them. The locker and shower rooms should be adjacent to the physical readiness.

**2-7.2.1.11.3** The locations of the break area and vending alcove are flexible, based on Tenant preference, but the break area should be located away from the entry, lobby and formal spaces of the facility to minimize noise and food odors transmitting to those spaces. A central location is preferable for Tenant convenience. The vending alcove is frequently collocated with the break area, but can be broken into smaller spaces to distribute vending machines throughout a larger facility.

**2-7.2.1.11.4** Mechanical, electrical and telephone rooms should be located, and distributed through the building, for efficiency of function and building distribution. The main mechanical room should be on an exterior wall with exterior access to a drive for ease of maintenance, repair, and replacement work. Architectural, mechanical and electrical disciplines must coordinate size and location of building support spaces to provide sufficient space for equipment installation, operation and maintenance, as well as efficient distribution of services.

### 2-7.3 OMS Functional Relationships

**2-7.3.1** An optimal space arrangement for an OMS would have several of the OMS spaces opening directly into the workbays. NFPA 101 no longer allows occupants from a corridor to exit through another space; any corridors must be arranged to provide the required number of exits without exiting through the maintenance bays. In addition, any corridor which leads to a maintenance bay must not exceed required dead-end distances. Larger facilities should have

**Figure 2-19**  
**OMS Schematic Diagram**

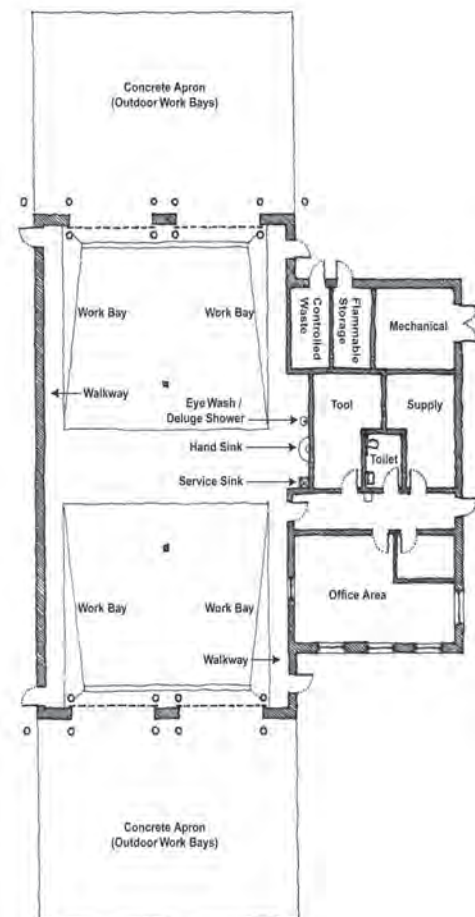

corridor arrangements similar to those shown in the Figures in this Section.

**2-7.3.2** The shop office, tools and parts storage, toilet, storage room and battery room (when authorized) are all closely associated with the workbays, and should be as nearly adjacent to them as possible.

**2-7.3.3** The shop office should overlook both the workbays and the MEP for control and security purposes.

**2-7.3.4** The flammable storage and controlled waste storage rooms must open only to the exterior of the building.

**2-7.3.5** The OMS mechanical equipment rooms authorization must also accommodate separate janitorial, electrical, telephone, and IT space requirements. The mechanical equipment rooms are best located off a corridor, and need not be adjacent to the workbays. Where climate permits, they could be accessible from the exterior of the building only.

#### 2-7.4 Unheated Storage Functional Relationships

**2-7.4.1** The unheated storage building serves only one function: the storage of operational equipment that requires no temperature or humidity control. A pre-engineered metal building system is frequently used to house this function.

#### 2-7.5 AMSA Functional Relationships

**2-7.5.1** An AMSA is very similar to an OMS, with some additional spaces added. AMSA functional relationships are also the same as those for an OMS - see Paragraph 2-7.3.

**Figure 2-20**  
**Shop Office Views**

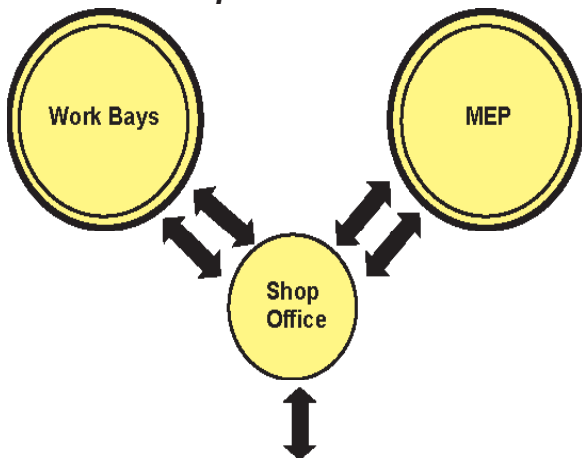

**Figure 2-21**  
**AMSA Schematic Diagram**

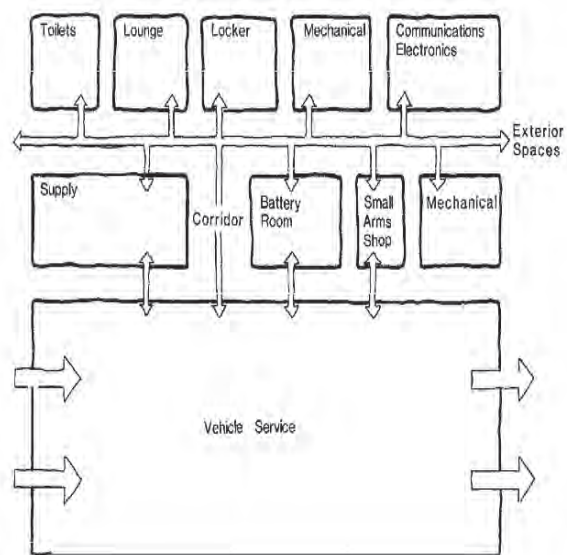

**2-7.5.2** Since an AMSA has full-time staff, a break area, and male and female toilet, shower and locker rooms are provided. They should be located adjacent to each other and need not be immediately adjacent to the workbays.

**2-7.5.3** In addition to the standard areas of an OMS, an AMSA is often authorized additional special maintenance offices, such as a supply room, an electronics/communication repair room, or a small arms repair shop and vault. All of these rooms would be best located adjacent to the workbays, if space and NFPA 101 allow. They may also be located off a corridor leading to the workbays.

## **2-8 FIRE PROTECTION/LIFE SAFETY**

**2-8.1** The primary criteria document for fire protection and life safety in USAR facilities is UFC 3-600-01: "Fire Protection Engineering For Facilities". New construction of training center, OMS, AMSA, and warehouse buildings generally includes fire sprinkler systems for protecting the occupants and building structure from fire. Unheated storage buildings are typically not covered by fire sprinkler systems, unless they are larger than 5,000 sf (465 sq m), because the value of the contents does not warrant the additional expense. The criteria for providing and designing sprinkler systems is included in UFC 3-600-01. OMS and AMSA buildings are considered to be "shops".

**2-8.2** The design criteria identified in UFC 3-600-01 must be conveyed to the contractor's sprinkler system designer on the contract documents. Note that the hose stream and remote areas for various hazard classifications are more stringent than NFPA 13 requirements. Identify design densities for water flow and sprinkler types on a room-by-room basis so hydraulic calculations may be performed. Flow test data must be provided for the contractor to determine if the cost of oversized piping will need to be included in the bid.

**2-8.3** In addition to UFC 3-600-01 other design criteria may be applicable. ETL 1110-3-446 provides thrust block design guidance. For aircraft hangar projects, ETL 1110-3-481 covers AFFF clean up requirements, ETL 1110-3-484 covers fire protection for fixed wing aircraft and ETL 1110-3-485 covers fire protection for helicopter hangars.

## **2-9 INTERIOR DESIGN**

**2-9.1** The interior environment must respond to the needs of the facility as well as the individuals who occupy it, and should be functional, esthetically pleasing, and cost effective. In addition, the interior environment should provide a humane setting to promote a sense of belonging and well-being for the personnel. The following Sections provide criteria that will be considered to meet these goals.

**2-9.2** The interior environment will be developed in coordination with the architectural design. All features of the building, including moveable furnishings and equipment, will be coordinated as parts of the overall design concept.

**Figure 2-22**  
**ARRTC VOQ,**  
**Ft. McCoy,**  
**Wisconsin**



**2-9.3** Through the planning process, the nature and configuration of the space can be examined. The adjacency requirements between the functional elements of an organization, adjacency priorities, work flow and patterns of communication will be initial considerations in the design process. Other factors will include multiple use of space and flexibility for future uses and growth. Overall, the primary goal of space planning is to convert functional program requirements into a workable, esthetically pleasing environment.

**2-9.4** Materials and finishes should not be selected for external appearance alone; they will ultimately affect the acoustical, lighting, insulating, fire rating and maintenance factors of an environment. Any selection must satisfy esthetic and functional requirements regarding durability, wearability and maintenance. To a great extent, USAR has predetermined the materials and finishes they desire. These are listed with the individual rooms in Chapter 4. Where selection options have been authorized, the above criteria will be considered.

**2-9.5** Emotional responses are, to a great extent, the product of color and its character and quality as encountered within the environment. These responses are influenced by the viewing conditions, the use of color on surrounding objects and surfaces, and the size and relationships of these factors. Color can stimulate the imagination and create, attract, and maintain interest. Handled knowledgeably, imaginatively, and wisely, it is one of the most economical, yet psychologically satisfying and successful elements of the interior environment.

**2-9.6** Specification of proper furnishings is critical to the performance and operational success of any facility. The standard criteria by which quality and appropriateness may be evaluated include function, moveability, adjustability, maintenance, durability, comfort, and cost.

## **2-10 INFORMATION TECHNOLOGY**

**2-10.1** The primary criteria document for the design of information technology areas for USAR facilities is the "Army Reserve IT Manual - Information Technology Design and Construction Guide" commonly referred to as the "Army Reserve IT Manual." This manual defines the current Army Reserve standards and requirements for new facilities and facility revitalization.

**2-10.2** A/E should determine the local telephone service provider in the area. A/E should record the company name, address, contact person, telephone number, e-mail address, and any discussions concerning service, requirements and costs. A/E should furnish a preliminary site plan with proposed telephone service conduit routing and estimated number of telephone instruments to the telephone company or local base.

**2-10.3** \3V3\3\ Underground telephone service conduit, 4 in (103 mm) diameter should be installed from the main telephone terminal board to the property line. Telephone service cable normally furnished and installed by the local telephone utility company./3/

**2-10.4** \3V3/

**2-10.5** \3V3/

**2-10.6** \3V3/

**2-10.7** \3V3/

## **2-11 SIGNAGE**

**2-11.1** The Design Agency is responsible for designing and specifying signage for the building exterior and interior. The applicable criteria for signage is UFC 3-120-01 "Air Force Sign Standard"..

**Figure 2-23**  
**USARC, Ft. Knox,**  
**Kentucky**



**2-11.2** \1\ Interior signage typically consists of a building directory, room name/numbers, directional accessibility, and similar signs./1/

**2-11.3** Exterior signage typically consists of a center monument sign, parking accessibility signs, traffic directional signs (if required), and similar signs. If the facility is on a larger Government installation, the installation may have its own guidance for exterior signs; the Design Agency should verify whether such guidance governs.

**2-11.4** \3\ The project signage will include "Minuteman" logo plaques for the project; one aluminum for the exterior and one bronze for the interior. These are Government-furnished and contractor-installed (GFCI); designer will determine locations with Tenant input. Source for the 'Minuteman' logo plaques is: US Army Corps of Engineers, Baltimore District, ATTN: CENAB-LO-S (Vickie Rohr), Baltimore, Maryland 21201 Telephone: 410-962-4395 or 410-962-7834./3/

**2-11.5** \3\ Construct exterior monument sign with concrete footing and concrete or CMU foundation. The exterior sign material design should reflect materials on the Training Center elevations. The sign should have 10 inch high (minimum) cast letters on two sides. Sign shall read "United States Army Reserve Center" or titled to reflect the occupants with the city and state. Provide cap to prevent moisture penetration and lighting on both sides. /3/



## **2-12 ACCESSIBILITY**

**2-12.1** USAR facilities must be designed to comply with the requirements of the Americans with Disabilities Act Accessibility Guidelines (ADAAG) and the Uniform Federal Accessibility Standards (UFAS), with the most stringent requirements governing. An exception to this requirement is made for OMS buildings, which are governed by UFAS only. This exception allows OMS restrooms to be designed without accessibility measures, as these facilities are assumed to be inhabited only by able-bodied soldiers.

**2-12.2** Due to the threat of terrorism, the Design Agency should pay particular care to the requirements for accessible exiting, especially those addressing areas of refuge.

## **2-13 SECURITY**

**2-13.1** The primary criteria for physical security for USAR facilities are AR 190-13, "The Army Physical Security Program," and AR 190-16 "Physical Security." AR 190-11, "Physical Security of Weapons, Ammunition and Explosives" governs the design of weapons storage spaces. The Design Agency should also coordinate its work with the USAR Installation and the Provost Marshal Office (PMO), which is responsible for the physical security of the facilities.

**2-13.2** Consideration should be given not only to securing facilities and equipment from damage or theft from the outside, but also to securing each unit's equipment within the facility. The units and soldiers are responsible for their equipment, and will want it segregated and secured from other units.

**2-13.3** Once the facility is occupied, the PMO will conduct periodic inspections to ensure that appropriate security measures are in place. The Tenants are graded on these inspections; the facility design should ensure that the physical security measures meet their needs.

**2-13.4** There is currently no general consensus on the appropriate locking system for building entries, although DoD is developing a universal card system. The USAR Installation should provide guidance on the type of locking system they prefer. If the facility is part of a larger Government installation, the installation may have its own criteria.



## CHAPTER 3

### GENERAL DESIGN CONSIDERATIONS

#### 3-1 INTRODUCTION

**3-1.1** The purpose of this Chapter is to provide the Design Agency with general information and direction on the systems and materials applicable to all USAR facilities, on the design of the site, and on the design of the various buildings. The Chapter includes some “lessons learned” by Corps of Engineers and private-sector A/E teams on previous USAR projects.

**3-1.2** The considerations in this Chapter are those which affect the site and landscaping, or an entire facility or building; for information on individual spaces, see Chapter 4. USAR building system and material preferences are also reviewed and discussed in this Chapter.

#### 3-2 CIVIL AND UTILITIES

##### 3-2.1 Grading and Drainage

###### 3-2.1.1 General

**3-2.1.1.1** Sites should be developed for positive drainage away from all building areas. Site drainage should be accomplished by sheet drainage, preferably over turf areas or other means of erosion control, especially adjacent to foundations. **3** Avoid sheet drainage over sidewalks to prevent icy conditions. **3** Use of onsite ditches and channels for conveyance of surface water will be minimized. Extremely flat sites on which it is not practical to establish sufficient elevation differences for overland drainage may require use of localized storm sewers and catch basins to convey storm water flow.

**Figure 3-1**  
**ARRTC VOQ,**  
**Ft. McCoy,**  
**Wisconsin**



**3-2.1.1.2** In general, all sites now require detention/retention of storm water to meet the standards of local or state water resources agencies responsible for regulation of surface water discharges; designs will comply with local requirements for release of storm water from the site. Government installations with a public works department may have adopted installation specific drainage requirements.

**3-2.1.1.3** **3** Balance of Cut and Fill. Site design should balance the quantity of cut and fill. Balancing cut and fill creates a more pleasing transition of the regraded areas into the natural site and minimizes the costs of hauling in additional fill or removing and disposing of extra cut. Cut disposal should be sent to a regulated or installation landfill due to liability issues with possible contamination either with the soil being disposed or of the receiving site. **3**

### 3-2.1.2 Storm Water Quality and Control

**3-2.1.2.1** The storm water runoff rate from the site should typically be held to its predeveloped rate, utilizing on-site detention or retention facilities. Surface ponds or depressions should be developed which are capable of storing, by detention or retention, the required amount of water.

**3-2.1.2.2** If the site to be developed has been acquired on the commercial market and is part of a larger overall development scheme, it may be part of a regional ponding system designed for storage of the incremental increase in runoff from the overall development. In such cases, the incremental runoff increase from the site will be verified with the local water resources regulatory agency to ensure that it is within the parameters of the regional pond design.

**Figure 3-2**  
**ARRTC VOQ,**  
**Ft. McCoy, Wisconsin**



**3-2.1.2.3** Underground or subterranean storm water detention facilities, or ponding in parking areas, are measures to be used only if space is not available for the construction of surface storage facilities.

**3-2.1.2.4** One of the sustainable design considerations recommends that the storm water plan adopted for the site results in a 25% decrease in the rate and quantity of storm water runoff, if the existing impervious area of the site is greater than 50% of the site. This would require on-site retention, not only detention, and may not be possible in all cases.

**3-2.1.2.5** Another recommended sustainable design measure is treatment systems for storm water quality to remove 80% of the average annual post-development total suspended solids and ~~2~~ 40% ~~/2/~~ of the average annual post-development total phosphorus. This is to be implemented by instituting Best Management Practices (BMPs) as outlined in EPA's "Guidance Specifying Management Measures for Sources of Nonpoint Pollution in Coastal Waters" (EPA-840-B-92-002). The design methodologies for determining percent removals are generally highly empirical and no standard universal method has been adopted for this purpose. Therefore, the local governing water resources regulatory agency or water resources department of the Government installation directorate of public works will be consulted regarding acceptable design methodologies for surface water quality treatment on developing sites. These preferred local methodologies should be implemented for site design. On some facilities, the site is not provided with a positive overland drainage outlet and additional site area may be required for development of infiltration ponds sized to accommodate the incremental increase in site runoff.

### 3-2.1.3 Temporary Measures

**3-2.1.3.1** Temporary drainage measures will be implemented to provide for erosion and sediment control according to the requirements of the National Pollutant Discharge Elimination System (NPDES) program, as implemented and enforced by the responsible

state or local agencies. Do not assume that if less than 1 acre is being disturbed that NPDES or some other permit is not required. Each state and many local agencies have requirements for erosion and sediment control; these requirements should be obtained and implemented either as part of the construction documents or as a requirement for action by the construction contractor. The designer is typically tasked with preparing preliminary permit paperwork for completion by the construction contractor.

**3-2.1.3.2** Specific temporary measures preferred by the state or local water resources regulatory agencies may need to be implemented to meet site-specific requirements. Temporary seeding and mulching of exposed areas may be required in addition to installation of specific facilities such as silt fences, sedimentation ponds, filtration beds, and riprap or slope protection. Suppression of fugitive dust from earthwork operations should also be required.

#### **3-2.1.4 Structural Features**

**3-2.1.4.1** Structural features for drainage facilities will generally be constructed of reinforced concrete, and are typically available from precast concrete suppliers local to the project area. Grates and manhole covers and frames and other appurtenances will be either a durable iron casting or galvanized steel construction according to materials and items locally available. Some sites may be located in areas where the soil and water are corrosive to concrete and metal. In this case, polyethylene or other synthetic pipe and drainage structure materials may be desirable for use.

**3-2.1.4.2** Incorporation of state Department of Transportation (DOT) or Government installation public works drainage structure details is advisable, since these are generally familiar to contractors, municipalities, and roadway agencies near the site.

**3-2.1.4.3** Structural features will be able to withstand applied vehicle loadings in their particular Government installations.

#### **3-2.2 Utilities**

##### **3-2.2.1 Sanitary Sewer**

**3-2.2.1.1** Sanitary sewers include the service pipe and structures from the building(s) to the available utility stub or connection point. The preferred pipe material for on-site sanitary sewer is PVC pipe. If extremely deep burial or heavy loads are encountered, the pipe may be installed in a steel casing or the pipe type changed to cement-lined ductile iron pipe. Sanitary sewer crossings of critical internal roadways, which should not be disturbed or open cut in the future, should be crossed using a steel casing around the sanitary sewer pipe. The pipe section and bedding should be designed to withstand the applied loads at its location.

**3-2.2.1.2** Sanitary sewer manholes will be constructed of precast concrete with cast iron covers and frames. Clean-outs will be located at bends or changes in grade on any service line. The junction of one or more service lines and the resulting downstream

sewer lateral should require a manhole.

**3-2.2.1.3** Verify the capacity requirements for conveyance and treatment for the sanitary sewer utility system to which the project is connected. In general, private or municipal utility systems will represent that the downstream pipes and sewers are in serviceable condition to meet the needs of the project; the utility company maintenance and replacement program is traditionally funded by Tenant connection charges and use fees to pay for maintenance and upgrading.

**3-2.2.1.4** On Government installations, where in-place sanitary sewer is to be incorporated into the project, it may be advisable to conduct a television inspection of the sanitary sewer to verify its serviceability for the proposed project. If the line is not in serviceable condition, its replacement or rehabilitation will be required. The Using Service and USAR Installation will determine who is responsible for that work. Government installation public works utilities may not have implemented or budgeted for sanitary sewer utility maintenance or upgrade in all areas of the installation. Verification of the sewer serviceability, and implementation and funding of repairs is required.

**3-2.2.1.5** Sanitary sewer servicing OMS/AMSA facilities and wash platform will require oil/water and grit separation. This is accomplished by installation of separate structures within the sanitary system. Coordination with the mechanical discipline is required to determine if the separator structures are to be installed within the building footprint or outside the building.

**3-2.2.1.6** Certain regions are using mechanical water and contaminant separators and the local Regional Readiness Command environmental and construction coordinators should be consulted.

### **3-2.2.2** Water Main

**3-2.2.2.1** Water mains include the on-site building services for domestic and fire protection purposes from the building(s) to the water main system stub or connection point. Interior looping of the system for fire protection may be desirable.

**3-2.2.2.2** Water main sizing for fire protection purposes will be based upon flow and pressure requirements for on-site hydrants and building fire suppression systems. It is recommended that the fire protection main be no smaller than 8 in (200 mm) diameter, and the standard hydrant lead no smaller than 6 in (150 mm) diameter. On-site water storage reservoirs and/or fire booster pumps may be required for sites located in areas of low system pressure.

**3-2.2.2.3** Verify with local fire protection, utility and building officials whether independent domestic and fire feeds external to the building are required, or if a single feed can be separated inside the building. The requirements for indicator valves will be verified with local building and fire protection officials, or with Government installation fire departments and public works directorate.

**3-2.2.2.4** In general, on-site fire protection and water supply system valves, hydrant spacing, and sizing shall be in accordance with UFC 3-600-01. Preferred water main pipe materials are corrosion-resistant materials such as PVC pipe, or ductile iron pipe with corrosion protection and cathodic protection, if required. Pipe sections and bedding shall be designed to withstand applied loads. Crossings of critical internal roadways, which should not be disturbed or open cut in the future, will utilize a casing around the underlying utility pipe.

**3-2.2.2.5** Fire hydrant flow tests on the supplying water utility system should be conducted at the earliest practical date to determine pressures available to the project site, and whether a fire pump will be required. Many water utilities are no longer willing to release their own internal hydrant flow data due to liability concerns. In such cases, contracting with a local fire protection company or consulting engineer to conduct flow tests may be required.

**3-2.2.2.6** Coordinate with the water utility to determine meter type and installation. \3\ UFC 3-400-01 requires the utilities to be monitored through connection to a base wide energy and utility monitoring and control system directly or via the building HVAC control system, this may require installing a meter separate from the billing meter./3/

### **3-2.2.3 Natural Gas**

**3-2.2.3.1** The gas utilities consist of the internal gas distribution and service pipes and controls servicing the site from the building(s) to the gas utility connection point. The gas utility service industry is competitive in certain service location areas and more than one source of service may be available.

**3-2.2.3.2** Gas companies normally provide some amount of service line and meter set at no charge, especially when the projected volume of gas use and resultant utility charges will justify the expenditure. Furnish estimated gas service requirements to the utility and request they examine the construction requirements and demand of the site to make a cost determination for any construction of service for the site. If longer on-site service lines are required, verify whether they are to be constructed by the utility or as part of the construction contract, and ensure that any charges to be paid to the utility are included in the contractor's requirements.

**3-2.2.3.3** \3\ UFC 3-400-01 requires the utilities to be monitored through connection to a base wide energy and utility monitoring and control system directly or via the building HVAC control system, this may require installing a meter separate from the billing meter./3/

**3-2.2.3.4** Many of the Government installation gas systems have been privatized; service and connection procedures are normally the same as the commercial market.

### **3-2.2.4 Other Utilities**

**3-2.2.4.1** Projects on Government installations may have access to a district heating



system.

**3-2.2.4.2** See Section 3-10 below for telecommunications and electric utilities.

### **3-2.3** Roads and Pavements

#### **3-2.3.1** Pavement Types

**Figure 3-3**  
**USARC, Camp**  
**Parks, California**



**3-2.3.1.1** The primary pavements and surfacings for USAR sites are asphalt concrete (AC or bituminous), Portland cement concrete (PCC), and aggregate. AC is normally used for POV and MEP areas. In most areas, AC will be cheaper than PCC; however, some areas may have supply or quality control issues that favor PCC; this should be investigated for each site.

**3-2.3.1.2** Tracked vehicle parking and maneuvering areas will require PCC or aggregate surfacing. Areas of high turnover of heavy equipment vehicle parking, or of concentrated vehicle turning movements and maneuvering, should receive PCC. **3** Tracked vehicle maneuvering areas include the vehicle path from the tracked vehicle parking pad location to the repair building apron. **3**

**3-2.3.1.3** Other areas that normally require PCC are aprons for OMS/AMSA/DS/GS buildings, wash platforms, fueling platforms, loading dock parking and drives, and dumpster pad/pickup zones. Some access approaches, and heavily used drives or streets, may merit consideration for PCC paving. **3** **3**

**3-2.3.1.4** It is recommended to adapt pavement specifications to the state's Department of Transportation (DOT) Standard Specifications for Roadway Construction. Local pavement materials suppliers and paving contractors are likely to have state DOT certifications for material sources, screen plants, batch plants, transporters, and pavers used for pavement material production and placement.

**3-2.3.1.5** AC pavement mixes should be relatively stiff to prevent wheel rutting or surface raveling during heavy use and periods of high temperatures. The state DOT highway mixes should address this situation. In some cases, the stiffer mix may have a coarser surface finish, but its strength and serviceability advantages are preferred.

**3-2.3.1.6** Pavements or aggregate surfacing may require subgrade improvement measures to limit rutting or breakup over softer subgrades. Soil replacement is the preferred subgrade improvement option, but geotextiles should be considered where the improvement excavation would be deep or the area of needed improvement extensive. Obtain the recommendations of a local geotechnical engineer or the Government installation public works department.

**3-2.3.1.7** Use of recycled aggregates for base materials and pavement mix aggregates should be allowed as a recycling/sustainable design measure. State DOT specification provisions for recycled aggregate should be reviewed for restrictions or limitations on



use.

**3-2.3.1.8** Provide painted striping in POV and MEP areas, and elsewhere as needed.

**3-2.3.2** Curb and Gutter

**3-2.3.2.1** Use of curb and gutter is normally minimized for drainage, grading, and maintenance reasons. However, use of curb and gutter may be desired to channel traffic flow at access points, critical on-site intersections, or in areas in which vehicle traffic needs to be strictly separated from pedestrian traffic or parking areas. Curb and gutter are often used to define the more public or administrative areas of a facility (training center) or to protect landscaping.

**3-2.3.2.2** In areas where a number of adjacent accessible parking spaces are provided, the designer should consider use of a “ribbon” type or flat curb at these accessible parking spaces, so that multiple curb ramps are eliminated. This will eliminate repetitive dips and rises in the sidewalk.

**3-2.3.2.3** Any curb and gutter should be constructed of concrete. Integral curb and gutter is strongly preferred where drainage is being conveyed along the gutter. Curb-only sections may be used where drainage is directed away from the curb. Where substantial lengths of sidewalk are located along the back of the curb, consideration should be given to using an integral sidewalk/curb section.

**3-2.3.3** Sidewalks and Aprons

**3-2.3.3.1** Sidewalks will be provided from all building entrances to the POV and MEP areas; sidewalks in the parking areas should be avoided. Sidewalks should also be provided along natural paths through unpaved areas.

**3-2.3.3.2** Sidewalks and aprons should be constructed of concrete, and should be of widths to comfortably accommodate anticipated traffic. Sidewalks immediately behind a curb at a parking area shall accommodate vehicle bumper overhang if wheel stops are not provided.

**3-2.3.3.3** Sidewalk finishes should be coordinated with architectural and landscape design for special joint patterns, finishes and colors. The typical sidewalk finish should be a lightly broomed texture.

**3-2.3.3.4** Special pedestrian or ramp details and finishes should be detailed on the construction drawings. Pedestrian ramp details utilized by municipalities or Government installation public works departments may be utilized for consistent appearance or for ease of construction.

**3-2.3.3.5** Aprons should be sized to allow parking of at least one vehicle; the apron size will depend upon the typical vehicles for the location. Aprons at loading docks, dumpster pads and wash bay platforms shall be sized to incorporate the areas in which

concentrated wheel turning movements of heavy vehicles or trucks occur and where heavy wheel loads repeatedly occur. Aprons outside maintenance shops workbays must be concrete, and 36 feet (11 meters) long.

### **3-2.3.4 Additional Paving Considerations**

**3-2.3.4.1** Some recommended sustainable design measures are intended to reduce heat islands, including use of light-colored materials for impervious surfaces, or open grid pavement systems. Open grid modular paving units are available on the commercial market and may be investigated for use, but the availability and cost of these systems may vary widely based on locale. Practicality and serviceability of this type of system in snow areas should be carefully considered.

**3-2.3.4.2** Special aggregates, toppings and coatings other than typical maintenance items (seal coatings, sealers) may be considered, but these may have high initial or maintenance costs. PCC is light in color, but usually introduces a substantial cost increase over AC pavement. Alternate pavement design, such as “resin modified pavement” may be used in special cases if, cost control and quality control parameters can be achieved. Resin modified pavement is suitable for fuel resistance on aprons that are nearly flat. Machine finished pavement is slick when wet.

## **3-2.4 Civil Layout**

### **3-2.4.1 Roadway Geometrics**

**3-2.4.1.1** Turning radii and needed traffic clearances should be checked for adherence to the AT/FP requirements for spacing and setbacks at buildings. Consideration in design should also be given to the using vehicles from off-site sources, such as delivery trucks and maintenance or service vehicles.

**3-2.4.1.2** Geometrics at the access drive will need to be coordinated with the agency responsible for the public or Government installation roadway which is being accessed. If off-site roadway improvements for access are needed, the geometrics will need to comply with the design standards of the responsible roadway agency.

**3-2.4.1.3** Geometrics may be used to channel truck traffic away from POV parking areas by installing openings and radii suitable only for the POV traffic. One-way traffic and corresponding roadway geometry may be used to strictly control traffic patterns on some sites.

### **3-2.4.2 Slopes and Setbacks**

**3-2.4.2.1** Slopes will promote positive drainage and maintainable surfaces for landscape features. If landscaped area slopes approach 2.5 horizontal to 1.0 vertical, consideration should be given to use of low retaining walls (modular concrete wall systems are efficient for low walls of limited lengths).

**Figure 3-4**  
**USARC, Camp**  
**Parks, California**



**3-2.4.2.2** Typical state DOT roadway slope design limitations should be met with consideration for parking and maneuvering requirements of military equipment. Much of the military equipment may be classified as all-terrain, but one of the purposes of MEP and OMS/AMSA facilities is to provide for ease of parking and maneuvering for maintenance purposes or loading for transport.

**3-2.4.2.3** Setbacks shall meet AT/FP requirements and conform, if practical, to local zoning requirements or Government installation design guidance in order to be compatible with neighboring facilities and uses.

### **3-2.4.3 Utility Clearances**

**3-2.4.3.1** Utility clearances shall provide for safe long-term operation and maintenance of utilities, prevent interference of one utility with another, and meet public health or safety requirements, such as minimum separation of sanitary sewers and water mains. Special designs, such as pipe encasement, insulation or isolation may be required where utilities are closer. This may occur on sites containing in-place utilities that cannot be feasibly relocated.

**3-2.4.3.2** Utility companies should be contacted for special requirements for utility separation beyond typical design values.

### **3-2.4.4 Driveway and Parking Layouts**

**3-2.4.4.1** POV parking should be arranged to minimize pedestrian traffic through rows of parked cars. The authorized area for POV parking is normally calculated to provide spaces for a maximum of 80% of Tenants on the largest drill weekend at an allowance of 3 SY (29.3 sq m) per space. Layouts must be efficient to provide the desired number of parking spaces, and 90 degree parking is preferred to 45 or 60 degree parking, unless site restraints dictate angled parking. ~~13~~ Spaces for motorcycle parking should be considered, these spaces require concrete pavement with appropriate signage and marking. ~~13~~

**3-2.4.4.2** MEP parking may be more efficiently accommodated with a 45 or 60 degree angled parking layout due to the size of some vehicles, and the variations in sizes among the vehicles. Designer should review parking layouts with Tenants to optimize parking and maneuvering. The MEP area is based on an authorization of 50 sy (41.8 sq m) per vehicle, and generally is provided for 60% of the unit vehicles, or 10% of the vehicles supported by an AMSA. Therefore, the authorized MEP area will not typically accommodate all of the Tenants' vehicles, and some will be stored at an ECS.

**3-2.4.4.3** At vehicle access driveways to kitchen, unit storage, mechanical, workbays, and similar spaces, AT/FP requirements dictate that a removable physical barrier be provided. This can be accomplished with gates, removable bollards, large chains between bollards, or similar devices. All such barriers must include locking provisions. Review with Tenants, USAR Installation and Provost Marshal.

### **3-2.5 Fencing**

**3-2.5.1** Chainlink or other security fencing is always provided around the MEP area, and may be approved by the Using Service for other areas. If the budget allows, consider fencing to match the surrounding architectural character. Also consider fencing attractive nuisances such as ponding areas that will hold stormwater for appreciable lengths of time; such fencing does not necessarily have to meet physical security requirements for security fencing. Most Tenants prefer that fences are located in a strip of rock mulch or similar surfacing to avoid the need to maintain grass or plantings along the fence line.

**3-2.5.2** The standard chainlink security fence is a minimum of 7 ft (2140 mm in height, with 6 ft (1830 mm) of fence and three strands of barbed wire totaling 1 ft (310 mm) above, sloped outboard. Fences of other materials providing similar security may be considered, but should be reviewed with USAR Installation security personnel to verify they meet physical security criteria. The maximum allowable distance from hard ground to bottom of fence is 2 in (50 mm). A “clear” area along both sides of the fence is typically required; this area generally extends for 10 feet (3 meters) on each side of the fence, but the distance should be verified with USAR Installation personnel.

**3-2.5.3** Vehicle gates may be swinging or rolling, based on Tenant preference, but rolling gates must maintain the maximum height above ground. It may be necessary to incorporate a “speed bump” at the gate in order to ensure the bottom of the gate does not exceed the maximum height above the paving. Powered gates are not normally provided.

**3-2.5.4** Fences must be electrically grounded.

### **3-2.6 Wash Bays**

**3-2.6.1** Wash bays for military equipment may be authorized in the project documents, or requested by the Tenants for ACSIM-ODR approval.

**3-2.6.2** In northern locations, wash bays will normally be located within an OMS, AMSA, or DS/GS building. No additional bays will be authorized due to cost, so one or more bays must be able to be separated from the others with retractable curtains. Provide wet service electrical systems in such bays.

**3-2.6.3** In warmer climates, wash bays will normally be exterior to the maintenance building. In such cases, the designer must address collection/treatment of gray water and prevention of stormwater entry to sanitary sewers. **3** Local EPA criteria must be complied with and could require solutions varying from a roofed structure, to a roofed structure with walls along the long axis or ultimately to a fully enclosed structure.**3**

**3-2.6.4** A concrete pad will be provided at exterior wash bays, and containment curbs or depression of the slab should be provided to control gray water. **3**/**3**

**3-2.6.5** The designer should verify whether any package pressure or heating wash system will be Tenant-supplied or a part of the construction contract. If such a system is portable, it will be necessary to provide sufficient storage space to accommodate it in the maintenance shop. The designer will verify that sufficient power is provided for such systems.

**3-2.6.6** Consideration should be given to recycling of gray water, possibly with a package system. Cost, sustainable design goals, and water availability will be factors in the consideration. If provided, a heated building for the equipment will be provided where climate requires.

**3-2.6.7** \3\ The facility should be provided with an electrical service receptacle in appropriate waterproof NEMA device on each side of the wash bay to support miscellaneous electrical requirements beyond the pressure washer. The interior of the facility shall also be lit to support low light periods, evenly distribute the light to establish a minimum of 40 fc, place fixtures such that sides, front and back of the vehicles are illuminated. All electrical systems should be designed for wet service./3/

**3-2.6.8** \3\ Water provided to exterior wash bays shall be provided by freeze proof fixtures. Investigate placement of work bay facility near heated facilities to increase ability to provide hot and cold water to support the cleaning operation minimizing water line freezing. Where freeze proof yard hydrants with drain holes are provided the water piping supplying these fixtures must be protected with a backflow device, the vacuum breaker on the hydrant is insufficient protection./3/

### **3-2.7** Loading Ramps

**3-2.7.1** Loading ramps for military equipment may be authorized in the project documents, or requested by the Tenants for ACSIM-ODR approval. If so, COE has a standard design for a bi-level loading ramp that designers may wish to obtain.

**3-2.7.2** Loading ramps should be adjacent to or within an MEP. Sufficient maneuvering room must be provided for both transport and loading vehicles. The necessary amount of paving may not be part of the project paving authorization or construction budget; these additional costs must be identified and approved by the Using Service.

**3-2.7.3** If tracked vehicles are to be loaded, the design must provide for concrete or aggregate approaches and circulation paths to appropriate roads or parking areas.

### **3-2.8** \3\ MKT and CK Pads

**3-2.8.1** Mobile Kitchen Trailer (MKT) pads are reinforced 30 ft by 30 ft pad with a brushed finish. Provide connection for electrical support of the mobile kitchen. Coordinate pad location with Training Center kitchen. MKT pad may be located within the unobstructed space since the MKT is used during drill times then returned for storage in the MEP. Waste and potable water requirements of the MKT can be handled



by the Training Center Kitchen's can wash.

**3-2.8.2** Containerized Kitchen (CK) are not currently being deployed within the Army Reserve. If a facility receives a CK, questions should be addressed directly to the Louisville District Army Reserve Support Team Technical Staff for resolution./3/

### **3-3 LANDSCAPE ARCHITECTURE**

**3-3.1** Quality planning and design are the basis for landscape architectural improvements that reinforce the vision, character, theme, and functional requirements of site design. Environmental conditions, sustainable design, historical context and aspects of conservation can influence the selection of materials and the design of a site.

**3-3.2** Landscape design and materials must reflect an understanding of the guidelines outlined in the Department of Defense's most recent Force Protection/Antiterrorism manual. Selection of deciduous, coniferous and/or herbaceous trees, shrubs, and ground covers must be responsive to aspects of maintenance, xeriscape/irrigation concerns, year-round color and visual impact, simplicity of design and value-added benefits to be derived by landscape installation.

**Figure 3-5**  
**USARC,**  
**Sacramento,**  
**California**



**3-3.3** Appropriate planting design incorporates landscapes that positively modify microclimatic conditions, provides habitat for wildlife where desirable and deters unwanted fauna when appropriate. Plant material selection depends upon as found soils, plant communities and hydrological conditions. Whenever possible, efforts should be made to incorporate resource management practices, to preserve existing stands of mature landscape, and to utilize indigenous plantings and native grasses.

**3-3.4** Site furnishings and related amenities need to address issues of vandal resistance, minimal maintenance, and handicapped accessibility, and should be coordinated in a manner that reflects the architecture and context in which the facility is situated. While not all-inclusive, the following site components may be considered to complement landscaping when designing outdoor spaces: facility sign, flagpoles, tables and chairs for outdoor dining, benches, trash receptacles, ash urns, bike racks, bollard posts, tree grates, appropriate mulches, fencing and trash enclosures for screening, shelters, and specialty paving surfaces for accent and focus.

**3-3.5** At a minimum, lighting should be incorporated at all facilities for functional and safety/security purposes. Lighting may be building-mounted, pole-mounted or ground-mounted. Lamps for accent, ornamentation and focus, when considered, must accommodate a consistent visual character, be vandal resistant, and require minimal maintenance.

**3-3.6** Signage supported by site furnishings, plant materials and lighting provides both immediate and subtle references to reinforce aspects of wayfinding at a facility.



Signs serve informational, interpretive, directional, and regulatory purposes. Visual consistency, scale and clarity of organization promote a comprehensive esthetic at main entry gates, facility and building entries, parking lots and along paths and roadways.

**3-3.7** Utilities and infrastructure required for support of the landscape include subsurface drainage to control hydrological aspects, water lines to address irrigation mechanical systems needs, and gas and electrical lines to supply power to site amenities that may be incorporated as part of a comprehensive site improvement package.

## **3-4 FIRE PROTECTION / LIFE SAFETY**

### **3-4.1 General**

**3-4.1.1** Fire protection and life safety are paramount in the design of USAR facilities. Consideration should be given to exceeding minimum requirements in certain instances. For instance, NFPA 101 allows some exit corridors in fully-sprinkled buildings to be built without one-hour ratings; the designer may wish to provide one-hour corridors based on the size of the building, number of occupants, and ease of exit.

**3-4.1.2** In order for a facility to be occupied by Department of Defense personnel, the design and construction must meet specific requirements. The Government's primary guidance on building codes, fire protection and life safety is UFC 1-200-01. Design and construction of USAR real property improvements shall comply with UFC 1-200-01, and shall comply with the specific applicable requirements of IBC, NFPA 101, UFC 3-600-01 and other codes and standards that are referenced in UFC 1-200-01.

**3-4.1.3** Some State and local code and regulatory agencies may not have jurisdiction over Federal Government construction on Federal Property. However, the USAR wishes to comply with State and local codes and regulations, and the Exchange Partner remains responsible for such compliance. Therefore, design and construction of USAR real property improvements shall also comply with all current and applicable State and local codes, and with all other applicable laws and regulations governing developments, design and construction at the site. If certain of such requirements appear particularly onerous, or hamper Army Reserve required functionality of the project, the Exchange Partner may recommend the Government waive the requirement or implement a lesser requirement. The Government's approval of such recommendations is not assured.

**3-4.1.4** Where any of the applicable requirements conflict, the most stringent shall govern. In no case shall building code, fire protection and life safety requirements be reduced below those required in UFC 1-200-01 and this document.

**3-4.1.5** A comprehensive code analysis and drawing showing all fire protection features is required for all USAR construction projects. The Design Agency shall give a standardized format for completing and certifying the analysis and presentation of fire protection and life safety features. When completing third party projects the content of the analysis will include an analysis and drawing that provides the following information:

- Type of occupancy.
- Type of construction.
- Location of fire-rated walls, doors and dampers, including those for hazardous areas.
- Exit travel distances.
- Horizontal exits.
- Exit signs and emergency lights.
- Occupant load/exit unit widths.
- Automatic extinguisher systems.
- Fire detection/alarm devices.
- Sprinklered areas (as appropriate)

**3-4.1.6** Fire extinguishers shall be provided per UFC 3-600-01 - which states to follow NFPA 101 and NFPA 10. A fire extinguisher is also required in arms vaults per paragraph 4-2.12.9. Per NFPA 10 maximum travel distance to an extinguisher is 75 feet.

**3-4.1.7** If a facility authorization includes a SCIF, the SCIF will have a single controlled point of entry, most likely with an electronic lock. If necessary, a separate exit (or exits if two are required) can be provided to satisfy life safety/exiting requirements. The USAR security personnel will want any such exits to include an audible alarm, and possibly a short delay, for security reasons. No hardware should be provided on the exterior side of such exit doors.

### **3-4.2** Fire Sprinkler System

**3-4.2.1** Fire sprinkler system design for USAR projects is normally accomplished through a performance specification, with the contractor's design engineer responsible for a detailed system design. The design criteria identified in UFC 3-600-01 must be conveyed to the contractor's designer in the contract documents. Note that the hose stream and design areas for various hazard classifications are more stringent than NFPA 13 requirements.

**3-4.2.2** Identify design densities for water flow and sprinkler types on a room-by-room basis so hydraulic calculations may be performed. Flow test data must be provided for the contractor to determine if the cost of oversized piping will need to be included in the bid.

**3-4.2.3** UFC 3-600-01 requires that every portion of a sprinkled building be sprinkled; it does not allow exceptions for computer or electrical rooms, or arms vaults.

### **3-4.3** Fire Alarm System

**3-4.3.1** An addressable Class B fire alarm system will be provided, consisting of manual ~~13~~ dual action ~~13~~ stations at exits, combination horn/visual signals located in accordance with ADA requirements, duct smoke detectors in air-handling units as required by code, and magnetic hold-open devices with smoke detectors for corridor fire doors. The system should be addressable, zoned, non-coded and fully supervised.

**3-4.3.2** A fire alarm riser diagram will be provided in the construction documents. The control panel should be fed from a panelboard to provide 120V, 1-phase, 2-wire plus ground to the control panel. The breaker to the Fire Alarm circuit shall be red and have a locking device.

**3-4.3.3** A remote annunciator panel should be installed at an entrance designated by the Tenant ~~13~~ and per NFPA 72 paragraph 4.4.6. ~~13~~

**3-4.3.4** Any kitchen equipment below hoods must be shut down upon activation of the kitchen fire suppression system per NFPA 96.

**3-4.3.5** Photoelectric smoke detectors are not required in sprinklered facilities; however they should be included in electrical, telephone and network/IT rooms as a result of customer specific needs.

**3-4.3.6** All water flow switches, tamper switches and post indicator valves should be connected to the fire alarm panel.

**3-4.3.7** ~~12~~ Audible requirements shall meet NFPA 72 paragraph 7.4. ~~12~~

**3-4.3.8** All conduits for fire alarm system should be 1/2 inch (16 mm) minimum.

**3-4.3.9** Remote station signal transmitter should be provided with a digital alarm communicator capable of transmitting alarm and trouble signals over telephone lines (telephone dialer) or radio transmitter to a remote security monitoring stations/base fire department. Verification of current practices for fire alarm signal monitoring at the existing base/site is necessary.

**3-4.3.10** ~~13~~~~1~~ Mass Notification Systems in Military Construction Projects. To reduce the risk of mass casualties, there must be a timely means to notify building occupants of threats and what should be done in response to those threats. Mass notification is defined as the capability to provide real-time information to all building occupants, or personnel in the immediate vicinity of a building, during emergency situations. See UFC 4-010-01 ~~11~~ and UFC 4-021-01. ~~13~~

## **3-5 ARCHITECTURAL**

### **3-5.1 USAR Approved Systems and Materials**

**3-5.1.1** The USAR, through the development of its projects, has established some preferred systems and materials for the design and construction of USAR facilities. When practical, USAR preference is that these systems and materials be used for all USAR facilities. Recommendations for departures from these systems and materials should be reviewed with the Using Service.

**Figure 3-6**  
**AFRC, Greenville,**  
**North Carolina**



**3-5.1.2** The preferred exterior wall construction is an insulated cavity wall of brick or CMU veneer with masonry, ~~insulated concrete form,~~ or steel stud backup. ~~The interior finish of the exterior wall will be gypsum board over furring or steel studs in finished spaces, and painted CMU in more utilitarian areas.~~

**3-5.1.3** Preferred exterior doors are hollow metal in hollow metal frames, with aluminum doors in aluminum storefront systems for major entries. Exterior windows should be steel or aluminum frame units, or storefront assemblies where large areas of glazing are desired.

**3-5.1.4** The preferred roof construction is a sloped standing seam metal roof or 50 year shingle except at the kitchen, where a low-slope (“flat”) roof better accommodates the kitchen equipment rooftop penetrations and equipment. See guidance on standing seam metal roof systems (SSMRS) and 50 year shingle in [Appendix K](#). Low slope roofs are an acceptable design solution when the Using Agency and USAR Installation approve, or where budget limitations dictate. Modified bitumen or single-ply membrane roofing will be used for low-slope roofs.

**3-5.1.5** Preferred interior walls are steel stud with gypsum board for spaces where a more pleasant finish is desired, or CMU. CMU walls may be GMU or painted CMU. Consideration should be given to space function and volume of traffic; in high traffic areas and areas where wear and tear can be anticipated, it may be desirable to use GMU if a nicer finish is desired. It may be helpful to consider wear and tear in an USAR training center to be similar to that anticipated in a high school or college building, and use in an OMS to be similar to a repair garage.

**3-5.1.6** Interior doors should be either solid-core wood or hollow metal in hollow metal frames. Offices and similar spaces with higher levels of finish should receive wood doors; more utilitarian areas can utilize hollow metal doors. The arms vault door must be a ~~GSA approved Class 5-A vault~~ door. Doors must have a minimum clear opening of 3 feet (900 mm) in width.

**3-5.1.7** Most spaces with ceilings will be suspended acoustical tile; the USAR preference is for 24 inch by 24 inch (600 mm by 600 mm) tiles to avoid sagging of tiles. Areas where higher humidity is anticipated should receive a suspended gypsum board ceiling. Ceilings for kitchen and shower areas will be suspended cement board with water resistant skim coat.

**3-5.1.8** In general, the materials and methods of construction proposed for use on USAR facilities should be of high quality and will have been used (preferably by the Design Agency) in several projects which can be researched to ascertain the product’s performance characteristics. Materials, as well as the design, should be of good quality and able to stand the test of time.

## **3-5.2** Image/Esthetics

**3-5.2.1** Both the exterior and the interior image of USAR facilities should reflect

military values, such as dignity, tradition, discipline and order. At the same time, they should provide the Tenants a functional and comfortable workplace, and an atmosphere which will promote feelings of pride and ownership.

**3-5.2.2** The USAR is seeking a level of standardization in their built facilities, but are not seeking “cookie-cutter” design solutions. Many of the spaces and features of the facilities will be the same throughout the USAR system, and design efficiencies can be gained through reuse of standard space modules or groupings. However, the Design Agency should seek to give each project its own identity, based on Tenant input and local/regional influences.

**3-5.2.3** The level of finish and detail in a training center should be one that would be appropriate for an office building of good quality, with additional emphasis on durability and maintainability. For an OMS or AMSA building, finish and detail can be more utilitarian in the maintenance areas, but similar to a training center in the office areas.

**3-5.2.4** Each USAR facility will have two “Minuteman” plaques, one for exterior display and one for interior display; the exterior plaque should be located with the “U.S. Army Reserve Training Center” signage. These should be in locations of maximum visibility. Consideration should be given to developing high-visibility locations for the Tenants to display their trophies and other memorabilia. In centers housing more than one unit, individual locations may be appropriate.

**3-5.2.5** Consider protective continuous bumper moldings and corner guards for corridors and other high traffic areas to minimize damage to walls. The continuous bumpers when required should be mounted at base height.

### **3-5.3** Room Numbering

**3-5.3.1** The Design Agency should work with the USAR Installation to develop a room numbering scheme for the construction documents that will also be functional for the later operation and maintenance of the facility.

**3-5.3.2** Consider numbering larger buildings by wings, i.e., S104, W236. Consider using letters, rather than numbers, for stairs, corridors and similar spaces; the Tenants and maintenance personnel rarely think of these spaces as rooms, and giving them room numbers can be confusing.

### **3-5.4** Stairs and Elevators

**3-5.4.1** Typical stairs are concrete-filled metal pan construction, unless a monumental stair is part of the design. USAR prefers wire mesh infill panels for open stair and landing rails. All stairs, including fire stairs, should be nicely detailed and finished, in keeping with finishes in the rest of the project.

**3-5.4.2** Elevators should meet accessibility requirements, and elevator hooks and pads should be specified for occasional moving of furniture. \3\ Elevators should be a



**Figure 3-7**  
**ARRTC VOQ,**  
**Ft. McCoy,**  
**Wisconsin**



minimum of 2,000 pound (900 Kg) loading capacity./3/

**3-5.4.3** Elevator Power Supply: Refer to Section 3-10 below.

**3-5.5** Doors and Windows

**3-5.5.1** Windows should be located where functionally appropriate and as an element of sustainable design for daylighting purposes. Consider the use of operable windows, with screens, for administrative and similar areas, for sustainable design reasons and to provide ventilation flexibility. Provide blinds or exterior shading to minimize glare.

**3-5.5.2** Daylighting strategies should be considered for the unit or administrative common areas, corridors, assembly hall, lobby, workbays and unit storage area. Due to security concerns, unit storage daylighting may require clerestory glazing or glazed block.

**3-5.5.3** Coordinate with the USAR Installation to develop appropriate door hardware and keying. There are security restrictions prohibiting master key systems; the designer should review keying requirements with USAR Installation security personnel. Weapons areas, storage areas, and secure spaces, at a minimum, will not be part of any master key system.

**3-5.5.4** Doors in office and similar administrative or educational areas are typically solid-core wood; doors in more utilitarian areas may be hollow metal. Doors to administrative areas may have lights or sidelights for sustainable design purposes, and to provide visibility for the Tenants and a view into the space from the corridors. Doors to individual offices should not require closers or kickplates.

**3-5.6** Caging and Shelving

**3-5.6.1** Woven welded wire fabric cages are generally required in storage areas such as unit storage, arms vault, tools storage, parts storage and unheated storage buildings to provide individual units the ability to secure their equipment. 13 The partitions will be 10-gauge steel wire, 1 in by 2 in (25 mm by 50 mm) woven mesh welded to a steel frame.3/ Framing should be provided at structural steel, pipes, ducts and other obstructions running through the partition to provide security and to prevent intrusion

**3-5.6.2** The Tenants may wish to combine one or more typical cages into a larger cage, or simply provide one or more large caged areas depending on their equipment storage needs.

**3-5.6.3** The typical size of a unit storage cage is 12 8 ft by 12 ft - 2 in (2400 mm by 3650 mm).2/ Doors may be 12 single swing, or bi-parting2/, providing a minimum clear opening in one of the narrow ends of the cage of 13 4 ft by 7 ft (1200 mm by 2100 mm) 3/. 12 The minimum height of the cage is 9 ft (2700 mm) with a woven wire fabric



ceiling. If it is more economical or practical, extend the height of the cage to the roof deck or floor slab above. If ceilings are provided, insure that shelving units will fit both horizontally and vertically. /2/

**3-5.6.4** Cages for arms vault, tools and parts storage and other storage areas may be the same /2/ 8 ft by 12 ft - 2 in (2400 mm by 3650 mm) /2/ module as the basic unit storage cage, or may be tailored to the Tenants' requirements. /3/ The only difference is that arms vault doors are 3 ft by 7 ft (900 mm by 2100 mm)./3/

**3-5.6.5** Security is a key element of the design of cages. The cage frames should be no more than 1 in (25 mm) from the floor /2/ and no more than 2 in (50 mm) from walls or ceilings /2/. /3/ All bolted cage frame connectors should be made with tamperproof hardware in lieu of peening or tack welding in place./3/ Doors should fit tightly in their frames and where they meet. Doors shall be provided with two padlock hasps; the padlocks should be specified with other door hardware. Swinging doors padlock hasps shall be provided at third points /3V3/. Doors for vault cages shall be of the swinging type only. Some Tenants prefer a few cages with Dutch doors; security personnel may think these require six padlocks. No opening in caging or a caged area shall exceed 96 sq in (60,000 sq mm); the least dimension shall not exceed 150 mm (6 in). This includes spaces in the building structure when the caging is extended to the structure, including web spaces of bar joists.

**3-5.6.6** Shelving for the unit storage caged areas is heavy-duty open steel shelving units with five adjustable shelves. The units are typically 4 ft wide by 2 ft deep by 7 ft tall (1200 mm wide, 600 mm deep and 2100 mm tall). Shelving for maintenance shop tool and parts storage cages is the same width and height, but 18 in (450 mm) deep. The units may be wider than their nominal width, and the Design Agency must ensure that the typical cages are of sufficient size to accommodate three shelving units end to end. A minimum of 6 units per typical cage is normally provided, 3 along each side, but Tenants should be asked for their shelving layout preference.

**Figure 3-8**  
**Duffel Bag Cage Layout**

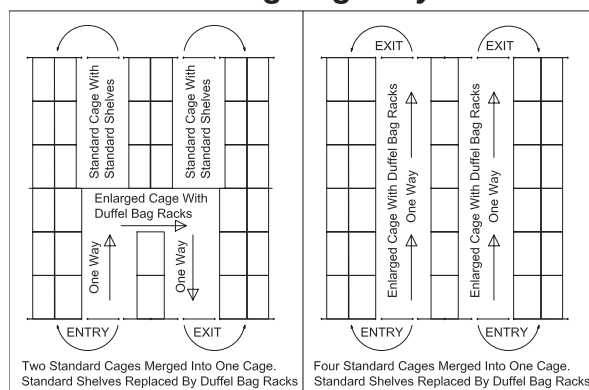

**3-5.6.7** Some units require space for duffel bag storage in the unit storage area. Duffel bag shelving is /2/ 32 in deep by 48 in long (800 mm deep by 1200 mm long) with 6 shelves evenly spaces at a minimum of 14 -1/2" clear between each shelf. The overall height of the unit will vary among manufacturers, but should not exceed 8 ft (2400 mm). The upper height limit insures the shelving will fit into a 9 ft (2700 mm) minimum height cage. The bottom shelf should be 3 in above the floor. A typical 8 ft. by 12 ft. - 2 in. (2400 mm by 3650 mm)

cage cannot provide a sufficient aisle clearance if shelving units are placed along each of the long walls. To provide the necessary clearance, combine two of the typical 8 ft by 12 ft - 2 in (2400 mm by 3650 mm) cages side by side to provide a 16 ft by 12 ft - 2 in

(4800 mm by 3650 mm) cage (Small Duffel Bag Caging Layout). If required provide 3 shelving units along each 12 ft - 2 in (3650 mm) side, and 2 shelving units in the middle of the cage. For more storage area utilize two Small Duffel Bag Caging Layouts end to end to create a 16 ft by 24 ft. - 4 in (2400 mm by 7300 mm) cage (Large Duffel Bag Caging Layout). This layout allows for six shelving units along each of the 24 ft. - 4 in (7300 mm) sides and six shelving units in the middle. By providing two doors in the 16 ft (4800 mm) side, the soldiers can enter one door, walk through the cage to pick up or return their duffel bags, and exit the other door. Each shelving unit will accommodate 3 duffel bags per shelf or 15 duffel bags per shelving unit. /2/

**3-5.6.8** \2\ See “Typical Caging Layout Plans” for more details at: <http://www.lrl.usace.army.mil/ed2/default.asp?mycategory=212>. /2/

**3-5.7** \3\ Dumpster Enclosure - Reinforced concrete dumpster pad with enclosure should be of sufficient height and size to fully screen the dumpster(s). The exterior material of the dumpster enclosure should match the same material proposed on the exterior of the Training Center. Provide at least two bollards in the rear of the pad to provide stops for dumpster return placement by the removal equipment. Provide bollards to protect the exterior of the enclosure. Provide operable gates to fully screen the dumpsters with gate keeper devices to hold close and to hold open gates in support of dumpster equipment operation.

### **3-5.8** Flagpole

**3-5.8.1** The flag of the United States will be displayed outdoors at all Army installations per Army Regulation 840-10. All Army Reserve Centers should have a flagpole. Typically, Army Reserve Centers on Army installations do not have a flagpole since the Army installation has one, however a flagpole should be requested when the Army Reserve Center is significantly remote from the main part of the installation. Army Reserve Centers on military installations other than Army should request to have a flagpole.

**3-5.8.2** The standard flagpole will be tapered mill finish aluminum, fitted with a gold anodized finish “ball” finial. The mounting detail is to be simple with a concrete base flush at grade. A concrete or sustainable paver pad must be used when poles are located in lawn areas. In plaza areas, flagpole locations and mounting detail will be integrated into the paving pattern. Flagpoles may be accented with planting beds around the base of the flagpole. The flagpole should be lighted if it is determined that the flag will not be removed at night. The height of the flagpole is dependent on the size of the flag flown, for Army Reserve Centers the flag is typically the field flag (6-foot 8-inch hoist by 12-foot fly) which would require a 40 foot flagpole. /3/

## **3-6 INTERIOR DESIGN**

### **3-6.1** Army Reserve Approved Materials and Systems

**3-6.1.1** The approved finish materials for the various spaces are described, by space,

in Chapter 4. A list of approved furnishings for each space is also located there.

### **3-6.1.2 Flooring**

**3-6.1.2.1** Vinyl composition tile (VCT) is the preferred flooring in most rooms for reasons of economy, durability, ease of maintenance and resistance to stains.

**3-6.1.2.2** In areas where an upgraded appearance is desired, carpet tiles is the standard. Carpet tiles aid in noise reduction and reduces fatigue when standing for long periods. Fiber, construction, and cleanability must be considered in selection of carpet tiles. Carpet tiles are more easily maintained and require replacement only of damaged portions.

**3-6.1.2.3** Certain areas of the building may require specialty floorings. In restrooms, ceramic tile is normally used because of its hard surface, ease of cleaning, and stain resistance. In the kitchen, quarry tile is used because it is impervious to water, grease and most liquids. In physical fitness rooms, rubber flooring is used for resilience and resistance to indentation. In NOC rooms and other rooms where electrical equipment is in use, a static dissipative tile is used to reduce the effects of static electricity.

**3-6.1.2.4** Other flooring materials such as porcelain pavers are occasionally used when an upgraded image is desired or to complement the facility image.

**3-6.1.2.5** Entrance-type carpeting should be provided at all major training center entrances to minimize tracking of dirt, mud and snow into the building.

### **3-6.1.3 Wall Finishes**

**3-6.1.3.1** Paint is the preferred finish for wall surfaces. The paints used in the facility should be high quality, durable and easily cleaned. Epoxy paint should be used in wet areas such as toilet rooms.

**3-6.1.3.2** Ceramic tile is used on the walls of toilet and shower rooms for durability, cleanability and resistance to stains.

**3-6.1.3.3** For areas where enhanced appearance is desired, such as conference rooms and command suites, vinyl wallcovering or paneling should be considered.

**3-6.1.3.4** Horizontal blinds are provided for most windows. Room-darkening horizontal blinds are required in classrooms, conference rooms, and other areas where A/V equipment might be used.

### **3-6.2 Furniture**

**3-6.2.1** All Army Reserve projects are designated as a UNICOR or non-UNICOR

**Figure 3-9**  
**USARC, Camp**  
**Parks, California**



project to determine the furniture vendor to be specified. The designer must verify the designation with the Louisville District Corps of Engineers. /2/

**3-6.2.2** \1\ The majority of the furniture in USAR facilities is administrative, and will be either freestanding metal desk-based furniture or panel based system furniture. The USAR has determined that suspended pedestals will not be used. Furniture should be coordinated with the Tenants so that it supports the intended functions and equipment./1/ \3\ Verify with Louisville District Corps of Engineers current furniture specifications./3/

**3-6.2.2.1** Freestanding metal desk-based furniture is used in the private and shared offices. The desk-based furniture will be capable of structurally supporting overhead desk storage. USAR has selected freestanding metal desk-based furniture for offices for its greater flexibility and minimal effort when changes are required. The supports for the overhead desk storage should not exceed approximately 6 in (150 mm) in depth. Avoid furniture arrangements which has office Tenant's back to the door.

**3-6.2.2.2** Panel-based system furniture is used in the unit common areas. All of the major components of the system will be suspended \3\ /3/ from the panels. The panels provide some acoustical and visual privacy in the open office spaces. \3\ /3/

**3-6.2.2.3** General Officer and staff suite, O6 Commanding Officers and O6 Commanding Officer's Command Sergeant Major offices shall be distinguished from typical private offices with the use of traditional wood furniture. \3\ Verify with Louisville District Corps of Engineers current wood furniture specifications./3/

**3-6.2.2.4** Desk Units, workstation and common-use storage pieces should be provided with keyed locks; coordinate keying with Tenants. Normally, desk unit storage pieces in each private office should be keyed alike; unit commons workstation storage may require more than one key per workstation due to multiple Tenants.

### **3-6.2.3 Seating**

**3-6.2.3.1** Desk seating for the private, shared and unit common workstations will have ergonomic adjustments to fit the Tenant and the task. Ergonomic adjustments include overall height, lumbar support and arm height adjustments which help the Tenant to more efficiently complete the task and prevent injury.

**3-6.2.3.2** Visitor or guest chairs will be sled-based to easily be pulled up to the desk or table.

**3-6.2.3.3** \1\ Classroom chairs will be stackable for ease of reconfiguring the furniture within the room as well as for ease of storage. The stacking chairs will have upholstered seats and backs, and a sled base./1/

**3-6.2.3.4** \2\ Breakroom chairs will be stackable, sledbase, plastic shell chair./2/

**3-6.2.3.5** Lounge seating will be fully upholstered.

**3-6.2.3.6** \1\ Adjustable stools used in conjunction with workbenches in armorers' room and repair rooms will have woven "Crypton" upholstery with a finish that will protect against grease and oils. Adjustable stools used in conjunction with workbenches in NOC's will be an ESD (static dissipative) type with arms. Adjustable stools, with or without arms, will be used in conjunction with lecterns in Learning Centers and Assembly rooms, and are optional for classrooms and training rooms.**/1/**

**3-6.3** Colors: The USAR has approved four basic color schemes for its projects: green, blue, rust and cranberry. These color schemes serve as a guideline and the designer is encouraged to enhance them.

**3-6.4** \1\ Steel shelving and steel cabinets for unit storage areas and maintenance shops are considered equipment rather than furniture, and are provided as part of the construction contract under OMAR funding. (See [Appendix C](#) for list of OMAR-funded items.) Shelving for library and facility maintenance storage areas are typically part of the furniture package. Workbenches for unit storage areas, maintenance shops and armorer's rooms are typically part of the furniture package.**/1/**

**3-6.5** Furniture design must be closely coordinated with electrical and communication design; this is especially true for the open office panel system workstations. The workstations will be furnished and installed by the Government, but the construction contractor will be responsible for wiring them once they are installed \3\ and the cutting of the Government furnished electrical base feed whip to the appropriate length and connecting to the buildings's power source. The construction contractor shall provide and install all conduit, fittings, cables, coverplates and jacks necessary to complete the communications system installation with the panel systems furniture workstations. **/3/** Close coordination should reduce the conflict inherent in this situation.

**3-6.6** \3\ Marker boards, projection screens and presentation boards need to be sized for the individual room and its use. The minimum size of marker boards in classrooms, library reading rooms, learning centers, and COMSEC training rooms is 4'h x 8'w and the minimum size in break areas is 4' x 4'. The minimum size of presentation boards in conference rooms is 4'x4'. The minimum size of projection screens in classrooms, library reading rooms, learning centers, and COMSEC training rooms is 6' x 6' and the minimum size in conference rooms 4'w x 8'h. Marker boards and projection screens in assembly halls will need to be sized to meet the tenant's desire. Marker boards are porcelain enamel on sheetmetal to allow use of magnets and magnetic presentation devices. Presentation boards in conference rooms are enclosed in a cabinet. Projection screens are powered and recessed mounted in the ceiling; an exception can be made for screens in the assembly hall. **/3/**

**3-6.7** The RSC and Tenants should be asked if they have furniture standards of their own. In case of conflicts with typical USAR standards, the Using Service will make a determination.



## **3-7 STRUCTURAL**

### **3-7.1 USAR Approved Systems and Materials**

**3-7.1.1** Reference ~~12~~ UFC 1-200-01 "General Building Requirements" ~~12~~ for further structural design information.

**3-7.1.2** The structural system should be the most cost effective design without restricting the architectural and engineering aspects of the building, such as flexibility, function, character, and symmetrical configuration for seismic resistance. A variety of systems should be considered, and the one selected must satisfy the site, flexibility, future expansion, program, economic and availability requirements. Note: availability of hard metric construction materials plays a significant role in the structural design.

**3-7.1.3** The following are typical structural framing systems preferred by USAR.

**3-7.1.3.1** Exterior walls will be concrete masonry or steel studs with a masonry veneer. Concrete masonry is preferred due to durability and stiffness for masonry veneer backup. If studs are considered for masonry veneer backup, design should limit stud lateral deflection to L/600. AT/FP requirements restrict the use of load-bearing concrete masonry and load bearing steel stud walls for multistory structures (three stories or more, not including the basement, if applicable).

**3-7.1.3.2** Roof framing consists of steel beams, steel bar joists, and steel roof deck. Depending on local soil conditions, the lower level floor is reinforced concrete slab on grade or structurally reinforced concrete slab. The remaining levels consist of either steel form deck filled with concrete supported by steel bar joists, steel beams and columns or precast plank supported on load-bearing concrete masonry walls. Depending on requirements for fireproofing, composite steel beams may be an alternative to steel bar joists in the above-mentioned systems. Consider pre-engineered buildings for unheated storage structures. USAR strongly prefers tube columns for ease of detailing and fit within exterior walls.

**3-7.1.3.3** ~~12~~ Use of wood in Army Reserve Projects is covered by ACSIM-ODR memorandum "Use of Wood for Military Construction, Army Reserve (MCAR) Projects" dated 10 September 2002. The memorandum states on a project-by-project basis, if aesthetically acceptable, economically feasible and approved by ACSIM-ODR, heavy timber or glued-laminated columns, beams, and trusses may be used in Army Reserve Facilities. The memorandum specifically states that light wood framing is not acceptable.~~12~~

### **3-7.2 Design Loads**

**3-7.2.1** The following are minimum design loads. Some local building codes or design requirements may be more stringent and will take precedence.



### 3-7.2.2 Gravity Loads

Roof live load	20 psf	1.0 kPA
Snow load (governs if greater than the minimum Roof live load of 20 psf above) refer to <del>2</del> UFC 3-310-01 <del>2</del>		
Floor live loads (in accordance with ASCE 7)		
Assembly/waiting rooms	100 psf	4.8 kPA
Classrooms	40 psf	1.9 kPA
Corridors (2nd floor)	80 psf	3.8 kPA
Day rooms/lounge	60 psf	2.9 kPA
Latrines/locker rooms	75 psf	3.6 kPA
Library/reading rooms	60 psf	2.9 kPA
Light storage	125 psf	6.0 kPA
Mechanical room (air conditioning)	125 psf	6.0 kPA
Mech. equip. room (general)	100 psf	4.8 kPA
Offices	50 psf	2.4 kPA
Recreation rooms	100 psf	4.8 kPA
Telephone/radio equip. rooms	100 psf	4.8 kPA
Floor partition load	20 psf	1.0 kPA

**3-7.2.3** Some Tenants have concentrated loads in the form of banks of files or safes; the designer should inquire as to whether there are special loads which need to be accommodated in the design.

### 3-7.3 Lateral Design

**3-7.3.1** Seismic lateral loads are determined according to ~~2~~ the latest DoD guidance set forth in UFC 1-200-01 "General Building Requirement" ~~2~~. A geotechnical engineer should determine the seismic Site Classification during the site evaluation and prior to the project feasibility study.

**3-7.3.2** Wind lateral loads are determined according to ~~2~~ the latest DoD guidance set forth in UFC 1-200-01 "General Building Requirement" ~~2~~. Basic wind speeds are also found in UFC 3-310-01 "Design: Structural Load Data". ~~2~~ However, in the event of discrepancies, the former shall govern. ~~2~~ An Importance Factor of 1.0 should be applied to the design of training centers.

**3-7.3.3** Wind pressures (components and cladding) on roof systems should be shown on construction documents. Structural should determine cladding wind pressure values and information could be shown on architectural roof plans.

**3-7.3.4** Provide redundant lateral resisting systems to comply with AT/FP requirements. Refer to Section 3-7.6 for further information.

**3-7.4** Structural Ceiling Grid System: Below the sloped roof, provide a U-shaped cold-formed channel grid system for ceiling, mechanical/electrical equipment support and lateral support of nonload-bearing partition walls. Grid system should be laterally

braced for site-specific seismic conditions. Minimum lateral design load will be 0.25 kPa (5 psf) applied to supported elements.

### **3-7.5 Wall Elevations**

**3-7.5.1** Structural wall elevations will be provided in the construction (drawings) documents. Concrete masonry wall elevations will note the reinforcing steel, steel or masonry lintels and other pertinent information. Wall elevations should ~~12\~~ reference architectural and mechanical drawings for actual dimensions of wall openings.~~12/~~

**3-7.5.2** Structural may consider a key plan (building footprint) for referencing wall elevations.

### **3-7.6 Antiterrorism/Force Protection (AT/FP) Considerations**

**3-7.6.1** Refer to Section 2-5 of this document for AT/FP documentation and further information. The USAR prefers that buildings be limited to two stories to avoid additional construction costs necessitated by buildings over two stories in height.

**3-7.6.2** A brief summary of some structural requirements:

**3-7.6.2.1** For all multistory (three or more stories, not including the basement, if applicable) inhabited structures, design all vertical load bearing elements assuming the loss of lateral support at any one floor level. For design of vertical elements, the effective length is established by lateral support by the roof or floor level(s). This will essentially double the design effective length of the column, and thus possibly increase its size. The design of the vertical element should include the load contribution from the lost level. This requirement is independent of standoff distances.

**3-7.6.2.2** Exterior masonry walls will be reinforced in all inhabited structures. Refer to AT/FP criteria for minimum masonry reinforcing. When AT/FP standoff distances are not met, grouting and vertical reinforcing may need to be increased to resist the damage of an explosive placed at the standoff distance.

**3-7.6.2.3** On multistory (three or more stories, not including the basement, if applicable) inhabited structures, design all floors and roofs with improved capacity to withstand load reversals. This requirement is independent of standoff distances.

**3-7.6.2.4** AT/FP requirements restrict the use of load bearing concrete masonry and load bearing steel stud walls for multistory structures (three stories or more, not including the basement, if applicable). Exterior walls in multistory inhabited structures will employ one-way wall elements spanning vertically to minimize blast loads on columns. AT/FP requires that concrete masonry walls span vertically and be isolated from vertical elements (i.e., columns) of the frame system. This requirement is independent of standoff distances.

**3-7.6.2.5** When portions of inhabited structures with lesser occupancies are located

within prescribed standoff distances, structurally separate those portions of lesser occupancy from the remaining portions of the structure that meet the standoff distances. Individual structural framing systems may be utilized, for example, locating two columns side by side to support neighboring portions of inhabited structures. Coordinate standoff distance requirements with project site designer.

**3-7.6.2.6** Attach interior ceiling-mounted fixtures to the supporting structural system in inhabited structures. This includes suspended ceilings, light fixtures, and mechanical and electrical ducting and pipes. Seismic support of these items is described in **\2\** the latest DoD guidance set forth in UFC 1-200-01 **/2/**. This requirement is independent of standoff distances.

### **3-7.7** Foundation

**Figure 3-10**  
**USARC, Arden**  
**Hills, Minnesota**



**3-7.7.1** Concrete masonry foundation walls below grade will be filled solid with corefill concrete to prevent water from accumulating.

**3-7.7.2** Provide a typical foundation and ground floor slab detail within the construction (drawing) documents. This detail will note the geotechnical soils report recommendations for preparation of soils to support the building foundation and concrete slab.

### **3-7.8** Renovations/Alterations

**3-7.8.1** Refer to **\2\** the latest DoD guidance set forth in UFC 1-200-01 “General Building Requirement”**/2/** for seismic evaluation and upgrading of existing structures.

**3-7.8.2** When altering an existing structure, consult the Using Service (ACSIM-ODR) for extents of structural upgrading for current code compliance and life safety requirements.

**3-7.8.3** In addition to structural design criteria, the seismic capability of existing structures must be evaluated per **\2\** the latest DoD guidance set forth in UFC 1-200-01 **/2/**

**3-7.8.3.1** The seismic evaluation analysis will be carried to the extent necessary to determine a reasonable estimate of the life safety requirement (safety of personnel, i.e., to prevent collapse of building).

**3-7.8.3.2** **\2\** The investigation should include but not **/2/** be limited to the analysis of representative frames or load-bearing shear walls in both directions of the structure. Seismic forces will be carried to the foundations.

**3-7.8.3.3** Consult the Using Service (ACSIM-ODR) regarding lateral resisting systems redundancy according to AT/FP guidelines.

**3-7.8.3.4** Roof and floor diaphragms will be investigated to transfer the lateral load to the frames or shear walls, particularly the connections.

**3-7.8.3.5** Nonreinforced masonry filler walls will be assumed to have no resistance capacity and will be susceptible to damage. However, if there are many of these walls that appear to provide substantial lateral load restraint without exceeding the allowable stresses, they may be considered as part of the seismic resisting system.

**3-7.8.3.6** When the strength of materials in concrete construction or the strength of the load-bearing masonry walls is critical for the investigation or in determining the necessary remedial measures, core samples will be taken and tested to determine the values to be used for developing the conclusions.

**3-7.8.3.7** Life safety of the existing structure is defined as meeting ~~75~~ **75** percent of the lateral resistance (strength requirements) required by code. However, any strengthening or remedial measures to be provided will be designed to meet 100 percent of the lateral resistance of the code.

**3-7.8.3.8** Refer to ~~the~~ **the** latest DoD guidance set forth in UFC 1-200-01 ~~for~~ **for** detailed requirements for ductility in frames, connections to account for walls, isolation of nonstructural masonry walls, clearances to account for story drift and support of nonstructural and mechanical/electrical elements. Existing partitions and walls without lateral support at the top, or without straying from a relatively rigid ceiling system near the top, will be provided with lateral support against seismic forces. Mechanical and electrical equipment will be anchored to resist seismic forces. All new partitions, suspended ceilings, mechanical and electrical elements, and systems must be designed in accordance with the latest DoD guidance set forth in UFC 1-200-01.

## **3-8 MECHANICAL**

### **3-8.1 USAR Approved Materials and Systems**

**3-8.1.1** HVAC materials are of commercial quality, leaning towards the industrial end of the scale. In most cases equipment is floor mounted in a mechanical room or installed outside on a housekeeping pad. Rooftop equipment is seldom used except for kitchen applications. NOC rooms should be served by small split system cooling units to allow the central cooling plant to be deactivated in the unoccupied mode. HVAC systems and equipment should be selected to provide the lowest life cycle cost. Refer to ETL 1110-1-181 for chiller selections. When selecting equipment and systems, consideration should also be given to keeping the service aspects of the installation simple, allowing on-site personnel to perform the maintenance tasks rather than having outside service contracts. There are five general HVAC system types typically used on Army Reserve projects:

**3-8.1.1.1** Variable Air Volume Systems include a central package air handler which utilizes chilled water, and hot water coils, package chiller and boilers, and VAV boxes with reheat. If a chilled water system cannot be justified by life cycle costs, air-cooled

condensing units may be used.

**3-8.1.1.2** Split Systems include fuel-fired furnaces with condensing units or small air handlers with condensing unit/heat pumps. These are normally single zone units.

**3-8.1.1.3** Fan Coil Units Systems can be used for multizone situations in lieu of VAV boxes. This system requires central chiller and boilers and piping systems feeding the fan coil units in each zone.

**3-8.1.1.4** Vehicle maintenance bays are normally served by either fuel-fired infrared heaters or fuel-fired forced air unit heaters. In climates with more than 5000 heating degree days, in-floor hot water heat with fuel-fired infrared heaters is the standard.

**3-8.1.1.5** Kitchens are normally served by a rooftop makeup air unit and cooled by either a packaged cooling rooftop unit or by a central VAV system.

**3-8.1.2** It is standard practice to apply DDC controls to Army Reserve building projects. The size of the projects are generally such that digital controls are warranted for energy savings. Off-Post facilities, buildings not intended to be connected to EMCS, and facilities where the user specifically directs the design, are facilities where DDC is permitted to be used and must be decided on a case-by-case basis.

**3-8.1.3** Select and design mechanical systems in accordance with UFC 3-410-01FA. For weather data use UFC 3-400-02 and other "authoritative sources of weather data and tapes." Also note that compliance with Executive Order 13123 requires purchase of products with an energy efficiency of the upper 25% available. Use mechanical ventilation to meet the building's cooling requirements when practical. Consider the use of heat recovery equipment in areas with high ventilation requirements. Size pipes and ducts using industry standard friction rates and velocities. Design ducts and piping with smooth transitions to reduce friction losses. Specify insulation thickness to meet applicable energy efficiency standards. ~~UFC~~ UFC 3-450-01 ~~/2/~~ provides design guidance for controlling noise and vibration.

**3-8.2** Provide mechanical ventilation that allows the buildings to conform to sustainable design standards. This includes applying the latest version of ASHRAE Standard 62.1. Assembly Hall, Classrooms, Reading Rooms, Conference Rooms, Physical Training, etc. will have widely varying occupancy rates during occupied periods. It also appears that pollutants in these spaces, and therefore the outside air requirements in these spaces, will be directly related to the number of occupants. Controlling the amount of outside air based on CO<sub>2</sub> sensors can be very effective in these cases saving significant amounts of energy while ensuring a healthy environment for the occupants. Suggest that CO<sub>2</sub> sensors be considered by the designer for these spaces in coordination with the user and maintenance staff. It also appears that many of the offices and similar spaces will be occupied only part of the time the building is occupied. The designer, in coordination with the user and maintenance staff, should consider occupancy sensors for those spaces to control both the lights and to reset the terminal units to an unoccupied setting.

**3-8.3** Provide automatic temperature controls for maintaining occupied and unoccupied temperature conditions. Use temperature controls with setback and time-of-day provisions that allow building temperatures to drift during unoccupied hours. Provide protective shields for sensors and thermostats in exposed areas. Apply DDC (direct digital controls) to VAV (variable air volume) and other multiple zone systems used on larger (over 10,000 sf or 1000 sq m) buildings. Provide an emergency HVAC shutoff switch accessible to building occupants that will shut down air handling systems to limit distribution of airborne contaminants.

**3-8.4** Zoning and System Considerations: emphasize the occupancy profile for various areas of the building when analyzing systems. Where possible, isolate part-time occupancy areas from full-time occupancy areas to reduce energy consumption. Allow unoccupied zones to drift to the unoccupied space temperature limits. Make provisions to introduce mechanically conditioned ventilation air only during the occupied hours for each zone. Ventilation requirements listed in individual space criteria are minimums. Humidification systems are not required. Dedicated dehumidification systems are required only in arms storage vaults. Base additional design decisions on the recommendations stated in the latest editions of the American Society of Heating, Refrigerating and Air Conditioning Engineers (ASHRAE) Handbooks.

**3-8.5** Provide dedicated mechanical room space for floor-mounted equipment. Access doors must be lockable. Include adequate space for the equipment, duct and piping connections, removal and replacement access, and manufacturer's recommended service clearances around each piece of equipment. Equipment may share service access space to minimize mechanical room floor area. Isolate natural draft fuel-fired equipment from air-handling equipment to prevent down drafting of flue gasses. Ventilation air intakes and exhausts must be a minimum of 15 ft (5 m) apart. Intakes must be 10 ft (3.05 m) above grade due to AT/FP requirements, and be on a different building face from exhausts. Intakes must also be as far as possible from cooling towers, plumbing vents and any other source of contamination, see Air Intake Minimum Separation Distance Table in ASHRAE 62.1. Army Reserve policy is to minimize roof penetrations and roof-mounted mechanical equipment for both practical and aesthetic reasons. Fresh air intakes will be located to maintain this intent while complying with antiterrorism requirements.

**3-8.6** Consider providing screen walls for exterior mechanical or electrical equipment, to screen them from view to improve the appearance of the facility. If screen walls are provided, their design must comply with AT/FP standards. Recommend and provide manufacturer equipment ventilation. Typical screen walls are 8 ft (2450 mm) tall, of a solid material with a lockable gate, and the screened area normally has a rock mulch or similar ground cover. It may be necessary to provide a screen top to the enclosure for AT/FP purposes.



### 3-9 PLUMBING

#### 3-9.1 USAR Approved Materials and Systems

**Figure 3-11**  
**Janitor's Closet**



**3-9.1.1** The plumbing materials are those typically used for commercial construction where the building owner intends to occupy the building. Included a compressed air piping system for maintenance bay service tools, typically the air compressor is located in the mechanical room. Other maintenance building options may include hard piped lube/oil and AT fluid distribution systems, compressed air drops, battery charging, emergency safety fixtures and water drops. These options may be shared by adjacent workbays to reduce cost.

**3-9.1.2** Provide factory fabricated plumbing equipment. This includes grease traps, oil/water separators, compressed air plants and trench drains. Select piping materials that will provide 25 years of service. Consider the durability required to withstand periodic and emergency cleaning with plumbing snakes. Select plumbing fixtures and equipment to provide the lowest life cycle cost. Refer to ETL 1110-3-465 for water meter criteria. Refer to ETL 1110-3-466 for selection of oil/water separators. **12** UFC 3-420-02FA, UFC 3-420-01 and TM 5-810-6 **12** provide design guidance for compressed air, plumbing and gas piping systems, respectively. UFC 3-230-10A provides design guidance for water supply systems. Communication with the Tenants is important to establish the appropriate level of design for the vehicle maintenance areas.

### 3-10 ELECTRICAL

#### 3-10.1 General

**3-10.1.1** The primary goal of electrical systems design should be to provide a safe, reliable, flexible, economical, comfortable and energy efficient facility.

**3-10.1.2** The project design should include power distribution, interior and exterior lighting, exit and egress lighting, fire alarm system, fire alarm signal transmitters, security system, arms vault intrusion detection system, public address system, cathodic protection, lightning protection, open office furniture wiring, kitchen equipment wiring, elevator equipment wiring, and telecommunication system.

**3-10.1.3** Electrical and communication design must be closely coordinated with furniture design; this is especially true for the open office workstations. The workstations will be furnished and installed by the Government, but the construction contractor will be responsible for wiring them once they are installed **13** and the cutting of the Government furnished electrical base feed whip to the appropriate length and connecting to the buildings's power source. The construction contractor shall provide and install all conduit, fittings, cables, coverplates and jacks necessary to complete the communications system installation with the panel systems furniture workstations. **13** Close coordination should reduce the conflict inherent in this situation. **12** For full time/

shared private offices refer to Section 4-2.1 for desk unit/workstation power and data requirements./2/

**3-10.1.4** The design and construction of the electrical systems should be in compliance with the latest NFPA 70-National Electrical Code, NFPA 101-Life Safety Code, and IES Lighting Reference Guide and Application Guide \3/ /3/.

**3-10.1.5** \3/ Materials and equipment shall be the standard catalogued products of manufacturers regularly engaged in the production of such equipment and material, and shall be the manufacturer's current design. All equipment and material shall conform to the requirements of American National Standards Institute (ANSI), American Society of Testing and Materials (ASTM), National Electrical Manufacturer's Association (NEMA), National Fire Protection Association (NFPA) or other national trade association as applicable. Where standards exist, materials and equipment shall bear the label and be listed by Underwriters Laboratories, Inc. (UL) or other Nationally Recognized Testing Laboratory (NRTL) per the NEC. /3/

**3-10.1.6** The designer should prepare lighting calculations, electrical load calculations, electrical short circuit and protective device coordination analysis and calculations. The short circuit and protective device coordination analysis should be done using industry standard computer software and the reports should be furnished for Government review.

### **3-10.2 Exterior Electrical Systems**

**3-10.2.1** The main electric power service will be obtained from the local power company or the Government installation.

**3-10.2.2** A/E should confirm in writing the service requirements from the utility or installation to provide primary underground electrical service and pad-mounted transformer. \3/ Pad-mounted transformer should be located in accordance with requirements of power company, installation and AT/FP. /3/

**3-10.2.3** The empty conduits from the service transformers to the primary power source, for service cables, and transformer pad will typically be provided by the contractor in accordance with utility company standards. Provide transition cabinet on transformer pad in accordance with utility company standards. Secondary underground electrical service, including trenching and backfilling, should be provided by the contractor. Provide current transformer (CT) cabinet for utility-furnished CTs. Utility company normally provides meter. A 1 inch (21 mm) conduit should be routed from the CT cabinet to the meter.

**3-10.2.4** A total electrical service including all cable, pad, transformer, meter and underground conduit, etc. will be provided for under the project design for facilities on government installations. Coordinate with government facility DPW. \3/ UFC 3-400-01 requires the utilities to be monitored through connection to a base wide energy and utility monitoring and control system directly or via the building HVAC control system, this may require installing a meter separate from the billing meter./3/

**3-10.2.5** Secondary underground electrical service should utilize direct burial conduits, with a spare conduit from the transformer to the main switchboard.

**3-10.2.6** \3\ Project exterior monumental sign should be lighted using photocell on - timer off - timer on - photocell off. Flagpole should be lighted if it is determined that flag will not be removed at night with photocell on - photocell off control. /3/

**3-10.2.7** Exterior lighting fixtures (wallpacks, canopy lights) should be provided at building entrances/exit doors with programmable lighting control system and a photocell. Control should be photo on/photo off. Locate the lighting controller and time clocks in the main electrical room. Time clock generally programmed to allow lighting between the hours of 5:30 P.M. - 11:59 P.M.

**3-10.2.8** DEPMED and MEP area should be provided with light fixtures mounted on 9.1 meter steel pole for area lighting. Consider the use of metal halide lamp light fixtures with motion sensors and time clock for exterior lighting to turn on light fixtures when a motion is detected in the area. Locate the lighting controller and time clocks in the main electrical room. Maintain an average lighting level of \2\ 0.2 foot-candles /2/ throughout the area. Provide motion sensor control for high-low light levels. \3\ The sequence of operations shall be:

- 1) Photocell ON.
- 2) Lamps brought to 100% light output and allowed to warm up per manufacturer's recommendations.
- 3) Lamp brought to 50% light output after warm up.
- 4) When motion detected, lamps brought immediately to 100% output.
- 5) Fifteen minutes after last motion detected lamps reduced to 50% output.
- 6) Photocell OFF./3/

**3-10.2.9** Verify the need for security lighting for POV parking area with the Tenants and also the local municipality or Government installation. \2\ POV parking area light level shall be 0.1 foot candles average./2/ \3\ POV parking lot lighting control: photocell on – timer off – timer on – photocell off./3/

**3-10.2.10** Outdoor GFCI receptacles with weatherproof covers should be provided.

**3-10.2.11** \3\ Light pole bases shall be designed to accommodate local soil and wind conditions. For poles in locations in POV parking lots protected by a curb or wheel stop, the pole base shall extend 3 inches above final grade. For poles in POV parking lots in locations not protected by a curb or wheel stop, the pole base shall be a minimum of 24 inches in diameter and extend 36 inches above final grade. For poles located in MEP areas, the pole base shall be a minimum of 36 inches in diameter and extend 48 inches above final grade./3/

### 3-10.3 Interior Electrical

#### 3-10.3.1 Interior Electric Power Distribution

**3-10.3.1.1** Buildings should be served from main switchboards in the electrical rooms at 480/277 volt, 3-phase, 4-wire for lighting, power and mechanical loads. DEPMED should be provided with 208/120 volt, 3-phase, 4-wire power supply.

**3-10.3.1.2** ~~3\~~ Dedicated Electrical Equipment Space. The main electric room shall be sized and organized to accommodate the main switchboard, space for an additional (future) distribution section, metering equipment, distribution transformer(s), distribution board(s), panelboard(s), space for 20% (not less than one) additional (future) panelboard(s), fire alarm control panel, lighting control equipment, and additional equipment as required. Coordinate access and egress requirements and location relative to the service transformer. Electrical equipment dedicated space and working space shall be in compliance with the NEC.~~3/~~

**3-10.3.1.3** Conductors for feeders should be sized to prevent a voltage drop exceeding 3 percent at the farthest outlet of power, heating, and lighting loads, or combinations of such loads – and where the maximum total voltage drop on both feeders and branch circuits to the farthest outlet does not exceed 5 percent, should provide reasonable efficiency of operation.

**3-10.3.1.4** ~~3\~~ The main switchboard shall be service entrance rated and shall have the neutral bus connected to the ground bus by a properly sized main bonding jumper. The main switchboard shall have circuit breakers serving large loads such as distribution boards, panelboards, motor control centers, elevators, and large equipment.~~3/~~ Combination starters should be provided with disconnect switches and breakers to serve motors in HVAC equipment. Branch circuit panels should be circuit breaker panelboard type with plug-in breakers.

**3-10.3.1.4.1** ~~3\~~ Panelboards shall be located to minimize voltage drop, to efficiently serve equipment, and to provide system flexibility. Coordinate locations with other disciplines to avoid conflicts. Electrical equipment dedicated space and working space shall be in compliance with the NEC.

**3-10.3.1.4.2** Distribution Transformers. Size for the load calculated per the NEC plus 25% excess capacity. Nonlinear Loads: In all areas with raised floors and in areas (including but not limited to open office spaces and computer center) where nonlinear load type equipment predominates, such as computers, printers, uninterruptible power supply (UPS), motors with variable speed drives, electronic ballasts and dimmers and other similar loads, IEEE Std. 1100 “Power and Grounding Sensitive Electronic Equipment”, and IEEE Std. 519 “Practices and Requirements for Harmonic Control in Electrical Power Systems” shall be used as design guides. Provide “K” factor rated

**Figure 3-12**  
**USARC, Camp**  
**Parks, California**



transformers as required for the anticipated harmonic load and as required in the Army Reserve IT Manual to power Clean Power circuits. Identify the “K” factor rating for each transformer. Locate in electrical rooms and provide proper ventilation and cooling. Provide energy efficient transformers meeting NEMA TP-1 Standards. Distribution transformers constitute separately derived systems and shall have the neutral bonded at the transformer or at the first overcurrent device in accordance with the NEC. The bonding point will be connected to the nearest suitable standing electrode with a grounding electrode conductor per the NEC.

**3-10.3.1.4.3 Smart Meters:** The Government requires the ability to measure and monitor hourly electrical consumption for each occupied building. Provide metering that communicates electrical data to a remote location in formats that can be easily integrated into an advanced metering system. The meters shall measure, as a minimum, power in kW average demand over 15-minute intervals and energy consumption in kWh, as well as voltage, current, frequency, reactive power, and power factor with an accuracy of 0.5% in accordance with ANSI C12.20. The output shall be Modbus RTU/RS485 and LonTalk ANSI/CEA-709 protocol. The meter shall store data for 30 days, including peak demand recording and time-of-use logging with battery backup. Provide alarm outputs for over/under voltage and phase loss.**/3/**

**3-10.3.1.5** Interior conductors should be type THHN/THWN or THW conforming to UL83 or RHW conforming to UL44. All conductors should be copper. All conductors should be routed in conduit. Minimum conductor size should be #12 AWG, except conductors for fire alarm system should be #16 for initiation circuits. A separate green ground conductor, size per NFPA 70 Article 250 “Grounding,” should be installed in all conduits containing receptacle and lighting circuits, and should be installed in all feeders from main switchboard to panelboards and motor/equipment.

**3-10.3.1.6** The main electrical service switchboard ground bus shall be connected to a Grounding Electrode System in accordance with NFPA 70, Article 250 “Grounding”. The computer room grounding and equipment should be connected directly to the building service ground.

**3-10.3.1.7** **3\** Final sizing for the service(s) for the facility shall be sized for the load calculated per the NEC plus 25% excess capacity, rounded up to the next standard service size, for future growth.**/3/** The following minimum loads should be assumed to determine the preliminary size of electrical service to the building:

Lighting Load	3 VA/sf (26.9VA/sq m)
Site Lighting	465 VA per fixture
HVAC Load	6.5 VA/sf (64.6 VA/sq m)
Elevator	40 HP/elevator
Computer Load	1.0 VA/sf (10.8 VA/sq m)
General Purpose	0.5 VA/sf (5.4 VA/sq m)



Receptacles	
Miscellaneous Loads	1.0 VA/sf (10.8 VA/sq m)
Future Spare Capacity	+25%
Minimum Power Factor	0.9
Transformer Impedance	5.75%

### 3-10.3.2 Power

**3-10.3.2.1** All motors 1/2 HP and larger should be specified 3-phase 480 volts when available. Provide overload protection in the motor starters and short circuit protection for the motor and its feeder. **2** When there is a problem obtaining equipment with 480 volt, 3 phase power, request a deviation from the Contracting Officer's Representative to provide equipment at another voltage.**2**

**3-10.3.2.1.1** **3** 120 volt motors shall have integral thermal overload protection when available. If integral thermal overload protection is not available, provide manual thermal overload starters. Provide combination motor starter–disconnect controllers for polyphase motors. Provide reduced voltage starters for motors over 25 HP. Coordinate starter type with motor design and starting torque requirements.

**3-10.3.2.1.2** Motor Efficiencies. Minimum motor efficiencies shall be either Energy Star or in accordance with DOE Buying Energy Efficient Products Recommendations (refer to [www.eere.energy.gov](http://www.eere.energy.gov) for recommended efficiencies). Provide premium efficiency motors where possible. Premium efficiencies shall meet or exceed the specifications of Baldor Super-E Products. Applications which require definite purpose, special purpose, special frame, or special mounted polyphase induction motors are excluded from these efficiency requirements.**3**

**3-10.3.2.2** **2** Include single phase protection where 120V/240V **2** motors are required by code to have thermal protection, manual thermal overload starters should be provided.

**3-10.3.2.3** **3** Provide disconnect switches for motors and equipment in accordance with the NEC. Provide motor-rated toggle switches for 120 volt motors with integral thermal overload protection. The manual starter may serve as the disconnect for 120 volt motors without integral thermal overload protection when properly located. Combination motor starter-disconnect controllers may serve as the disconnect for polyphase motors when properly located. Provide additional non-fused disconnect switches within sight of the motor when the starter-disconnect cannot be placed within sight of the motor.**3**

**3-10.3.2.4** **3** **3**

**3-10.3.2.5** In branch circuit, feeder and service calculations, compute receptacle loads at not more than 180 volt-amperes per outlet with demand factors according to NFPA 70 Article 220.



**3-10.3.2.6** \3\ All general purpose receptacles should be 20 amps, NEMA WD 1. Ground fault circuit interrupter receptacles should be provided for bathrooms, maintenance bays and outdoor receptacles. Flush floor boxes for the first floor and poke-through boxes on upper floors should be provided to connect panel system workstations in the open office areas, as necessary./3/

**3-10.3.2.7** \3\ /3/

**3-10.3.2.8** \2\ If 4 (four) or more 3-phase motors are located within a room or area use a motor control center (MCC) for motors requiring a starter. /2/

**3-10.3.2.9** \3\ General Purpose Receptacles. General purpose receptacles are in addition to the special purpose and dedicated outlets for special equipment.

**3-10.3.2.10** Provide a minimum of one general purpose 120 volt, 20 ampere duplex receptacle outlet in each room

**3-10.3.2.11** Offices. Provide a minimum of one general purpose receptacle on each wall. In offices where walls exceed 12 feet, provide an additional duplex receptacle for each additional 12 feet of wall or fraction thereof. Receptacle spacing shall not exceed 12 feet. Mount receptacles in offices at 15 inches above finished floor.

**3-10.3.2.12** Provide receptacles or power connections for utilization equipment included in the project as well as equipment furnished by the Government. Government-furnished utilization equipment may include (but is not limited to) computers, fax machines, printers, photo-copy machines, office equipment, vending machines, kitchen equipment, computer network equipment, security system equipment, motorized gates, general maintenance equipment, vehicle maintenance equipment, battery chargers, and military equipment.

**3-10.3.2.13** Clean Power. The use of this term is as defined in the Army Reserve IT Manual.

**3-10.3.2.14** Workstations. Provide each stand-alone, non-system furniture workstation with an adjacent duplex receptacle (in addition to the general purpose receptacles required by paragraphs above) connected to a Clean Power circuit.

**3-10.3.2.15** Provide each stand-alone, system furniture workstation with an adjacent double duplex receptacle (in addition to the general purpose receptacles required by paragraphs above) connected to a Clean Power circuit.

**3-10.3.2.16** Provide each group of six (6) (or fraction thereof) modular, system furniture workstations with a Clean Power multi-wire branch circuit.

**3-10.3.2.17** Provide duplex receptacles in adjustable, multi-service floor outlets or multi-service fire-rated poke-throughs for Unit Commons area worktables, counters, or cabinets that are not against fixed walls or columns.

**3-10.3.2.18** Provide power through adjustable, multi-service floor outlets or multi-service fire-rated poke-throughs for Unit Commons system furniture that are not against fixed walls or columns. /3/

### **3-10.3.3 Interior Lighting**

**3-10.3.3.1** The lighting system should consist of 2 ft x 4 ft (600 mm by 1,200 mm) lensed lay-in fluorescent light fixtures in offices, classrooms, corridors, toilets and general areas. All mechanical and small storage rooms should be provided with fluorescent strip lighting. All fluorescent light fixtures should be provided with energy saver lamps and ballasts. \3\ Lighting levels for the individual areas shall conform to those indicated in Chapter 4 and IES recommendations. Specified light levels shall not be reduced by more than 10% to meet EPA requirements. Individual offices may be provided with a single light fixture, centered over the work surfaces, providing an average-to-minimum uniformity ratio that shall not exceed 10-to-1. The average-to-minimum uniformity ratio shall not exceed 5-to-1 in multiple occupant office spaces. The light fixtures to be used for each functional area are scheduled in Attachment E of this Statement of Work. The fixtures scheduled represent the minimum quality and type for each functional area. Additional types of fixtures and fixtures of higher quality may be required as necessary to meet the design intent and to accommodate specific user needs./3/

**3-10.3.3.2** Emergency lighting should be provided per NFPA 101 utilizing either battery emergency lighting fixtures or emergency battery backup ballasts in the fluorescent fixtures. Exit lights with battery backup should be used. All emergency and exit lights should be connected to the room lighting circuit, ahead of any local switching. An emergency lighting fixture should be installed in all mechanical rooms.

**3-10.3.3.3** Lighting foot-candle levels for the individual areas should conform to levels as indicated in Chapter 4.

**3-10.3.3.4** In calculating foot-candle levels in the office areas, the following criteria for surface reflectance should be used. A maintenance factor of .7 should be used in the calculations. Floors: 20% Ceilings: 80% Walls: 50%

**3-10.3.3.5** Provide lighting fixtures with appropriate lamps for the function of the space.

**3.10.3.3.6** Provide light switches in lobby areas, utility/equipment spaces, and special function rooms. Provide dual level switching in conference rooms and classrooms.

**3.10.3.3.7** Provide a wall or ceiling mounted combination light switch and passive infrared motion sensor for light control in private offices. Ceiling-mounted motion sensors shall be considered for large rooms.

**3-10.3.3.8** Provide ceiling-mounted ultrasonic motion sensors for light control in open office areas, corridors, toilets, locker rooms, storage rooms and physical fitness rooms.

Lighting in unit storage cages should be switched at the end of each row of cages, rather than within each cage.

**3-10.3.3.9** Consider an automatic dimming system utilizing dimming ballasts in fixtures at spaces or portions of spaces where significant daylighting can reduce artificial lighting requirements; consider spaces such as lobbies, unit commons, unit storage, corridors, and assembly hall when daylighting is provided.

**3-10.3.3.10** Light switches should be 20 amp, 120/277 volt AC, specification grade.

**3-10.3.3.11** \3\ A security light outside the arms vaults shall be provided. This light shall be wired ahead of any switches, be vandal-proof, and shall be equipped with a back-up power source./3/

### **3-10.3.4 Special Requirements**

**3-10.3.4.1** Verify geotechnical report for soil resistivity and provide cathodic protection or wrapping of ferrous metals as required.

**3-10.3.4.2** \3\ Provide a UL Master Label lightning protection system if the calculations indicate that the facility lightning risk index  $N_d > N_c$  based on NFPA 780. Coordinate lightning protection and grounding with information systems requirements./3/

**3-10.3.4.3** Power connections to any SCIF room should be provided from a disconnect switch connected ahead of the main switch.

**3-10.3.4.4** Consider providing power for video projector and including public address system with a microphone in any large conference room.

**3-10.3.4.5** \3\ Provide multi-outlet raceway above workbenches with receptacles 12 inches on center in photo lab, IT work room, armorers' room, weapons repair, and electrical/communication repair rooms. Provide a Clean Power circuit for each multi-outlet raceway./3/

**3-10.3.4.6** Provide a minimum of 4 receptacles in reproduction rooms.

**3-10.3.4.7** Provide receptacles for vending machines, faxes, printers, copy machines and special office equipment. Verify whether Tenants have any equipment with special electrical requirements

**3-10.3.4.8** Provide intrusion detection system (IDS) in arms vaults and AGCCS. Provide power supply for the IDS controller. \2\ If on-post, transmit alarm signal to Provost Marshals Office. If off-post transmit alarm signal to Fort McCoy./2\3\

**3-10.3.4.8.1** Electronic Security Systems. There are two (2) separate security systems for this project, a Government-furnished Intrusion Detection System (IDS) and a Contractor-provided Entry Control System (ECS).

**3-10.3.4.8.2** IDS: Provide empty conduit system in arms vaults. Provide backboxes and conduit for sensors, switches, controllers, and alarms as required. Provide conduit for exterior alarm bell. Provide continuous rigid conduit from IDS controller to NOC or telephone room as required. Provide power supply for the Government-furnished IDS controller. Coordinate locations and requirements with the using agency. Locate alarm control junction box outside caged area, but within vault. The IDS is furnished and installed by the Government.

**3-10.3.4.8.3** ECS: Provide an Entry Control System (ECS). This is a complete system, Common Access Card (CAC) compatible and compliant, provided by the Contractor with the following major components:

**3-10.3.4.8.4** Microprocessor Control. Provide central station equipment including a digital computer with the necessary memory, power supply, clock, parts, keyboard, mouse, disk storage, modem, CD-ROM drive, report printer, UPS, and software to control, operate, and annunciate the system.

**3-10.3.4.8.5** Entry Control Local Processor. Provide local entry control processing hardware, software devices, and wiring to communicate between the central station equipment and entry control devices such as card readers, door contact switches, and electric door strikes.

**3-10.3.4.8.6** Card Readers. CAC compatible and compliant card readers at selected exterior doors.

**3-10.3.4.8.7** Provide CAC compatible and compliant card readers and associated equipment for entry control at the following doors: loading dock man door and maintenance.

**3-10.3.4.8.8** Door Contact Switches. Provide Door Contact Switches at all exterior doors.

**3-10.3.4.8.9** Electric Door Strikes. Coordinate with door hardware. Provide power and control wiring as required to support the selected entry control scheme. Provide interconnection with the fire alarm as required to allow unrestricted egress when the Fire Alarm system is in alarm.

**3-10.3.4.8.10** Provide hardware, software, wiring, devices, control interfaces and testing as required for a complete system acceptable to the Government./3/

**3-10.3.4.9** \3\ Receptacles located in hazardous areas besides the Workbays shall be mounted at 18 inches above finished floor. As stated in 4-3.9.11, receptacles in Workbays are to be mounted at 48 inches above finished floor. All adjoining spaces must be designed to meet NFPA 70 Article 511 or designed to be non-rated./3/

### **3-10.4 Communications**

**3-10.4.1** Provide a minimum of two (2) data outlets in each private office. Mount outlets at 15 inches above finished floor./3/

**3-10.4.2** Provide data services through adjustable multiple service floor boxes or fire-rated poke-throughs for telephone outlets in Unit Commons area systems furniture that are not against fixed walls or columns./3/

**3-10.4.3** Provide data outlets in adjustable, multi-service floor boxes or multi-service fire-rated poke-throughs in the Unit Commons area for worktables (one outlet per four (4) seating positions (or fraction thereof)), counters, or cabinets that are not against fixed walls or columns. /3/

**3-10.4.4** Provide the following CATV outlets: two (2) in Assembly Hall, two (2) in each Classroom, and one (1) in the Library Reading Room. Outlets shall be pre-wired in accordance with the Army Reserve IT Manual and local cable TV company requirements./3/

#### **3-10.4.5** /3/

**3-10.4.6** /3/ Public Address (PA) Systems. Provide the PA system required by individual space criteria paragraphs for the Assembly Hall, with two-channel high-fidelity stereo components including AM/FM radio and compact disc music sources, separate mixer/pre-amp and power amplifier, desk and floor stand microphones, speaker switching panel, and roof-mounted AM/FM antenna. Mount components in an enclosed rack in the Chair Storage Room. This system shall be muted by activation of the Fire Alarm and Mass Notification System./3/

#### **3-10.4.6.1** /3/

**3-10.4.7** Provide a telephone or similar annunciation/bell system at the main entrance, and other entrances as practical. Training centers have no receptionist, and are frequently locked during business hours; visitors will need a way to contact someone within the building.

### **3-11 SPECIFICATIONS**

#### **3-11.1 Unified Facilities Guide Specifications (UFGS)**

**3-11.1.1** The Using Service typically requires that USAR projects utilize UFGS. UFGS is a standardized specification system (somewhat like MasterSpec and other master systems) and is regularly updated by DoD. It is available at no cost.

**3-11.1.2** UFGS is a performance-based specification system, rather than a products-based system; references to manufacturers are discouraged in most cases. It is intended to identify salient features and requirements, and to permit any manufacturer

or vendor to provide materials or products which comply with those requirements in accordance with Government mandates for nonrestrictive solicitation.

**3-11.1.3** Some COE Districts and their clients provide versions of UFGS specifically tailored for their needs; USAR is one of these. In most cases the tailored versions do not include all specification sections. The following UFGS versions may be required for a complete USAR project specification (links to all of these can be found at [www.lrl.usace.army.mil/ed/default.asp](http://www.lrl.usace.army.mil/ed/default.asp)).

**3-11.1.3.1** UFGS is the base document from which all versions are adapted, and includes almost all specifications which will be required for a complete specification. It will be the source for sections not included in the USAR-tailored version, and may be obtained at [www.wbdg.org/ccb/browse\\_org.php?o=70](http://www.wbdg.org/ccb/browse_org.php?o=70).

**3-11.1.3.2** UFGS Army Reserve Support Guide Specifications (RST) are the UFGS Sections modified and edited to reflect minimum standards of quality for USAR projects. They may also contain references to manufacturers and model numbers, as well as additional technical and quality assurance features. These are the preferred specification sections for use on USAR projects and may be downloaded from [www.lrl.usace.army.mil/ed/default.asp](http://www.lrl.usace.army.mil/ed/default.asp).

**3-11.1.3.3** Some COE Districts also have UFGS versions tailored to their preferences and experience, such the CEGS Louisville District Guide Specifications (LRL). These may be preferred for non-RST Sections by the Districts that maintain them. They may be requested from the appropriate district. For Louisville District, see [www.lrl.usace.army.mil/ed/default.asp](http://www.lrl.usace.army.mil/ed/default.asp).

**3-11.1.3.4** Occasionally a project may require a specification section not provided by UFGS. In such cases the designer may use commercial or in-house specifications.

## **3-11.2** SpecsIntact

**3-11.2.1** The Using Service generally requires that USAR specifications be prepared using SpecsIntact software. SpecsIntact is free software and can be downloaded at [www.wbdg.org/ccb/browse\\_org.php?o=70](http://www.wbdg.org/ccb/browse_org.php?o=70).

**3-11.2.2** SpecsIntact (Specifications-Kept-Intact) is an automated system for preparing standardized facility construction specifications used worldwide by NASA, the U.S. Naval Facilities Engineering Command (NAVFAC), and the U.S. Army Corps of Engineers (USACE). Using the SpecsIntact software reduces the time and expense required to produce facility technical specifications, and reduces costly construction changes due to omissions, discrepancies or improper quality control. The system uses Master Guide Specifications prepared by each of the three agencies. SpecsIntact facilitates an interchange of construction specifications among Government agencies, therefore eliminating the necessity for the user's familiarity with multiple agency specification systems.



**3-11.2.3** Users prepare specifications by editing the Master text in the SpecsIntact Editor, which employs an application of the Standard Generalized Markup Language (SGML). SGML is an international standard that provides a mechanism for defining and tagging elements of information within the documents. It is this SGML tagging system that allows the software to produce quality assurance reports and other automated features to reduce the time required to complete project specifications. The quality assurance reports verify the accuracy of technical references, submittal requirements, test and other requirements. It allows the user to turn on or off the view capability for tags, notes, metric units, English units, and revisions, and generates a Table of Contents for projects and sections.

**3-11.2.4** When setting up SpecsIntact for the first time, all specifications will go into subdirectories called MASTERS directories. If using base UFGS, RST and district spec sections, three of these directories will be required (i.e., UFGS, RST and LRL for Louisville District). The specification writers will “pull” the necessary specification sections out of these three MASTERS directories into a project JOBS directory where they will be edited for the project.

**3-11.2.5** The project shop drawing submittal register should also be prepared using SpecsIntact.

## **3-12 COST ESTIMATING**

**3-12.1** The USAR typically requires a cost estimate prepared using the Military Computer Aided Cost Estimating System (M-CACES). There are several versions of this software; the designer should verify with the Using Service whether a particular version is required. The USAR Design Process and Submittal Requirements has an excellent description of the desired scope of the estimate. A brief summary follows.

**3-12.2** The estimate will be prepared as a Type K estimate when the national labor rates database is used. The estimate will be prepared as a Type A estimate when a site specific labor rates database is used. The estimate will be organized in the Work Breakdown Structure (WBS) established during the estimate creation process.

**3-12.3** The estimate will be current, complete and accurate, reflecting the information contained in the design documents of the associated submittal. The level of detail contained in the estimate will be consistent with the level of detail contained in the other elements of the submittal. Square meter (SM) pricing and lump sum (LS) allowances may be used to price elements without sufficient design to warrant more detailed pricing methods.

**3-12.4** Project escalation from the date of the estimate to the midpoint of construction shall be expressed as an Owner Cost applied to the project at the highest appropriate title level. Projects having more than one phase may require separate escalation values. The effective date of project supporting databases (Unit Prices, Labor and Equipment) may not reflect current pricing information for the project area. The Adjust Pricing feature of M-CACES may be used to bring the project supporting databases to the

current date and project area. Cost Escalation Tables and Area Cost Factor Tables will be provided by the Government to determine the applicable adjustment factors.

**3-12.5** Design contingency may be applied at early design stages, depending on the amount of design anticipated outside standard criteria. See specific design submittal requirements for applicable percentages. When used, assign this contingency as either an Owner Cost before Escalation or a Prime Contractor Indirect Cost after Bond, as the estimating software allows. DD Form 1391 typically provides a construction cost contingency: 5% for new construction and 10% for add/alter projects. No other contingencies are allowed.

**3-12.6** For requirements on separation of MCAR and OMAR funding in cost estimates, see Section 1-10 of this Guide.

### **3-13 ENERGY CONSERVATION**

**3-13.1** Energy conservation through building design has received a great deal of attention in recent times. Tremendous potential exists for trimming energy consumption and operating costs in both new and existing buildings. As such, it is the most current directive for energy management. Additional energy conservation measures are incorporated in “Sustainable Design Guidelines”, applicable to USAR projects. See Section 2-2.2., and below. UFC 3-400-01 applies to all new and renovated facility design

**3-13.1.1** Site Related Buildings located to utilize winter sun, prevailing winds, and natural land forms. Landscaping and planting to shade the building from summer sun and to block winter winds. East/west orientation of long axis of buildings.

#### **3-13.1.2** Building Envelope

New or replacement insulation: thicknesses, insulating values, insulation placement, and vapor barriers.

Energy efficient windows: reduced glass area, the number of panes, light transmission and reflectivity, type of window construction, window placement, double/triple glazed windows, etc. Protection of windows from direct summer sun: overhangs, shades, blinds, solar films, tinted glass, solar screens and plantings.

Weather stripping and caulking to reduce infiltration.

Entrance vestibules.

Building shapes or frames with low exterior surface to volume ratio.

Maximize advantage of winter solar heat gain and natural daylight.

Earth contact design, such as full or partial wall berms or underground structures.

**Figure 3-13**  
**USARC, Arden Hills, Minnesota**

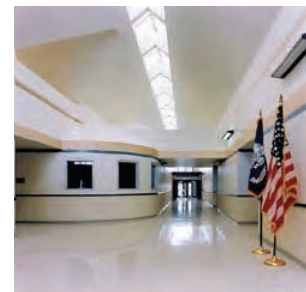

**3-13.1.3 Distribution System**

- Pipe and duct insulation.
- New or replacement steam traps.
- Adjustable flow rates on fans and pumps to carefully match load.

**3-13.1.4 HVAC Equipment**

- System zones based on the Tenant profile of the building.
- High-efficiency boilers, furnaces and unit heaters.
- Multiple boilers for better part load efficiencies.
- Waste heat recovery devices.
- High-efficiency air conditioning equipment.
- Time clocks and setback thermostats.
- Low leakage dampers.
- Economizers.
- High-efficiency filters to reduce ventilation and power usage.
- Tempered air to exhaust hoods.
- Computer-based energy management systems.

**3-13.1.5 Domestic Hot Water**

- Insulated water heaters and storage tanks.
- Water conserving fixtures.
- Time clocks on water heaters.
- Waste heat recovery for water heating.
- Separate water heaters for kitchen and toilets.

**3-13.1.6 Lighting**

- Decreased light levels in noncritical areas.
- High-efficiency lamps and ballasts.
- More efficient fixtures, and better lenses.
- Task lighting.
- Switching to allow for more individual control in unoccupied areas or naturally lit areas.
- High-efficiency exterior lighting with time clock or photocell control.
- Daylighting where possible in conjunction with light fixtures with dimming ballasts.

**3-14 ANTITERRORISM FORCE PROTECTION**

**3-14.1** USAR-specific AT/FP criteria, applicable to the AT/FP criteria document, defines the assembly hall or an auditorium as a “primary gathering structure or area,” where more than 50 people gather in one space. 13 ACSIM-ODR has issued some implementation guidance for UFC 4-101-01 providing specific direction regarding AT/FP, this memorandum is posted on the Army Reserve Customers Website ([www.lrl.usace.army.mil/ed2/default.asp?mycategory=212](http://www.lrl.usace.army.mil/ed2/default.asp?mycategory=212)). All portions of the Training Center are considered Primary Gathering Spaces. Other Buildings will be classified dependent on their occupancy. Special consideration should be paid to the occupancy of the workbays in the OMS and AMSA, if the density is greater than one person per 400 sf

(37 sq m) the occupancy of the space must be counted. /3/

\3 /3/

**3-14.2** The AT/FP criteria require a minimum standoff distance from property lines to inhabited structures, and to primary gathering structures. Uncontrolled parking and roadways also require minimum setbacks from primary gathering areas, and from inhabited structures or areas.

\3 /3/

**3-14.3** Trash containers must be kept a minimum distance from inhabited structures, and from primary gathering areas as illustrated in UFC 4-010-01. This includes trash containers serving the kitchen area; they must be a minimum distance from the assembly hall.

### **3-15 ACCESSIBILITY**

**3-15.1** All building entrances and POV areas should be accessible to accommodate visitors and civilian employees.

**3-15.2** Provide accessible parking spaces in accordance with ADAAG and UFAS.

### **3-16 ENVIRONMENTAL**

**3-16.1** Non-contaminated Site Issues

**Figure 3-14**  
**USARC, Arden**  
**Hills, Minnesota**



**3-16.1.1** Wetlands

**3-16.1.1.1** The site topographic survey should include delineation and survey the limits of wetlands identified on the site, if any. The first consideration is to avoid wetland areas and to direct on-site drainage to storm water treatment or storage ponds prior to discharge into wetlands. In addition to meeting Federal regulations regarding wetlands, it is recommended that designer coordinate with State and local agencies with water resource/wetland jurisdiction. The RSC and COE District Office should be consulted for points of contact with such agencies.

**3-16.1.1.2** If the area of wetlands impacted is over the regulatory maximum, wetland mitigation will be accomplished according to the standards of the local or state water resources agency. The site size may not have sufficient area to accommodate wetland mitigation. Off-site mitigation or purchase of wetland mitigation credits from established wetland mitigation banks may be required, but should be avoided if possible due to associated costs and complications of off-site work.

### **3-16.1.2 Noise and Air.**

**3-16.1.2.1** Any noise and air impacts identified from the Environmental Assessment which require mitigation or permitting will be incorporated into the design. Typical emissions from a site might include boilers and other equipment that emit heat, fumes or particles.

**3-16.1.2.2** Typically, site locations are in areas which permit commercial or industrial type uses with corresponding noise and air quality standards. The general layout of the site should consider locating areas of concentrated vehicle operations and associated noise away from neighboring properties for which noise may be an issue.

### **3-16.1.3 Traffic Safety**

**3-16.1.3.1** As outlined in Section 3-2, coordination with local roadway agencies and implementation of DOT recommended roadway geometrics will accommodate a majority of the site traffic safety needs. The roadway agency may dictate control devices such as stop signs and other roadway design features at access points.

**3-16.1.3.2** If the size of the site and its interior site traffic circulation is substantial, consider designing traffic control signs such as stop signs, pedestrian crossing warning signs, pavement markings, directional signs, information signs, and speed limits to provide safe traffic control and eliminate confusing traffic patterns on the site.

### **3-16.1.4 Groundwater**

**3-16.1.4.1** Groundwater is not a substantial issue on most sites; however, some sites may have shallow groundwater tables which may affect the methodology of construction, and require measures such as temporary dewatering to install items such as deep utilities and foundations. The contractor will be required to obtain the necessary state and local permits for dewatering operations and to control its appropriation and discharge. Items such as French drains or infiltration wells should not be used.

**3-16.1.4.2** Other site uses such as wash racks and refueling points, which may introduce contaminants to the groundwater, must be controlled to contain potential releases of contaminants, and the design must address the control measures.

**3-16.1.4.3** If the site is near a municipal well, wellhead protection provisions may be in effect. The utility or well owner will be contacted regarding these provisions. Wellhead protection provisions may also be required by state rules in some locations.

### **3-16.1.5 Water Quality**

**3-16.1.5.1** Surface water runoff quality is addressed in Section 3-2.1 above. Facilities which could affect the quality of runoff water, such as wash racks and fueling stations, will be connected to a local sanitary sewer through on-site oil/water separators and/or mechanical water/contaminant separators.

**3-16.1.5.2** Exterior connected drains to sanitary sewers shall be under roofed areas or contain valves to control discharge into the sewer. Containment areas may also be provided for contaminants which may affect surface or groundwater quality to provide for its control prior to being safely collected and removed and disposed of by hazardous material teams or contractors.

### **3-16.1.6. Temporary Construction Impacts**

**3-16.1.6.1** Temporary erosion and sediment control requirements are addressed in Section 3-2.1.3 above. Other requirements may include use of flagpersons and/or special control signs during site construction, for access to the site and on-site routing of construction traffic.

**3-16.1.6.2** Fugitive dust from construction shall be controlled by use of application of water or dust retardant chemicals to earthwork areas. Air omissions and noise due to construction are recognized as temporary environmental impacts and generally do not require mitigation or special permits other than the normal licenses or permits required by construction contractors.

**3-16.1.7** It is not unusual for USAR sites to harbor protected wildlife. The design will address any measures identified in the project environmental documentation.

**3-16.1.8** Areas with natural vegetation should be preserved to the extent possible.

### **3-16.2 Contaminated Site Issues**

#### **3-16.2.1 Asbestos/Lead/PCBs**

**3-16.2.1.1** New construction will not incorporate materials which contain asbestos, lead or PCBs, or will only incorporate them in environmentally acceptable forms. Designs for existing facility alterations will normally include mitigation provisions. Mitigation design is typically based on previously accomplished environmental assessments, and feasibility and mitigation studies, but occasionally may require the designer to perform environmental investigations.

**3-16.2.1.2** Mitigation design will comply Federal, state and local rules and regulations, and will normally be completed with regulatory closure approval prior to other construction. The construction contractor should be made liable for control and use of potentially contaminating materials used in their operations.

#### **3-16.2.2 Petroleum Products**

**3-16.2.2.1** Any environmental studies conducted prior to development should identify whether there are on-site petroleum contamination issues. If petroleum contamination consists of surface spills or shallow concentrated areas, the areas are normally mitigated by removal and disposal of the fuel and any adjacent contaminated soil. Underground tanks should be removed and contaminated soils disposed of, with



regulatory closure prior to construction on the site.

**3-16.2.2.2** Certain Government sites, usually on existing Government installations, may be included in a larger zone of petroleum contamination. In such cases, the Government may make a determination that the site is developable even with the presence of petroleum contamination. Site design should address possible vapor emissions and accommodate any existing monitoring wells, extraction wells or treatment facilities. Contractors will be required to have approved health and safety operating plans in place prior to commencing work on the site.

### **3-16.2.3 Munitions**

**3-16.2.3.1** Some Government sites will have had munitions storage, training, manufacturing, or handling facilities. In such cases, the site should be cleared of all munitions by Government ordinance disposal teams or contractors.

**3-16.2.3.2** Soil and groundwater sampling programs should identify any contamination issues from munitions, chemicals or related materials. The site should be cleared of munitions and related contamination, and have regulatory closure prior to construction on the site.

**3-16.2.4** Identification of ongoing site contamination due to off-site actions beyond control of the Government will be identified and measures to address the contamination developed.

## CHAPTER 4

### INDIVIDUAL SPACE CRITERIA

#### 4-1 GENERAL

**4-1.1** The individual space design criteria and information in this Chapter reflects typical guidance on usage and code compliance; the Design Agency should verify that it meets the Tenants' needs and complies with the specific code and other requirements of their project.

**4-1.2** This Chapter delineates the functional and environmental requirements for most individual spaces within the training center and maintenance buildings. Not all projects include all of the spaces, nor are all of the possible types of spaces included in this Design Guide. Specific information regarding the types and sizes of spaces authorized are determined by the project documents. The Using Service will supplement the information herein at the initial design conference; ~~13~~ within the control of the ACSIM-ODR Project Officer.~~3~~

**4-1.3** The space sizes noted below reflect current USAR authorizations for the spaces. The Using Service will provide the actual authorized area for each space in the project documents, and where there are differences between the areas in this Guide and the project documents, the project documents govern. Since the Government building authorization includes an allowance for structure, these are assumed to be net space authorizations. The Design Agency should endeavor to match the design to the authorized spaces, but it is acceptable for actual area of any space to vary from the authorization by plus or minus 10%, except for the assembly hall, which cannot be larger than authorized.

**4-1.4** The spaces listed in this Chapter are those common to most USAR units and facilities. There are additional spaces which are authorized only for certain types of Reserve Units. Information on the spaces, and their authorized area, can be found in AR 140-483.

**4-1.5** Occasionally, the Tenants will identify what they believe is a requirement for a space or function that is not in the project authorization documents. When such a requirement is approved by the Using Service, the space to accommodate must come "out of hide;" the Design Agency must borrow the necessary space from other spaces. One example of such a space is a photo identification room for making facility or installation identification cards for the Tenants and their dependents.

**4-1.6** All locksets should be mortise-type; functions are shown by specific space below.

**4-1.7** ~~12~~ Specify one individual trash receptacle for each private, shared and unit common workstations. Specify large trash receptacles with lids for assembly hall, break rooms, classrooms, library, physical readiness training and showers. Large trash

receptacles size base on room occupancy. /2/

**4-1.8** All equipment indicated for spaces below is part of the design and construction, unless noted as provided by Government or Tenants.

## **4-2 TRAINING CENTER BUILDING**

### **4-2.1 Full-time Offices**

**4-2.1.1** Full-time offices are used by permanent USAR staff for the daily administration tasks associated with the unit's mission and the operation of the facilities. The full-time staff typically works 8-hour days from Monday to Friday, and they are the major building Tenants during the week. Design of these spaces will be similar to a typical business office. \3\ Only certain grades and staff positions are authorized private office space. ACSIM-ODR may authorize additional offices if it will enhance the unit mission accomplishment./3/

**4-2.1.2** Full-time offices may be designed for a single occupant or for multiple occupants, based on Tenant requirements and functional efficiency. Avoid room arrangements that have the occupants' back to the door. In some cases, the Design Agency may wish to recommend combining some full-time offices for reasons of design efficiency or flexibility.

**4-2.1.3** \2\ Provide one each single quad power receptacle \3\ and one each voice/data outlet/3/ at each desk location to accommodate potential for a variety of equipment that may be utilized. On the "U" configured desk units, place \3\ these receptacles and outlets centered/3/ at the bridge location and on the "L" configured desk units, place \3\ these receptacles and outlets centered/3/ at the return location./2/ \3 \On the "U" configured desk units place a convenience power receptacle centered on the credenza. Mount these receptacles 15 inches (300 mm) above the finish floor./3/

**4-2.1.4** \2\ General Officer and staff suite, O6 Commanding Officers and O6 Commanding Officer's Command Sergeant Major offices shall be distinguished from typical private offices with the use of traditional wood furniture./2/ \3\ Grade of wood furniture is based on occupants rank, see the Army Reserve Customer's webpage on the USACE Louisville District's web site for more information /3/

### **4-2.1.5 Space Design Information**

#### **General/Code**

Size – 120 sf (11 sq m) each typical; larger for higher ranks; \3\ construct room with no dimension below 9 ft - 6 in (2900 mm) to accommodate furniture/3/

Occupancy – business

Occupancy count – varies; 1 person per workstation

#### **Architectural/Interiors**

Minimum STC rating – 40

Ceiling height – 8 ft - 8 in (2600 mm)

Floor – carpet **2**; VCT as an alternative  
Base – rubber  
Walls – painted gypsum board  
Ceiling – suspended acoustical ceiling tile (ACT)  
Trim – coat rack mounted on the wall behind the door  
Lockset – office

**Mechanical**

Heating, occupied – 68 degrees F (20 C); maintained – 55 degrees F (13 C)  
Cooling, occupied – 78.25 degrees F (25 C); maintained – ambient  
Ventilation – comply with ASHRAE 62.1

**Electrical**

Lighting – 50 fc  
Receptacles – convenience and **2** computer quad power outlet as described in  
4-2.1.3 **2**

Voice/data – two telephone/data outlets per desk unit/workstation

**1** Furniture

Desk unit with box/box/file and file/file pedestals  
Keyboard tray with mouse pad  
Overheads with task light  
Tackboard  
**3** High-Back desk chair  
Two guest chairs  
Lateral files and/or bookcases  
Contact Louisville District, Corps of Engineers for latest information on use of  
wood furnishings

**3** Specific layouts and components can be found on the Army Reserve  
Customer's webpage on the USACE Louisville District's web site **3**

**Equipment**

Verify if additional equipment required in some offices

**Special features or considerations 1**

**Figure 4-1**  
**Single Office**



**Figure 4-2**  
**Shared Office - A**

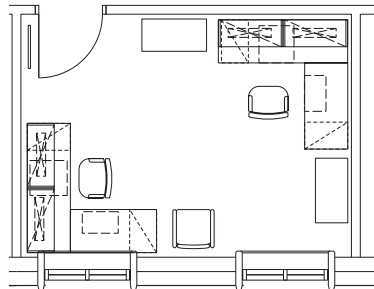

**Figure 4-3**  
**Shared Office - B**

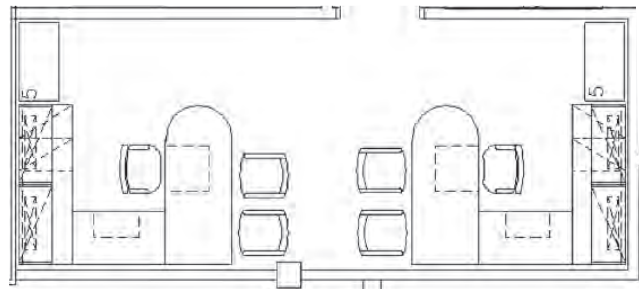

**4-2.2** Unit Exclusive Offices

**4-2.2.1** Unit exclusive offices are used periodically by USAR supervisors for training, training administration, and the operation of the units. The majority of the use will occur on drill weekends.

**4-2.2.2** Space Design Information: Design of these spaces will be same as the full-time offices above, and the same space design information applies.

#### 4-2.3 Unit Commons

**4-2.3.1** Unit commons provide working areas and workstations for the USAR soldiers, for training and administrative tasks. Use typically occurs on the soldiers' drill weekends, with different units and soldiers using the spaces on different weekends. **2** Each unit common workstation is authorized approximately 100 sq ft, which includes circulation, common-use file cabinets and work areas. **2** Circulation from the allocation for the building must be used to provide sufficient space for a functional unit common space. Some of those who prepare project authorizations allow for this and shift space from circulation to unit commons when preparing the space allocation worksheet.

**4-2.3.2** **1** Panel-based systems furniture workstations are typically used in open offices, although metal desk-based furniture workstations may be used in small open offices often included in OMS buildings. Workstations for open offices may be configured for individual workstations, groups or clusters of workstations, or a combination of individual and group workstations. Additional counters or furniture may be required to accommodate Tenants' equipment, such as printers, coffee makers, and similar items (these are not to be powered from the panel-based systems furniture or the metal desk-based furniture). The Tenants should be asked to provide information on their other equipment and space needs. Contact Louisville District, Corps of Engineers for latest information on Unit Commons workstation requirements. **1**

**4-2.3.3** **3** Provide power and telecommunication services through adjustable, multi-service floor boxes or fire-rated poke throughs for areas where system furniture is not against fixed walls or columns. Floor boxes or fire-rated poke throughs should be provided for worktables (one outlet per four seating positions or fraction thereof), counters, or cabinets that are not against fixed walls or columns. Designer should provide dimensioned drawings with locations of floor boxes for power, data and phone. **3**

**4-2.3.4** In addition to the files provided in the workstations, the Design Agency should try to provide sufficient space for common-use file cabinets in most unit commons.

#### 4-2.3.5 Space Design Information

##### General/Code

Size – 60 sf (5.6 sq m) each authorized unit common space, plus 15% of total for circulation

**Figure 4-4**  
**Unit Commons**

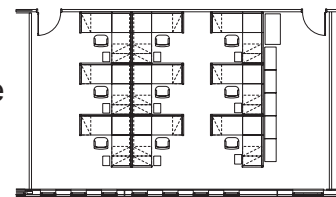

**Figure 4-5**  
**Unit Commons**

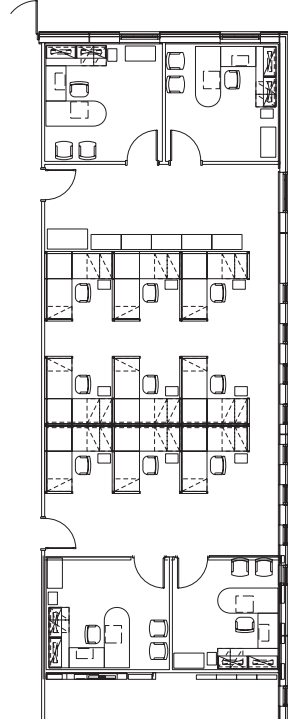

Occupancy – business

Occupancy count – varies; 1 person per workstation or seat

**Architectural/Interiors**

Minimum STC rating – 40

Ceiling height – 8 ft - 8 in (2600 mm)

Floor – carpet **/2\**tile**/2\**

Base – rubber

Walls – painted gypsum board

Ceiling – suspended acoustical ceiling tile (ACT)

Trim – **/2\** coat racks mounted on wall **/2\**

Lockset – office

**Mechanical**

Heating, occupied – 68 degrees F (20 C); maintained – 55 degrees F (13 C)

Cooling, occupied – 78 degrees F (25 C); maintained – ambient

Ventilation – comply with ASHRAE 62.1

**Electrical**

Lighting – 50 fc

Receptacles – convenience duplexes

**/3\** Voice/data- two voice/data outlets per workstation, wall phone outlet for common use areas, voice/data outlet for common area copiers, printers and FAX machines.**/3\**

**/1\ Furniture**

**/3\** Panel Based Workstations - Specific layouts and components can be found on the Army Reserve Customer's webpage on the USACE Louisville District's web site

Each box/box/file pedestal at a workstation shall have a pencil tray and be keyed differently**/3\**

**Equipment**

Verify if common-use printers, faxes, coffee makers, etc., will be provided by Tenants. Cabinets with counters may be provided.

**Special features or considerations**

Consider sinks with goose neck faucets for coffee stations in larger commons

Dedicated 20A circuits for any large printers

Circulation space must come from facility circulation allowance **/3V3\**

Some Tenants prefer to have team groupings of workstations, or a few table/chair stations which can also function as meeting areas **/1\**

**4-2.4 Recruiting/Retention Office**

**4-2.4.1** This space is for unit retention personnel and is used primarily for administrative purposes. This space is also where potential members and re-enlistees are interviewed. The retention office must be easy to locate, adjacent to the main entrance, and adjacent to fulltime recruiting personnel. This space is shared by all assigned units.

**4-2.4.2** There will also be an office to accommodate two full-time recruiting personnel, as part of the full-time office space authorization. It should be located adjacent to the



recruiting/retention office. Glazed panels (door or sidelight) may be used to emphasize public accessibility.

#### 4-2.4.3 Space Design Information

##### **General/Code**

Size – 250 sf (23.25 sq m) each typical

Occupancy – business

Occupancy count – 1 to 4

##### **Architectural/Interiors**

Minimum STC rating – 40

Ceiling height – 8 ft - 8 in (2600 mm)

Suspended acoustical ceiling tile. (ACT)

Walls - Painted gypsum board.

Floor – carpet **2**

Base – rubber

Trim – **1** coat rack mounted on the wall behind the door **2**

Lockset – office

##### **Mechanical**

Heating, occupied – 68 degrees F (20 C); maintained – 55 degrees F (13 C)

Cooling, occupied – 25 degrees C (78 F); maintained – ambient

Ventilation – comply with ASHRAE 62.1

##### **Electrical**

Lighting – 50 fc

Receptacles – convenience and computer duplexes

Voice/data – telephone and data outlets

##### **1 Furniture**

Desk Units similar to full-time offices above with two (2) guest chairs each desk unit

Lateral file for each desk unit

Bookcase

Freestanding literature rack **3** **3**

Lounge chairs or table and chairs in a seating area as space allows

**3** **3**

##### **Equipment**

Verify if printers, fax machines, coffee machines, etc., will be provided by Tenants

Dedicated 20A circuit for any large printer

##### **Special features or considerations**

Space for Tenants' literature racks may be required **1**

**Figure 4-6**  
**Recruiting /**  
**Retention Office**

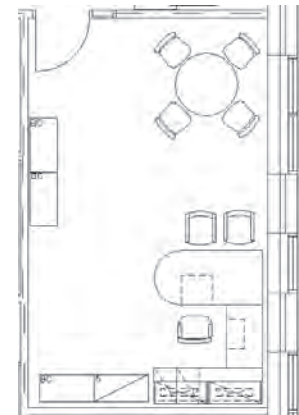

#### 4-2.5 Family Support Office

**4-2.5.1** This space is for the use of the Tenants' family support groups, and for unit members' families when they are meeting with the family support groups. It should be located near the main entry to be easily accessible to the visiting family members. The

space authorization is typically 200 sf (18.6 sq m).

**4-2.5.2** Consider providing a window or door sidelight into an adjacent lobby or corridor but provide blinds to allow for privacy when needed.

**4-2.5.3** Furniture should be coordinated with the Tenants, most prefer some workspaces with visitor chairs, and a seating group around a coffee table. Consider a small refrigerator for drinks for visiting family members.

**4-2.5.4** Space Design Information: Design of these spaces should be similar to the recruiting/retention offices above and the same space design information applies.

#### **4-2.6 Administrative Support**

##### **4-2.6.1 Mail Room**

**4-2.6.1.1** The mail room is the point for receipt and distribution of all interoffice and intraoffice correspondence. This space will not be staffed full-time, but will provide a mail screening, sorting and pickup area. **3** For Reserve Centers on installations, the mail room may need to be re-configured based on central mail screening facility and processes.**3**

**4-2.6.1.2** The mail room should be enclosed and equipped with a lockable door and should be designed to maximize wall space. A vestibule for picking up mail is required, rather than having mail slots open into the lobby or corridor. A Postal Service approved mailbox unit is provided; coordinate size and number of mail slots with Tenants. Most Tenants prefer mail slots that will accommodate **3** 9 inch by 12 inch **3** envelopes without folding.

**4-2.6.1.3** **3** The mail room authorization should be divided into two spaces: a screening room and a sorting room. A third adjacent space, the vestibule, counts as part of the building's circulation allowance. The screening room is on an exterior wall, where mail/UPS is brought directly into the building and checked for potential threats (e.g., letter bombs, corrosive materials, etc.). The screening room should have floor-to-structure reinforced CMU walls.**3**

**4-2.6.1.4** **3** Adjoining the screening room is the sorting room.**3** Mail sorting/handling rooms will have gypsum board walls **3** with metal mesh**3** from floor to structure, and a gypsum board ceiling to provide evidence of attempted entry.

**Figure 4-7**  
**Mail Room**

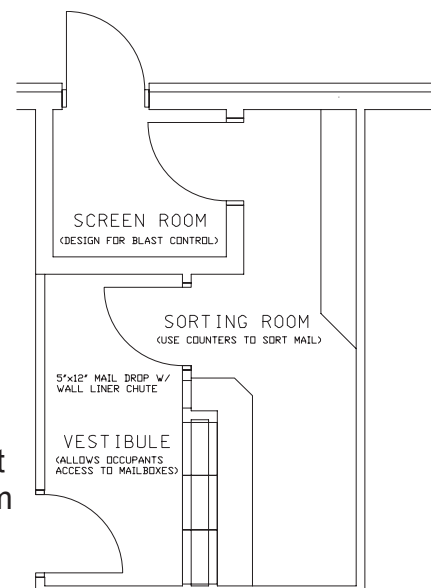

#### 4-2.6.1.5 Space Design Information

##### **General/Code**

Size – varies

Occupancy – business

Occupancy count – 1 person per 100 sf (9.3 sq m)

##### **Architectural/Interiors**

Minimum STC rating – 40

Ceiling height – 8 ft - 0 in (2600 mm)

Floor – VCT **2/2/**

Base – rubber

Walls – painted gypsum board/ **2\ CMU/2/**

Ceiling – suspended acoustical ceiling tile (ACT)

Trim – none

Lockset – office

##### **Mechanical**

Heating, occupied – 68 degrees F (20 C); maintained – 55 degrees F (13 C)

Cooling, occupied – 78 degrees F (25 C); maintained – ambient

Ventilation – comply with ASHRAE 62.1

**3\** HVAC system shall comply with UFC 4-010-01 and ductwork for other systems should not pass through the mailroom, mailroom ductwork should not pass through other spaces, segregate intake and exhaust as much as practical given these constraints.**/3/**

##### **Electrical**

Lighting – 50 fc; dual-level switching

Receptacles – convenience duplex, some at counter height

Voice/data – telephone and data outlets

##### **3\ Furniture**

Table sized appropriately for the screen room

Medium trash bin**/3/**

##### **Equipment**

Verify if postage or other machines require power

Upper and lower cabinets with counters for work space and storage

##### **Special features or considerations**

**2\** Follow mailroom criteria listed in UFC 4-010-01 **/2/**

Some units locate a large copier in this space.

#### 4-2.6.2 Reproduction

**4-2.6.2.1** This space provides for the reproduction and collating of administrative correspondence, bulletins, orders, and similar paperwork. The space may also house hard copy printers connected to computers in the office space or to the LAN. Diazo or blueprint reproduction is not typically included in this space.

**4-2.6.2.2** The reproduction space should be located adjacent to the administration space. The space must be large enough to accommodate the Tenants' copiers, and have table or counter space for collating and binding. Sufficient storage space should

be provided for operating quantities of paper, toner, ink, office supplies, forms, etc. The size of this area will be relative to the size of the unit and specific reproduction requirements.

#### 4-2.6.2.3 Space Design Information

##### **General/Code**

Size – varies

Occupancy – business

Occupancy count – 1 person per 100 sf (9.3 sq m)

##### **Architectural/Interiors**

Minimum STC rating – 40

Ceiling height – 8 ft - 8 in (2600 mm)

Floor – VCT **V2/V2/**

Base – rubber

Walls – painted gypsum board

Ceiling – suspended acoustical ceiling tile (ACT)

Trim – none

Lockset – classroom

Cabinets with counters for work space and storage.

##### **Mechanical**

Heating, occupied – 68 degrees F (20 C); maintained – 55 degrees F (13 C)

Cooling, occupied – 78 degrees F (25 C); maintained – ambient

Ventilation – comply with ASHRAE 62.1

##### **Electrical**

Lighting – 50 fc

Receptacles – convenience duplexes

Voice/data – wall-mounted telephone

##### **Furniture**

Verify equipment by Tenants and power/data requirements

**V3** Medium Trash can **/3/**

##### **Equipment**

Cabinets with counters for work space and storage

##### **Special features or considerations**

Large copiers may require exhaust

**V3**

**Figure 4-8**  
**Copy Room**

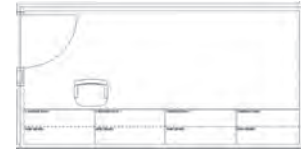

#### 4-2.7 Information Technology (IT) Spaces

##### 4-2.7.1 IT Spaces - General Information

**4-2.7.1.1** The Army Reserve IT spaces described below are the spaces in an Army Reserve facility that are dedicated to housing telecommunication service and distribution provisions for the facility, or to providing space solely for User data processing and telecommunications operations. Almost all Army Reserve spaces have some IT provisions to allow Users access to data or communications; the spaces described below have data access and telecommunication as their primary purpose.

**4-2.7.1.2** Descriptions and requirements for most Army Reserve IT spaces are found below. The information for IT spaces listed here are in addition to what is specified in the Army Reserve IT Manual. It is intended to be space design specific and used by the designer of the Army Reserve facility. Detailed floor plans for the Entrance Facility (EF) Telecommunications Equipment Room (TER) and Telecommunications Room (TR) are in the Army Reserve IT Manual. The Army Reserve IT Manual is available at [www.lrl.usace.army.mil/ed2/default.asp?mycategory=212](http://www.lrl.usace.army.mil/ed2/default.asp?mycategory=212).

**4-2.7.1.3** The space sizes listed below are typical or minimum sizes for Army Reserve facilities. Authorized areas for spaces for individual projects will be provided in the project documentation, particularly in the 1391.

**4-2.7.1.4** The IT spaces described require a space allocation equal to approximately 1.1% of the net Training Center area (net area equals gross building area minus structural, circulation, mechanical, toilets, and similar support areas). This 1.1% allocation provides unoccupied space for operating and distribution of the IT system and infrastructure. It is intended to provide sufficient space for EF, TR, TER and similar IT operation and distribution spaces.

**4-2.7.1.4.1** As of the date of this change, the 1.1% allocation has not been incorporated into AR 140-483, Army Reserve Land and Facilities Management, Appendix B, and so may not be reflected in the individual project 1391 at present. The Army Reserve Project Officer must authorize deviations from the project 1391 for compliance with this guide. If authorized by the Project Officer, the space will come from 1391 authorizations for Network Ops Center and Demarc; it's likely some space may come "out of hide."

**4-2.7.1.5** The light levels called for in the TER and TR are minimum horizontal illumination levels measured at the front and back faces of the IT racks. Closely coordinate light fixture locations to avoid conflicts with IT racks and cable tray. Do not block access to IT racks or cable tray and do not block light fixtures from providing the required illumination levels.

**4-2.7.1.6** Provide fire protection systems for the EF, TER, TR spaces. Coordinate the location of the sprinkler heads in the rooms with the equipment in the rooms. Comply with TIA-569-B fire Protection.

#### **4-2.7.2** Entrance Facility (EF)

**4-2.7.2.1** The purpose of this room is to isolate telecommunication service provider equipment and provisions from the remainder of the facility telecommunications infrastructure. Due to Government servers and other equipment in the TER, the EF is required to be a separate space to maintain security of TER from service provider personnel

**4-2.7.2.2** This space is optimally located on the perimeter of the building, and on the side of the building closest to utility connection point. Provide access to the space from

inside the building; no windows are desired. Refer to Figure 3-2 in the Army Reserve IT Manual for a typical EF plan view drawing.

#### 4-2.7.2.3 Space Design Information

##### **General/Code**

Size –80 sf (7.5 sq m) typical

Occupancy – business

Occupancy count - unoccupied

##### **Architectural/Interiors**

Minimum STC rating – 40

Ceiling height – 10 ft (3050 mm) minimum height to structure

Floor – static-dissipative VCT

Base – rubber

Walls – painted gyp board or painted CMU continuous to structure

Ceiling – none; painted structure

Trim – none

Lockset – storeroom or classroom

##### **Mechanical**

Heating –maintain 64° F (18° C)

Cooling – maintain 78° F (25° C) when active devices are present; otherwise ambient

Ventilation – comply with ASHRAE 62.1

##### **Electrical**

Lighting – 50 fc (540 lux)

Receptacles – See Chapter 3

Voice/data – one telephone jack

##### **Furniture**

No furniture required

##### **Equipment**

Refer to IT Manual for equipment requirements/3/

##### **Special features or considerations**

Fire-resistant plywood backboards on two adjacent walls

No special security requirements

Provide wire cages over sprinkler heads and drainage troughs below sprinkler pipes

#### 4-2.7.3 Telecommunications Equipment Room (TER)

**4-2.7.3.1** This space is provided to house file and print servers, data switches and the telephone switch. It will typically be located in the main building of a multi-building facility, normally the Reserve Center building. It is the main telecommunications distribution point for its building and the facility.

**4-2.7.3.2** The TER may serve as the TR for the floor it occupies; larger buildings or building configuration may require additional TRs on that floor.



**4-2.7.3.3** A central location is optimal for efficiency of cable distribution. Provide access into the space from the interior of the building; the TER may not provide access to any other spaces. Buffer the space from electrical and mechanical rooms and equipment, in order to minimize the potential for signal interference and ductwork/cable tray conflicts. No windows are desired. Refer to figure 3-3 in the Army Reserve IT Manual for typical TER plan drawing.

#### **4-2.7.3.4 Space Design Information**

##### **General/Code**

Size – 120 sf (11.2 sq m) minimum; provide adequate space to accommodate facility IT requirements

Occupancy – business

Occupancy count - unoccupied

##### **Architectural/Interiors**

Minimum STC rating – 40

Ceiling height – 10 ft (3050 mm) minimum height to structure

Floor – static-dissipative VCT

Base – rubber

Walls – painted gyp board or painted

CMU, continuous to structure

Ceiling – none; painted structure

Trim – none

Lockset – storeroom or classroom

##### **Mechanical**

Heating – maintain 64° F (18° C)

Cooling – maintain 78°F (25° C)

Ventilation – comply with ASHRAE 62.1

Humidity – maintain between 30 and 55 percent relative humidity

##### **Electrical**

Lighting – 50 fc (540 lux)

Receptacles – convenience duplexes - See Chapter 3 of the Army Reserve IT Manual

Voice/data – one telephone jack

##### **Furniture**

Small 30 x 36 inch table with CPU sling/3/

##### **Equipment**

Four standard floor mounted 19" (480 mm) telecommunications racks, minimum

Any UPS required will be provided by USARC, not project

##### **Special features or considerations**

Fire-resistant plywood backboards on two adjacent walls for service punch-down and termination

No special security requirements

Provide wire cages over sprinkler heads and drainage troughs below sprinkler pipes

#### 4-2.7.4 Telecommunications Room (TR)

4-2.7.4.1 These spaces serve as distribution points for workstation voice and data cables, and other terminations.

4-2.7.4.2 Provide TRs as necessary to maintain compliance with EIA/TIA link distribution length limit, at a minimum, and as building configuration dictates. One TR per building floor is required, except in buildings with minimal telecommunications provisions, such as Unheated Storage buildings. Unit Storage buildings with supply offices require a TR. Refer to figures 3-4 and 3-5 in the Army Reserve IT Manual for typical TR plan views and rack elevation drawings.

4-2.7.4.3 A location near the center of the building is optimal for distribution, and TRs in multi-story buildings will be stacked unless there is a strong reason not to do so. No windows are desired. Buffer from electrical and mechanical rooms and equipment, in order to minimize the potential for signal interference and ductwork/cable tray conflicts.

#### 4-2.7.4.4 Space Design Information

##### **General/Code**

Size – 80 sf (7.5 sq m) minimum; provide adequate space to accommodate zone IT requirements

Occupancy – business

Occupancy count - unoccupied

##### **Architectural/Interiors**

Minimum STC rating – 40

Ceiling height – 10 ft (3050 mm) minimum height to structure

Floor – static-dissipative VCT

Base – rubber

Walls – painted gyp board or painted CMU, continuous to structure

Ceiling – none

Trim – none

Lockset – storeroom or classroom

##### **Mechanical**

Heating – maintain 64° F (18° C)

Cooling – maintain 78° F (25° C)

Ventilation – comply with ASHRAE 62.1

Humidity – maintain between 30 and 55 percent relative humidity

##### **Electrical**

Lighting – 50 fc (540 lux)

Receptacles – convenience duplexes - See Chapter 3 of the Army Reserve IT Manual

Voice/data – one telephone jack

##### **Equipment**

Two standard floor mounted 19" (480 mm) telecommunications racks, minimum, for Reserve Center TRs - OMS, Storage and similar less IT-intensive buildings may require only one rack per TR; provide as building

telecommunication requirements dictate

**Special features or considerations**

Fire-resistant plywood backboards on two adjacent walls for service punch-down and termination

No special security requirements

Provide wire cages over sprinkler heads and drainage troughs below sprinkler pipes

**4-2.7.5 IT Work Space**

**4-2.7.5.1** This room is provided only for General Officer command facilities. It is intended to provide space for set-up, testing and repair of IT equipment. It is not intended to provide IT storage space, which can be accommodated in Unit Storage.

**4-2.7.5.2** The room is best located adjacent to G6 administrative space, but as a separate, lockable room.

**4-2.7.5.3 Space Design Information**

**General/Code**

Size – 100 sf (9.3 sq m)

Occupancy – business

Occupancy count – one person

**Architectural/Interiors**

Minimum STC rating – 40

Ceiling height – 8 ft - 8 in (2600 mm) minimum

Floor – static-dissipative VCT

Base – rubber

Walls – painted gyp board or painted CMU

Ceiling – suspended acoustical ceiling tile

Trim – none

Lockset – storeroom

**Mechanical**

Heating – occupied maintain 68° F (20° C): unoccupied maintain 55° F (13° C)

Cooling – maintain 78° F (25° C)

Ventilation – comply with ASHRAE 62.1

Humidity – maintain between 30 and 55 percent relative humidity

**Electrical**

Lighting – 50 fc (540 lux)

Receptacles – See Chapter 3

Voice/data – one telephone jack, and continuous metal raceway extending the full length of the work surface with data outlets at 6 inches on center

**Furniture**

Static dissipative workbench with shelf

Stool with woven upholstery

Lockable storage cabinet

**Figure 4-9**  
**IT Work Space**

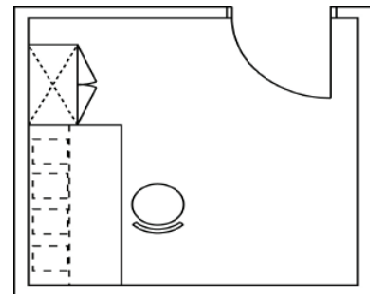

**Equipment**  
**Special features or considerations**  
*/3/*

**4-2.8** Lobby

**4-2.8.1** The lobby provides an entryway and reception area for unit personnel and visitors. It is one of the first images observed by visitors, and should reflect feelings of pride and commitment characteristic of the Army Reserve.

**4-2.8.2** As the primary public entrance to the training center building, the entry must be readily identifiable from the parking lot and pedestrian access routes. The entrance should have an adequate exterior overhang or vestibule, and the design should provide an ordered, warm, friendly invitation to the public.

**4-2.8.3** The lobby must be adjacent to a permanently staffed office since there is no receptionist, and must accommodate circulation, traffic patterns and waiting space. Graphic displays, such as Minuteman and units' plaques, trophies and awards, should be placed in a visually prominent location.

**4-2.8.4** Space Design Information

**General/Code**

Size – 480 sf (44.6 sq m); may augment from circulation space

Occupancy – business; may be assembly if associated with assembly hall

Occupancy count – 1 person per 100 sf (9.3 sq m); more if considered assembly waiting space

**Architectural/Interiors**

Minimum STC rating – 40

Ceiling height – 9 ft (2750 mm) minimum

Floor – **2** porcelain paver**/2/**

Base – **2** porcelain paver**/2/**

Walls – painted gypsum board

Ceiling – gypsum board; suspended ACT as an alternative

Trim – guardrail and wall or corner guards to protect walls

Lockset – panic hardware; locksets are Tenant preference

**Mechanical**

Heating, occupied – 68 degrees F (20 C); maintained – 55 degrees F (13 C)

**3** Cooling, occupied – 78 degrees F (25 C); maintained – ambient **/3/**

Ventilation – comply with ASHRAE 62.1

**Electrical**

Lighting – 20 fc

Receptacles – convenience duplexes

Voice/data – pay phones

**1** Furniture

Lounge / sofa chairs **3** **/3/**

**Figure 4-10**  
**Lobby**

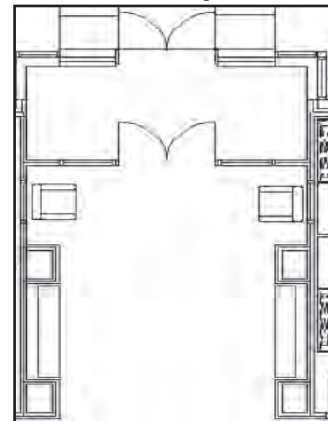

Wood occasional tables  
Freestanding literature rack \3\ /3/

**Equipment**

\3\ Built-in Trophy and display cases/3/

**Special features or considerations**

Verify if Tenants require card readers, door security, CCTV, etc.

Special lighting for displays

Building directory

Finishes in this space may be upgraded for image reasons

Exterior building finishes may be incorporated into the area to provide a transition into the building

USAR does not want wall vinyl due to difficulty of repair

Concealed sprinkler heads for esthetics/1/

**4-2.9 Assembly Hall**

**4-2.9.1** The assembly hall provides space for troop formations, maintenance of equipment, personnel assemblies, food service seating and large group assemblies for instructional training. It is a multipurpose space which will be used for any large indoor events associated with the facility. \3\ The Assembly Hall shall be an open space with no internal columns or supports./3/

**4-2.9.2** Tenants occasionally request that the assembly hall be divided with operable panel partitions to enable its use as additional classrooms or a conference center; this requires Using Service approval. In this configuration, an adjacency to the other classrooms should be considered.

**Figure 4-11  
Assembly Hall and Kitchen**

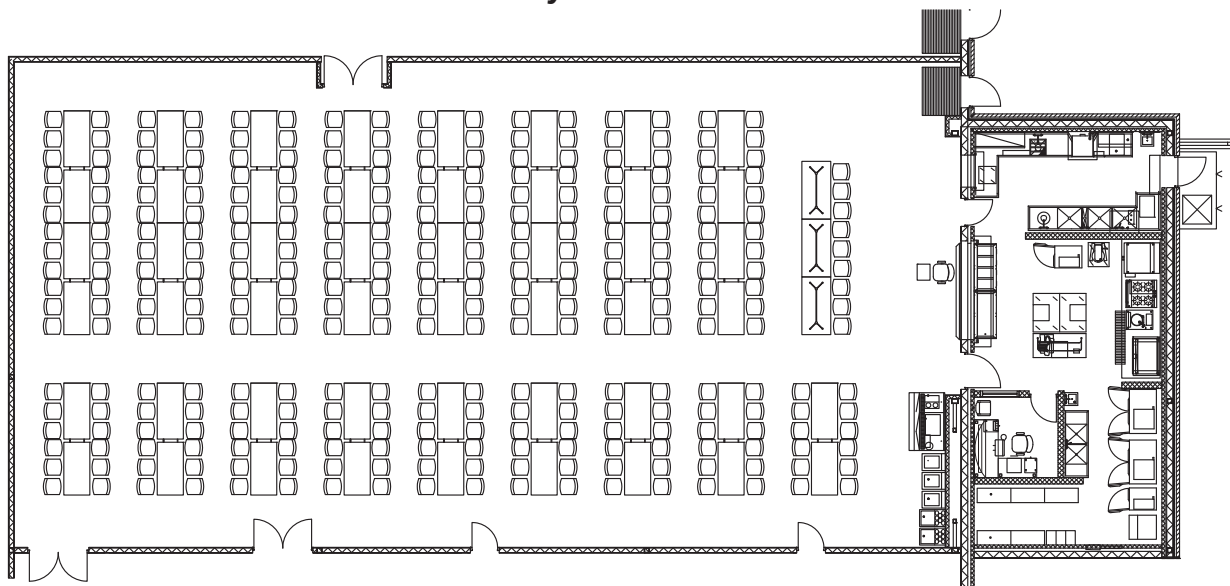

**4-2.9.3** Tenants also occasionally request an overhead door to allow vehicle entry for loading for maneuvers; this was typical in older armories, but is discouraged now. If

approved by the Using Service, the assembly hall finishes should be downgraded to reflect this more utilitarian function and \3\ mechanical system will need to address vehicle exhaust./3/

#### 4-2.9.4 Space Design Information \3\ Figure Change /3/

##### **General/Code**

Size – varies

Occupancy – assembly

Occupancy count – varies; typically less intensive use assembly space

##### **Architectural/Interiors**

Minimum STC rating – 40

Ceiling height – 14 ft (4300 mm)

Floor – VCT; concrete with sealer or paint if truck access

Base – rubber

Walls – painted gypsum board; painted CMU if truck access

Ceiling – suspended acoustical ceiling tile (ACT); none if truck access

Trim – \2\ none/2/

Lockset – panic hardware

##### **Mechanical**

Heating, occupied – 68 degrees F (20 C); maintained – 55 degrees F (13 C)

Cooling, occupied – 78 degrees F (25 C); maintained – ambient

Ventilation – comply with ASHRAE 62.1

##### **Electrical**

Lighting – 50 fc; dual-level switching

Receptacles – convenience receptacles

Voice/data – two voice/data outlets per wall

##### **\1\ Furniture**

\3\ Fold-up, mobile, cafeteria tables with stackable chairs with chair dollies

Folding tables and table dolly with additional stackable chairs and chair dolly for registration, banquet table etc/3/

Mobile floor lectern

Adjustable stool with or without arms

##### **Equipment**

Public address system with speakers and microphone outlets – contractor-supplied

Ordinary hazard sprinklers

Marker boards and projection screens may be added if Tenants desire

##### **Special features or considerations**

Typically must be separated from adjacent spaces with rated wall.

If the ceiling is not suspended acoustical tile, the acoustics of the room must be addressed

If operable partition is included, provide structural support and stacking space

\3\ Ensure that door to chair storage is tall enough to accommodate the height of furniture items in their mobile configuration

/3//1/



#### 4-2.10 Chair and Table Storage

**4-2.10.1** This space is for the storage of the assembly hall tables and chairs when not in use. \1\ The PA system for the assembly hall is also typically located here. The PA system shall have wireless clip-on type microphones./1/

**4-2.10.2** This space should not be used for mechanical equipment or electrical panels due to the potential for damage to them or obstruction by the stored furniture.

#### 4-2.10.3 Space Design Information

**Figure 4-12**  
**Chair and Table Storage**

##### **General/Code**

Size – 10% times assembly hall authorized area

Occupancy – business

Occupancy count – 1 person per 100 sf (9.3 sq m)

##### **Architectural/Interiors**

Minimum STC rating – 40

Ceiling height – 10 ft (3050 mm)

Floor – \2\ VCT/2/

Base – rubber

Walls – painted gypsum board; painted CMU as alternative

Ceiling – suspended acoustical ceiling tile (ACT)

Trim – wall guard to protect walls

Lockset – storeroom on active leaf; flush bolts inactive

##### **Mechanical**

Heating, occupied – 68 degrees F (20 C); maintained – 55 degrees F (13 C)

Cooling, occupied – none; maintained – none

Ventilation – comply with ASHRAE 62.1

##### **Electrical**

Lighting – 10 fc

Receptacles – convenience duplex plus dedicated outlet for PA

Voice/data – none

##### **\1\ Furniture**

Table dolly for assembly hall registration/banquet/etc folding tables

Chair dollies for assembly hall stacking chairs

Storage cabinet for PA system for Assembly Hall

##### **Equipment**

PA system for Assembly Hall with amplifier and minimum of two (2) or three (3) wireless clip-on type microphones

##### **Special features or considerations**

Conduit to roof-mounted AM/FM antenna may be desired voice/data outlet for office

\3V3/Ensure that the door into chair storage is tall enough to accommodate the height of furniture items in their mobile configuration/1/

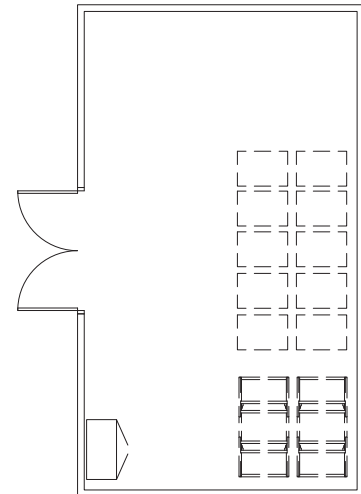

#### 4-2.11 Kitchen ([See Also Appendix E](#))

**4-2.11.1** The kitchen module provides space for training of cooks, and for preparation of meals. It includes space for food preparation, cooking, serving and for the storage and cleaning of cookware and serving ware, and is divided into four areas: \3\ Kitchen, Scullery, Kitchen Office, and Food Storage. This is a standard kitchen; any changes to the kitchen or equipment must be approved by the ACSIM-ODR Project Officer. Standard Architectural drawings, including enlarged equipment plans, elevations, sections and Equipment Schedules, are available for download from the Army Reserve FTP Download site link located on [www.lrl.usace.army.mil/ed2/default.asp?mycategory=212](http://www.lrl.usace.army.mil/ed2/default.asp?mycategory=212). Also available on the web site are Mechanical, Plumbing and Electrical informational sheets./3/

**4-2.11.2** The kitchen area is the area where food is prepared, cooked, and served. The scullery is the area where soiled cooking and serving ware is cleaned, and stored when clean. The food storage area provides space for storage of perishable and nonperishable food, and kitchen supplies. The office provides administrative space for the kitchen supervisor.

**4-2.11.3** Security requires \3\ /3/coiling doors at the openings for food serving and tray return between the kitchen and Assembly Hall. Code analysis may require these coiling to be fire rated doors and on smoke-detector-activated hold-opens.

#### 4-2.11.4 Space Design Information

##### **General/Code**

Size – 811 sf (75.3 sq m), includes the Kitchen Office

Occupancy – business

Occupancy count – 1 person per 100 sf (9.3 sq m)

##### **Architectural/Interiors**

Minimum STC rating – 40

Ceiling height – 8 ft - 8 in (2600 mm)

Floor – \2\ textured quarry tile in walk area \3\ to include Kitchen Office/3/, smooth quarry tile under equipment /2/ \3\; with epoxy grout/3/

Base – \3\ Quarry tile with epoxy grout/3/

Walls – \2\ Ceramic Tile with epoxy grout on CMU/2\3\; Ceramic tile with epoxy grout on cement board as an alternative; Epoxy-painted water resistant gypsum wall board as an alternative for the Kitchen Office only/3/

Ceiling – \3\Skim coated/3/ and epoxy-painted cement board; \3\ suspended ACT as an alternative for the Kitchen Office Only/3/

Trim – stainless steel corner guards, door kick plates; \3\ coat rack mounted on the wall behind the kitchen office door /3/

Locksets – office, classroom, storeroom and panic

##### **Mechanical**

Heating, occupied – 68 degrees F (20 C); maintained – 55 degrees F (13 C)

Cooling, occupied – 80 degrees F (27 C); maintained – ambient

Ventilation – comply with ASHRAE 62.1 and NFPA 96

### Electrical

Lighting – 50 fc for office and 70 fc for kitchen; 30 fc for scullery and food storage

Receptacles – convenience duplex in addition to equipment requirements

Voice/data – voice/data outlet for office

### 1\ Furniture, Kitchen Office

13\ Double pedestal desk or “L” shaped desk unit/3/

Mid-back desk chair with arms.

Lateral file

### Equipment

See [Appendix E](#)

### Special features or considerations

Exhaust hood over cooking equipment – verify fire protection requirements,

12\ limited to wet chemical or automatic sprinkler system installed in accordance with NFPA 96 – direct-fired makeup air unit per NFPA 96 /2/

Typically must be separated by rated construction

Wet location light fixtures

12\ Contactor/2/ to shut down power to equipment under hood – coordinate with fire protection

A grease trap must be provided

May require an adjacent exterior concrete pad for MKT - 30 ft by 30 ft (9.2 sq m by 9.2 sq m) /1/

12\ Locate fire suppression cabinet along path of egress./2/

## 4-2.12 Arms Vault

**4-2.12.1** The arms vault provides secure storage of all weapons assigned to units at the facility. Ammunition may be stored in small amounts in some instances. The arms vault will not be located on an exterior wall.

**4-2.12.2** Construction of the vault is governed by AR 190-11, and will be cast-in-place, reinforced concrete. In general, walls must be 8 in 12\ (205 /2/ mm) thick minimum, reinforced with #4 (13 mm) reinforcing bars at 9 in (230 mm) on center each way, each face, with the two layers staggered, to provide a projected 4-1/2 in (115 mm) grid. Ceilings must be a minimum of 8 in (205 mm) thick, with a minimum reinforcement of #4 (13 mm) reinforcing bars forming a grid such that no opening exceeds 96 sq in (62,000 sq mm). Structural floors will be equivalent to ceiling requirements. Slabs on grade will be 6 in (153 /2/ mm) thick with #3 at 12\ 12” /2/ o.c. each way (#10 bars at 300 mm o.c. each way). Refer to AR 190-11, Chapter 4 and Appendix G, for additional vault construction requirements, including securing rings for securing the weapons in the racks. The structural documents must prominently display the following note: 13\ “Concrete placement for arms vault walls and roof may not proceed until written security certification and Contracting Officer approval is received. Certification can only proceed after reinforcing steel is in place. The contractor shall provide the Contracting Officer a two week notice, minimum, prior to concrete placement for the security inspection to take place. Be aware that separate concrete placements for various portions of the vault must have separate inspections. It is the Contracting Officer’s responsibility to obtain

security certification from Army Reserve Security Specialists, Provost Marshal with authority over project or the Project Engineer. The various stages of the vault construction requiring an authorizing inspection shall occur with the individual listed above or an approved representative of the certifying individual listed above”/3/

**Figure 4-13**  
**Armorer's Room and Arms Vault**

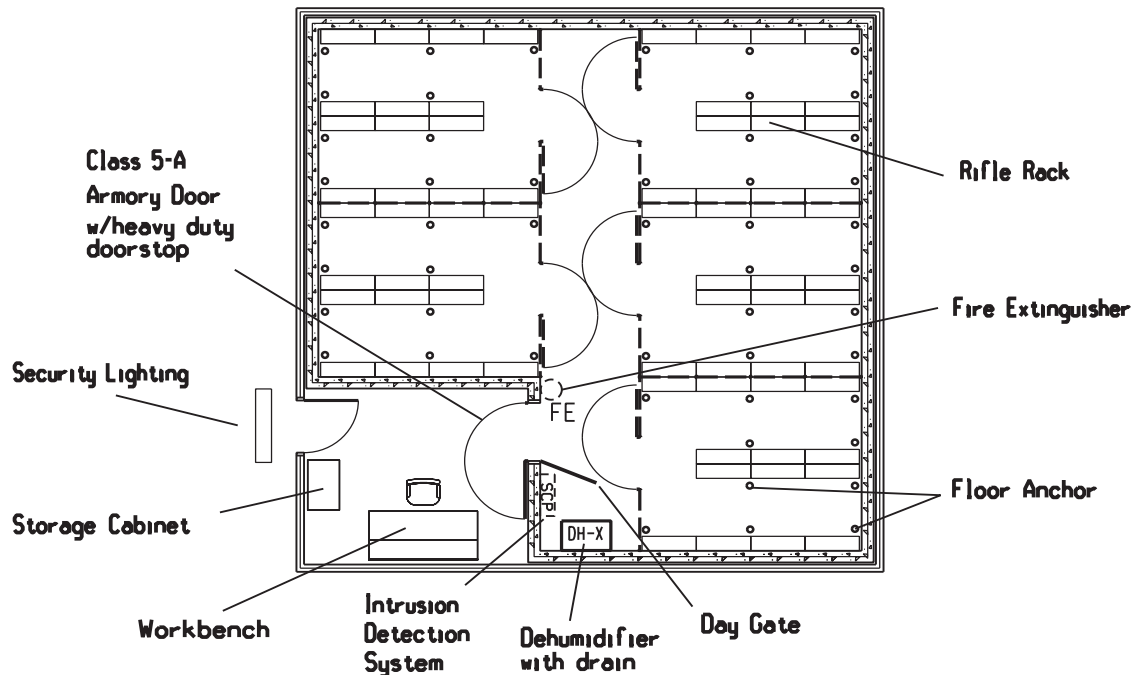

**4-2.12.3** A 13\ GSA approved Class 5-A Armory /3/ door capable of swinging open 180 degrees, with a heavy duty doorstop, will be provided. Day gates, with a pass-through capability for issuing weapons, may be provided if Tenants desire.

**4-2.12.4** 12\ Provide for an intrusion detection system (IDS) (some installations the IDS will be required as part of the contract, other places rough-in for the system is all that is required)./2/ Provide floor anchors for weapons racks. An alarm control box will be placed outside the caged areas, but inside the vault. Refer to AR 190-11 for security criteria. Electrical power is to be provided through a non-fused 30 amp disconnect switch, located in the arms vault, to a lockable 30 amp disconnect switch fused for 20 amps, connected ahead of the main in the electrical room. A 3/4 in (19 mm) rigid conduit will be provided from the telephone terminal board to a junction box located in the arms vault and a 3/4 in (19 mm) rigid conduit from the arms vault junction box to a recessed junction box mounted on the building exterior.

**4-2.12.5** Provide a 110 volt outlet and a 2 in (50 mm) diameter floor drain for the dehumidifier. These should be located adjacent to each other and outside of the caged areas.

**4-2.12.6** Battery backup, fluorescent fixtures to illuminate the vault door should be provided over the vault door if it opens into a corridor or other space other than the

armorer's room, such as the assembly hall of unit storage. These lights will be connected directly to the panel board. If the vault door opens into the armorer's room, this egress lighting should instead be provided outside the armorer's room door.

**4-2.12.7** Coordinate lighting and caging layout to allow caging walls to extend to ceiling. In laying out arms vaults, use a 5 ft (1525 mm) module for width to allow a 3 ft (915 mm) aisle between 10-1/4 in (260 mm) wide rifle racks. Use a 3 ft (915 mm) module for length to allow for 3 ft (915 mm) rifle racks.

**4-2.12.8** Gun racks and containers are Government-supplied and installed. Wire caging on the modules described above is to be provided in vaults serving more than one military unit if requested. **12** GSA approved Class 5 **12** containers (safes) are approved for use instead of small arms storage racks and arms rooms where small quantities of weapons, central firing components and related ammunition are stored. Specific cabinets authorized for use are listed in AR 190-11.

**4-2.12.9** A dehumidifier outside the caged area should be provided. **12** Consider placing dehumidifier on a shelf near the ceiling to prevent damage caused by weapons racks being moved through the vault. **12** A fire extinguisher should be located adjacent to the motion detection control box, both of which should be outside caged areas.

**4-2.12.10** Anchorments for securing weapons in the racks should be provided in the floor, and must be coordinated with floor construction and reinforcing. Floor anchorments should not protrude from floor, and must be coordinated with slab thickness and reinforcing; consider using airport mooring eyes, as manufactured by Neenah Foundry and others. **13** Standard Army Reserve arms vault configurations (available on the Louisville District website) indicate floor anchor placement. Coordinate anchor placement if User utilizes a different weapons rack. **13**

**4-2.12.11** For restoration programs, modular arms vaults are acceptable if they meet the criteria of **13** AR 190-11/**13**, **12** Federal Specification AA-V-2737 **12**, Modular Vault Systems, and are approved by GSA. One manufacturer of such vaults is CustomVault Corporation, Alexandria, VA; their vaults must be installed in humidity-controlled environments. A new floor may be required, depending on condition of existing floor. The final proposed design must be approved in writing prior to

#### **4-2.12.12 Space Design Information**

##### **General/Code**

Size – varies

Occupancy – business

Occupancy count – not occupied; typically 1 person per 300 sf

##### **Architectural/Interiors**

Minimum STC rating – not applicable

Ceiling height – 8 ft - 2 in (2500 mm) minimum

Floor – sealed concrete

Base – none

Walls – painted concrete  
Ceiling – exposed structure, painted  
Trim – none  
Lockset – by vault door supplier \3\ (Fed Spec FF-L-2937 combination lock)/3/

**Mechanical**

Heating – none  
Cooling – none  
Ventilation –0.5 cfm/sf (2.5 L/S/SQM) thru transfer ducts; duct openings must comply with AR 190-11

**Electrical**

Lighting – 50 fc;  
Receptacles – convenience duplex; dedicated 20A circuits one for dehumidifier and one for IDS panel.  
Voice/data – dedicated telephone connection to IDS supervision  
\2\ Intrusion Detention System (IDS). IDS alarm signal transmitter shall be Advantor Plus for signal transmissions to Fort McCoy for off-post vaults. Exterior local alarm bell required for all vaults./2/

**Furniture**

\1\ There is no furniture provided for this room function/1/

**Equipment**

Dehumidifier (pipe to floor drain) by contractor

**Special features or considerations**

24-hour fluorescent, vandal-proof fixture outside vault door, above door  
Power, conduit and boxes for intrusion detection system (IDS) if by Government  
Minimize penetrations in vault envelope  
Tenants may want a lockable pass-thru in the vault's day gate for weapons distribution

**4-2.13 Armorer's Room**

**4-2.13.1** The armorer's room provides a space for weapons issue, inspection, training, cleaning and repair.

**4-2.13.2** If the arms vault door opens into the armorer's room, a physical security light is required outside the armorer's room door - see 4-2.12.6.

**4-2.13.3 Space Design Information**

**General/Code**

Size – 100 sf (9.3 sq m)  
Occupancy – business  
Occupancy count – 1 person

**Architectural/Interiors**

Minimum STC rating – 40  
Ceiling height – 8 ft - 8 in (2600 mm)  
Floor -VCT  
Base – rubber



Walls – painted gypsum board  
Ceiling – suspended acoustical ceiling tile (ACT)  
Trim – none  
Lockset – office

**Mechanical**

Heating, occupied – 68 degrees F (20 F); maintained – 55 degrees F (13 C)  
Cooling, occupied – 78 degrees F (25 C); maintained – ambient  
Ventilation – comply with ASHRAE 62.1

**Electrical**

Lighting – 50 fc receptacles – convenience and computer duplexes  
Voice/data – two voice/data outlets

**1\ Furniture**

Workbench with laminated hardwood top and power strip (plug-in type)  
Stool with woven “Crypton” upholstery  
Lockable storage cabinet

**Equipment**

There is no equipment provided for this room function/1/

**Special features or considerations**

Continuous 110 v power strip above the workbenches

**4-2.14 Classrooms**

**4-2.14.1** This space is used primarily for instructional training of unit personnel, but may also be used as a conference/meeting room on occasion.

**4-2.14.2** Classroom space authorizations are based on 8 sf (0.75 sq m) per person. If the authorization allows, some larger and some smaller classrooms should be provided, with larger classrooms accommodating up to 50.

**4-2.14.3** The larger classrooms can be subdivided with a quality operable panel partition, with an STC rating of 48-52. Extend the sound attenuation above the ceiling to eliminate flanking points. For subdivided rooms, provide equipment for both sides of the partition. Specifications for operable partition should include O & M manual, and provision of multiple sets of any required operating hardware.

**4-2.14.4** Room-darkening shades or blinds should be provided for classrooms with windows.

**4-2.14.5** Portions of any facility which serve a unit with more than 50 members, such as a school command, will be designed as educational occupancies, and meet applicable code criteria for such occupancy. The library, learning center, COMSEC training, and their support spaces will be part of this educational occupancy area.

**Figure 4-14**  
**Classroom**

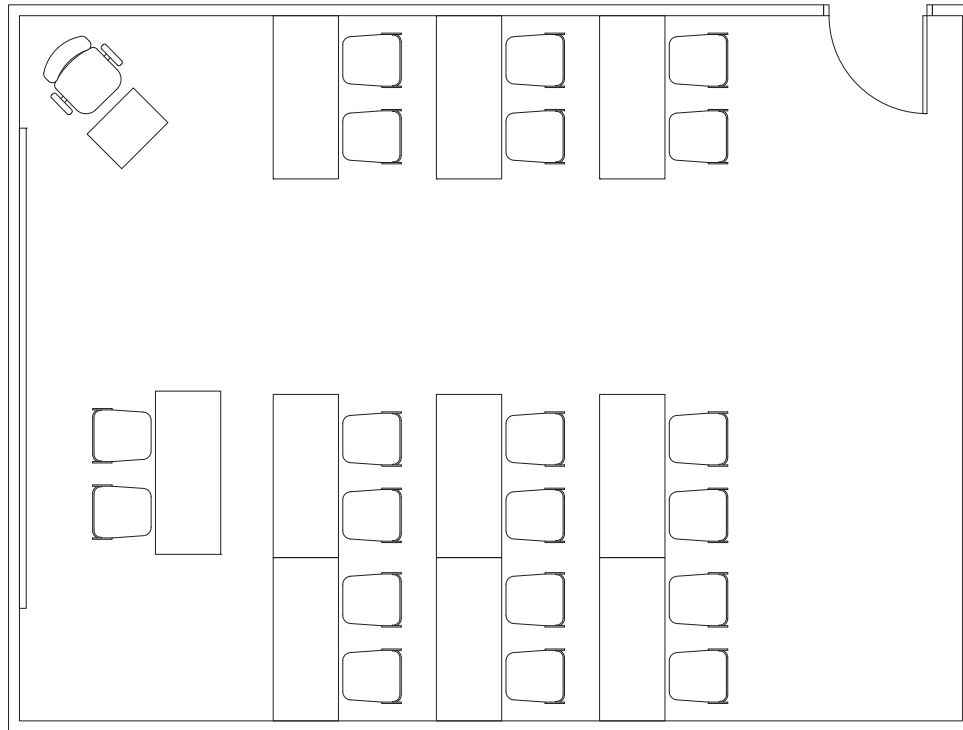

#### 4-2.14.6 Space Design Information

##### **General/Code**

Size – varies

Occupancy – business, educational or assembly depending on personnel count

Occupancy count – 1 person per 20 sf (1.9 sq m)

##### **Architectural/Interiors**

Minimum STC rating – 40

Ceiling height – 8 ft - 8 in (2600 mm) minimum

Floor – carpet **V2**/tile/**2**/; VCT as an alternative

Base – rubber

Walls – painted gypsum board

Ceiling – suspended acoustical ceiling tile (ACT)

Trim – chair rail to protect walls **V2**, coat rack mounted to the wall **/2/**

Lockset – classroom

##### **Mechanical**

Heating, occupied – 68 degrees F (20 C); maintained – 55 degrees F (13 C)

Cooling, occupied – 78 degrees F (25 C); maintained – ambient

Ventilation – comply with ASHRAE 62.1

##### **Electrical**

Lighting – 50 fc; dual-level switching; provide additional controls at marker board

Receptacles – convenience and a duplex receptacle at each data outlet

**V2** - Provide receptacle for ceiling mounted overhead projector **/2/**

Voice/data – two voice/data outlets /2\ at the instructor location

- one data outlet at each student location
- Two conduits from the overhead projector location, one to the instructors location the other to center of the wall at the rear of the classroom (if rear of classroom is a moveable partition locate outlet box in wall at either end of the partition /2/)

/3\ Floor receptacles and outlets may be required if wall outlets are not accessible per table layout (i.e. over 12 feet from a wall outlet)/3/

### /1\ Furniture

**Figure 4-15**  
**Classroom with Operable Partition**

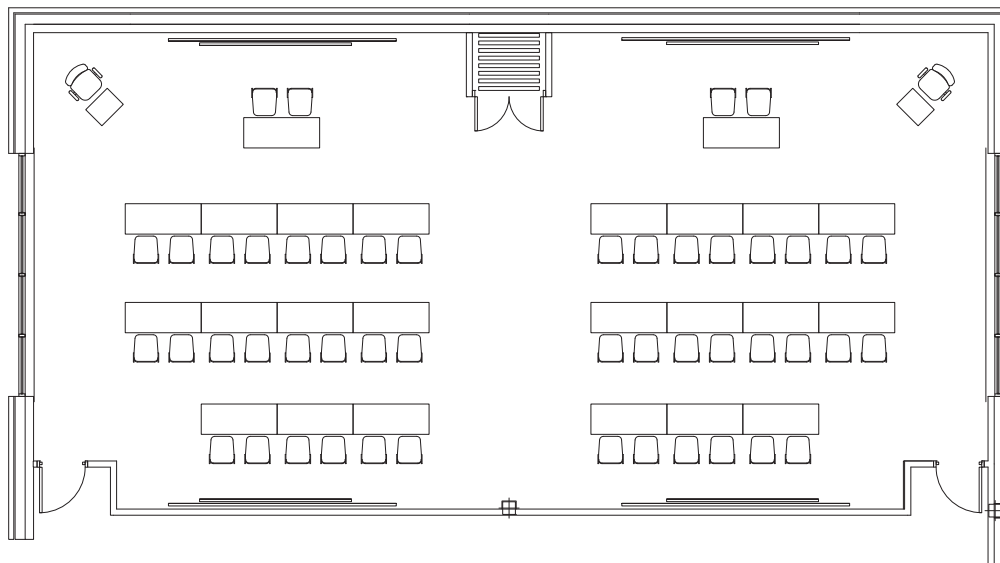

/3\ Non-powered folding tables with t-legs /3/

Sled-based stacking chairs /3\ with arms /3/, with upholstered seat and back  
Full height lectern; pedestal type with shelf underneath (table-top lectern optional) /2V2/

### Equipment

Powered projection screen

Marker board with two inch (2") map rail; multiple marker boards provided where appropriate

Two inch (2") map rail continuous around the perimeter of room.

Map rails to include end stops and hanger clips

### Special features or considerations

Consider incandescent downlights with dimmer to 15 fc for room darkening

Provide room-darkening shades for windows

Verify if Tenants require CATV or permanent mount for LCD projection (TV and projector would be Tenant provided)

Provide sufficient data outlets for computer training, with wire management and appropriate lighting/1/

/2\ Provide blocking in ceiling for an overhead projector /2/

#### 4-2.15 Library Reading Room

**4-2.15.1** The library reading room, or library, provides the Tenants a place to review training publications and other reading material. It is occasionally used as a meeting or conference room.

**4-2.15.2** Library materials are stored in the library storage room storage room.

#### 4-2.15.3 Space Design Information

##### General/Code

Size – varies

Occupancy – business, unless 4-2.14.5  
above governs

Occupancy count – 1 person per 20 sf (1.9  
sq m)

##### Architectural/Interiors

Minimum STC rating – 40

Ceiling height – 8 ft - 8 in (2600 mm)

Floor – carpet **2/ 2/**

Base – rubber

Walls – painted gypsum board

Ceiling – suspended acoustical ceiling tile (ACT)

Trim – chair rail to protect walls **2/**, coat rack mounted to the wall **2/**

Lockset – classroom

##### Mechanical

Heating, occupied – 68 degrees F (20 C); maintained –55 degrees F (13 C)

Cooling, occupied – 78 degrees F (25 C); maintained – ambient

Ventilation – comply with ASHRAE 62.1

##### Electrical

Lighting – 50 fc

Receptacles – convenience duplexes

**2/** - Provide receptacle for ceiling mounted overhead projector

- Provide duplex receptacle in floor under the table **2/**

Voice/data – telephone and data outlets, **2/** located in wall and in floor under  
the table **2/**

**2/** - Provide conduit from the overhead projector location to a wall box on  
wall opposite proposed screen location **2/**

##### 1\ Furniture

**3/ 2/** Meeting room table or **3/ 2/** Folding **2/** tables with t-legs

**3/** Sled based **3/** upholstered chairs with arms

Bookcases

Credenza storage unit **3/** or **3/** lockable storage cabinet with shelves

##### Equipment

Marker board with 2” map rail **1/**

##### Special features or considerations

Verify whether Tenants require computer power, voice/data receptacles, marker

**Figure 4-16**  
**Library Reading Room**

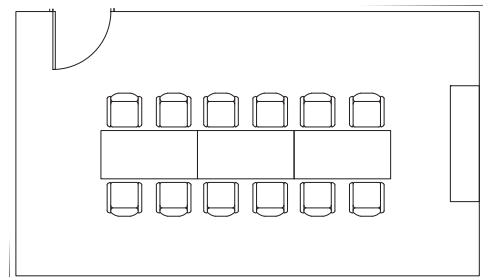

boards, etc., for use as a conference or meeting room  
 \2\ Provide blocking in ceiling for an overhead projector /2/

#### 4-2.16 Library Storage

**4-2.16.1** This space is for the storage of the graphic aids, training modules, bulk training modules and other materials to support the training function. The space should be designed to maximize storage space and shelving.

#### 4-2.16.2 Space Design Information

##### General/Code

Size – 10 % times Library Reading Room authorization

Occupancy – business

Occupancy count – not occupied; typically 1 person per 300 sf

##### Architectural/Interiors

Minimum STC rating – 40

Ceiling height – 8 ft - 8 in (2600 mm)

Floor – VCT

Base – rubber

Walls – painted gypsum board

Ceiling – suspended acoustical ceiling tile (ACT)

Trim – none

Lockset – storeroom

##### Mechanical

Heating, occupied – 68 degrees F (20 C); maintained - 55 degrees F (13 C)

Cooling - none

Ventilation – comply with ASHRAE 62.1

##### Electrical

Lighting – 30 fc

Receptacles – convenience receptacles

Voice/data – wall phone

##### Furniture

Bookcases and/or storage cabinets

##### Equipment

\3V3/

##### Special features or considerations

**Figure 4-17**  
**Library Storage**

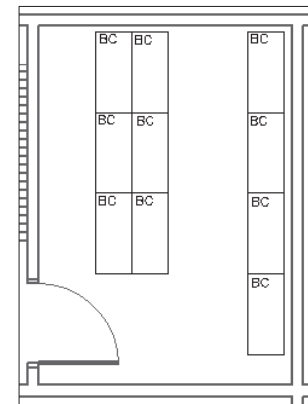

#### 4-2.17 Learning Center

**4-2.17.1** This space is used as a computer training space. It can be used for individual testing or group instruction.

**Figure 4-18**  
**Learning Center**

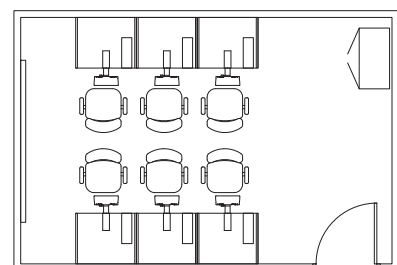

#### 4-2.17.2 Space Design Information

##### **General/Code**

Size – varies

Occupancy – business, unless 4-2.14.5 above governs

Occupancy count – 1 person per 20 sf (1.9 sq m)

##### **Architectural/Interiors**

Minimum STC rating – 40

Ceiling height – 8 ft - 8 in (2600 mm)

Floor – carpet ~~2~~/tile~~2~~/; VCT as an alternative

Base – rubber

Walls – painted gypsum board

Ceiling – suspended acoustical ceiling tile (ACT)

Trim – ~~2~~ none ~~2~~

Lockset – classroom

##### **Mechanical**

Heating, occupied – 68 degrees F (20 C); maintained – 55 degrees F (13 C)

Cooling, occupied – 78 degrees F (25 C); maintained – ambient

Ventilation – comply with ASHRAE 62.1

##### **Electrical**

Lighting – 50 fc

Receptacles – ~~3~~ convenience receptacles and a duplex receptacle at each data outlet~~3~~

~~3~~ ~~3~~

##### **1\ Furniture**

~~3~~ Tables with privacy screen use of CPU holder, keyboard tray shall be verified with the Tenant~~3~~

~~3~~~~3~~

Mid-back upholstered task chairs with adjustable arms

~~3~~~~3~~

Lockable storage cabinet with shelves

##### **Equipment**

Marker board with 2" map rail; map rail to include end stops and hangerclips

~~3~~ ~~3~~

##### **Special features or considerations**

Power outlets and data outlets should be provided along the wall at each table location ~~3~~ ~~3~~

~~3~~ Floor receptacles and outlets may be required if wall outlets are not accessible per table layout ~~3~~~~1~~

~~3~~ ~~3~~

#### 4-2.18 Training Aids Storage

**4-2.18.1** This space is for the storage of teaching aids (including A/V equipment), manuals, publications, and models. The designer should verify the types of materials to be stored, and design the space accordingly.

**Figure 4-19**  
**Training Aids**  
**Storage**

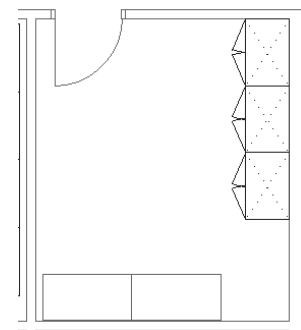



#### 4-2.18.2 Space Design Information

##### **General/Code**

Size – 10% times total classroom area authorization

Occupancy – business

Occupancy count – not occupied; typically 1 person per 300 sf

##### **Architectural/Interiors**

Minimum STC rating – 40

Ceiling height – 8 ft - 8 in (2600 mm)

Floor – VCT

Base – rubber

Walls – painted gypsum board

Ceiling – suspended acoustical ceiling tile (ACT)

Trim – none

Lockset – storeroom

##### **Mechanical**

Heating, occupied and maintained – 55 degrees F (13 C)

Cooling – none

Ventilation – incidental

##### **Electrical**

Lighting – 30 fc

Receptacles – convenience duplex receptacles

Voice/data – wall phone

##### **Furniture**

1\ 2\ 2\ Lockable storage cabinets with shelves

TV/VCR cart, one (1) for every two (2) classrooms; minimum one (1) per project; to be stored in training aid storage rooms 1\

##### **Equipment**

Shelving

##### **Special features or considerations**

Ordinary hazard sprinklers

3\ 3\

#### 4-2.19 COMSEC Storage

**4-2.19.1** This space provides storage area for sensitive communication devices. However, a security safe may be substituted and placed within a COMSEC training room. If a safe is utilized, then the room design must provide sufficient space surrounding the safe for circulation and door operation. The safe must be offset from the wall 12 inches in order to open on two sides and swivel, thus requiring a slight increase in floor space. Safes are provided by the Tenants, and weigh approximately 100 psf.

**4-2.19.2** The door to a COMSEC storage room must be solid-core wood or hollow metal industrial, lockable and without glazing. The strike plate must be heavy-duty, high-security, and hinge screw length must be sufficient to resist removal by prying. Hinge pins must be within the space, or non-removable. An electromechanical lock meeting Federal Specification FF-L-2740 is required.

**4-2.19.3** If a storage safe is not incorporated into the COMSEC training room, then the Storage room space must be secure against surreptitious entry; provide gypsum board walls from floor to ceiling, and a gypsum board ceiling, to provide visual evidence of any attempted entry.

**4-2.19.4** Air vents, ducts and similar openings that breach the room envelope must be secured to prevent penetration; if greater than 96 sq in (2,000 sq mm), provide hardened steel bar grates or IDS supervision. All openings must be baffled to limit audio or acoustical transmission to non-COMSEC spaces.

#### **4-2.19.5** Space Design Information

##### **General/Code**

Size – varies

Occupancy – business

Occupancy count – not occupied, typically 1 person per 300 sf

##### **Architectural/Interiors**

Minimum STC rating – 40

Ceiling height – 8 ft - 8 in (2600 mm)

Floor – VCT

Base – rubber

Walls – painted gypsum board

Ceiling – painted gypsum board

Trim – none

Lockset – storeroom

##### **Mechanical**

Heating, occupied – 68 degrees F (20 C); maintained – 55 degrees F (13 C)

Cooling – none

Ventilation – incidental

##### **Electrical**

Lighting – 30 fc

Receptacles – convenience duplex

Voice/data – wall phone

##### **Furniture**

Bookcases upon Tenant request, Designer of Record shall verify

##### **Equipment**

Any safe(s) will be provided by with the Tenants

\\3\ /3/

##### **Special features or considerations**

Ordinary hazard sprinklers

Though not a requirement, Tenants normally prefer no windows in this space

#### **4-2.20** Unit/Individual Storage

**4-2.20.1** This space permits storage and inventory management of organizational equipment, such as clothing, tents, radios, tool sets, etc., in a separate and secure area. The issue and return of organizational equipment is also conducted here, or in the

staging area.

**4-2.20.2** The unit storage space is typically subdivided into **12** 8 ft by 12ft - 2in (2400 mm by 3650 mm) **12** cages constructed of 1 in by 2 in (25 mm by 50 mm) woven welded wire fabric. See Section 3-5.6 for additional information on cages and shelving. Aisles and vestibules between the secured areas should allow for efficient circulation and movement of stored equipment. Circulation space is not included within the total area authorization. **13** Provide each cage unit with a small sign identify sequentially each cage. Signs should be posted stating storage height limitation and/or no storage above the cage ceilings. **13**

#### **4-2.20.3** Space Design Information

##### **General/Code**

Size – varies

Occupancy – storage

Occupancy count – not occupied; typically 1 person per  
300 sf (27.9 sq m)

##### **Architectural/Interiors**

Minimum STC rating – 40

Ceiling height – 10 ft (3050 mm) minimum

Floor – sealed concrete

Base – none

Walls – painted CMU; painted gypsum board as an  
alternative

Ceiling – none; paint structure

Trim – none

Lockset – classroom; padlocks at cages

##### **Mechanical**

Heating, occupied – 68 degrees F (20 C); maintained – 55 degrees F (13 C)

Cooling – economizer only

Ventilation – one air change per hour

##### **Electrical**

Lighting – 30 fc; motion sensors for aisles

Receptacles – convenience duplex in each cage; convenience duplexes along  
aisles

Voice/data – none

**Furniture** - none

**Equipment** - shelving, caging

##### **Special features or considerations**

**13** Ordinary hazard group 2 sprinklers with storage below 12 feet (3.7 metres) **13**  
Lights should be located at cage ceilings, as well as in aisles, to provide  
sufficient light for cages and allow for ease of bulb replacement

Provide padlocks for all cage door hasps

If some portions of unit storage have gypsum board walls, consider a plywood  
wainscot

**Figure 4-20**  
**Unit Storage with**  
**Supply Office**

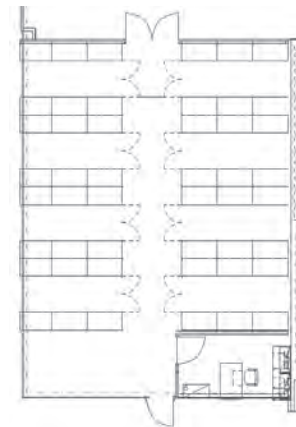

**Figure 4-21**  
**Unit Storage with Staging and Supply Office**



#### **4-2.21 Staging Area**

**4-2.21.1** The staging area provides space for issue and return of the units' organizational equipment, and for marshaling and loading for movement off-site.

#### **4-2.21.2 Space Design Information**

##### **General/Code**

Size – 10% time authorized area for unit storage

Occupancy – storage

Occupancy count – not occupied; typically 1 person per 300 sf

##### **Architectural/Interiors**

Minimum STC rating – 40

Ceiling height – 10 ft (3050 mm) minimum

Floor – sealed concrete

Base – none

Walls – painted CMU; painted gypsum board as an alternative

Ceiling – exposed structure, painted

Trim – none

Lockset – panic at exit door

##### **Mechanical**

Heating, occupied - 68 degrees F (20 C); maintained – 55 degrees F (13 C)

Cooling – none

Ventilation – comply with ASHRAE 62.1

##### **Electrical**

Lighting – 30 fc

Receptacles – convenience duplex

Voice/data – wall phone

**Furniture**

**Equipment**

**Special features or considerations**

Overhead door to the exterior, typically 10 ft by 10 ft (3 m by 3 m)

2\ Provide 6-inch diameter concrete filled with a concrete dome top, heavy-weight steel protective bollards inside and outside of overhead door jams

/2/

If site conditions allow, consider a raised or depressed loading dock at the overhead door

Ordinary hazard sprinklers

**4-2.22 Supply Office**

**4-2.22.1** These offices are used by the supply officers for administration and training purposes. They should be located to have a view of the unit storage and staging areas, possibly through a window, sidelight or door light, since they have air conditioning and the spaces around them do not. An exterior window overlooking the service drive to the staging area, and any vehicle barrier, are also desirable.

**4-2.22.2** There is typically a GFGI safe in at least one supply office; provide a floor anchor, similar to that in the arms vault at the appropriate office(s).

**4-2.22.3 Space Design Information**

**General/Code**

Size – 120 sf (11 sq m) each typical

Occupancy – business

Occupancy count – 1 person per single office; shared offices 2-10

**Architectural/Interiors**

Minimum STC rating – 40

Ceiling height – 8 ft - 8 in (2600 mm)

Floor – VCT

Base – rubber

Walls – painted gypsum board; painted CMU as an alternative

Ceiling – suspended acoustical ceiling tile (ACT)

Trim – none

Lockset – office

**Mechanical**

Heating, occupied – 68 degrees F (20 C); maintained – 55 degrees F (13 C)

Cooling, occupied – 78 degrees F (25 C); maintained – ambient

Ventilation – comply with ASHRAE 62

**Electrical**

Lighting – 50 fc

Receptacles – convenience and computer duplexes

Voice/data – two telephone/data outlets per workstation

**Furniture**

Similar to full-time offices above

**\3\ /3/**

**Equipment**

Verify if additional equipment required in some offices

**Special features or considerations**

**4-2.23 Janitorial**

**4-2.23.1** Janitorial closets provide space, and plumbing, for the cleaning and storage of mops, janitorial supplies and related cleaning equipment. The authorization may be distributed throughout larger or multistory buildings for maintenance convenience.

**4-2.23.2 Space Design Information**

**General/Code**

Size – varies

Occupancy – business

Occupancy count – not occupied; typically 1 person per 300 sf

**Architectural/Interiors**

Minimum STC rating – 40

Ceiling height – **\3\** 8 ft - 8 in (2600 mm) **/3/**

Floor – sealed concrete

Base – none

Walls – **\3\** epoxy-painted water resistant gypsum board; epoxy-painted CMU as an alternative **/3/**

Ceiling – **\3\** epoxy-painted water resistant gypsum board **/3/**

Trim – Mop hooks; At least 10 lineal feet (3 m) of shelving

Lockset – storeroom

**Mechanical**

Heating – passive, through transfer air

Cooling – passive, through transfer air

Ventilation – ventilate with exhaust at 10 air changes per hour; maintain negative pressure

**Electrical**

Lighting – 10 fc

Receptacles – GFCI duplex receptacle

Voice/data – none

**Furniture**

**Equipment**

**Special features or considerations**

Floor sink with spout with pail hook

Ordinary hazard sprinklers

**Figure 4-22  
Janitorial**

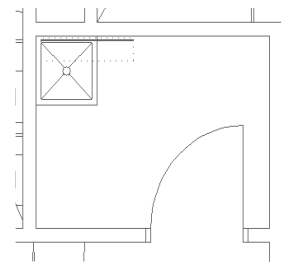



#### 4-2.24 Flammable Storage

These rooms are rarely provided in training centers; see OMS Flammable Storage, Section 4-3.7 below.

#### 4-2.25 Controlled Waste Storage

These rooms are rarely provided in training centers; see OMS Controlled Waste Storage, Section 4-3.8 below.

#### 4-2.26 Facility Maintenance Storage

**4-2.26.1** This space is provided for storage of maintenance equipment and supplies, and general building storage. The authorization may be distributed throughout larger buildings for operational convenience.

**Figure 4-23**  
**Facility Maintenance Storage**

**4-2.26.2** A portion of this space should be dedicated to recycling, for sustainable design and environmental reasons. This portion should be located near an exterior exit with vehicle access, and provide storage to support the break room recycle center.

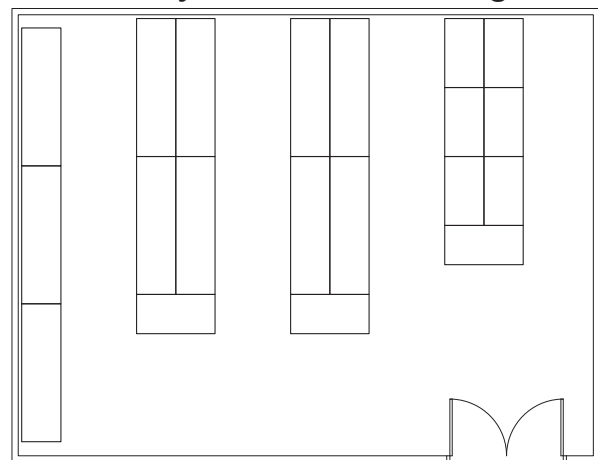

#### 4-2.26.3 Space Design Information

##### **General/Code**

Size – 200 sf (18.6 sq m)  
Occupancy – business  
Occupancy count – not occupied;  
typically 1 person per 300 sf

##### **Architectural/Interiors**

Minimum STC rating – 40  
Ceiling height –  
Floor – sealed concrete  
Base – none  
Walls – painted gypsum board; painted CMU as an alternative  
Ceiling – exposed structure, painted  
Trim – none  
Lockset – storeroom

##### **Mechanical**

Heating – 55 degrees F (13 C)  
Cooling - none  
Ventilation – ventilate with exhaust fan

##### **Electrical**

Lighting – 30 fc  
Receptacles – convenience duplex receptacles

Voice/data – wall phone  
**Furniture**  
**Equipment**  
 Shelving and or storage cabinets  
**Special features or considerations**  
 Ordinary hazard sprinklers

**4-2.27** Weapons Simulator

**4-2.27.1** The weapons simulator space houses either a Laser Marksmanship Training System (LMTS) or an Engagement Skills Trainer (EST) to provide simulator-type weapons training. It is similar in design to a classroom, and may occasionally be used as a classroom and shall be designed for this dual purpose. The 24' x 70' Weapons Simulator space is sub-divided into three rooms: a 24' x 62' Simulator Room, an 18' x 8' Control Room and a 6' x 8' Secure Storage Room. The Control Room and Secure Storage Room are for the simulator weapon controls, computers and other support equipment.

**4-2.27.2** The designer should verify the type of weapons simulator system to be provided with the Using Service and USAR Installation and obtain the specifications for the system. The weapons simulator system is typically Government provided and installed, but the designer will need to develop the proper room layout for the system, as well as appropriate electrical, communications and mechanical systems to support the equipment.

**4-2.27.3** Provide 60 STC for Weapons Simulators Room walls located near occupied spaces, reduce STC rating to 48 when adjacent to unoccupied spaces. Provide 60 STC for walls around Secure Storage Room to reduce sound of the EST compressor now or in the future.

**4-2.27.4** Space Design Information

**General/Code**

Size – 24' x 70'

Occupancy – business

Occupancy count –

- Simulator Room – 5 People when used as Weapons simulator, when used as a classroom 1 person per 20 sf (1.9 sq m)
- Control Room – 2 People.

**Architectural/Interiors**

Minimum STC rating – 48/60 (See Paragraph 4-2.27.3)

**Figure 4-24**  
**Weapons Simulator**

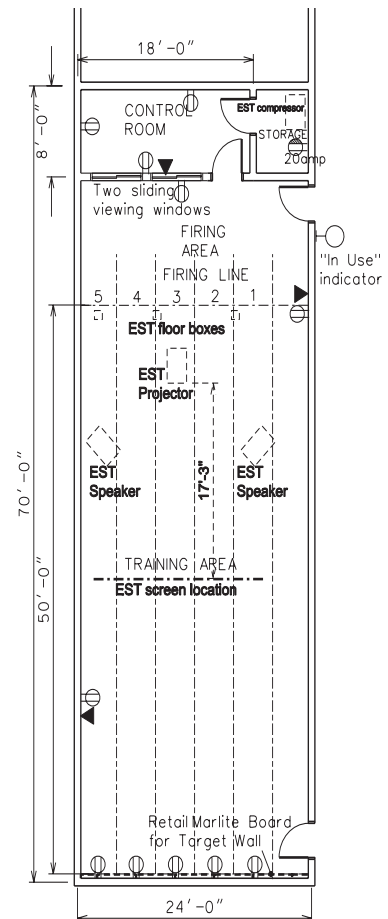

Ceiling height – 8 ft - 8 in (2600 mm) minimum

Floor –VCT

Base – rubber

Walls – painted high-impact gypsum board in Simulator Room

- Wall opposite Control Room in Simulator Room to have full height/full width retail display board (Marlite Board) for suspension of targets and control devices. Wall behind display board shall receive grade one select wood blocking for display board support.
- Control Room and Secure Storage Room shall have painted gypsum board walls.

Ceiling – suspended acoustical ceiling tile (ACT). Ceiling to have 12” by 10” high raise notch along Simulator Room wall between Control Room and target wall for an exposed cable tray to be inserted. Top and side of raised notch shall be ACT.

Trim – none

Locksets – classroom style - except Secure Storage Room is storage.

Two (2) 2-36” High x 48” wide sliding operable windows with locking device and single pane safety glazing in hollow metal frame mounted between Control Room and Simulator Room. Bottom of window frame 34” AFF.

Two (2) 8”x8” operable access doors. One access door between Secure Storage Room and Simulator Room, and another between Control Room and Simulator Room. Access doors are for running cables and air lines between the rooms.

### **Mechanical**

Heating, occupied – 68 degrees F (20 C); maintained –55 degrees F (13 C)

Cooling, occupied – 78 degrees F (25 C); maintained – ambient

Ventilation – comply with ASHRAE 62.1

Air movement shall not cause targets or projection screen to ripple, special emphasis for EST screen location.

### **Electrical**

Lighting – 50 fc; provide dimmers for room darkening

- Provide track lighting over targets with five directional incandescent fixtures, light control provided with dimmer in Control Room.
- Zone fluorescent with multiple switch control and three tube fixtures with one tube on a separate switch. (Dimmer control may be used)
- Lighting Controls for Simulator Room located at entry behind firing line into room as well as in Control Room.
- Provide “Range-In-Use” light outside main entry door, with an associated pilot light switch in the Control Room.

Receptacles – convenience and computer duplexes

- Provide a receptacle at each target location
- Provide a dedicated 20 Amp circuit with standard duplex outlet for future air compressor in the Secure Storage Room
- Provide double duplex receptacles by voice and data outlets in Simulator room.

Voice/data – two voice/data outlets in Control Room located below viewing windows. Locate voice and data outlets along walls in Simulator Room per

proposed furniture layout (minimum of six locations).

- 6" wide by 4" high aluminium , cable tray in ceiling notch. Bottom of the cable tray shall be flush with bottom of adjacent acoustical ceiling tile.

LMTS target switches in the Control Room.

Weapons Simulator PA System – Provide PA system such that Control Room can give one-way instruction to shooters. If a building wide PA system is used continue it throughout the Weapons simulator space but have a PA silence switch in Control Room to silence building wide PA system in Simulator Room only. Building wide PA silence switch will not disable mass notification or fire alarms in Training Room.

No mercury vapor fixtures.

#### **Furniture**

Exercise (floor mats) for comfort at firing area and to cover cables/air lines on floor connecting targets and equipment.

Control Room

Two folding tables

Two desk chairs

**\3\3/**

#### **Equipment**

Simulator Room

60" x 60" Powered projection screen centered on wall mounted below ceiling in front of display board wall.

#### **Special features or considerations**

Noise – maximum 107 decibels

- Locate Weapons Simulator space away from offices.

Provide room-darkening shades for any windows

Verify equipment power or data needs with Tenants

Quiet air distribution **/2/**

**\3\3/**

**4-2.28** Band Room – [See Appendix G](#)

**4-2.29** Medical Section

**4-2.29.1** Units with medical sections assigned to them will be authorized a 400 sf (37.2 sq m) space to be used for training and storage. The designers should coordinate layout and furnishing for the space with the Tenants.

**4-2.29.2** Space Design Information: This area may house functions similar to office, unit common, or physical exam spaces; see space design information for those functions as appropriate.

**4-2.30** Physical Exam Wing – [See Appendix I](#)

**4-2.31** Secure Compartmented Information Facility (SCIF) - [See Appendix H](#)

**4-2.32** Soils Testing Lab

**4-2.32.1** The space is authorized for units with soils testing functions, and should be located near an exterior door to minimize tracking of dirt by field personnel.

**4-2.32.2** Space Design Information

**General/Code**

Size – 150 sf (13.9 sq m)

Occupancy – business

Occupancy count – 1 person per 100 sf (9.3 sq m)

**Architectural/Interiors**

Minimum STC rating – 40

Ceiling height – 8 ft - 8 in (2600 mm)

Floor – VCT

Base – rubber

Walls – painted gypsum board

Ceiling – suspended acoustical ceiling tile (ACT)

Trim – none

Lockset – office

**Mechanical**

Heating, occupied – 68 degrees F (20 C); maintained – 55 degrees F (13 C)

Cooling, occupied – 78 degrees F (25 C); maintained – ambient

Ventilation – comply with ASHRAE 62.1

**Electrical**

Lighting – 50 fc

Receptacles – convenience duplex; GFCI duplex above counters

Voice/data – wall phone above counter

**Furniture**

Verify with Tenants

**Equipment**

Soils testing equipment by the Tenants

**Special features or considerations**

Chemical-resistant counter space 8 ft (2.4 m) in length

Two-compartment, chemical-resistant stainless steel sink

Consider filtered return registers

**4-2.33** Conference Room

**4-2.33.1** This space is used for meetings by the Commanding General and/or staff within the general office or headquarters, and is only authorized if there is a General officer in one of the units. It should be near, or in, the General's suite. A higher level of finishes may be appropriate.

**4-2.33.2** The conference room must be capable of accommodating 20 people, with good sight lines from all seats and sufficient space for ease of circulation during meetings. If space allows, additional seating can be provided along one or more walls of the room.

**Figure 4-25**  
**Conference Room**

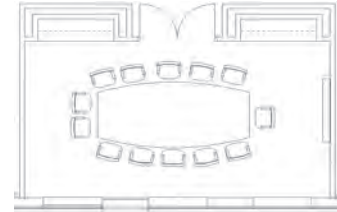

**4-2.33.3** \1\ Space Design Information

**General/Code**

Size – 600 sf (55.7 sq m)

Occupancy – business

Occupancy count – by number of seats, or 1 person  
per 15 sf (1.4 sq m)

**Architectural/Interiors**

Minimum STC rating – 40

Ceiling height – 8 ft - 8 in (2600 mm) minimum

Floor – carpet \2\tile/2/

Base – rubber

Walls – painted gypsum board; vinyl as an alternative

Ceiling – suspended acoustical ceiling tile (ACT)

Trim – chair rail

Lockset – classroom

**Mechanical**

Heating, occupied – 68 degrees F (20 C); maintained – 55 degrees F (13 C)

Cooling, occupied – 78 degrees F (25 C); maintained – ambient

Ventilation – comply with ASHRAE 62.1

**Electrical**

Lighting – 50 fc with dual-level switching; provide dimmers

Receptacles – convenience duplexes

\2\ - Provide receptacle for ceiling mounted overhead projector.

- Provide duplex receptacle in floor under the table /2/

Voice/data – voice/data outlets on each wall and in floor under the table

\2\ - Provide conduit from the overhead projector location to a wall box on  
wall opposite proposed screen location /2/

**Furniture**

Large wood conference table \3V3/

High-back upholstered chairs with adjustable seat height, fixed arms, and swivel  
base at conference table

\3\ Guest /3/ chairs around perimeter of room

Full-height floor lectern \3V3/

\3V3/

**Equipment**

Powered projection screen wired to lectern to allow computer screen to be  
projected

Electronic presentation “smart board” with printing capabilities, enclosed

Two inch (2”) map rail on one (1) wall

Map rail to include end stops and hanger clips

Verify with Tenants if CATV, LCD projection, video teleconferencing, etc., are



desired (TV and projector by Tenants) – ACSIM-ODR approval is required

**Special features or considerations**

Optional built-in casework may be appropriate for storage and counter space

Provide chair rail around entire room

Provide structural support for ceiling mounted projector (projector to be provided by Tenant)/1/

\2\ Provide blocking in ceiling for an overhead projector./2/

**4-2.34 Drafting Room**

**4-2.34.1** This space is used for manual or electronic drafting training and operations, printing, and storage of drawings and media. In most cases it should be set up for one manual and one CAD drafting station. Designer should verify typical drafting practice with Tenants.

**4-2.34.2 Space Design Information**

**General/Code**

Size – 250 sf (23.25 sq m)

Occupancy – business

Occupancy count – 2 people

**Architectural/Interiors**

Minimum STC rating – 40

Ceiling height – 8 foot - 8 in (2600 mm) minimum

Floor – VCT; carpet \2\tile/2/ as an alternative

Base – rubber

Walls – painted gypsum board

Ceiling – suspended acoustical ceiling tile (ACT)

Trim – none

Lockset – office

**Mechanical**

Heating, occupied – 68 degrees F (20 C); maintained – 55 degrees F (13 C)

Cooling, occupied – 78 degrees F (25 C); maintained – ambient

Ventilation – comply with ASHRAE 62.1; adequate ventilation for any printer

**Electrical**

Lighting – 50 and 100 fc; dual-level switching

Receptacles – convenience and computer duplexes

Voice/data – voice/data outlets each workstation

**\1\ Furniture**

One small computer station similar to full-time offices above (freestanding metal desk-based furniture)

Upholstered mid-back task chair with adjustable seat height and arms

Drafting table (single pedestal desk optional), 36 in x 72 in

(0.9144 m x 1.8288 m)

Drawing storage flat files - \3\ optional verify with Tenant

Lockable storage cabinet with shelves to be used as printer stand

/3/

### Equipment

CAD terminals

Printer provided by Tenants

Line one (1) wall with tack boards and a small marker board, tack board sized to accommodate standard “E-size” drawing paper, minimum of 36 in high x 48 in wide (0.9144 m high x 1.2192 m wide)

### Special features or considerations

Verify Tenant equipment power/data needs

Floor space should be provided for Tenant’s freestanding plotter and large freestanding printer /1/

## 4-2.35 Physical Readiness Training

**4-2.35.1** This space is for the Tenants’ physical training (PT); the athletic/training equipment is included in the design, and is provided and installed by the Government as part of the project furniture package.

**Figure 4-26**  
**Physical Readiness Training Room**

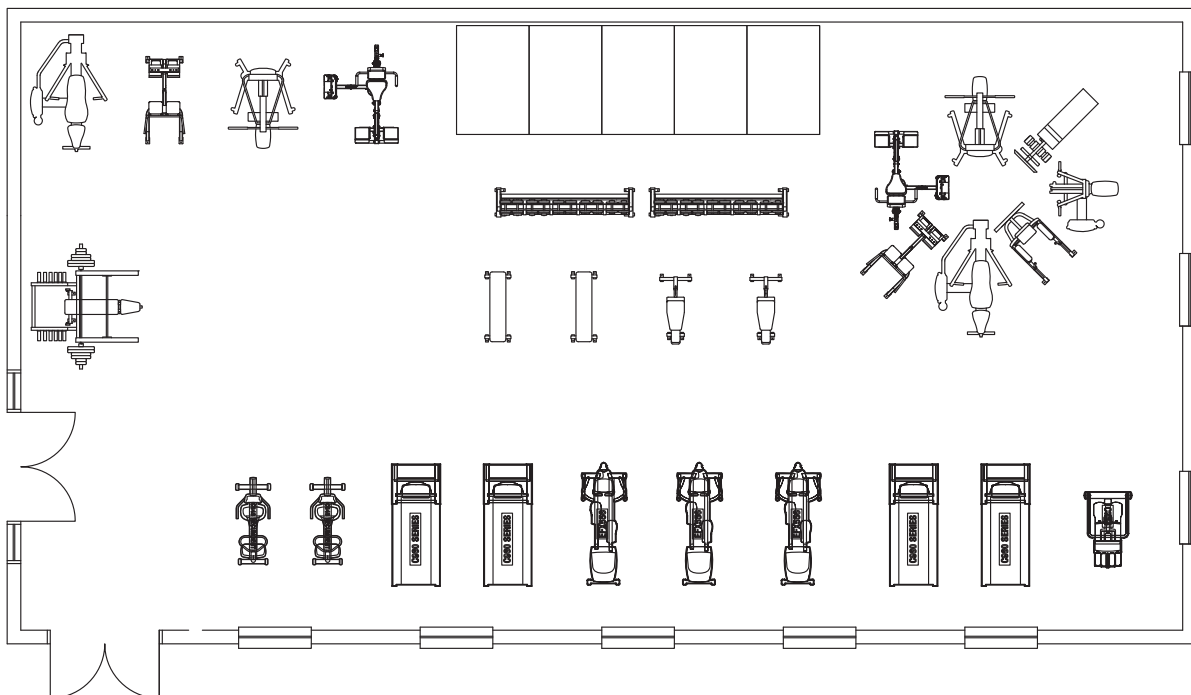

**4-2.35.2** Exterior access should be direct or through a short corridor to allow soldiers to incorporate running into their training. Access should avoid the main entries and more formal spaces in the building. /3/ Room access should provide a pair of 3 foot wide doors to support equipment movement./3/

**4-2.35.3** A drinking fountain should be located in or near this space.

**4-2.35.4** Space Design Information

**General/Code**

Size – varies

Occupancy – business

Occupancy count – 1 person per 100 sf (9.3 sq m)

**Architectural/Interiors**

Minimum STC rating – 40

Ceiling height – 8 foot - 8 in (2600 mm) minimum

Floor – cushioned athletic-type flooring

Base – rubber

Walls – painted gypsum board; painted CMU as an alternative

Ceiling – suspended acoustical ceiling tile (ACT)

Trim – none

Lockset – classroom

**Mechanical**

Heating, occupied – 68 degrees F (20 C); maintained – 55 degrees F (13 C)

Cooling, occupied – 78 degrees F (25 C); maintained – ambient

Ventilation – 20 cu ft per minute (10 L/S) per person minimum; sufficient ventilation for rigorous activity – do not recirculate to other spaces

**Electrical**

Lighting – 30 fc

Receptacles – convenience duplex; outlets for powered equipment

Voice/data – wall phone

1\ Electrical outlet and cable connection for TV hookup/1/, 3\ these outlets should be at the TV mounting height/3/

**Furniture**

3\ A matrix of equipment has been developed based on room size. See matrix in [Appendix L - U.S. Army Reserve Physical Readiness Room Equipment Matrix.](#) /3/

Minimum of one (1) treadmill and one (1) recumbent bike per each physical readiness room

1\ **Equipment**

2\ Mirrors on at least one wall with low exercise bar /2/

One (1) generic TV wall mount bracket

**Special features or considerations**

Verify if Tenants want CATV or data jacks

Provide support for mounting TV bracket /1/

**4-2.36 Army Global Command Control System (AGCCS )**

**4-2.36.1** 3\ This space is used for training and operations with secure information. Its location in a facility is a command decision; it is optimally located adjacent to the SIIPRNET Café, but some may want it with the G3 staff section. It will always be a separate space.

**4-2.36.2** Design and construct the room in accordance with secure room construction requirements of AR 380-5, including provisions for IDS system. The IDS system serving an Arms Vault in the facility may be extended to AGCCS. Some secure room

construction requirements are listed for COMSEC space above, but must be verified with AR 380-5 to assure they are current and complete.

#### 4-2.36.3 Space Design Information /3/ Figure Change/3/

**Figure 4-27**  
**AGCCS**

##### **General Code**

Size - 150 sf (13.9 sq m)

Occupancy - business

Occupancy count – 1 person

##### **Architectural/Interiors**

Minimum STC rating – 45

Ceiling height – 8 ft - 8 in (2600 mm)

Floor – carpet tile; VCT as an alternative

Base – rubber

Walls – painted gypsum board; painted  
CMU as an alternative

Ceiling – painted gypsum board

Trim – none

Lockset – GSA-approved combination lock meeting Federal Specification FF-L-2740A

##### **Mechanical**

Heating, occupied – 68° F (20° C); maintained – 55° F (13° C)

Cooling, occupied – 78° F (25° C); maintained – ambient

Ventilation – comply with ASHRAE 62.1

##### **Electrical**

Lighting – 50 fc (540 lux)

Receptacles – convenience and computer duplex

Voice/data – voice/data receptacle at each workstation

##### **Furniture**

One double pedestal desk with keyboard tray and mouse pad

Mid-back task chair

Conference table and four chairs

Verify tables or stands for USARC provided equipment

##### **Equipment**

Verify secure equipment, GSA containers and other operational items to be provided by USARC, not project

##### **Special features or considerations**

/3/

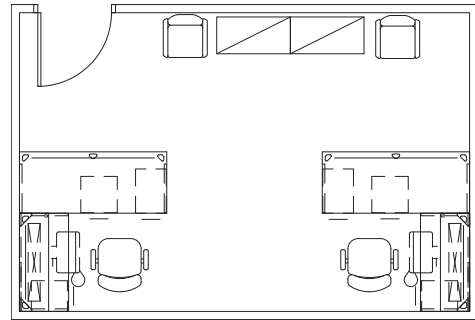

#### 4-2.37 Distance Learning Center

**4-2.37.1** This space is provided, when authorized, to allow delivery of remote training and education resources. An authorization of 800 sf (74 sq m) is provided for each multiple of 12 students, and there may be an associated office for a contract operator/instructor.

**4-2.37.2** The space will be similar to a computer learning lab, with voice/data links. The

Using Service will provide and install all equipment, hardware and software; the designer must obtain the specifications, and coordinate the design of the mechanical and electrical building systems required to support the space and equipment.

**4-2.37.3** Space Design Information - similar to Classroom above; designer must verify whether projection screens, marker boards, map rails and similar accessories are required.

#### **4-2.38** Male and Female Toilets and Showers

**4-2.38.1** Toilet rooms should be provided on each floor, and may be distributed throughout larger buildings for personnel convenience. The total fixture count should be based on the tables in [Appendix F](#) for the maximum drill weekend. If local codes require more fixtures, review with the Using Service. Modesty screening should be provided at toilet room entries.

**4-2.38.2** Shower rooms are provided primarily for weekend drill and physical training purposes, but will also serve some sustainable design goals. Shower rooms should be associated with a toilet room, but only one shower room for each sex should be provided. All showers will be individual units; no gang showers. Standard shower stall is 36 in x 36 in (900 mm by 900 mm); accessible stalls may be 40 in x 40 in (1000 mm by 1000 mm) or 36 in x 60 in (900 mm by 1500 mm). **3** The preferred material for drop-in shower units is fiberglass or plastic.**3**

**Figure 4-28**  
**Shower Room**

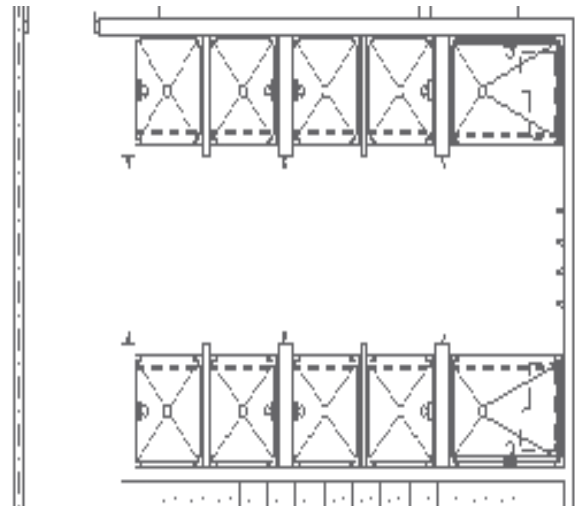

#### **4-2.38.3** Space Design Information

##### **General/Code**

Size – varies

Occupancy – business

Occupancy count – 1 person per 100 sf (9.3 sq m)

##### **Architectural/Interiors**

Minimum STC rating – 40

Ceiling height – 8 ft - 8 in (2600 mm) minimum

Floor – ceramic tile; open rubber tile at showers

Base – ceramic tile

Walls – ceramic tile; epoxy-painted water-resistant gypsum board as an alternative; molded fiberglass as an alternative in shower room

Ceiling – epoxy-painted cement board

Trim – none

Lockset – passage or push/pull

**Mechanical**

Heating - passive, from transfer air

Cooling - passive, from transfer air

Ventilation – Use the largest of 2 CFM/SF (10 L/S/SQM), 10 air changes/HR, or ASHRAE 62.1; negative air pressure.

**Electrical**

Lighting – 30 fc; showers, 20 fc recessed, wet location, lensed fluorescent downlights

Receptacles – convenience duplex – GFCI in wet areas; GFCI duplex at sinks

Voice/data – none

**Furniture**

**Equipment**

Towel hooks or racks at showers

**Special features or considerations**

Commercial grade, flush valve, **13** water closets and waterless urinals **//**

Corrosion-resistant registers

Consider benches at drying areas

**13** Countertop sinks are preferred for large toilet areas. Use solid surface material for the countertops and backsplash. Use stainless steel or vitreous china for the bowls. **13**

**4-2.39** Accessible Unisex Toilet

**4-2.39.1** With the requirement that all newly constructed toilet rooms be accessible, this space authorization is sometimes lumped with the male and female toilets. It may also be used to provide a toilet in a remote part of a building. **12** Some designers have made provisions for baby changing stations in these rooms near the Family Support Office. **12**

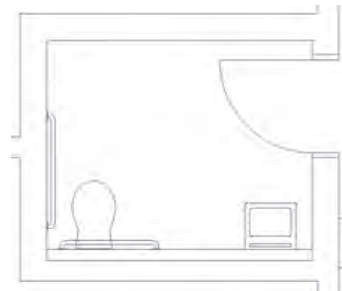

**Figure 4-29**  
**Unisex Toilet**

**4-2.39.2** Space Design Information: See male and female toilet rooms above.

**4-2.40** Male and Female Locker Rooms

**4-2.40.1** Locker room space is provided for personnel storage, and for changing of clothing for physical training or during drill weekends. **12** Provide modesty screening at room entrances as required. **12**

**4-2.40.2** The locker room space authorization may not provide sufficient area for an individual locker for all personnel; in such cases some lockers may be assigned, or all may be available for anyone's use. Full-height, half-height, or a mixture of both may be provided. As a rule of thumb, provide full-height lockers for full-time personnel and all Commanders, and half-height for the remainder as space allows.



4-2.40.2 Space Design Information

**Figure 4-30**  
**Locker Room**

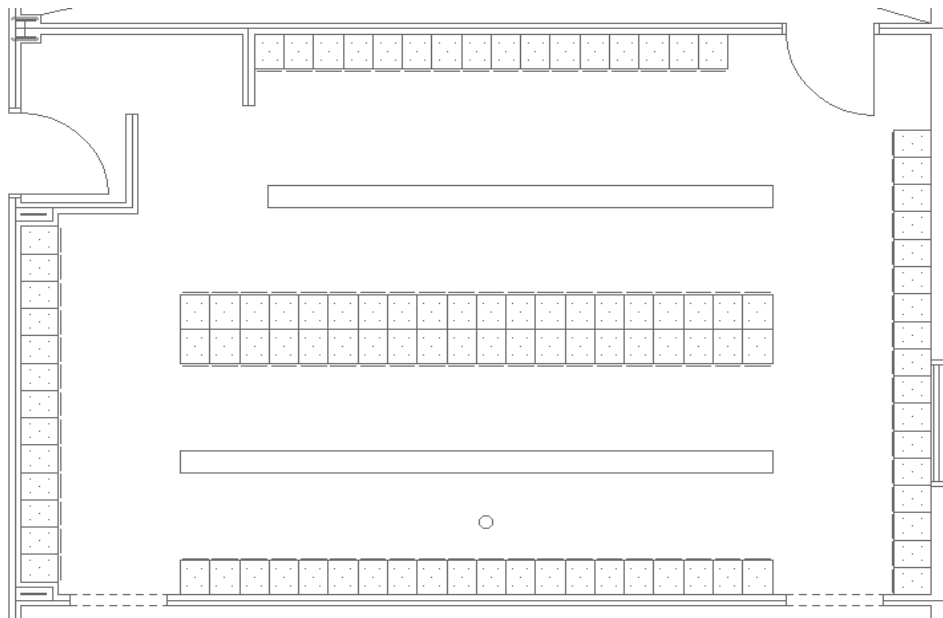

**General/Code**

Size – varies

Occupancy – business

Occupancy count – 1 person per 10 sf (9.3 sq m)

**Architectural/Interiors**

Minimum STC rating – 40

Ceiling height – 8 ft - 8 in (2600 mm) minimum

Floor – ceramic tile

Base – ceramic tile

Walls – painted gypsum board

Ceiling – painted gypsum board

Trim – none

Lockset – classroom

**Mechanical**

Heating, occupied – 68 degrees F (20 C); maintained – 55 degrees F (13 C)

Cooling, occupied – 78 degrees F (25 C); maintained – ambient

Ventilation – Use 1 cfm/sf (5 L/S/SQM) in locker area and 2 cfm/sf  
(10 L/S/SQM) in shower areas; air pressure to be negative

**Electrical**

Lighting – 20 fc

Receptacles – convenience duplex - GFCI

Voice/data – wall phone

**Furniture**

**Equipment**

Benches

## Special features or considerations

### 4-2.41 Vending Alcove

**4-2.41.1** This space is provided for vending machines for the convenience of the Tenants, and is typically located off a corridor or in the break area – occasionally in the assembly hall. Large facilities may justify multiple locations, but the space will have to come out of hide.

### 4-2.41.2 Space Design Information

#### General/Code

Size – 28 sf (4.5 sq m)

Occupancy – business

Occupancy count – not occupied; typically 1 person per  
300 sf (8 sq m)

#### Architectural/Interiors

Minimum STC rating – 40

Ceiling height – 8 ft - 8 in (2600 mm) minimum

Floor – VCT **V2/V2**

Base – rubber

Walls – painted gypsum board

Ceiling – suspended acoustical ceiling tile (ACT)

Trim – none

Lockset – none

#### Mechanical

Heating, occupied – 68 degrees F (20 C); maintained – 55 degrees F (13 C)

Cooling, occupied – 78 degrees F (25 C); maintained – ambient

Ventilation – comply with ASHRAE 62.1; return air to remove heat from vending machines

#### Electrical

Lighting – 20 fc

Receptacles – dedicated 20A for each vending machine

Voice/data – none

#### Furniture

#### Equipment

Vending machines are by the Tenants

#### Special features or considerations

**Figure 4-31**  
**Vending Alcove**

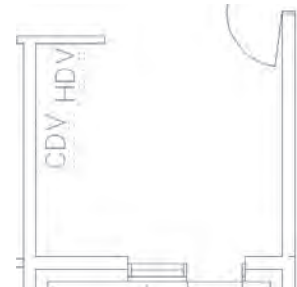

### 4-2.42 Break Area

**4-2.42.1** This space is provided for break and meal activities; it may occasionally be used as a meeting or training space. The Using Service may authorize up to 37 sq m (400 sf) of additional space for family support/retention purposes.

#### 4-2.42.2 Space Design Information

##### General/Code

Size – varies

Occupancy – business

Occupancy count – 1 person per 20 sf (1.9 sq m)

##### Architectural/Interiors

Minimum STC rating – 40

Ceiling height – 8 ft - 8 in (2600 mm) minimum

Floor – \2\ VCT /2/

Base – rubber

Walls – painted gypsum board

Ceiling – suspended acoustical ceiling tile (ACT)

Trim – \2\ none /2/

Lockset – passage

##### Mechanical

Heating, occupied – 68 degrees F (20 C); maintained – 55 degrees F (13 C)

Cooling, occupied – 78 degrees F (25 C); maintained – ambient

Ventilation – comply with ASHRAE 62.1; exhaust with local control for microwave

##### Electrical

Lighting – 50 fc

Receptacles – convenience duplex; dedicated 20A for appliances; GFCI duplex at sink

Voice/data – wall-mounted phone

##### Furniture

Folding tables and plastic shell stack chairs

##### Equipment

\3\ Bulletin board

Marker board /3/

##### Special features or considerations

Refrigerator and microwave are part of construction contract

Counter with upper and lower cabinets and two-compartment sink

\3\ Recycle center to support at least three items/3/

Verify with Tenants if they will provide large coffee maker

**Figure 4-32**  
**Break Area**

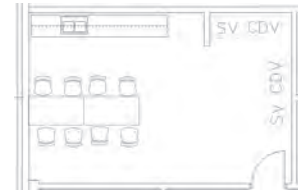

#### 4-2.43 Mechanical

4-2.43.1 Mechanical space for HVAC equipment and ductwork will be distributed through the building for efficient operation of the mechanical systems.

4-2.43.2 The main mechanical space should have double doors to the exterior for convenient access for maintenance and repair.

#### 4-2.43.3 Space Design Information

##### General/Code

Size – \2\ 9% /2/ times authorized bldg. functional area or as required

Occupancy – business  
Occupancy count – not occupied; typically 1 person per 300 sf (27.9 sq m)

**Architectural/Interiors**

Minimum STC rating – 40  
Ceiling height – varies  
Floor – concrete, sealed  
Base – none  
Walls – sealed and painted CMU; painted gypsum board as an alternative  
Ceiling – none, paint structure  
Trim – none  
Lockset – storeroom; entrance at exterior door

**Mechanical**

Heating – 55 degrees F (13 C)  
Cooling – sufficient to remove excess equipment heat  
Ventilation – sufficient to satisfy combustion air and cooling requirements; one  
air change per hour minimum

**Electrical**

Lighting – 30 fc  
Receptacles – convenience duplexes  
Voice/data – wall phone

**Furniture**

1\ Lateral file for O&M manuals /2/

**Equipment**

**Special features or considerations**

Connections to flow switches, tamper switches, and fire alarm  
Ordinary hazard sprinklers  
Floor drains for relief valves and condensate, hose bibb, eyewash if water  
treatment chemicals in room  
Power and data connections for computer if energy management control  
system

**4-2.44 Electrical**

**4-2.44.1** The authorization for electrical space is intended to provide the main electrical distribution room, but electrical closets or panels may be located throughout the building for efficient operation of the facility. Space for the closets will have to come out of hide.

**4-2.44.2** It is preferred that the main electrical room be dedicated, and not share space with mechanical equipment.

**4-2.44.3 Space Design Information**

**General/Code**

Size – 360 sf (33.5 sq m))  
Occupancy – business  
Occupancy count – not occupied; typically 1 person per 300 sf (27.9 sq m)

**Architectural/Interiors**

Minimum STC rating – 40

Ceiling height –

Floor – concrete, sealed

Base – none

Walls – sealed and painted CMU; painted gypsum board as an alternative

Ceiling – none, paint structure

Trim – none

Lockset – storeroom

**Mechanical**

Heating – 55 degrees F (13 C)

Cooling – ventilate sufficient to remove excess equipment heat

Ventilation – sufficient to maintain suitable temperatures for equipment

**Electrical**

Lighting – 30 fc

Receptacles – convenience duplexes

Voice/data – wall phone

**Furniture**

**Equipment**

Electrical service equipment

**Special features or considerations**

Main ground bar

Ordinary hazard sprinkler

Avoid routing water piping above electrical equipment

**4-2.45** Circulation

**4-2.45.1** Typical widths for main corridors are 6 ft and 8 ft (1800 mm and 2400 mm) to allow two people abreast to circulate comfortably without body contact. Secondary corridors may be reduced in width.

**4-2.45.2** Corridors should be planned to be a maximum of 150 feet straight in one direction. Consider changing corridor direction and providing views to adjacent spaces or an exterior scene. Permanent wall-mounted fixtures such as drinking fountains or fire extinguishers must not project into the corridor.

**4-2.45.3** \3\ Stairs shall be constructed with steel frame work with steel pans for concrete treads and landings. All aspects of the stair design shall meet all code requirements. Stair treads shall receive rubber treads with nosings and landings shall receive rubber flooring materials./3/

**4-2.45.4** Space Design Information

**General/Code**

Size – varies

Occupancy – business

Occupancy count – 1 person per 100 sf (9.3 sq m)

### **Architectural/Interiors**

Minimum STC rating – 40

Ceiling height – 8 ft - 8 in (2600 mm) minimum

Floor – VCT; carpet ~~2~~tile/2/ as an alternative in more formal and administrative areas ~~3~~ with low foot traffic /3/

Base – rubber

Walls – painted gypsum board ~~2~~2/; painted CMU as an alternative in more utilitarian spaces

Ceiling – suspended acoustical ceiling tile (ACT)

Trim – wall and corner guards

Lockset – varies; may include hold-opens

### **Mechanical**

Heating, occupied – 68 degrees F (20 C); maintained – 55 degrees F (13 C)

Cooling, occupied – 78 degrees F (25 C); cooling, maintained – ambient

Ventilation – comply with ASHRAE 62.1

### **Electrical**

Lighting – 20 fc

Receptacles – convenience duplex

Voice/data – pay phones if requested by Tenants

### **Furniture**

If space allows, seating areas with lounge chairs

Trophy cases, display cases, bulletin boards

### **Equipment**

#### **Special features or considerations**

Electric water coolers for each floor, minimum

Consider concealed sprinkler heads for esthetics

USAR does not want vinyl wall covering in circulation spaces due to difficulty of repair

~~3~~

#### **4-2.46 Stairs**

**4-2.46.1** Stairs shall be constructed with steel frame work with steel pans for concrete treads and landings. Design stairs with proper rise and run with required landings. Provide exterior exit and area of refuge to support code application. Primary stairs shall receive rubber floor on steps and landings with secondary stairs being sealed concrete.

#### **4-2.46.2 Space Design Information**

##### **General/Code**

Size – varies

Occupancy – business

Occupancy count – 1 person per 100 sf (9.3 sq m)

##### **Architectural/Interiors**

Minimum STC rating – 40

Ceiling height – 8 ft - 8 in (2600 mm) minimum

Floor – rubber

Base – rubber



Walls – painted gypsum board; painted CMU as an alternative in more utilitarian spaces

Ceiling – suspended acoustical ceiling tile (ACT)

Trim – wall and corner guards

Lockset – varies; may include hold-opens

#### **Mechanical**

Heating, 55 degrees F (13 C)

Cooling, occupied – 80 degrees F (27 C); cooling, maintained – ambient

Ventilation – comply with ASHRAE 62.1

#### **Electrical**

Lighting – 20 fc

Receptacles – convenience duplex

#### **Furniture**

#### **Equipment**

#### **Special features or considerations**

Consider concealed sprinkler heads for esthetics

USAR does not want vinyl wall covering in circulation spaces due to difficulty of repair

Ceremonial stairs will be conditioned similar to the spaces served

### **4-2.47 SIPRNET Cafe**

**4-2.47.1** This room provides space for secure/SIPRNET communications as mission or training cycle demands, in lieu of bringing SIPRNET to individual desktops. The Café is intended to operate during normal business hours, not 24/7, with closed storage. In Reserve Centers without SIPRNET missions, this space may be used for other purposes during those times when SIPRNET equipment is not installed.

**4-2.47.2** The preferred location for the Café is at a ground floor point central to the Army Reserve units and personnel in the facility. It is also desirable that the Café is adjacent to the TER to minimize backbone requirements, and adjacent to any other secure communications spaces for efficiency of security and oversight. In a facility with a General Officer, functional and operational efficiency may dictate a location adjacent to the command suite.

**4-2.47.3** Design and construct the room in accordance with “secure room” construction requirements of AR 380-5. Some provisions are listed below, but must be verified with AR 380-5 to assure they are current and complete. When constructed in accordance with AR 380-5, the room will meet definitions of both secure room and controlled access area (CAA). Provide both a combination lock and a supplemental card-key system. The card-key locking system must be dedicated for the Café only, separate from other card-key locking systems for the facility, and must comply with AR 380-5.

**4-2.47.4** Provide for an intrusion detection system (IDS) to monitor the Café. The IDS system serving an Arms Vault in the facility may be extended to the Café, and shall incorporate the card-key system. For IDS provisions required, see Individual Space Criteria for Arms Vault and AR 380-5.

**4-2.47.5** The Cafés are designated as small or large; provide size as indicated below. For CAA-certified facilities with population over 1000, provide space for one large Café plus additional small space increments as appropriate for population. All Army Reserve facilities are non-CAA facilities unless otherwise designated by USARC G3.

- Small CAA facilities with full-time staff  $\leq$  400
- Non-CAA facilities 1 Battalion or more than 5 Companies
- Large CAA Facilities with full-time staff  $\leq$  1000
- Non CAA facilities Brigade and higherr

**Figure 4-33**  
**Typical Small SIPRNET Cafe**

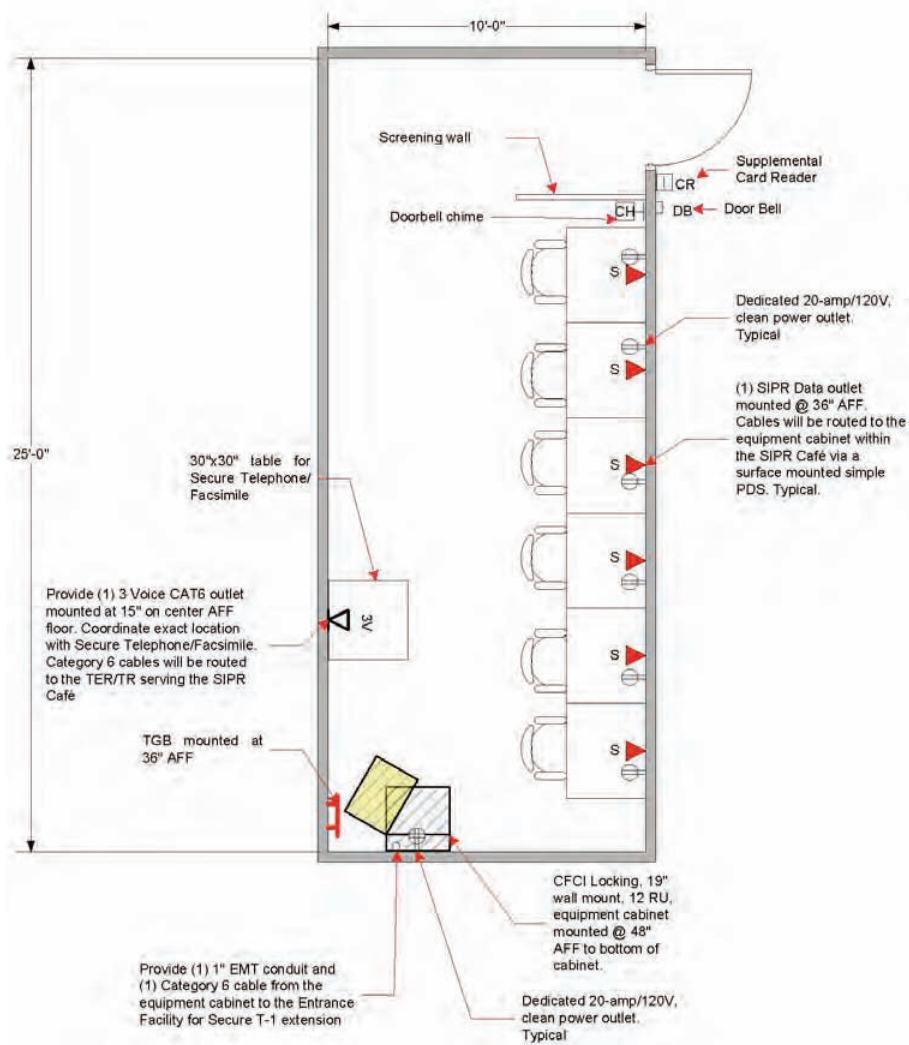

**Figure 4-34**  
**Typical Large SIPRNET Cafe**

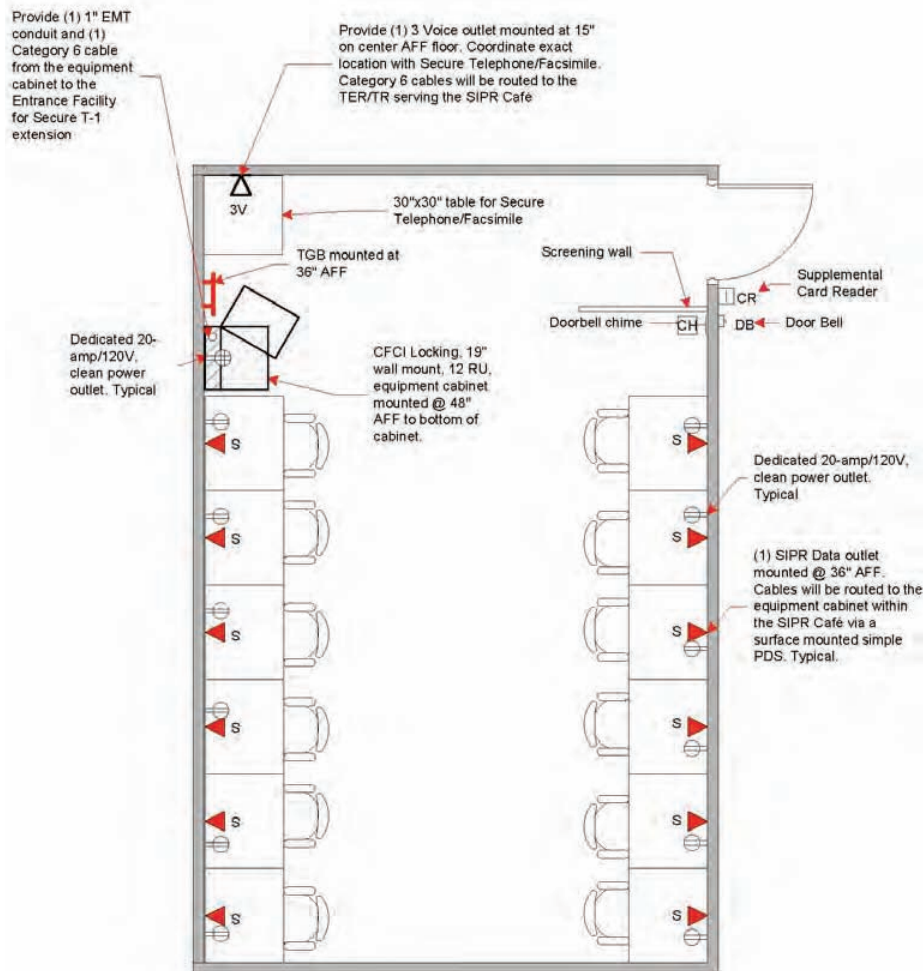

#### 4-2.47.6 Space Design Information

##### **General/Code**

Size – small = 250 SF (14 sq m), and large = 400 SF (51.1 sq m)

Occupancy – business

Occupancy count – varies depending on size of room

##### **Architectural/Interiors**

Minimum STC rating – 49

Ceiling height – 10' (3050 mm) minimum height to structure

Floor – carpet tile

Base – rubber

Walls – painted gypsum board or painted CMU from true floor to structure  
above constructed in accordance with AR 380-5

Ceiling – painted gypsum board

Trim – none

Lockset – GSA-approved combination lock meeting Federal Specification FF-L-2740A and FF-L-2890A (LKM7000), plus supplemental card-key reader

**Mechanical**

Heating – Occupied maintain 68° F (20° C): unoccupied maintain 55° F (13° C)

Cooling – maintain 78° F (13° C)

Ventilation – comply with ASHRAE 62.1

**Electrical**

Lighting – 50 fc (540 lux)

Receptacles – See Chapter 3

Voice/data – SIPRNET distribution and drop to each workstation, plus two unclassified data drops and one telephone drop in room for Secure Telephone Equipment (STE)

**Furniture**

Six computer desks for small room, 10 for medium room and 20 in large room – computer desks are 36 inches (915 mm) wide by 30 inches (765 mm) deep, with shelf, keyboard tray with mouse pad, and mobile CPU cart

Verify tables or stands for USARC provided equipment

**Equipment**

Verify fax machines, safes, servers, secure files, encryption devices, secure telephones and similar items specific to the operation of the Café to be provided by USARC, not the project.

**Special features or considerations**

Walls and ceiling must be constructed to offer resistance to and show evidence of attempted unauthorized entry. Wall studs and gyp board must extend from floor to structure above.

Door must be solid-core wood or metal. Hinge pins of out-swinging doors must be pinned, brazed or spot-welded to prevent removal. Do not provide windows in this space.

Mechanical, electrical and other openings into this space must be smaller than 96 square inches, or must be hardened in accordance with MIL HDBK 1013/1A. Do not route utilities or other infrastructure not associated with this space through this space.

Provide doorbell or buzzer in Café, with activating button outside space entry door

Extend SIPRNET data line in PDS from Café to one conference or classroom, and to COMSEC space if one is authorized for facility

Verify weight of equipment to determine appropriate design floor loads

Provide power, conduit and boxes for a Government-provided IDS system.

Users and security personnel normally prefer no windows in this space. If windows are provided, comply with requirements of AR 380-5.

**4-2.48** EOC - Emergency Operations Center

*Refer to Army Reserve IT Manual for EOC spaces. The Army Reserve IT Manual is available at [www.lrl.usace.army.mil/ed2/default.asp?mycategory=212./3/](http://www.lrl.usace.army.mil/ed2/default.asp?mycategory=212./3/)*

## 4-3 ORGANIZATIONAL MAINTENANCE SHOP

### 4-3.1 Shop Office

**4-3.1.1** The shop office provides space for the performance of administrative functions relating to dispatch records, maintenance records and scheduling.

**Figure 4-35**  
**Shop Office**

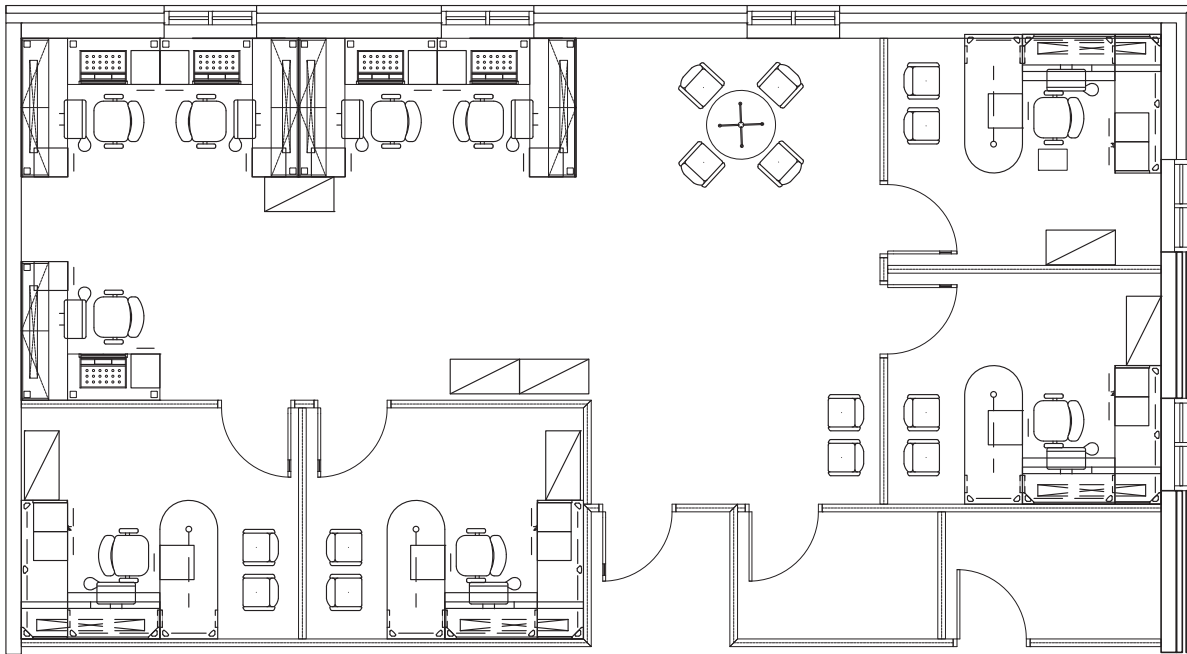

**4-3.1.2** The location of the shop office should provide maximum visibility of workbays, and Tenants generally desire that the offices overlook the workbays, either through a window or a door. The designers must be aware of the requirements of NFPA 70 Article 511 requiring that communicating areas adjacent to workbays be classified as Class 1 locations. A non-operable window is preferable for visibility. Any door should not open directly into the workbays, unless the requirements of NFPA 70 Article 511 are met.

**4-3.1.3** NFPA 101 requires that no other spaces exit through the workbays; if the office area requires two exits, an exit corridor must be provided as well as a direct exit.

**4-3.1.4** Access must be provided from the shop office to the workbay area as well as to the exterior of the building.

**4-3.1.5** Shop offices with Unit Common areas shall match paragraph 4-2.3 with the exception that the floor material shall be VCT in lieu of carpet tile.

**4-3.1.6** Space Design Information

**General/Code**

Size – varies

Occupancy – business

Occupancy count – 1 person per 100 sf (9.3 sq m)

**Architectural/Interiors**

Minimum STC rating – 40

Ceiling height – 8 ft - 8 in (2600 mm) minimum

Floor – VCT **/2/**

Base – rubber

Walls – painted gypsum board; painted CMU as an alternative

Ceiling – suspended acoustical ceiling tile (ACT)

Trim – **/2\** coat rack mounted on wall behind the door **/2/**

Lockset – office or classroom

**Mechanical**

Heating, occupied – 68 degrees F (20 C); maintained – 55 degrees F (13 C)

Cooling, occupied – 78 degrees F (25 C); maintained – ambient

Ventilation – comply with ASHRAE 62.1

**Electrical**

Lighting – 50 fc

Receptacles – convenience and computer duplexes - **/2\** If no separation from workbays per NFPA 70 Article 511, no electrical within 18 in (460 mm) of floor **/2/**

Voice/data – two voice/data outlets at each workstation

**Furniture**

Same as full-time offices above except it should be darker or textured finish for easier maintenance

**Equipment**

**Special features or considerations**

**4-3.2** **/2\** Male and Female Toilets **/2/**

**Figure 4-36**  
**Unisex Toilet**

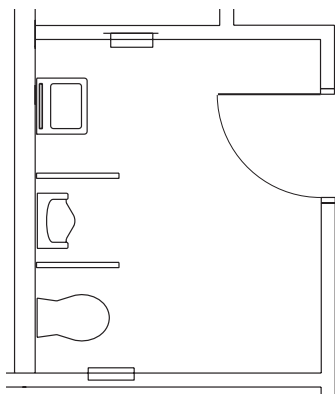

**4-3.2.1** **/3\** The toilet authorization for the OMS is typically sufficient for separate male and female toilet rooms. Where only a unisex toilet is authorized provide a toilet, urinal and sink. The designer should strive to meet accessibility requirements even though the OMS has an exception when it is occupied by only able-bodied military personnel. **/3/**

**4-3.2.2** Space Design Information: See Section 4-2.38 above.

**4-3.3** Tools and Parts Storage Room

**4-3.3.1** This space is the storage and issue area for spare parts and tools, especially mechanics' tool sets and organizational maintenance sets.

**4-3.3.2** The Tenants typically want the tools and parts areas of this room separated by caging or a hard wall, and may want the two areas further divided by caging for an individual unit's use. The designer should verify whether a Dutch door with shelf, or



sliding window, is required for issue of parts and tools, and whether one or more workstations are desired in the room.

**4-3.3.3** Steel shelving units are typically provided under the construction contract, and some floor space is typically left open for storage of larger items. The designer should verify the Tenants' shelving requirements.

#### **4-3.3.4** Space Design Information

##### **General/Code**

Size – 96 sf (8.9 sq m) per authorized workbay

Occupancy – low hazard storage

Occupancy count – not occupied; typically 1 person per 300 sf (27.9 sq m)

##### **Architectural/Interiors**

Minimum STC rating – 40

Ceiling height –

Floor – sealed concrete **/2\**; or VCT as alternative **/2/**

Base – none if CMU; rubber if gypsum board

Walls – painted CMU; painted gypsum board as an alternative

Ceiling – exposed structure, painted

Trim – **/2\** none **/2/**

Lockset – storeroom

##### **Mechanical**

Heating, occupied – 68 degrees F (20 C);  
maintained – 55 degrees F (13 C)

Cooling - none

Ventilation – ventilate if workstation located here

##### **Electrical**

Lighting – 30 fc

Receptacles – convenience duplexes; computer duplex if automated inventory

Voice/data – wall voice receptacle; data receptacle if automated inventory

##### **Furniture**

Workbench with laminate top and stool provided upon Tenant's request

##### **Equipment**

Open shelving

##### **Special features or considerations**

Ordinary hazard sprinklers

**Figure 4-37**  
**Tools and Parts Storage Room**

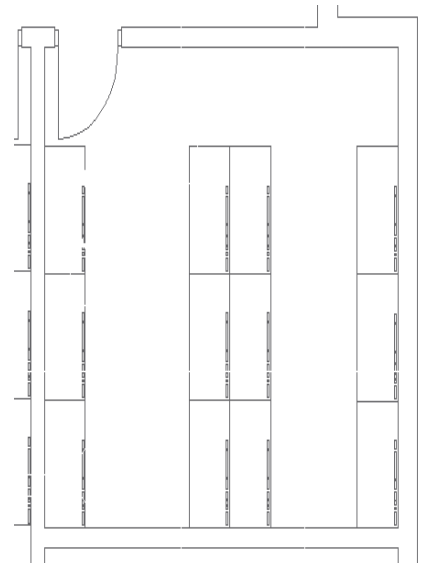

#### **4-3.4** Storage Room

**4-3.4.1** This space is provided for storage of ancillary equipment issued with vehicles, including operators' vehicle maintenance tools, canvas, canvas bows, seats, sideboards, etc. It is best located adjacent to tools and parts storage, and may be divided with caging for units.

**4-3.4.2** \3\ Steel shelving units are typically provided under the construction contract, and some floor space is typically left open for storage of larger items. The designer should verify the Tenants' shelving requirements. /3/

#### **4-3.4.3** Space Design Information

##### **General/Code**

Size – 96 sf (8.9 sq m) per authorized workbay

Occupancy – low-hazard storage

Occupancy count – not occupied; typically 1 person per 300 sf (27.9 sq m)

##### **Architectural/Interiors**

Minimum STC rating – 40

Ceiling height –

Floor – sealed concrete

Base – none if CMU; rubber if gypsum board

Walls – painted CMU; painted gypsum board as an alternative

Ceiling – exposed structure, painted

Trim – \2\ none /2/

Lockset – storeroom

##### **Mechanical**

Heating – 55 degrees F (13 C)

Cooling – none

Ventilation – ventilate if workstation located here

##### **Electrical**

Lighting – 30 fc

Receptacles – convenience duplexes; computer duplex if automated inventory

Voice/data – wall voice receptacle; data receptacle if automated inventory

##### **Furniture**

##### **Equipment**

Open shelving

##### **Special features or considerations**

Ordinary hazard sprinklers

#### **4-3.5** Special Equipment Alcove

**4-3.5.1** The Tenants typically have equipment such as tire changers, balancers, etc., which is in frequent use, but cannot be located within the maintenance bays. An authorization of 200 sf (18.6 sq m) is provided to accommodate this equipment. The designer should locate this alcove off the workbay area where this equipment can be permanently located, convenient to the workbays and with sufficient space for operation of the equipment.

**4-3.5.2** Space Design Information: Refer to the space design information for the workbays; this space is treated as an integral part of the workbays, and the space design should be the same.

#### 4-3.6 Battery Room

**4-3.6.1** Battery rooms are no longer authorized for an OMS; for exceptions, see information in paragraph 4-5.9.

#### 4-3.7 Flammable Storage

**4-3.7.1** This space is provided for storage of petroleum-based lubricants, paints, solvents, etc. for use in the OMS. Due to the volatile nature of the contents, it will have exterior access only, and CMU wall to structure or a concrete ceiling.

**4-3.7.2** The room should have a depressed well under a metal grate floor for collection of any spills: no drain. The well should be sloped to allow convenient suction of spills at a low point. The well should be capable of containing 150% of the stored materials; verify likely amount of stored materials with Tenants.

**4-3.7.3** Some steel shelving is typically provided, with some floor area left open for larger containers.

**4-3.7.4** OSHA requires emergency eyewash and showers where an employee's eyes or body could be exposed to injurious corrosive materials. For that reason, this space is typically located with ready access to an emergency eyewash and shower unit in the maintenance bay. Where ready access to an emergency eyewash and shower is not available, a unit should be installed. The requirement can be waived, where the Building Owner thoroughly documents that no injurious corrosive materials will be stored in this space. /2/

#### 4-3.7.5 Space Design Information

##### General/Code

Size – varies

Occupancy – high hazard storage

Occupancy count – not occupied; typically 1 person per 300 sf (27.9 sq m)

##### Architectural/Interiors

Minimum STC rating – 40

Ceiling height –

Floor – sealed concrete below metal grate

Base – none

Walls – painted CMU

Ceiling – 2 fire rated /2/

Trim – none

Lockset – entrance

##### Mechanical

Heating - 40 degrees F (4.4 C); explosion proof hot water or electric heater

**Figure 4-38**  
**Flammable Storage**

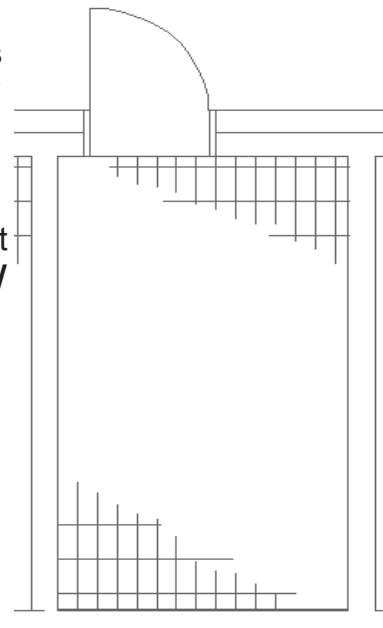

Cooling - none

Ventilation – ~~12~~ 6 AC/HR, 1 cfm/ft<sup>2</sup> (5 l/s/m<sup>2</sup>) or 150 CFM (4 m<sup>3</sup>/min) whichever is greatest. Inlets and outlets located 12" above ~~13~~ top of slab ~~13~~ positioned as far apart as practicable, to provide air movement across all portions of the floor. Fans shall be explosion/spark proof. Ventilation system shall be tied to lights unless dispensing activities are planned for space. If dispensing Class I fluids is planned for the space, continuous ventilation shall be provided and shall have an airflow switch or other equally reliable method that is interlocked to sound an audible alarm upon failure of the ventilation system, a pilot light by the light switch shall light when fan is operating ~~12~~

**Electrical**

Lighting – 10 fc; minimum of two explosion-proof fluorescents on exterior weatherproof pilot-lighted exterior switch. Provide low temperature ballasts.

Receptacles – none

Voice/data – none

**Equipment**

Open shelving

**Special features or considerations**

Extra hazard sprinklers; dry system in north

Open grating aluminum flooring over spill-collection basin

~~13~~ Design room to NEC Article 501 and 511 for a Class I Division II location ~~13~~

**4-3.8 Controlled Waste Storage**

**4-3.8.1** This space is provided for storage of waste materials or items for environmental protection, while awaiting recycling or other disposal. Due to the nature of the contents, it will have exterior access only, and CMU wall to structure or a concrete ceiling.

**4-3.8.2** The room should have a depressed well under a metal grate floor for collection of any spills. The well should be sloped to allow convenient suction of spills at a low point: no drain. The well should be capable of containing 150% of the stored materials; verify likely amount of stored materials with Tenants.

**4-3.8.3** Some steel shelving is typically provided, with some floor area left open for larger containers.

**4-3.8.4** ~~12~~ OSHA requires emergency eyewash and showers where an employee's eyes or body could be exposed to injurious corrosive materials. For that reason, this space is typically located with ready access to an emergency eyewash and shower unit in the maintenance bay. Where ready access to an emergency eyewash and shower is not available, a unit should be installed. The requirement can be waived, where the Building Owner thoroughly documents that no injurious corrosive materials will be stored in this space. ~~12~~

**4-3.8.5** Space Design Information**General/Code**

Size – varies

Occupancy – high hazard storage

Occupancy count – not occupied; typically 1 person per  
300 sf (27.9 sq m)**Architectural/Interiors**

Minimum STC rating – 40

Ceiling height –

Floor – sealed concrete below metal grate

Base – none

Walls – painted CMU

Ceiling – ~~12~~ fire rated ~~12~~

Trim – none

Lockset – entrance; code may require panic

**Mechanical**Heating - 40 degrees F (4.4 C); explosion proof hot  
water or electric heater

Cooling - none

Ventilation – ~~12~~ 6 AC/HR, 1 cfm/ft<sup>2</sup> (5 l/s/m<sup>2</sup>) or 150 CFM (4 m<sup>3</sup>/min) whichever is greatest. Inlets and outlets located 12" above ~~13~~ top of slab ~~13~~ positioned as far apart as practicable, to provide air movement across all portions of the floor. Fans shall be explosion/spark proof. Ventilation system shall be tied to lights unless dispensing activities are planned for space. If dispensing Class I fluids is planned for the space, continuous ventilation shall be provided and shall have an airflow switch or other equally reliable method that is interlocked to sound an audible alarm upon failure of the ventilation system, a pilot light by the light switch shall light when fan is operating ~~12~~

**Electrical**

Lighting – 10 fc; minimum of two explosion-proof fluorescents on exterior weatherproof pilot-lighted exterior switch. Provide low temperature ballasts.

Receptacles – none

Voice/data – none

**Equipment**

Open shelving

**Special features or considerations**

Extra hazard sprinklers; dry system in north

Open grating aluminum flooring over spill collection basin

~~13~~ Design room to NEC Article 501 and 511 for a Class I Division II location ~~13~~

**Figure 4-39**  
**Controlled Waste**  
**Storage**

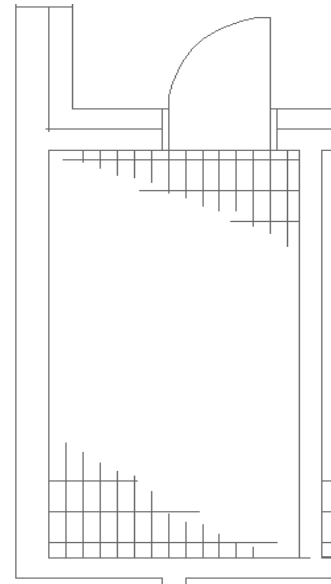
**4-3.9** Workbays

**4-3.9.1** The workbay provides space for training and for the performance of services and repairs of assigned equipment (mobile and stationary). There are two basic types of

workbay configurations, single access and drive-through double access. Drive-through workbays should be included whenever possible; two workbays end to end, with an overhead door at the opposite ends.

**4-3.9.2** The workbays are the heart of the OMS. The other support areas are normally located as closely adjacent to the workbays as possible under the exiting requirements of NFPA 101; consider locating most of them off a corridor into the workbay, with the other end of the corridor as their exit path. The functional layout should allow for the future addition of workbays, if possible.

**4-3.9.3** Water runoff from workbay cleaning operations will be collected in a trench drain located inside the overhead door and emptied into a grease/oil separator connected to the sanitary sewer. Designer should verify environmental requirements for drainage with USAR Installation, and local codes and regulations

**4-3.9.4** Welding is typically not authorized in an OMS. If authorized, a code-compliant hood or room must be provided. Comply with NFPA 70 Article 511 and NFPA 51B; a welding room would require double doors with a vestibule between if it opens to the workbays. If welding is not authorized, no provisions will be provided for meeting this requirement. The designer should verify power requirements.

**4-3.9.5** The workbays typically are taller than the other OMS supporting spaces with a 4.3 m (14 ft) minimum clear height, resulting in differing roof and wall heights for the two areas. In instances where it becomes more economical to construct the OMS with one roofline, use of the area above the ancillary shop spaces for additional storage and mechanical equipment space is discouraged. The designer must verify required clear workbay height with Tenants' vehicle sizes. ~~13~~ The maintenance bay interior walls from finish floor to roof deck should receive durable material to resist the harsh treatment associated with a shop environment. The interior wall finish should be concrete, concrete masonry units or other painted material approved by the Project Officer. ~~13~~

**4-3.9.6** The basic dimensions of the workbays are 20 ft (6.1 m) wide by 40 ft (12.2 m) long, which includes circulation space along the 20 ft (6.1 m) width. End workbays are authorized an additional 4 ft (1.2 m) of width on their outboard side to provide circulation space. Trench drains are located approximately 5 ft (1500 mm) from the exterior wall, and the floor slopes 3 in (75 mm) to them as shown below.

**4-3.9.7** Concrete aprons serve as outdoor workbays, especially for portable hydraulic hoists, and will be 36 ft (11 m) in depth.

**4-3.9.8** Vehicle exhaust drops should be located in each workbay. The drops must be of sufficient flexibility and length, and have appropriate terminations to adequately serve the units' vehicles.

**4-3.9.9** Designers should pay particular attention to coordination of systems in the space above the workbays. Lights, space conditioning, exhaust drops, power/light reels, overhead doors, etc., compete for space and must be coordinated for space



functionality. \3\ When practical allow natural light into the workbays./3/

**4-3.9.10** Overhead workbay doors are typically 16 ft by 14 ft (4900 mm wide by 4300 mm high) \3\ coiling steel with powered door operation/3/. Provide 6-inch diameter concrete filled with a concrete dome top, heavy weight steel protective bollards inside and outside of overhead door jambs and at corners of OMS buildings adjacent to traffic paths.

**4-3.9.11** An air sweep exhaust for the entire work area should be located \2\ under /2/ \3\ 12 in (300 mm) /3/ above the floor \2\ to effectively remove vapor accumulations/2/. \3\ The entire floor area of the workbays and areas adjoining the workbays to a level 18 inches (450 mm) above the floor should be designed as Class 1, Division 2 spaces per NFPA 70 Article 511 and NFPA 30A since the air sweep system is not to be run continuously. A continuously pressurized vestibule between the workbays and adjoining spaces or an 18 inch elevation change up to the adjoining spaces will negate the need to design adjoining spaces as Class 1, Division 2 spaces. Compliance with NFPA 70 Article 511 is necessary since the workbays could be utilized to maintain equipment utilizing diesel and/or volatile flammable liquids (gasoline) for fuel or power. Compliance with NFPA 30A is required since Class I liquids are handled in the workbay. Sweep ventilation must be run at a minimum of 1 cfm/sf or 4 air changes per hour when flammable liquids are being used in the occupied workbays, placarding shall be used to ensure compliance. Presently, the Army Reserve does not maintain equipment utilizing flammable gases but this could change in the future./3/

**Figure 4-40**  
**Workbays**

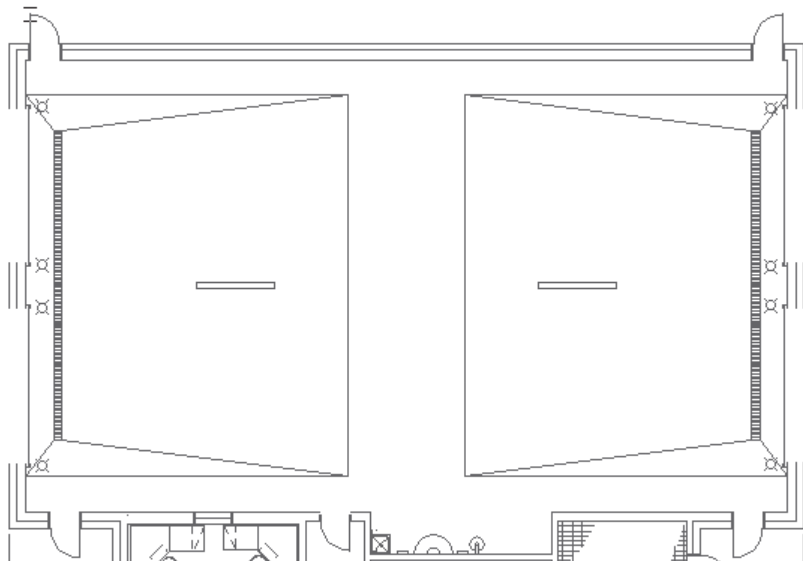

**4-3.9.12** An air compressor will be contractor-furnished and installed, and will normally be located in the mechanical room with a quick disconnect outlet in each workbay.

**4-3.9.13** A service sink, and drinking fountain will be provided in the workbay area. \2\

Provide at least one eyewash/deluge shower in the workbay area./2/ Hose bibbs will be provided in each workbay, contractor-furnished and installed.

**4-3.9.14** Overhead cranes are not typically authorized for an OMS; see 4-5.2.2 for overhead crane information, if authorized.

**4-3.9.15** Space Design Information

**\2\ General/Code**

Size – varies; base workbay is 800 sf (74.3 sq m)

Occupancy – repair garage; typically no fueling or welding

Occupancy count – 1 person per 300 sf (27.9 sq m)

**Architectural/Interiors**

Minimum STC rating – 40

Ceiling height – 14 ft (4300 mm) minimum clear

Floor – sealed concrete

Base – none

Walls – painted CMU

Ceiling – none, paint structure

Trim – none

Lockset – entrance

**Mechanical**

Heating - 68 degrees F (20 C); maintained - 55 degrees F (13 C)

NOTE: \3\ In climates exceeding 5,000 degree days, hydronic in-floor heating should be provided. Where in-floor heating cannot provide sufficient heat or rebound, utilize overhead infrared radiant heating or temporarily adjust delivery temperature of make-up air unit. In-floor heating should be coordinated with concrete slab on grade./3/

Cooling – none

Ventilation – comply with ASHRAE 62.1

**Electrical**

Lighting – 50 fc; \3\ high efficiency fluorescents or /3/ pendant 250W pulse start halide with wide distribution and acrylic lens

Receptacles – GFCI duplex receptacles at columns and on walls at 48 in (1220 mm) AFF

Voice/data – voice/data outlets in each bay

Ground - Provide a static ground receptacle readily available for each bay

**Furniture**

\1\ Workbenches with metal tops (One workbench per 20 ft x 40 ft workbay.)/1/

\3\ Designer - verify with Tenant if freestanding or built-in benches are preferred /3/

**Equipment**

Trouble light/power reel in each bay

**Special features or considerations**

Carbon monoxide detectors

Ordinary hazard sprinklers

Design grade-supported slabs to comply with UFC 3-310-02A and

UFC 3-320-06A /2/

**4-3.10 Mechanical/Electrical**

**4-3.10.1** Separate spaces are provided for the location of electrical panels, telephone equipment, water heaters, heating equipment, air compressors, and storage of maintenance equipment and supplies. Codes and Tenant preference may require separate rooms for telephone and/or electrical systems. Access may be exterior only.

**4-3.10.2 Space Design Information**

**General/Code**

Size – varies

Occupancy – low hazard storage

Occupancy count – not occupied; typically 1 person per 300 sf (27.9 sq m)

**Architectural/Interiors**

Minimum STC rating – 40

Ceiling height –

Floor – concrete

Base – none

Walls – painted CMU; painted gypsum board as an alternative

Ceiling – none; paint structure

Trim – none

Lockset – entrance

**Mechanical**

Heating – 55 degrees F (13C)

Cooling – ventilate sufficient to remove excess equipment heat

Ventilation – sufficient to remove excess equipment heat and to provide combustion air; one air change per hour minimum

**Electrical**

Lighting – 30 fc

Receptacles - Convenience duplex

Voice/data – none

**Equipment**

Air compressor for workbay

Open shelving

**Special features or considerations**

Connections to flow switches, tamper switches, and fire alarm

Power and data connections for computer if energy management control system

Ordinary hazard sprinklers

Floor drains for relief valves and condensate, hose bibb, eyewash if water treatment chemicals in room

Verify with Tenants any special connections for equipment

#### 4-3.11 Information Technology

**4-3.11.1** This space authorization is required to provide an IT hub for the OMS, with connection typically back to the training center network operations center. This may be part of a telephone room, and is sometimes located within the shop office in an out-of-the-way corner.

**4-3.11.2** Designer should coordinate the equipment requirements with the USAR Installation and Tenants.

#### 4-3.11.3 Space Design Information

*13\ Refer to Army Reserve IT Manual for IT spaces. The Army Reserve IT Manual is available at [www.lrl.usace.army.mil/ed2/default.asp?mycategory=212](http://www.lrl.usace.army.mil/ed2/default.asp?mycategory=212).13/*

#### 4-3.12 Custodial/Janitorial

**4-3.12.1** This space may be collocated within the maintenance bay/equipment alcove.

**4-3.12.2** Space Design Information: See Section 4-2.23 above. *13/*

### 4-4 UNHEATED STORAGE (UHS)

**4-4.1** An unheated storage building is provided for storage of equipment and supplies that do not require a controlled climate. These buildings are typically simple pre-engineered metal buildings, but may be designed to match other buildings in the facility if the project budget allows. One or more personnel doors and one or more overhead doors are typical; the standard overhead door size is 8 ft by 8 ft (2450 mm by 2450 mm). These buildings are not considered warehouses, and are not typically designed with recessed truck docks, or to accommodate material handling equipment.

**4-4.2** The interior space is also typically quite simple: concrete floor, unfinished walls, service-level lighting and convenience duplex outlets. A telephone may be provided for communications with the other buildings. No offices or other spaces are included. *13\ Provide sufficeint insulation under the roof deck to prevent condensation dripping on the interior content.13/* Normally, no sprinklers, plumbing, or HVAC are provided. *13\ Design should provide louvers to support natural convection and heat removal from the building. Per UFC 3-600-01 sprinklers shall be added if the building is over 5,000 SF ( 465 sq m).13/*

**4-4.3** The Tenants may wish to divide the space with caging to provide space for individual units, and may also want individual doors. Storage cages and shelving may also be required, along with open space for palletized storage.

**4-4.4** The space allocation for unheated storage is sometimes added to another building for functionality reasons. If this occurs, this space remains without climate

control. Designers should be aware that the other building may require fire sprinklers, and must address separation of the spaces accordingly.

**4-4.5** If a pre-engineered building is used, provide applicable design loads and prepare performance specification. Structural design will incorporate details and loads from any pallet rack systems. Special consideration should be made for frost protection in cold weather geographical areas.

## **4-5 AREA MAINTENANCE SUPPORT ACTIVITY (AMSA)**

### **4-5.1 General**

**4-5.1.1** The ancillary shop areas for AMSA, such as the shop offices, tool rooms, flammable storage, battery rooms, mechanical rooms, custodial areas and workbays are similar to those of OMS in functional requirements; therefore, refer to the OMS individual space criteria in Section 4-3 above for these AMSA spaces.

**4-5.1.2** An AMSA, due to its full-time staff and maintenance mission, is also authorized spaces and equipment not found in an OMS. These additional spaces are described below.

### **4-5.2 AMSA Workbays**

**4-5.2.1** There is one major difference between the OMS and AMSA (or DS/GS) workbays: an AMSA (or DS/GS) is authorized a crane. The crane typically covers the majority of workbays; it may not cover them entirely, but covers the bulk of the workspace.

**4-5.2.2** The typical crane is a 7.5 ton (6.8 metric ton), single-girder, top-running crane, equipped with a low-headroom, bottom-running trolley with a wire rope hoist. Structural columns with a supporting haunch must be strategically placed to support the crane girder and rail, which supports the bridge crane. The maximum span of the bridge crane itself will be 60 ft (18,000 mm). It is not economically feasible to span the entire 80 ft (24,000 mm) width of the building. Verify clear hook height required with the Tenants, based on the equipment they service. **12** Note that this lift height will be limited to a maximum of 18 ft (5,400 mm) for the standard structural eave height of 24 ft (7,200 mm). **12** Some units servicing heavier equipment may require a crane with a larger lifting capacity.

**4-5.2.3** The crane will be Class C, moderate service CMAA Duty Classification. Provide push button pendant **12** control station with strain-reliever chain or cable permanently attached to the hoist frame and integral with pendant conductor cable **12**. Minimum and maximum speeds: hoist 15 fpm (.076 m/s) and 25 fpm (.127 m/s); trolley 45 fpm (.229 m/s) and 75 fpm (.381 m/s); and bridge 75 fpm (.381 m/s) and 150 fpm (.762 m/s). Provide warning horn and light when crane is in motion, and warning alarm and light when crane malfunctions or is overloaded. **13** Provide positioning sensors on the bridge crane to shut down the infrared heaters when the crane is directly

underneath the heater(s). Coordinate control systems to allow other infrared heaters in the area to compensate and maintain proper heating levels in the area./3/

**4-5.2.4** Space Design Information – see OMS workbays, Section 4-3.9 above. See 4-3.9.4 if welding is authorized.

#### **4-5.3** Small Arms Shop and Vault

**4-5.3.1** The shop and vault provide space for the repair and storage of small arms such as rifles, machine guns, grenade launchers, etc. The shop should be located adjacent to the arms vault with access to the vault through the shop, similar to the armorer's and arms vault spaces in a training center.

**Figure 4-41**  
**Small Arms Repair Room with Arms Vault**

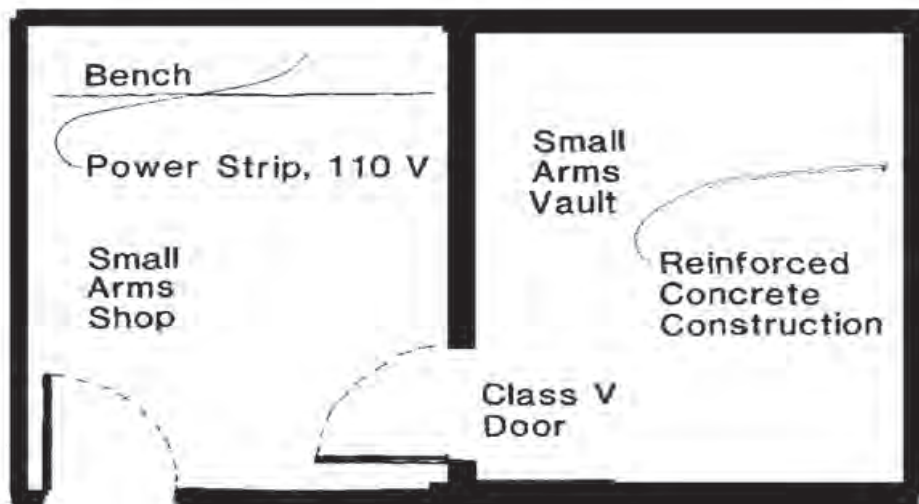

**4-5.3.2** A 110 volt continuous power strip should be provided over the work benches.

**4-5.3.3** Construction of the vault must be in compliance with AR 190-11. See Section 4-2.12 for additional vault design information.

**4-5.3.4** Space Design Information: Refer to arms vault and armorer's room, Sections 4-2.12 and 4-2.13 above. Provide air conditioning.

#### **4-5.4** Supply

**4-5.4.1** This space is provided for the storage, receipt and issue of spare parts for AMSA maintenance and operations. It is a part of the tools and parts room, but should be separated from the tools and parts with standard caging.

**4-5.4.2** Space Design Information: Same as OMS tools and parts storage, Section 4-3.3 above.



**4-5.4.3** A supply office may be provided adjacent to the supply space. The design criteria are the same as those for an OMS office space, Section 4-3.1 above.

#### **4-5.5** Electrical/Communications Repair

**4-5.5.1** This space is provided for the repair and storage of supported units' communications equipment.

**4-5.5.2** Space Design Information: Same as armorer's room, Section 4-2.13 above. Provide air conditioning, provide continuous 110V power strip above workbench, and provide a 28-volt DC power plug strip above the workbench for testing equipment after repairs. Provide static-dissipative VCT flooring.

**Figure 4-42**  
**Electric / Comm. Repair**

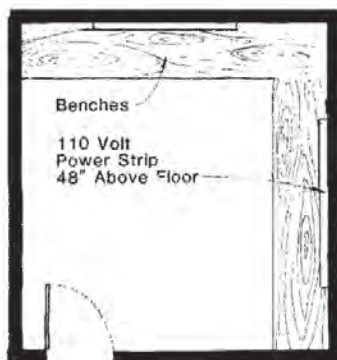

**Figure 4-43**  
**Break Area**

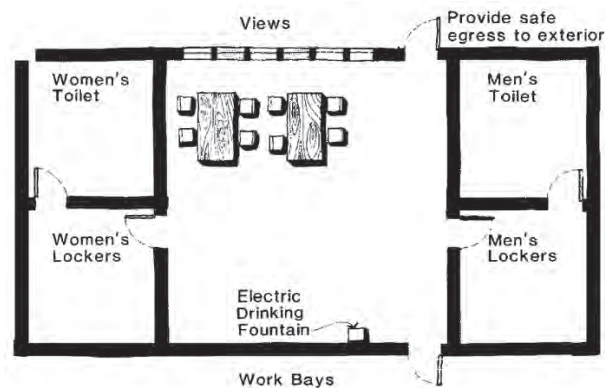

#### **4-5.6** Breakroom

**4-5.6.1** This is a multipurpose space for employee relaxation and meals, and to conduct classroom training activities. It should be located adjacent to the toilets and locker rooms, and should include a drinking fountain.

**4-5.6.2** Space Design Information: Same as training center break area, Section 4-2.42 above except use plastic shell seat and back sled-base stacking chairs without upholstery.

#### **4-5.7** Male and Female Locker Rooms

**4-5.7.1** These spaces will be used by the full-time, civilian maintenance technicians to store street clothing and to change. They should be located with the breakroom and toilets.

**4-5.7.2** One locker will be provided for each authorized AMSA position. Designer should consider providing a few extra lockers for each sex to anticipate staff turnover. The lockers should be heavy-duty steel athletic-type, 15 in wide by 18 in deep by 72 in tall (380 mm wide by 460 mm deep by 1830 mm tall).

**4-5.7.3** Space Design Information: Same as training center lockers, Section 4-2.40 above.

#### **4-5.8** Male and Female Toilets and Showers

**4-5.8.1** Toilets and showers are provided for the use and convenience of the personnel, and should be located with the breakroom and lockers.

**4-5.8.2** Space Design Information: Same as training center toilets and showers, Section 4-2.38 above.

#### **4-5.9** Battery Room

**4-5.9.1** This space is provided for servicing, charging, and storage of lead-acid batteries. The designer may find that the Tenants no longer service or charge batteries, and simply store them for short periods before exchange or after delivery. Unless otherwise directed by the Using Service, the room should be designed for full battery operations, in case the situation changes in the future. If this space opens into the workbays, the requirements of NFPA 70 Article 511 apply.

**4-5.9.2** Battery shelving is provided under the construction contract, and is typically of redwood, cedar or fiberglass, along the side of the room opposite the door. The shelves are usually tiered from front to back, with the lowest shelf at (18 in) 460 mm AFF.

**4-5.9.3** A hose bibb will be provided. No floor drain will be provided.

**4-5.9.4** Provide an electrical interlock system for the battery room exhaust fan/receptacle power wiring to eliminate the possibility of an explosion in the battery room caused by someone plugging a battery charger into a live receptacle in a room filled with explosive gas. The system shall include the following:

- Light switch on outside of the battery room shall energize the lights and exhaust fan in the room simultaneously. This switch shall have a pilot light to be lit when the switch is in the on position.
- Within the duct for the exhaust fan provide a sail switch that shall be connected to the receptacle power wiring.
- Interlock battery room exhaust fan sail switch with battery charger receptacles to deactivate and prevent charging upon loss of airflow./3/

**Figure 4-44**  
**Battery Room and Toilet**

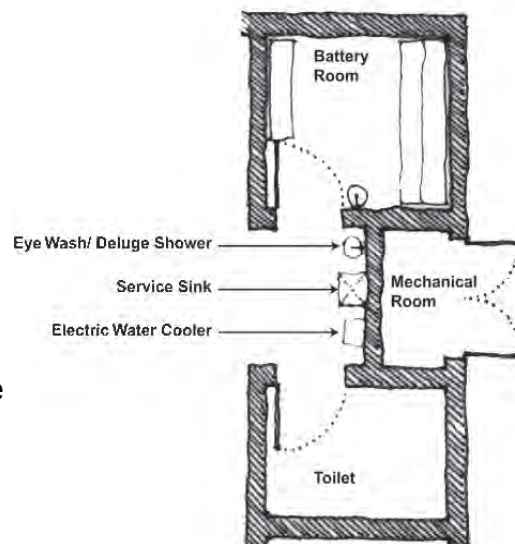

**4-5.9.5** Provide eyewash/deluge showers inside and outside the door to the room.

**4-5.9.6** Space Design Information

**General/Code**

Size – varies

Occupancy – high hazard storage

Occupancy count – not occupied; typically 1 person per 300 sf (27.9 sq m)

**Architectural/Interiors**

Minimum STC rating – 40

Ceiling height –

Floor – sealed concrete

Base – none

Walls – painted CMU

Ceiling – none, paint structure

Trim – none

Lockset – storeroom

**Mechanical**

Heating – 55 degrees F (13 C)

Cooling – none

Ventilation – explosion proof exhaust to keep hydrogen gas below 5% concentration; consider a hood above batteries

**Electrical**

Lighting – 20 fc; explosion-proof, fluorescent fixtures on pilot-lighted switch outside room

Receptacles – see special features below

Voice/data – none

**Furniture**

Workbench with laminate top and stool provided upon Tenant's request

**Equipment**

Battery shelving

**Special features or Considerations**

Continuous metal raceway with duplex receptacles at 24 in (600 mm) o.c. above battery racks; sail switch connection to ventilation

Ordinary hazard sprinklers

**4-6 DIRECT SUPPORT/GENERAL SUPPORT (DS/GS)**

**4-6.1** Direct support and general support (DS/GS) maintenance shops will be built only in support of a unit whose mission is DS/GS maintenance. This level of maintenance activity requires more specialized repair, calibration equipment, and highly skilled repairmen. The missions of specific units vary widely. Consequently, a standard design or even a functional space breakdown has not been developed for DS/GS units.

**4-6.2** The project documents will define the specific functional area breakdown and ancillary support equipment required for each DS/GS shop building. The Tenants will

provide a precise definition concerning the various maintenance functions of the DS/GS shop and the actual and perceived relationship between the various functions. The functional and physical requirements of the support facilities must be fully defined to ensure correct design and layout.

**4-6.3** DS/GS shops are rarely built separately from a United States Army Reserve Center (USARC); therefore, they will normally be built as a part of an OMS or as an addition to an existing OMS. If the facility's site has sufficient area, it may be more functional and economical to build a separate structure.

**4-6.4** The nature of the DS/GS shop operations require that all space be exclusive use. Therefore, the DS/GS shop will usually only share a central HVAC unit, a common wall, access/egress and toilet facilities with the OMS or OMS/AMSA.

**4-6.5** Support facilities for a DS/GS will be defined in the project documents for a specific project and may include a small MEP area, outside storage, covered storage and an adjacent concrete apron pad for location and operation of mobile maintenance shop trucks and vans. The design criteria for standard areas such as the shop office, tool room, battery room, flammable storage and workbays are the same as those for the OMS. Special maintenance areas, such as tent repair, sheet metal shop, paint shop, welding shop, etc., will be provided as required by the project documents.

#### **4-7 DEPLOYABLE MEDICAL SETS (DEPMEDS)**

**4-7.1** A DEPMEDS area is an exterior space allocated for Reserve units with Deployable Medical Sets: collapsible structures used to create a medical theater in the field. For mission essential equipment training (MEET), an area of 40,000 sf (3,720 sq m) is authorized.

**4-7.2** The DEPMEDS area is typically provided with an aggregate surface, security fencing, and exterior lighting similar to the MEP. The security fence should have both personnel and vehicle gates. Utility provisions typically include power, water, stormwater provisions to drain the area, and a graywater connection to a sanitary sewer. The Tenants will provide and install grounding rods for their equipment as a part of their training. All the DEPMEDS equipment is provided by the Tenants.

#### **4-8 WAREHOUSE**

**4-8.1** An USAR warehouse (WHS) is a building to accommodate a USAR unit with a full-time supply function in support of other USAR units or maintenance shops. No standard design or functional space breakdown has been developed for warehouses, as their size and specific functions and capabilities may vary.

**4-8.2** The project documents will define the specific functional area breakdown and ancillary support equipment required for each warehouse. The Tenants will provide further definition concerning the various storage and supply functions of the warehouse, and the actual and perceived relationship between the various functions. The functional

and physical requirements of the support facilities must be fully defined to ensure correct design and layout.

**4-8.3** Unlike an unheated storage building, a warehouse is likely to have raised or depressed loading docks with typical dock accessories such as dock levelers, dock bumpers, and seals. The dock and dock doors should be sized to accommodate the vehicles which will utilize it, as well as material handling equipment, if the Tenants have such equipment.

**4-8.4** Shelving, pallet racking, and similar systems should be provided to fit the Tenant's needs.

**4-8.5** A Hands-on-Training Warehouse (HOT WHS) is for training USAR units to support ongoing Army missions or activities. As with a warehouse, the designer must work with the Tenants to define the program for the HOT WHS.

## APPENDIX A

### REFERENCES

**V2\ A-1 REFERENCES:** References listed below without dates indicate that the latest version/revision will be used. The following references are directly referenced in this design guide:

#### GOVERNMENT PUBLICATIONS:

1. Non Department of Defense Government Agency

- |                                 |   |
|---------------------------------|---|
| ADAAG                           | Americans with Disabilities Act Accessibility Guidelines - <a href="http://www.access-board.gov/">http://www.access-board.gov/</a>  |
| DCID 6/9                        | 18 November 2002 - Physical Security Standards for Sensitive Compartmented Information Facilities - <a href="http://www.dami.army.pentagon.mil/site/sso/regs.aspx">http://www.dami.army.pentagon.mil/site/sso/regs.aspx</a> |
| EO 13123                        | Executive Order - Greening the Government Through Efficient Energy Management - <a href="http://www.archives.gov/">http://www.archives.gov/</a>   |
| EPA-840-B-92-002                | January 1993 - Guidance Specifying Management Measures for Sources of Nonpoint Pollution in Coastal Waters - <a href="http://www.epa.gov/OWOW/NPS/MMGI/index.html">http://www.epa.gov/OWOW/NPS/MMGI/index.html</a>          |
| Federal Specification AA-V-2737 | Modular Vault Systems - <a href="http://www.dsp.dla.mil">www.dsp.dla.mil</a>  |
| Federal Specification FF-L-2740 | Locks, Combination - <a href="http://www.dsp.dla.mil">www.dsp.dla.mil</a>   |
| UFAS                            | Uniform Federal Accessibility Standards (FED-STD-795) - <a href="http://www.dsp.dla.mil">www.dsp.dla.mil</a>  |

2. Department of Defense

**UNIFIED FACILITIES CRITERIA (UFC)** - [http://www.wbdg.org/ccb/browse\\_cat.php?o=29&c=4](http://www.wbdg.org/ccb/browse_cat.php?o=29&c=4)

- |                |  |
|----------------|--|
| UFC 1-200-01   | General Building Requirements          |
| UFC 1-110-03   | Roofing                                |
| UFC 3-120-01   | Air Force Sign Standard                |
| UFC 3-210-05FA | Landscape Design and Planning Criteria |
| UFC 3-230-10A  | Water Supply: Water Distribution       |



UFC 3-310-01	Structural Load Data
UFC 3-310-02A	Structural Design Criteria for Buildings
UFC 3-320-06A	Concrete Floor Slabs on Grade Subjected to Heavy Loads
UFC 3-400-01	Energy Conservation
UFC 3-400-02	Design: Engineering Weather Data
UFC 3-410-01FA	Heating, Ventilating and Air Conditioning
UFC 3-420-01	Plumbing Systems
UFC 3-420-02FA	Compressed Air
UFC 3-450-01	Noise and Vibration Control
UFC 3-600-01	Fire Protection Engineering For Facilities
UFC 4-010-01	DoD Minimum Antiterrorism Standards for Buildings
UFC 4-021-01	Design and O&M: Mass Notification Systems

**MILITARY HANDBOOK (MIL HDBK)** - [www.hnd.usace.army.mil/techinfo/support.htm](http://www.hnd.usace.army.mil/techinfo/support.htm)

MIL HDBK 1012/3 Telecommunications Premises Distribution - Planning, Design, and Estimating

2.1 Department of the Army

**ARMY REGULATIONS (AR)** - [www.usapa.army.mil/USAPA\\_PUB\\_search\\_P.asp](http://www.usapa.army.mil/USAPA_PUB_search_P.asp)

AR 140-483	Army Reserve Land and Facilities Management
AR 190-11	Physical Security of Weapons, Ammunition and Explosives
AR 190-13	The Army Physical Security Program
AR 190-16	Physical Security
AR PAM 415-3	Economic Analysis: Description and Methods
AR 420-10	Management of Installation Directorates of Public Works

**ENGINEER TECHNICAL LETTER (ETL)** - [www.hnd.usace.army.mil/techinfo/engpubs.htm](http://www.hnd.usace.army.mil/techinfo/engpubs.htm)

ETL 1110-1-181	Procurement of Energy Efficient Liquid Chillers
ETL 1110-3-446	Revision of Thrust Block Criteria in TM 5-813-5/AFM 88-10, Vol 5, Appendix C -- Note TM 5-813-5 is now UFC 3-230-10A this ETL applies to the UFC.
ETL 1110-3-465	Design & Construction of Water Meters & Appurtenances at New Army Facilities
ETL 1110-3-466	Alternatives for Secondary Treatment at Central Vehicle Wash Facilities
ETL 1110-3-481	Containment and Disposal of Aqueous Film-Forming Foam (AFFF) Solution
ETL 1110-3-484	Aircraft Hangar Fire Protection Systems
ETL 1110-3-485	Fire Protection for Helicopter Hangars

**TECHNICAL INSTRUCTION (TI)** - [www.hnd.usace.army.mil/techinfo/engpubs.htm](http://www.hnd.usace.army.mil/techinfo/engpubs.htm)

TI 800-01	Design Criteria
-----------	-----------------

**TECHNICAL MANUALS (TM)** - [www.hnd.usace.army.mil/techinfo/engpubs.htm](http://www.hnd.usace.army.mil/techinfo/engpubs.htm)

TM 5-810-6	Nonindustrial Gas Piping Systems
------------	----------------------------------

**TECHNICAL BULLETINS (TB)**

TB 55-46-1	Standard Characteristics (Dimensions, Weight, and Cube) for Transportability of Military Vehicles and Other Outsize/Overweight Equipment (in TOE line item number sequence <a href="http://www.tea.army.mil/">www.tea.army.mil/</a> (Permission required from web site to view publications))
------------	---

## 2.1.1 Headquarters United States Army Corps of Engineers (USACE)

USACE Army LEED Implementation Guide” ([https://eko.usace.army.mil/\\_kd/go.cfm?destination=\)ShowItem&Item\\_ID=47308](https://eko.usace.army.mil/_kd/go.cfm?destination=)ShowItem&Item_ID=47308)

2.1.2 Army Reserve Support Team Documents [www.lrl.usace.army.mil/ed2/default.asp?mycategory=212](http://www.lrl.usace.army.mil/ed2/default.asp?mycategory=212)

USAR Design Process and Submittal Requirements

Army Reserve IT Manual - Information Technology Design and Construction  
Guide

USAR Tailored Specifications for SpecsIntact

USAR Tailored Specifications for Design Build Contracts

USAR Design Build Instruction Manual

2.1.3 USACE Louisville District Documents [www.lrl.usace.army.mil/ed2/default.asp?mycategory=212](http://www.lrl.usace.army.mil/ed2/default.asp?mycategory=212)

Louisville District Tailored Specifications for SpecsIntact

Fire Protection/Life Safety Code Submittal

#### **NON-GOVERNMENT PUBLICATIONS:**

1. American Society of Civil Engineers (ASCE)  
1801 Alexander Bell Drive  
Reston, VA 20191-4400  
Ph: 703-295-6300 - 800-548-2723  
Fax: 703-295-6222  
E-mail: [marketing@asce.org](mailto:marketing@asce.org)  
Internet: <http://www.asce.org>

ASCE 7                      Minimum Design Loads for Buildings and Other Structures

2. American Society of Heating Refrigeration and Air Conditioning Engineers (ASHRAE)  
Atlanta, GA 30329  
Ph: 800-527-4723 or 404-636-8400  
Fax: 404-321-5478  
E-mail: [ashrae@ashrae.org](mailto:ashrae@ashrae.org)  
Internet: <http://www.ashrae.org>

ASHRAE 62.1              Ventilation for Acceptable Indoor Air Quality

ASHRAE 90.1              Energy Standard for Buildings Except Low-Rise Residential Buildings

ASHRAE Hndbks          Four Volume Set including Fundamentals, Refrigeration, HVAC Applications, and HVAC Systems and Equipment

3. International Code Council (ICC), Incorporated  
5203 Leesburg Pike, Suite 708  
Falls Church Virginia 22041-3401  
Ph: 703-931-4533  
Fax: 703-379-1546  
E-mail: [webmaster@iccsafe.org](mailto:webmaster@iccsafe.org)  
Internet: <http://www.iccsafe.org>  
  
IBC International Building Code  
  
IPC International Plumbing Code
4. Illuminating Engineering Society (IES)  
120 Wall Street, 17th Floor  
New York, NY 10005  
Ph: 212-248-5000  
Fax: 212-248-5017  
E-mail: [iesna@iesna.org](mailto:iesna@iesna.org)  
Internet: <http://www.iesna.org>  
  
IES Lighting Application Guide  
  
IES Lighting Reference Guide
5. National Electrical Manufacturers Association (NEMA)  
1300 North 17th Street, Suite 1847  
Rosslyn, VA 22209  
Ph: 703-841-3200  
Fax: 703-841-5900  
E-mail: [webmaster@nema.org](mailto:webmaster@nema.org)  
Internet: <http://www.nema.org>  
  
NEMA WD 1 General Color Requirements for Wiring Devices
6. National Fire Protection Association (NFPA)  
1 Batterymarch Park  
Quincy, MA 02169-7471  
Ph: 617-770-3000  
Fax: 617-770-0700  
E-mail: [webmaster@nfpa.org](mailto:webmaster@nfpa.org)  
Internet: <http://www.nfpa.org>  
  
NFPA 10 Portable Fire Extinguishers  
  
NFPA 13 Installation of Sprinkler Systems  
  
NFPA 30A Code for Motor Fuel Dispensing Facilities and Repair

Garage

NFPA 51B	Fire Prevention During Welding, Cutting, and Other Hot Work
NFPA 70	National Electrical Code (NEC)
NFPA 72	National Fire Alarm Code
NFPA 96	Ventilation Control and Fire Protection of Commercial Cooking Operations
NFPA 101	Life Safety Code
NFPA 780	Installation of Lightning Protection Systems
7.	Telecommunications Industry Association/Electronic Industries Alliance (TIA/EIA) Electronic Industries Alliance (EIA) 2500 Wilson Boulevard Arlington, VA 22201-3834 Ph: 703-907-7500 Fax: 703-907-7501 Internet: <a href="http://www.eia.org">http://www.eia.org</a>
TIA/EIA-568-B	Commercial Building Telecommunications Cabling Standard
TIA/EIA-568-B.1	Commercial Building Telecommunications Cabling Standard - Part 1: General Requirements
TIA/EIA-568-B.2	Commercial Building Telecommunications Cabling Standard - Part 2: Balanced Twisted Pair Cabling Components
TIA/EIA-568-B.3	Optical Fiber Cabling Components Standard
TIA/EIA-569-B	Commercial Building Standard for Telecommunications Pathways and Spaces
TIA/EIA-607	Commercial Building Grounding and Bonding Requirements for Telecommunications <i>/2/</i>

## APPENDIX B

### ACRONYMS AND MILITARY RANK DESIGNATIONS

**B-1.1** The Army Reserve frequently uses acronyms. Here is a list of those most commonly used. See website <http://www.dtic.mil/doctrine/jel/doddickt>

<b>A/E</b>	Architect/engineering
<b>AC</b>	Asphalt concrete
<b>ACSIM-ODR</b>	Assistant Chief of Staff for Installation Management- Operations Division Reserve
<b>ACT</b>	Acoustical ceiling tile
<b>ADA-AG</b>	Americans with Disabilities Act - Accessibility Guidelines
<b>AFFF</b>	Aqueous Film Forming Foam
<b>AGCCS</b>	Army Global Command Control System
<b>AMSA</b>	Area maintenance support activities
<b>AR</b>	Army Regulation OR Army Reserve
<b>ASCE</b>	American Society of Civil Engineers
<b>ASHRAE</b>	American Society of Heating, Refrigerating and Air Conditioning Engineers
<b>AT/FP</b>	Antiterrorism/Force Protection
<b>BIM</b>	Building Information Model or Building Information Modeling
<b>BMAR</b>	Backlog of maintenance and repair
<b>BMP</b>	Best management practices
<b>BOD</b>	Beneficial occupancy date
<b>BRAC</b>	Base Realignment and Closure
<b>CAC</b>	Common Access Card
<b>CAD</b>	Computer-aided design
<b>CATV</b>	Cable access television
<b>CCTV</b>	Closed circuit television
<b>CCL</b>	Construction cost limit
<b>CE-R</b>	Corps of Engineers Regulation
<b>CFCI</b>	Contractor-furnished/contractor-installed
<b>CFM</b>	Cubic Feet per Minute
<b>CFR</b>	Code of Federal Regulations
<b>CK</b>	Containerized Kitchen
<b>CMU</b>	Concrete Masonry Unit
<b>COE</b>	Corps of Engineers
<b>COMSEC</b>	Communications Security
<b>CT</b>	Current transformer
<b>CWE</b>	Current working estimate
<b>DAAR-EN</b>	Department of the Army, Army Reserve Engineering
<b>Design Agency</b>	Corps of Engineers and supporting architectural/ engineering firms
<b>DIA</b>	Defense Intelligence Agency



**B-1 CONTINUED**

<b>D/B</b>	Design/build
<b>D/B/B</b>	Design/bid/build
<b>DCID</b>	Director of Central Intelligence Directive
<b>DDC</b>	Direct digital controls
<b>DDG</b>	District design guide
<b>DEPMED</b>	Deployable medical
<b>DoD</b>	Department of Defense
<b>DOT</b>	Department of Transportation
<b>DPW</b>	Department of Public Works
<b>DRC</b>	Direct Reporting Command
<b>DS/GS</b>	Direct support and general support (maintenance shop)
<b>EA</b>	Environmental assessment
<b>EBS</b>	Environmental baseline survey
<b>ECS</b>	Equipment concentration site or Entry Control System
<b>EF</b>	Entrance Facility
<b>EFS</b>	Engineering Feasibility Study
<b>EPA</b>	Environmental Protection Agency
<b>ETL</b>	Engineering technical letter
<b>FEMA</b>	Federal Emergency Management Agency
<b>FFR</b>	Full Facility Restoration
<b>FONSI</b>	Finding of no significant impact
<b>FPI</b>	Federal Prison Industries
<b>FPM</b>	Feet per minute
<b>GFCI</b>	Government-furnished/contractor-installed or Ground-Fault Circuit Interrupter
<b>GFGI</b>	Government-furnished/government-installed
<b>GSA</b>	Government Service Administration
<b>HID</b>	High intensity discharge (lighting)
<b>HVAC</b>	Heating, ventilating, and air conditioning
<b>IDS</b>	Intrusion detection system
<b>IES</b>	Illuminating Engineering Society
<b>I-P</b>	Inch-pound
<b>IT</b>	Information technology
<b>LAN</b>	Local area network
<b>LCC</b>	Life cycle cost
<b>LCD</b>	Liquid crystal display
<b>LED</b>	Light emitting diode
<b>LEED-NC</b>	Leadership in Energy and Environmental Design New Construction and Major Renovations
<b>LP</b>	Lump sum
<b>LRL</b>	Louisville District, Corps of Engineers
<b>M&amp;R</b>	Maintenance and repair
<b>M-CACES</b>	Military Computer-Aided Cost Estimating System

**B-1 CONTINUED**

<b>MCAR</b>	Military Construction Army Reserve
<b>MDS</b>	Modular Design System
<b>MEP</b>	Military equipment parking area
<b>MILCON</b>	Military Construction
<b>MKT</b>	Mobile Kitchen Trailer
<b>MMCAR</b>	Minor Military Construction Army Reserve
<b>MOS</b>	Military occupational specialty
<b>MTOE</b>	Modification Table of Organization and Equipment
<b>NASA</b>	National Aeronautics Space Administration
<b>NAVFAC</b>	U.S. Naval Facilities Engineering Command
<b>NBS</b>	National Bureau of Standards
<b>NEC</b>	National Electrical Code - NFPA 70
<b>NEMA</b>	National Electrical Manufacturing Association
<b>NFPA</b>	National Fire Protection Association
<b>NOC</b>	Network Operations Center
<b>NPDES</b>	National Pollutant Discharge Elimination System
<b>OCE</b>	Office of the Corps of Engineers
<b>OMAR</b>	Operation and Maintenance Army Reserve
<b>OMS</b>	Organizational maintenance shops
<b>OPA</b>	Other Program Army
<b>OSHA</b>	Occupational Safety and Health Administration
<b>PA</b>	Programmed amount OR Project architect OR Public address
<b>PCC</b>	Portland cement concrete
<b>PF</b>	Protection factor
<b>PMO</b>	Provost Marshal Office
<b>POV</b>	Privately-owned vehicles
<b>PRV</b>	Plant replacement value
<b>PT</b>	Physical training
<b>RCAS</b>	Reserve Component Automation System
<b>REPR</b>	Real Estate Planning Report
<b>RFP</b>	Request for proposal
<b>RPX</b>	Real Property Exchange
<b>RRC</b>	Regional Readiness Command (Previous used name for RSC prior to BRAC 2005)
<b>RRSC</b>	Regional Readiness Sustainment Command (BRAC 2005 term for RSC)
<b>RSC</b>	Regional Support Command
<b>RST</b>	Reserve Support Team
<b>SCIF</b>	Secure compartmented intelligence facility
<b>SF</b>	Square foot
<b>SGML</b>	Standard Generalized Markup Language
<b>SLDC</b>	Single line digital control
<b>SSMRS</b>	Standing seam metal roof systems

**B-1 CONTINUED**

<b>SSO</b>	SCIF Security Officer
<b>STC</b>	Sound transmission coefficient
<b>TER</b>	Telecommunications Equipment Room
<b>TB</b>	Technical Bulletins
<b>TC</b>	Training center
<b>TI</b>	Technical Instruction
<b>TM</b>	Technical manual
<b>TR</b>	Telecommunications Room
<b>UBC</b>	Uniform Building Code
<b>UFAS</b>	Uniform Federal Accessibility Standards
<b>UFGS</b>	Unified Facility Guide Specifications
<b>UFGS RST</b>	UFGS - Reserve Support Team
<b>UNICOR</b>	Federal Prison Industry
<b>USACE</b>	U.S. Army Corps of Engineers
<b>USAR</b>	United States Army Reserve
<b>USARC</b>	United States Army Reserve Center
<b>USGBE</b>	U. S. Green Building Council
<b>Using Service</b>	Assistant Chief of Staff for Installation Management- Operations Division Reserve (ACSIM-ODR)
<b>VAV</b>	Variable air volume
<b>VCT</b>	Vinyl composition tile
<b>WAN</b>	Wide area network
<b>WBS</b>	Work breakdown structure

**\3\**

**B-1.2** Staff Designations - The following designations are used in the United States Armed Forces to designate different staff positions:

<b>G-1</b>	Deputy Chief of Staff for Personnel
<b>G-2</b>	Deputy Chief of Staff for Intelligence
<b>G-3</b>	Deputy Chief of Staff for Operations and Plans
<b>G-4</b>	Deputy Chief of Staff for Logistics
<b>G-5</b>	Civil Affairs or Public Affairs Officer
<b>G-6</b>	Director of Information Systems for Command, Control, Communications, and Computers (DISC4)
<b>G-7</b>	Joint Operations Staff Officer
<b>G-8</b>	Deputy Chief of Staff for Programs











The “G” designation is used for Army Reserve Headquarter level positions. At lower command levels the “G” designations are replaced by “S” designations.

**/3/**





**B-2 MILITARY RANK DESIGNATIONS**

**B-2.1** Military rank is frequently referred to by pay grade designations; such designations are listed below with their applicable rank insignia \2\

**OFFICER RANKS**









Pay Grade	Name	Abbreviation	Insignia
O1	Second Lieutenant	2LT	
O2	First Lieutenant	1LT	
O3	Captain	CPT	
O4	Major	MAJ	
O5	Lieutenant Colonel	LTC	
O6	Colonel	COL	
O7	Brigadier General	BG	
O8	Major General	MG	
O9	Lieutenant General	LTG	
O10	General	GEN	

**WARRANT OFFICER RANKS**

Pay Grade	Name	Abbreviation	Insignia
W1	Warrant Officer	WO1	
W2	Chief Warrant Officer	CW2	
W3	Chief Warrant Officer	CW3	
W4	Chief Warrant Officer	CW4	
W5	Chief Warrant Officer	CW5	

**B-2 CONTINUED**

**ENLISTED RANKS**

<b>Pay Grade</b>	<b>Name</b>	<b>Abbreviation</b>	<b>Insignia</b>
E1	Private	PV1	(No Insignia)
E2	Private	PV2	
E3	Private First Class	PFC	
E4	Corporal / Specialist	CPL/ SPC	
E5	Sergeant	SGT	
E6	Staff Sergeant	SSG	
E7	Sergeant First Class	SFC	
E8	Master Sergeant / First Sergeant	MSG / 1SG	
E9	Sergeant Major / Command Sergeant Major	SGM / CSM	

**121**

## APPENDIX C

### OMAR-FUNDED ITEMS

#### C-1 General

**C-1.1** \1\ Operations and Maintenance, Army Reserve or OMAR funding for furniture and collateral equipment associated with newly constructed Army Reserve training facilities must be identified well in advance of project execution for budgetary purposes. Physical fitness equipment will be funded at the same time as furniture, as Government furnished/ Government-installed (GFGI) equipment. /1/

**C-1.2** \1\ MCAR funding in general applies to items permanently attached to the structure which cannot be relocated to other facilities for easy reuse. Items that can be moved and reused with relative ease are considered collateral equipment and, as such, will be OMAR -funded. OMAR- funding associated with Contractor Furnished / Contractor Installed (CFCI) collateral equipment \3\ must comply with the “Bona-Fide Need Rule”. Generally speaking OMAR CFCI items must be installed within 180 days of item procurement; this will require option items with long bid acceptance periods. Certain items such as the telephone server/switch, metal lockers and caging (unit storage, arms vault and too and parts storage areas) which require a lengthy submittal process and that are made to order can have a longer delay between procurement and installation than items that are just placed. In considering the time required for long bid acceptance the Project Delivery Team (PDT) should consider award date, construction duration, lead time to procure items, and submittal requirements. The bid documents (specifications and drawings) must clearly define what is OMAR-funded collateral equipment and which line item it will be funded under. The bid form shall also narratively define what constitutes OMAR Collateral Equipment to be funded at or shortly after the time of award and what is to be awarded within six months of BOD. Bona-fide Need Rule does apply to Base Realignment and Closure (BRAC) projects. /3/ The furniture and physical readiness equipment will be funded approximately six months prior to beneficial occupancy date (BOD) as Government Furnished / Government Installed (GFGI) items. /1/

#### C-2 CFCI OMAR - Funded Items

**C-2.1** \3\ CFCI OMAR Funded Items - Funded at or near time of construction award

- Metal Lockers
- Caging for unit storage, arms vault, and tool and parts storage areas /3/

**C-2.2** \3\ CFCI “Bona Fide Need” OMAR Items - Awarded within six months of BOD

**C-2.2.1** Kitchen Equipment

- Silver soak sink
- Warming cabinet
- Mixer
- Mixer stand



## C-2 CONTINUED

- Work Tables, Mobile
- Hot food well
- Cold food well
- Slicer
- Table food preparation with pot & pan rack
- Can opener
- Refrigerator
- Freezer
- Mobile security rack
- Shelving (Freestanding)
- Tray bussing racks, double
- Coffee urn
- Dispenser, cup and glass
- Dispenser, silverware/tray

**C-2.2.2** Arms Vault dehumidifier

**C-2.2.3** Freestanding metal shelving included in caged storage areas

**C-2.2.4** Shelving and palette racks in unheated storage areas

**C-2.2.5** Break Room refrigerators and microwaves

**C-2.2.6** Fire extinguishers and window blinds

**C-2.2.7** Exterior ash/trash /3/

**C-3** \1\ GFGI OMAR-Funded Items,( Funded six months prior to BOD)

**C-3.1** All furniture (pre-wired panel-based systems furniture, metal desk-based furniture, seating, and freestanding furniture such as casegoods, filing cabinets, trash bins, etc., will require separate design and pricing breakout by phase, if applicable, in all project submittals)

**C-3.2** Physical fitness equipment (part of the furniture design and pricing) /1/

**C-3.3** \3\Telephone server/switch and telephone handsets (Note: conduit, cableing, trays, and racks are CFCI MCAR funded). Telephone server/switch and telephone handsets are funded under OMAR funding and coordinated by Army reserve G-2/G-6. Coordination with Army Reserve G-2/G-6 to ensure the project is in the Reserve Component Automation system (RCAS) program will have to be made by the Project Manager.

**C-4** Updates: Check the Army Reserve Customer Web Site for possible updates at [www.lrl.usace.army.mil/ed2/default.asp?mycategory=212./3/](http://www.lrl.usace.army.mil/ed2/default.asp?mycategory=212./3/)

APPENDIX D

SAMPLE 1390, 1391, AND 5034R - FUNCTIONAL SPACE DETAIL

D Sample 1390

1. COMPONENT AR	<b>FY 2002 GUARD AND RESERVE MILITARY CONSTRUCTION</b>	2. DATE Jul 01
3. INSTALLATION AND LOCATION Eldridge-Harrington USARC, Conway, AR		4. AREA CONSTR COST INDEX 0.87
5. FREQUENCY AND TYPE UTILIZATION		
Reservist	-	1 weekends/month      2 nights/week
Full-Time Personnel	-	5 days/week
6. OTHER ACTIVE GUARD/RESERVE INSTALLATIONS WITHIN 15 MILE RADIUS		
7. PROJECTS REQUESTED IN THIS PROGRAM		
<u>CATEGORY CODE</u>	<u>PROJECT TITLE</u>	<u>SCOPE</u>
171	AR Center/OMS/AMSA/Unh Strg	0 SF
	<u>COST (\$000)</u>	<u>(DESIGN STATUS) START      COMPLETE</u>
	5,630	N/A      N/A
8. STATE RESERVE FORCES FACILITIES BOARD RECOMMENDATION		
Facilities identified in item 6 have been examined by the <u>05 Oct 2000</u> Joint Service Reserve Component Facility Board for possible <span style="float: right;">(Date)</span> joint use/expansion. The board recommends unilateral construction.		
9. LAND ACQUISITION REQUIRED		
None		<u>0</u> (Number of Acres)
10. PROJECTS PLANNED IN NEXT FOUR YEARS		
	<u>FISCAL YEAR</u>	<u>COST (\$000)</u>
None		

**D Sample 1390 Continued**

1. COMPONENT AR	<b>FY 2002 GUARD AND RESERVE MILITARY CONSTRUCTION</b>	2. DATE Jul 01
3. INSTALLATION AND LOCATION Eldridge-Harrington USARC, Conway, AR		4. AREA CONSTR COST INDEX 0.87
11. PERSONNEL STRENGTH AS OF 29 Apr 2005		
	PERMANENT	GUARD/RES
	TOTAL    OFFICER    ENLISTED    CIVILIAN	TOTAL    OFFICER    ENLISTED
AUTHORIZED	<u>6</u> <u>0</u> <u>4</u> <u>2</u>	<u>107</u> <u>5</u> <u>102</u>
ACTUAL	<u>6</u> <u>0</u> <u>4</u> <u>2</u>	<u>66</u> <u>3</u> <u>63</u>
12. RESERVE UNIT DATA		
	ASGD/AUTH    62%	STRENGTH
UNIT DESIGNATION	AUTHORIZED	ACTUAL
489 EN BN CO B (CBT COR	<u>107</u>	<u>66</u>
Totals	<u>107</u>	<u>66</u>
13. MAJOR EQUIPMENT AND AIRCRAFT		
TYPE	AUTHORIZED	ACTUAL
Wheeled Vehicles	20	12
Trailers	23	14
Tracked Vehicles	19	12
Totals	<u>62</u>	<u>38</u>
14. OUTSTANDING POLLUTION AND SAFETY DEFICIENCIES		
		(\$000)
Air Pollution		0
Water Pollution		0
Safety and Occupational Health		0

**D Sample 1391**

1. COMPONENT AR	<b>FY 2002 MILITARY CONSTRUCTION PROJECT DATA</b>			2. DATE Jul 01
3. INSTALLATION AND LOCATION Eldridge-Harrington USARC Conway, AR			4. PROJECT TITLE AR Center/OMS/AMSA/Unh Strg	
5. PROGRAM ELEMENT 0532292A	6. CATEGORY CODE 171	7. PROJECT NUMBER CAR 02-10317	8. PROJECT COST (\$000) 5,630	
<b>9. COST ESTIMATES</b>				
ITEM	U/M	QUANTITY	UNIT COST	COST (\$000)
<u>PRIMARY FACILITIES:</u>				<u>3798</u>
Training Building (22,617 SF)	SF	22,617	102.08 (	2309)
Maintenance Building (5,454 SF)	SF	5,454	108.19 (	591)
Unheated Storage (536 SF)	SF	536	67.66 (	37)
Land	AC	10	83,200.00 (	832)
Antiterrorism/Force Protection	LS	-	-	( 29)
<u>SUPPORTING FACILITIES:</u>				<u>1274</u>
Site Improvement	LS	-	-	( 681)
Information Systems	LS	-	-	( 175)
Parking Area (6,751 SY)	SY	6,751	32.58 (	220)
Fencing (700 LF)	LF	700	20.05 (	15)
Antiterrorism/Force Protection	LS	-	-	( 8)
Utilities	LS	-	-	( 175)
TOTAL CONSTRUCTION COST				5072
Contingencies (5.0%)				254
Supervision and Administration (5.7%)				304
TOTAL PROJECT COST				5630
Equipment Funded Other Appropriations			(Non-Add)	( 685)
<b>10. DESCRIPTION OF PROPOSED CONSTRUCTION</b>				
<p>Construct a 100-member U.S. Army Reserve Training Center (USARC), an Unheated Storage Building, and a two-workbay Area Maintenance Support Activity (AMSA)/Organizational Maintenance Shop (OMS). Buildings will be of permanent construction with reinforced concrete foundations, concrete floor slabs, structural steel frames, masonry veneer walls, standing seam metal roof, HVAC systems, plumbing, mechanical systems, security systems, and electrical systems. Supporting facilities include land clearing, paving, fencing, general site improvements, and extension of utilities to serve projects. Force protection (physical security) measures will be incorporated into design including maximum standoff distance from roads, parking areas, and vehicle unloading areas; berms, heavy landscaping, and bollards to prevent access when standoff distance cannot be maintained.</p> <p>AIR CONDITIONING: 211 kws (55 Tons)</p>				

**D Sample 1391 Continued**

1. COMPONENT AR	<b>FY 2002 MILITARY CONSTRUCTION PROJECT DATA</b>	2. DATE Jul 01
3. INSTALLATION AND LOCATION Eldridge-Harrington USARC Conway, AR		
4. PROJECT TITLE AR Center/OMS/AMSA/Unh Strg		5. PROJECT NUMBER CAR 02-10317
<p>11. REQUIREMENT:        0 SF                                    Adequate:        0 SF                                    Substandard: 0 SF</p> <p>PROJECT: Construct a 100-member U.S. Army Reserve Training Center (USARC), an Unheated Storage Building, and a two-workbay Area Maintenance Support Activity (AMSA)/Organizational Maintenance Shop (OMS). (Current Mission)</p> <p>REQUIREMENT: This project will provide facilities necessary to conduct and support training of the reserve components by replacing the existing government-owned 1959 vintage facility located on leased land. This project includes construction of a 100-member training facility with administrative areas, classrooms, library, learning center, assembly hall, arms vault, and unit storage functions for one FSP Tier 1A Engineer Unit. The construction of the OMS shop consists of two workbays and maintenance administrative areas to support 3 fulltime mechanics and 1 maintenance administrative personnel. The project will also provide adequate parking space for all military and privately owned vehicles.</p> <p>CURRENT SITUATION: The Eldridge-Harrington USARC, constructed in 1959, consists of a government-owned 12,189 square feet training building, and a 3,050 square feet maintenance building located on a three acre nominal land lease from the Board of Trustees of the Arkansas State Teachers College, now the University of Central Arkansas, that expires in 2056. One Engineer Company and an AMSA Sub-Shop occupy the facility. The current utilization rate is 168% for the training building and 135% for the maintenance building. The site is completely enclosed by the University campus prohibiting future expansion.</p> <p>IMPACT IF NOT PROVIDED: The Engineer Company would continue to train in their current facilities. The operation of engineer equipment disrupts the surrounding University resulting in negative community impact. The overcrowded existing facilities do hamper in the training and readiness of the unit.</p> <p>ADDITIONAL: This project was coordinated with the 90th Regional Support Command physical security plan and no force protection/combating terrorism measures other than those required by regulations and design guides for protecting Federal property are included.</p> <p>JOINT USE CERTIFICATION: The Deputy Assistant Secretary of the Army (Installations and Housing) certifies that this project has been considered for joint use potential. This facility will be available for use by other components.</p>		

**D Sample 1391 Continued**

1. COMPONENT AR	<b>FY 2002 MILITARY CONSTRUCTION PROJECT DATA</b>	2. DATE Jul 01																																				
3. INSTALLATION AND LOCATION Eldridge-Harrington USARC Conway, AR																																						
4. PROJECT TITLE AR Center/OMS/AMSA/Unh Strg		5. PROJECT NUMBER CAR 02-10317																																				
12. SUPPLEMENTAL DATA																																						
<p>12. SUPPLEMENTAL DATA:</p> <p>a. Estimated design data:</p> <p>(1) Status:</p> <p>(a) Date Design Started..... /</p> <p>(b) Percent Complete as of ..... %</p> <p>(c) Date Design 35% Complete..... /</p> <p>(d) Date Design Complete..... /</p> <p>(e) Parametric Cost Estimating Used to Develop Cost. No</p> <p>(f) An energy study and life cycle cost analysis will be documented during the final design.</p> <p>(g) Type of Design Contract.....</p> <p>(2) Basis:</p> <p>(a) Standard or Definitive Design..... No</p> <p>(b) Where Design Was Most Recently Used... N/A</p> <p>(3) Total Cost (c) = (a) + (b) or (d) + (e) : (\$000)</p> <p>(a) Production of Plans and Specifications..... 0</p> <p>(b) All Other Design Costs..... 0</p> <p>(c) Total..... 0</p> <p>(d) Contract..... 0</p> <p>(e) In-house..... 0</p> <p>(4) Construction Award..... /</p> <p>(5) Construction Start..... /</p> <p>(6) Construction Completion..... /</p> <p>b. Equipment associated with this project which will be provided from other appropriations:</p> <table style="width: 100%; margin-top: 20px;"> <thead> <tr> <th style="text-align: left;"><u>Equipment Nomenclature</u></th> <th style="text-align: left;"><u>Procuring Appropriation</u></th> <th style="text-align: center;"><u>Fiscal Year Appropriated or Requested</u></th> <th style="text-align: right;"><u>Cost (\$000)</u></th> </tr> </thead> <tbody> <tr> <td>Furniture</td> <td>OMAR</td> <td style="text-align: center;">2003</td> <td style="text-align: right;">188</td> </tr> <tr> <td>Shelving</td> <td>OMAR</td> <td style="text-align: center;">2002</td> <td style="text-align: right;">111</td> </tr> <tr> <td>Fitness Equipment</td> <td>OMAR</td> <td style="text-align: center;">2003</td> <td style="text-align: right;">50</td> </tr> <tr> <td>Wire Partitions</td> <td>OMAR</td> <td style="text-align: center;">2002</td> <td style="text-align: right;">128</td> </tr> <tr> <td>Dehumidifier</td> <td>OMAR</td> <td style="text-align: center;">2003</td> <td style="text-align: right;">1</td> </tr> <tr> <td>IT SPT Equipment</td> <td>OMAR</td> <td style="text-align: center;">2003</td> <td style="text-align: right;">157</td> </tr> <tr> <td>Lockers</td> <td>OMAR</td> <td style="text-align: center;">2002</td> <td style="text-align: right;">50</td> </tr> <tr> <td colspan="3" style="text-align: right;">Total:</td> <td style="text-align: right; border-top: 1px solid black;">685</td> </tr> </tbody> </table>			<u>Equipment Nomenclature</u>	<u>Procuring Appropriation</u>	<u>Fiscal Year Appropriated or Requested</u>	<u>Cost (\$000)</u>	Furniture	OMAR	2003	188	Shelving	OMAR	2002	111	Fitness Equipment	OMAR	2003	50	Wire Partitions	OMAR	2002	128	Dehumidifier	OMAR	2003	1	IT SPT Equipment	OMAR	2003	157	Lockers	OMAR	2002	50	Total:			685
<u>Equipment Nomenclature</u>	<u>Procuring Appropriation</u>	<u>Fiscal Year Appropriated or Requested</u>	<u>Cost (\$000)</u>																																			
Furniture	OMAR	2003	188																																			
Shelving	OMAR	2002	111																																			
Fitness Equipment	OMAR	2003	50																																			
Wire Partitions	OMAR	2002	128																																			
Dehumidifier	OMAR	2003	1																																			
IT SPT Equipment	OMAR	2003	157																																			
Lockers	OMAR	2002	50																																			
Total:			685																																			



**D Sample 5034-R**

Project Number : 10317  
 Project Title : AR Center/OMS/AMSA/Unh Strg  
 Date: Jun 30, 2005

**Functional Space Details - Actual/ English**

**171 - Training Building**

	Authorized	Approved	Existing	Memo
<b>I. 171 - Training Buildings</b>				
A. Administrative Areas	2,971	3,131	0	
(1) Full Time Office Space	360	360	0	X
(2) Unit Exclusive Space	270	270	0	X
(3) Unit Common-Use Space	1,311	1,311	0	X
(4) Retention Office	250	250	0	X
(5) Family Support Office	0	0	0	
(6) Admin. Support Areas	300	460	0	
(a) General	180	180	0	X
(b) Network OPS Center	120	280	0	X
(c) Campus Center IT Closet	0	0	0	
(7) Lobby Area	480	480	0	X
B. Assembly Area	3,300	3,300	0	
(1) Assembly Areas	3,000	3,000	0	X
(2) Chair and Table Storage	300	300	0	X
C. Kitchen - STD. Design	0	0	0	
D. Weapons Area	540	540	0	
(1) Arms Vault	440	440	0	X
(2) Armorer Work Area	100	100	0	X
E. Educational Areas	1,730	1,730	0	
(1) Classrooms	900	900	0	X
(2) Library Reading Room	300	300	0	X
(3) Library Storage	90	90	0	X
(4) Learning Center	150	150	0	X
(5) Training Aids Storage	90	90	0	X
(6) COMSEC Training	100	100	0	X
(7) COMSEC Storage	100	100	0	X
(8) USARF Instruction Room	0	0	0	
(9) USARF Publication Storage	0	0	0	
F. Storage Areas	3,157	3,157	0	
(1) Unit/Individual Equipment Storage	1,988	1,988	0	X
(2) Staging Area	199	199	0	X
(3) Supply Office	120	120	0	X
(4) Janitorial Storage	50	50	0	X
(5) Flammable Storage	0	0	0	

**D Sample 5034-R Continued**

Project Number : 10317  
 Project Title : AR Center/OMS/AMSA/Unh Strg  
 Date: Jun 30, 2005

**Functional Space Details - Actual/ English**  
**171 - Training Building**

	Authorized	Approved	Existing	Memc
(6) Controlled Waste Storage	0	0	0	
(7) Facility Maintenance/Storage Area	800	800	0	X
G. Special Training Areas	1,100	2,525	0	
(1) Weapons Simulator Room	0	0	0	
(2) Photo Lab	0	0	0	
(3) Band Room	0	0	0	
(4) Medical Section Area	0	0	0	
(5) Physical Exam Wing	0	0	0	
(6) SCIF	0	0	0	
(7) Soil Testing Lab	0	0	0	
(8) G. O. Conference	0	0	0	
(9) Drafting Room	0	0	0	
(10) Physical Readiness Area	1,100	1,100	0	X
(11) AGCCS	0	0	0	
(12) Distant Learning Center	0	0	0	
(13) Family Support	0	200	0	X
(14) Weapons Simulat	0	1,225	0	X
(15)	0	0	0	
(16)	0	0	0	
H. Support Area	3,493	3,635	0	
(1) Mens Toilets & Showers	350	350	0	X
(2) Womens Toilets & Showers	225	225	0	X
(3) Locker Room	1,100	1,100	0	X
(4) Vending Alcove	48	48	0	
(5) Break Area	218	218	0	X
(6) Electrical Space	100	100	0	X
(7) Demarcation Telephone Space	100	100	0	X
(8) Mechanical Room	1,352	1,494	0	X
Total Center Net Training Area	16,291	18,018	0	
Circulation Allowance (15% or 22%)	2,444	2,714	0	
Structural Allowance (10% of Net SF)	1,630	1,810	0	
Total Center Gross Area	20,365	22,542	22,604	
Outgranted Area			0	

## D Sample 5034-R Continued

Project Number : 10317  
Project Title : AR Center/OMS/AMSA/Unh Strg  
Date : Jun 30, 2005

### Functional Space Details - Actual/ English

#### 171 - Training Building

- IA1 Full Time Office Space -  
ADMINISTRATIVE AREA, FULL TIME:  
WRKCB0 is authorized three full time personnel with administrative duties.  
  
3 FTS x 11.14 SM (360 SF) = 33.4 SM (360 SF)
- IA2 Unit Exclusive Space -  
ADMINISTRATIVE AREA, UNIT EXCLUSIVE:  
  
WRKCB0: 1 CDR<06 x 13.9 SM (150 SF) = 13.9 SM (150 SF)  
1 1SG x 11.14 SM (120 SF) = 11.14 SM (120 SF)  
TOTAL = 25.1 SM (270 SF)
- IA3 Unit Common-Use Space -  
ADMINISTRATIVE AREA, UNIT COMMON:  
  
Unit requires 19 unit common spaces.  
19 Unit Common x 5.57 SM (60 SF) x 1.15 (Circulation) = 121.8 SM (1,311 SF)
- IA4 Retention Office -  
ADMINISTRATIVE AREA, RETENTION:  
  
Normal authorization is 23.2 SM (250 SF). Retention Office should be located near the main entrance to the facility.
- IA6a General -  
ADMIN SUPPORT, GENERAL:  
  
ALLOWANCE IS BASED ON THE TOTAL AUTHORIZED DRILLING STRENGTH OF THE LARGEST DRILL WEEKEND. SIXTY SQUARE FEET IS AUTHORIZED FOR EACH INCREMENT OR PORTION THEREOF OF 50 MEMBERS. SPACE IS PROVIDED FOR COPIER, FAX, AND MAIL OPERATIONS. SHOULD BE LOCATED NEAR ADMINISTRATIVE AREAS.  
  
LARGEST DRILL WEEKEND HAS 107 SOLDIERS.  
  
 $109 \text{ SOLDIERS} / 50 = 2.18 \Rightarrow 3 \times 5.57 \text{ SM (60 SF)} = 16.7 \text{ SM (180 SF)}$
- IA6b Network OPS Center -  
ADMIN SUPPORT, RCAS:  
  
References:  
  
a. Memorandum, HQ USARC, AFRC-CIS-I, 22 July 1999, Subject: Information Technology (IT) Requirements for Military Construction Army Reserve.

## D Sample 5034-R Continued

Project Number : 10317  
Project Title : AR Center/OMS/AMSA/Unh Strg  
Date : Jun 30, 2005

### Functional Space Details - Actual/ English

#### 171 - Training Building

b. Memorandum, OCAR, DAAR-EN, 27 October 1999, Subject: Information Technology Requirements in Design and Construction.

IT services provided on-site will include:  
Voice Communications (Telephone)  
Logistics, and other, STAMIS Applications

Within the 1-4 FTUS site, all IT support equipment will be rack-mounted in climate controlled facilities as IT Support Facilities. Recommended square footage for 1-4 FTUS IT Support Facilities are:

Network Operations Center (NOC)	14.9 SM (160 SF)
Electrical Closet	11.1 SM (120 SF)
TOTAL	26.0 SM (280 SF)

The Electrical Closet here is in addition to the normal authorization in Section H.(8).

Design and construction should comply with Reference a.

IA7 Lobby Area -  
LOBBY AREA::

Normal authorization is 44.6 SM (480 SF).

IB1 Assembly Areas -  
ASSEMBLY AREA: PROVIDES SPACE FOR TROOP FORMATIONS, PERSONNEL ASSEMBLIES, FOOD SERVICE AND LARGE GROUP ASSEMBLIES FOR INSTRUCTIONAL TRAINING.

LOCATE ADJACENT TO THE UNIT SUPPLY, CHAIR AND TABLE STORAGE, AND CLASSROOM AREAS.

PROVIDE 10' MINIMUM CEILING HEIGHT IN THE ASSEMBLY AREA TO SUPPORT CLASSROOM TYPE TRAINING AND ASSEMBLY/DINING REQUIREMENTS OF THE UNITS ASSIGNED TO THE CENTER. THE ASSEMBLY AREA MAY HAVE A MOVEABLE PARTITION TO SUBDIVIDE THE ROOM INTO EQUALLY SIZED ASSEMBLY AREAS.

IB2 Chair and Table Storage -  
CHAIR & TABLE STORAGE: LOCATE ADJACENT TO THE ASSEMBLY AREA.

ID1 Arms Vault -  
VAULT: VAULT SHOULD BE PROVIDED WITH ELECTRICAL AND PLUMBING FOR A DEHUMIDIFIER. LOCATE ADJACENT TO THE STAGING AREA WITH ENTRANCE TO THE VAULT THROUGH THE ARMORER AREA.

**D Sample 5034-R Continued**

Project Number : 10317  
Project Title : AR Center/OMS/AMSA/Unh Strg  
Date : Jun 30, 2005

**Functional Space Details - Actual/ English**

**171 - Training Building**

- ID2 Armorer Work Area -  
ARMORER: SHOULD BE PROVIDED WITH ENTRANCE TO VAULT THROUGH THIS 9.3 SM (100 SF) AREA AND ADJACENT TO STAGING AREA.
- IE1 Classrooms -  
EDUCATIONAL AREAS, CLASSROOMS:  
  
CLASSROOMS ARE AUTHORIZED BASED ON THE TOTAL AUTHORIZED DRILLING STRENGTH OF THE LARGEST DRILL WEEKEND.  
  
 $109 \text{ SOLDIERS}/50 = 2.18 \rightarrow 3.0 \times 27.9 \text{ SM (300 SF)} = 83.7 \text{ SM (900 SF)}$  IS AUTHORIZED FOR CLASSROOMS.  
  
PROVIDE ONE 83.7 SM (900 SF) CLASSROOM WITH MOVEABLE PARTITION TO SUBDIVIDE THE CLASSROOM INTO THREE 300 SF CLASSROOMS FOR SMALLER GROUPS. PROVIDE HALLWAY ACCESS TO ALL CLASSROOMS. LOCATE THE CLASSROOMS NEAR AN OUTSIDE ENTRANCE FOR EASY ACCESS WITHOUT GOING THROUGH THE ADMINISTRATIVE AREA.
- IE2 Library Reading Room -  
EDUCATIONAL AREAS, LIBRARY READING ROOM:  
  
ALLOWANCE IS BASED ON THE TOTAL AUTHORIZED DRILLING STRENGTH OF THE LARGEST DRILL WEEKEND.  
  
THE MINIMUM AUTHORIZED SPACE IS 27.9 SM (300 SF).  
  
THE LIBRARY READING ROOM SHALL BE DESIGNED TO ACCOMMODATE READING/STUDY OR CLASSROOM/CONFERENCE ACTIVITIES. LAYOUT OF THE LIBRARY READING ROOM, LEARNING CENTER, AND LIBRARY STORAGE/REFERENCE ROOM SHALL BE SIMILAR TO THAT SHOWN ON PAGE 35 OF THE DESIGN GUIDE FOR U.S. ARMY RESERVE FACILITIES. LOCATE ADJACENT TO THE LIBRARY STORAGE, LEARNING CENTER, AND TRAINING AID STORAGE AREAS.
- IE3 Library Storage -  
EDUCATIONAL AREAS, LIBRARY STORAGE:  
  
ALLOWANCE IS 10% OF TOTAL CLASSROOM SPACE.  
  
 $83.6 \text{ SM (900 SF)} \times 10\% = 8.4 \text{ SM (90 SF)}$   
  
PROVIDE SHELVING TO STORE BOOKS, MANUALS, VIDEO TAPES, AND EIGHT-INCH TECH TAPES IN THE LIBRARY STORAGE ROOM. LOCATE ADJACENT TO THE LEARNING CENTER, LIBRARY READING ROOM, AND TRAINING AID STORAGE AREAS.

**D Sample 5034-R Continued**

Project Number : 10317  
Project Title : AR Center/OMS/AMSA/Unh Strg  
Date : Jun 30, 2005

**Functional Space Details - Actual/ English**

**171 - Training Building**

- IE4 Learning Center -  
EDUCATIONAL AREAS, LEARNING CENTER:
- ALLOWANCE IS BASED ON THE TOTAL AUTHORIZED DRILLING STRENGTH OF THE LARGEST DRILL WEEKEND.
- $109 \text{ SOLDIERS}/50 = 2.18 \Rightarrow 3 \times 4.64 \text{ SM (50 SF)} = 13.9 \text{ SM (150 SF)}$
- PROVIDE DUPLEX ELECTRICAL OUTLETS AT FOUR FOOT INTERVALS ALONG THE WALLS FOR OPERATION OF CARRELS WITH COMPUTER CONNECTIONS IN THE LEARNING CENTER. USE ONLY SINGLE, NOT DOUBLE, CARRELS IN THE FURNITURE DESIGN. LOCATE NEAR THE LIBRARY READING ROOM, LIBRARY STORAGE, AND TRAINING AID STORAGE AREAS.
- IE5 Training Aids Storage -  
EDUCATIONAL AREAS, TRAINING AIDS STORAGE:
- ALLOWANCE IS 10% OF TOTAL CLASSROOM SPACE.
- $83.6 \text{ SM (900 SF)} \times 10\% = 8.4 \text{ SM (90 SF)}$
- PROVIDE SHELVING IN THE TRAINING AIDS STORAGE ROOM. LOCATE ADJACENT TO THE CLASSROOMS.
- IE6 COMSEC Training -  
COMSEC TRAINING: PROVIDE ONE 9.3 SM (100 SF) AREAS LOCATED ADJACENT TO THE COMSEC STORAGE FOR THE UNIT AUTHORIZED.
- IE7 COMSEC Storage -  
COMSEC STORAGE: PROVIDE ONE 9.3 SM (100 SF) AREAS LOCATED ADJACENT TO THE COMSEC STORAGE FOR THE UNIT AUTHORIZED.
- IF1 Unit/Individual Equipment Storage -  
UNIT/INDIVIDUAL EQUIPMENT STORAGE:
- SUBDIVIDE INTO 2.4-METER BY 3.7-METER (8-FOOT BY 12-FOOT) CAGES CONSTRUCTED OF WOVEN WELDED WIRE FABRIC. CAGING SHOULD BE INSTALLED FROM FLOOR TO THE ROOF DECK OR FLOOR SLAB ABOVE. AISLES AND VESTIBULES BETWEEN THE CAGED AREAS SHOULD BE KEPT TO A MINIMUM.
- $18 \text{ CAGES @ } 8.92 \text{ SM (96 SF)} = 161 \text{ SM (1728 SF)}$   
 $\text{CIRCULATION @ } 15\% = 24 \text{ SM (260 SF)}$   
 $\text{TOTAL} = 185 \text{ SM (1988 SF)}$
- IF2 Staging Area -  
STAGING AREA: Area will be 10% of the total individual storage area authorized.



**D Sample 5034-R Continued**

Project Number : 10317  
Project Title : AR Center/OMS/AMSA/Unh Strg  
Date : Jun 30, 2005

**Functional Space Details - Actual/ English**

**171 - Training Building**

Staging area should have an exterior double door and adjacent to the supply office.

IF3 Supply Office -  
SUPPLY OFFICE:

One office of 11.15 SM (120 SF) is authorized for the fulltime supply person. The office should be located adjacent to the staging area and unit supply storage area.

IF4 Janitorial Storage -  
STORAGE AREAS, JANITORIAL STORAGE:

AUTHORIZED ALLOWANCE IS 4.6 SM (50 SF) FOR STORAGE OF JANITORIAL SUPPLIES AND EQUIPMENT.

IF7 Facility Maintenance/Storage Area -  
STORAGE AREAS, FACILITY MAINTENANCE:

THE AUTHORIZED SIZE FOR THE FACILITY MAINTENANCE AREA IS 74.3 SM (800 SF).

IG10 Physical Readiness Area -  
SPECIAL TRAINING AREAS, PHYSICAL READINESS AREA:

ALLOWANCE IS BASED ON THE TOTAL AUTHORIZED DRILLING STRENGTH OF THE LARGEST DRILL WEEKEND.

$107 \text{ SOLDIERS}/10 = 10.7 \Rightarrow 11 \times 9.29 \text{ SM (100 SF)} = 102.2 \text{ SM (1100 SF)}$

A NEW PHYSICAL READINESS AREA NEAR THE NEW LOCKER ROOM SHOULD BE CONSTRUCTED. THE EXISTING PHYSICAL READINESS AREA CANNOT BE EXPANDED DUE TO BUILDING CONFIGURATION AND SHOULD BE REMODELED AS THE BREAK ROOM AFTER CONSTRUCTION OF THE ADDITION.

IG13 -  
Special Training Areas, Family Support:

References:

a. Memorandum, USARC, DAAR-EN, 14 September 2000, Subject: Interim Change, AR 140-483, Army Reserve Land and Facilities Management

A family support office of 200 square feet (18.58 square meters) is authorized for all centers for use of all units on their respective drill weekends, regardless of unit strength.

IG14 -  
Special Training Areas, Weapons Simulator Room:

## D Sample 5034-R Continued

Project Number : 10317  
Project Title : AR Center/OMS/AMSA/Unh Strg  
Date : Jun 30, 2005

### Functional Space Details - Actual/ English

#### 171 - Training Building

A weapons simulator room is authorized based on the Engagement Skills Trainer (EST) Main Simulation Unit (MSU) configuration issued to a facility. The EST 5-lane Trainer is authorized area of 113.8 square meters (1225 square feet).

IH1 Mens Toilets & Showers -

SUPPORT AREA, MEN'S TOILETS AND SHOWERS:

ALLOWANCE IS BASED ON 90% OF THE NUMBER OF PERSONNEL IN ATTENDANCE DURING THE LARGEST DRILL WEEKEND.

16 SOLDIERS X 90% = 15 MEMBERS

FIRST INCREMENT OF 100 = 32.5 SM (350 SF)  
TOTAL SPACE AUTHORIZED FOR MEN'S TOILETS AND SHOWERS = 32.5 SM (350 SF)

THE TOILET AND SHOWER WILL BE DESIGNED AND CONSTRUCTED HANDICAP ACCESSIBLE.

IH2 Womens Toilets & Showers -

SUPPORT AREA, WOMEN'S TOILETS AND SHOWERS:

ALLOWANCE IS BASED ON 30% OF THE NUMBER OF PERSONNEL IN ATTENDANCE DURING THE LARGEST DRILL WEEKEND.

16 SOLDIERS X 30% = 5 MEMBERS

FIRST INCREMENT OF 100 = 20.9 SM (225 SF)  
TOTAL AUTHORIZED FOR THE WOMEN'S TOILET AND SHOWERS = 20.9 SM (225 SF)

THE TOILET AND SHOWER WILL BE DESIGNED AND CONSTRUCTED HANDICAP ACCESSIBLE.

IH3 Locker Room -

SUPPORT AREA, LOCKER ROOM:

PROVIDE LOCKER ROOM FOR THE RESERVE UNITS. THE LOCKER ROOM SHOULD BE LOCATED ADJACENT TO THE LATRINE FACILITIES.

ALLOWANCE IS BASED ON THE TOTAL AUTHORIZED DRILLING STRENGTH OF THE LARGEST DRILL WEEKEND.

107 SOLDIERS/10 = 10.7=> 11 X 9.29 SM (100 SF) = 102.2 SM (1100 SF)

IH5 Break Area -

SUPPORT AREA, BREAK ROOM:

**D Sample 5034-R Continued**

Project Number : 10317  
Project Title : AR Center/OMS/AMSA/Unh Strg  
Date : Jun 30, 2005

**Functional Space Details - Actual/ English**

**171 - Training Building**

AUTHORIZED A 20.3 SM (218 SF) BREAK KITCHEN FOR THE FULL TIME STAFF

IH6 Electrical Space -  
SUPPORT AREA, ELECTRICAL:

AUTHORIZED SPACE IS NOMINAL. PROVIDE SPACE REQUIRED TO ACCOMMODATE NECESSARY EQUIPMENT.

IH7 Demarcation Telephone Space -  
SUPPORT AREA, TELEPHONE:

AUTHORIZED SPACE IS NOMINAL. PROVIDE SPACE REQUIRED TO ACCOMMODATE THE TELEPHONE EQUIPMENT. PROVIDE CLIMATE CONTROL (AC AND HEAT).

IH8 Mechanical Room -  
SUPPORT AREA, MECHANICAL:

ALLOWANCE IS 9% OF TOTAL APPROVED ALLOWANCES FOR A THROUGH H EXCLUDING H.(7).

AUTHORIZED SPACE IS NOMINAL. PROVIDE MECHANICAL ROOM SPACE AS REQUIRED BY THE EQUIPMENT USED TO HEAT AND COOL THE BUILDING ALONG WITH OTHER NEEDED OR REQUIRED EQUIPMENT.

**D Sample 5034-R Continued**

Project Number : 10317  
 Project Title : AR Center/OMS/AMSA/Unh Strg  
 Date: Jun 30, 2005

**Functional Space Details - Actual/ English**

**214 - Maintenance - Tank and Automotive**

	Authorized	Approved	Existing	Memo
V. 214 - Maintenance - Tank and Automotive				
A. Organizational Maintenance Shop (OMS)	746	866	0	
(1) Shop Office	120	120	0	X
(2) Tool & Parts Room	192	192	0	X
(3) Storage Room	192	192	0	X
(4) Flammable Storage	50	50	0	X
(5) Controlled Waste Storage	192	192	0	
(6) REF MANUAL STOR	0	120	0	X
(7)	0	0	0	
B. Area Maintenance Support (AMSA)	0	966	0	
(1) Shop Office	0	240	0	X
(2) Locker Room	0	100	0	X
(3) Class Room/Break Area	0	0	0	X
(4) Tool Room	0	192	0	X
(5) Parts Room	0	192	0	X
(6) Library	0	0	0	
(7) Battery Room	0	0	0	
(8) Commo/Electronics Shop	0	0	0	
(9) Instrument Repair	0	0	0	
(10) Small Arms Repair	0	0	0	
(11) Small Arms Vault	0	0	0	
(12) Flammable Storage	0	50	0	X
(13) Controlled Waste Storage	0	192	0	X
(14)	0	0	0	
(15)	0	0	0	
C. DS/GS Maintenance Shop Special Areas	0	0	0	
Maximum Authorized = 5,250 SF/488 m2				
(1)	0	0	0	
(2)	0	0	0	
(3)	0	0	0	
(4)	0	0	0	
(5)	0	0	0	
(6)	0	0	0	
D. Joint Maintenance Areas (OMS/AMSA)	2,423	3,001	0	
(1) Work Bays	2,240	2,240	0	X

**D Sample 5034-R Continued**

Project Number : 10317  
 Project Title : AR Center/OMS/AMSA/Unh Strg  
 Date: Jun 30, 2005

**Functional Space Details - Actual/ English**  
**214 - Maintenance - Tank and Automotive**

	Authorized	Approved	Existing	Memo
(2) Mechanical/Custodial	183	281	0	
(3) ARNET/IT Closet	0	0	0	
(4) Equipment Alcove	0	0	0	
(5) Mens Toilets & Showers	0	0	0	
(6) Womens Toilets & Showers	0	0	0	
(7) IT CLOSET	0	280	0	X
(8) Equipment Aclov	0	200	0	
Total Shop Net Area	3,169	4,833	0	
Circulation Allowance (15% of Net SF)	112	0	0	
Structural Allowance (10% of Net SF)	317	496	0	
Total Shop Gross Area	3,598	5,329	7,382	
Outgranted Area			0	
Total Shop Available Gross Area			7,382	

## D Sample 5034-R Continued

Project Number : 10317  
Project Title : AR Center/OMS/AMSA/Unh Strg  
Date : Jun 30, 2005

### Functional Space Details - Actual/ English

#### 214 - Maintenance - Tank and Automotive

VA1 Shop Office

OMS, SHOP OFFICE: LOCATE SHOP OFFICE TO PROVIDE MAXIMUM VISIBILITY OF WORK BAYS. ACCESS SHOULD BE PROVIDED FROM THE SHOP OFFICE INTO THE WORK BAYS AND EXTERIOR OF THE BUILDING.

5.6 SM (60 SF) PER AUTHORIZED OMS ADMINISTRATIVE PERSON WHO WORKS IN THE OMS ON THE LARGEST MAINTENANCE DRILL WEEKEND, PLUS 11.1 SM (120 SF) PER FULL-TIME OMS MAINTENANCE ADMINSTRATIVE PERSON.

1 FULLTIME X 11.1 SM (120 SF) = 11.1 SM (120 SF)

VA2 Tool & Parts Room

OMS, TOOL AND PARTS STORAGE: SUBDIVIDE AREA INTO 2 EQUAL SECTIONS WITH WIRE/EXPANDED METAL STORAGE CAGES 2.4-METER BY 3.7-METER (8 FT X 12 FT) WITH SLIDING DOORS FOR TOOL AND PARTS STORAGE. CAGES MUST EXTEND TO WITHIN ONE INCH OF THE FLOOR AND CEILING. THIS SPACE SHOULD BE ADJACENT TO THE STORAGE ROOM AND DIRECTLY ACCESSABLE TO THE WORKBAYS.

VA3 Storage Room

OMS, STORAGE ROOM: SUBDIVIDE AREA INTO 2 SECTIONS WITH WIRE/EXPANDED METAL STORAGE CAGES 2.4-METER BY 3.7-METER (8 FT X 12 FT) WITH SLIDING DOORS FOR STORAGE. CAGES MUST EXTEND TO WITHIN ONE INCH OF THE FLOOR AND CEILING. THIS SPACE SHOULD BE ADJACENT TO THE TOOL AND PARTS ROOM AND DIRECTLY ACCESSABLE TO THE WORKBAYS. AREA TO BE USED FOR STORAGE OF ANCILLARY EQUIPMENT ISSUED WITH VEHICLES. A MINIMUM OF TWO DUPLEX 110V OUTLETS SHALL BE PROVIDED PER MODULE.

VA4 Flammable Storage

OMS, FLAMMABLE STORAGE : MUST COMPLY WITH DESIGN GUIDE STANDARDS AND EPA STANDARDS AS OF DATE OF CONSTRUCTION. DOORS MUST OPEN TO THE OUTSIDE OF THE BUILDING.

VA6

REF MANUAL STORAGE/DISPATCH OFFICE:

DUE TO THE SIZE AND TYPE OF UNIT AND EQUIPMENT SERVICED OUT OF THIS OMS, A STORAGE AREA FOR REFERENCE MANUALS AND DISPATCH OFFICE IS DESIRABLE. THIS



## D Sample 5034-R Continued

Project Number : 10317  
Project Title : AR Center/OMS/AMSA/Unh Strg  
Date : Jun 30, 2005

### Functional Space Details - Actual/ English 214 - Maintenance - Tank and Automotive

AREA SHOULD BE INCORPORATED AS PART OF THE OMS SHOP OFFICE.

APPROVED SIZE = 11.1 SM (120 SF)

#### VB1 Shop Office

AMSA, SHOP OFFICE: LOCATE SHOP OFFICE TO PROVIDE MAXIMUM VISIBILITY OF WORK BAYS. ACCESS SHOULD BE PROVIDED FROM THE SHOP OFFICE INTO THE WORK BAYS AND EXTERIOR OF THE BUILDING.

A subshop of AMSA 95 is located in Conway. The subshop consists of two mechanics with administrative duties. Approve one 22.3 SM (240 SF) Shop Office.

#### VB2 Locker Room

AMSA LOCKER ROOM: 0.93 SM (10 SF) PER RECOGNIZED AMSA PERSON. LOCKER ROOM FOR FEMALE PERSONNEL WILL BE INCORPORATED INTO THE WOMEN'S TOILET. MINIMUM AREA WILL BE 9.3 SM (100 SF). Provide wall hung, full size, solid metal lockers, 15 inches wide by 18 inches deep by 72 inches high. Incorporate as part of the OMS Unisex toilet.

LOCKER ROOM AREA = 2 PERSONS X 0.93 SM (10 SF) = 1.86 SM (20 SF) => 9.3 SM (100 SF)

#### VB3 Class Room/Break Area

AMSA, CLASS ROOM/BREAK AREA: SHARE FACILITIES IN THE MAIN USARC.

#### VB4 Tool Room

AMSA, TOOL ROOM: Locate adjacent to the supply room with direct accessibility to the work bays. Divide the space into 2 separate caged areas with sliding cage doors.

WIRE/EXPANDED METAL STORAGE CAGES 2.4-METER BY 3.7-METER (8 FT X 12 FT) WITH SLIDING DOORS FOR TOOL AND PARTS STORAGE. CAGES MUST EXTEND TO WITHIN ONE INCH OF THE FLOOR AND CEILING.

2 Work Bays x 8.9 SM (96 SF) = 17.8 SM (192 SF).

## **D Sample 5034-R Continued**

Project Number : 10317  
Project Title : AR Center/OMS/AMSA/Unh Strg  
Date : Jun 30, 2005

### **Functional Space Details - Actual/ English** **214 - Maintenance - Tank and Automotive**

**VB5**                      **Parts Room**

AMSA, SUPPLY ROOM: Centrally locate to provide ease of access from the work bays. Provide metal shelving for storage of parts inside of caged areas in the supply room.

SUBDIVIDE AREA INTO 2 SECTIONS. WIRE/EXPANDED METAL STORAGE CAGES 2.4-METER BY 3.7-METER (8 FT X 12 FT) WITH SLIDING DOORS FOR STORAGE. CAGES MUST EXTEND TO WITHIN ONE INCH OF THE FLOOR AND CEILING. THIS SPACE SHOULD BE ADJACENT TO THE TOOL AND PARTS ROOM AND DIRECTLY ACCESSABLE TO THE WORKBAYS. A MINIMUM OF TWO DUPLEX 110V OUTLETS SHALL BE PROVIDED PER MODULE.

2 Work Bays x 8.9 SM (96 SF) = 17.8 SM (192 SF).

**VB12**                      **Flammable Storage**

AMSA, FLAMMABLE STORAGE : MUST COMPLY WITH DESIGN GUIDE STANDARDS AND EPA STANDARDS AS OF DATE OF CONSTRUCTION. DOORS MUST OPEN TO THE OUTSIDE OF THE BUILDING.

**VB13**                      **Controlled Waste Storage**

AMSA, CONTROLLED WASTE STORAGE: PROVIDE SEPERATE CONTROLLED WASTE STORAGE FOR THE AMSA.

**VD1**                      **Work Bays**

WORK BAYS: Provide one double drive-through work bays. Provide overhead cranes in the drive through bay.

(2 WORKBAYS x 74.3 SM (800 SF)) + 59.5 SM (640 SF) = 208.1 SM (2240 SF)  
Total Work Bay area = 208.1 SM (2240 SF)

**VD7**

References:

- a. Memorandum, HQ USARC, AFRC-CIS-I, 22 July 1999, Subject: Information Technology (IT) Requirements for Military Construction Army Reserve.

**D Sample 5034-R Continued**

Project Number : 10317  
Project Title : AR Center/OMS/AMSA/Unh Strg  
Date : Jun 30, 2005

**Functional Space Details - Actual/ English**

**214 - Maintenance - Tank and Automotive**

b. Memorandum, OCAR, DAAR-EN, 27 October 1999, Subject: Information Technology Requirements in Design and Construction.

IT services provided on-site will include:  
Voice Communications (Telephone)  
Logistics, and other, STAMIS Applications

Within the OMS, all IT support equipment will be rack-mounted in climate controlled facilities as IT Support Facilities. Recommended square footage for OMS Facilities are:

Network Operations Center (NOC)	14.9 SM (160 SF)
Electrical Closet	11.1 SM (120 SF)
TOTAL	26.0 SM (280 SF)

Design and construction should comply with Reference a.

**D Sample 5034-R Continued**

Project Number : 10317  
 Project Title : AR Center/OMS/AMSA/Unh Strg  
 Date: Jun 30, 2005

**Functional Space Details - Actual/ English**  
**UNH - Unheated Storage**

	Authorized	Approved	Existing	Memo
<hr/>				
VII. UNH - Unheated Storage				
Equipment Storage				
Unheated Storage				
(1) Unit/Individual Storage	442	442	0	X
(2) Staging Area	45	45	0	
Total Unheated Storage Net Area	487	487	0	
Circulation (15% of Net SF)	74	0	0	
Structural Allowance (10% of Net SF)	49	0	0	
Total Unheated Storage Gross Area	610	487	0	
Outgranted Area			0	
Total Unheated Storage Available Gross Area			0	

**D Sample 5034-R Continued**

Project Number : 10317  
Project Title : AR Center/OMS/AMSA/Unh Strg  
Date : Jun 30, 2005

**Functional Space Details - Actual/ English**

**UNH - Unheated Storage**

VII1 Unit/Individual Storage -

UNHEATED STORAGE, UNIT/INDIVIDUAL STORAGE:

SUBDIVIDE INTO 2.4-METER BY 3.7-METER (8-FOOT BY 12-FOOT) CAGES  
CONSTRUCTED OF WOVEN WELDED WIRE FABRIC. CAGING SHOULD BE  
INSTALLED FROM FLOOR TO THE ROOF DECK OR FLOOR SLAB ABOVE. AISLES  
AND VESTIBULES BETWEEN THE CAGED AREAS SHOULD BE KEPT TO A  
MINIMUM.

**D Sample 5034-R Continued**

Project Number : 10317  
 Project Title : AR Center/OMS/AMSA/Unh Strg  
 Date: Jun 30, 2005

**Functional Space Details - Actual/ English**  
**SPRT - Support Facilities**

	Authorized	Approved	Existing	Memo
X. Supporting Facilities				
A. Privately Owned Vehicle Parking (POV) (SY)	9,030	9,100	3,000	
B. Military Equipment Parking (MEP)	3,100	3,440	3,000	
(1) OMS (SY)	3,100	3,100	3,000	
(2) AMSA (SY)	0	340	0	
(3) ECS	0	0	0	
Number of Vehicles at the ECS	0	0	0	
ECS (SY)	0	0	0	
C. Wash Platforms (EA)	1	1	1	
D. MEP Fencing (LF)	672	672	0	
E. MEP Lighting (EA)	3	3	0	
F. Access Roads (SY)	903	910	0	
G. Sidewalks (SY)	0	0	0	
H. Service/Access Maintenance Shop Apron (SY)	0	0	0	
I. Fuel Storage and Dispensing (EA)	0	0	0	
J. Equipment Loading Ramp (EA)	0	0	0	
K. Marine Pier/Dock (EA)	0	0	0	
L. Flagpole (EA)	0	0	0	
M. Occupational Safety and Health Equipment (EA)	0	0	0	
(1)	0	0	0	
(2)	0	0	0	
N.	0	1	0	
O. MKT Concrete Pad (EA)	0	0	0	

**D Sample 5034-R Continued**

Project Number : 10317  
 Project Title : AR Center/OMS/AMSA/Unh Strg  
 Date: Jun 30, 2005

**Functional Space Details - Actual/ English**

**STAT - Statistics**

Description	Center	Shop	UNH Strg	WHS Strg
Total Square Footage For:				
Authorized Size	20,365	3,598	610	0
Approved Size	22,542	5,329	487	0
Existing Size for Alteration	22,604	7,382	0	0
Size of Addition	0	0	0	0
Size of New Building	0	0	487	0

Center Statistics	Total Personnel	Weekend
Rated Capacity	100	
Largest Drill Weekend	99	1
Largest Admin Weekend	28	1
Largest Maintenance Weekend	0	0
Weekends Per Month	1	



## APPENDIX E

### STANDARD KITCHEN PLAN AND EQUIPMENT LIST

#### E-1 Plan

**E-1.1** A standard Army Reserve kitchen plan is shown below. This plan and its associated equipment have been approved by the Using Service for inclusion in all Army Reserve training center projects with kitchens. Equipment changes are occasionally made which affect all future projects. See the Army Reserve FTP download site (link located on [www.lrl.usace.army.mil/ed2/default.asp?mycategory=212](http://www.lrl.usace.army.mil/ed2/default.asp?mycategory=212)) for Army Reserve kitchen updates.

**E-1.2** The designer is strongly advised to obtain a copy of the current standard kitchen drawings from the Army Reserve FTP download site, along with current equipment data sheets. Kitchen specifications are linked on the web page listed above.

**Figure E-1**  
**Kitchen Equipment Plan**

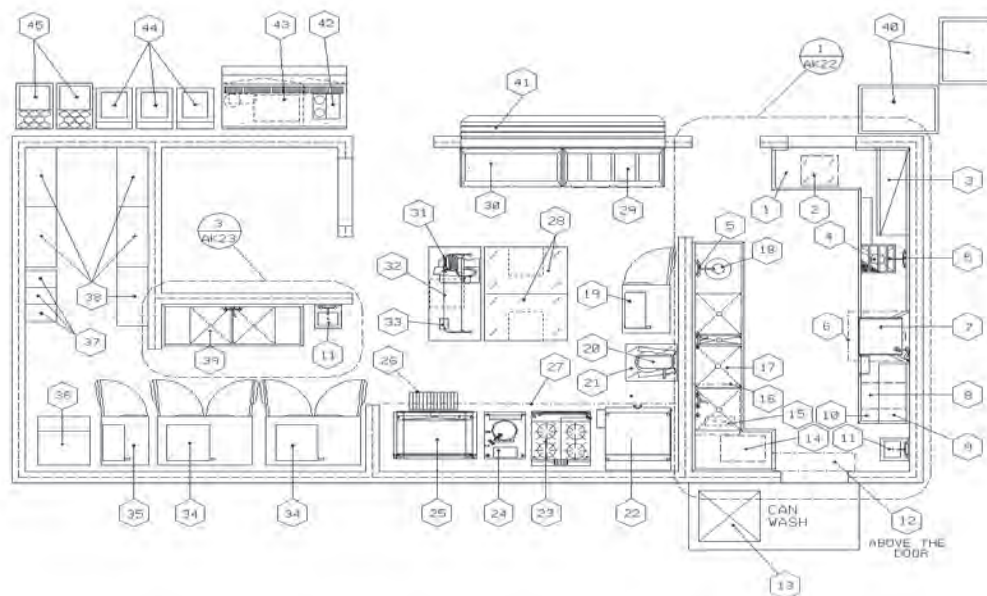

#### E-2 Equipment List

##### E-2.1 Equipment List

1. Soiled dish table
2. Silver soak sink
3. Overhead rack shelf
4. Garbage disposer
5. Pre-rinse spray assembly
6. Ventilation hood
7. Dishwasher

***E-2 Continued***

8. Booster heater
9. Overhead shelf
10. Clean dish table
11. Hand sink with soap/towel dispenser
12. Air curtain
13. Can wash
14. Booster heater
15. Sanitizing booster heater
16. Ventilation hood
17. Three-compartment sink
18. Disposer
19. Warming cabinet
20. Mixer
21. Mixer stand
22. Convection oven
23. Range with oven
24. Tilting kettle
25. Braising pan
26. Drain trough with grate
27. Hood over cooking area
28. Mobile worktables
29. Hot food well
30. Cold food well
31. Slicer
32. Food preparation table
33. Can opener
34. Refrigerator
35. Freezer
36. Ice machine
37. Mobile racks
38. Shelving
39. Vegetable sink
40. Tray busing rack
41. Stainless steel tray slide
42. Coffee maker
43. Drink stand with dolly
44. Cup and glass dispenser
45. Tray and silverware dispenser

## APPENDIX F

### TOILET ROOM FIXTURE COUNTS

#### F-1 Counts

**F-1.1** The minimum fixture count ~~12~~ for the Training Center Building ~~12~~ should be based on the tables below for the maximum drill weekend. ~~13~~ Fixtures required in Physical Exam Wing and General Officer Suites are in addition to the fixtures listed in this Appendix.~~13~~~~12~~ Minimum fixture counts for other buildings are based on their projected population.~~12~~ Review male/female personnel ratios with Tenants.

**F-1.2** As an alternative method of calculating fixtures, use 40% of the maximum drill weekend for female toilet fixtures, and 80% for males. Consider the male/female ratio within the Tenant units when determining ratio of male to female locker, toilet and shower space.

**F-1.3** ~~12~~ Space column listed in the two tables below is a suggested or targeted area, if this square foot figure is exceeded, designer must ensure space is below allowance as set forth in AR 140-483. ~~12~~

#### F-2 Fixture Count Tables ~~12~~

##### F-2.1 Female Toilet Room Fixture Counts

Peak Occupancy	Water Closets	Lavatories	Showers	Total Fixtures	Recommended/ Suggested Space
1 to 15	1	1	1	3	150 SF
16 to 30	2	2	2	6	285 SF
31 to 35	2	2	3	7	325 SF
36 to 45	3	3	3	9	380 SF
46 to 55	3	3	4	10	420 SF
56 to 60	4	3	4	11	450 SF
61 to 75	4	4	5	13	515 SF
76 to 80	4	4	6	14	555 SF
81 to 90	5	4	6	15	585 SF
91 to 105	5	5	7	17	650 SF
106 to 110	5	5	8	18	690 SF
111 to 120	6	5	8	19	690 SF
121 to 125	6	5	9	20	740 SF
126 to 135	6	6	9	21	740 SF
136 to 150	6	6	10	22	740 SF
151 to 165	7	6	11	24	840 SF
166 to 170	7	6	12	25	840 SF
171 to 180	7	7	12	26	840 SF
181 to 190	7	7	13	27	890 SF
191 to 195	8	7	13	28	940 SF
196 to 210	8	7	14	29	940 SF
211 to 215	8	7	15	30	990 SF
216 to 225	8	8	15	31	990 SF
226 to 230	8	8	16	32	990 SF

**Female Toilet Room Fixture Counts - continued**

Peak Occupancy	Water Closets	Lavatories	Showers	Total Fixtures	Recommended/ Suggested Space
231 to 240	9	8	16	33	1,040 SF
241 to 255	9	8	17	34	1,085 SF
256 to 260	9	8	18	35	1,085 SF
261 to 270	9	9	18	36	1,085 SF
271 to 285	10	9	19	38	1,185 SF
286 to 300	10	9	20	39	1,185 SF
301 to 305	10	9	21	40	1,235 SF
306 to 310	10	10	21	41	1,235 SF
311 to 315	11	10	21	42	1,285 SF
316 to 330	11	10	22	43	1,285 SF
331 to 345	11	10	23	44	1,335 SF
346 to 350	11	10	24	45	1,335 SF
351 to 360	12	11	24	47	1,385 SF
361 to 375	12	11	25	48	1,430 SF
376 to 390	12	11	26	49	1,430 SF
391 to 395	13	11	27	51	1,530 SF
396 to 405	13	12	27	52	1,530 SF
406 to 420	13	12	28	53	1,530 SF
421 to 430	13	12	29	54	1,580 SF
431 to 435	14	12	29	55	1,630 SF
436 to 440	14	12	30	56	1,630 SF
441 to 450	14	13	30	57	1,630 SF
451 to 465	14	13	31	58	1,680 SF
466 to 470	14	13	32	59	1,680 SF
471 to 480	15	13	32	60	1,730 SF

**F-2.2 Male Toilet Room Fixture Counts**

Peak Occupancy	Water Closets	Urinals	Lavatories	Showers	Total Fixtures	Recommended/ Suggested Space
1 to 35	2	1	2	3	8	335 SF
36 to 45	2	1	3	3	9	360 SF
46 to 55	2	1	3	4	10	400 SF
56 to 60	3	1	3	4	11	430 SF
61 to 75	3	1	4	5	13	495 SF
76 to 80	3	1	4	6	14	535 SF
81 to 90	3	2	4	6	15	560 SF
91 to 105	3	2	5	7	17	625 SF
106 to 110	3	2	5	8	18	665 SF
111 to 120	4	2	5	8	19	695 SF
121 to 125	4	2	5	9	20	735 SF
126 to 135	4	2	6	9	21	760 SF
136 to 150	4	2	6	10	22	800 SF
151 to 165	5	2	6	11	24	870 SF
166 to 170	5	2	6	12	25	910 SF
171 to 180	5	2	7	12	26	935 SF
181 to 190	5	2	7	13	27	975 SF
191 to 195	6	2	7	13	28	1,005 SF
196 to 210	6	2	7	14	29	1,045 SF
211 to 215	6	2	7	15	30	1,085 SF

**UFC 4-171-05**  
**1 January 2005**  
**Including Change 3, 1 February 2010**

**Male Toilet Room Fixture Counts - continued**

Peak Occupancy	Water Closets	Urinals	Lavatories	Showers	Total Fixtures	Recommended/ Suggested Space
216 to 225	6	2	8	15	31	1,110 SF
226 to 230	6	2	8	16	32	1,150 SF
231 to 240	6	3	8	16	33	1,150 SF
241 to 255	6	3	8	17	34	1,200 SF
256 to 260	6	3	8	18	35	1,200 SF
261 to 270	6	3	9	18	36	1,200 SF
271 to 285	7	3	9	19	38	1,300 SF
286 to 300	7	3	9	20	39	1,300 SF
301 to 305	7	3	9	21	40	1,350 SF
306 to 310	7	3	10	21	41	1,350 SF
311 to 315	8	3	10	21	42	1,400 SF
316 to 330	8	3	10	22	43	1,400 SF
331 to 345	8	3	10	23	44	1,450 SF
346 to 350	8	3	10	24	45	1,450 SF
351 to 360	8	4	11	24	47	1,490 SF
361 to 375	8	4	11	25	48	1,540 SF
376 to 390	8	4	11	26	49	1,540 SF
391 to 395	9	4	11	27	51	1,640 SF
396 to 405	9	4	12	27	52	1,640 SF
406 to 420	9	4	12	28	53	1,640 SF
421 to 430	9	4	12	29	54	1,690 SF
431 to 435	10	4	12	29	55	1,740 SF
436 to 440	10	4	12	30	56	1,740 SF
441 to 450	10	4	13	30	57	1,740 SF
451 to 465	10	4	13	31	58	1,790 SF
466 to 470	10	4	13	32	59	1,790 SF
471 to 480	10	5	13	32	60	1,830 SF
481 to 485	10	5	13	33	61	1,880 SF
486 to 495	10	5	14	33	62	1,880 SF
496 to 510	10	5	14	34	63	1,880 SF
511 to 525	11	5	14	35	65	1,960 SF
526 to 530	11	5	14	36	66	1,960 SF
531 to 540	11	5	15	36	67	1,960 SF
541 to 550	11	5	15	37	68	2,010 SF
551 to 555	12	5	15	37	69	2,040 SF
556 to 570	12	5	15	38	70	2,040 SF
571 to 575	12	5	15	39	71	2,090 SF
576 to 585	12	5	16	39	72	2,090 SF
586 to 590	12	5	16	40	73	2,090 SF
591 to 600	12	6	16	40	74	2,130 SF
601 to 615	12	6	16	41	75	2,180 SF
616 to 620	12	6	16	42	76	2,180 SF
621 to 630	12	6	17	42	77	2,180 SF
631 to 645	13	6	17	43	79	2,260 SF
646 to 660	13	6	17	44	80	2,260 SF
661 to 665	13	6	17	45	81	2,310 SF
666 to 670	13	6	18	45	82	2,310 SF
671 to 675	14	6	18	45	83	2,340 SF
676 to 690	14	6	18	46	84	2,340 SF
691 to 705	14	6	18	47	85	2,390 SF
706 to 710	14	6	18	48	86	2,390 SF

Male Toilet Room Fixture Counts - **continued**

Peak Occupancy	Water Closets	Urinals	Lavatories	Showers	Total Fixtures	Recommended/ Suggested Space
711 to 720	14	7	19	48	88	2,430 SF
721 to 735	14	7	19	49	89	2,480 SF
736 to 750	14	7	19	50	90	2,480 SF
751 to 755	15	7	19	51	92	2,560 SF
756 to 765	15	7	20	51	93	2,560 SF
766 to 780	15	7	20	52	94	2,560 SF
781 to 790	15	7	20	53	95	2,610 SF
791 to 795	16	7	20	53	96	2,640 SF
796 to 800	16	7	20	54	97	2,640 SF
801 to 810	16	7	21	54	98	2,640 SF
811 to 825	16	7	21	55	99	2,690 SF
826 to 830	16	7	21	56	100	2,690 SF
831 to 840	16	8	21	56	101	2,730 SF
841 to 845	16	8	21	57	102	2,780 SF
846 to 855	16	8	22	57	103	2,780 SF
856 to 870	16	8	22	58	104	2,780 SF
871 to 885	17	8	22	59	106	2,860 SF
886 to 890	17	8	22	60	107	2,860 SF
891 to 900	17	8	23	60	108	2,900 SF
901 to 910	17	8	23	61	109	2,950 SF
911 to 915	18	8	23	61	110	2,980 SF
916 to 930	18	8	23	62	111	2,980 SF
931 to 935	18	8	23	63	112	3,030 SF
936 to 945	18	8	24	63	113	3,030 SF
946 to 955	18	8	24	64	114	3,030 SF
956 to 960	18	9	24	64	115	3,070 SF

***/2/***

## APPENDIX G

### BAND ROOM

#### G-1 General

**G-1.1** Band rooms provide practice areas for a 41-member band and storage spaces for instruments, music, uniforms, and other equipment. The rooms may be adjacent to the assembly hall. This usually allows a best fit with the rest of the facility, because the band rooms have varying roof heights and some non-rectangular spaces. It also provides separation from administrative and education areas to minimize distraction to other building occupants.

**G-1.2** See Technical Instructions (TI) 800-01, Design Criteria, for discussion of architectural and engineering criteria unique to a band's training spaces. Acoustic design considerations are complex and can not be concisely duplicated here. Do not attempt to follow the space planning criteria given in the TI to size the facility. The Army Reserve has a different system than the active Army to generate project scope.

#### G-2 Space Authorizations

**G-2.1** Space authorizations for a band may appear under multiple categories in the Army Reserve's project documentation. This paragraph explains the standard authorizations. Verify the quantities given for a specific project.

**G-2.2** Administrative spaces total 270 sf (25 sm). There are two private, unit exclusive offices.

Commander's office	= 150 sf (14 sm)
Enlisted bandleader's office	= 120 sf (11 sm)

**G-2.3** Storage spaces total 1,004 sf (93 sm). Provide locker and storage rooms in lieu of the standard 8 ft x 12 ft (2400 m x 3600 m) cages normally located in the unit/individual storage area. The standard Army Reserve allowance is one cage per 6 members of a unit organized under a modification table of organization and equipment (MTOE) document, e.g., 7 cages for the band.

Storage: 7 cages x 8.9 sm/cage x 1.15 intrafunctional circulation	= 72 sm	(773 sf)
Staging: 72 sm x 0.1	= 7 sm	(77 sf)
Additional circulation factor (historic experience): 72 sm x 0.2	= <u>14 sm</u>	(155 sf)
Total storage allowance	= 93 sm	(1,004 sf)

Reconfigure this allowance into male and female locker rooms plus a storage room. Provide each band member with a full-height locker (2 ft x 3 ft) (600 mm x 900 mm) for uniforms. Adjust the sizes of the locker rooms as needed to accommodate the actual count of male and female members. Provide a storage room with shelves for unit



**G-1 Continued**

equipment and members' duffle bags.

**G-2.4** Special training spaces total 3,300 sf (307 sm)

Main rehearsal room	= 146 sm (1,575 sf)
Large group practice room	= 65 sm (700 sf)
Three individual practice rooms at 6.5 sm each	= 20 sm (210 sf)
Recording room	= 7 sm (80 sf)
Instrument repair/cleaning area	= 16 sm (175 sf)
Instrument storage area	= 37 sm (400 sf)
Library	= 15 sm (160 sf)

**G-2.5** Corridors within the band area count against the building's circulation allowance. /2/

**Figure G-1  
 Standard Band Room Plan**

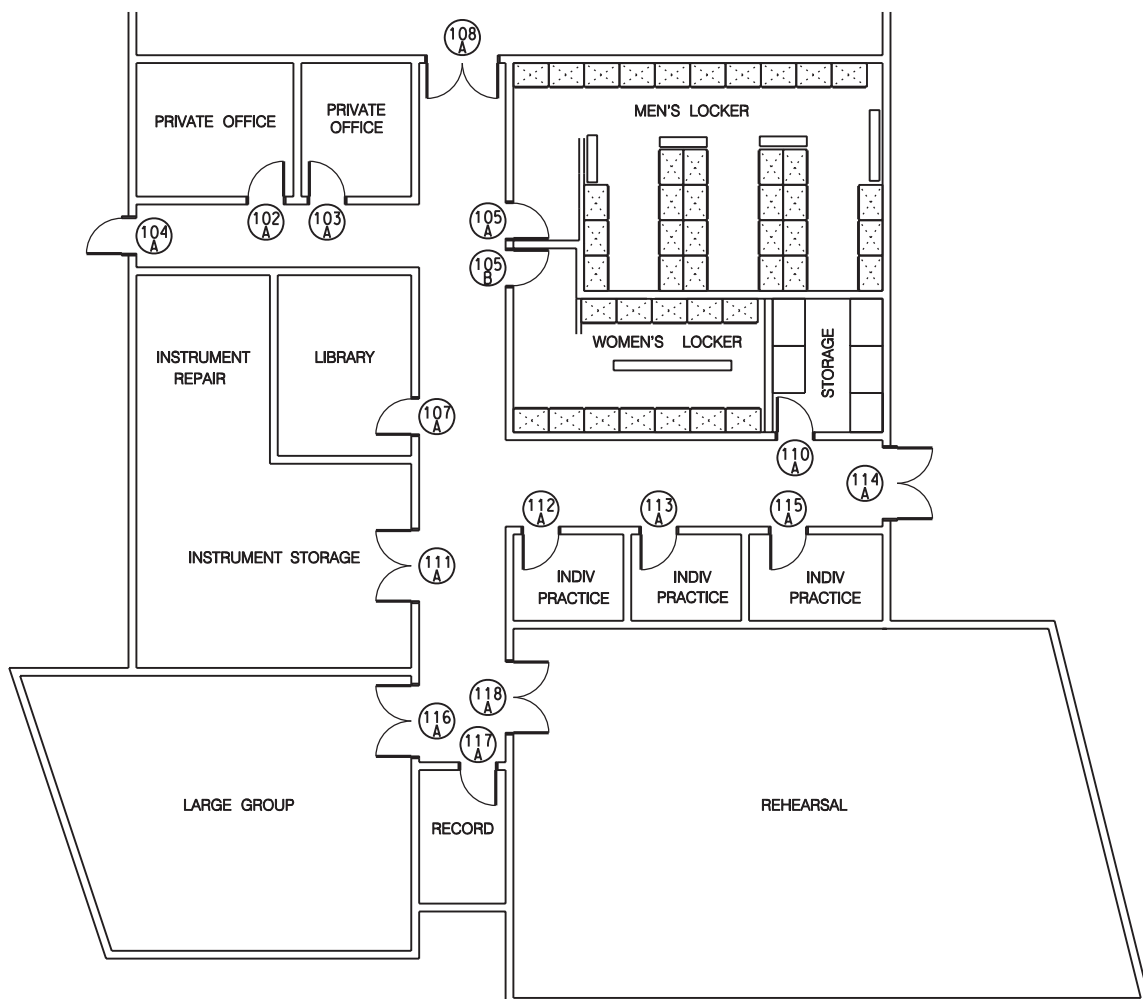

## APPENDIX H

### SECURE COMPARTMENTED INFORMATION FACILITIES (SCIF)

#### H-1 General

**H-1.1** A SCIF is an infrequent element of a Reserve Center. When authorized, this space is used for electronic intelligence training activities and operations.

**H-1.2** There is no standard design for a SCIF. The project documents will provide the SCIF space authorization; the designer will need to work with the Project Officer, RSC, SCIF Proponent, Army Reserve Installation and Tenants to determine what specific spaces and areas are required within that authorization. They will also help define the furnishings, equipment, and mechanical/electrical/communications systems for the SCIF.

**H-1.3** The governing criteria for SCIF design and construction is Director of Central Intelligence Directive (DCID) 6/9 "Physical Security Standards for Sensitive Compartmented Information Facilities." The manual defines several SCIF categories, and provides design and construction guidance for each. However, the designer must ask the SCIF Security Officer (SSO) for applicable guidance, particularly for communication security. At one time, there were two volumes on the subject from a Defense Intelligence Agency (DIA) Worldwide SCIF Security Officer (SSO) Conference, the SSO may be able to provide information from these volumes to aide in design.

**H-1.4** The SCIF is a secure facility; access to the SCIF must be controlled and monitored, and communications within, to and from the SCIF must be secure from threat of interception.

**H-2** Security Considerations - from previous Army Reserve SCIFs - accuracy and applicability must be verified:

**H-2.1** There will be security vestibule with CCTV monitoring, most likely with an electronic latch release. Entry into the SCIF will be controlled by the SSO or a designee. If necessary, a separate exit (or exits if two are required) can be provided to satisfy life safety/exiting requirements. The Army Reserve security personnel will want any such exits to include an audible alarm, and possibly a short delay, for security reasons. No hardware should be provided on the exterior side of such exit doors.

**H-2.2** There are STC rating requirements, door and wall construction requirements, and requirements affecting all mechanical, electrical, and voice data penetrations of the SCIF. Penetrations are to be minimized. No HVAC ductwork not serving the SCIF can run through its ceiling space. Secure telephone instruments and fax machines are required in the SCIF.

**H-2.3** Although windows are not absolutely forbidden by the DCID, the Tenants

***H-2 Continued***

typically do not want any windows. This might be an area for the core of the building, but remember that no exit path can run through (into and then out of) a SCIF.

**H-2.4** Design of the SCIF will include provisions for power, conduit and cable for IDS and other security systems; those security systems will be provided and installed by the Government.

**H-3** Space Design Information

**H-3.1** A typical SCIF might contain office/admin areas, a classroom, an open area with computer workstations, an electronics maintenance space, a server room, storage room, security vestibule, and electrical/telephone room.

**H-3.2** Some spaces that are part of the SCIF space authorization may not be within the secure area. Some administrative spaces and the maintenance space might be better located outside of the SCIF.

**H-3.3** If the SCIF proponent does not provide individual space design information, refer to similar spaces (administrative, classroom, telecommunications spaces, etc.) and model the design of the SCIF spaces on those.

**H-3.4** Include furniture and similar equipment as part of the design similar to the rest of the training center. Fax machines, safes, servers, secure files, encryption devices, secure telephones and similar items specific to the operation of the SCIF will be provided by the Tenants.

**H-3.5** The SCIF HVAC equipment must be separate from other building HVAC systems.

**H-3.6** Provide clean power if Tenants do not provide UPS system, and verify grounding required for SCIF. /3/

## APPENDIX I

### PHYSICAL EXAM WING

#### I-1 General

**I-1.1** When authorized, medical spaces will be provided for physical exams, treatment and professional medical training. The project documents will define the authorized space and may provide additional information for the designer.

**I-1.2** Locate the medical wing adjacent to dedicated office space that can be assigned to the medical unit. The medical wing will typically have its own entrance, as well as an interior access to the remainder of the building. It should be somewhat isolated from the rest of the building for reasons of patient privacy. Planning concepts should allow for privacy of patients when accessing dressing areas and toilets.

**I-1.3** The medical wing layout and capabilities may vary to suit the Tenants' training and operational requirements. The designer should work with the Tenants to develop a functional layout.

**I-1.4** The types of spaces that may be required are waiting rooms, dressing rooms, medical exam rooms, dental exam rooms, supply rooms, lavatories with male and female specimen toilet areas, laboratory, physical exam areas for blood pressure, EKG, X-ray, audio meter, eye exam, and height and weight measurement.

**Figure I-1**  
**Typical Medical Section Plan**



***I-1 Continued***

**I-1.5** Special purpose training areas such as operating rooms, scrub rooms, two bed wards, sterile supply rooms and pharmacy will be provided only when justified.

**I-2** Space Design Information

**I-2.1** Due to the variety of functional areas possible and variance in the medical equipment, the Using Service will provide a list of equipment and proposed locations for any special requirements when the concept design is completed.

**I-2.2** Refer to the space design information for office and administrative spaces in Chapter 4 as a guideline for systems, furniture, equipment, and finishes. Review recommended selections with Tenants, and obtain their input. Finishes should be those appropriate to a civilian medical clinic with attention to durability and maintainability.

**I-2.3** The necessary medical equipment, standard medical equipment sets including X-ray machines, will be provided and installed by the Tenants. An X-ray equipment installation certificate will be required. Other furniture and equipment is to be addressed as for the remainder of the training center.

**I-2.4** Built-in equipment may include the following:

**I-2.4.1** Waiting room: Admissions counter 15 in (400 mm) wide by 49 in (250 mm) high by 12 fr (3,650 mm) long. A portion should be accessible.

**I-2.4.2** Dressing room: Feed-in clothes hooks - four per dressing room. A seat may be built in on one side.

**I-2.4.3** Medical exam room: Wall hung lavatory, or sink in cabinetry.

**I-2.4.4** Dental exam room: Wall hung lavatory, or sink in cabinetry.

**I-2.4.5** Laboratory: Base cabinets 24 in (610 mm) deep by 36 in (915) high with chemical-resistant work counter and a two-compartment stainless steel sink. This unit will be located on one wall or as an island. The total length should not exceed 16 ft (4,900 mm).

**I-2.4.6** Specimen toilet: One water closet, one lavatory, one shelf, one towel dispenser and one pass-through door to the laboratory.

**I-2.4.7** Dark room: Work counter 24 in (610 mm) wide by 36 in (915 mm) high by 96 in (2,450 mm) long with chemical-resistant work surface. This may be located on a wall and/or an island.

**I-2.4.8** Audio/meter room: One booth 3 ft (915 mm) by 5 ft (1525 mm) with sound treatment to 55 STC and one counter on one end of the room, 18 in (460 mm) wide and 28 in (715 mm) above the floor. The Tenants may provide a portable booth in lieu of a

***I-2 Continued***

constructed room.

**I-2.4.9** Supply room: 12 in (300 mm) deep wood shelving, 5 shelves high, beginning 18 in (460 mm) from the floor, and epoxy-painted. This shelving may be installed on three walls. Shelving units may be used if cost justified. This room may also accommodate medical records in file cabinets.

**I-2.4.10** Provide divided surface metal raceways above lab counters with 20A, GFCI, duplex receptacles.

**I-2.4.11** Other built-in or installed equipment may be included on a case-by-case basis, provided such equipment is fully justified for the operational training needs.

## APPENDIX J

EQUIPMENT CONCENTRATION SITE  
(ECS)

## J-1 General

**J-1.1** An ECS is essentially a large MEP area for the storage of military vehicles and equipment to be used during annual and weekend training periods.

**Figure J-1**  
**Typical ECS Layout**

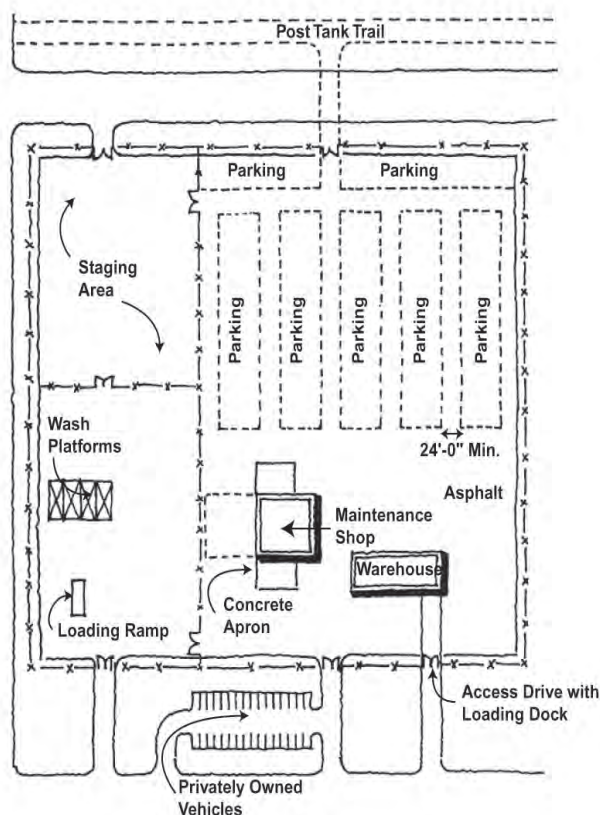

**J-1.2** With few exceptions, an ECS is located on an active or semi-active military installation and is collocated with an AMSA dedicated to maintaining the equipment stored at the ECS.

**J-1.3** Facilities associated with the ECS will be described in the project documents, and may include parking hardstand, fuel dispensing system, loading ramp, wash platform, indoor equipment storage warehouse, combat vehicle arms vault, fencing, security lighting and an AMSA.

## J-2 Design Information

**J-2.1** Factors which affect the layout and design of an ECS are much the same as those for the MEP at an OMS or AMSA, with the following exceptions.

**J-2.1.1** Access/Egress and Circulation: Tracked combat vehicles are stored at an ECS and require access to the nearest tank trail on the

military installation. In instances where asphalt paving or circulation areas are provided around a supporting AMSA, a concrete roadway or turning area may be required to provide access for combat vehicles to the AMSA shop bays. Due to the larger size and heavier concentration of vehicles, the ECS traffic is very heavy during annual training periods. Traffic patterns, therefore, should be carefully laid out to avoid severe internal circulation conflicts at the fuel pumps, dispatch and washracks. Circulation lanes within the ECS area should be a minimum of 24 ft (7.4 m) wide.

**J-2.1.2** Fuel Dispensing Point: When authorized, the fuel point should be located adjacent to a primary circulation area and in proximity to the main entrance and other support facilities. The lanes and pump bases for the diesel and gas pumps should be



***J-2 Continued***

concrete and should be drained so that all gas spills and water runoff are collected and emptied into a grease/oil separator. The separator should also serve the AMSA workbays and vehicle washrack whenever practicable. See Chapter 3 for additional environmental design guidance.

**J-2.1.3** Indoor Equipment Storage Warehouse: Since the primary function of this building is bulk storage of equipment, the structure must be noncombustible and as simple as possible. Pre-engineered metal buildings are acceptable. The interior layout should be open for flexibility and provide aisles large enough for material-handling equipment. Some areas should be designed for bulk and palletized storage. Depending on the type and the amount of equipment, a loading dock may be provided at one exit. A small portion of the building serves as a work area and should be have space conditioning similar to a supply office. An office for the warehouse man should also be provided. Information about the types and amount of equipment to be stored, and the types of material-handling equipment to be operated within the warehouse will be provided by the Using Service.

## APPENDIX K

### ROOF SYSTEMS FOR ARMY RESERVE PROJECTS

#### K-1 General Direction

**K-1.1** There are ~~two~~ four approved roofing systems for Army Reserve facilities: standing seam metal roofing systems (SSMRS), low-slope membrane roofing systems (EPDM and Mod-Bit), and fiberglass-based asphalt shingle roof systems. ~~Other~~ Other systems may be acceptable with Using Service approval. ~~The below~~ The below offers the primary guidance and first choice for roofing designs on Army Reserve projects. Additional guidance is located in UFC 3-110-03, Roofing. Designers should utilize UFC 3-110-03 for items not addressed below. ~~Use~~

#### K-2 Specific Guidelines

##### K-2.1 Standing Seam Metal Roof System (SSMRS)

**K-2.1.1** Use architectural rather than structural SSMRS

**K-2.1.2** ~~Use~~ Preferred slope should be 4 in 12. ~~Minimum~~ Minimum slope shall be 3 in 12. ~~If~~ If a 3:12 slope is utilized, then felt underlayment is required for the entire roof. ~~Use~~

**K-2.1.3** Require #30 felt underlayment for entire roof, and use ice and water shield in eaves, valleys, hips and ridges

**K-2.1.4** Require ice and water shield over entire roof where appropriate for the locality of the project

**K-2.1.5** Specify and show on the drawings a rigid underlayment.

**K-2.1.6** The clip screws should go down through the underlayment and insulation into the metal deck

**K-2.1.7** Require crimping machine to be calibrated daily

**K-2.1.8** Provide generic NRCA details to help define the quality of the roof.

**K-2.1.9** ~~Use~~ Reference Reserve Support Team Specification Sections 07 61 13.00 48 and 07 61 14.00 48 available at the USACE Louisville District Web-Site. ~~Use~~

**K-2.1.10** ~~Use~~ Ice/snow guards shall be utilized on SSMRS for locations where the average snowfall is more than 4" per year and may be considered in other locations. A Snow Retention system shall be utilized with mechanically fastened snow guards with continuous connectors. The attachment piece shall be a convex fastener. Ice/snow guards shall be either steel rods or extruded aluminum with matching coil stock inserted. No roof penetrations or adhesives shall be utilized. Ice/snow guards should be

## K-2 Continued

considered for the entire roof but shall be placed to protect equipment, sidewalks, doorways, and other critical areas. Ice/snow guards shall be designed to withstand ice and snow loads as defined in ASCE Manual 7. More stringent requirements based on manufactures recommendations or local building codes may apply. Ice/Snow guards shall be designed and installed to meet manufactures warranty. */3/*

### K-2.2 Modified Bitumen (Mod-Bit) Membrane System

K-2.2.1 Use a modified bitumen 2-ply system

K-2.2.2 Require a 20 year, no-dollar-limit warranty

K-2.2.3 Provide generic NRCA details to help define the quality of the roof.

K-2.2.4 *\3\* Low slope roofs on all new construction shall have a minimum slope of ½:12. */3/*

### K-2.3 Ethylene Propylene Diene Munomer (EPDM) Roof Membrane

K-2.3.1 Specify a minimum 60-mil thickness

K-2.3.2 Must be fully adhered, rather than ballasted or mechanically attached

K-2.3.3 Do not use over kitchens

K-2.3.4 Should include a coating to save energy

K-2.3.5 Require Factory Mutual certification for the system

K-2.3.6 Provide generic NRCA details to help define the quality of the roof.

K-2.3.4 *\3\* Low slope roofs on all new construction shall have a minimum slope of ½:12. */3/*

### K-2.4 *\2\* Fiberglass-Based Asphalt Shingle Roof System (System Added Fall 2004)

K-2.4.1 Asphalt shingle roofing system shall include shingles, underlayments, and flashing.

K-2.4.2 Shingle roofing system to provide ventilation of roof to prevent heat build-up and associated heat damage.

K-2.4.3 Coordinate shingle color and style with architectural design and exterior finishes.

## K-2 Continued

**K-2.4.4** Minimum slope for shingles shall be 4 in 12 or manufacturer's recommendation to meet 50 year warranty.

**K-2.4.5** Provide continuous top ridge vent connected to roof ventilation system. Also provide non-maintenance vents at the base of the roof system to support the air movement convection process.

**K-2.4.6** Provide asphalt shingle manufacturer's standard 50 year warranty for the asphalt shingles (including 110 mph wind up-lift). Provide all accessories and systems to meet the 50 year warranty criteria. Contractor shall warrant for 5 years that the asphalt shingle roofing system, as installed, is free from defects in workmanship.

**K-2.4.7** Provide cross-vented insulation over a vapor retarder in accordance with the manufacturer's instructions. */2/*

**K-2.4.8** ~~Ice~~ Ice and snow guards should be considered in northern climates. */3/*

## K-2.5 Requirements for all systems

**K-2.5.1** Contractor qualifications: five years minimum in the roofing business, and must be a member of professional roofing association (SMACNA and/or NRCA) for a minimum of 3 years

**K-2.5.2** Required pre-installation activities

**K-2.5.2.1** Must have a pre-roofing-construction meeting with the designer, supplier, manufacturer and contractor after award of the construction contract

**K-2.5.2.2** Must have a pre-installation meeting 2 weeks before starting installation

**K-2.5.3** Required quality control measures

**K-2.5.3.1** Manufacturer's representative must be on site during installation (all week the first week, at least once a week after that, minimum based on A/E's recommendation)

**K-2.5.3.2** Manufacturer's representative must be an employee of the manufacturer with a minimum of 5 years experience with the type of system being installed or an employee of an independent installer certified by the manufacturer

**K-2.5.3.3** Submittals will be for Government approval, and must be reviewed by the designer of record

**K-2.5.3.4** Manufacturer and Installer must provide a written statement that they have reviewed the plans and specifications, and will provide a 20 year ~~20~~ (50 year for fiberglass-based asphalt shingle)*/2/* premium warranty based on the design. (See below.)

**K-2 Continued**

**K-2.5.3.5** \3\ The contractor is required to provide Registered Roof Observer services during all roof construction activities. Registered Roof Observers (RRO) will perform daily oversight and quality control on all roof work to assure compliance with the projects plans and specifications. **/3/**

K-2 Continued

**INSTALLER'S STATEMENT ON ROOF WARRANTY**

I \_\_\_\_\_, THE ROOF INSTALLER FOR THIS PROJECT, HEREBY CERTIFY THAT THE PLANS AND SPECIFICATIONS HAVE BEEN THOROUGHLY REVIEWED AND THAT THE PROPOSED ROOF WILL MEET THE DESIGN INTENT AND MANUFACTURER'S REQUIREMENTS FOR A PREMIUM WEATHERTIGHTNESS WARRANTY.

\_\_\_\_\_  
INSTALLER'S NAME

\_\_\_\_\_  
PROJECT

\_\_\_\_\_  
DATE

**MANUFACTURER'S TECHNICAL REPRESENTATIVE**

I \_\_\_\_\_, A TECHNICAL REPRESENTATIVE EMPLOYED FOR A MINIMUM OF FIVE YEARS BY \_\_\_\_\_, THE ROOFING MANUFACTURER FOR THIS PROJECT, HEREBY ATTEST THAT THE ROOF INSTALLED FOR THIS PROJECT BY \_\_\_\_\_ WAS CONSTRUCTED AND ASSEMBLED IN ACCORDANCE WITH THE MANUFACTURER'S APPROVED METHODS AND DETAILS AND MEETS THE MANUFACTURER'S PREMIUM 20 YEAR (50 YEAR FOR FIBERGLASS-BASED ASPHALT SHINGLE) WEATHERTIGHTNESS WARRANTY REQUIREMENTS.

\_\_\_\_\_  
INSTALLER

\_\_\_\_\_  
PROJECT

\_\_\_\_\_  
DATE

APPEN-

DIX L

**U.S. ARMY RESERVE  
PHYSICAL READINESS ROOM  
EQUIPMENT MATRIX**

Nominal Area (sq. ft.)	Nominal Size IP (English)	Nominal Area (sq. m.)	Nominal Size Metric	Number of Pieces of Equipment													
				Elliptical Cross Trainer	Treadmill	Stair Climber	Recumbent Bike	Incline Bench	Flat Bench	Dumbbells	Dumbbell Rack	Five Station Multi-Gym	Seven Station Multi-Gym	Mirror	Barres	Fitness Mats	Free Weight Half Cage*
1600	32ft x 50ft	148.64	9.75m x 15.25m	3	4	1	2	3	3	3	3	1	1	10	8	12	1
1500		139.35		2	4	1	2	2	3	3	3	1	1	7	10	10	1
1400		130.06		2	3	1	2	2	2	2	2	1	1	8	10	10	1
1300		120.77		2	3	1	2	2	2	2	2	1	1	8	8	8	1
1200		111.48		2	2	1	1	3	3	3	3	0	1	6	4	10	1
1100		102.19		2	2	1	1	2	2	2	2	0	1	10	12	8	1
1000	32ft x 31ft	92.90	9.75m x 9.5m	2	2	1	1	2	2	2	2	0	1	4	10	7	1
900		83.61		2	2	1	1	1	1	1	1	0	1	4	8	7	1
800		74.32		2	2	1	1	1	1	1	1	1	0	4	6	4	1
700		65.03		2	2	1	1	2	2	1	1	1	0	6	6	8	1
600	32ft x 19ft	55.74	9.75m x 6.25m	2	2	1	1	1	1	1	1	1	0	4	4	4	1
500		46.45		1	1	0	1	1	1	1	1	1	0	8	8	4	0
400		37.16		1	1	0	1	1	1	1	1	1	0	4	8	4	0
300		27.87		1	1	0	0	1	1	1	1	0	0	4	6	4	0
200		18.58		1	1	0	0	1	1	1	1	0	0	3	4	2	0

\* Free Weight Half-Cage should have safety catches to allow for safe lifting without a spotter



## APPENDIX M

### SAMPLE PROJECTS AND PHOTOGRAPHY CREDITS

#### **M-1** Sample Projects

**M-1.1** The following pages provide illustrations of Army Reserve projects as examples for project designers

#### **M-2** Photography Credits

**M-2.1** The project photographs in this Appendix and throughout the Design Guide are provided with the permission of the photographers or owners of the photographs:

USARC/OMS/AMSA/WHS, Arden Hills, MN - RSP Architects

USARC, Fort Dodge, IA - Philip Prowse Photography, Minneapolis, MN

Battle Projection Center, Arlington Heights, IL - Staff of RSP Architects

ARRTC VOQ/Dormitory, Fort McCoy, WI - Staff of RSP Architects

USARC/OMS/WHS, Sacramento, CA - George Heinrich Photography, Minneapolis, MN

USARC, Parks RFTA, Dublin, CA - George Heinrich Photography, Minneapolis, MN

USARC, Toledo, OH - Gossen Livingston Associates, Inc.

USARC, Fort Des Moines, IA - Gossen Livingston Associates, Inc.

USARC/AMSA, Pittsburgh, PA -Blackman & Bell, Pittsburgh, PA

USARC/OMS/AMSA, Fort Belvoir, VA - Staff of Louisville District Corps of Engineers

USARC, Fort Knox, KY - Staff of Louisville District Corps of Engineers

**M2.2** The rendered drawings are provided with the permission of the project designers.

**ADD/ALT AFRC/OMS/STORAGE; ORLANDO, FLORIDA**



- Armed Forces Reserve Center (new) - 121,000 sf
- Remodel Existing USARC - 22,000 sf
- OMS (new) - 8,600 sf
- Add Mezz to Existing Storage - 16,000 sf
- 40 Acres
- Design completion - June 2001
- Construction completion - Winter 2003

RSP ARCHITECTS

USARC/OMS/DS-GS/WHS; ARDEN HILLS MINNESOTA



- USARC - 53,000 sf
- OMS/DS-GS - 31,000 sf
- Warehouse - 58,000 sf
- 29 Acres
- Design completion - June 1989
- Construction completion - September 1991

RSP ARCHITECTS



USARC; FORT DODGE, IOWA



- USARC - 11,500 sf
- 4 Acres
- Design completion - May 1996
- Construction completion - October 1997

RSP ARCHITECTS

**BERRY ROSENBLATT USARC/OMS; WEST HARTFORD, CONNECTICUT**



THE MASON & HANGER GROUP, INC.



**USAR BATTLE PROJECTION CENTER; ARLINGTON HEIGHTS, ILLINOIS**



- BPC - 28,000 sf
- 6 Acres
- Design completion - 1996
- Construction completion - 1998

RSP ARCHITECTS

USARC/OMS/AMSA; FT. BELVOIR, VIRGINIA

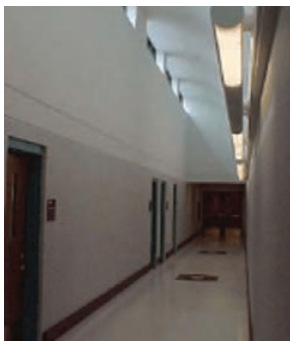

- USARC - 47,000 sf
- 13 Acres
- Design completion - January 1999
- Construction completion - September 2001

STAR TEAM - Corps of Engineers, Louisville District



USARC/AMSA; PITTSBURGH, PENNSYLVANIA



- USARC - 136,300 sf
- OMS/AMSA - 15,740 sf
- Unheated Storage - 2,540 sf
- 35 Acres
- Design completion - January 2000
- Construction completion - September 2001

Final Design - GOSSEN LIVINGSTON ASSOCIATES, INC.  
Concept Design - RSP ARCHITECTS

USARC; DES MOINES, IOWA



- USARC - 53,400 sf
- DEPMEDS Storage - 15,500 sf
- 20 Acres
- Design completion - September 1992
- Construction completion - October 1994

GOSSEN LIVINGSTON ASSOCIATES, INC.

UFC 4-171-05

1 January 2005

Including Change 3, 1 February 2010

USARC/OMS; TOLEDO, OHIO



- USARC - 43,000 sf
- OMS/AMSA - 31,100 sf
- 23.5 Acres
- Design completion - July 1994
- Construction completion - August 1996

GOSSEN LIVINGSTON ASSOCIATES, INC.



USARC/OMS/UHS; LINCOLN NEBRASKA



- USARC - 46,300 sf
- OMS - 6,200 sf
- UHS - 2,300 sf
- 10 Acres
- Design completion - August 2002
- Construction completion - September 2004

RSP ARCHITECTS

USARC/DCMC; ARLINGTON HEIGHTS, ILLINOIS



- USARC/DCMC - 96,300 sf
- 8 Acres
- Design completion - November 2000
- Construction completion - October 2002

RSP ARCHITECTS

USARC/OMS/WHS; SACRAMENTO, CALIFORNIA



- USARC - 64,200 sf (2 buildings)
- OMS - 11,600 sf
- WHS - 42,115 sf
- 36 Acres
- Design completion - 1997
- Construction completion - November 1999

RSP ARCHITECTS



USARC; PARKS RFTA, DUBLIN, CALIFORNIA



- USARC - 56,000 sf
- 8 Acres
- Design completion - 1998
- Construction completion - March 2000

RSP ARCHITECTS

USARC/OMS/WHS; SALT LAKE CITY, UTAH



- USARC - 31,400 sf
- OMS - 6,640 sf
- WHS - 7,500 sf
- 10 Acres
- Design completion - 1998
- Construction completion - September 2000

RSP ARCHITECTS

USARC/OMS/ECS; FORT POLK, LOUISIANA



- USARC - 12,325 sf
- OMS - 11,700 sf
- AMSA - 15,500 sf
- ECS WHS - 53,225 sf
- 50 Acres
- Design completion - December 2000
- Construction completion - November 2002

RSP ARCHITECTS



AFRC/OMS/AMSA/UHS; GREENVILLE, NORTH CAROLINA



- AFRC - 78,000 sf
- OMS/AMSA - 14,200 sf
- UHS - 2,000 sf
- 25 Acres
- Design completion - July 2001
- Construction completion - November 2002

RSP ARCHITECTS

ARRTC VOQ/DORMITORY; FORT McCOY, WISCONSIN



- VOQ/Dormitory - 105,000 sf
- 10 Acres
- Design completion - 1998
- Construction completion - December 2000\

RSP ARCHITECTS

USARC/OMS/STORAGE; MESA, ARIZONA



- USARC - 48,530 sf
- OMS - 5,535 sf
- Storage - 16,300 sf
- 10 Acres
- Design completion - May 2002
- Construction completion - June 2004

RSP ARCHITECTS