

## EXPLOSIVE CHARGES SAFETY TESTS

Zhang Yinliang, Zhang Jikang, Mi Litian, Lin Ying

(Xian Modern Chemistry Research Institute)

P. O. Box 18, Xian 710061, China

### ABSTRACT

This paper describes several simulating tests of explosive charges subjected to some environmental stimulations. The simulating tests are designed according to environmental conditions in the battlefield. It is well known that oil-wood fire cook-off, bullet and fragment impact, shock wave sympathetic detonation and shaped charge jet penetration is the most dangerous stimuli to munitions. Therefore, the informations obtained by means of simulating tests may be used to assess and compare the vulnerability of various candidate explosives for munitions. In this paper we reported the experimental pictures and results of three explosives: TNT, Comp. B and TATB.

### 1. INTRADUCTION

As we knew, the Desert Storm (Gulf War) was a modern war. The fire was very violent, the environmental conditions were very harsh. Under the harsh terms of modern war the main charge explosives in the bomb and warhead could undergo some dangerous stimuli, such as oil-wood fire cook-off, bullet and hot fragment impact, shock wave sympathetic detonation and shaped charge jet penetration. These environmental stimuli are serious threat to survivability of munitions in the battlefield. If the main explosive charges were poor vulnerability they would produce violent reactions: deflagration or detonation, and would make an accidental explosion. In order to prevent from the accidental explosion it is

# Report Documentation Page

*Form Approved  
OMB No. 0704-0188*

Public reporting burden for the collection of information is estimated to average 1 hour per response, including the time for reviewing instructions, searching existing data sources, gathering and maintaining the data needed, and completing and reviewing the collection of information. Send comments regarding this burden estimate or any other aspect of this collection of information, including suggestions for reducing this burden, to Washington Headquarters Services, Directorate for Information Operations and Reports, 1215 Jefferson Davis Highway, Suite 1204, Arlington VA 22202-4302. Respondents should be aware that notwithstanding any other provision of law, no person shall be subject to a penalty for failing to comply with a collection of information if it does not display a currently valid OMB control number.

1. REPORT DATE <b>AUG 1992</b>	2. REPORT TYPE	3. DATES COVERED <b>00-00-1992 to 00-00-1992</b>			
4. TITLE AND SUBTITLE <b>Explosive Charges Safety Tests</b>		5a. CONTRACT NUMBER			
		5b. GRANT NUMBER			
		5c. PROGRAM ELEMENT NUMBER			
6. AUTHOR(S)		5d. PROJECT NUMBER			
		5e. TASK NUMBER			
		5f. WORK UNIT NUMBER			
7. PERFORMING ORGANIZATION NAME(S) AND ADDRESS(ES) <b>Xian Modern Chemistry Research Institute,P.O.Box 18,Xian 710061, China,</b>		8. PERFORMING ORGANIZATION REPORT NUMBER			
9. SPONSORING/MONITORING AGENCY NAME(S) AND ADDRESS(ES)		10. SPONSOR/MONITOR'S ACRONYM(S)			
		11. SPONSOR/MONITOR'S REPORT NUMBER(S)			
12. DISTRIBUTION/AVAILABILITY STATEMENT <b>Approved for public release; distribution unlimited</b>					
13. SUPPLEMENTARY NOTES <b>See also ADA260986, Volume III. Minutes of the Twenty-Fifth Explosives Safety Seminar Held in Anaheim, CA on 18-20 August 1992.</b>					
14. ABSTRACT <b>see report</b>					
15. SUBJECT TERMS					
16. SECURITY CLASSIFICATION OF:			17. LIMITATION OF ABSTRACT	18. NUMBER OF PAGES	19a. NAME OF RESPONSIBLE PERSON
a. REPORT <b>unclassified</b>	b. ABSTRACT <b>unclassified</b>	c. THIS PAGE <b>unclassified</b>	<b>Same as Report (SAR)</b>	<b>14</b>	

necessary that the vulnerability( 1-4) of candidate main explosive is tested under simulating practice conditions. Thus we designed four kinds of simulating test according to the harsh terms in the battlefield. That is oil-wood fire fast cook-off test, 7.62mm caliber bullet impact test, shock wave sympathetic detonation test and shaped charge jet penetration test. The testing results may be used to assess and compare the vulnerability of various candidate explosives, and to select the low vulnerability explosives as the munitions of modern ordances.

## 2. SIMULATING TESTS

### (1) Fire Fast Cook-off Test

This test is designed to simulate the stimulus of the oil-wood fire to munitions in the battlefield. The test set-up (5-7) is shown in Figure 1(a). Its fire flame source consisted of a certain size and quantity of lumbers which drenched with kerosene. Its flame temperature-time history was measured by means of thermocouple (Figure 1(b)). Duration of flame was about 8 min. The candidate explosive charges were loaded in a metal case (Figure 2) which was made of 45# steel tube and sealed at both ends by threaded caps. During testing the interval (i. e. cook-off time) from ignition of fire flame source to explosion (or detonation) of candidate explosive was measured by timer. After test the metal case or its fragments were recovered. Its fracture scenario was an evidence to assess cook-off reaction and vulnerability of the candidate explosive.

### (2) Bullet Impact Test

This test is designed to simulate the stimulus of bullets or hot fragments to munition in the battlefield. The test set-up(2, 4, 6) is shown in Figure 3. The candidate explosive charges were loaded in the

metal case (Figure 2). Bullet caliber was 7.62mm, it was fired by an automatic rifle at distance 30m. Bullet velocity was 741m/s. During testing the candidate explosive charges may produce the phenomena: smoke, ignition, combustion, deflagration or detonation. After test the metal case or its fragments were recovered. Its fracture scenario was an evidence to assess reaction and vulnerability of the candidate explosive.

### (3) Shock Wave Sympathetic Detonation Test

The Large Scale Gap Test (7, 8) is used to simulate the shock wave stimulus to munition in the battlefield. The test set-up is shown in Figure 4. The donor was RDX/W (95/5) explosive, pressed in a cylinder  $\Phi 40 \times 30$ mm, density  $1.675 \pm 0.005$  g/cm<sup>3</sup>. Attenuator (or barrier) material was Ly-12 model of aluminium alloy, its diameter 40mm, several thicknesses. The candidate explosive (i. e. receptor) was pressed or cast in cylinder  $\Phi 40 \times 90$ mm. Witness plate (80mm diameter  $\times$  30mm thick) was steel A<sub>3</sub>. The criterion for receptor to produce detonation (GO) is punching a clear dent in the steel witness plate. The critical thickness of barrier (the 50 percent point for sample detonation) was determined by means of Optimum seeking Method (0.618) to change the thickness of barrier. This critical thickness is a standard for assessing the relative shock wave sensitivity of candidate explosive.

### (4) Shaped Charge Jet Penetration Test

This test is designed to simulate the metal jet stimulus to munition in the battlefield. The test assembly is shown in Figure 5. The shaped charge was RDX/W (95/5) explosive, pressed in a cylinder  $\Phi 40 \times 66$ mm, density  $1.680 \pm 0.005$ g/cm<sup>3</sup>, copper liner with apex angle 60° and wall thickness 0.75mm. Its metal jet could penetrate  $150 \pm 6$ mm of steel 45# at the stand-off 72mm. The candidate explosive (receptor) was pressed

or cast in a cylinder 40mm diameter×90mm long. The criterion for sample detonation is punching a clear dent in the steel witness plate. The critical thickness of steel barrier (the 50 percent point for sample detonation) was determined by Optimum Seeking Method (0.818) to change the thickness of steel barrier. This critical thickness is a standard for assessing the relative metal jet sensitivity of candidate explosive.

Otherwise, the jet sensitivity of candidate explosive may be also expressed by quantity  $V_j^2 d$ . Where,  $V_j$ , the jet velocity penetrated xmm steel plate after, d the jet diameter corresponded to  $V_j$ . After penetrating various thicknesses of steel plate the velocity  $V_j$ , and its diameter d of the metal jet were measured by a 2MV flash X-ray system. The results are listed in Table 6. According to these data we obtained the following fit formulas:

$$V_j = 33.6X^{-0.401} \quad (1)$$

$$d = 2.36 - 0.01X \quad (2)$$

Where  $X \in [30, 110]$ mm

Therefore, if X is given  $V_j$ , and d may be calculated with above fit formulas (1) and (2), respectively.

### 3. RESULTS AND DISCUSSION

We have already done above four simulating tests to three explosives: TNT, Comp. B and TATB. Their results are listed in Tables 1, 2, 3 and 4, respectively.

The results listed in Table 1 and Figure 6 indicated that TATB is very insensitive to fire fast cook-off stimulus, only combustion and no deflagration and detonation, its metal case was only ruptured in the lids. Comp. B is very sensitive to this stimulus, produced the violent reaction (detonation), its metal case was fractured at all. Although TNT could resist the long cook-off time (360S) and the high temperatures

(620°C) it produced deflagration and its metal case was ruptured wholly. Therefore, their insensitivity to cook-off stimulus is ranked as follows:

TATB > TNT > Comp. B

The results listed in Table 2 and Figure 7 indicated that, underg-one the bullet impact stimulus, TATB was no reaction, its metal case was not ruptured. Comp. B burned partly and a lid of its metal case was ruptured. TNT burned out and the lids of its metal case were ruptured at all. Therefore, their insensitivity to bullet impact stimulus is ranked as follows:

TATB > Comp. B > TNT

The data of shock wave and jet sensitivities for three explosives tested are listed in Tables 3 and 4, respectively. It is well known that increasing the thickness of barrier decreases the intensity of shock wave and metal jet to enter the receptor explosive. Thus the more the thickness, the more the sensitivity. Analysed the critical thickness data (i. e. the 50% probability point for receptor detonation), their both insensitivities to stimuli of shock wave and metal jet for three explosives tested are ranked as follows:

Insensitivity to shock wave stimulus

TATB > Comp. B > TNT

G50. 28. 0mm 41. 0mm 42. 5mm

Insensitivity to metal jet stimulus

TATB > Comp. B > TNT

X50. 47. 5mm 88. 3mm 97. 2mm

The jet sensitivity of explosives is also expressed by quantity V<sub>3</sub>d.

Because  $V_j^2 d$  is of the nature of force-power, the more the quantity, the more the insensitivity. So the rank for three explosives tested is the same as above one:

	TATB	>	Comp. B	>	TNT
$V_j^2 d$	47.5		20.5		18.1

All in all, above ranks indicated that the jet sensitivity for explosive covered by steel plate corresponds to its shock wave sensitivity. This result supports the jet penetration bow wave shock initiation mechanism for covered explosives (9, 10).

#### 4. CONCLUSIONS

(1) The testing results showed that the four simulating tests, i. e. oil-wood fire fast cook-off test, 7.62mm caliber bullet impact test, shock wave sympathetic detonation test (Large Scale Gap Test) and shaped charge jet penetration test, are virtual for comparing and assessing the low vulnerability of candidate explosives. The results are applicable to explosive hazard and vulnerability analysis and modern weapon munition design.

(2) The results of this paper demonstrated that TATB is very insensitive to fire fast cook-off, bullet impact, shock wave sympathetic detonation and metal jet penetration stimuli. Thus it is a type low vulnerability explosive and may be used as a standard of comparison. To fast cook-off stimulus TNT deflagrated, Comp. B detonated. To bullet, shock wave and metal jet stimuli, TNT is all more sensitive than comp. B.

#### 5. ACKNOWLEDGEMENTS

The authors wish to thank Engineers Hou Shixuan and Tang Bin for

helpful assistance in the experiments to measure the jet velocity and its diameter by flask x-ray system.

## 6. REFERENCES

- (1) M. J. Stosz, Development of New Explosives for the U. S. Navy, ICT, International Jahrestanng, 1982
- (2) AD-A148685 Ammunition and Explosives Safety Standards, DOD 6065.9-STD, 1984
- (3) Recommendations on the Transport of Dangerous Goods, Tests and criteria, First edition, United Nations, New York, 1986
- (4) Zhang Yinliang, Explosive Vulnerability and Its Evaluation, Propellants and Explosives, No. 3, 1986
- (5) Zhang Yinliang, Fire Fast Cook-off Test of Explosives and Propellants, Minutes of 23rd Explosives Safety seminar, Volume II, P2169, 1988
- (6) MIL-STD-1751 (USAF), 1982
- (7) Zhang Yinliang, Explosive Vulnerability Test Study, BING GONG XUE BAO, Part of propellants and Explosives, No. 1, 1988
- (8) Terry R. Gibbs, Alphanse Popolato, LASL Explosive Property Data, University of California Press, 1982
- (9) M. C. Chick and I. B. Macintyre and R. B. Frey. The Jet Initiation of Solid Explosives, 8th symposium (International) on Detonation, P318, 1986
- (10) M. C. Chick and T. J. Bussell, R. B. Frey and A. Biness, Jet Initiation Mechanisms and Sensitivity of covered Explosives, 9th Symposium (International) on Detonation, P666, 1989
- (11) Zhang Yinliang, Mi Litian, Wang Minzhu and zhang Jikang, Research of Metal Jet to Penetrate and Initiate the Explosives, Explosion and shock waves, Vol. 10, No. 4, P345, 1990



TABLE 1 Fire Fast Cook-off Test Results

Explosive	Density g/cm <sup>3</sup>	TMD* %	Cook-off Time s	Cook-off temperature °C	Fracture scenario of metal case (Fig.8)	Cook-off Reaction
TNT(pressed)	1.58	96	380	620	Ruptured into block	Deflagration
Comp.B(cast)	1.69	97	240	470	Fractured into pieces	Detonation
TATB(pressed)	1.73	90	300	590	Ruptured in lids	Combustion

\* TMD—Theretical Maximum Dencity

TABLE 2 Bullet Impact Test Results

Explosive	Density g/cm <sup>3</sup>	TMD %	Bullet Caliber mm	Bullet velocity m/s	Fracture scenario of metal case (Fig.7)	type Reaction
TNT(pressed)	1.58	98	7.62	741	Ruptured in lids	Combustion
Comp.B(cast)	1.69	87	7.62	741	Ruptared in a lid	Part combustion
TATB(pressed)	1.73	90	7.62	741	Not ruptured	No reaction

TABLE 3 Large Scale Gap Test Results

Explosive	Density g/cm <sup>3</sup>	TMD %	Gap Material	Critical Gap Thickness G50 mm
TNT (pressed)	1.58	96	Ly-12Al	42.5
Comp. B (cast)	1.69	97	Ly-12Al	41.0
TATB (pressed)	1.73	90	Ly-12Al	28.0

TABLE 4 Jet Sensitivity Test Results

Explosive	Density g/cm <sup>3</sup> (TMD %)	Critical Jet Characteristics *			
		X50 mm	V <sub>j</sub> mm/μs	d mm	V <sub>j</sub> <sup>2</sup> d mm <sup>3</sup> /μs <sup>2</sup>
TNT (pressed)	1.58 (96)	97.2	3.6	1.4	18.1
Comp. B (cast)	1.69 (97)	88.3	3.7	1.5	20.5
TATB (pressed)	1.73 (90)	47.5	5.0	1.9	47.5

\* X50—Steel Plate thickness, V<sub>j</sub>—Jet Velocity  
d—Jet Diameter

TABLE 5 Velocity and Diameter of the Jet by Flash X-rays

Steel Plate Thickness mm	30	50	70	90	110
Jet Velocity V <sub>j</sub> mm/μs	6.3	4.8	4.5	3.6	3.3
Jet Diameter d mm	2.1	1.8	1.5	1.5	1.2

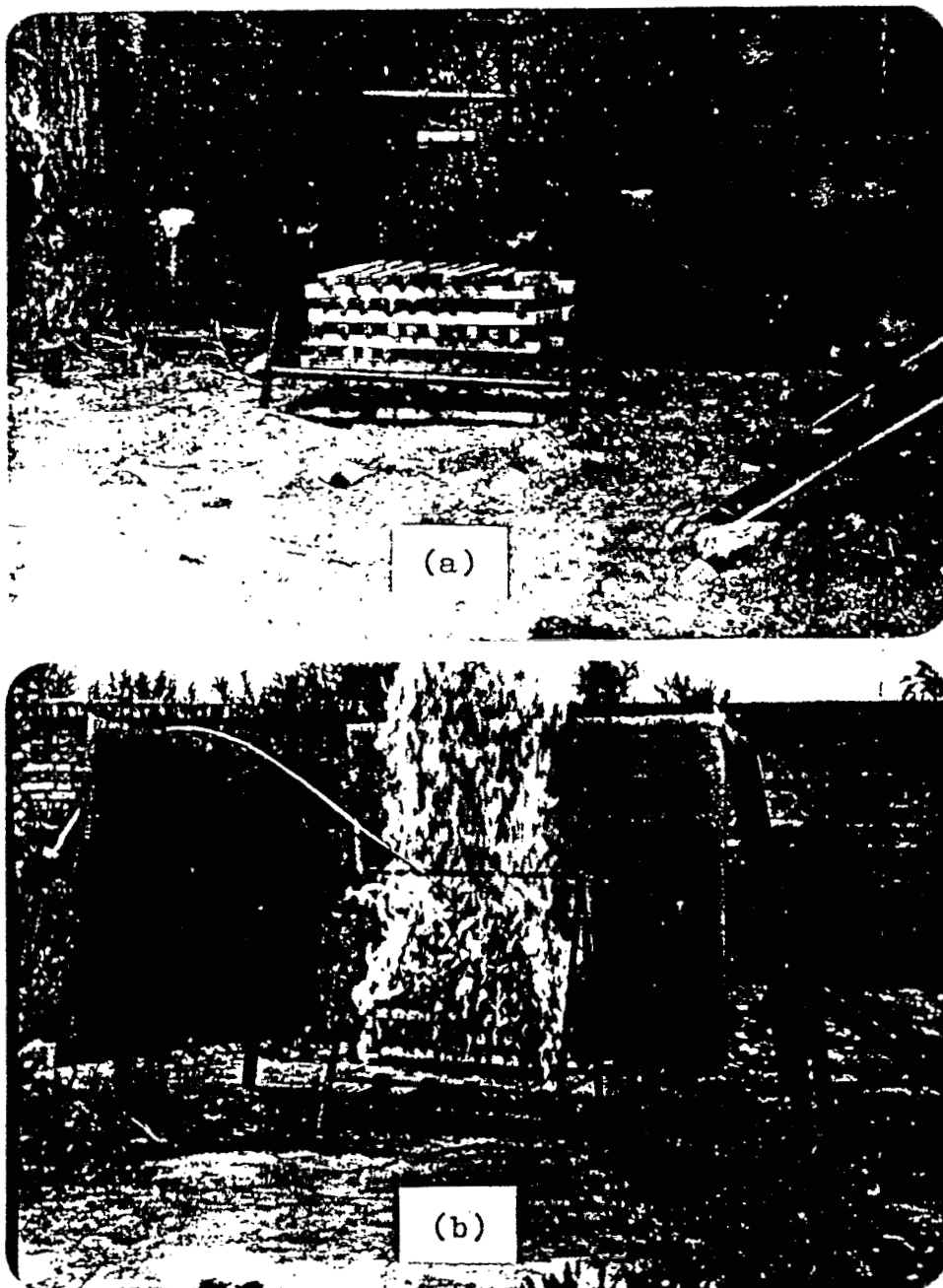

Figure 1 (a) Cook-off Test Set-up

(b) Flame Temperature Measurement

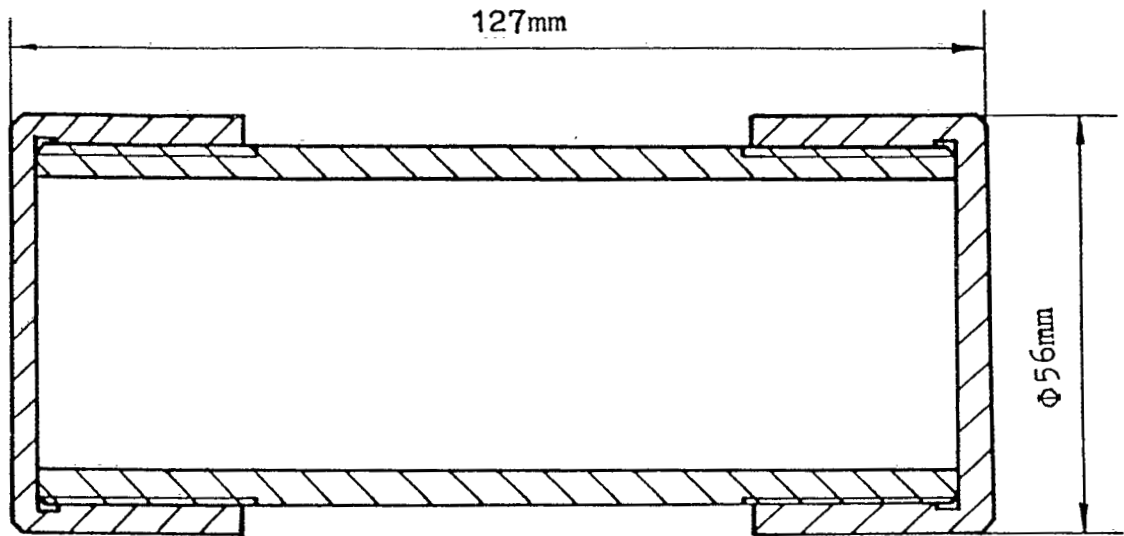

Figure 2 Metal Case

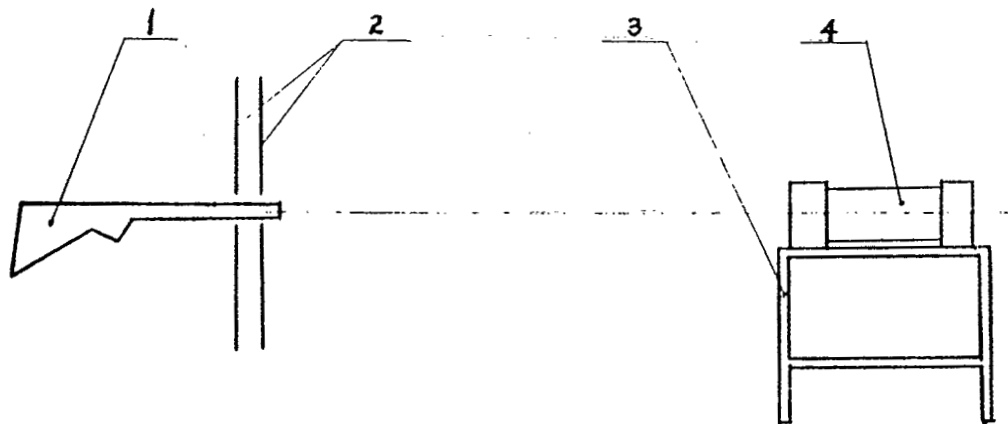

Figure 3 Bullet Impact Test Set-up

- 1—Rifle    2—Steel plate prevented  
3—support    4—Metal case

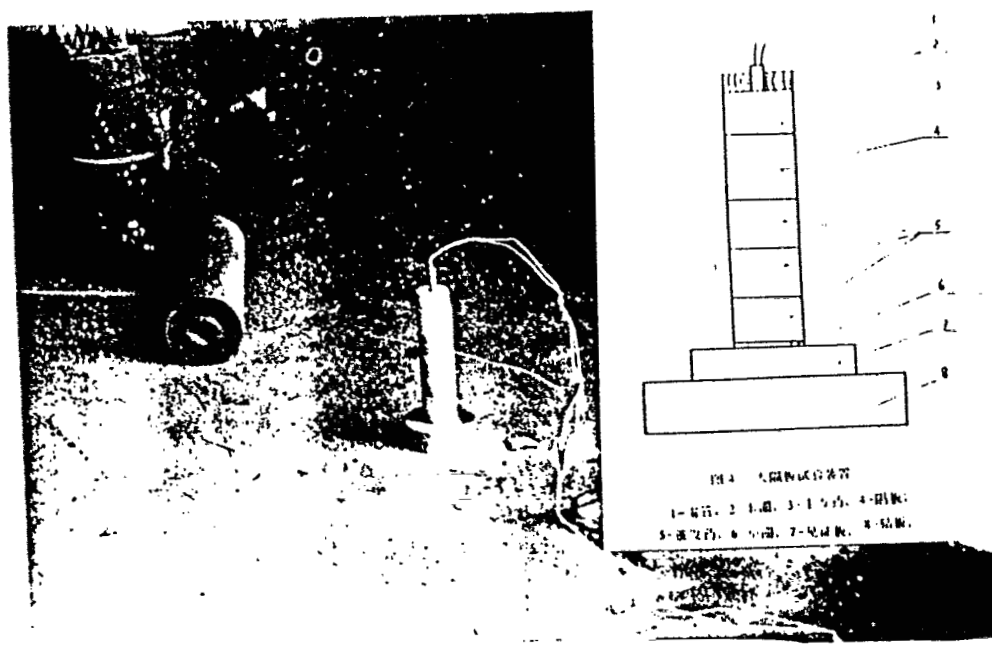

Figure 4 Large Scale Gap Test Set-up

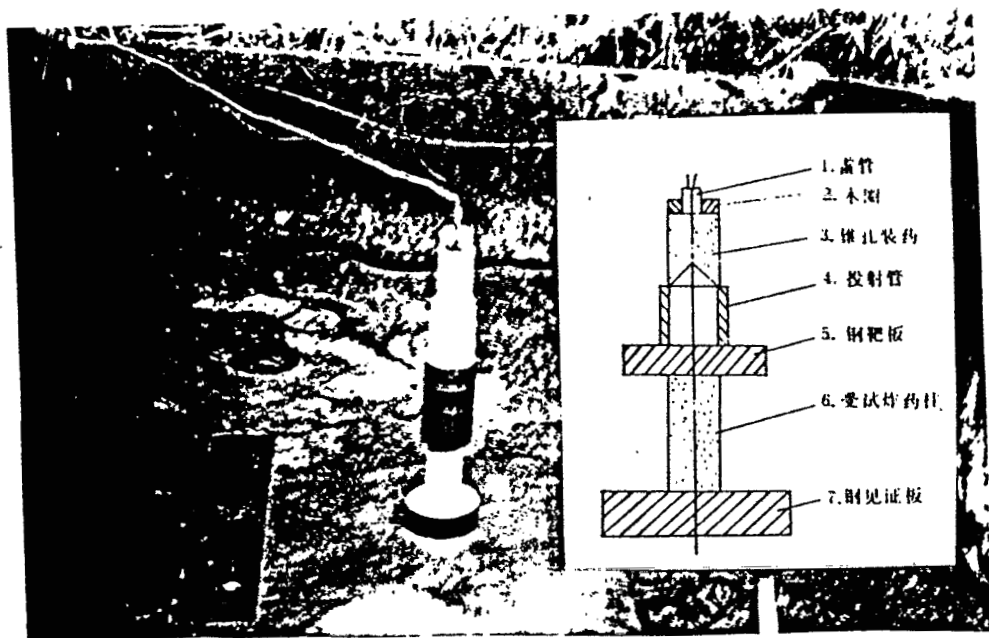

Figure 5 Metal Jet Penetration Set-up

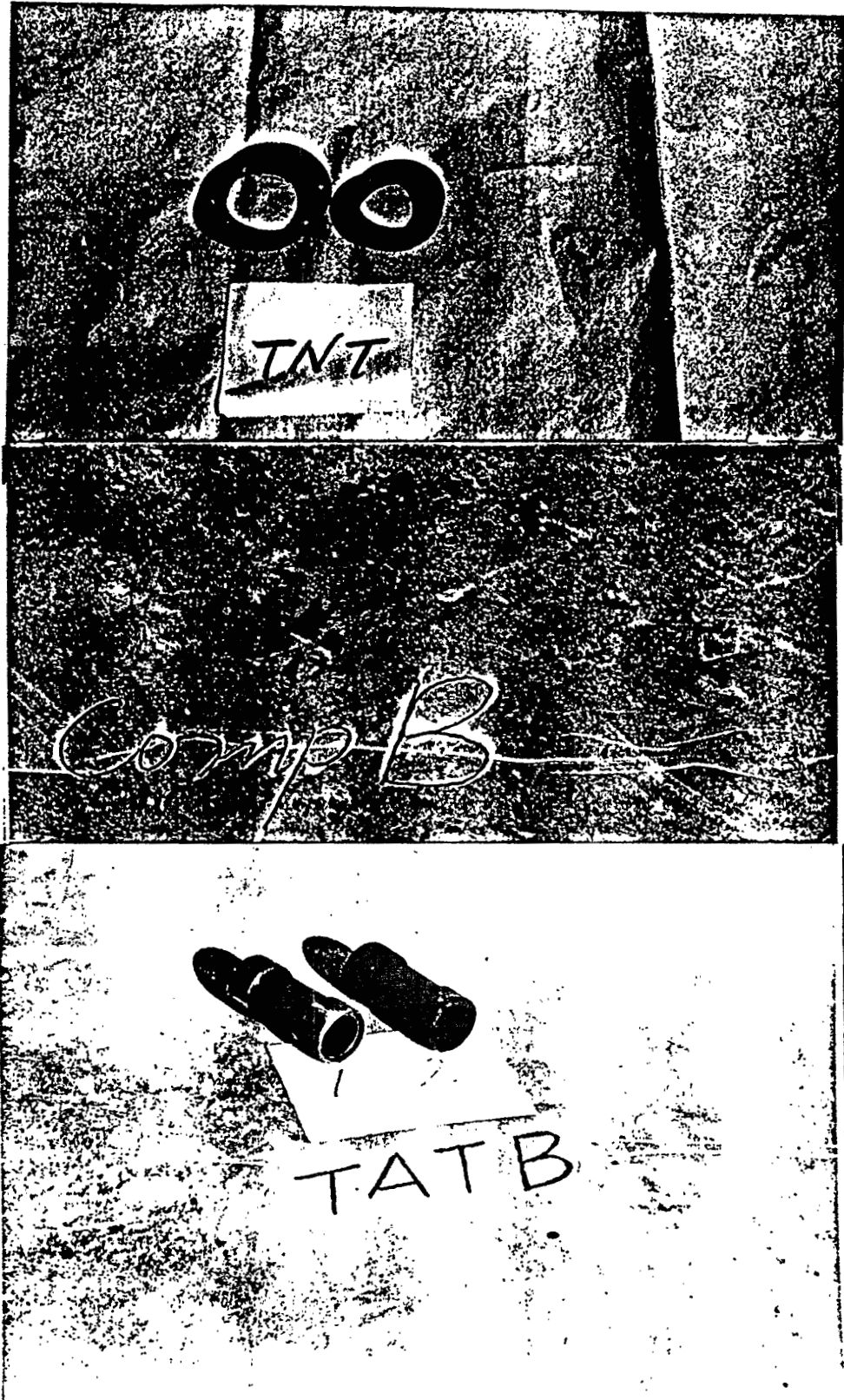

Figure 6 Fracture Scenario of Metal Case After Cook-off Test

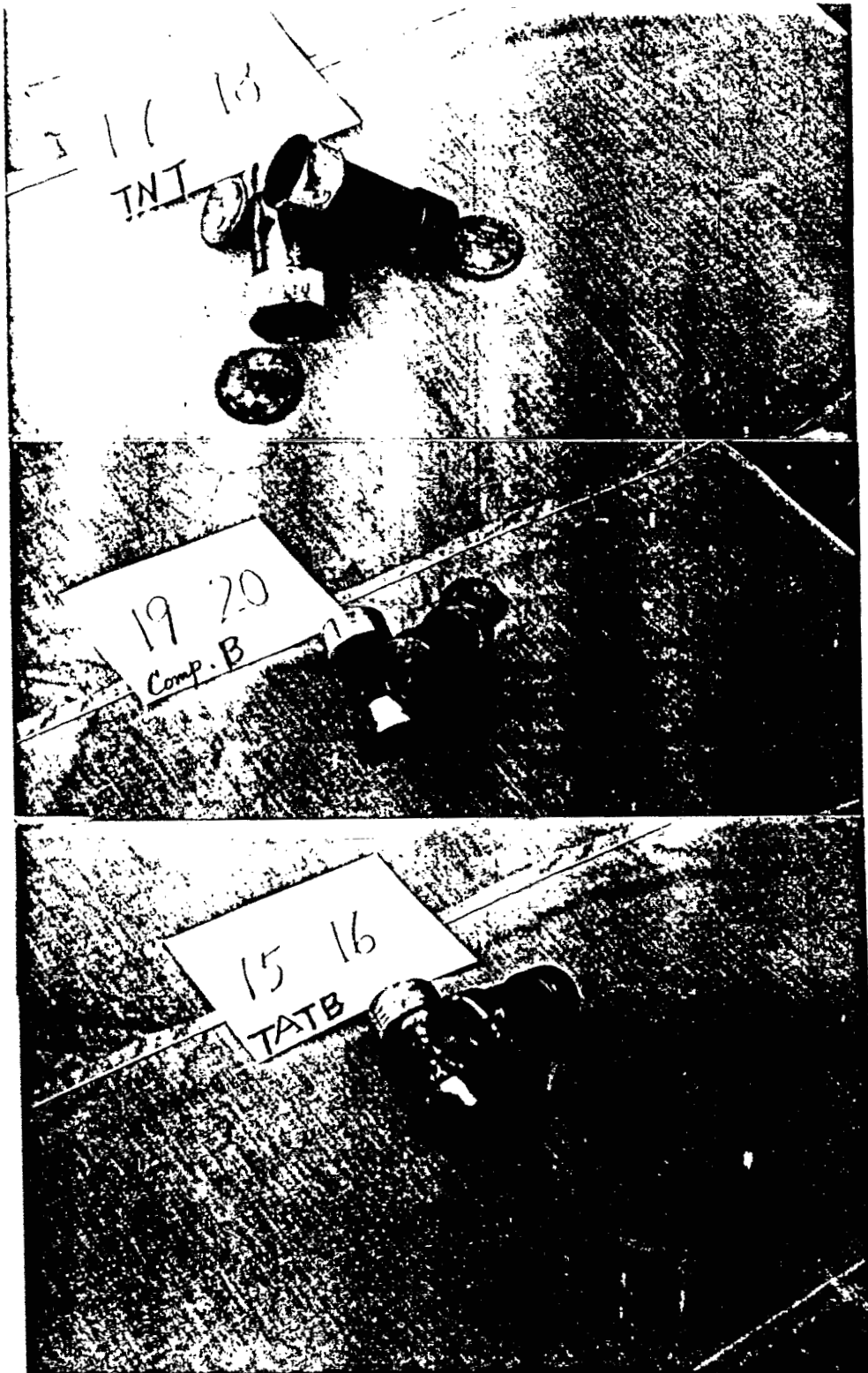

Figure 7 Fracture Scenario of Metal Case After Bullet Impact Test