

*Creating Defense Excellence:
Defense Addendum to
Road Map for National Security*

May 15, 2001



**U.S. Commission on
National Security/21st Century**

**Prepared by:
Dr. Pat Allen Pentland
Study Group Coordinator
USCNS/21st Century**

Report Documentation Page

Form Approved
OMB No. 0704-0188

Public reporting burden for the collection of information is estimated to average 1 hour per response, including the time for reviewing instructions, searching existing data sources, gathering and maintaining the data needed, and completing and reviewing the collection of information. Send comments regarding this burden estimate or any other aspect of this collection of information, including suggestions for reducing this burden, to Washington Headquarters Services, Directorate for Information Operations and Reports, 1215 Jefferson Davis Highway, Suite 1204, Arlington VA 22202-4302. Respondents should be aware that notwithstanding any other provision of law, no person shall be subject to a penalty for failing to comply with a collection of information if it does not display a currently valid OMB control number.

1. REPORT DATE 15 MAY 2001		2. REPORT TYPE		3. DATES COVERED 00-00-2001 to 00-00-2001	
4. TITLE AND SUBTITLE Creating Defense Excellence: Defense Addendum to Road Map for National Security				5a. CONTRACT NUMBER	
				5b. GRANT NUMBER	
				5c. PROGRAM ELEMENT NUMBER	
6. AUTHOR(S)				5d. PROJECT NUMBER	
				5e. TASK NUMBER	
				5f. WORK UNIT NUMBER	
7. PERFORMING ORGANIZATION NAME(S) AND ADDRESS(ES) U.S. Commission on National Security, 21st Century, Washington, DC				8. PERFORMING ORGANIZATION REPORT NUMBER	
9. SPONSORING/MONITORING AGENCY NAME(S) AND ADDRESS(ES)				10. SPONSOR/MONITOR'S ACRONYM(S)	
				11. SPONSOR/MONITOR'S REPORT NUMBER(S)	
12. DISTRIBUTION/AVAILABILITY STATEMENT Approved for public release; distribution unlimited					
13. SUPPLEMENTARY NOTES					
14. ABSTRACT					
15. SUBJECT TERMS					
16. SECURITY CLASSIFICATION OF:			17. LIMITATION OF ABSTRACT	18. NUMBER OF PAGES	19a. NAME OF RESPONSIBLE PERSON
a. REPORT unclassified	b. ABSTRACT unclassified	c. THIS PAGE unclassified			

Contents

Preface	iii
Summary	1
I. DoD Structural Reform	11
A. Realigning Staff Roles and Responsibilities	11
1. Staff of the Office of the Secretary of Defense	14
2. The Joint Staff	16
3. The Services	17
4. The CINCs	18
B. Reducing DoD’s Infrastructure	18
1. The Infrastructure Problem	19
2. The Defense Working Capital Fund	21
3. The A-76 Outsourcing Problem	22
4. Need for Common Visibility over Infrastructure	23
5. A Plan to Outsource and Privatize	23
II. DoD Process Reform	27
A. Reforming the PPBS Process	27
1. How the PPBS Process Works — Theory and Reality	27
2. Adjusting the PPBS Cycle	31
3. PPBS Lacks “Top-Down” Guidance and is “Bottom-Up” Driven	32
4. Involving Senior Defense Leadership in Strategic Planning	33
5. Developing and Elevating Alternatives via the PPBS	36
6. Output Focus with Joint and CINC Funding	39
7. Revising Programming and Analysis Mechanisms for the PPBS Process	41
B. Reforming the Defense Acquisition System	48
1. Role of Technology	48
2. The Defense Industrial Base	49
3. Acquisition Reform Overview	50
4. Acquisition Reform Principles	52
5. Innovation and Experimentation	53
6. Improving Program Stability	57
7. Improving Business Practices	60
8. Incentivizing New Behavior	65
III. Military Capabilities Reform	69
A. Force Sizing Requirements	70
1. Problems with Current Force Planning Process	70
2. A Capabilities-Based Planning Process	72
B. Military Forces	74
C. Military Capabilities	79
D. Implications	81

IV. Implementing Defense Reform	83
A. Defense Reform Prerequisites	83
1. Linking Reform to Strategic Objectives	83
2. Involving DoD Senior Management	85
3. Selecting Critical Initiatives to Pursue	86
4. Establishing a Sound Implementation Mechanism	86
B. Defense Reform Game Plan	88
 National Security Study Group Staff, Contractors, Consultants, and Advisors	 93

List of Figures

1. The “Theory” of PPBS	28
2. The “Current Reality” of PPBS	30
3. Current OSD (PA&E) Organization	44
4. Proposed OSD (PA&E) Structure	45
5. Current “Four-Phase” Acquisition System	60
6. “Three-Phase” Acquisition system	61
7. Defense Reform Game Plan	91

List of Tables

1. Current Major Force Programs	42
2. Joint Warfighting Capabilities Assessment	42
3. Proposed Major Force Programs	43

Preface

The National Security Study Group (NSSG) is a chartered entity that provides basic research and analytical support for the U.S. Commission on National Security/21st Century (USCNS/21). The NSSG has issued reports through its Executive Director, and has traditionally done so through the medium of “Supporting Research” or “Addenda” associated with specific reports. The NSSG prepared this Addendum at the original direction of the Commission. Because the Department of Defense (DoD) plays a crucial role in national security, the Commission and Study Group considered it important to expand on a number of defense reform recommendations in the Phase III report, *Road Map for National Security: Imperative for Change*. Of concern were those DoD structural, process, and military capability reforms in Section III, D, of the main report. The Commission believed that additional explanation and analysis would prove useful to those charged with reforming the Department. However, we deliberately excluded other defense reform topics and recommendations from this Addendum. The Phase III report contains sufficient details about DoD support to Homeland Security (Section I) and on military personnel reforms (Section IV). In addition, the Commission has developed detailed implementation plans for those sections of the report. (See *Road Map for National Security: Addendum on Implementation*.)

Thus, this Addendum supplements the Phase III report, and primarily reflects the work of the full-time NSSG staff, a collection of national security scholars and practitioners. Nevertheless, while the Addendum mirrors the structure and recommendations of a section of the main Commission report, it also provides additional material. The Commissioners unanimously concurred on all 50 Phase III major recommendations contained in the main report and on the numerous supplemental recommendations, although they did not agree with every nuance contained in that report.

Likewise, not all the expanded material in this Addendum has been reviewed and unconditionally approved by the Commission. To highlight this distinction, *this Addendum presents fully approved Commissioner recommendations in bold, italic text*, and it specifically identifies USCNS/21 proposals with the word “Commission.” Conversely, *it presents recommendations expanded by the Study Group in non-bold, italic text*, and clearly identifies new material associated with these proposals with the acronym “NSSG.” Moreover, this Addendum informs a different audience, and contains a greater level of detail than the main report. Many senior executives would probably not concern themselves with such a “nuts and bolts” discussion, but the complexity of defense reform demands further elaboration. Thus, this Addendum should also assist interested parties in further understanding the Commission’s recommendations.

Stemming from the last distinction—the intended audience—this Addendum offers more in-depth guidance to accountable authorities. The level of detail varies by topic. Part of the Commission’s chartered Phase III responsibility is to provide “an institutional roadmap” for implementation, “when appropriate.” In that spirit, the NSSG has expanded this Addendum.



Charles G. Boyd, General, USAF (Retired)
Executive Director
USCNS/21

Summary

The Department of Defense (DoD) has gone through some monumental changes in the last two decades, and it faces some enormous future challenges. The changes include the Goldwater-Nichols Defense Reform Act of 1986, which realigned authorities and responsibilities in the defense establishment, and the end of the Cold War, which brought about significant reductions in force structure. The challenges encompass the rise of new commitments and missions, the problem of adapting revolutionary information technology, and the evident need to reshape DoD's support systems, processes, and infrastructure. Both the changes and the challenges have made the need for defense reform evident. Numerous studies, commissions, panels, and Congressional reports have revolved around the single issue of transforming the Department to cope with the security needs of the 21st century.

In 1997 one such effort, the Defense Reform Task Force, consulted a world-renowned management expert on how to reform DoD. After a short pause, he stated, "You of course realize that the most difficult problem in the entire world right now is the transformation of Russia into a democratic, free-market economy. You may not realize that the second most difficult problem I can possibly envision is that of reforming the Defense Department."

This vignette underscores the magnitude of the task and should disabuse those who see simple solutions that underestimate the complexities of the issue. Entrenched bureaucracies within the defense community, which either *see* no problem or which approach every solution with requests for increased funding, constitute a major component of the defense reform problem. A GOSPLAN mentality persists within much of the Department. Inevitably, prior defense reform efforts have focused on the margins. They *rewire* some organizations and *tinker* with existing processes, but refuse to articulate a vision of what military capabilities the Department needs to produce and how DoD might operate—in other words, the desired *characteristics* and *outcomes*.

This Addendum offers recommendations that focus on structure and process, but here the NSSG also clearly states a vision—a set of desired outcomes—if the Department is to implement these recommendations. Thus, this summary aims to avoid a stovepiped examination of individual recommendations. Rather it offers an overview of the major recommendations and how they mutually reinforce each other to create excellence. This effort suggests seven future DoD outcome-oriented objectives worthy of pursuit that, if implemented, would make a remarkable difference in America's national security posture.

- **Objective One:** *A leadership function within the Office of the Secretary of Defense (OSD) focused on strategic direction, resource allocation, mission assignment and management oversight, while it eschews direct ownership and daily supervision of operational agencies.*

No OSD staff function or responsibility is more important than establishing policy. That task should be the basis of everything OSD does. However, the Department now performs that task far less effectively than it should. Strategic direction suffers from a serious lack of overall focus, an absence of direction from a coherent national security process, and poor coordination of national security policy among the instruments of government—particularly at the interagency level—where OSD should take the lead and orchestrate defense issues, but largely has not and does not.

OSD has fallen well short in its responsibility to lead and direct overall resource allocation.

OSD has fallen well short in its responsibility to lead and direct overall resource allocation. This stems from both lack of will and the absence of a management system and process to do so. It has left this critical function to a Service-driven, bottom-up process that OSD and the Joint Staff belatedly paw over, but is left largely unchanged by OSD leadership. Overall, OSD only impacts one percent of the Service budgets! Moreover, OSD has studiously avoided the assignment of missions, another core responsibility of leadership. That failure of OSD leadership has defaulted the task to the Services (who argue over missions), to periodic commissions (which “survey” the problem), and to the Congress (which interferes with and tries to steer the process). Moreover, there has been little improvement over thirty to forty years of Service “turf” wrangling.

Management oversight by DoD has been lacking. The General Accounting Office (GAO) has largely inherited the role of commenting on management flaws, while the Services and OSD have been left the role of responding to outside criticism. This is an area where OSD should lead by setting goals and establishing broad output metrics, and then holding subordinates accountable for outcomes: in other words, the basic blocking and tackling responsibilities of leadership.

The NSSG also strongly advocates that OSD must divest itself of activities not involved in providing strategic direction, resource allocation, mission assignment or management oversight. This is a sensitive matter, since it would immediately terminate OSD’s growing practice of establishing and running operating agencies that report to staff bureaucrats. DoD must assign some Defense Agencies to leaders and commanders accountable for producing results, along with the responsibility to justify budgets, programs, and practices. Other Defense Agencies, the Department should outsource or privatize.

- **Objective Two:** *Redesign Departmental infrastructure support functions to meet core military needs, but operate them under sound business principles that intelligently leverage the commercial sector—including outsourcing and privatization.*

This functional area is probably second only to resource allocation in its Service-associated sensitivities. In fact, much of the infrastructure problem is properly the Services’ responsibility. At the same time, the Services confront a heavy burden of excess facilities, poorly focused procurement and stocking policies, and duplicative and repetitive support capabilities. Because the emphasis, core talent, leadership, and training in the Services concentrates on “operations,” “support” often takes a second seat. Lacking pride of place, it is nonetheless the primary consumer of defense resources—a dangerous combination.

Infrastructure support functions are a fertile field for substantial savings and efficiencies, estimated at a recurring \$30 to \$50 billion per year, according to every study and commission that

Infrastructure support functions are a fertile field for substantial savings and efficiencies.

has examined the problem. Even if the numbers are only half of what is predicted, they are substantial in these times of constrained funding and unfavorable “tail-to-tooth” force ratios. The fiscal savings associated with Base Realignments and Closures (BRACs) are well known, and more BRACs are crucial to further streamlining and reduction of excess capacity.

Other areas offering the prospect of substantial savings and improved effectiveness lie in mastering the oversight, accountability, reporting, structuring, functions, and products of Defense Agencies. While OSD must retain its policy functions, it must give up all its agencies and their daily supervision must be placed under accountable leadership. Defense Agencies and field activities all need reinvention, with some actually candidates for elimination; some vastly modified in function; some substantially reorganized into a sensible military/commercial product/output mix; and some reoriented into new organizational structures designed to meet output user needs, not internally focused on a process. The only agency under OSD control that the NSSG endorses in its present form is the Defense Advanced Research Projects Agency (DARPA). This is an exception to the general rule, because of its role to peer into the future and examine conceptual feasibility and visionary/revolutionary technologies that the Department can feed into the processes of developing future strategy, policy, and acquisition.

- **Objective Three:** *An OSD fiscal function armed with the necessary management tools that would allow leadership to correlate the allocation of resources and budget with achievement of desired policy objectives more coherently and in a more timely fashion.*

Today, the Department's planning and programming process and fiscal functions are at best a poorly structured ledger entry and journal-oriented accounting system. It knows the *cost* of countless disconnected and unrelated pieces (program elements) but not the *value* of the various purposes of the enterprise. This state of affairs results from the Department's budgetary focus on "inputs" versus "outputs." Then Secretary of Defense Robert McNamara took a first cut at the problem in 1961 by setting up the basic Planning, Programming, and Budgeting System (PPBS) with its various program elements, but the Department stopped there. This archaic, industrial-age accounting system has persisted, still mired in the 1960s. For example, the Department can point to any number of program element codes associated with tactical systems, but it cannot evaluate the price of tactical operations or missions—it does not think that way, nor does it set up and aggregate program accounts in that fashion. Nor does the Department possess the means to measure progress toward achieving *any* objectives. The current Defense Planning Guidance (DPG) does not specify objectives or priorities, nor do the current Major Force Program categories in the PPBS process lend themselves to analysis by useful mission area. Without missions or objectives specified, the Department cannot measure meaningful "outputs."

PPBS is an archaic industrial-age accounting system, still mired in the 1960s.

Several years ago, a Defense Science Board (DSB) study suggested that the Department establish an "input-output" style resource table. Such a table would have the various DoD (e.g., military Service) organizations arrayed along the ordinate, and the various output organizations (CINCs) along the abscissa, with the right vertical column totaling to the overall DoD budget at the bottom. The DSB's notion was to construct better methods to grasp the true costs of task execution, with further potential drill-downs contemplated to peel away the layers and improve understanding. When this idea was carried forward, the Services and the Joint Staff uniformly recoiled from such a relatively small change. Admittedly, the effort would have been difficult—no question—but that was certainly not justification for rejecting the proposal. In many ways, the Services do not want to know the answer, because such an answer would eventually pull together the true cost of providing particular functional outputs to the field. Once known, the door might be open to find newer, cheaper, and better ways to accomplish military missions. As long as costs remain input-collected and functional costs are obscured, *military judgment* remains the sole entering argument—further assistance neither required nor desired.

This is a paradigm on its head. Every business wants to know what it costs to accomplish a task, produce a product, or provide a service—but DoD deliberately chooses not to know. Despite institutional resistance, the Department needs to work diligently to change this situation. DoD needs to better understand what it costs to achieve desired outcomes effectively. To do this, it must determine if the envisioned military capability-related “outputs” justify the various attributed costs of the “input” functions. Such a tool would provide senior leaders the needed visibility over investments, and an understanding of current resource allocation effectiveness. It would create a useful mechanism to compete and adjust resource allocations in order to achieve improved outcomes.

- **Objective Four:** *An OSD tasking function, which ensures that departmental “input” elements (the four military Services) have clear cut lines of responsibility and authority for organizing, training and equipping forces, as well as ensuring that the “output” elements (Joint Staff and CINCs) have the authority, capability, resources and means to assure successful mission execution.*

If there is a first-order sensitive nerve in the Department, this is it. One can best describe DoD’s fifty-three year history as a titanic struggle to reallocate the authorities of the military Services—budgetary as well as operational—among the supervising OSD staff, Service secretariats, military departments, Joint Staff, and the CINCs. Nothing absorbs more Departmental energy than this issue. While incremental progress toward clear lines of responsibility has occurred over time, the ball has not moved down the field to any significant extent since Goldwater-Nichols in 1986. The reasons are evident: too hard to do; causes huge fights; involves the Congress; and takes on entrenched constituencies.

However, the attack plans for reforms have never been sound. Attempts to alter the status quo have most frequently occurred through the plans and policy route. However, a more effective attack axis would be through the ultimate OSD weapon, the resource allocation tool—by leveraging the Golden Rule: “He who controls the gold sets the rules.” If OSD truly controlled the allocation of resources, and performed that task in a visionary up-front fashion linked to OSD’s responsibility for strategic direction, the budgeting entities would be obliged to conform to the established direction.

The NSSG is not naive enough to believe this could happen overnight. Quite the contrary, we appreciate that it cannot. There would be substantial resistance to such an approach, but this proposal would set changes in motion, which, over time, would gain traction. With the OSD policy and planning function setting forth outcome objectives, linked to strategic guidance from the President and the Secretary, the resource allocation processes could both establish financial “guidelines” and use “competition” to leverage innovative change. For example, OSD could hold back portions of the defense budget, and allocate different percentages of funding to research and development (R&D) or to space. Moreover, such a system would force the Services to compete for different shares of the budget during the Quadrennial Defense Review (QDR) process for certain capabilities and systems. OSD could use reallocation and competition to better balance operations, readiness, sustainability, and modernization needs throughout defense programs. It also might begin producing the future capabilities this nation needs.

The QDR should focus on altering resource investment and expenditure.

Alteration of the financial investment and expenditure guidelines should be the focus of the QDR debate among the Services, the Joint Staff, and the CINCs, with OSD retaining ultimate control. Once OSD settled the debate, the Services would then compete for resource allocations by designing

fiscally constrained programs and proposals within their assigned mission areas to “capture” the funds required to sponsor and execute desired policy outcomes.

Part of this outcome objective proposes that the Joint Staff and CINCs possess “... *the authority, capability, resources and means to assure successful mission execution.*” This is a highly controversial issue among the Services—empowering the “output” function by providing them direct access to resources. In DoD, the current approach provides money and resources only to the “input” functions, while the business world does just the opposite. In the latter case, the function that produces the product and/or service—the purpose of the enterprise—drives the various corporate inputs to hew to its needs. If DoD were to adopt such a system, the Services would still remain the stewards of force structure and most of the resources. The Services must take the long view of requirements and force modernization because they support force structures over the full life cycles of personnel and equipment. As currently structured in DoD however, only the Services determine what the executor will have—in organization, training, and equipment—and OSD largely looks on as a spectator rather than a referee.

At the same time, the NSSG is not suggesting a revolution but rather a series of sensible modifications to the current policies and processes. Stated simply, fund output entities to execute some of the functions for which they are directly accountable. In the case of the Joint Staff, the budget/funding list is short, mainly: the funding of the staff and those output functions assigned, such as standardization, interoperability, joint education, and joint testing. CINCs must also receive sufficient resource authority to carry out their uniquely assigned tasks, primarily the command and control of joint forces at the strategic and theater level, and preparation of those forces for potential employment through the design, planning, control, and execution of joint exercises. Placing the control of standardization and interoperability resources in the hands of the Chairman and exercise funds in the hands of the CINCs would over time enormously improve warfighting capabilities.

- **Objective Five:** *Reinvigorated military Services that embody authority, responsibility, and accountability, and who participate as true partners in key resource decisions, while managing programs effectively and efficiently.*

This is the “flip side” of Objective Four above. While it recognizes the struggle for power over resources and authority within the Pentagon—and the primacy of OSD—it acknowledges that sound management within the Department requires Service cooperation and participation. Secretary Rumsfeld needs to establish a shared vision that enjoys “buy in” from the Services.

The Secretary needs to establish a shared vision that enjoys “buy in” from the Services.

Rivalry and opposition between the Pentagon’s staffs exist for several reasons, but primary among them is the deeply-held belief that each organization is “doing what’s right” for the security of the nation. The Services spar with each other over doctrine and missions, because these drive requirements and ultimately force structures, programs, and resources. The Joint Staff possesses particular views on the requirements for “Joint Warfighting” and some senior career civil servants in OSD hold long-established opinions that can be incompatible with Service plans. Major differences can also exist between the uniformed Services and the political appointees within OSD. Bluntly stated, the military Services clearly acknowledge civilian authority and control, but occasionally distrust political appointees—many of whom can be young, inexperienced academics—as “interlopers” who can severely damage well-established Service programs, which the Services institutionally view as critical to national defense. Thus, when

political appointees fail to consult seriously with the Services or oppose Service programs, the Services, in turn, resort to a strategy of “using the system” to delay and wait out the political appointees’ tenure. This management culture must change.

Reform should begin by selecting Service Secretaries (and OSD appointees) for their management skills and experience, not as political window dressing or to satisfy political debts. Secretary Rumsfeld has shown true judgement on this issue. The Service Secretaries should act as the principal agents of the Secretary of Defense in managing the departments. While OSD should set policy and expect cooperation from the Services in “corporate decisions,” the Services must be re-empowered to execute. For example, retaining authority for major acquisition decisions in OSD, while holding the Services responsible for programs, divides accountability and results in nobody being “in charge.”

Just as importantly, the Service chiefs and the Joint Chiefs must also be revived as institutional actors. Their influence has been overly reduced by Goldwater-Nichols, and the result has not improved decision-making in the Department. When the Service chiefs routinely send vice-chiefs or even deputies to weekly “Tank” sessions, it is primary evidence that substantive issues are not being elevated or addressed in these meetings. This is because military advice to the Secretary and the President is now predominantly coming from a single individual—the Chairman—and contrary views are infrequently sought or desired from the Joint Chiefs. What this also indicates is that Goldwater-Nichols has fully swung the pendulum in the opposite direction from the days of watered-down, consensus-derived advice by the Joint Chiefs. There needs to be a happy medium, and Service participation in resource allocation and policy decisions should be improved via three venues.

First, within the proposed Quadrennial Defense Review competition, the Services would be responsible for surfacing proposals to satisfy high priority objectives of the Secretary of Defense, but just as important, they should also have an input into those objectives. Second, after competition decisions are made, Secretary Rumsfeld needs to call the Service secretaries and chiefs in for regular meetings. There the Secretary must empower them to manage their Service programs, and require them to eliminate the unfunded modernization “bow waves.” Essentially, the Secretary must allow them to act and make management decisions within resource constraints, and if they cannot or will not do so, only then be ready to issue OSD guidance to do it for them. Third, Secretary Rumsfeld should invest enough confidence in the Joint Chiefs to seek their guidance and military advice on issues, even though it is technically no longer required by Goldwater-Nichols. This would not impact the legal authority of the Chairman, but would inject additional views and new vitality into the mechanism of the Joint Chiefs.

Ultimately, the Secretary needs to embrace the Services as managing partners in the Department.

Ultimately, the Secretary needs to embrace the Services as managing partners within the Department. Competition among the Services is good when it stimulates alternative solutions, military capabilities, and forces from which Secretary Rumsfeld can make decisions. But once reached, the Services should execute decisions and

run programs to provide effective and efficient operational capabilities of unique forces that can jointly operate.

- **Objective Six:** *A Departmental acquisition system that puts high technology capability in the hands of the U.S. warfighter more quickly than the development, decision, and execution cycle of potential adversaries.*

For the past decade, the focus of acquisition reform has been on improved processes, not better outcomes. We now have: fewer, but larger suppliers; a greater concentration of funding going to system-of-system companies larded with growing overhead and institutionalized methodology (oriented on evolution, not revolution); a declining ability of OSD and the Services to manage programs competently; and much slower technology-to-shooter developmental times. The latter is a dangerous characteristic for a nation committed to substituting high technology for “mass” in warfighting, and intent on reducing risks to the fighting forces.

Defense acquisition is an area ripe for implementing incredible improvement. The Commission and NSSG recommendations intend to shift acquisition investment policy to the perspective of a “going concern.” That is, DoD should develop and execute long-term funding strategies for major defense accounts—modernization, readiness, force structure, and supporting infrastructure. The current year-to-year expenditure pattern lacks coherence and vision, results in substantial sector instabilities (e.g. spotty readiness funding profile), damaging funding “holidays” (e.g. R&D, procurement/ modernization), and creates burgeoning bow waves (e.g. infrastructure renewal).

DoD should look to the marketplace to solve the value proposition—cost, performance, timeliness, need, and mission functionality. To break down barriers to innovation, the Department needs to focus its effort on providing improved product “outcomes,” rather than simply justifying accumulated costs and rescheduling programs. A new approach must include restructuring existing centralized and arguably inefficient agencies, many—if not most—of which the Department can outsource, privatize, or operate on a competitive business model to promote management responsiveness and accountability.

The Department must shift its acquisition perspective to one that focuses on defining the required system capabilities that contractors must produce by a certain time to function within increasingly rapid technology development cycles. The Department should accept more tradeoffs, rather than insisting on specific performance for a fixed fee during a time when technology is advancing rapidly—as is happening in the commercial sector. Failing to pursue such a policy would deny a unique American strength—technology to deliver decisive battlefield outcomes at minimum loss in U.S. lives.

The Department must incentivize innovation, bolster industrial base sustainment, and leverage free market strengths by embracing the principle of continuous competition (more than one supplier) as much as practical. In selected circumstances, it may be necessary to grant waivers in competition due to the low quantity under order (e.g. aircraft carriers); unfeasibility of provisioning a second supplier (submarines); or unique but narrow technology applications (nuclear power plant). *But, in the main*, the Department must embrace the principle and practice of continuous competition as the soundest way to procure major defense articles at best value and, overall, best price.

Embrace the principle of continuous competition as the soundest way to procure major defense articles at best value and best price.

The Department should underpin, stabilize, and focus modernization planning by directing sustained year-to-year “level of effort” funding for: research and development; prototyping/capability demonstration; and upgrades to platforms, systems and capabilities. Such

an approach entails a commitment to the principle of sustained low-rate stream production schemes, that stabilize production costs, improve price predictability, utilize resources and facilities more efficiently, but most importantly, facilitate the timely and rapid insertion of technology.

The Commission's objective is a broad "industrial base for defense," rather than today's discreet "defense industrial base." The Department can accomplish this goal by designing and strongly advocating a procurement system characterized by the lowest possible barriers for new entrants to government business by new, agile, technologically innovative companies. Today's commercial marketplace increasingly relies on intellectual power and timely market presentation to compete successfully—characteristic strengths of smaller rather than larger firms. The Congress and the Department should embark on a course that rewrites current acquisition

The Congress and the Department should rewrite current acquisition legislation in a fundamental fashion that revises the current Federal Acquisition Regulations.

legislation in a fundamental fashion that revises the current Federal Acquisition Regulations. Like welfare reform in the 1990s, such a revolutionary approach has a better chance for success because it would be easier to start over than amend the current mountain of laws and regulations. In the interim, the Commission recommends simplifying the acquisition process from a four-phase to a three-phase system, providing waivers more easily, and reducing the overwhelming auditory and oversight requirements that inhibit business with DoD. The present practices

currently bias procurement to select larger, evolutionary-oriented companies, rather than small, revolutionary-oriented firms marketing fast moving technologies. The Department is now incorporating technology at a slower pace than ever before, while the commercial sector has solved this challenge and is moving even faster because of its entrepreneurial spirit, the power of new ideas, and its ability to manage risk.

The government should retain proprietary title to all contractor work fully funded at taxpayer expense. The goal should be the protection of taxpayer valuables purchased with government funds, whether it is in R&D, processes, or products. The purpose should be to facilitate constant competition. Such an approach also promotes standardization and interoperability, while at the same time, it moves away from proprietary procurement practices where, in effect, the taxpayer pays twice... and sometimes three times for the same taxpayer-financed development. The policy of retaining proprietary rights—along with the policies of constant competition, evolutionary step upgrades, and funded and stabilized R&D—would eliminate some important contractor needs to "game" the current system. Namely, the system drives many to underestimate R&D risks or to understate first article procurement costs, which, in turn, forces them to present sharp price increases during follow-on contracts to recover expenses. The Services abet this process by their willingness to accept such low estimates in their desire to move programs through major milestones. They know that "sunk costs" in a system leverage arguments for continued expenditures, despite cost increases. This process needs to stop.

- **Objective Seven:** *Flexible DoD mechanisms that constantly adapt to change, and produce military capabilities and future force structures better suited to the emerging national security environment, rather than replicating legacy forces and missions.*

With a radically altered vision and mindset—an empowered and policy-focused OSD staff; fiscal authority and accountability; a reformed infrastructure support system; a PPBS process oriented on objectives; reinvigorated Services; and a technologically driven,

output focused, and lean acquisition system—the Department could solve some very tough force structure challenges. Namely, these include how to evolve the pace and scale of change over the next few years, and how to decide what entities are responsible and accountable for existing and emerging missions—particularly for homeland security, for rapid expeditionary capabilities, and for space. This entails breaking the Two Major Theater War (2MTW) paradigm and reallocating modernization resources to transform the force.

As the Commission indicated in its Phase II report, the concept of fighting near-simultaneously two major theater wars—the current basis for US military force structure planning—is not producing the capabilities this nation requires. The present commitment to readiness for all-out engagement in two regions of the world at the same time, without strategic prioritization and sequencing of campaigns, is by itself an extraordinary notion. To envision at present, two opponents capable of or willing to challenge the United States in a theater-wide conflict simultaneously is indeed an extraordinary notion. Far more likely is the need to retain readiness for a major conflict while also securing the homeland and responding to small-scale conflicts, international terrorism, peacekeeping, humanitarian actions, and other commitments requiring U.S. support. Failure to plan for the more likely scenarios impedes the *transformation* process needed to produce capabilities better suited to the actual security environment.

The Commission clearly emphasizes that the current 2MTW construct is a force sizing tool, not a strategy. As a sizing tool, it is utterly inadequate for any sensible strategy. It fails to support transformation and over-invests in the past. A useful force sizing tool must both *shape* and *size* the force, but the present method only preserves *size*, by assuming that complex contingency requirements are “lesser included demands” satisfied by the current force. The Commission contends that force capabilities are not infinitely flexible and fungible, and emphasizes a basic need to also *shape* military forces to ensure they are prepared for a wider range of operations with extremely deployable, lethal, and agile units. One cannot train military forces and hold them ready for an array of fundamentally different missions without degrading their readiness to perform core war fighting tasks. The Commission also recognizes the high opportunity costs of the current force posture: sub-optimizing for contingencies; deferring modernization; and crowding out transformation. Worse still, the precipitous readiness erosion inside today’s armed forces will accelerate unless the Department realistically matches forces to anticipated uses.

The key to producing such a shift lies with altering the Department’s current threat-based force sizing metric into a capability-based force sizing tool. This proposed process would measure requirements against recent operational activity trends, actual intelligence estimates of potential adversary’s capabilities, and the national security objectives as defined in a new national security strategy and national military strategy. U.S. military force planning should both *size* and *shape* U.S. forces against a strategy of **detering** war, **precluding** crises from evolving into major conflicts, and **winning** wars rapidly and decisively when necessary.

U.S. military force planning should both *size* and *shape* U.S. forces against a *deter, preclude, win* strategy.

During the transformation to a capability-based force, the Commission recommends retention of current near-term capabilities to fight a major theater war. As the transformation process advances, the primary focus would emphasize multiple complex contingencies and homeland security. Noting that U.S. overseas bases and force structure have decreased dramatically over the last decade, while the frequency and duration of commitments have

increased, the transformation process must concentrate on fielding fast, agile, and rapidly deployable forces.

It would be inappropriate for the Commission to dictate the exact number and type of divisions, wings, and naval battle groups this nation needs to execute its strategy, however it can provide guidance and a *mechanism* to help the Department move in the necessary direction. Accordingly, the Commission recommends that Secretary Rumsfeld revise the categories of Major Force Programs (MFPs) used in the Defense Program Review to focus on a different mix of military capabilities, and use the MFPs to capture mission-oriented functional outputs. New MFPs should be created corresponding to the five military capabilities the Commission deemed essential in its Phase II report—namely: Strategic Nuclear Forces; Homeland Security Forces; Conventional Forces; Expeditionary Forces; and Humanitarian Relief and Constabulary Forces.

This Commission recognizes the transformation process will produce these five capabilities over time, yet some must mature at a faster rate. Ultimately, the transformation process should render the distinction between expeditionary and conventional forces moot, as both types of capabilities will eventually possess enhanced mobility, survivability, and lethality. For the near term, however, expeditionary capabilities are the most critical to the existing and future security environments. Consequently, the Commission recommends that the Department should devote its highest priority to improving and further developing its expeditionary capabilities, which implies the need for long-range power projection and theater missile defense.

From a Departmental perspective, there will be heavy lobbying by all the Services for these missions including homeland security and National Missile Defense. By achieving dominance in any area, a Service could achieve preeminence for up to a decade with major control of resources and significant force structure. If OSD fails to exercise strong policy direction or control of the resource allocation process, these issues alone will consume all the available bureaucratic energy, while obscuring sound transformation of the force.

This Commission has identified what the Departmental vision should look like—a set of desired outcomes—to meet this nation’s military needs for the future. The Department must concentrate on internal reform. It must empower OSD and restructure the other Pentagon staffs along core roles and responsibilities. The Department must consolidate, outsource, and privatize defense infrastructure to free up resources. It must institute a strategy-driven planning and resource allocation process that is focused on mission outputs. It must reinvigorate the Services as management partners within the Pentagon. The Department must streamline the acquisition process to place high technology capabilities in the hands of warfighters more swiftly and at lower cost. Lastly, the Department must use these reforms to transform military capabilities to meet future requirements.

This nation may discover that a transformed U.S. force structure will require even more resources. It may result in a capability baseline that is actually higher than that possessed by the current 2MTW construct. The transformation process will require a reprioritization of current resources. Ultimately, the result may be a larger force, or a smaller one, but the Commission is confident that it will be a *better* force. That is the crucial issue.

Section I. DoD Structural Reform

Structural reforms are critical to a healthy, lean, and effective Department of Defense. They rest upon five principles.

First, focus on *core competencies*. Government organizations must concentrate on core competencies, must divest themselves of non-core activities, and should outsource or privatize support functions clearly appropriate to the private sector.

Second, establish *clear lines of authority*. Organizations function best with clearly defined roles and responsibilities. This helps to eliminate redundancy, duplication of effort, micro management, and the constant revisiting of minor decisions. It also elevates strategic alternatives to senior decision-makers.

Third, become *lean*. Lean organizations are the most productive. Excessive management layers adds costly overhead, increases complexity, inhibits speed, and contributes to duplication of effort and confusion of functions.

Fourth, *simplify processes*. Organizations focused on timely, meaningful outputs do not use overly complex processes encumbered in regulations and red tape. Processes in effective organizations are simple and occur only as necessary.

Fifth, *embrace adaptiveness*. Organizations that recognize the need for constant change thrive on unpredictability, empower lower level managers, and develop processes to elevate problems and alternatives to senior managers. The structures and processes of adaptive organizations are responsive to external circumstances.

Innumerable commissions, governmental organizations, and individuals have studied DoD and then urged significant structural reform.¹ Two structural areas of DoD warrant major reform: deconflicting the roles and responsibilities of the major staffs, civil as well as military, within the Pentagon, and reforming DoD's infrastructure. This Addendum addresses these in turn.

A. Realign Staff Roles and Responsibilities

The NSSG recognizes the Department's efforts to introduce reform over the years. However, the Congress and the President, often working in concert, have imposed most meaningful reforms from the outside. Examples include the 1949, 1953, 1958, and 1986 Amendments to the original 1947 National Security Act. The Defense Reform Initiative (DRI) of 1997 serves as a good example of an attempt to reform DoD from "within." An external Defense Reform Task Force, chartered by the Secretary, primarily focused on reducing manpower within the Department by examining the major staffs (the OSD staff, the Joint Staff, the Service staffs, and CINC staffs) and Defense Agencies and field activities. An internal study conducted by OSD manpower (known as the Pang/Rossetti Task Force) complemented this effort. The final DRI report, published by the Department, reflected the Defense Reform Task Force's management emphasis, but proposed relatively modest bureaucratic realignments.² Many of the core

¹ These include GAO studies in 1976, 1978, 1996, 1999, and 2000, as well as the Rockefeller Committee, the Rice Defense Resource Management Study, the Packard Commission, the SASC study leading to Goldwater-Nichols, the Commission on Roles and Missions (CORM), the Hicks & Associates study, the Defense Reform Initiative (DRI), and the BENS Tail-to-Tooth Commission.

² William S. Cohen, "Defense Reform Initiative Report," November 1997

recommendations of the task force concerning reduced staffs, realigned functions, and restructured Defense Agencies disappeared as “too radical.”

The Pentagon chartered the Defense Management Council in December 1997 to oversee implementation of the DRI Report. It sought to improve DoD business practices and to convert defense staff work from “paper” to “electronic” tracking methods. It succeeded in divesting and

Many basic roles and responsibilities between the staffs still overlap, creating significant inefficiencies and impairing the Department’s strategic and organizational transformation.

realigning some DoD organizations, but few of the even modest structural reforms recommended in the final DRI Report ever occurred.³ Headquarters’ staffs are still large by comparison to civilian and governmental counterparts.⁴ While DoD has clarified many minor overlapping functions and processes listed in the DRI report, many basic roles and responsibilities between the staffs still overlap, creating significant inefficiencies and impairing the Department’s strategic and organizational transformation.⁵

The Cold War structure supported a large military oriented toward a potential war with the Soviet Union, and served as the mold for a particular DoD organizational structure. Today, however, there is no such focus and the DoD structure of staffs, agencies, commands, and military Services may not be the most efficient or effective structure for emerging threats and challenges. There is an ongoing debate in today’s defense arena and within the Department regarding the need to abet organizational change and innovation in DoD.

Prior efforts to accomplish organizational transformation within DoD have focused on three basic approaches. The first advocates shifting more authority and resources to Joint and/or OSD control (e.g. the Joint Staff, Defense Agencies, and the regional/functional Commanders-in-Chiefs (CINCs)) to assure that more “Jointness” is achieved—a *centralized approach*. The second attempts to retain or bolster semi-autonomous military Services, properly guided by an overarching strategy and an effective OSD decision-making and resource allocation process. The focus of this approach is to promote creativity, innovation, and overall effectiveness through competition—a *decentralized method*. The third popular approach tries to infuse “business management” structures into the Pentagon’s staff processes, using cross-functional, formal and informal “teams,” “boards,” and “councils”—*essentially a business matrix approach*. The current structure of DoD’s major staffs (and their functions) represents a meshwork of all three models, and the net result has been a diffusion of authority, responsibility, and accountability. In many

³ See the list of DRI Directives and Management Reform Memoranda posted at <http://www.defenselink.mil/dodreform/directives-memorandums>, and compare them to the DRI Report. The site reports that approximately 70 percent of the DRI Directives and Memoranda have been “implemented.” However not all the structural recommendations of the DRI Report were actually translated into DRI Directives. One ASD in USD(P) was disestablished, but its functions and most of its personnel were redistributed within USD(P). Consolidations recommended between USD(AT&L) and ASD/C3I have not occurred. Several OSD activities were divested to Defense Agencies, and some consolidation has been pursued within Defense Agencies and field activities. The Joint Staff has been divested of most Chairman-controlled activities, by transferring them to Joint Forces Command. Some reductions in CINC staffs are on-going, but primarily as a result of Congressional direction.

⁴ See GAO, “Defense Headquarters, Status of Efforts to Reduce Headquarters Personnel,” GAO/NSIAD-99-45, February 1999, GAO, “Defense Headquarters, Status of Efforts to Redefine and Reduce Headquarters Staff,” GAO/NSIAD-00-224, September 2000.

⁵ Examples of excess functional overlap within DoD include manpower, plans, readiness, and acquisition.

cases the three different paradigms work at cross-purposes to obstruct and block each other. This dilutes the Department's ability to transform itself internally. It hinders the identification of problems, the development of alternative solutions, and the elevation of decisions to senior officials for resolution. *A clearer vision needs to be adopted for DoD's major staffs.*

In the past few years the Department has undertaken organizational changes such as creating powerful Defense Agencies, empowering the Joint Warfighting Capability Assessment (JWCA) mechanism of the Joint Requirements Oversight Council (JROC), and establishing Joint Forces Command (JFC). At the same time that new organizations were created to respond to new threats, DoD met other demands within the framework of established organizations. For example, it strengthened the authority of the Undersecretary of Defense for Acquisition, Technology, and Logistics (USD/AT&L). Some suggest the nature of many of DoD's new missions and challenges require total reorganization around functions or capabilities, rather than Services.⁶ Efficiency and effectiveness, they argue, may be best realized if DoD takes on increasing responsibilities based on operational requirements and missions, centralizing the organization and authority under the Joint Staff and OSD and, as necessary, creating new organizations as extensions of the Joint Staff and OSD.

However, aggregating authority and weakening the organizational cultures of the Services may decrease overall effectiveness through over-centralization, lost managerial competence, and the loss of Service *esprit de corps*. The centralized approach may instill greater efficiency toward a unified end state, but less agility over the long run, less organizational commitment among Service personnel, and exacerbated civilian control could also result. Instead of solving the "problem" of interservice rivalry, the Joint/OSD control "solution" could just move Service competition into new or unintended arenas. Additionally, the loss of Service identities and organizational authority could decrease the advantages of inter-Service competition in critical areas such as doctrine development, research, and experimentation.

Aggregating authority and weakening the organizational cultures of the Services may decrease overall effectiveness.

The "business approach" borrows from the "Revolution in Business Affairs" (RBA), and is typified by the 1997 Defense Reform Initiative. This corporate management emphasis is enticing and appealing because it promises efficiency and savings. Unfortunately, it often has difficulty meshing with existing acquisition and PPBS authorities vested in different staff functions and organizations at various levels within DoD. The net result has been to diffuse accountability and decision-making authority, and the clash with existing organizational paradigms has to date not produced the anticipated benefits.

Defense reform must begin with DoD identifying its core competencies and assessing specific capabilities that various organizations within its structure need to perform. This would permit divestiture or realignment of many activities not related to core competencies, allow the use of performance goals to measure success, and encourage its constituent organizations to focus more on missions and outcomes. You cannot manage what you cannot measure, and very few organizations within the Pentagon have established performance goals.⁷

⁶ See William Owens, *Lifting the Fog of War*, (New York: Farrar, Straus, & Giroux, 2000).

⁷ See the 17 August 1999 letter from Senator Fred Thompson to Secretary of Defense Cohen, in *Inside the Pentagon*, 19 August 1999, and GAO Report B282836, "Observations on the Department of Defense Fiscal Year 2000 Performance Plan," 20 July 1999.

Based on a review of the core roles and responsibilities of the staffs of the Office of the Secretary of Defense, the Joint Staff, the Military Services, and CINCs, the Secretary of Defense should reorganize and reduce those staffs by 10 to 15 percent.⁸ The Department could develop a reorganization plan, as suggested here, in the first year of the new Administration, and implement it in the second and third year. Extending reform beyond three years serves no useful purpose, because it only would allow an entrenched bureaucracy to delay needed reforms.

The DoD bureaucracy complains about the current burden of tasking and is sure to resist efforts to further reduce staffing. For example, DoD has not even implemented current Congressional guidance to trim its staff personnel levels. The key to success lies in working four areas. First, reduce redundancy so that the appropriate functional staff is properly empowered to work problems, and ensure that efforts are not being duplicated elsewhere. Second, streamline the coordination and approval process for actions through improved processes and the removal of unnecessary staff layers. Third, eliminate nonproductive, self-imposed tasking. Much that occurs in the Pentagon on an annual basis could be either omitted or slipped into a biennial or even a quadrennial schedule. Lastly, the Congress should share responsibility for empowering Secretary Rumsfeld to accomplish this objective by eliminating unnecessary reporting requirements that justify larger staffs.

1. Staff of the Office of the Secretary of Defense

The staff of the Office of Secretary of Defense (OSD) is still approximately 30 percent larger than advertised because of billets and duties “hidden” within other agencies, and bodies masked by extensive contractor support.⁹ Even discounting contractors, OSD is still roughly 90 percent of its end-of-Cold War level, while the number of personnel in uniform is roughly 60 percent of the 1989 level. This results from staff duties remaining unchanged and intact, despite the overall force reductions, because of U.S. global commitments and Congressionally mandated reporting requirements. Another reason, however, is that the major staffs within the Pentagon (OSD, the Joint Staff, and the Services) typically have *six to seven layers* of management between action officers and the Secretary. Some staffs require such layering because of constant travel duties by the primary deputy, while legislation and Congressional pressure have added some functional billets. But the Pentagon should recognize many billets for what they are—places for political appointees and staff favorites in the Senior Executive Service (SES). Organizations should be required to justify why more than three or four layers of supervision are necessary to perform their function.

The proliferation of positions within OSD contributes to its sluggish pace. Since the mid-1980s, the time required to prepare a response to the Secretary has nearly tripled (thirty-nine days versus fourteen days), while over 50 percent of taskings are now completed “late” compared to 8 percent a decade and a half ago.¹⁰ The practice of requiring General Counsel review of *all*

⁸ This number was estimated as a “reasonable goal” by the Commission given post Cold War force structure reductions, similar mandates by the Congress, and the apparent layering and redundancy of staffs within the Pentagon. Streamlining the defense planning process, the QDR, and the Joint assessment process would assist the staff reductions. See the PPBS section below.

⁹ See GAO/NSIAD-99-45, and GAO/NSIAD-00-224.

¹⁰ Taskings logged by Correspondence and Directives Office during March-June period in one year from Secretary Weinburger to Secretary Cohen. True, there are many exceptions and explanations, mostly stemming from missions added to OSD, but the general trend is clear. Defense Reform Task Force Briefing, “Streamlining Central Support Management,” December 1997.

Secretarial actions, while necessary, adds further delay in a circumstance where fewer staff officers process far more items—and where the General Counsel rarely delegates authority.

Structural reform within the Department must begin by clearly defining basic roles and responsibilities for the various major players: OSD, the Joint Staff, the Services, and the CINCs. This is necessary because the evolution of joint warfighting and defense economics has shifted many past roles and responsibilities to joint and defense-wide activities. While “jointness” is generally a good thing, these new patterns further confuse DoD’s traditionally ill-defined divisions of labor.¹¹

Structural reform must begin by clearly defining basic roles and responsibilities.

OSD’s role is to establish policy, to provide advice to the Secretary, to integrate the defense program into a coherent whole, to allocate tasks and resources, to provide oversight, and to develop strategic alternatives meriting Secretary decisions. The role of the OSD staff, in particular, has become blurred because it has increasingly acquired a management habit focused on *what* is being done, and *how* it is being done, within its various functional areas, as well as attempting to manage many programs directly. At its current size, OSD is too small to manage the Service plans and programs it attempts to direct. Delegation of authority must occur, and OSD must hold the Joint Staff and the Services accountable for implementing Secretary Rumsfeld’s policy decisions. To the extent that OSD has to manage detailed plans and programs, it detracts from its primary responsibilities.¹²

The new Administration’s leadership must establish a new vision for OSD’s role in the Department, one that refocuses on its basic functions. OSD needs to improve its strategy and planning function, divest itself of direct reporting agencies, and eliminate both its hidden billets and its excessive management layers. *The Commission recommends that the Office of the Under Secretary of Defense for Policy (USD(P)) be restructured by: creating a new office of an assistant secretary dedicated to Strategy and Planning (S/P), and abolishing the office of assistant secretary for Special Operations and Low-Intensity Conflict (SOLIC).* A new office of Strategy and Planning would be responsible for the Defense Planning Guidance, which should tie the Department’s internal budgeting and weapons acquisition processes to strategic planning. This office would also support the Secretary of Defense in a National Security Council-led strategic planning process as well as the Joint Staff’s military contingency planning process.¹³

As stated above, the Commission also believes that a separate assistant secretary for SOLIC is no longer needed. Special operations are no longer an “orphan” among the Services. Moreover, they also possess a CINC to advocate SOLIC issues. Such activities are now widely integrated into U.S. strategy, plans, and forces, and the Department can and should address special operations in a fashion similar to other mature missions. Such change is also consistent with removing OSD from directly managing resources and programs.

A separate assistant secretary for SOLIC is no longer needed.

¹¹ “Directions for Defense,” Report of the Commission on Roles and Missions of the Armed Forces, 24 May 1995, p. 4-2.

¹² Examples of OSD program management include: Defense Airborne Reconnaissance Office, Cooperative Threat Reduction Program, Special Operations Program, Humanitarian Assistance Program, Counterdrug Program, De-mining Program, ACTD Oversight, and the POW/MIA office.

¹³ See “National Security Council” chapter in *Road Map for National Security: Addendum on Implementation*, USCNS/21, April 15, 2001.

To make OSD leaner and faster, and to keep taskings moving, the Office of the Secretary of Defense should also create a true “chief of staff”—similar to the Director of the Joint Staff. As currently structured, the OSD staff has no director (other than the Secretary, or the Deputy Secretary) to manage the cross flow taskings between a cadre of co-equal Under Secretaries, the Joint Staff, and the Services. While the Secretary of Defense has a number of designated military and civilian advisors, personal secretaries, and a “chief of staff” for his personal office, there is no single point of contact to coordinate the flow of paperwork to and from the Secretary. That is why the Joint Staff will generally process a Secretarial tasking faster than OSD. A civilian OSD “Director” or “Chief of Staff,” equal in rank to an assistant secretary would help solve this problem.

OSD’s analytic capabilities would improve if OSD’s Program Analysis and Evaluation (PA&E) directorate was aligned organizationally with the Major Force Programs. Because this proposed structural reform is minor, it is discussed below, in Section II, A, 7, relating to PPBS analysis. The Under Secretary of Defense for Policy (USD(P)) also requires a strong in-house analytical capability focused on the policy, planning, and resource allocation aspects of the PPBS process. OSD Net Assessment should be strengthened in its role to provide this analysis. Without an organic analytical capability, USD(P) often issues guidance without the benefit of being able to develop and analyze tradeoffs.¹⁴

2. The Joint Staff

The Joint Staff, too, has gone well beyond its core function of supporting the Chairman and the Joint Chiefs in their responsibilities, namely: *providing military advice to the Secretary; providing unified strategic direction for combatant forces; managing the strategic planning process; and insuring the integration and interoperability of the armed forces.* Several areas that require examination in the Joint Staff include the overlap between it and USD(P) on regional policy, as well as the overlap between the manpower functions of the Joint Staff, OSD, and the Services.

The Joint Staff has moved past its initial role of providing review and validation of military requirements, a role that has advanced somewhat the establishment of common interoperability requirements.¹⁵ In 1994 using Goldwater-Nichols authority, the Joint Staff

The Joint Staff’s assessments have actually slowed an already plodding decision process.

expanded its purview into programming and budgeting as required by legislation (U.S. Code Title 10, Section 153). Unfortunately, it largely duplicates OSD’s analytic efforts to evaluate defense programs in the PPBS process, and the Joint Staff’s assessments have actually slowed an already plodding decision process.¹⁶ Just recently, the Joint Staff tried to inject itself into Service personnel and health care programs and other

¹⁴ Some would argue that OSD Net Assessment currently provides this capability. While Net Assessment does support USD(P) in some areas, much of its effort is independent. Another alternative would be to transfer OSD PA&E from the Defense Comptroller to USD (P), which would have other drawbacks.

¹⁵ We refer in particular to the Joint Requirements Oversight Council (JROC) and the Joint Warfighting Capabilities Assessments (JWCA) process. See below under PPBS discussion. For a critique of interoperability see GAO Report, “Joint Military Operations: Weaknesses in DoD’s Process for Certifying C4I Systems’ Interoperability,” GAO/NSIAD-98-73, March 1998.

¹⁶ Frank Hoffman, “Goldwater-Nichols After a Decade,” in *The Emerging Strategic Environment, Challenges of the Twenty-First Century*, ed. Williamson Murray (Westport: Praeger, 1999).

defense infrastructure issues. As noted in the report of the Tail-to-Tooth Commission, “The size of the Joint Staff and OSD staff may have reached the point where their efforts in programming and budgeting are more duplicative than synergistic.”¹⁷ Much of the traditional “creative tension” between OSD and the Joint Staff has been lost, resulting in “homogenous” alternatives rising to the Secretary. The old truism holds, “If everyone is thinking alike, no one is really thinking at all.”

3. The Services

Goldwater-Nichols has reduced the operational focus of the Services, but by law they still have the obligation to *recruit, organize, train, and equip forces*. The Services should retain their role as custodians of military culture, training, education, and operational expertise within their particular environments. They possess the relevant expertise for this, and that expertise represents a decentralized competition for innovation in DoD that is often and inappropriately disparaged as “interservice rivalry.” Competition between the Services is good when it stimulates alternative solutions, military capabilities, and forces from which Secretary Rumsfeld can make decisions. But once reached, the Services should execute decisions and run programs to provide effective and efficient operational capabilities of unique forces that can jointly operate.

More importantly, the Services should remain the stewards of force structure, although not to the point where their posturing harms the overall defense program. The Services take the long view of requirements and force modernization, because they must support force structures over the full life cycles of personnel and equipment. The Service Secretaries should act as the principal agents of the Secretary of Defense in managing the military departments and acquisition programs. Service Secretaries need to be highly competent, informed managers and leaders, not individuals selected to satisfy political debts.¹⁸

Proposals to modify Service staff structures have ranged from recommendations to “eliminate” them to suggestions to “merge” the military and civilian staff components.¹⁹ Other proposals have suggested embedding them as Service “Undersecretaries” in the OSD staff. The NSSG advocates none of these measures. Embedding Service staffs in OSD would blur the relationship between OSD *oversight* and direct involvement in *program management*. Some entity needs to execute detailed Title 10 functions, and this entity should be the Services. The NSSG acknowledges, however, that unnecessary redundancies exist both within the Service staffs (between military and civilian secretariats), and between the Services, OSD, and the Joint Staff—particularly among personnel/manpower elements, but also in the areas of acquisition management, plans, and policy. Studies have shown that of all the principal staffs within the Pentagon, the Service staffs have reduced the most—by approximately 30 percent—although this was recently questioned.²⁰

Embedding Service staffs in OSD would blur the relationship between OSD *oversight* and direct involvement in *program management*.

¹⁷ M. Thomas Davis, “Changing PPBS,” BENS Tail-to-Tooth Commission Report, 4 December 2000, p.18.

¹⁸ Eliot Cohen, “Defending America in the Twenty-first Century,” *Foreign Affairs*, November/December 2000, pp. 51-53. See also, Paul Davis, David Gompert, Richard Hillestad, and Stuart Johnson, “Transforming the Force, Suggestions for DoD Strategy,” RAND Issue Paper 179, 1998, p. 5.

¹⁹ See Owens, *Lifting the Fog of War*, and CORM, “Directions for Defense,” pp. 4-23 to 4-25.

²⁰ The Pang/Rossetti Task Force, 1997 and 1998. But also see GAO/NSIAD-00-224.

Additional reductions may be possible, if a comprehensive review of *all* the principal staffs occurred. However, major savings would likely not appear unless additional defense-wide functions, such as acquisitions, were consolidated, or unless subordinate Service headquarters received the same close examination that could result in further consolidation and reduction. Some Services have made more progress than others in this latter area. Secretary Rumsfeld could incentivize the process by tasking the Services to examine every subordinate headquarters and agency. For every military or civilian staff or support position “cut,” OSD would add and fund one equivalent combat position.

4. The CINCs

The CINCs exercise command over assigned forces, focus on current operations and contingency planning, and advocate security issues within a region or a functional area. Like others in the defense establishment, CINC staffs have grown considerably in absolute numbers since the end of the Cold War, but their short-term focus has remained consistent. The CINC’s planning horizon rarely exceeds three years, and they remain advocates of readiness—often at the expense of long-term modernization—lest anything go wrong on their “watch.” The Joint Staff openly solicits the views of CINCs, because of the weight their support adds to Joint positions. Often overlooked, however, is the almost complete lack of analytic capability at CINC headquarters to make substantive program judgements. This is only matched by the small amount of time CINC staffs expend in examining programmatic issues. CINC input is important to DoD processes, but the Department must recognize their analytic limitations and not allow short-term concerns to prejudice long-term force modernization requirements.²¹

DoD needs to examine the number of sub-unified and component command headquarters under the CINC’s and limit the role of Joint Forces Command.

The Department also needs to examine the number of sub-unified and component command headquarters under the CINCs and limit the role of Joint Forces Command (JFCOM). The Joint Staff has divested many of its activities to JFCOM, while that command has recently received other missions to include, joint training, joint doctrine, joint experimentation, and Joint Task Force-Civil Support (JTF-CS) in the homeland security mission. Some experts also advocate tasking JFCOM to represent all CINCs in the requirements definition process. As the JFCOM commander also wears the SACLANT²² hat, a span of control problem looms. JFCOM’s portfolio is becoming too diverse, over-populated, and lacking in focus.

B. Reducing DoD’s Infrastructure

But realigning staffs is not enough. *The Secretary of Defense should establish a ten-year goal to reduce infrastructure cost by 20 to 25 percent through outsourcing and privatizing as many DoD support agencies and activities as possible.* Many current debates focus on the overall defense budget, but not on how to shift portions of the budget to meet combat needs. The primary effort should be on how to do business differently within DoD—how to solve problems, increase savings, and shift resources from DoD’s “tail” to its “teeth.” An internal

²¹ John Shalikashvili, “Keeping the Edge in Joint Operations,” in *Keeping the Edge, Managing Defense for the Future*, eds. Ashton Carter and John White, (Cambridge: Puritan Press, 2000), p. 43.

²² SACLANT is a North Atlantic Treaty Organization command. It is short for Supreme Allied Commander, Atlantic.

redistribution of DoD's supporting infrastructure can provide a significant percentage of modernization resources. Any person or function that is not fully used in a necessary, core role in the Department is a "misallocation" that slows down the Pentagon and retards transformation. Every General, who pretends to be a "businessman" within some Defense Agency that the Department could privatize, detracts from combat capabilities.

Most Defense Agencies place little emphasis on achieving performance goals or measuring meaningful outputs. A good example is the Defense Logistics Agency (DLA). DLA looks at its inventory and support to warfighters purely in terms of numbers and quotas, not in terms of a hierarchy of warfighter requirements. As such, because DLA is not 100 percent funded to meet all warfighter needs, it seeks to carry an inventory capable of filling the great majority, but not 100 percent, of customer needs. DLA's "metrics" are based on internal efficiencies, not support effectiveness. In DLA's practices, meeting 85 percent of needs is seen as an admirable metric. However, the 15 percent of inventory not stocked is often the most important and critical to customers tasked with achieving a military objective. When the most critical customer needs are not met, the customer will resort to buy arounds and other sources to meet its needs. This method bypasses DLA, which is not able to capture customer demands, and further exacerbates the problem. Additionally, the DLA field representative program is organized around business areas, not to solve warfighting problems. DLA field representatives tend not to have knowledge of the processes and capabilities of other business areas, nor are they aggressive in solving problems to address the needs of warfighters in the field.²³

DLA's "metrics" are based on internal efficiencies, not support effectiveness.

Worse yet, Defense Agencies suffer conflicting and often passive supervision by both OSD and the Services, while receiving strong advocacy from the Congress, which seeks to protect local constituent jobs and installations.²⁴ Several defense activities have combat support roles, but they poorly address the harmonization of business efficiency and combat support effectiveness in the current bureaucratic process. Approximately two dozen DoD-operated Defense Agencies and field activities exist, and these clearly outstrip any sensible management arrangement. Cost effectiveness analysis must be implemented to gain oversight of the linkages between the workload, the workforce, and the applied resources. This would allow restructuring decisions to be based on the measurement of performance value.²⁵

1. The Infrastructure Problem

Even conservative estimates suggest that nearly half of all defense resources (a minimum of 48 percent of personnel and 46 percent of budget) are consumed by DoD's infrastructure. Other estimates place this percentage as high as 60 percent.²⁶ Defense experts commonly referred to infrastructure as DoD's "tail," and define it as non-combat activities and support services, which operate from fixed locations (such as installation support,

²³ *DLA Combat Support Agency Review*, Booz, Allen & Hamilton, 1998, pp. IV-2 to IV-13.

²⁴ Judith Miller, "Implementing Change," in *Keeping the Edge*, pp. 290-291.

²⁵ A vehicle similar to the Army Workload and Performance System (AWPS) could be adopted to facilitate input/output measurement. See "Report of the Committee on Armed Services, House of Representative on H.R. 4205," Report 106-616, May 12, 2000, and briefing "Army Workload and Performance System," for the Assistant Secretary of the Army for Manpower and Reserve Affairs, February, 2001.

²⁶ GAO, "Defense Budget, Observations on Infrastructure Activities," GAO/NSIAD-97-127BR, April 1997. GAO, "Future Years Defense Program, Funding Increase and Planned Savings in FY2000 Program Are at Risk," GAO/NSIAD-00-11, November 1999.

central training, central medical, central logistics, acquisition infrastructure, central personnel, and central command, control, and communications). Approximately 50 percent of DoD's infrastructure falls into two categories—central logistics and installation support—and more than 75 percent of DoD's infrastructure resides within the Services. It is easy to get confused over “infrastructure” because infrastructure remains buried in both Defense Agencies and Service field activities. The accounts stretch across programs, and many budgeting elements are intermixed. No single office within OSD retains oversight of the defense infrastructure.

DoD's “tail-to-tooth” ratio is too large by any measure. Nearly 30 “division-equivalents” of support personnel (approximately 450,000 people) perform service and support functions

Nearly 30 “division-equivalents” of support personnel perform service and support functions similar to jobs in the civilian sector.

similar to jobs in the civilian sector. Despite the dedicated and hard working people in these jobs, much of their work falls far outside of DoD's core warfighting missions. The sharp end of the spear, the “teeth”—the infantry, armor, artillery, marines, sailors, and pilots job-coded into actual combat positions—constitutes barely 200,000 warfighters out of DoD's 2.0 million full-time military and civilian personnel. That means that there are almost four DoD civilians for every uniformed soldier, sailor, airman, or marine in the active combat units.

There are also nearly five uniformed military personnel in the “tail” for every individual assigned combat duty. The NSSG recognizes the logistics “tail-to-tooth” ratio of U.S. forces will never reach an absolute “one-to-one” ratio because of the power projection requirements of U.S. strategy, the current focus on precision weapons, and second-to-none support for our fighting forces. However, the Department and Services could probably reduce that ratio significantly through consolidation, outsourcing, and privatization.²⁷

Consuming approximately \$134 billion in FY2001, DoD's infrastructure constitutes the world's 31st largest GDP, ranking just between South Africa and Thailand.²⁸ It does not operate according to market forces, but rather functions under a bureaucratic planning and budgeting process, the acquisition process, DoD Instructions and Directives, and a system of congressionally-driven audits and investigations. Six of the top-ten “defense contractors” are Defense Agencies or field activities. For example, both the Defense Logistics Agency and defense health programs are larger than Lockheed Martin and the defense portions of Boeing; the Defense Commissary Agency (DeCA) is larger than Raytheon; and the Ballistic Missile Defense Organization (BMDO) is the same size as General Dynamics.²⁹

Business costs and practices within these agencies are not competitive compared with the civilian sector. For example, the Defense Finance and Accounting Service (DFAS) consumes

²⁷ Similar to the need for visibility over Defense Agencies, the infrastructure reengineering effort needs to be based on methods that better capture workloads, performance, and resources such as the Army Workload and Performance System. See section I, B, 3 below.

²⁸ “Defense Budget Materials, FY2001 Budget,” at <http://dtic.mil/comptroller/fy2001budget>. “The Defense Budget Scene,” briefing by Bruce Dauer, OSD Deputy Comptroller Program Budget, February 2000. GAO, “Future Years Defense Program, funding Increase and Planned Savings in FY2000 Program Are at Risk,” GAO/NSIAD-00-11, November 1999. “The World in 2000,” *The Economist*, (London: The Economist Intelligence Unit, December 1999).

²⁹ Based on 1999 contractor data and FY01 defense agency budgets including Defense Working Capital Fund (DWCF). Defense health based on Defense Health Programmed (DHP) portion of FY01 budget and excludes Service medical funding outside DHP. DISA and DFAS make up the remaining “six.” Arnold Punaro, “Keep the Tooth—Cut the Tail,” briefing to NDU QDR Symposium, 8 November 2000.

nearly one-third of DoD's total travel budget in administrative costs. In 1999, DFAS still charged approximately \$4 to process a simple civilian paycheck, when the private sector charged less than \$2 for a similar service, and some civilian companies have reduced the cost to twenty cents per paycheck.³⁰ OSD and the Services have tried to reduce these costs. DFAS, too, has struggled to merge the two dozen different accounting systems it inherited from DoD into a common electronic format. Unfortunately, all too much remains to be accomplished.

The Defense Information Systems Agency (DISA) like its DFAS cousin operates and maintains a DoD-owned information system that the Department could competitively outsource, despite its unique and secure requirements. The same is true for the Defense Contract Audit Agency (DCAA). There is no "unique" mission that DCAA and its nearly 3,000 auditors perform that a commercial auditing agency could not do under contract—probably more cheaply. A similar observation could be made for the approximately 13,000 auditors employed in the Defense Contract Management Command (DCMC) under the Defense Logistics Agency.

In the field, the Services continue to maintain redundant staffs and facilities for many types of common acquisition support activities. Consolidating acquisition functions into a unified organization under OSD or the Joint Staff enjoins the great risk of separating those functions from their operational elements and unique Service expertise. However, collocating similar program offices and consolidating particular acquisition support activities where wide duplication exists across Service lines, would enjoy considerable potential savings and represent the greatest opportunity to encourage cooperation. Co-location of program management offices should achieve the following: cut overhead; move the program manager's technical and business support functions into a single chain of command; and encourage joint adoption and use of common equipment and subsystems across Services.

Consolidating acquisition function into a unified organization under OSD or the Joint Staff enjoins the great risk of separating those functions from their operational elements and unique Service expertise.

2. The Defense Working Capital Fund

All too often, the Department erroneously treats Defense Agencies as a "free good" to the Services. Just because these largely business entities often have military leadership they are not "free." They receive their funding primarily through the Defense Working Capital Fund (DWCF), which often inhibits rational business decision-making, because it includes all overhead as well as "mobilization costs" in the rates charged for goods and services—costs the Services have to bear, but often feel are unfairly overpriced. "Mobilization costs" are associated with mobilization or surge capabilities needed for wartime operations. Excess or unutilized plant and equipment not considered a mobilization "requirement" is not supposed to be included in mobilization costs reimbursed to the DWCF. There are obvious disagreements between the Services and Defense Agencies as to what the actual mobilization "requirement" should be. The Defense Comptroller approves these costs, and Defense Agencies obviously try to include as much excess infrastructure as possible in this category.

³⁰ See Paul Taibl, "Outsourcing & Privatization of Defense Infrastructure, Case Studies: Defense Travel System and Military Family Housing," BENS Special Report, April 1997, p. 5. Thomas McInerney and Erik Pages, "Bolstering Military Strength by Downsizing the Pentagon," BENS, Winter 1997-1998, p. 3. Also see "Moving With the Times," *Jane's Defense Weekly*, 15 November 2000, pp. 20-23.

The DWCF also forces organizations to purchase through DWCF sources rather than locally, which in some cases distorts prices four to six fold. Moreover, DWCF pricing policy tends to be “linear” rather than distributing fixed costs among customers via an initial payment followed by incremental cost on a per work unit basis.³¹ The simple process of allowing the Services to purchase directly from cheaper, non-Defense Agency sources would introduce much needed competition into the entire system and force Defense Agencies into better business practices.

The DWCF needs reengineering to increase its effectiveness.

The DWCF needs reengineering to increase its effectiveness. The Department must remove unnecessary mobilization costs from DWCF rates for goods and services. The DWCF currently has four objectives: 1) to show full cost visibility including sunk and fixed costs; 2) to encourage competition between DWCF and commercial sources (A-76); 3) to stabilize defense programs by encouraging constant prices; and 4) to finance other defense costs indirectly when Congress is reluctant to do so by producing some “profit.” *The NSSG sees these objectives as conflicting and counter to market forces, and recommends that the DWCF concentrate on the first two of the above objectives.*

3. The A-76 Outsourcing Problem

Efforts to reduce infrastructure costs by “outsourcing” under OMB Circular A-76 guidelines have been somewhat successful, but disappointing to date.³² Under A-76 rules, DoD may award an outsource contract for support services to a private vendor only if the bid is more than 10 percent less than projected government costs. Government costs, however, are based on a hypothetical “Most Efficient Organization” (MEO), which is a paper estimate that ignores indirect and overhead costs. Nor does the process allow examination of past governmental performance, while all private sector bids must include such information. There are cases, moreover, in which employees, whose jobs depend upon the outcome of contract awards, preside over the competition process.³³ Many competitions deliberately avoid contract “bundling,” which achieves efficiencies across sectors and installations, and instead focus on breaking contracts up in piecemeal fashion so that they are unattractive to private sector contractors.

Moreover, the A-76 process itself is cumbersome and bureaucratic, often taking two to four years to complete. Between 1978 and 1994, DoD could only finalize 2,138 competitions—or less than 150 per year—involving approximately 90,000 positions. Under the Defense Reform Initiative, DoD expected to conduct 750 competitions per year through 2005. It hoped to convert approximately 230,000 positions and save \$11 billion over the Future Years Defense Program (FYDP), but with the same staff and funding level performing the competitions.³⁴ It is unlikely

³¹ Edward Keating and Susan Gates, “Defense Working Capital Fund Pricing Policies: Insights from the Defense Finance and Accounting Service,” RAND, MR-1066-DFAS, 1999.

³² See GAO, “DoD Competitive Sourcing, Lessons Learned System Could Enhance A-76 Study Process,” GAO/NSIAD-99-152, July 1999. GAO, “Defense Reform Initiative: Organization, Status, and Challenges,” GAO/NSIAD-99-87, 21 April 1999.

³³ Bill Landauer, “Contractors Back away from DoD Outsourcing,” *Federal Times*, 11 September 2000. Also see, “Report of the Acquisition Reform Working Group,” December 2000, pp. 7-8.

³⁴ GAO/NSIAD-99-152. BENS Update #9, “The Myth of Public-Private Competitions – OMB Circular A-76 and Other Obstacles to Change,” 23 January 1998. Also see Michael Lippitz, Sean O’Keefe, and John White, “Advancing the Revolution in Business Affairs,” in *Keeping the Edge*, pp. 165-202.

that DoD will achieve its outsourcing objectives given current systemic obstacles. *DoD and the Office of Management and Budget need to revamp Circular A-76 guidelines and competition.* This requires a Presidential directive to the OMB, which has resisted past A-76 changes. The aim must be to make the selection process quicker and competition more equitable.

The Congress has already injected itself into this issue, in the Defense Authorization Act for FY2001 and Public Law 106-398, October 30, 2000. It directed the Comptroller General of the United States to convene a panel of experts “to study the policies and procedures governing the transfer of commercial activities for the federal government” under A-76. The panel will have representatives from the GAO, DoD, private industry, federal labor organizations, and OMB, and must submit a report to the Congress by May 1, 2002.³⁵ The Administration would be wise to support solid recommendations that can improve the A-76 process.

4. Need for Common Visibility over Infrastructure

You cannot improve what you cannot define and measure. On the larger scale, DoD needs the ability to review the allocation of funds between “infrastructure” and “forces” within the different categories of the Major Force Programs (MFP). It also needs better horizontal visibility over activities that are truly “forces,” and activities that are truly “combat support,” and “service support.” This will require changes in MFP categories, as detailed later in this paper (see Section II, A, 7). The objective should be to maintain or improve productivity while reducing infrastructure. *In the OSD staff review, Secretary Rumsfeld should consider creating an Assistant Secretary of Defense from existing staff entities dedicated to monitoring the Department’s infrastructure; the Assistant Secretary could also assist in the restructuring effort.*³⁶

On the smaller scale, individual Program Elements and activities with the MFPs require detailed methods to capture workload costs and measure performance values to determine required trade offs. An effective infrastructure reduction effort within DoD must also include the military departments. DoD needs to develop clear and common definitions of what constitutes a “support activity.” Currently, different Military Departments define identical activities as both “support” and “non-support.” This prevents efficient contracting across sectors and functions. DoD needs to work directly with the Congress to reduce narrow legislative restrictions in certain sectors clearly intended to preserve civil service jobs. Prime examples of this include DFAS, fire fighting activities on defense installations, and military depot workloads. Tightly coupled with developing common definitions and policy, the Department and OMB need to revamp the Circular A-76 competition. Outsourcing will never achieve the desired level of savings under current procedures.³⁷ Only if the Department changes processes and puts systems in place to gain visibility over its inputs and outputs, will it be able to determine trade offs and develop a comprehensive plan to reduce its infrastructure costs.

DoD needs to develop clear and common definitions of what constitutes a “support activity.”

5. A Plan to Outsource and Privatize

³⁵ *Federal Register*, Vol. 66, No. 57, Friday, March 23, 2001, Notices, pp. 16245-6.

³⁶ Currently infrastructure issues are scattered between the military Services, USD (AT&L), ASD (C4I), and the Defense Agencies.

³⁷ Examples of recommended A-76 changes can be found in the CORM report, also the “Report of the Acquisition Reform Working Group,” pp. 7-8, and in Lippitz, O’Keefe, and White, “Advancing the Revolution in Business Affairs,” in *Keeping the Edge*.

Defense Agencies and field activities are “big business” and need to be treated as such. The Department should consolidate, outsource and privatize them into fewer, leaner organizations. They also must institute commercial business practices, create competition, and establish oversight of workload and performance outputs.³⁸ As noted by the Defense Reform Initiative, restructuring and reengineering are long, arduous campaigns that require many years for implementation to succeed.

Privatization means getting DoD out of the counterproductive process of competing with private industry.

Outsourcing represents an intermediate step toward privatizing those portions of DoD’s infrastructure that lack any combat support role. Outsourcing combines government ownership with the private contracting of various functions. Privatization means reducing government ownership and getting DoD out of the counterproductive process of competing with private industry. While outsourcing should aim at achieving 10 percent savings, privatization may achieve additional savings of 20 to 25 percent in some sectors. *For privatization to occur the NSSG recommends that DoD establish a future vision for defense infrastructure—essentially a plan to show the Congress where the completed effort stops.*

This plan should include: what would remain as government owned and operated; what would be outsourced; and what would be privatized. Those categories of Defense Agencies and field activities that should be *candidates* for consolidation, restructuring and reengineering under this plan are easy to identify. Intelligence, Acquisition, and Criminal Investigation should remain government owned and operated. On the other hand, the Department should outsource military health, personnel, DISA, and many support functions on local installations. DLA, DFAS, DCAA, and defense exchanges and commissaries (DeCA) are clear candidates for privatization. Privatizing exchanges and commissaries does not mean they “go away.” It simply means they become privately owned and operated on military installations. This privatization will not be easy, but it is absolutely necessary.

The plan should include a five-year roadmap on how to get to outsourcing, and a ten-year roadmap for getting to privatization. Consolidation and outsourcing will require detailed collaboration with the Congress and most likely another two rounds of Base Realignment and Closures (BRAC). The BRAC requirement exists, because DoD has already consolidated and reduced some support infrastructure within existing installations. Further consolidations must eliminate unused facilities and excess capacity, which will require base closures and reductions in civilian positions. Privatization will invite intense congressional scrutiny and may generate additional BRACs. But failure to correct DoD’s infrastructure imbalance could prove most injurious. For example, attempts to reduce costs by squeezing savings from the current system—without fundamentally restructuring that system—will eventually jeopardize adequate funding for core needs such as modernization and personnel.

Implementing structural change requires firm leadership from Secretary Rumsfeld. The Secretary of Defense and the President can direct many structural reforms *within* and *among* the DoD staffs. However, ***DoD’s infrastructure reduction should rely on a BRAC-like commission that reports to both the Legislative and Executive Branches.*** The Defense Reform Initiative effort within DoD, or something similar to it, could support analysis for the envisioned commission. The infrastructure reforms will undoubtedly require enabling legislation.

³⁸ The Army Workload and Performance System would be an excellent starting point.

DoD, like most large institutions, exhibits a change-resistant culture. It has difficulty anticipating and adapting to change. In an increasingly volatile world, this inherent resistance to change represents a dangerous vulnerability. Senior leaders must focus on leading change. It must be their highest priority and responsibility. Defense reform is a “journey” not a “destination.” It must be a continuous process directed and supported from the top. Leaders should employ techniques to break DoD’s attachment to the past. They should create a renewal process to identify the need for change by scanning the horizon, recommending changes to policies, programs, organizations, and procedures, and helping to implement those changes. Finally, they should sharpen DoD’s focus on missions and outcomes to facilitate the identification of the need for change.

Today’s complex, rapidly changing security environment has placed a premium on modern leadership skills and exposed the shortcomings of DoD’s 1960s-style management. Leaders must set strategic goals and motivate people to achieve them. DoD must create a leadership culture that values effective performance. *Secretary Rumsfeld must make leadership a selection criterion for senior DoD civilian positions, and increase the attention paid to leadership development.*³⁹

³⁹ Ideas to accomplish the latter are presented in the Commission’s “Civilian Personnel Reform” section of *Road Map for National Security: Addendum on Implementation*.

Section II. DoD Process Reform

Two major areas of DoD responsibility require major process reform: the planning and budgeting process, and the acquisition process. This Section addresses each in turn.

A. Reforming the PPBS Process

Other government departments and agencies often view DoD's Planning, Programming, and Budgeting System (PPBS) as a "model" strategic planning process, because it successfully provides detailed and logical budget data to the Congress. The process itself, however, is extremely complex, cumbersome, expensive, and time-consuming. Even more important, the system is not as logical as it seems. The real problems of the PPBS system do not lie in its complexity or how the process is executed. They lie much deeper.

The first is the "bottom-up" driven nature of the system, where budgets dominate planning, and programming.

Flowing from this, the second problem is the disproportionate weight senior leaders devote to budgeting versus strategic planning.

Third, the PPBS process fails to generate major options for change or elevate them to the Secretary for decision.

Fourth, the PPBS process is not focused on measuring "outputs."

Lastly, PPBS analysis mechanisms, which are used to evaluate capabilities across defense programs, are not useful decision tools, nor do they focus on future requirements.

The net result is that when left on "autopilot," the PPBS system endorses the status quo and blocks any significant effort at transformation. After describing how the PPBS system works, this section will discuss the above problems in turn.

1. How the PPBS Process Works – Theory and Reality

The PPBS is one of two key processes within the Department of Defense. At any given time, some aspect of the PPBS process is consuming a large part of OSD's activities, not to mention those of the Joint Staff and the Services. Secretary of Defense Robert McNamara instituted the PPBS process in 1961 to tie "ends" to "means," so that planners could relate the defense budget as a whole to national strategy in a sequential process of planning, programming, and budgeting. McNamara intended PPBS to enhance OSD's oversight by producing common measures horizontally across defense programs, so that he and his staff could examine outputs and evaluate strategic alternatives.

It is worth underlining that McNamara had just come to the position of Secretary of Defense from the Ford Motor Company. As such, McNamara cast the PPBS process very much in the mode of the top-down, highly bureaucratized approach that characterized the American automotive industry in the late 1950s. In other words, PPBS represents the philosophy of heavy industry in America of forty years ago—an approach that was soon challenged by leaner, more decentralized industrial regimes. PPBS created the original ten Major Force Programs (MFP) as the basis for matching defense missions (outputs) with defense resources (inputs). This mission

structure has been little changed since 1961, suggesting that the functions the DoD has to perform are also little changed. The only “major” change was in response to the 1987 Cohen-Nunn Amendment to the DoD Reorganization Act, which caused the Department to add an eleventh MFP category—Special Operations Forces.

Before one can identify its problems, one needs a brief description of PPBS to understand its intended, or theoretical, function. The purpose of PPBS is to produce a plan, a program, and a six-year budget for DoD, of which two years are “operable.” The entire process requires two years to complete (see Figure 1).

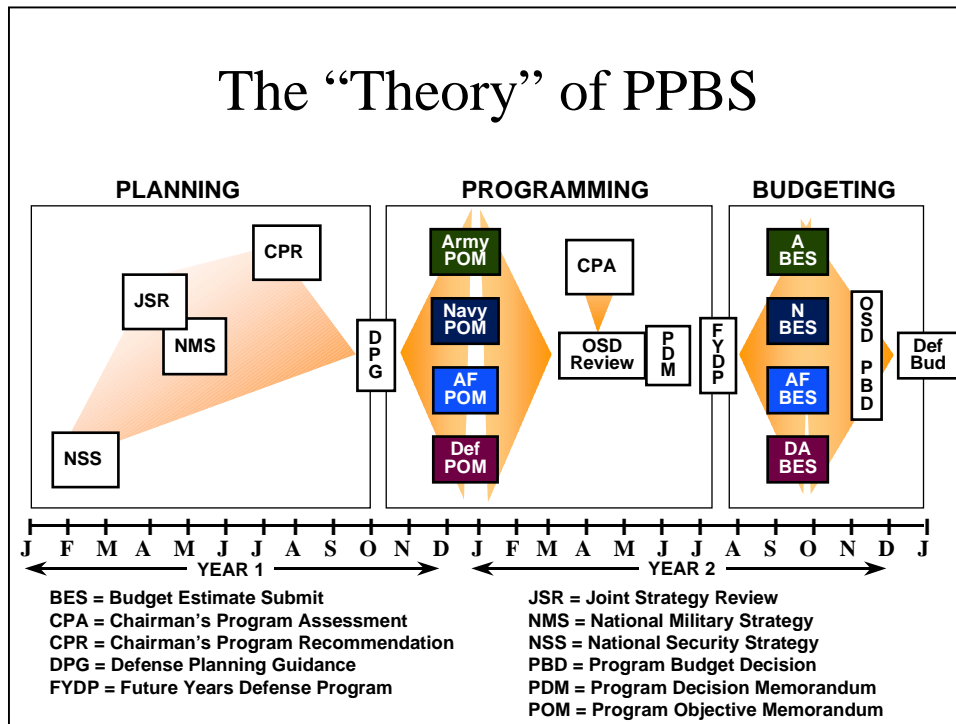

Figure 1. The “Theory” of PPBS ⁴⁰

The *planning* component of PPBS theoretically rests on the National Security Strategy and occurs from January to September of the first year. It incorporates several major processes. These include: the Joint Strategy Review (JSR), which the Chairman and Joint Staff control; and the Defense Planning Guidance (DPG), which OSD controls.⁴¹ While the Quadrennial Defense

⁴⁰ Courtesy of M. Thomas Davis, Northrop Grumman Corporation, 2000.

⁴¹ The JSR is used to assess the strategic environment, to make inputs into the Joint Strategic Capabilities Plan, and to lay the basis for the National Military Strategy written by the Chairman and approved by the Secretary of Defense. Joint planning is conducted biennially, and the National Military Strategy is updated as needed, usually every two to four years. The OSD-controlled DPG is produced biennially but updated annually. The DPG issues SecDef/OSD guidance to the military departments for development of the Service’s Program Objective Memorandums (POMs) (their program/budget plans). A Chairman’s input to the DPG is also made in the form of the Chairman’s Program Recommendations (CPR). The DPG includes: major planning issues and decisions; strategy and policy; the Secretary’s program planning objectives; the Defense Planning Estimate; and the Illustrative Planning Scenarios. The DPG is the major link between the planning and programming phases of PPBS. The DPG is controlled and led by the Undersecretary of Defense for Policy (USD(P)), but OSD (PA&E), under the Defense Comptroller (USD(C)), oversees the programming guidance in the DPG.

Review (QDR) is technically not a part of the PPBS process, it is part of the planning process, and thus for all intents and purposes is a part of PPBS

The *programming* phase of PPBS is supposed to follow the issuance of the DPG and theoretically occurs from October of year one through July of year two. The programming phase primarily focuses on an analysis of the Service Program Objective Memorandum or “POMs,” which the Services construct around the eleven Major Force Programs.⁴² OSD’s Program Analysis and Evaluation (PA&E) directorate evaluates the Service POMs through the “Issue Cycle” or “Program Review” from April through June of year two, to insure they comply with the DPG. The Joint Staff, through the Joint Warfighting Capabilities Assessment (JWCA) process, also evaluates the Service’s composite POMs by a different set of categories to assess their impact on joint warfighting.⁴³ The JWCA and several other inputs then serve to produce the Chairman’s Program Assessment (CPA) of the POMs, which his staff also submits during the “Issue Cycle.” The Services respond to the PA&E and the Chairman’s issues, which the Defense Resource Board (DRB) resolves. The programming phase then culminates with the release of a Program Decision Memorandum (PDM).

The *budgeting* phase of PPBS theoretically begins in July of year two as the POMs and PDM are repackaged into Budget Estimate Submissions (BESs) for the Defense Comptroller. The BES essentially “restacks” the POMs from the eleven Major Force Program categories into the accounting and funding elements used by the Congress. The Comptroller and OMB jointly review the BES in a series of hearings. The primary focus of the hearings is to make final adjustments based on current economic assumptions to insure the BES complies with the original budget guidance issued by OMB. Adjudications occur in a series of Program Budget Decisions (PBDs). The budgeting phase culminates with submission of the defense budget to OMB in December, and its subsequent release to the Congress in February of year two.

In reality, PPBS is overlapping, congruent, and compressed in execution. The annual budget appropriated by the Congress drives an “abbreviated” PPBS, a “DPG update,” and the creation of “mini-POMs” every year to update the two-year budget. Because of such “abbreviated” PPBS cycles, two PPBS phases are commonly running in the Pentagon at any given time, with their intended objectives becoming very indistinct. A process intended to be sequential, with each phase adding increased detail to the one before, becomes a series of simultaneous operations that are largely repetitive. For example, the planning during “year one” occurs with regard to the budget after next, while simultaneously, the budgeting during “year two” is occurring on the next year’s budget (see Figure 2).

Numerous other anomalies exist, and “work arounds” must occur to compensate for PPBS problems. For example, because the DPG is rarely delivered on time, Services construct their POMs based on circulated early “drafts” of the DPG. The DPG itself often lacks specificity or priority. Similarly, the Chairman’s Program Recommendations (CPR) often occurs too late to affect Service POM construction, and it also focuses on too many issues and minor details. Not

⁴² The MFP categories have been consistent since 1961, except for the addition of MPF 11. They are: 1) Strategic Forces, 2) General Purpose Forces, 3) Intelligence & Communications, 4) Airlift & Sealift, 5) National Guard & Reserve Forces, 6) Research & Development, 7) Central Supply & Maintenance, 8) Training, Medical, & Other, 9) Administration, 10) Support of Other Nations, and 11) Special Operations. OSD is conducting an internal study to review the eleven MFPs. See Table 1.

⁴³ The *newly proposed* JWCA categories are: 1) Strategic Deterrence, 2) Dominant Maneuver, 3) Precision Engagement, 4) Focused Logistics, 5) Full Dimensional Protection, 6) Intelligence, Surveillance & Reconnaissance, 7) Communications & Computers, and 8) Information Superiority. See Table 2.

surprisingly, the planning process moves as slowly today, as it did during the Cold War when PPBS focused on glacial changes in response to the Soviet threat. It normally required Presidential involvement or congressional dictates to induce DoD to examine major strategic alternatives or review roles and missions. In the absence of similar, senior-level involvement, the PPBS process alone is incapable of addressing the direction of future force modernization and strategy, such as aviation modernization needs across the services, space architectures, or different power projection alternatives.

In the absence of senior-level involvement, the PPBS process alone is incapable of addressing the direction of future force modernization.

During the programming review phase, the eleven Major Force Programs—originally introduced as OSD vehicles to analyze programs horizontally across the defense budget—have little influence on broad capability or mission outcomes. Objectives are not specified in the DPG for the MFPs, so how can progress be measured or analyzed? Thus, issues typically originate from modernization problems recognized and raised by the Defense Acquisition Board and injected by the Defense Planning Advisory Group—an entity composed primarily of USD(P), USD(AT&L), and PA&E representatives. The previously mentioned problems of overlap and duplication exist between OSD’s “Issue Cycle” review and the JWCA assessment.

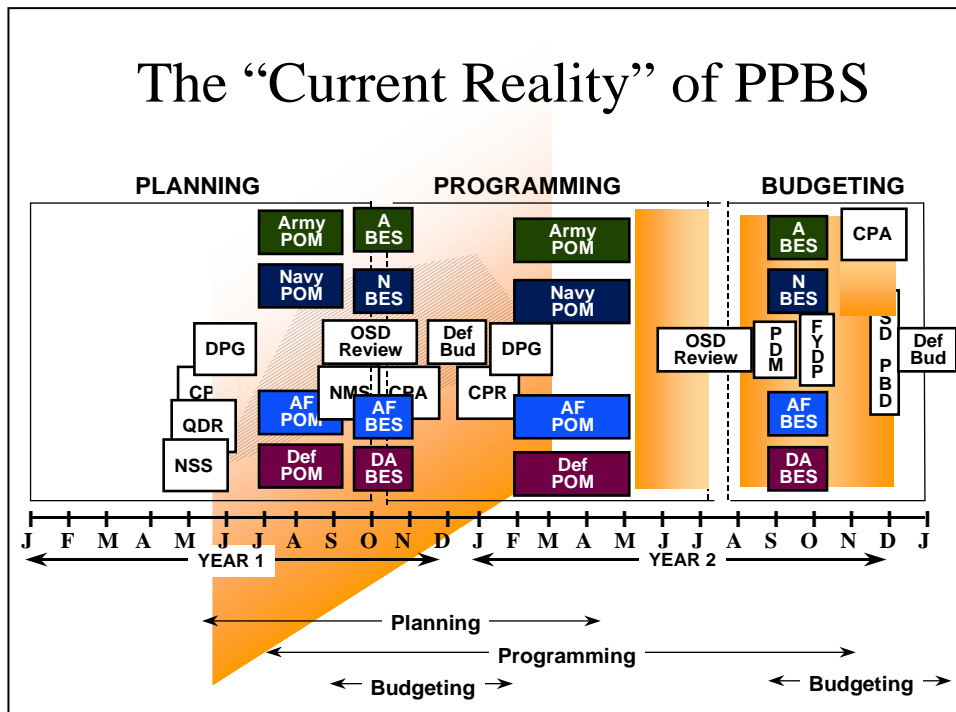

Figure 2. The “Current Reality” of PPBS ⁴⁴

The Pentagon expends a huge amount of effort during the “Issue Cycle.” Remarkably, however, total changes to Service programs commonly amount to as little as one percent of the total resources, reflecting a focus on minor issues of marginal value. This implies the Service and

⁴⁴ Courtesy of M. Thomas Davis, Northrop Grumman Corporation, 2000.

Defense Agency budgets were over 99 percent “correct” before OSD or the Joint Staff ever saw them.⁴⁵ In essence, the OSD and Joint review process moves “chump change” around. So much apparent “harmony” clearly reflects political and bureaucratic entrenchment, and an imbalance in the political weight of organizations involved in the review process. It is also evidence that the process is not fulfilling its intended function—identifying inefficiencies, tradeoffs, and alternatives.

This implies the Service and Defense Agency budgets were over 99 percent "correct" before OSD or the Joint Staff ever saw them.

The program review often starts too early—sometimes even before Services release their POMs—and is prolonged into the budgeting phase, because senior defense officials delay decisions and release a series of PDMs often extending into the budget review and the publication of the first PBDs. This delay in completing the program review occurs for two reasons: to identify unexecutable programs, and to get a sense of Congressional direction on key programs by waiting for the Congressional bill mark-ups on the previous year’s budget. Even though the number of delayed *significant* decisions is often “small” the total defense program remains in “flux” because of top line budget caps.⁴⁶

This, in turn, results in hurried and inaccurate adjustments to budgets and the Future Years Defense Program (FYDP). The process also frequently disrupts long-term modernization plans during annual budget cycles, while minor details receive inordinate attention. Decision delays also affect the budgeting cycle as programmers and budgeters reconcile and recompile programs. Because the defense budget is so large, OMB must become involved much earlier and work informally with the Services and OSD on the POMs. Thus OMB is aware of POM content and implications of changes resulting from the PDMs. This, and computerization of the PPBS process, are major factors that allow the budget process to be executed in a compressed period of time.

2. Adjusting the PPBS Cycle

Several studies have proposed “fixes” to the PPBS process by forcing it back into its original phases and timelines.⁴⁷ While such proposals solve the problem from the individual perspective of planners, programmers, or budgeters, they may not be necessary or even desirable for all the PPBS phases.

It is more important that PPBS connect to and flow from a national strategy and a strategic QDR process. The PPBS process must also orient in ways to conform to political reality and achieve better coordination between the civilian and military staffs. Certainly, portions of the DoD budget will remain annual in nature even if the Commission’s defense acquisition proposals are adopted (see below). Thus, it is unrealistic to attempt to “force fit” the final budget decision

⁴⁵ BENS Tail-to-Tooth Commission, “Framing the Problem of PPBS,” January 2000, p. 21. Available at: <http://www.bens.aa.psiweb.com/pubs/srPPBS.html>. We recognize of course, that a significant portion of the defense budget being “locked in” as non-discretionary funding influences this statistic.

⁴⁶ M. Thomas Davis, *Managing Defense After the Cold War*, Center for Strategic and Budgetary Assessments, June 1997, pp. 23-25. The number of Congressional “changes” in the defense mark ups have averaged over 1,600 in recent years across a total of 5,000 programs. However, the number of significant changes normally impacts about 4 to 5 percent of programs.

⁴⁷ See, *Ibid.* and the two BENS studies on PPBS: “Framing the Problem of PPBS,” January 2000, and “Changing PPBS,” December 2000.

process in the executive branch into a straight jacket that ignores the resource decision process occurring in the legislative branch. The impact between annual budgets is simply too great and executive decision-makers have consistently shown they are unwilling to make potentially premature decisions on upcoming budgets that Congressional mark-ups on programs in the previous year's budget could render moot.

Moreover, it is often unnecessary to force such firm, early decisions, as long as they are preceded by sound strategic guidance and planning. When Secretary McNamara originally designed the PPBS process in the 1960s, two factors existed. First, the Congress rarely delved into programmatic details, which resulted in less reprogramming and rescheduling within DoD's annual budgets. And second, the distinct four to five month "budgeting phase" was a real

Clearly, major decisions need to be faced and addressed well before OMB publishes tabular data.

requirement driven by the need to translate DoD's program estimates into the Congressionally mandated budgeting elements. It was a tedious, manual process. Modern computers now make it possible to compress the programming and budgeting phases, allowing DoD to take account of Congressional action before a new budget is fully formulated. But clearly, major decisions need to be faced and addressed well before OMB

publishes tabular data for submission to the Congress. If the Commission's recommendations for a two-year modernization budget and increased use of multi-year procurement were to become a reality, the problem would be alleviated even more.

The PPBS calendar should be revamped, but in the following way. OSD would issue policy and planning guidance (the DPG) biennially, prior to when the Services start building their initial programs and budgets. The Joint Staff and OSD would develop the most critical issues for review by the Secretary in the April to August time frame. While many issues could be resolved, the process would postpone some final decisions until after the Congress had done its markup of the previous year's budget, so as to integrate their decisions into the upcoming budget. Presidential approval would occur by the end of the year. Thus, planning needs to be done less frequently and in greater detail, and a budget has to be turned in by the first week of February. However the dates between planning and budget submission do not need to be too rigid, and not all budget decisions need to be sequential.

3. PPBS Lacks "Top-Down" Guidance and is "Bottom-Up" Driven

The NSS is not a "strategy" document at all, but a ritual "policy" wish list that does not relate ends to means.

Theoretically, PPBS is top-down driven, from the National Security Strategy (NSS) to both the National Military Strategy (NMS) and the DPG. The Goldwater-Nichols Act requires an annual NSS, which supposedly depicts the President's broad national security directions for the United States. Required by law each January, the document is habitually late, and it never prioritizes its objectives and goals.⁴⁸ By this Commission's definition, the NSS is not a "strategy" document at all, but a ritual "policy" wish list that does not relate ends to means.

⁴⁸ William Clinton, "A National Security Strategy for a New Century," The White House, December 1999. For example the publishing dates have been: 1993-January, 1994-July, 1995-February, 1996-February, 1997-May, 1998-October, 1999-December (the 1999 NSS was actually released in January 2000 but was backdated to December 1999).

Astonishingly, the NSS remains uncoordinated, even in draft form, with the key keepers of means—namely, the Congress.

Outwardly the supposed “top-to-bottom” approach looks sound. For example, the May 1997 version of the NSS contained the first reference to a “Shape, Respond, Prepare Now” strategic approach. As expected, the May 1997 Quadrennial Defense Review (QDR) and the October 1997 National Military Strategy mirrored the “Shape, Respond, Prepare Now” approach of the 1997 NSS. “Shape, Respond, Prepare Now,” along with the Two Major Theater War (2MTW) requirement, has become pivotal in recent strategic planning—strengthened in subsequent versions of the NSS and the NMS.⁴⁹

But appearances can deceive. The “Shape, Respond, Prepare Now” strategy was actually developed in DoD in the December 1996 QDR work up, and then OSD fed it into draft versions of the 1997 NSS.⁵⁰ This provided political top cover to the QDR and insured the appearance of a linkage between the National Security Strategy on one hand and the National Military Strategy and QDR on the other. What it really demonstrates is how “bottom-up” the strategy process has become. The 1997 QDR failed to address adequately the resource constraints associated with modernization and largely justified legacy force structures.⁵¹ This “bottom-to-top” linkage has since become even tighter as the Defense Planning Guidance (DPG) is now restructured around the “Shape, Prepare, Respond Now” approach.⁵² In theory, every Pentagon program is linked to and “justified” by the NSS. In practice, DoD has created an interlocking, essentially self-referential planning process that does little more than protect existing force structures.

DoD has created an interlocking, essentially self-referential planning process that does little more than protect existing force structures.

4. Involving Senior Defense Leadership in Strategic Planning

Numerous studies have highlighted the need to improve strategy and planning in PPBS and lamented the dominance of budgeting. One of the most debilitating effects of the process is that senior leaders devote a disproportionate weight of effort to budgeting versus strategic planning. Moreover, planning often neglects to acknowledge resource constraints and fails to balance readiness and modernization requirements. The DPG does not articulate a clear vision of the future and rarely reflects relative priorities. Rather than providing broad guidance with measurable objectives, it often delves into mundane program details.

The PPBS process fails to provide the Secretary with the means to guide defense decision processes strategically and has contributed to the Department’s tendency to replicate legacy force structure. In the Commission’s view, planning improvements must start with the National

⁴⁹ John M. Shalikashvili, “National Military Strategy,” 26 January 1999, at <http://www.dtic.mil/jcs/nms/>. Prior to this, the NMS had been updated in February 1995 and October 1997.

⁵⁰ See, GAO, “Quadrennial Defense Review, Opportunities to Improve the Next Review,” GAO/NSIAD-98-155, June 1998, and James Thomason, Paul Richanbach, Sharon Fiore, and Deborah Christie, “Quadrennial Review Process: Lessons Learned from the 1997 Review and Options for the Future,” IDA Paper P-3402, August 1998.

⁵¹ William Cohen, “Report of the Quadrennial Defense Review,” May 1997 at <http://www.defenselink.mil/pubs/qdr>.

⁵² Department of Defense, “Defense Planning Guidance, Update for Fiscal Years 2001-2005,” April 1999, SECRET, from Unclassified “Contents” page, p. v.

Security Strategy and our recommendation to create a national security planning and budgeting process with guidance from the President. This must continue through DoD's planning documents—the National Military Strategy and the Defense Planning Guidance. All strategic planning must rest on sound strategic objectives, and the DPG, which remains classified and rarely released outside the Pentagon, should reflect relative priorities so that programmers and budgeters know what is and is not important. This requires senior defense officials to work with the Defense Planning Advisory Group, and become involved up front in the planning process—issuing better guidance at the beginning, rather than spending the bulk of their effort working the budget after the fact.

In the main Phase III report, the Commission also proposed a major change aimed at getting Secretary Rumsfeld and his staff involved directly in the strategic planning process. *We recommended that the Congress and the Secretary move the QDR to the second year of an administration*, and use the QDR as a foundation for the PPBS process.

The current timing and political appointment process simply does not allow an incoming Administration to develop guidance that can usefully influence the QDR.

The current QDR timing, coupled to the political appointment process, simply does not allow an incoming Administration to develop guidance that can usefully influence the QDR. If not moved, the QDR will become captive to the Joint Staff and the previous Administration, instead of a tool to examine basic issues by Secretary Rumsfeld and key appointees. As currently structured the DoD civilian and military bureaucracy has ascertained that they can best preserve the status quo by not having the QDR strongly tied to key decision-makers. Concurrently, decision-makers have figured out that they have no real stake in the QDR, and as a result largely ignore it within the PPBS decision process. The 1997 QDR essentially evaded the “ends” to “means” mismatch by assuming resource savings from a BRAC process that was “dead in the water” politically. Thus the QDR, as currently structured, is basically useless and gives the defense planning system a documented plan to parse resources along traditional lines versus a plan to transform and employ our strengths.

As long as the Department has the current QDR approach to fall back on, it will not do the heavy lifting required to transform our military capabilities. The current “Rumsfeld Strategic Review” will surely impact the QDR. In fact it could either severely truncate the QDR or even substitute for it in some ways. Criticism of the 1997 QDR led the Department to establish a 2001 QDR Working Group under the aegis of the Institute for National Strategic Studies at National Defense University. The purpose of this group was to develop methodologies, assumptions, and recommendation to “jump start” the 2001 QDR.⁵³ The QDR Working Group was also created to help overcome the obstacle of an incoming Administration having to provide a final QDR report to Congress by September 2001.

This Commission recognizes that delaying the QDR by a few months would not appreciably correct the problem, because its results would occur too late to mesh with the PPBS program review process and subsequent budget. The best way to make the next QDR relevant to the incoming administration would be to convene the review in October of 2001, after

⁵³ See “Report of the National Defense University Quadrennial Defense Review 2001 Working Group,” Institute for National Strategic Studies, November 2000, and Michele A. Flournoy, ed. *QDR 2001: Strategy-Driven Choices for America's Security*, (Wash D.C.: NDU Press, 2001).

the majority of political appointees are in place. The QDR would then aim at a completion date of May 2002 in time to influence the “second” **developed** budget.⁵⁴ If the QDR remains in the first year, the QDR analysis or “results” will most likely be altered to coincide with and collaborate the amended FY2002 budget. In this case the budget will clearly drive the QDR. Moving the QDR to the second year of an Administration, means the first budget that is developed would not be informed by the QDR, and it would actually impact the “second” budget of an Administration. The objective would be to complete the QDR in time to inform subsequent PPBS cycles. The Commission recognizes the disadvantage of delaying the QDR, but believes the delay is the lesser of two evils, if the QDR is to become a useful tool for defense planning.

The most critical step to turn this situation around is for the Secretary of Defense to produce defense policy and planning guidance that defines specific goals and establishes relative priorities. This Secretarial guidance would provide the basis for defining the nation’s National Military Strategy, conducting the Quadrennial Defense Review (QDR), and writing the Defense Planning Guidance. His initial guidance must conform to the President’s national security planning and budget guidance issued in the February-to-March time frame of the incoming Administration. The current “Rumsfeld Strategic Review” will obviously influence QDR guidance.

The Commission proposes another change to improve the QDR process. *Those conducting the review should aim at defining defense modernization requirements for two distinct planning horizons: near-term (one to three years) and long-term (four to fifteen years).* The CINCs should have primary influence on readiness issues in the near-term execution horizon. The Services themselves should then focus on modernization, personnel, and infrastructure throughout the long-term planning horizon. The Joint Staff should focus on joint issues and force interoperability planning. The OSD staff would exercise broad oversight and ensure that QDR planning followed the President’s and Secretary’s strategic guidance as well as rest on realistic political and resource assumptions. The planning process must reflect the various institutional interests and expertise of the major players in the Department, but it must also balance near- and far-term requirements. The Department need not repeat strategic planning every year. If a strategic plan must change each year, it is probably not crafted correctly.

If a strategic plan must change each year, it is probably not crafted correctly.

If the QDR occurs every four years, *the NSSG believes the DPG should go from an annually updated document to a truly biennial process.* This alone would cut current planning efforts in the Pentagon considerably and allow senior leaders to develop prioritized, objective guidance for the DPG. The biennial DPG should reflect decisions from the President and the Secretary as mirrored and developed in the QDR. The program review phase should measure progress in achieving DPG objectives, with a particular emphasis on innovation, modernization, and promising transformation alternatives. At the same time, such an approach would generate senior DoD involvement prior to the budget process.

⁵⁴ To be clear, we define an Administration’s “first” defense budget as the first budget it **develops**, not as the first budget it **executes**. While the Bush Administration will attempt to make some changes to the Clinton FY2002 Budget developed last year, and will work with the Congress on many changes, it primarily executes the budget submitted by DoD from the previous Administration.

5. Developing and Elevating Alternatives via the PPBS

In the NSSG’s view, the greatest strategic problem with the PPBS process is that it fails to develop and elevate realistic and important alternatives over the direction of future force modernization and strategy to senior decision-makers. The “Issue Cycle” focuses on minor programmatic details rather than significant alternatives. Despite the end of the Cold War, the PPBS process is not using the Major Force Program categories for analysis of issues, nor has it revised the MFPs as to their applicability—although OSD is in the process of “studying” such a revision.⁵⁵ Thus there is little horizontal visibility to identify programming compliance with *future requirements*. PA&E, while responsible for the issue cycle, no longer serves its intended function of providing strategic horizontal visibility across defense programs.

Despite all efforts to improve “Jointness,” despite all the analyses, despite Congressional prodding, and despite all the efforts of PPBS, DoD rarely focuses on developing serious alternatives that could alter force structures to function in future national security environments. Alternatives, for example, over future force modernization required by aviation across the services, or power projection alternatives, receive endless discussion, but never get injected into the PPBS process for decision. Despite the end of the Cold War and the emergence of a newer, less certain strategic environment, the percentage of Total Obligation Authority (TOA) allotted to the Services has not appreciably changed over the past ten years.⁵⁶ Force structure changes are minor, programs remain essentially the same, and the modernization bow wave pushes farther into the future. The current bureaucratic process grinds stark alternatives into homogenous mush.

Clearly, the Secretary of Defense must reform OSD first, and then direct changes in the PPBS process. OSD must take a central role in running a reformed PPBS process. A major focus

A major focus in PPBS should be on generating alternatives for senior decision-makers.

in the PPBS should be on generating alternatives for senior decision-makers. Attempts to alter the status quo have been most frequently made through the plans and policy route. The more effective attack axis, however, is through the ultimate OSD weapon, the resource allocation tool—by leveraging the Golden Rule... “He who controls the gold sets the rules.” If OSD were truly in the resource allocation role and performed this task in a visionary up front manner that was linked to its strategic direction responsibility, the budgeting entities would then be obliged to conform to the established direction. A viable method to accomplish this would be the introduction of competition for the allocation of Total Obligational Authority (TOA) among the Services by OSD during the QDR. Thus, for the Department to develop true strategic alternatives, it will need to focus on resources. *We recommend that the Secretary of Defense introduce a new process that would require the Services to compete for the allocation of some resources within the overall defense budget.*

A structured process of competition for resources, moored within the QDR process, and focused on the allocation of TOA, can change this. One possible way to accomplish such a competition would be for OSD to retain 5 to 10 percent of the TOA and then reallocate that percentage during the QDR to promising *systems* and initiatives—be they those of the Services, DARPA, or Joint programs.⁵⁷ This could be accomplished when OSD PA&E produces the Fiscal

⁵⁵ The eleven MFP categories are listed below in Table 1, while the JWCA categories are listed in Table 2.

⁵⁶ Those percentages are: Army 24 percent, Navy 32 percent, Air Force 30 percent, and Defense Agencies 14 percent.

⁵⁷ The Commission assumes that such systems and initiatives should meet clearly defined joint interoperable standards.

Guidance document in mid-March of the QDR year.⁵⁸ Secretary Rumsfeld and his OSD staff must accompany their TOA holdback with an effort to identify high priority programs that fill key strategic requirements. This is necessary to insure funding for strategic lift and space programs, as well as joint interoperability programs, such as C4ISR.⁵⁹ In this QDR process, the Services and Defense Agencies would naturally have to identify their highest and lowest priority programs.⁶⁰ This would give the Secretary a vehicle to kill low priority programs and begin the process of reallocating funds to more promising areas during subsequent PPBS cycles.⁶¹ The Defense Planning Guidance would reflect the Secretary's QDR decisions, while future "Issue Cycles" within the PPBS would measure progress toward achieving these decisions.

For any TOA reallocation process to be viable, two things must happen. First, Secretary Rumsfeld must rely on his OSD staff—not only on the Service and Joint Staffs. Second, the OSD staff will need to coordinate the analysis that informs the discussion of the alternatives. The internal reforms of OSD will prove key to the accomplishment of these tasks.

On the first point, some would argue against TOA competition in the QDR on the grounds that it would increase "interservice rivalry." The NSSG rejects this view. The passage of the Goldwater-Nichols Defense Reorganization Act of 1986 restructured power within the Joint Chiefs and deliberately tried to emphasize "jointness" by muting interservice rivalry. Unfortunately, some have transformed this jointness into to *de facto* political correctness and reduced not only rivalry, but constructive competition as well.⁶² It is interesting, that American culture holds competition to be a good thing in all aspects of human endeavor, except when it occurs between the military Services. There it is derisively viewed as parochialism. This model of de-emphasizing competition does not serve any constructive purpose.

American culture holds competition to be a good thing in all aspects of human endeavor, except when it occurs between the military Services.

The Services are essential to the American way of war. The nation needs them and cannot forego them even if it wanted to. It would go beyond bad management to bad judgement. Moreover, the Services cannot be eliminated or transformed into some sort of non-competitive, functional entities. They are honored institutions with large constituencies that would go to the barricades to preserve them. Who would want to expend the enormous political capital necessary to even start that process? The Services, as they now exist, have the history, institutional memory, and expertise for what it takes to fight in a given specialized environment—ground, sea, air, or littoral. While the Services tend to resist change, they contain the repository of knowledge necessary to evolve the U.S. military in a fashion most likely to maintain American military

⁵⁸ PA&E's Fiscal Guidance (FG) precedes OMB's release of "budget preparation guidance" in June. The FG is an internal DoD document not sanctioned by OMB, although OMB is aware of its contents. The FG is conservative and usually assumes a zero percent growth. It starts the bottom-up POM building process.

⁵⁹ C4ISR is a DoD acronym meaning "Command, Control, Communications, Computers, Intelligence, Surveillance, and Reconnaissance."

⁶⁰ Note the Services and Defense Agencies must identify "programs" not "funds." Otherwise they will stretch programmed procurement to free budget year "funds," but increasing future unit costs.

⁶¹ David Chu, "Sustaining Innovation in the Military," OSD Net Assessment Summer Study, 1996.

⁶² This is not a statement against "jointness." It is an observation, however, that degrees of competition between the Services still exist in other forms, and can be constructive if they do not disrupt the necessary synergies required to conduct joint operations.

superiority. The trick is not to eliminate or suppress that competitive spirit, but to harness it to DoD's strategic planning process.

How can one stimulate competition and innovation without wasting energy and resources on inter-Service battles? First strong civilian leadership must begin with a sense of what the nation actually needs in the emerging security environment. Second, civilian leaders must realize

Competition implies making hard resource decision that create winners and losers.

that competition implies making hard resource decisions that create winners and losers. They must accept that the TOA fraction historically provided to each Service might need to change.⁶³ Third, the civilian leadership, with a firm idea of what capabilities it feels the United States needs, could establish a competitive framework to select those systems that best produce the requisite capabilities. Lastly, the

department would withhold a certain fraction of the annual defense budget, as noted above, to award to the Service(s) providing the most plausible and supportable options, based on good judgement and analysis. Competition between the Services is good to the point where the QDR makes basic decisions. Then, the Services should execute policy and run programs.

The second prerequisite for a viable QDR rests upon developing a methodology and improved analysis to conduct the TOA competition. The NDU QDR 2001 Working Group provides some useful insight for a strategy-driven methodology, but unfortunately they proposed no competition and the assumptions imbedded within their framework severely limited the resulting alternatives.⁶⁴ Conducting TOA competition in the QDR is no easy task. Undoubtedly the Services will object to any method, structure, rule, or analysis mechanism that they perceive as disadvantageous, and likewise the Services will advocate analysis vehicles that provide them a competitive edge. The solution is to develop a methodology based on "output" oriented objectives tied to mission areas. This in turn requires revising the Major Force Program categories, and developing systems that measure input/output productivity to conduct tradeoff analysis. (See below)

If the QDR performed a thorough analysis and the Services developed major alternatives to meet mission outputs requirements, different TOA shares would presumably flow to different Services and agencies. TOA distribution would then reflect decisions that mirrored Service

Currently there is no TOA change, because OSD has no technique for redistribution, no basis to do so, and no mechanism for Service competition on major issues.

success or failure in "competing." Currently there is no TOA change, because OSD has no technique for redistribution, no basis to do so, and no mechanism for Service competition on major issues. In the NSSG's view, TOA competition should not be an annual process. That would prove much too disruptive to program stability and could invite too much interservice competition. On the other hand it does lend itself to a quadrennial process that provides the incentive and the cover for the Services to compete. In

the end, OSD and Secretary Rumsfeld need to be the final decision authority.⁶⁵

⁶³ They would do well to examine President Eisenhower's methods of defense reform in the 1950's. See Dwight D. Eisenhower, *The White House Years: Mandate for Change, 1953-1956* (New York: Doubleday & Company, 1963), pp. 445-58.

⁶⁴ All four "Defense Strategy Alternatives" were based on maintaining the 2MTW construct—some with more risk. See Flournoy, *QDR 2001*, pp. 353-62.

⁶⁵ Davis, *Managing Defense After the Cold War*, pp. 33-40

6. Output Focus with Joint and CINC Funding

Today, the Department’s PPBS process and fiscal functions are at best a poorly structured ledger entry and journal-oriented accounting system. It knows the *cost* of countless disconnected and unrelated pieces (program elements) but not the *value* of the various purposes of the enterprise. This state of affairs results from the Department’s focus on “inputs” versus “outputs.” Then Secretary of Defense Robert McNamara took a first cut at the problem in 1961 by setting up the basic PPBS process with its various program elements, but the Department stopped there. This archaic, industrial-age system has persisted, still mired in the 1960s. For example, the Department can point to any number of program element codes associated with tactical systems, but it cannot evaluate the price of tactical operations—it does not think that way, nor does it set up and aggregate program accounts in that fashion. Nor does the Department possess the means to measure progress toward achieving *any* objectives. The current Defense Planning Guidance does not specify objectives or priorities, nor do the current Major Force Program categories in the PPBS process lend themselves to analysis by useful mission area. With no missions or objectives specified, the Department cannot measure meaningful “outputs.”

Several years ago, a Defense Science Board (DSB) study suggested that the Department set up an “input-output” style resource table. Such a table would have the various DoD (military Service) organizations arrayed along the ordinate, and the various output organizations (CINCs) along the abscissa, with the right vertical column totaling to the overall DoD budget at the bottom. The DSB’s notion was to construct better methods to grasp the true costs of task execution, with further potential drill-downs contemplated to peel away the layers and improve understanding. When this idea was carried forward, the Services and the Joint Staff uniformly recoiled from such a relatively small change. Admittedly, the effort would have been very difficult, but that was certainly not justification for rejecting the proposal. In many ways, the Services do not want to know the answer, because such an answer would eventually pull together the true cost of providing particular functional outputs to the field. Once known, the door would be open to find newer, cheaper, and better ways to accomplish military tasks. As long as costs remain input-collected and functional costs are obscured, *military judgment* remains the sole entering argument—further assistance neither required nor desired.

As long as costs remain input-collected and functional costs are obscured, *military judgment* remains the sole entering argument.

This is a paradigm on its head. Every business wants to know what it costs to accomplish a task, produce a product, or provide a service—but DoD deliberately chooses not to know. Despite the institutional resistance, the Department needs to work diligently to change this situation. DoD needs to better understand what it costs to achieve desired outcomes effectively. To do this, it must determine if the envisioned military capability-related “outputs” justify the various attributed costs of the “input” functions. Such a tool would provide senior leaders the needed visibility over investments, and an understanding of current resource allocation effectiveness. It would create a useful mechanism to compete and adjust resource allocations in order to achieve improved outcomes.

As part of this outcome oriented system, *the NSSG proposes that the Joint Staff and CINCs be provided with the authority, capability, resources, and means to assure successful mission execution of their areas of responsibility.* This is an intensely controversial issue among the Services—empowering the “output” function by providing them direct access to resources. In

DoD, the current approach provides money and resources only to the “input” functions, while the business world does just the opposite. In the latter case, the function that produces the product and/or service—the purpose of the enterprise—drives the various corporate inputs to hew to its needs. If DoD were to adopt such a system, the Services would still remain the stewards of force structure and most of the resources, but not all. The Services take the long view of requirements and force modernization because they must support force structures over their full life cycles. As currently structured in DoD however, only the Services determine what the executor will have—in organization, in training, and in equipment—and OSD largely looks on as a spectator rather than a referee. At the same time, the NSSG does not suggest revolution but rather a series of sensible modifications to the current policies and processes. Stated simply, fund output entities to execute some of the functions for which they are directly accountable.

In the case of the Joint Staff, the budget/funding list is short, mainly: the funding of the staff and those output functions assigned, such as standardization, interoperability, joint education, and joint testing. Regarding standardization and interoperability, this function must start at the very beginning. To make this happen, a directorate would be tasked to vet all major military system requirements, developments and procurements—especially all C4ISR programs—above a certain financial threshold of approximately \$100 million. This would include Joint Staff establishment of joint pass/fail critical performance parameters related to standardization and interoperability of weapons systems and support systems. Such an effort overseeing service acquisition proposals from initial inception to retirement would demand a full time position. *This new Joint Staff directorate should be created from existing resources and report to the JROC,⁶⁶ which would be newly empowered and accountable to validate the proposal and either sign for the Chairman or Joint Chiefs or forward it to the Joint Chiefs for ultimate confirmation.* Placing the control of standardization and interoperability in the hands of the Chairman and the Joint Staff would over time enormously improve warfighting capabilities.

While there is a great deal of activity in the JROC, the net effect of the JROC has been to change nothing.

The counter-argument from the Joint Staff will be that they already perform this function within the J-8 and the JROC. This is not so, however. While there is a great deal of activity in the JROC, the net effect of the JROC has been to change nothing. By the time a Service program gets to the JROC, it is far too late to make substantive change and the JROC is largely a rubber stamp exercise. As a result, requirements are not changed, standardization/interoperability pass/fail criteria are not inserted, and programs are not altered or terminated.

Programmatic matters are still Service responsibilities and the JROC members, who are Service officers, do not gore each other’s oxen.⁶⁷

Another issue is resourcing CINCs—financing them with resources to execute their responsibilities. Currently, CINCs have insufficient resource authority to carry out their uniquely assigned tasks, primarily the command and control of joint forces through the strategic and theater level, and the preparation of those forces for potential employment through the design, planning,

⁶⁶ To reform the process of identifying military requirements, the Joint Requirements Oversight Council (JROC) was chartered with responsibility to analyze for potential joint needs across Service boundaries and emerging mission areas. See, “Charter of the Joint Requirements Oversight Council,” Chairman of the Joint Chiefs of Staff Instruction (CJCSI) 5123.01, 2 May 1997. The 1997 charter is currently undergoing revision.

⁶⁷ M. Thomas Davis, “The JROC: Doing What? Going Where?” *National Security Studies Quarterly*, Summer, 1998.

control and execution of joint exercises. Of particular importance here is CINC exercise funding. Under DoD’s present system, the CINCs do not fund joint exercises, except for airlift/sealift and port handling/inland transportation (which are really “chits” issued from the executing agency, the US Transportation Command). CINCs organize the exercise but the Services supply the forces and pay the bills. Unfortunately, under this arrangement, the CINC must exercise the art of the possible—what the Services will agree to do in a joint exercise—rather than the CINC designing, controlling, and exercising his own plan.

If the CINCs were provided full exercise funds, the paradigm undergoes radical revision. Then the CINC would not only be accountable for joint exercising, but he would be expected to exercise the most worrisome parts of his theater contingency plans and war plans. This inserts vitally needed responsibility and accountability into the CINC planning, joint exercise and joint execution process. Moreover, such an approach would provide a unique tool for the CINC to identify shortcomings based on actual field-gathered data. Once the CINCs were offered full funding for joint exercises, the Services would have to get in line to play. Every fully-funded CINC exercise would not only be joint oriented and joint commanded, but would also offer free training for Service forces. The Services would participate to recapture the training.⁶⁸

7. Revising Programming and Analysis Mechanisms for the PPBS Process

The Commission also believes that the Department needs to reorient the programming process—and analysis capabilities of PPBS—on future requirements, or DoD will not produce the kind of transformation needed. *We therefore recommend that DoD revise the Major Force Programs used in the Defense Program Review to focus on a different mix of military capabilities. The eleven MFPs should be expanded into thirteen different programs divided into three major categories: “Combat Force” programs, “Combat Support” programs, and “Service Support” programs.*

The first major category would provide better horizontal visibility over the intended destination of future force capabilities, while the last category should provide detailed visibility over DoD’s infrastructure to assist in outsourcing and privatization. The current Major Force Program #2, General Purpose Forces, is simply too large and reinforces the DoD argument over the “fungibility” of conventional forces. It prevents the development of categories of missions that could transform the PPBS process into measuring output-focused results. Moreover, it prolongs the needed shift away from the current “Two Major Theater War” (2MTW) force sizing metric.

The Major Force Programs prevents the development of categories of missions that could transform the PPBS process into measuring output-focused results.

The current vehicles used to address issues during the program review—OSD’s “Major Force Programs” (see Table 1) and the Joint Staff’s “Joint Warfighting Capabilities Assessment” (see Table 2)—need revision to reflect future requirements better.

Each MFP currently contains numerous Program Elements (PEs) associated with specific Service, OSD, Defense Agency, and joint programs. Approximately 5,000 PEs exist, with most belonging to the Services. However, most PEs are outdated and many are assigned to the wrong MFP. The result is that meaningful analyses across MFPs is difficult, if not misleading.

⁶⁸ Michael Donley, “It’s Time for DoD to Establish a Joint Budget,” DRAFT paper, May 1, 2001

Category	Current Major Force Programs
1	Strategic Forces
2	General Purpose Forces
3	Intelligence and Communication
4	Airlift and Sealift
5	National Guard and Reserve Forces
6	Research and Development
7	Central Supply and Maintenance
8	Training, Medical, and Other
9	Administration
10	Support of Other Nations
11	Special Operations

Table 1. Current Major Force Programs

The NSSG is aware the Joint Staff is in the process of changing the JWCA categories—most likely to those depicted in Table 2 below.⁶⁹ It appears that the original 1994 JWCA categories were specifically created because MFP 2 (General Purpose Forces) programs *were* in fact too broad to provide meaningful analyses on different warfighting capabilities. The new thrust appears to make the JWCA more congruent with the operational concepts specified in Joint Vision 2020. This may provide better consistency between the established Joint Vision and the Joint Staff’s involvement in PPBS program review. It is uncertain however, this revision will generate more insightful analyses or move the PPBS process in the direction of producing needed future capabilities proposed by the Commission. Developing specific outcomes and metrics for each JWCA category before system and program analysis would seem to be a basic necessary.

Category	Joint Warfighting Capabilities Assessment
1	Strategic Deterrence (J-5)
2	Dominant Maneuver (J-8)
3	Precision Engagement (J-8)
4	Focused Logistics (J-4)
5	Full Dimensional Protection (J-8)
6	Intelligence, Surveillance and Reconnaissance (J-2)
7	Communications and Computers (J-6)
8	Information Superiority (J-3)

Table 2. Joint Warfighting Capabilities Assessment

⁶⁹ The ten key JWCA categories prior to the revision were: 1) Strike, 2) Land & Littoral Warfare, 3) Strategic Mobility & Sustainability, 4) Sea, Air & Space Superiority, 5) Deterrence & Counter Proliferation of WMD, 6) Command & Control, 7) Information Warfare, 8) Intelligence, Surveillance & Reconnaissance, 9) Regional Engagement & Presence, and 10) Joint Readiness. Also note that some DoD documents refer to the “C” in JWCA as plural “Capabilities” while others use the singular “Capability.”

The NSSG proposes the revision of MFP categories, as shown below in Table 3. New categories should be created to include homeland security forces, theater conventional forces, rapidly deployable/intervention forces, and constabulary forces to reflect future needs. These categories should not remain static. Regular revisions would provide a sustaining mechanism to implement change within DoD. The Defense Planning Guidance (DPG) should address each proposed category, and provide detailed and measurable objectives. Such a “horizontal” review would help identify programming compliance with planning objectives. *Additionally, the Program Elements (PEs) need thorough examination to align them correctly with the appropriate MFPs.*

Category	Proposed Major Force Programs
	<i>Combat Force Programs</i>
1	Strategic Offense and Defense Forces
2	Homeland Security Forces
3	Theater Conventional Forces
4	Rapid Expeditionary/Intervention Forces
5	Humanitarian Relief and Constabulary Forces
	<i>Combat Support Programs</i>
6	Strategic Mobility
7	Space and C4ISR
8	Medical Programs
	<i>Service Support Programs</i>
9	Research and Development
10	Acquisition Programs
11	Central Logistics and Sustainment
12	Administration, Personnel, and Training
13	International Activities

Table 3. Proposed Major Force Programs

The summer “Issue Cycle” or program review needs a basic restructuring as well. The Department needs to deconflict OSD’s Major Force Programs and the Joint Staff’s JWCA process. The reviews should nominally be on similar “sheets of music” rather than using exclusive informational data systems. That means both the MFP categories and the JWCA categories need some “harmonization,” so that comparisons and analyses are meaningful.⁷⁰ Both processes need to focus on major issues, and there is clearly not enough time for a summer program review cycle that examines issues generated by MFP analysis followed by one generated by JWCA analysis. Thus, “harmonization” between the two would lend itself to a single program review before the DRB. The JWCA process needs simplification, with recognition that it is providing a short to mid-term perspective. Ideally, it should focus only on “Combat Force” and “Combat Support” programs. The summer review should not begin until after the publication of Service POMs. The Chairman’s Program Review must be timely, and should reflect data more in common with that of OSD.

⁷⁰ The NSSG recognizes that different viewpoints can often shed new insight on an issue, however, current comparisons between MFP and JWCA categories is analogous to the proverbial comparison of apples to oranges.

Lastly, *the Department of Defense needs to improve its analytic capabilities.* This can occur in four ways. First, as proposed above in the Structural Reform section of this Addendum, the *Department can restructure the Program Analysis and Evaluation (PA&E) directorate to conform with the proposed MFP categories.* It can also improve the in-house analysis capability of the Under Secretary of Defense for Policy (USD(P)) by enhancing the capability of OSD Net Assessment to fulfill USD(P)'s needs to analyze strategic resource allocation tradeoffs.

As to OSD (PA&E), neither it nor USD(P) are establishing strategic goals or objectives for the MFPs, nor is the PA&E organization oriented on the MFP programs. Ownership of specific MFPs is clearly lacking, and despite almost 150 PA&E analysts and numerous supporting contractors the MFPs are essentially bureaucratic orphans.⁷¹ The MFP categories do not play in the examination of broad defense programs, rather they serve as “racks” where the various input-derived program elements are “stacked.” Thus, the PA&E organization, and the analysis process itself, within the annual defense program review, reverts to focusing upon program minutia within individual Program Elements. Figure 3 shows the current alignment of PA&E's four major divisions that contribute to this problem.

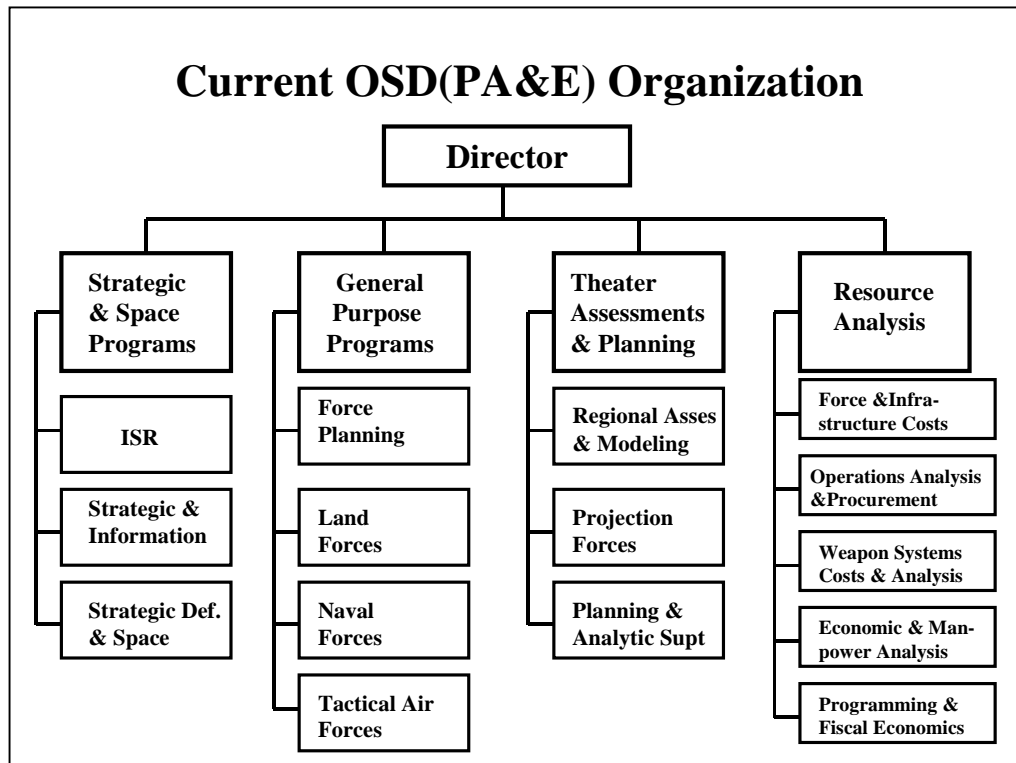

Figure 3. Current OSD(PA&E) Organization

Figure 4 below, reflects a proposed reorganization of PA&E that assigns responsibility for the NSSG's proposed MFPs. This would retain important expertise to support analysis of system costs (e.g the Cost Analysis Improvement Groups), and simultaneously provide better oversight of the PPBS process. It would facilitate needed visibility over the Combat Force

⁷¹ See, the two BENS studies on PPBS by M. Thomas Davis: “Framing the Problem of PPBS,” January 2000, and “Changing PPBS,” December 2000.

Programs and Combat Support Programs, and especially over the Service Support Programs, which is a clear requirement, if DoD infrastructure analyses and restructuring is to occur. The Combat Force Programs, Deputy Directorate may still require the capability to conduct “Land,” “Naval,” and “Air” analyses within and across some of the five Divisions. This would provide the analytic structure to help move the entire PPBS process toward the ability to implement the second analysis reform—measuring functional outputs associated with certain missions or capabilities.

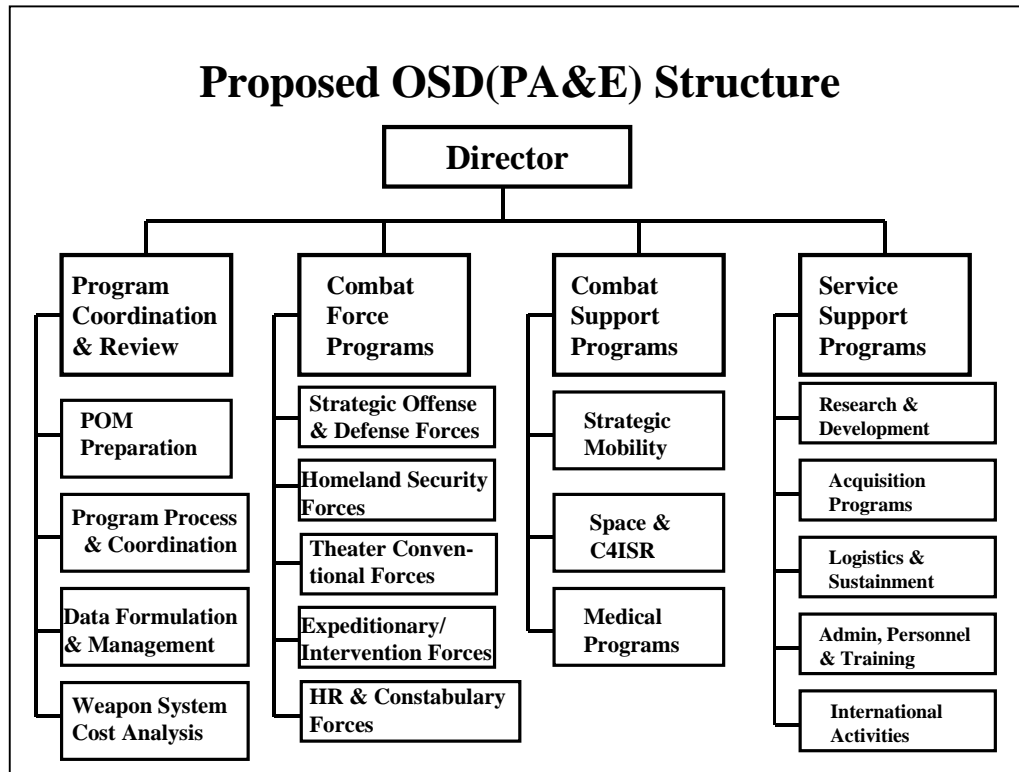

Figure 4. Proposed OSD(PA&E) Structure ⁷²

Second, the Department must establish specific “metrics” focused on measuring outputs or objectives throughout the PPBS process. Meaningful analysis that allows the establishment of real priorities and that identifies trade offs—the basis of any decision-making process—must begin with objectives, tasks, standards, and measures of effectiveness within mission categories. It should start with the DPG, must exist within the MFPs, and should be the focus of the QDR and the program review. The NSSG is well aware of the difficulty of developing and applying performance measures to the Pentagon’s various activities. Nonetheless it must occur or *analysis* becomes a *ritual* that masks serious inquiry and uninformed decision-making across defense programs. The Services resist and argue against such standards and measures from doctrinal perspectives and widely different assumptions. While some Service viewpoints remain valid, the underlying rationale is often to protect force structures and missions. By preventing the development of common DoD “metrics” focused on mission capabilities, the Department cannot analyze, much less make, substantive force trade offs—either within or between Services—that result in better outputs. The task is big, but it is crucial for an effective QDR and PPBS process.

⁷² Some structures were suggested by M. Thomas Davis, Northrop Grumman Corporation, 2000.

Third, *the Department's modeling and wargaming tools used to assess capabilities and to size forces are dated and inadequate.* The Chairman's letter in the 1997 QDR clearly stated that the "assessment process has highlighted the need for better analytical models that will allow us to accurately and rapidly conduct future force requirements analysis. These analytical tools do not capture the interaction of key variables in force-on-force assessments across the spectrum of military operations, from smaller-scale contingencies through major theater war."⁷³ This problem was reemphasized in the National Defense University-sponsored QDR 2001 Working Group report that stated, "There is a paucity of sophisticated force performance models that accurately reflect how the U.S. military actually operates. Nor are there fully developed models to capture the full range of peacetime demands and evaluate force sustainability over time."⁷⁴

Existing models are vestiges of the Cold War and have critical deficiencies that require many assumptions and the constant injection of subjective judgement.⁷⁵ The result is that there

Existing models are vestiges of the Cold War and have critical deficiencies that require many assumptions and the constant injection of subjective judgement.

are few means to validate, assess, or test new ideas and technical concepts. Allied and enemy capabilities are difficult to capture, and current combat models nearly always focus on attrition rather than effects. The last unit left alive "wins." Attrition models are inherently incapable of modeling highly networked environments. They erroneously separate the reconnaissance, targeting, strike, and assessment process, rather than showing it as a constant execution cycle. Networks use precision and speed rather than mass to achieve effects and can possess corresponding critical failure nodes—

all poorly portrayed by DoD's current theater modeling and force sizing tools. Moreover, real military forces adapt and learn as they fight, but attrition models have no capacity to portray adaptation or emergent behavior. Models based upon genetic algorithms and complexity theory better portray networked adaptive environments and the Department must pursue such approaches.⁷⁶

Fourth, beyond metrics, wargaming, and modeling *DoD needs to use its analysis dollars more wisely.* The Department spends hundreds of million of dollars annually for various studies analyzing issues directly related to the PPBS process.⁷⁷ Different Pentagon staffs and agencies conduct many studies internally, and contract innumerable studies externally with independent consulting firms and Federally Funded Research and Development Centers (FFRDCs). Many of these studies are worthwhile, performing original research and analysis that sheds insight upon significant problems. Many of these studies, however, are clearly reverse-engineered to provide analytical "top cover" to already agreed upon positions. Unsurprisingly, the conclusions stemming from such "independent" analysis inevitably reflect the original institutional positions held by the contracting organizations before the initiation of such studies.

⁷³ John M. Shalikashvili, in "Report of the Quadrennial Defense Review," May 1997, Section X.

⁷⁴ "Report of the NDU QDR 2001 Working Group," p. 32.

⁷⁵ These include TACWAR, JWARS, and JICM.

⁷⁶ Some new directions in modeling do exist but need to be expanded to the theater level. For example see the classified efforts at the Joint Warfare Analysis Center, and the unclassified work by Andrew Ilachinski, "EINSTEIN: An Artificial-Life Laboratory for Exploring Self-Organized, Emergent Behavior in Land Combat," Center for Naval Analyses, CRM D0002239.A1, September 2000.

⁷⁷ DoD expended 194,749 contractor "man years" on R&D, T&E, and "Special Studies and Analysis" in FY2000. See "Use of Employees of Non-Federal Entities to Provide Services to Department of Defense," Department of Defense, 12 March 2001, p. 3.

While the Department's internal analytic capability is important and must be improved, DoD still needs to balance it with good external analysis. In-house studies can also get "captured" and drive the Department to reinventing Napoleon's Army over and over, because they frequently provide only a one-dimensional view of issues. The key is to blend both capabilities, and managers must insure that analysis requirements add value to problem resolution.

No overarching analytic "theme" has arisen to replace the Cold War emphasis, thus lack of focus and direction pervades analysis within DoD. The Department, and the defense analysis "industry" that supports it, needs an infusion of analysts trained in new modeling methods. The overall effect of studies and analysis within the Department is that it seldom advances institutional knowledge on problems, and rarely surfaces critical alternatives, because senior leaders remain swamped with competing studies that focus on marginal details. Excessively studying a problem does not necessarily lead to better decisions; it often provides excuses to delay difficult ones. Much needs to be done to reduce the PPBS "studies and analysis overhead" and improve the usefulness of analysis for decision-making.

The overall effect of studies and analysis within the Department is that it seldom advances institutional knowledge on problems, and rarely surfaces critical alternatives.

Secretary Rumsfeld and the President deserve a QDR/PPBS process that contributes to defense management, and develops and elevates viable alternatives for decision. The current system of modifying and replacing legacy platforms, while delaying long-term requirements dictated by a changing strategic environment, endangers the security of the United States. Reorganizing and streamlining DoD's PPBS process could elevate strategic choices and decisions to the Secretary. However, the eagerness with which any Secretary will deal explicitly with both resource allocation and policy issues may depend on the political position and goals of the Administration. While rhetoric from the Hill often derides the Department's inefficiency and lack of management, powerful incentives exist to preserve programs and jobs. Aside from the Pentagon's bureaucracy, the most vigorous impediment to changing the status quo is often the Congress. The constituency for military reform is weak when it threatens local installations. Moreover, if the Administration is unwilling or unable to question Service proposals that have already garnered strong congressional support, structural and process changes alone within DoD will not achieve the desired results.

B. Reforming the Defense Acquisition System

If the Department of Defense does not change the manner in which it buys weapons and services, the United States will enfeeble its national security and industrial base, while perpetuating a system of defense acquisition that is intolerably sub-optimal.

1. Role of Technology

A key part of the future competitive edge of America's military resides in maintaining the technological superiority of its forces. Technological superiority helps to offset disadvantages in numerical manpower, serves as an important deterrent, and helps reduce casualties among the nation's combat forces when deterrence fails.

The pace of current technological advancement is arguably more rapid than any other time in history. In the military sphere, recent decades have witnessed the advent of precision guided missiles, the ability to see at night, precision navigation, surveillance from space, light-weight mobile telecommunications, stealth, massive information processing and other similarly important developments. Such capabilities were a significant factor in the disparate casualty rates encountered by the opposing combatants in the Gulf War and other recent combat operations.

Underpinning much of this technological leadership is America's private sector—the nation's industrial base. But a number of recent developments have fundamentally changed the character of that segment of the industrial base traditionally referred to as the *defense* industrial

The leading edge of technological progress resides largely in academia, in research centers, and in commercial firms—and many of the latter prefer not to do business with the U.S. government.

base. The first of these developments has been the explosion in commercial technologies, such as information management, telecommunications, biotechnology, and nanotechnology. During the Cold War many or even most advances in state-of-the-art technology stemmed from defense research and development. Today, in contrast, the leading edge of technological progress resides largely in academia, in research centers, and in commercial firms—and many of the latter prefer not to do business with the U.S. government due to the burdensome nature of such dealings.

A second factor concerns the so-called defense procurement holiday, which is now into its second decade and which in its initial years was made possible by the demise of the Soviet threat. Confronting declining defense procurement budgets and the need to reduce overhead costs associated with the large Cold War industrial structure, America's defense companies, encouraged by the Pentagon, downsized and consolidated. One outcome has been that the number of competitors capable of providing any given category of military equipment has declined markedly. Today, it is unclear whether current procurement levels can sustain more than one, or at most two, viable competitors for many types of weapons systems, given present and forecast procurement budgets and the rising unit-cost of military equipment. In some instances, it will be difficult to sustain even a single supplier. Such a state of affairs is obviously deleterious to the notion of a vibrant, highly competitive collection of defense suppliers.

2. The Defense Industrial Base

In equipping its military forces over the years, the United States has chosen to depend to a large degree on the private sector, as opposed to maintaining an extensive government arsenal system. Unfortunately, present day defense procurement from the private sector cannot continue in the manner of traditional free-enterprise processes. There are many reasons for this state, the primary one being that the sole customer for military equipment made in the United States, in addition to being the most powerful buyer in the world, is monopsonistic as well as the gate-keeper for foreign sales. Second, for some specific items of equipment already in production, there is only one realistic source from which the Department of Defense can purchase additional units. Thus, at times there are monopolies within the defense system.

The necessity of providing intense oversight and scrutiny to assure public propriety and the need to afford competition to all reasonably qualified suppliers further complicates the above circumstances. In addition, there are political and social purposes some seek to support via defense procurement, including the maintenance of jobs, facilities, support for small businesses and the like. Finally, the defense procurement stakes are very high indeed, since one is dealing not merely with the profitability of a handful of companies, but with the very lives of U.S. military personnel and conceivably even with national survival. The result of these and other considerations has led the government, in carrying out its defense procurement, to seek to establish surrogate forces to act in the stead of market forces, which automatically govern more conventional commerce throughout the free-enterprise system. These surrogate forces have to a large extent taken the form of laws, regulations, and intensive oversight—each in abundance.

Operating within this environment is a small group of primarily defense-oriented companies, a larger number of basically commercial firms that have some involvement in defense procurement, and a growing number of particularly high-tech companies, which find it anathema to deal with the Department of Defense. Importantly, all of these companies, including the purely defense-oriented firms, must compete in the open marketplace for financial and human capital. Even defense suppliers must compete on an equal footing with such firms as Microsoft, General Motors, and Intel as well as the new phenomenon called “dot.coms,” if they hope to attract talented employees and maintain modern laboratories and factories.

A growing number of particularly high-tech companies find it anathema to deal with the Department.

A substantial number of studies in recent years have pointed to the increasingly tenuous health of many of the nation’s most critical defense suppliers.⁷⁸ That situation, if prolonged, could severely endanger America’s long-term military capabilities. As tempting as it is to adopt a strategy of standing back and relying on the marketplace to solve the problem, for the reasons cited above, such an approach would be ineffectual as well as irresponsible. The Department of Defense, as the monopsony customer of military equipment, can no more take a detached position

⁷⁸ John Harbison, Thomas Moorman Jr., Michael Jones, and Jikun Kim, “U.S. Defense Industry Under Siege—An Agenda for Change,” Booz-Allen & Hamilton Viewpoint, July 2000. “Preserving a Healthy and Competitive U.S. Defense Industry to Ensure our Future National Security,” Defense Science Board Task Force briefing to USCNS/21, June 2000. “U.S. Space Industrial Base Study,” DoD and NRO Co-sponsored Study by Booz-Allen & Hamilton. Briefed to USCNS/21, June 2000. “The National Crisis in the Defense Industry,” study briefed by The Scowcroft Group and DFI International to USCNS/21, June 2000. Tail-to-Tooth Commission, “Call to Action,” BENS, February 2001.

toward the health of the overall defense industrial base than it can divorce itself from responsibility for the viability of its Army, Navy, Air Force or Marine Corps.

3. Acquisition Reform Overview

The principal linkage between the Department of Defense and its suppliers is the defense acquisition process, considered for many years to be overly burdensome and fundamentally inefficient. Unless serious and sustained intervention in this system is forthcoming, the defense industrial sector's ability to fulfill its role will be in jeopardy. As a consequence, the ability to field superior military forces in the 21st century will also be in jeopardy.

This is not a problem that a massive infusion of money can solve; at its root are fundamental structural defects that, if not fixed, will only worsen over time, producing increasingly less useful output for ever-more dollars.

This is not a problem that a massive infusion of money can solve; at its root are fundamental structural defects that, if not fixed, will only worsen over time, producing increasingly less useful output for ever-more dollars. This has at its core the Defense Department's inability to match security ends to defense means. But equally important are the overall shortcomings of the defense acquisition process itself. In short, as then-Deputy Secretary of Defense David Packard noted in the 1960s, the acquisition system is broken and stands in

need of repair. It is even in worse shape today, and without repair it will be difficult for the United States to meet its defense needs in the vitality of the private "new technology" commercial sector.

This NSSG emphasizes the need to address acquisition reform in the following three areas:

- **INNOVATION AND EXPERIMENTATION**—*To maintain its edge in the use of new technology and concepts of operation, DoD must have a robust program of innovation and experimentation focused on unique warfighting requirements that the commercial world will not develop on its own.*
- **PROGRAM STABILITY**—*The defense industry needs a stable budgetary environment if it is to raise adequate capital and maintain shareholder confidence, and that will be possible only when program stability becomes a principle of operation shared by DoD and the Congress. This practice will also maximize the nation's return on its defense investment dollars.*
- **BUSINESS PRACTICES**—*DoD will attract commercial suppliers, achieve the timely introduction of new technology, and generate cost savings only after it adopts a number of widely accepted modern business practices.*

As noted, virtually all indications confirm that the U.S. defense industrial base faces severe financial, cash flow, and personnel recruiting and retention problems. A 50 percent reduction in DoD procurement budgets since 1987 has contributed to this circumstance, and the vibrancy of the commercial private sector has made personnel issues particularly acute. These troubles, however, are "symptoms" of the real problem rather than its cause. Specifically, they are

symptoms of stultifying regulations, a dysfunctional budgetary process, and an acquisition process functioning largely under an obsolete industrial age paradigm.⁷⁹

Many capable businesses are unable to work profitably with DoD under the weight of the auditing, contracting, profitability, investment, and inspection constraints imposed by its regulations. Some of these problems are inherent in a system that is neither entirely public nor entirely private. That state of affairs makes the process of arming the U.S. military a world of inherent contradictions. For example, competition is essential within the defense sector to achieve both affordability and innovation. However, competition remains limited by the current disproportionately low modernization activity, which makes some competitions impractical.

DoD is rightly held to a high level of public responsibility involving social and ethical standards, but this generates the sort of oversight that makes it impossible for procurement to be efficient and aggressive in achieving cost savings. It also affects DoD's ability to function with the speed it needs to keep abreast of technological change. Weapons development cycles average nine *years* for the Department in a world where technology now changes every twelve to eighteen *months* in Silicon Valley—and the trend lines continue to diverge.

Despite circumstances that make it impossible for the acquisition system to work as a true free market, market mechanisms can be made more effective. The government must reduce the impediments to competition and to DoD's use of best business practices. This is much easier to say than to do, however, for one main reason: The defense industrial base, and the acquisition system driving it, resides within a larger political context where local politics play an important role. The separation of powers and Congress' ultimate "power of the purse" have led over time to a situation in which Congressionally-mandated actions heavily impact procurement processes.⁸⁰ Unneeded government facilities continue to operate at the expense of legitimate needs for funding in other areas. Moreover, while formal and legal customer/supplier relationships exist with DoD, strong informal political relationships concerning local jobs and programs often affect the decision process within the Congress and the Executive branch.

The defense industrial base, and the acquisition system driving it, resides within a larger political context where local politics play an important role.

Most DoD officials fully understand these problems—and others besides—and they are acting to solve them. Congress, too, has provided mechanisms to expedite procurement of commercial equipment. Dozens of studies support, and argue over, how to go about reform in

⁷⁹ The "health" of the defense industrial sector of the economy is seriously in doubt. As pointed out in the Booz-Allen & Hamilton and Defense Science Board studies, industry profitability has declined, and the industry's interest coverage ratio has fallen. Debt ratings for most companies have fallen to almost junk bond levels. This means industry profits can rarely cover the cost of new loans. Despite recent improvements, the industry's market capitalization is down 33 percent from \$100 billion in January 1997 to \$66.7 billion in 2000. The entire defense industry is valued at 14 percent of Microsoft, 17 percent of Intel, and 50 percent of America Online. "On February 23, 2000, you could buy the defense and space parts of Boeing, Lockheed Martin, Raytheon, General Dynamics, Hughes, TRW, Northrop Grumman, Loral and Litton all for \$47 billion, which was less than the one day market value appreciation of Cisco (\$50 billion) the day before." See Harbison, Moorman, Jones, and Kim, "U.S. Defense Industry Under Siege," p. 1.

⁸⁰ "The Road Ahead – Accelerating the Transformation of Department of Defense Acquisition and Logistics Process and Practices," Office of the Under Secretary of Defense for Acquisition and Technology, June 2000.

various areas. But so far the effort is not producing the scale of change necessary to right a system that has degenerated to the point of alarming concern. The Congress has applied piecemeal “fixes,” but it has proven highly resistant when it comes to its own organization for national security, which influences the entire acquisition process. In addition, the defense industry consolidation of the 1990s ended up producing more “specialization” and “segmentation” than “conversion” into a broader civil/military product mix.

A national industrial base for defense is required rather than a specialized Defense Industrial Base. This would consist of a cluster of industries—a broad cross-section of commercial firms as well as the more traditional defense firms. To realize such an enterprise cluster, the defense acquisition process needs a more business-like footing.⁸¹ DoD must learn to leverage robust partnerships with the commercial economy in a more coherent fashion, and defense firms need to broaden their business base by moving into dual-use technologies. The United States can no longer afford or rely solely on a defense industry devoted exclusively to servicing DoD. Nor can it allow a situation in which critical new technological capacities remain beyond DoD’s reach. The Department must attract “new technology” sectors to work with government on business and professional grounds. In addition, the more traditional defense suppliers, which fill needs not addressed by the purely commercial sector, must receive incentives to invest in innovation and operate efficiently. Finally, the Department must acknowledge the increasingly globalized nature of the defense industrial economy. The United States should seek out selective international partnerships (generally for procurement as opposed to R&D), yet it should preserve its ability to pursue unilaterally those programs uniquely critical to the nation’s defense.

In the Commission’s view, the statutory guidelines and the Federal Acquisition Regulations (FAR) system itself needs redesign—from scratch. We realize, however, that the government cannot accomplish changes to the acquisition system and the defense industrial base overnight. As acquisition reform proceeds, the Department must minimize the disruption to established programs or there will be nothing left to reform. Short-term solutions to acute problems, however, can help the Department move to a position from which long-term solutions can succeed.

4. Acquisition Reform Principles

To accomplish acquisition reform, the defense acquisition process, which is the principal linkage between the Defense Department and its suppliers, will need fundamental revision. To guide this reform, the Commission offered these overarching principles.

- *The nation needs to restore the balance of funding among modernization, readiness, and force structure. The procurement “holiday” affecting modernization has produced a highly unbalanced force for the future.*
- *The government should encourage small, agile, high-tech companies to enter defense competitions, as they represent both a source of innovation and an inspiration to new efficiencies.*
- *The Department’s overall modernization strategy should give priority to fundamental research; substantially increase prototyping; stress the evolutionary*

⁸¹ Ann R. Markusen and Sean S. Costigan, eds, *Arming The Future: A Defense Industry for the 21st Century* (New York: Council on Foreign Relations, 1999).

upgrading of platforms throughout their life; and keep commitments to long-term, stable production.

- *To the extent practicable, the acquisition system needs to be open to continuous competition, and open to new ideas from companies of all sizes. It should focus on “outputs,” i.e., measurable products, time, and cost, as opposed to “process.”*
- *The weapons development process should rely on competition to solve performance problems and keep down costs, with commensurate rewards for those who succeed.*
- *The acquisition system should use the market to decrease system costs and improve schedule and system performance. The current system of centralized planning, the inappropriate use of government agencies to perform commercial tasks, and the lack of managerial accountability stifles efficiency.*
- *The government, not the private sector, should pay the costs that result from explicit government demands and requirements in the acquisition process. At the same time, companies deserve no proprietary entitlement to publicly-financed designs and technology.*

5. Innovation and Experimentation

For decades, many commissions and studies have recognized innovation and experimentation as essential components of defense reform. This was reiterated in the 1997 National Defense Panel report.⁸² Modest short-term efforts have been directed toward improving this area.⁸³ These efforts have increased the focus on interoperable C4ISR systems, but have had limited impact on increasing the flow of innovation into the requirements process. The Services are often unwilling to trade off “requirements” and have been known to forego *any* capability rather than match technology with requirements to launch a program. As a result, U.S. warfighters often receive equipment and technology that lags behind the state-of-the-art because of the acquisition cycle times involved with producing major systems.

To insure greater innovation and experimentation, the Department needs to modify the Service near-monopoly on identifying and initiating requirements. Requirements should flow from many directions and sources: operational shortfalls, new threats, long-term strategy and policy, technological opportunities, and impending block obsolescence of current platforms. Unfortunately, the last mentioned requirement source often dominates decision-making because of the pressure to start programs as vehicles for the Services to obtain and sustain funding. The pressure to perpetuate remarkably similar force structures, roles, and missions—more of the same, just bigger, faster, and better—tends to squeeze out innovation.

Some voice the complaint that the Services exercise a “stranglehold” over the requirements process, because only they are authorized to initiate Mission Need Statements (MNS), which ultimately get translated into programs. Allowing the initiation of MNSs from other actors who shoulder different responsibilities and are accountable for considering different planning horizons would open the entire process to more innovation and the airing of different

⁸² *Transforming Defense, National Security in the 21st Century*, Report of the National Defense Panel, December 1997.

⁸³ For example, Service “Battle Labs” were created, and “Joint Experimentation” has been assigned to the Joint Forces Command.

alternatives. Such a change would allow OSD, DARPA and the Joint Staff to initiate Mission Need Statements. At present, CINCs can generate MNSs directly to the JROC, but remain limited in their capability to make such inputs due to staffing and Service acquiesce to fund such programs. It is imperative, however, to insist upon joint interoperability standards, and the maintenance of a top-down review process to insure that a potential flood of proposals meet the Department's needs and are fiscally executable. The JROC and Defense Acquisition Board review process would still play, but both mechanisms need streamlining and real "teeth" to better screen proposals.

The overwhelming focus of the DoD requirements process, and the acquisition system that flows from it, remains oriented on process rigors and large-scale production commitments,

The current acquisition system does not support timely introduction of new technologies.

not on innovation and experimentation. The current acquisition system does not support timely introduction of new technologies, because "cycle times" are much too long.⁸⁴ Some major defense systems do not even reach production before the parts they depend on from the commercial sector are obsolete and no longer available.

Worse, while the commercial world is succeeding at further shortening cycle times, DoD is not—so the gap between commercial and government practice continues to widen.⁸⁵ *One ingredient of fixing this problem is to establish and employ a two-track acquisition system, one for major acquisitions and a second, "fast track" for a limited number of breakthrough systems, especially those in the area of command and control.*

While such an approach seems to presuppose that one can derive "breakthrough" systems, the Commission assumes no such thing. C4ISR systems should primarily be "fast track." In other instances, this approach would be controversial and require decision authority vested in Service acquisition officials. Flexibility is paramount and authority should exist to move programs either to or from "fast track" status depending on progress and performance. Major new weapons systems will always include several subsystems or components, and authority to qualify these for "fast track" status should rest with the system Program Manager—naturally subject to higher review.

The current process is much too limiting. Except for a few highly sensitive classified programs, all current acquisition programs move through similar legal-bureaucratic hurdles in the acquisition process at rates largely dependent on program costs and funding availability.⁸⁶

⁸⁴ The average development cycle for all DoD systems is approximately 9 years. The average of some systems like helicopters and fighters is 20 years, the average for avionics systems is 11 years, and the average for communications systems is 10 years.

⁸⁵ The cycle time for producing an automobile used to be seven years, today it is two years, and the auto companies have a goal of eighteen months. For a commercial aircraft, it used to be eight to ten years, today it is five years, and the industry is working towards a two-and-a-half year cycle time. Commercial spacecraft use to take eight years, today it takes eighteen months and the goal is twelve months. Consumer electronics took two years in the past, now it takes six months or less. This illustrates how fast technology is *not* being introduced into DoD at present.

⁸⁶ Acquisition Category (ACAT) I programs are defined as having RDT&E costs of \$200 million in constant year (CY) 1980 dollars or as having total production expenditures over \$1 billion in CY 1980 dollars. ACAT II programs have RDT&E costs of \$75 million or production cost of \$300 million in CY 1980 dollars. ACAT I is classified as a "Major Program" and ACAT II is classified as a "Major System." ACAT I and II programs are subject to unique acquisition execution and reporting requirements imposed by Title 10 U.S.C. The Under Secretary of Defense for Acquisition, Technology, and Logistics (USD AT&L) is the acquisition decision authority for most ACAT I programs. Management of ACAT III and IV

Unfortunately, the costing levels are set low enough to encompass almost every major DoD program, including most C4ISR systems. Even the lower six-year cycle time of some programs is well outside the envelope of the commercial world's eighteen-month development cycle for information systems. The current acquisition system is testing some "Pilot Programs," which have so far proven insufficient to decrease cycle time enough for DoD to keep up with the information revolution.⁸⁷ The Department is now falling approximately three generations behind in each major C4ISR system it produces. Assuming the Department cannot purchase

The Department is now falling approximately three generations behind in each major C4ISR system it produces.

off-the-shelf products to support unique military requirements, DoD's technology is out of date with comparable civilian counterparts before such systems are ever produced. Increased use of off-the-shelf systems can ameliorate the problem somewhat, but such technology is also available to potential adversaries and the civilian sector cannot meet some DoD requirements, because of special needs for hardening, encryption, and environmental considerations. It is critical to amend the statutory requirements to allow the Department to purchase C4ISR systems on a faster track.

The most fragile elements of the defense industrial base lie in its design teams and research teams. Prototyping can support the forces and avoids large infrastructure investments and costly production runs associated with moving "grand design" high-risk weapons systems through the acquisition process. Program "slips" and cost growths are in truth, highly predictable in the aggregate. Assuming the problem lies with poor estimates is too simple. Better estimating techniques are useful if one wants better estimates, but the real solution is not to require point cost estimates too early in the development process. Another solution is to recognize that uncertainty exists and risk must be better managed.

The most fragile elements of the defense industrial base lie in its design teams and research teams.

Conversely, in the lower-cost pre-program environment, one should stretch further. One should also be prepared to fail on occasion. In today's innovative business world of modern science and technology, those who succeed know that an environment where creative failure is impossible is also an environment where success is not possible. Indeed, the commercial world views occasional "failures" as providing very useful information and considers them an unavoidable part of an innovative environment. DoD's failures, however, are often more expensive, because they occur in the later phases of development—even in the production stages of a project. Ultimately, it is better to have more expensive, but fully-funded experimentation processes that select ideas mature enough to warrant full-scale development. Increased use of experimental prototyping would help solve this problem, as well as help preserve important and highly perishable design teams.

programs can be delegated by DoD or the Services to lower levels, and are executed under less complex statutory requirements. The average cycle time for ACAT I and II programs are 11 years and 6 years respectively.

⁸⁷ Defense acquisition "Pilot Programs" were initially authorized by Section 809 of the Defense Authorization Act for FY1991 (Public Law 101-510; 10 U.S.C. 2430). They were amended and enhanced in Section 831 of the 1994 Defense Authorization Act and in the Federal Acquisition Streamlining Act of 1994. They were renewed in the FY2001 Defense Authorization Act.

The Commission also believes that the Department should emphasize, incentivize, and fully compensate technological development. The United States must invest heavily in break-through research in laboratories, universities, corporations, and government facilities. DoD must eliminate the pressures where firms need to recover R&D costs and profits during the production phase. Prototyping at the front, allowing some to fail, and then developing, evolving, and producing the most promising prototypes, would shorten the development cycle and lower total program costs. In addition, it would help in creating and maintaining viable defense suppliers, even in an environment where there is little production.

Therefore, DoD should return to the pattern of increased prototyping and the testing of selected weapons and support systems, specifically to foster innovation. The Department should implement this initiative immediately for programmed product improvement upgrades of legacy systems that meet future requirements. This should provide the learning vehicle for new systems. DoD should also combine prototyping with the introduction of incremental delivery schedules and an evolutionary upgrading of existing platforms that would focus on equipment modules, software improvements, and block changes.

The NSSG endorses Advanced Concept Technology Demonstrations (ACTDs) and the use of an evolutionary approach in all but cases offering clear break-through capabilities. Today's ACTD programs represent only a small fraction of DoD's procurement budget and more often than not the Services have avoided ACTD programs, which often focus on short to mid-term needs. The Defense Advanced Research Projects Agency's (DARPA) use of Advanced Technology Development (ATD) programs is also valuable, but DARPA's ATDs are so far at the cutting edge of technology that only a few can be rolled into ACTDs or into production.

Placing a greater emphasis on ACTDs and prototyping would allow requirements and capabilities to track more closely with the technological base and provide three key advantages. First, it would help reduce cycle time to deliver weapons systems to warfighters. Second, it would reduce risk in the production environment. Third, it would allow the injection of new technology into weapons systems at a rate more comparable to civilian practices.

That said, the Department cannot depend entirely on speeding up its integration with the commercial sector. The nation needs to maintain a robust investment in selected research programs, particularly in long-term research. A

A Department research and development strategy forced to live entirely off of commercially available products is doomed to be inadequate.

Department research and development strategy forced to live entirely off of commercially available products is doomed to be inadequate because many military systems simply have no commercial counterparts. Unfortunately, large and complex DoD development projects suffer from distorted R&D cost competition. By nature, bids for R&D are highly uncertain, and in recent times companies have often tendered bids with the hope of securing funding wedges for profitable production phases. Industry is increasingly forced to divert Independent R&D (IR&D) to buy down "risk" in engineering and manufacturing development rather than using it to enhance the state-of-the-art. *The Commission recommends that the laws prohibiting the use of Independent R&D (IR&D) funding for program support be more broadly interpreted and more strictly enforced by the Department.* DoD is currently eating its research "seed corn." In effect it is forcing industry to subsidize under-funded government acquisition programs.

Furthermore, the NSSG believes the Department should not artificially constrain its R&D budget by pegging it, even informally, to a percentage of the annual defense budget, as has been past practice. On balance, the NSSG also believes that to the extent that the United States draws down its forces, even for sensible reasons, it should *increase* its investment in military R&D against an uncertain future. Finally, the Department should appropriately divert some of that R&D to the unique demands of countering the terrorist threat both at home and abroad.

6. Improving Program Stability

Program turbulence and lack of budgetary stability is a primary cause of inefficiencies and cost overruns in DoD programs. This budgetary instability has several sources. One is the current reality of the resource allocation process itself within DoD, which unfortunately often takes *all* resources into account during budget reductions—including acquisition programs. This normally results in a known and deliberate underfunding of previously approved programs. Another problem is the acquisition system itself, which suffers from cost overruns and program extension. Lastly, the Congress often uses small “takes” from large programs to reallocate funds to other priorities without realizing or understanding the problems this creates in having to reprogram funds, write new contracts, and establish new schedules.

The commercial world clearly recognizes program turbulence as an enemy of rapid development and production, as well as to the bottom line. Industry manages turbulence by providing funds to match schedules rather than scheduling to match funds. If DoD is to streamline its acquisition process, it must minimize budget perturbations by better discipline in the programming/budgeting decision process. Part of this must come by making the start up of new projects very demanding, and the fundamental revision of established programs even more demanding. However well DoD does in this respect, the NSSG knows that modernization accounts will remain among the most unpredictable within the DoD ambit. That is because, more than any other program category within the Department, the modernization process itself is, and will remain, inherently experimental and uncertain.

The commercial world clearly recognizes program turbulence as an enemy of rapid development and production.

We realize that many Commissions and even more studies over the past several years have recommended two-year budgeting to limit program instability. We also know that Congress has doggedly refused to take these proposals seriously. Therefore, rather than propose two-year budgeting across the entire Department, the Commission recommends two areas where two-year budgeting would make the most sense, stand to do the most good, and dovetails well with the Commission’s PPBS recommendations. ***The Commission recommends that the Congress implement two-year defense budgeting solely for the modernization element of the DoD budget (R&D/procurement) because of its long-term character, and expand the use of multi-year procurement.***

As things stand today, the Services create Program Objective Memorandums (POMs) based on early budget *estimates*. A corporate structure, in which lower committees and councils make modifications, review and build each POM. Service “Resource Boards” then approve or reject the POM at senior levels. Changes are injected frequently as the POM is built for two reasons: cost overruns impact programs from below while budget changes come from above. The general result is the constant need to produce funding “offsets” by killing minor programs, or by stretching or cutting the size of major procurement programs. Decisions to actually kill programs

are rare. Instead, the Services stretch major programs and push modernization “bow waves” into the future.

The Defense Resources Board (DRB) then reviews and approves the completed POMs. These budget decisions reverberate back upon subsequent acquisition programs, often impacting thousands of in-being contracts and schedules on a single program. *If the Department is to minimize program turbulence, acquisition personnel must have a greater role in providing program impact information. Moreover, senior decision-makers must also exercise greater leadership and discipline in maintaining a steadier helm with regard to program budget changes.*

Modernization objectives and strategy have to be top-down in nature. Technology investment decisions should occur at the corporate level (with cross-Service input). The Services should then execute product development. Shortening production cycles is a prerequisite to increasing budgetary stability. It would provide Congress the assurance that the Department can execute a two-year budget for modernization and R&D accounts, and pursue multi-year funding.

The authority for two-year budgeting for modernization and R&D funding elements resides solely with the Congress. Multi-year procurement is slightly different. Usually proposed by the Department to the Congress, it is a procurement appropriation in one year that commits the government to purchase yearly numbers of in-production systems in non-budget years—sometimes out to five years—even though total contract funds are not available at the time of contract award.⁸⁸ Although multi-year contracts solve many program stability problems, they are still subject to funding availability in subsequent years, but there is no guarantee that the Congress will appropriate funds other than severe penalty clauses. Multi-year procurement, however, allows prime contractors to establish long-term contracts with suppliers to achieve savings through quantity purchases. But the government should only enter into multiyear procurement when it has a high confidence in the technological readiness level of a program and it possesses stable configurations.

Article I, Section 8 of the Constitution clearly permits two-year appropriations, and the Department routinely goes through the process of producing two-year budgets in the hope Congress will pass them. It has not happened for a number of reasons. One, as suggested above,

Appropriating funds on a yearly basis provides a vehicle that permits the Congress to micro-manage Executive Branch programs and influence policy decisions.

is that Congress has little confidence that DoD is capable of executing such a budget, given the high degree of program instability, the lack of accountability, and cost growths in the past acquisition of weapons systems. Another reason is that appropriating funds on a yearly basis provides a vehicle that permits the Congress to micro-manage Executive Branch programs and influence policy decisions.

Nonetheless, if modernization and R&D accounts had two-year budgeting, and if the Department were to implement multi-year procurement, program stability would markedly increase and budgetary savings would register in the billions of dollars. For this to happen, however, DoD needs to adopt other broad reforms. Secretary Rumsfeld must take a personal interest in acquisition reform and impose discipline in the decision-making process. It is sometimes better to eliminate some programs early than to absorb the costs of extending programs and procuring limited numbers of weapons at high per unit costs. Congress should let

⁸⁸ See Title 10 U.S.C., Section 2306b(1), and Title 41 U.S.C., Section 254c(d).

such decisions stand and strongly support DoD budgeting and procurement reforms. Ultimately, the Congress should be called to account and asked to justify why its obsolete model of annual appropriations justifies the *decreased* levels of procurement.

Immature technologies and concepts lead to major waste in resources, especially when introduced into engineering development activities. Constant modifications drive costs upward significantly and extend program cycle times, while undue development/production concurrency increases risk. The procurement system must discover weaknesses or the need for modification as early as possible. Production and development require concept and technology stability, if timelines are to be trimmed and total costs minimized.

*The Commission recommends that the Defense Department allocate resources for weapons development programs by phase rather than in annual increments.*⁸⁹ The NSSG suggests, in particular, that the time for engineering development for most programs should rarely exceed four to six years for major platforms, and shorter times for other programs and “fast-track systems.”⁹⁰ It is also important that DoD provide incentives to maintain integrity in the process. Simply stated, industry can never correctly measure program manufacturing development or production estimates without proper incentives during the early R&D stages of a program. Costs escalate significantly in the early stages and such errors can be very expensive. Once production begins, costs generally stabilize because of automated manufacturing techniques, and the relatively repetitious nature of production. Hence, it is important to introduce appropriate production engineering expertise early in engineering development along with proper oversight to prevent “requirements creep.”⁹¹

It is important to introduce appropriate production engineering expertise early in engineering development along with proper oversight to prevent “requirements creep.”

As a program moves through the acquisition process it becomes easier to measure costs. The Commission endorses DoD’s recent implementation of the Defense Science Board’s recommendation to increase R&D funding. Nevertheless, there is further need for more movement in this direction. Fully resourcing programs during each phase—and especially the early phases—will decrease program turbulence and provide a basis for more reliable budget and schedule forecasting. Such a basis for resourcing will also allow better program management. *This full resourcing should also include the provision of financial reserves to resolve unanticipated problems.* The “Program Stability Wedge” initiated by USD (AT&L) is a step in the right direction, however, these resources should be under the control of Service acquisition officials, and not held at the Under Secretary level.⁹²

⁸⁹ This can be facilitated by use of two-year budgeting and multi-year contracting for the balance of the program phases, subject to DoD’s satisfaction with the program’s progress.

⁹⁰ As noted, some current and past programs have had development cycles approaching twenty years.

⁹¹ Historically, estimates are always significantly wrong. Weapons system development programs typically have cost overruns of 20 to 40 percent, and overrun initial schedule estimates by 24 percent. See “Best Practices: Successful Application to Weapon Acquisitions Requires Changes in DoD’s Environment,” United States General Accounting Office report to the Subcommittee on Acquisition and Technology, Committee on Armed Services, GAO/NSIAD-98-56, February 1998, p. 16.

⁹² The Program Stability Wedge was established to limit disruption in acquisition programs brought about by unexpected cost increases in a particular program. It attempts to limit the demand to migrate funds from healthy programs thereby affecting overall modernization plans. The stability wedge is a percentage of each Service’s R&D and procurement plans in the “out years” that is set aside by each Service in a fund to address unexpected problems in a program in the current year. USD (AT&L) works with the Services to

7. Improving Business Practices

This Commission views robust experimentation for the exploration of innovative technologies as essential, but it also recognizes the need for an effective screening process for the selection of mature, affordable technologies. DoD currently uses a complex four-phase acquisition schedule, where risks associated with the development of technology, design development, and manufacturing development are often spread across two and sometimes three phases of an acquisition program.⁹³ (See Figure 5)

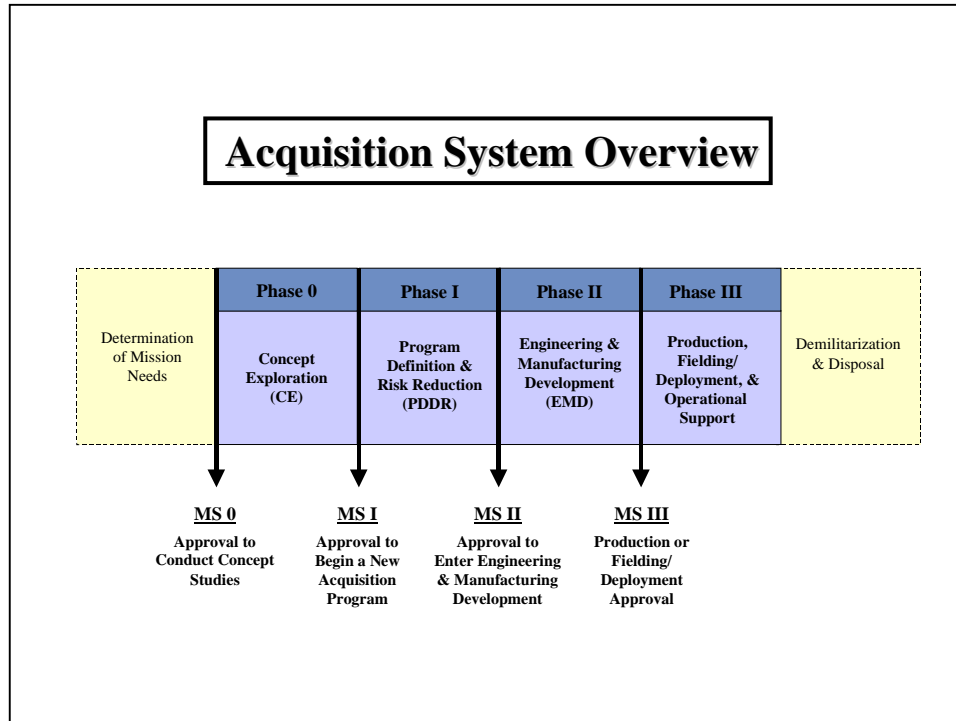

Figure 5. Current “Four-Phase” Acquisition System

Leading commercial companies employ a three-phase acquisition schedule, one that clearly separates technology development, product development, and production. (See Figure 6) This allows them to evaluate the maturity of a technology realistically before they initiate product development. *We therefore recommend that DoD institutionalize a three-phase acquisition process composed of technology development, product development, and production.* Such a three-phase system would focus on maturing technologies *prior* to production decisions and would identify problems earlier in a program to minimize risk and costs.⁹⁴ The Commission

help them determine how large their stability wedges should be, and must review and approve Service requests to draw from the stability wedge.

⁹³ The four-phase acquisition system was recently (October and November 2000) modified by the DoD into a three phase system. The process, however, is still in transition and most programs still function under old guidelines. See new DoD 5000 series directives and instructions available at <http://www.acq.osd.mil/ara>.

⁹⁴ “Defense Acquisition: Employing Best Practices Can Shape Better Weapon System Decisions,” Testimony before the Subcommittee on Readiness and Management Support, Committee on Armed Services, U.S. Senate, General Accounting Office report GAO/T-NSIAD-00-137, April 26, 2000.

endorses DoD’s recent adoption of a three-phase acquisition system. As we have emphasized above, the Department must minimize program turbulence at the product development and production phases. To do this within a three-phase system, however, *DoD must also adopt a “knowledge-based” evaluation and testing procedure to establish technology maturity, and to evaluate risks, costs and operational limitations.*⁹⁵ Testing needs to become the key part of the engineering development process as well as the verification of operational readiness.

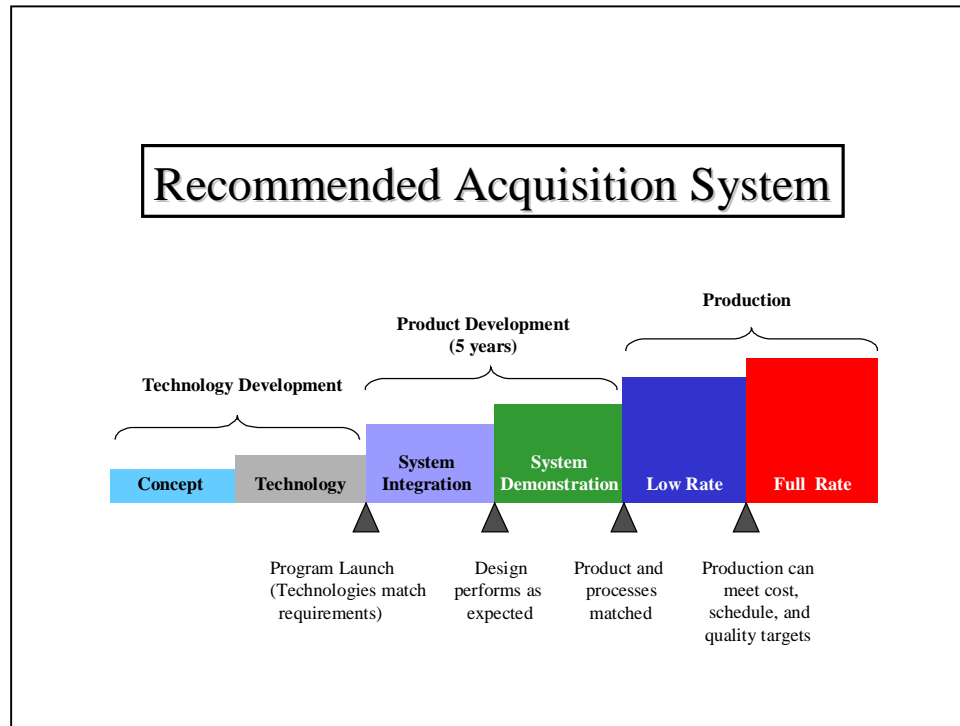

Figure 6. “Three-Phase” Acquisition System

Why is this necessary? As things now stand, DoD suffers program schedule and cost overruns, because it fails to allow technologies to mature sufficiently before placing them in production. Private sector industries have tested and verified fundamentally new technologies before they commit to full-scale development or production.

Moreover, the regulations and competition for defense funding requires the making of detailed projections at an early time on the basis of clearly insufficient information. Cost estimates are “forced” to coincide with projections of available funding. The competition for funding continues throughout program development, where success is identified less with technical achievement than with the ability to secure the next funding installment. Thus, there is little or reduced incentive to discover and reveal potential problems, and testing procedures during development essentially produce “report cards.” The lack of knowledge also makes it difficult for program managers to identify and dampen unreasonable expectations. Worst of all, testing procedures, short management tenures, and career pressures all combine to discourage

⁹⁵ “Defense Acquisition: Employing Best Commercial Practices Can Improve Program Outcomes,” Testimony before the Subcommittee on Readiness and Management Support, Committee on Armed Services, U.S. Senate, General Accounting Office report GAO/T-NSIAD-99-116, March 17, 1999.

program managers from attaining knowledge, demonstrating technological maturity, or assuring the viability of key manufacturing processes.

Clearly, the Department should not launch or allow programs to move on to subsequent milestones unless program managers can prove that technological maturity and program timelines can be met. The DoD must bring its acquisition system in line with best commercial practices, which embody incentives to encourage realism, candor, intelligent risk-taking, and meeting product expectations. *The Commission recommends that program reviews focus on the need, merit, and maturity of the program, and not be used to reopen past debates about the wisdom of the original program approval.*

Once the program has received approval, program managers should be given broad authority to manage their programs. They must possess the power and encouragement to make tough decisions, and DoD's testing practices should also change to support such tough decisions. Under the current system, testing occurs late and normally combines tests of subcomponents with total-system testing. This situation stems from the current orientation of using tests as "report cards" near the end of acquisition phases to secure funding for the next major milestone. Commercial production, on the other hand, tests early, tests hard, and tests often to identify problems and generate "knowledge" to feed back into program development.

Commercial testing is also more systematic. Companies thoroughly test subcomponents before combining into components, and thoroughly test components before combining them into subsystems and so forth. DoD testing should increase the use of computer simulation more than is currently the practice. To move in this direction, the Department must strengthen the testing mechanisms available to program managers, and exercise those testing mechanisms early during each phase of the acquisition cycle. OSD testing should also focus on overall system performance within the anticipated combat environments, not just on combat survivability.

DoD's acquisition process could also make more cooperative use of depots—whether the depot is government run, outsourced, or privatized—in the form of an acquisition cradle-to-grave teaming. For example, initial support for a weapon should come from the contractor, and should remain in place as long as the system is in production. This would allow access to current production lines and suppliers to help support the system. Half-way through the production run, the Department could start moving support (40/60 split) to a depot, and then compete depot against contractor for the largest share. As a weapon goes out of production, all the support work would then migrate to the depot.

The accumulation of laws and regulations that Congress has established to protect against fraud, waste, and abuse has created a nightmarish system of bureaucratic requirements and acquisition oversight whose net affect creates the very waste Congress intended

A system based on institutional distrust expends vast amounts of energy on regulation and not enough on the purpose for which it exists.

it to prevent. A system based on institutional distrust expends vast amounts of energy on regulation and not enough on the purpose for which it exists. Other laws, such as the False Claims Act, have the effect of criminalizing accounting "estimates," which by their nature are inexact. The current statute has a low burden of proof and no requirement to prove intent to defraud. In fact, fraudulent conduct *is* distinguishable from honest mistakes, however this act is often inappropriately used in contract disputes to impose

severe penalties. The False Claims Act adds regulations that deter commercial firms from

entering the government sector.⁹⁶ In a business world where speed and adaptability is critical for survival, a more sensible system of defense acquisition regulations is of the essence.

Equipping America's military forces will depend on improved relations between DoD and the commercial sector, as well as the current defense industrial firms. To reap the full benefit of new information technologies, DoD and the government must adopt the major tenets of the "Revolution in Business Affairs." The successes of the private sector in reducing costs, improving product development cycles, and rapidly adopting technology is predicated on a broad range of new business concepts. Clinging to outdated business models has ensured the downfall of many large companies, and DoD, with its outdated Cold War model, suffers many of their malaise.⁹⁷

To accomplish significant reforms, the NSSG urges the need to separate technology development from product development and change the product development cycle so that the process generates flexibility in requirements, full funding, and varied acquisition tracks earlier in the cycle, when product uncertainty is highest. Likewise, the Department should tighten requirements, funding, and contract types to reinforce expectations that as a product moves to the more expensive stages of the cycle, it will perform as expected and achieve delivery on time and within costs.

In short, the Federal Acquisition Regulations must allow DoD acquisition to operate within a new business model. They must not weigh down contractors with over-burdensome paperwork and regulations that impede agility and flexibility. If the Department is to attract leading edge companies to do business with DoD, the Federal Acquisition Regulations must better reflect business practices found in the private sector. Better cash flow and appropriate profit motivation are basic requirements to making the defense industrial sector innovative and efficient. The defense industrial sector faces the same demands that Wall Street places on all companies. With current regulations and levels of procurement activity, defense industrial base companies cannot remain viable. Indeed, the "regulation cost" in DoD and the defense industry is approximately 40 percent of the acquisition budget, while the management and control burden in private industry ranges from 5 to 15 percent—and is falling.⁹⁸

The defense industrial sector faces the same demands that Wall Street places on all companies.

DoD's oversight process suffers from four major flaws. First, it engenders an adversarial system that forces industry to extremes in accounting and business procedures. Oversight also includes the requirement to submit countless numbers of legal certifications, representations, declarations, and statements at every step of the acquisition and contracting process. Many such requirements exist in the FARs and drive the paper work burden, but do not exist in statutes. The 1996 Clinger-Cohen Act directed the reduction of such non-statutory requirements, but the Department has not fully implemented the Act.⁹⁹ Such pressures, for example, add approximately

⁹⁶ "Report of the Acquisition Reform Working Group," December 2000, p. 16.

⁹⁷ See "Best Practices: Successful Application to Weapon Acquisitions Require Changes in DoD's Environment," Testimony before the Subcommittee on Readiness and Management Support, Committee on Armed Services, U.S. Senate, General Accounting Office report GAO/T-NSIAD-00-137, April 26, 2000.

⁹⁸ Carnegie Commission on Science, Technology, and Government, "New Thinking and American Defense Technology," second edition, May 1993.

⁹⁹ See, "Report of the Acquisition Reform Working Group," pp. 21-22, which cites Public Law 104-106, Section 4301.

18 percent to the cost of products and services purchased by the Department's labs.¹⁰⁰ These requirements also contribute to the refusal of many companies to do business with DoD at all.

Second, excessive regulation creates costly inefficiencies that often lead to products inferior to those produced under private sector regulations. As noted above, OSD employs a "division equivalent" of auditors by itself. Moreover, these are complemented by multitudes of various Service auditing organizations. Redundant requests for information are common. Contractor and government auditors duplicate each other's work, and generally fail to consider each other in audit planning and execution—yet government auditors typically "live" with the larger contractors. The whole system of acquisition could gain greater efficiency by simply coordinating internal and external auditing.

OSD employs a "division equivalent" of auditors by itself.

Third, the current system has a propensity to put the auditor in the role of *second-guessing decisions* using facts and information often not available at the time of the decision. Such an approach is destructive and creates timid decision-making within DoD that inhibits the taking of meaningful risks that could benefit many programs. Auditors must focus on how managers examined the options available to them at the time, and then, whether these managers made a reasonable decision based on that information.

Fourth, auditing and oversight still focuses on *process* versus *output*. Oversight is necessary, but the Congress must allow DoD to adopt oversight procedures in harmony with standard commercial business processes in meeting the government's need for cost data. Traditionally government audits are always behind schedule—anywhere from one to five years.

Problems will still occur, but that price is less than the cost of excessive oversight created by too many auditing layers. The cost of occasional problems is far less than the benefits gained from adopting a modernized auditing philosophy. ***The Commission therefore recommends that the Congress modernize Defense Department auditing and oversight requirements by rewriting relevant sections of U.S. Code, Title 10, and the Federal Acquisition Regulations.***

To make this recommendation work, Secretary Rumsfeld must exercise significant leadership and work with the Congress to change the existing culture throughout the acquisition and procurement infrastructure. And in every sense, he will confront intractable and difficult problems, because the current culture is deeply resistant to change. But the culture of the acquisition community is not the only problem.

Positive actions taken in the past decade have paid off only when *both* DoD program managers and industry changed their way of doing business.

Industry often fails to take advantage of flexibility in government regulations, because it is often easier to follow old procedures than to manage the relationship to its fullest potential. Positive actions taken in the past decade have paid off only when *both* DoD program managers and industry changed their way of doing business. Changing the FAR, however, would go far to incentivizing rational behavior on both sides of the fence.

Excessive regulation involves not only auditing and oversight burdens. It also goes to the heart of the business relationship—the making of money. The specialized nature and low relative

¹⁰⁰ *The DOD Cost Premium: A Quantitative Assessment*, December 1994, Coopers and Lybrand and TASC.

volumes produced for DoD programs has been a major factor hampering the Department's ability to work with commercial companies and adopt more efficient practices. However, computer controlled machine tools and other modern manufacturing processes make the term "government unique" almost obsolete. Economies of scale no longer require massive lots of production of identical items. Changes in regulations, funding more technology experimentation, and staging technology transitions to move toward production more quickly—along with achieving program stability once in production—will significantly help in efforts to expand participation in the defense industrial base.

8. Incentivizing New Behavior

The impediments to effective reform are significant. The greatest of these is the lack of incentives to break the current cycle of initiating and sustaining weapon programs without making hard tradeoff decisions. Despite the known costs and inefficiencies, and a general inability to generate and absorb innovation, the current system meets many diverse "needs" of its major participants. In effect it has created a system of self-sustaining incentives for the status quo. This is evident from a cursory examination of the organizational needs of major stakeholders in the current system.

For the *Services*, the system provides military capabilities, but also helps in defining roles and missions. Moreover, it justifies budget levels and shares.

For the *OSD Staff*, the system provides organizational influence. It is a vehicle to provide independent advice to the Secretary and represents a justification for leveraging more power from the Service staffs.

For the *CINCs*, the prime "customers" of the acquisition system, it furnishes their near-term warfighting needs, albeit inefficiently.

For the *Defense Industrial Base*, the system generally absorbs cost overruns and still provides jobs, careers, and minimal profits. As monopolies and/or duopolies, large firms in a number of defense market sectors jealously protect their turf and use programs as vehicles to influence political decisions.

For *Congress*, the system provides many positive and negative issues on which to campaign: jobs and projects to meet constituent interests, as well as opportunities to "run against the bureaucracy."

As independent actors, these participants act "rationally" within the current system. They see their own needs as aligned with national interests. However, collectively, these needs create an environment encouraging destructive parallel parochialism. It certainly compromises good judgment. For example, is it reasonable to expect program sponsors to present objective risk assessment, report realistic cost estimates, or perform thorough tests, when such measures expose programs to disruption, deferral, or even cancellation? Because it is not reasonable to do so, a level of cost growth, performance problems, schedule delays, and difficulties with production remain essentially embedded in acquisition programs from the start. Because the system focuses on *process* instead of *accountability* and *output*, everyone is "safe."

Collectively, these needs create an environment encouraging destructive parallel parochialism.

Seen in this light, blaming acquisition problems on program managers (or any other single participant for that matter) overlooks the fact that these problems are the collective responsibility of all who participate. Thus, the Services' ability to change requirements during the execution of development contracts generates enormous cost growth. But this is acceptable to contractors, who more often than not, operate in a "cost plus" environment. There is no incentive for efficiency under such conditions. Several recent changes in DoD's profit policy—to provide more cash to companies without any requirement to improved management or performance—further incentivize wasteful behavior. On the other hand, Department's insistence that contractors must return all cost savings from improvements in efficiency to DoD is a *disincentive* to the very efficiency it seeks.

Strong incentives to support acquisition programs compromise the entire reform climate.

Strong incentives to support acquisition programs compromise the entire reform climate. It is easier to find ways to "afford" programs—by accepting increased risk, stretching programs, or limiting programmed buys—than to make hard decisions based on affordability or performance. Support grows as programs mature. Contractors deliberately find subcontractors in several states to leverage political support. Such efforts win high-level sponsorship *before* the lower level staffs formally review program milestones. Once weapons systems are in production, an even larger problem exists in ending "good" programs. Political desires to sustain local jobs along with more elevated arguments about preserving defense industrial capacity inevitably extend programs beyond their rational utility and complicate force modernization.

Past efforts to reform the acquisition process have emphasized coercive procedures to change the current system. Such proposals have suggested adding controls, increasing management, as well as streamlining and centralizing. *But none of these attempts have changed the basic incentives or pressures that drive behavior.* Despite incentives to reduce cost growth in a fiscally constrained environment, the motivation to preserve programs, force structures, and missions has always prevailed. Thus, to implement real change, as proposed in this Commission's recommendations, the incentive structure must change as well to:

- Produce a willingness to make a sacrifice in order to achieve better outcomes.
- Produce a recognition that broader consequences will follow from individual actions.
- Discourage excessive optimism, parochialism, and protection of immature programs.
- Use competition to improve programs and help resolve decisions.
- Address Congressional needs and incentives as well as Executive Branch problems.

This last point is extraordinarily important. When the participants in the acquisition process view the Congress as *always* ready to overturn decisions, there is no compelling reason to make changes in DoD itself. To achieve true reform by changing the incentive structure, the following four aspects of implementation are critical:

First, for DoD to manage and properly maintain oversight of the nation's defense needs, it must attract and maintain qualified trained and experienced personnel well versed in both technology and modern business practices—not just the FARs. DoD must provide continuity by

retaining program managers at least through major milestones. Moreover, the Department must maintain a working environment that empowers personnel at all levels. Such policies will encourage a more aggressive, less timid evaluation process.

Second, the Department must create direct monetary incentives for good program management. In the pre-program, R&D phase, which could last several years, the Department must incentivize and fully-fund experimentation. However, as programs move into later phases, it should consider different incentives. When programs come in on time or ahead of schedule, it needs to award the Service or the program a small increase in TOA.

Third, the Department must deposit acquisition authority, accountability, and responsibility in a single place. The current practice of diffusing authority across several staff agencies within the Pentagon breeds mismanagement. No one is responsible, and no one can be held accountable. The proper place to run acquisition programs is the Services, not an OSD “Czar,” who gives an illusion of accountability.

Fourth, a political mechanism may be necessary to allow the Secretary of Defense and the Congress to kill truly wasteful and under-performing programs. This may require the creation of a standing independent bipartisan commission similar to the Base Realignment and Closure (BRAC) Commission. Such a commission, sponsored by both the Administration and the Congress, would allow both branches of the government to work together and meet parochial concerns and backlash with answers based on wider national interests. It would create a release valve to escape the pressure of political incentives to sustain the status quo.

Section III. Military Capabilities Reform

The reformation of policy mechanisms, structures, and process would allow the Department to transform its military capabilities. To secure this nation in the world the Commission sees emerging, would require a different mix of capabilities than presently exist. The Commission summarized and prioritized the needed military capabilities in its Phase II and Phase III reports as:

- *nuclear* capabilities to deter and protect the United States and its allies from attack;
- *homeland security* capabilities;
- *conventional* capabilities necessary to win major wars;
- rapidly employable *expeditionary* capabilities; and
- *humanitarian relief* and *constabulary* capabilities.¹⁰¹

Most, but not all, of these capabilities exist today. Of those capabilities that do, the Services and the Department have not adequately structured, shaped, or resourced them to achieve the strategic ends paramount to future requirements. To place these capabilities in their proper balance, DoD must change the way it plans, trains, organizes, and equips its military forces.

The Commission has focused its efforts on the strategic and policy making levels. Thus, it has produced an overriding National Security Strategy, not a National Military Strategy, nor a detailed Defense Planning Guidance. It would be inappropriate then for the Commission to dictate the exact number and type of divisions, wings, and naval battle groups the United States needs to execute a National Military Strategy. That is a task Secretary Rumsfeld and a remodeled Department should perform—given clear guidelines and direction from the National Command Authorities (NCA).¹⁰² That is where government accountability rests, something the Commission has consistently encouraged.

The Commission would be remiss, however, were it not to make a number of observations based on its research and analysis since Phase II. In its second phase report, the Commission stated that the current Two Major Theater War (2MTW) yardstick “is not producing the capabilities needed for the varied and complex contingencies now occurring and likely to increase in the years ahead.”¹⁰³ To provide further strategic direction to the Department, the Commission recommended expanded guidelines regarding the force sizing requirements of future defense forces. The Department needs to shift from a threat-based sizing metric to a capability-based one. While some will argue that the current 2MTW approach is “capability-based,” the Commission emphasized that the 2MTW forces are clearly focused on traditional “threat” scenarios.¹⁰⁴ Not surprisingly, the inflated force figures (order of battle) in the Defense Planning

¹⁰¹ USCNS/21, *Seeking a National Strategy*, p. 14, and USNS/21, *Road Map for National Security: Imperative for Change*, 15 March 2001, pp 78-79.

¹⁰² The term “National Command Authorities” refers to the President and the Secretary of Defense, who are in the military chain of command.

¹⁰³ USCNS/21, *Seeking a National Strategy*, p. 14.

¹⁰⁴ Despite its frequent use, OSD, the Joint Staff, and the military departments have never defined the term “MTW” in open literature. We infer it to require all forms of military capability (land, sea, air) on the scale equivalent to the Gulf War or that envisioned in the past for North Korea.

Guidance’s “Illustrative Scenarios” drive specific force structure requirements beyond realistic needs. Finally, it should size and shape U.S. forces against a strategy of **detering** war, **precluding** crises from evolving into major conflicts, and **winning** wars rapidly and decisively, when necessary.

A. Force Sizing Requirements

As the Commission indicated in its Phase II report, the concept of fighting near-simultaneously two major theater wars, the current basis for U.S. military force structure planning, has not produced the capabilities this nation requires. The commitment to readiness for all-out engagement in two widely separated regions of the world at the same time, without strategic prioritizing and sequencing of campaigns, is in itself an extraordinary notion. To envision at this period in history, two opponents capable of and willing to challenge the United States at the theater-wide level of conflict and doing so simultaneously is an even more extraordinary notion. In the Second World War, the only historically relevant example, the Allies established an overarching set of priorities and acted in accordance with that understanding. Thus, the United States focused first and foremost on the defeat of Nazi Germany. The NSSG finds it

The NSSG finds it difficult to envision just where over the next several decades the United States would find two opponents with both the capability and intent to fight large armored ground wars.

difficult to envision just where over the next several decades the United States would find two opponents with the both the capability and intent to fight large armored ground wars requiring the commitment of forces comparable to those used in Desert Storm. Conversely, other possible contingencies that would demand significantly different power projection assets, such as a possible conflict in the Taiwan Straits, have not received the attention they deserve.

Even if the United States were to move toward a policy of more limited engagement in the world, the primary challenges confronting the U.S. military would still be complex contingencies. Those challenges beg for a transformation of the U.S. military. Ironically, this requirement could lead to establishing a new force structure “floor” for the military that was actually higher than the current 2MTW standard. Far more likely, are the need to retain readiness for a major conflict, while securing the homeland and responding to small-scale conflicts, international terrorism, peacekeeping, humanitarian actions, and other commitments, such as securing access to space, which would require U.S. support. Failure to plan for the more likely requirement impedes the *transformation* process needed to produce capabilities better suited to the current and emerging security environment.

1. Problems with Current Force Planning Process

The institutional processes that defined and constructed the current 2MTW force were continuations of those that fielded the successful Cold War and Desert Storm forces. It is therefore reasonable that the Pentagon continued an accepted process that rationalizes current force structure and capabilities. Yet, the threat forces against which the Department constructed these 2MTW units have either disappeared or are significantly diminished in current capability. The current 2MTW yardstick focuses excessively on two scenarios, one of which—North Korea—analysis has consistently inflated and which is increasingly less likely. The Southwest Asia scenario is also little more than a strawman. Current rapid deployment forces, combined with prepositioned assets, could handle a conflict in that area, especially in view of the modest capabilities of both Iranian and Iraqi forces and U.S. experience with the latter during Desert

Storm. The decade just past has been a reasonable precursor to that which will follow. That is a world in which the United States has no peer competitor, but faces threats to its homeland from a widening array of actors on the global stage with access to weapons of mass destruction and disruption. A strategic environment where the likelihood of an interstate conflict threatening U.S. interests is diminishing, while intrastate conflict in areas important to U.S. security is on the rise. And the U.S. military has not been paying attention.

Another factor hindering transformation is the perceived deterrent value provided by the declared 2MTW “strategy.” In fact, the reality is that the United States does not now possess a true 2MTW capability as currently defined—a fact that no potential adversary could miss. The process of changing from a 2MTW declaratory policy may result in some short-term political turbulence. But given the window of opportunity the Commission defined in Phase I—no global competitor likely to arise over the next 25 years—this is the time to make the transition with minimum risk.¹⁰⁵ The NSSG believes the greater risk by far would be an unaltered force that proves unsuitable and ineffective in the future, a development that would ultimately harm U.S. credibility and coalition leadership far more seriously.

The reality is that the United Stated does not now possess a true 2MTW capability as currently defined—a fact that no potential adversary could miss.

Resource availability is another major consideration impeding change. Within the 2MTW construct, the cost of transforming the current structure into forces more relevant to the modern security environment can only occur if defense spending increases significantly (\$20 to \$60 billion plus per year), or if resources are made available through significant reductions in current force structure. The first of these alternatives seems unlikely and could be compounded by efforts to increase space and missile defense funding; the second is worrisome to the military Services accustomed to operating the kinds of forces they presently possess.

The Commission clearly emphasizes that the current 2MTW construct is a force planning tool, not a “strategy.” As a planning tool, it is utterly inadequate for the Commission’s strategy, or any other strategy that focuses on the future. The 2MTW planning construct fails to support transformation and over-invests in the past. A useful force sizing tool must both *shape* and *size* the force, but the present method only preserves *size*, by assuming that complex contingency requirements are “lesser included demands” satisfied by current forces. While some diversity of capability exists within different types of units, the NSSG contends that force capabilities are not infinitely flexible or fungible. It emphasizes the need to *shape* the military to ensure that U.S. forces prepare for a wider range of operations with extremely deployable, lethal, and agile units.

Military forces cannot train and hold themselves ready for a wide number of fundamentally different missions without degrading readiness required to execute their primary war-fighting missions. Force capabilities are not seamlessly transferable. Forces trained for high-tempo combat operations cannot assume peacekeeper missions, and vice versa, without attendant loss of capability. As technologically advanced units assume duties other than their primary mission, the more time they require for training—and retraining upon return—at both individual and collective skill levels. Time required is a function of personnel, equipment, and unit preparation. Personnel must retrain in their collective skills to required levels of proficiency. Even with an absolute priority in training resources and funds, one cannot assume a unit returning

¹⁰⁵ USCNS/21, *New World Coming, Major Themes & Implications*, p. 4.

from peacekeeping missions could restore its normal level of combat proficiency faster than peacetime training cycles dictate. Of course, the Department can continue to place unit personnel on an accelerated schedule, but this near round-the-clock activity engenders attendant morale and discipline problems. Such operational tempo and personnel tempo (OPSTEMPO and PERSTEMPO) “churn” required by the current 2MTW requirement is wearing U.S. military forces out at rates faster than planned, while it is also robbing modernization accounts to pay for current operations and maintenance.

The NSSG recognizes full well the high opportunity costs of the current force posture.

The NSSG recognizes full well the high opportunity costs of the current force posture. It sub-optimizes forces for contingencies, it defers modernization, and it crowds out transformation. Worse, the precipitous readiness erosion inside today’s armed forces will accelerate unless the Department realistically matches its forces to anticipated uses. The

current system prevents the force from transforming and is leading to what many believe is a defense death spiral.¹⁰⁶

2. A Capabilities-Based Planning Process

Despite the factors which militate against change, the world has evolved, and the rate of change in coming decades will only increase. A vital ingredient in the justification for moving from a threat-based to a capabilities-based approach is the proliferation of growing global technology into the hands of both state and non-state actors. This alone introduces a higher modicum of uncertainty into the planning process. The overarching challenge still stands—how to refocus U.S. military force planning to meet tomorrow’s threats, opportunities, and requirements. As stated, force planning should both *size* and *shape* U.S. forces against a strategy of **detering** war, **precluding** crises from evolving into major conflicts, and **winning** wars rapidly and decisively when necessary. The answer lies in how the Department organizes its force capabilities for the future, and how it manages that transformation. Accordingly, *the Commission recommends that the Secretary should direct the Department to shift from the threat-based, 2MTW force sizing process to one which measures requirements against recent operational activity trends, actual intelligence estimates of potential adversary’s capabilities, and national security objectives once formulated in the new Administration’s national security strategy.*

This commission believes that the United States should maintain sufficient capabilities of the kind it now possesses, with some modernization, to prevail against the possible emergence of a theater level opponent. Further, the nation’s military must develop the ability to deal with small to medium violent conflicts requiring very rapid, forced entry response, as well as long-term stability operations in tense, post-conflict scenarios. Land, sea, and air capabilities suitable to such a security environment must possess speed, agility, lethality, ease of deployment and sustainment, and highly networked connectivity. Peace keeping and humanitarian duties should be reduced, but will likely continue, with their inherent constabulary requirements. The U.S. military must also organize and train for these missions. Finally, the Department of Defense and the federal government must place new emphasis on the special needs of homeland security.

¹⁰⁶ Daniel Goure and Jeffrey Ranney, *Averting the Defense Train Wreck in the New Millennium*, (Washington D.C.: CSIS Press, 1999).

In using the current 2MTW-based force sizing process, military planners consider “illustrative” scenarios and force structures of Iraq and North Korea and then provide sufficient friendly forces to ensure a high degree of success to U.S. efforts. Using attrition-based modeling tools, planners determine likely military outcomes in these scenarios.¹⁰⁷ The models emphasize mass, firepower and survivability against large, traditional threats. In the end, such models call for more friendly forces to achieve success than Desert Storm experience or common sense would dictate. Consequently, the large numbers of forces that must be assigned to these scenarios ensure that force planners have limited assets remaining to execute other missions.

In a capability-based sizing process, such as this Commission has recommended, military planners would identify the types of missions necessary to implement the NCA-assigned national security objectives and then structure defense programs and military force capabilities to accomplish those missions. Planning must rest on updated modeling techniques (discussed above in the PPBS section) that emphasize “effects” over “mass.” Modeling should highlight the synergistic effects of Joint forces with modern weapons employed in a networked environment against symmetrical and asymmetrical opponents.

During the transformation to a capability-based force, the NSSG recommends retention of near-term capabilities to fight a major theater war with forces currently in the inventory, with some modernization. Ideally, planners should posture the “MTW” force against a “composite” and modernized threat, one that exhibits the most threatening capabilities projected for Iraq, Iran, North Korea, and possibly others. Such an approach would require operational utility in various terrain and environments, as well as capabilities for war fighting, power projection, control of required environments (air, land, sea, and space), strategic lift, and logistic supportability. Such demands should also include integrated capabilities for sustained land combat operations ashore, as well as sea- and air-based power projection options. The NSSG proposes the creation of forces capable of a robust and unilateral response in any theater with minimum access to host-nation support or mature infrastructure. Such forces would provide a deterrent hedge against the possible rise of a regional competitor or hostile coalition. Under this construct, the United States would build the capacity to respond, either East or West, to a major regional conflict with lethal, decisive forces against an adversary (or adversaries) whose military technology will obviously not equal those possessed by U.S. forces for the foreseeable future, but who may miscalculate U.S. political will.

The NSSG recommends retention of near-term capabilities to fight a major theater war with forces currently in the inventory, with some modernization.

This theater warfighting force would preserve America’s war winning capabilities and enable victory, if the United States were to find itself engaged in a major war. These conventional forces would primarily constitute the high-end “deter” and “win” components of the Commission’s proposed Phase II strategy. Such a force would consist of active, as well as reserve forces, maintained at higher levels of readiness. Additional reserve tiers of readiness would exist as a hedge against other unexpected conflicts. A major contingency would result in commitment of other rapidly deployable active and reserve forces, while incorporating allied capabilities, where present.¹⁰⁸ Forces committed to less critical small-scale contingencies would normally find

¹⁰⁷ See above in the PPBS section, (II, A, 7).

¹⁰⁸ Note this construct is similar in some respects to the strategy reflected in National Security Decision Memorandum 27 (NSDM-27) of 1969, which was known as the “one-and-one-half war” doctrine, which emphasized including America’s allies in force sizing requirements.

themselves retasked to higher priority missions recognizing a considerable degree of difficulty in redeployment.

As the transformation process continues, the primary focus of the U.S. military will gradually emphasize multiple complex contingencies and homeland security. Noting that U.S. overseas bases and force structure have decreased dramatically over the last decade, while the frequency and duration of commitments has increased, the transformation process must maximize fielding fast, agile, and rapidly deployable forces. For example, assuming our national strategy required the stabilization of a region by military intervention in a fragmenting country, capability-based force planners would design units strategically deployable, logistically sustainable, operationally agile, highly survivable, and extremely lethal. Properly trained and equipped, this intervention capability would be militarily useful anywhere in the world. Furthermore, due to their enhanced operational characteristics, such units would possess utility, whether employed in a fragmenting country or participating in a regional conflict. The end result of a capability-based process, freed from the constraints of 2MTW illustrative scenarios, would be an extremely flexible, highly capable military force.

Properly trained and equipped, this intervention capability would be militarily useful anywhere in the world.

An equal focus on multiple complex contingencies would also shape the U.S. military to ensure that its forces were prepared to engage in a wider range of crisis response missions. Such rapid expeditionary forces would contribute to a “**deter**” and “**win**” capability, but would primarily represent the “**preclude**” component of the Commission’s proposed Phase II strategy. Some forces will require rapidly deployable, lethal, and agile units, while others will demand little lethal capability. At a *minimum*, U.S. military forces need to be able to execute three *different* types of missions simultaneously rather than focusing on contingency levels that just total “three.” Engagement and stability operations are also necessary for implementing preventive strategies. They have in the past, and will continue in the future, to account for a great drain on resources. They require equal emphasis and provisioning in force planning requirements.

The NSSG has examined the implementation of these recommendations by exploring needed changes in military forces and military capabilities. We have gathered enough data points across the 1990s to plot future directions for the armed forces. It is now time to act.

B. Military Forces

The forces detailed below are “idealized,” in that they represent desirable endstates of a long transformation process. They present military planners a holistic force structure vision between the suggested force-sizing metrics above and the more detailed military capabilities that will follow. These are based on the Commission’s five capabilities specified in the Phase II and Phase III reports. Resource availability will obviously constrain the journey towards this vision.

America’s *ground* forces need significant rebalancing. The NSSG applauds ongoing efforts to create less heavy, more readily deployable ground forces that can rapidly deploy and fight in organizational structures below division level, where appropriate. The U.S. military must also preserve some modernized heavy capabilities to conduct sustained operations in a high-tempo war against a regional opponent. Rapid response capabilities are necessary to counter possible anti-access strategies, when the United States aims at projecting its forces into a theater. The difficulties in sequencing rapidly deployable forces and heavier forces needs

attention, because the United States cannot suffer delays in its ability to escalate combat power. The Department needs to trade off some near-term heavy and light capabilities to achieve these future modernization goals.

Future ground forces need the ability to conduct operational and strategic maneuver by closing on an objective from all directions and dimensions, air, land, sea, and space. Possessing strategic speed, ground forces optimally must arrive in a threatened theater early enough to preclude enemy ground forces from taking offensive action or achieving operational objectives, should hostilities begin.

The Department needs to balance deep maneuver and strike capabilities reasonably against overall needs. Ground forces will have to operate within a joint environment that brings the many complementary precision strike capabilities of air and naval forces into play. An intervening ground force should have the ability to achieve dominance in combat power on arrival. The operational intent must be to exploit dominance in situational awareness to sense, track, and anticipate enemy movements and place discrete, but decisive, forces unexpectedly against enemy centers of gravity at minimum risk. The operational objective would be to rob the enemy of the advantage of time, while achieving rapid and decisive results.

Ground forces, as with air and naval forces, seek combat efficiencies by subtle trade-offs between protection, mobility, firepower, and information. If increases in range and precision firepower correspond to increases in information and situation awareness, then military forces can often trade off protection for mobility. They can avoid hits and achieve mass by ranging the enemy with precision firepower through maneuver, rather than by providing heavy protection in the expectation of enduring close-in fires.

If increases in range and precision firepower correspond to increases in information and situation awareness, then military forces can often trade off protection for mobility.

Above all, the Department needs to evaluate more closely “tail-to-tooth” requirements and incorporate as much “reach back” as possible in combat support and combat service support functions without increasing the risk to combat forces. This would reduce deployment requirements and shrink the in-theater “footprint.” The objective should be to minimize in-theater logistic support, increase efficiency, and achieve higher “tail-to-tooth” ratios in theater, where the true measure must be improved operational effectiveness.

America’s ground forces must also have capabilities dedicated more directly to missions of lower combat intensity and operations without a clear enemy. This includes peace enforcement, peace keeping, humanitarian relief, and constabulary operations that obviously require greater civil support and military policing functions.

U.S. *naval* forces will continue to play an important stabilizing role within this country’s overall national security strategy—that of a mobile, sea-based containment and power projection force. The Department should rebalance future naval forces from several perspectives. First, the Navy should continue its emphasis on forward presence, but recognize that forward basing will likely decrease over the next quarter century. Thus strategic deployment from home must be a growing capability. This requires the building of tacit knowledge through sustained operations in key forward areas, and posturing for rapid response. Second, the Navy should provide a full spectrum of naval combat capabilities—not just strike. This means: stronger low-end capabilities; the need to maneuver; and the ability to fight anywhere, not just from

distant sanctuaries. Third, the Navy needs to own the littoral, which means the ability to assure access to the domains of competition. The Navy must acquire or use expeditionary sensor capabilities—space-based sensing may not be enough—and invest seriously in mine countermeasures. The Navy must be able to acquire access, fight decisively, and sustain itself and other forces in the littoral environment. Fourth, with respect to platforms, the swift and the many may dominate the slow and the few. Therefore, the Navy must examine buying different platforms in different ways. Finally, it must be able to secure the oceans for the world's commerce.

A percentage of funding for the surface combatant Navy should go to a family of new ships designed for the highly contested close-in littoral fight. These would be very fast survivable ships, low in cost with the ability to change missions through modular adaptations of different weapons loads. Such technologies are near at hand, and this approach could dramatically increase the size of the surface Navy with ships that could swing between the high and low ends. Adopting technology and modularization should also significantly reduce crew size.

Naval forces need to expect and counter anti-access strategies through defense, stealth, and speed.

Naval forces need to expect and counter anti-access strategies through defense, stealth, and speed. The Navy should accentuate its joint role in defeating anti-access strategies—theater missile defense—and include capabilities to defeat future precision-guided, advanced atmospheric vehicles that pose significant threats to future U.S. platforms and bases. The submarine force should adopt a high-low mix approach with the low end picking up many surveillance missions.

The Navy needs to improve its fire support for operations ashore. It needs to balance naval aviation, missiles, and guns to insure they are capable of fulfilling requirements for supporting ground and air operations ashore. Naval aviation should introduce some unmanned combat air vehicles (UCAVs) within this time frame, but the NSSG acknowledges UCAV limitations to conduct certain missions. The aircraft carrier will still be necessary for many reasons, including the importance of having a high-energy source at sea in a mobile, fairly high speed, and survivable platform.

Naval forces need to retain and build a powerful and rapid strategic mobility function and maintain a balance between strategic fast sealift, prepositioning, and intra-theater lift. Maritime prepositioning may eventually no longer be necessary with high-speed transports based on current fast-ferry concepts. However, before investing in a new round of advanced maritime prepositioned assets or in fast sealift, the Navy must conduct a detailed and thorough cost and operational effectiveness analysis (COEA) to examine the relative merits of using advanced hull forms and fast-ferry technologies.

Marine forces will need to meet tomorrow's diverse threats to prosecute the concept of expeditionary, maneuver warfare. Their current capability to strike *anywhere* in the world's littorals needs to be preserved, while at the same time, the operational flexibility of Marine forces in crisis response and conventional warfighting in both littoral and urban contexts needs expansion.

Future crisis situations will be dynamic and explosive in both their onset and nature. The continued validity of a strategically agile, expeditionary force-in-readiness is clear for both preventive responses and as early entry forces in support of a combatant CINC's campaign. The

Marine Air Ground Task Force (MAGTF) approach brings unique capabilities. It is sharply different than conventional land armies and contributes to a CINC's joint force capabilities. But the future also suggests demanding requirements for training and equipping Marine forces. These include substantive improvements in tactical mobility, lightweight sensors, and unmanned vehicles and logistics support that requires less of a footprint ashore.

In light of the pervasiveness of future anti-access strategies and missile proliferation, the Marines should seek greater range, mobility, and stand off distance for their maneuver forces. Modernization efforts to expand the operational reach of Marine air-ground forces and improve maritime pre-positioning or the use of "fast" transports should seek next generation capabilities. The Marines must avoid reinvesting in legacy systems. The *velocity* of Marine forces in both deployment and operational maneuver must increase.

In this regard, the Marines must acquire more agile and precise means of fire support to achieve *effects vice attrition* by sheer mass. Marine aviation must maintain its tactical responsiveness and flexible basing, but its fire support must become more precise. Future fire support requirements need sizing for both organic needs and within the joint context. Marine operations must take into account the increased joint capability of the armed forces that has become increasingly visible since Goldwater-Nichols, as well as the availability of standoff precision fire support. In stressing future MAGTF core missions, the NSSG sees the need to increase the lethality of Marine attack helicopter forces and explore the balance offered between rotary wing, fixed wing, and organic and joint precision fire support capabilities. The Corps must vigorously pursue efforts to reduce future fixed wing aviation's footprint.

The Marines must acquire more agile and precise means of fire support to achieve *effects vice attrition* by sheer mass.

Maritime forces need to ensure continued access to the littorals by evolving expeditionary capabilities that include mine and obstacle countermeasures, joint air support, and naval surface fires. Where adversaries develop an access-denial strategy, MAGTFs require the ability to identify and exploit seams to gain access or, if necessary, they must be able to overwhelm the enemy instead with the full range of capabilities necessary for forcible entry options. The ability to project combat power swiftly across long distances may require the dramatic flexibility of technological innovations, such as tilt-rotor aviation platforms.

The Marine Corps should examine and pursue alternative force structures for task organized expeditionary warfare across the spectrum of conflict. Scaleable Marine Expeditionary Brigade capabilities, more closely matched to the anticipated contingencies foreseen over the next several decades, are necessary. Such contingencies would place a premium on the Marine Corp's unique competencies, but also require greater velocity, easier sustainability, and modernized capabilities.

Air forces have made great strides towards air dominance as well as expeditionary warfare. In the future the Air Force should continue shifting the balance toward creating longer range, high precision forces that permit the rapid projection of distant influence and power without projecting vulnerabilities in the same ratio.

The Air Force needs to hone a global response capability that focuses on reducing response time from days to hours and minutes. It needs to continue migrating functions to space, when practical, while ensuring seamless integration for the joint team. This should occur at the

expense, if necessary, of close air support capabilities. The United States needs to maintain control, as needed, of vital airspace and air lines of communications in regional power projection contingencies and air and space denial/control operations. Similarly, air forces must retain their air mobility roles in support of the Department's full spectrum power projection capabilities. That mobility is also critical for contingency operations such as peace enforcement and disaster relief. The air-breathing role in C4ISR will continue over the near term, but eventually where practicable it will move to space.

Over time, the Commission anticipates the reduction of permanent forward operating air bases. Thus, future air forces need to contribute to U.S. strategy through long-range and rapid expeditionary air operations that defeat an enemy's anti-access efforts that aim at countering U.S. power projection.

The future Air Force should continue to adapt stealth, standoff, and high-precision capabilities into its weapons and platforms. Efforts should include information operations, miniaturized weapons using multi-spectral, semi-autonomous, and self-adopting seekers and guidance systems that can overcome camouflage, deception, and dispersion techniques. Information operations must combine with adaptable munitions to produce precisely definable effects—both lethal and nonlethal that minimize physical and political collateral damage. In the future, U.S. adversaries will mingle their combatants among civilian populations or enterprises. The Air Force needs to continue development, testing, exploration, and adoption of unmanned systems, to include expendable standoff weapons and reusable UCAVs, for those missions where their use proves feasible and offers efficient operational advantages.

The Air Force needs to continue development, testing, exploration, and adoption of unmanned systems, to include expendable standoff weapons and reusable UCAVs.

Information operations must combine with adaptable munitions to produce precisely definable effects—both lethal and nonlethal that minimize physical and political collateral damage. In the future, U.S. adversaries will mingle their combatants among civilian populations or enterprises. The Air Force needs to continue development, testing, exploration, and adoption of unmanned systems, to include expendable standoff weapons and reusable UCAVs, for those missions where their use proves feasible and offers efficient operational advantages.

The combination of theater and long-range air forces needs to be highly survivable and capable of operating with limited or no forward deployments, while integrating information and space capabilities to achieve desired effects. Future air forces also need great flexibility and the capability to operate jointly with both ground and naval forces across the spectrum of conflict.

Systems operating in *space* should receive greater focus as essential supporting elements for all joint forces. Consequently they need protection. Future efforts should continue to emphasize a shift from terrestrial military force structures and supporting capabilities to placing significant investments in space, wherever practicable, to exploit American technical and strategic advantages. The command, control, communications, computers, intelligence, surveillance, and reconnaissance (C4ISR) capabilities provided by space forces could replace many terrestrial and theater-based systems, while significantly reducing the logistic tail and footprint of current power projection forces.

The United States must adopt a hedging strategy and move towards the capability of controlling the space medium, if necessary, over the mid- and far-term. This requires continued progress in developing both directed energy and launch-on-demand capabilities. If necessary, limited numbers of space-based, conventional precision weapons or energy weapons could augment forward-based forces. This would further reduce strategic *lift* requirements needed to realize global and regional force projection. Such weaponization of space, if pursued, would

include weapons capable of employing into space, in space, and from space.¹⁰⁹ Space-based weapons could also complement other *combat* force structures, possibly reducing the need to concentrate major platforms that support target coverage. *The NSSG does not recommend that the United States pursue either space “control” or that it immediately rush weapons into space. It does believe, however, that the United States must develop the latent capacity should circumstances demand such action.*

C. Military Capabilities

Given the preceding discussion on force sizing requirements, and the above vision for military forces, the NSSG deems it essential to relate these elements to the five military capabilities proposed in the Phase II report and slightly expanded in the Phase III report. As stated in *Road Map for National Security*, it would be inappropriate for the Commission to delve into detailed force planning recommendations. However, it provides guidance and a *mechanism* to move the Department in the necessary direction. ***Accordingly, the Commission recommends that the Secretary should revise the current categories of Major Force Programs (MFPs) used in the Defense Program Review to focus on providing a different mix of military capabilities.***

As noted in the PPBS section above, the original MFPs tried to enhance oversight of the defense budget by producing a number of common categories across Service defense programs. Theoretically, this allowed the establishment of objectives and the measurement of progress toward those objectives. Unfortunately the MFPs lacked sufficient definition—and OSD lacked sufficient will—to establish useful objectives. The system has remained unchanged since 1961 with the exception of a new category, Special Operations Forces, added in 1987 in response to the Cohen-Nunn Amendment to the Goldwater-Nichols Act. Given the need for transformation, the Department must update the categories of Major Force Programs, and use them as they were originally intended—to measure progress toward prioritized objectives. This should become a key tool in imposing true management reform on the Department.

The Department must update the categories of Major Force Programs, and use them as they were originally intended—to measure progress toward prioritized objectives.

At present, only three of the current eleven MFPs focus on military “forces,” while the remainder includes defense support activities. Of the three MFP “force” categories, two are specific (Strategic Nuclear and Special Operations), while a single MFP category (General Purpose Forces) contains **all** conventional capabilities. Thus, it provides no visibility over the types of capabilities needed, the direction required to transform the force, or the ability to measure progress towards that transformation. *The Department should create new MFPs corresponding to the five military capabilities the Commission deemed essential in its Phase II*

¹⁰⁹ It is worth stating that there are very few international legal impediments to such a course. The Outer Space Treaty bans only the deployment of weapons of mass destruction in space, and the Anti-Ballistic Missile Treaty only limits interference with national means of verification with respect to arms control agreements. Even the United Nations Charter, Article 51, states explicitly that no nation is precluded from taking appropriate defensive measures in any environment. See also “Report of the Commission to Assess United States National Security Space Management and Organization,” January 11, 2001, pp. 36-38.

report. This would better reflect future requirements and force objectives and ensure a permanent mechanism to implement needed changes within DoD. We expand on those capabilities below.

Strategic nuclear forces must retain the ability to perform their classic role of nuclear deterrence against WMD actors. However, strategic defense should also be factored into strategic offensive capabilities. In addition, the future security environment and probable strategic nuclear arms reduction efforts portend smaller arsenals that call into question the need and ability to maintain the three legs of the strategic nuclear triad in a cost effective manner. Future high precision weapons containing improved conventional explosives may well be able to strike targets previously reserved for nuclear weapons—fixed targets of limited physical extent. Therefore, the Department should give serious consideration to eliminating the most vulnerable and least responsive air-breathing leg of the triad. Long-range air assets released from this mission could carry standoff cruise missiles that would improve conventional air missions.

Homeland security forces must have the ability to deter, protect, and respond to threats to America’s homeland. Homeland security is not entirely a military function; it is a major interagency challenge. The bulk of strategic defensive military forces, both active and reserve, should remain under the purview of DoD. Enhanced border security should consolidate into the proposed National Homeland Security Agency detailed in the main Phase III report. Portions of the National Guard should transform themselves to assume their historic and Constitutional role as a premier force for defending and securing the homeland as well as responding to disasters. Most Guard units, not currently tasked to augment the active Army, could transition into military police, engineering, transportation, CBR defense, communications, and medical units that have great utility for homeland security (including humanitarian assistance and disaster response). Forces equipped to respond to natural, manmade, and/or WMD-triggered disasters should have state and regional as well as an out-of-the-continental United States (OCONUS) deployment capabilities. Such capabilities would enable the United States to respond rapidly to domestic and overseas disasters and lessen the need for active duty military forces to prepare for and conduct such missions.

Conventional forces need sizing and tailoring to threats defined by realistic scenarios and updated force modeling. For the foreseeable future, Army legacy-equipped, heavy units, “blue water” naval forces, full-spectrum air power, and Marine forced-entry units will provide this capability. Fewer such forces, however, are necessary to dominate potential threats than current assumptions and models have previously defined. Given likely limitations on strategic airlift and fast sealift, pre-positioned legacy equipment in regions at risk requires renewed emphasis, along with follow-on mobility provided by fast sealift.

Fewer such forces are necessary to dominate potential threats than current assumptions and models have previously defined.

The National Guard and reserve forces, maintained in peacetime at a higher state of readiness, would serve as the strategic reserve to mobilize upon declaration of a crisis. Forces not required for conventional response could begin the transformation process. Aviation support would come from theater or U.S.-based units, augmented by sea-based platforms, and space-based systems, if they become available.

Expeditionary capability must come from a combination of expeditionary marine, army, air, naval, and special operations forces. Enhanced MAGTF capabilities are essential as well as light and medium Army units. The naval component will need to shift its emphasis from super large platforms to include littoral and brown-water capable forces. Sea-based, firepower-intensive platforms must provide a critical element of this capability. Long-range, homeland-based or

overseas-deployed aircraft, or possibly space-based systems are essential for the delivery of precision munitions. To enhance their mobility, survivability, and lethality, and to reduce their logistic footprint, U.S. expeditionary capabilities should receive priority for modernization resources. These air, naval, ground and space forces must provide the United States with preemptive capabilities against major threats to national security, while retaining the ability to hold key assets of potential opponents at risk with conventional weapons.

Humanitarian relief and constabulary operations must come from some homeland security forces and residual Army light units augmented, when appropriate, by expeditionary Marine units. Potential crises would require light infantry, military police, engineering, medical, civil affairs, and logistics units in situations that anticipate low potential for combat operations. The Commission envisions the need for purely constabulary force as relatively small, but necessary. The “constabulary” descriptor does not infer non-military skills, or a lesser degree of proficiency. Such forces would focus on different tasks, similar to the elite constabulary forces of other nations. Interagency, non-DoD assets also need consideration for long-term, follow-on constabulary operations.

The Commission recognizes the transformation process will produce these five capabilities over time. Nevertheless, some must mature at a faster rate. Ultimately, the transformation process should render the distinction between conventional forces and expeditionary forces moot, as both types of capabilities would eventually possess enhanced mobility, survivability, and lethality. For the near term, however, expeditionary capabilities are the most critical to the existing and future security environments. *Consequently, the Commission recommends that the Department should devote its highest priority to improving and further developing its expeditionary capabilities.*

Ultimately, the transformation process should render the distinction between conventional forces and expeditionary forces moot.

D. Implications

Given the proximity of the next Quadrennial Defense Review and the Secretary’s strategic review, the Department must consider several additional points. Strategic mobility and responsiveness remain constrained by current capabilities, primarily by the amount of available airlift and sealift. Short of funding additional strategic lift, the only alternative to enhancing strategic mobility is to maximize use of pre-positioned assets in regions at risk. Furthermore, savings from defense infrastructure reductions, such as future Base Reductions And Closures (BRACs), will only occur over the long-term.

Significant increases in defense spending in the near term—of the magnitude needed to modernize the entire force—is desirable but highly unlikely. Therefore, modernization of force capabilities will necessitate force structure reductions or a *reduction in the force structure that requires modernization*. “Means” must be correlated to match “ends,” with acceptable risk, or the ends must be reduced. Without significant additional capital outlays, the Department will have to reduce the currently defined “end”—that of modernizing the entire force. The NSSG cannot overstate the criticality of clear direction and priorities. Without such guidance, the Department cannot explore tradeoffs, nor can it implement decisions through an improved planning, programming, and budget process.

As stated earlier, the Commission did not specify the numbers and types of units required—that is the task for Secretary Rumsfeld and a remodeled Department. The Commission has identified what the U.S. military needs to achieve for the future—U.S. forces capable of **detering** war, **precluding** crises from evolving into major conflicts, and **winning** wars rapidly and decisively when necessary. How to get there is best left to the responsible experts.

This nation may discover that a *transformed* U.S. force structure will require even more resources and generate a capabilities baseline that is actually higher than that required by the current 2MTW construct. But above all, the transformation process will require a reprioritization of current resources. Ultimately, the result may be a larger force, or a smaller one, but we are confident that it will be a *better* force—a force more suited to advancing our interests and defending against true threats.

Section IV. Implementing Defense Reform

President Bush and Secretary of Defense Rumsfeld surprised a great many people when they declared that a strategic review should, and would, precede any judgments about the scale and allocation of defense resources.

Let them be surprised.

It is high time that American leaders employed a serious strategy process to determine defense requirements. Secretary Rumsfeld clearly realizes that an intellectual process alone will not generate a force structure appropriate to the times, and that meaningful defense reforms cannot be achieved by “cherry picking” a handful of programs. The underlying reason the Pentagon has proven unable to generate a post-Cold War military is that its management mechanisms are broken. Its staffs are overblown. Its programming and budgeting system is sclerotic. Its acquisition process is out-of-synch with contemporary business practices and technological cycles. If these management deficiencies are not fixed, root and branch, no strategy review and no program pruning, no matter how well-intended or ripe for “picking,” will produce the desired results. The new Defense Secretary knows this and is selecting proven managers to address the problem.

If management deficiencies are not fixed, root and branch, no strategy review and no program pruning, no matter how well intended or ripe for “picking” will produce the desired results.

Secretary Rumsfeld has indicated a willingness to *rewire* organizations and *adjust* processes within the Pentagon. Even more important, he has begun to articulate a strategic *vision* of how the Department should operate, and what military capabilities it needs to produce. The Secretary is rightly focused on desired *outcomes*. In our view, those outcomes are seven-fold:

- *An OSD leadership function focused on strategic direction, resource allocation, and policy.*
- *Streamlined and efficient DoD infrastructure support systems.*
- *OSD management tools that tie resources to policy.*
- *OSD tasking functions that can reallocate resources.*
- *Reinvigorated military Services that embody authority, responsibility, and accountability.*
- *An acquisition system that fields technology faster than potential adversaries.*
- *DoD mechanisms that adapt to change and produce different military capabilities.*

To attain these objectives, defense reform must embody some underlying prerequisites, and must base itself on a prioritized game plan to see the effort through.

A. Defense Reform Prerequisites

The defense reform problem should be based upon four major prerequisites: linking reform efforts to strategic objectives; involving DoD senior management in the reform process; selecting critical initiatives to pursue; and establishing a sound implementation mechanism. We address each in turn.

1. Linking Reform to Strategic Objectives

The Commission recognizes a disconnect between the process of establishing national security objectives and the process of allocating resources. Responding to the complex threat environment requires an integrated approach combining the capabilities of a number of Executive Branch agencies—not just the Department of Defense. This can be achieved through a National Security Council-coordinated interagency planning process. Currently, crisis response consumes too much attention, leaving little time for deliberate planning. To correct this problem, the Commission recommends a crosscutting planning process that captures the President’s national security priorities and translates them into long-term plans to guide resource allocation.

The Commission proposes a framework designed to integrate domestic, foreign, military, and economic policies. The framework would guide national security activities by means of a strategic planning process that lays out how the allocation of resources serves the nation’s overall national security goals. Consequently, the process would institute closer coordination between departments and agencies, including DoD, on national security matters.¹¹⁰

The President should personally guide a top-down strategic planning process and delegate authority to the National Security Advisor to coordinate that process. This procedure would foster a coherent national security policy that effectively links policy, strategy, programming, and budgeting and would encapsulate the President’s national security vision. The National Security Council staff should prepare an outline of the President’s top priority national security goals and objectives based on his vision. The NSC principals¹¹¹ should then use the outline as a starting point to translate the President’s vision into defined, strategically critical goals and priorities.

Specific guidance from the NSC principals would constitute a relatively short, classified document.

Specific guidance from the NSC principals would constitute a relatively short, classified document (in the 20-25 page range) called the *National Security Planning Guidance* (NSPG). This document would link the President’s strategically critical goals and priorities with regional objectives. It would integrate foreign policy, economic, and military activities. It would assign responsibility for intelligence collection as well as planning for engagement and contingency operations. It would direct resource allocation among crosscutting activities, including preventive diplomacy, crisis response, non-proliferation, counter-terrorism, and homeland security. It would provide fiscal guidance to departments and agencies. Finally, it would specify directions for resource allocation to meet Presidential priorities. It is essential that the Director of the Office of Management and Budget (OMB) be involved to provide management, programming, and budgeting advice. The NSC Principals Committee (NSC/PC) and OMB would review the NSPG, ensuring that it incorporates coordinated policy direction and priorities.

Once the President determines that the *National Security Planning Guidance* reflects his priorities and provides sufficient instruction for the departments, it should be distributed on a

¹¹⁰ See the NSC reform chapter in *Road Map for National Security: Addendum on Implementation*, USCNS/21, April 15, 2001, available at www.nssg.gov.

¹¹¹ The term “NSC Principals” refers to the NSC Principals Committee, of which the SecDef is a member, and which is the senior interagency forum for considering policy issues affecting national security.

limited basis for implementation. Its preparation should *precede* the departments' initial budget preparation. Ideally, distribution of the final NSPG should occur in March to initiate department budget and planning processes. The Defense Department should use the *National Security Planning Guidance* to direct the development of its budget submissions via the PPBS process. The NSPG would be broadly hewn, highlighting critical goals, but it would provide enough detail to instruct and guide DoD's priority programs and activities.

DoD reforms should tie USD(P) directly into this strategic planning process, and the Defense Planning Guidance should echo and refine the President's and Secretary Rumsfeld's objectives and priorities. Defense reforms should be focused on integrating the Department into this strategic planning process, and on transforming the Department's ability to better translate plans and policy into resource allocations, programs, and budgets. *The Commission advocated an Assistant Secretary of Defense for Strategy and Planning within USD(P) as a key element to performing this function.*

2. Involving DoD Senior Management

The short, simple, and obvious truth is that Secretary Rumsfeld will need to be personally engaged in defense reform efforts. The challenges are too great to delegate responsibility to others and only the Secretary, strongly supported by the President, possesses the *gravitas* to push significant reforms through the system.

At the same time, other senior officials who are responsible and accountable must support defense reform or the momentum for change will quickly dissipate. Senior officials must understand that defense reform is not an end state but a continuous journey. As cynically defined in *The Devil's Dictionary*, reform is "a thing that mostly satisfies reformers opposed to reformation."¹¹² Thus, reform should not be diluted to appease bureaucrats who secretly shun change.

Senior officials must understand that Defense reform is not an end stated but a continuous journey.

Senior leaders and managers need to embed reform and the creation of defense excellence into their personal objectives. They must understand they are working the Secretary's agenda when involved with defense reform. If they do not understand the processes whereby organizations reinvent themselves they must learn—because they will have to lead those processes. If they cannot learn, they need to leave.

Senior leaders must create incentives within their organizations to gain the active support of middle and lower management tiers. Bureaucratic non-compliance and foot-dragging must be identified and remedied. Low-level problems *will* arise from the civil servants within OSD, and from within the military Services. They will not admit resistance, but it will be evident in a thousand minor ways unless senior leaders develop visible and successful pockets of reform and court serious involvement from both formal and informal leaders. That is the only way to defeat expected "end runs" to the Hill, to labor unions, and to other special interest groups.

Secretary Rumsfeld must visibly empower senior leaders to implement reform. The topic must be on the Secretary's regular agenda, and senior officials must report to him **regularly** and **frequently** (weekly/bi-monthly) on their progress. Reform is not something to be taken out and

¹¹² Ambrose Bierce, *The Devil's Dictionary* (New York: Dover Publications, 1993), p. 103.

flashed before the press once or twice a year. Reform is a process that must be nurtured constantly to produce results.

3. Selecting Critical Initiatives to Pursue

Political capital is valuable and should not be squandered on minor reform efforts. If approached like a “shotgun,” where the velocity and vector of hundreds of “reform pellets” dissipate over distance and time, it will likely fail. If focused like a “rifle” on five or six critical “reform bullets,” however, it stands a chance of hitting its distant target. Picking the right bullets can together constitute a “tipping point” that will in train draw other processes in the direction of genuine reform. Thus, Secretary Rumsfeld and senior defense officials must select carefully the key initiatives that will create the tipping point. These must be tied to critical objectives and priorities outlined by the strategic planning process illustrated above.

Realigning organizational *structures* is only part of any solution. The real emphasis must be on fixing key *processes* within DoD. When processes are changed, structures will normally conform to them. The heart of organizational reform should be three-fold: to meet strategic priorities; to make the key processes work; and to eliminate redundancy and inefficiency by focusing on core competencies.

Meaningful changes cannot be implemented overnight, and easy fixes tend to preserve the status quo.

The initiatives should be selected for their long-term payoff. Meaningful changes cannot be implemented overnight, and easy fixes tend to preserve the status quo. At the same time, some attention must be paid to short- and mid-term reforms, if for no other reason than they may be necessary. They may also be useful vehicles as intermediate steps in the road to reform.

For each critical initiative, the Secretary will find it useful and necessary to gather associated problems into a cluster of reforms. Each cluster would focus on key and supporting processes, products, and organizational changes. The reason is that critical initiatives will likely be complex, will interact with other key reforms, and the solution path to implementing them will likely require “drill down” efforts and analysis to identify underlying problems.

The selection of initiatives will itself require resources and tradeoff decisions. The resource decisions involve the political capital and time expended. The tradeoff decisions require fundamental analysis of both the benefits and opportunity costs of selecting some issues and not others. These decisions will essentially be political in nature, so the Secretary must ensure that the President presents his selections in such a way as to garner Congressional support.

4. Establishing a Sound Implementation Mechanism

Some proposals, however insightful and practical they may be, are never implemented for lack of appropriate method. The process for implementing reform is just as important as the choice of reforms pursued. Secretary Rumsfeld needs to create a reform office of some type—a reform implementation cell—responsible directly to him for structuring and implementing defense reform efforts. It must be empowered to work closely with senior defense

officials and support them in developing detailed plans and methods, monitoring progress, and assisting them and the Secretary in identifying and overcoming obstacles.¹¹³

The Department and the reform cell may do well to maintain contact with outside commissions, institutes, associations, and public policy groups interested in defense reform that have a solid knowledge base. Using them in a semi-official status could assist the reform effort by contributing inputs, acting as “sounding boards,” and using these constituent groups for outreach and public/Congressional advocacy.

No reform effort can propose credible improvements to the Department without first understanding how DoD actually functions. It must also recognize that such a large organization with complex processes is inherently in a state of constant evolution—particularly during transitions of administrations. But before institutional redesigns can occur, or before detailed road maps can be constructed to get the defense establishment headed in the right direction, the reform cell needs to understand how the Department is structured and how it goes about its business. Thus, the reform effort must begin with a strong “baseline” of current DoD structures and process. The work by the USCNS/21, *Road Map for National Security: Addendum on Structure and Process Analyses* will prove a useful tool in this endeavor.¹¹⁴

Successful defense reform will ultimately hinge upon workable, detailed implementation plans for each critical issue. The defense reform implementation cell should develop such plans to identify where responsibilities lie, suggest timelines, sequence actions, and specify the necessary coordination and consultation nodes between the Executive and Legislative Branches. In addition, the plans must address the impact on costs and personnel levels (where applicable), and identify issues that are likely to impede implementation. The implementation plans should also recognize whether legislation, Presidential directives, or internal departmental actions are required to bring the reform into being, should identify the key elements, and provide draft implementation language. Finally, the plans should highlight issues that, unless addressed, are likely to render implementation less effective—such as bureaucratic considerations, cultural impediments that accompany all transformations, and lessons derived from earlier events—and provide options that, if adopted, will facilitate implementation of those reforms. A suggested outline for the implementation plans is provided below:¹¹⁵

Successful defense reform will ultimately hinge upon workable, detailed implementation plans for each critical issue.

- **Background**
- **Implementation Blueprint**
 - **Actions**
 - **Responsibilities**
 - **Timelines**
- **Process Maps and/or Organizational Charts (as required)**
- **Personnel Implications**
- **Costs**

¹¹³ The reform implementation cell could also support the defense management board contemplated by Secretary Rumsfeld.

¹¹⁴ USCNS/21, April 15, 2001, available at www.nssg.gov. See Volumes I, IV, and VI.

¹¹⁵ Based on several implementation plans developed by the Commission. See USCNS/21, *Road Map for National Security: Addendum on Implementation*, April 15, 2001, available at www.nssg.gov.

- **Issues and Considerations**
- **Implementation Means**
 - **Draft Legislation, Presidential Directives, and/or Departmental Directives**

The Department and the reform implementation cell must remember that plans are developed to implement reforms aimed at solving specific problems. The detailed implementation plans, however, are only starting points that will invariably require alteration. As every military commander knows, plans are designed primarily to exercise the process and to get you to “first contact.” Even excellent plans must be constantly adjusted. The keys are to present bureaucratically feasible steps, to establish a mechanism and a process, and to provide appropriate incentives.

The implementation process will be just as important as the implementation plans.

The implementation *process* will be just as important as the implementation *plans*, which only serve as a foundation for change. In this light, it would also be wise to develop and use some “pilot programs” in the implementation process to test key reforms. Pilot programs provide several advantages. They allow for early success to help build momentum. They provide reform “paths” so that actions can be undertaken in sequential fashion rather than one giant leap. Lastly, they provide means to detect unexpected consequences, which permits the plan to be refined and adjusted. The latter assumes the reform implementation cell establishes an assessment process and develops appropriate metrics to measure progress or failure.

B. A Defense Reform Game Plan

The implementation plans recommended above represent tactical and operational vehicles to achieve specific ends. However, the larger reform effort should be based upon a strategic game plan aimed at creating excellence within DoD. Eight key elements constitute such a plan. (See Figure 7.) In the ideal world, they can be prioritized in a sequential manner, however, the real world dictates that several elements can and should be pursued in parallel.

First, reiterating the Commission’s emphasis on top-down strategic planning, *the President and the Secretary of Defense must define what the military component of the national security strategy must accomplish.* In other words, what are the key objectives at the global and regional levels? This should flow from the National Security Strategy (NSS), the National Security Planning Guidance (NSPG), and the Defense Planning Guidance (DPG). These key objectives must be based on our national interests and values, and need to include opportunity-based policy goals as well as response-based security requirements.¹¹⁶ The key to accomplishing this first step depends on Secretary Rumsfeld supporting the process to develop an NSPG and pursuing the recommendations in Section II of this Addendum to reform the DPG into a more useful planning document.

Second, flowing from the above step, *DoD needs to identify the military capabilities needed to provide the defense component of the NSS and the NSPG.* All trails lead towards the conclusion that military capabilities should be “mission oriented” and “outcome measured.” This task begins with revising the Major Force Programs (MFPs) and Program Elements (PEs), and harmonizing the Joint Warfighting Capabilities Assessment around similar missions. The revised

¹¹⁶ See USCNS/21, *Seeking a National Strategy*.

MFPs must in turn be tied to a strategy-driven DPG. As long as individual programs remain unconnected to specific mission capabilities, the Department will lack the mechanism to link outputs to larger national security objectives, or to conduct tradeoff analyses.

Third, *the Department must size and shape the military forces and design the sustainment structures for the required military capabilities.* This should be accomplished in a QDR, or a QDR-like process. This task must encompass an OSD-designed methodology to revise the force planning process that includes improved modeling and the ability to address and resolve several critical issues in different categories. The “force” related issues include: major theater war and multiple complex contingency requirements (to include power projection); reserve component requirements; homeland security requirements; and allied interoperability issues and contributions. The “combat support” issues include C4ISR requirements and strategic lift/prepositioning tradeoffs. The key “service support” issues should be addressed within a strategic plan to outsource and privatize the Department’s infrastructure. Nothing precludes DoD from initiating efforts to begin working these issues in parallel with steps one and two above.

This task must encompass OSD putting a methodology in place.

Fourth, *the Department must designate a responsible Service and/or Defense Agency for each required military force structure and support/sustainment function.* Authority, responsibility, and accountability must be clarified rather than diffused across staffs and agencies. OSD should function to designate Services as Administrative or Executive Agents, as required, for certain cross-Service programs. The Department should also propose legislation to delegate certain DAB authorities away from USD(AT&L) and back to the Services to empower them to execute programs. Where appropriate, the Services should compete for who provides the capability within a QDR process. The competition could be total—winner takes all—or for shares of required missions—a 40/60 split could be used, for example.

Fifth, *OSD must impose management systems over the current DoD structures that facilitate input and output measurement, similar to current best business practices, to determine efficiencies of the current systems, to evaluate potential improvements, and to develop the available alternative courses of action.* At the macro level this begins with reforming the PPBS process by changing the Defense Planning Guidance, the Major Force Programs, and reorganizing the individual Program Elements. Management reviews would be performed during the QDR process and during the annual issue cycle. At the micro level this requires instituting workplace performance concepts such as Army Workload and Performance System (AWPS) within infrastructure support systems that measure output value. Management reform would thus be in place to evaluate infrastructure consolidation, outsourcing, and privatization alternatives. Acquisition management reform should focus on the changes and flexibility necessary to deliver the types of military capabilities needed. In other words, zero in on the critical capabilities first, versus across the board acquisition reform.

Acquisition management reform should focus on changes and flexibility necessary to deliver the types of military capabilities needed.

Sixth, *flesh out the risks and costs associated with each course of action: force structure or military capability; supporting/sustaining infrastructure; and acquisition system.* This is where the Department must examine tradeoffs and investment priorities between force requirements, force sustainment/readiness, and force modernization. It must differentiate between strategic and

operational risk. It must determine whether to pursue incremental change or skip a generation. It should evaluate alternative programs for the size and composition of active and reserve forces. It must dissect needs for high-demand low-volume assets. It must consider the use of space assets and the C4ISR enhancements necessary for network-centric operations. It should probe various power projection and basing options. It must also consider costs for enduring presence and engagement options. It must review force re-capitalization choices as well as fundamental cost effective alternatives to reforming defense infrastructure.

Seventh, *decide on a course of action*. This is primarily a SecDef decision, but obviously Secretary Rumsfeld should also rely on the advice of his senior executives—the Under Secretaries and the Service Secretaries, as well as the Chairman and the Joint Chiefs. Because most defense issues are deeply moored to the political process, such enormous decisions will obviously involve the President, the Congress, and numerous outside stakeholders. Neither “military efficiency” nor “national security” alone will likely generate the support needed to carry many decision through to completion. Defense “reform” has little constituency on the Hill compared to “pro-defense” positions that thinly mask support for local installations and jobs associated with defense programs. Thus political capital must be expended and steps must be taken to inform the Congress and generate required “buy in” on key decisions. Again, a BRAC-type commission may be necessary to provide political cover for some courses of action.

Eighth, *acquire the capabilities needed to field and sustain the required military forces using reformed PPBS and acquisition processes*. This task should fall mostly upon the military Services, assuming OSD has properly laid the groundwork for and guided the defense reform process. This last step feeds directly back into the defense reform prerequisites detailed in the front of this section with the suggested implementation mechanisms.

Defense reform could be Secretary Rumsfeld’s real legacy to this nation, and it should not be allowed to wander aimlessly about the corridors of the Pentagon. Secretary Rumsfeld needs to be in charge of defense reform if he hopes to create true excellence. He needs his senior managers to carry out reforms effectively, and this requires a dedicated defense reform implementation cell to assist the effort. Lastly, the Secretary should focus the entire reform effort on a few key areas. From this addendum, we offer four issues as being critical: reform the major staffs around their core competencies; reengineer defense infrastructure to reduce costs and improve efficiency; reform the PPBS process into a true management tool; and reform the defense acquisition system to field the needed military systems. Two additional issues from the Commission’s main Phase III report bring the total number of initiatives to six: military and civilian personnel reform; and transforming the National Guard to better assume a homeland security mission.¹¹⁷

As noted in the summary of this addendum, the problem of defense reform and creating excellence within DoD is an enormous and daunting challenge. However, as an old proverb states, “If you have a mountain to climb, waiting around won’t make it any smaller.” Adapting the Department of Defense to the security environment of the 21st century will be a difficult climb, but it is time to start assaulting the summit.

¹¹⁷ See details in Sections I and IV of *Road Map for National Security*. Also see the “Personnel Reform” and “Homeland Security” chapters in *Road Map for National Security: Addendum on Implementation*.

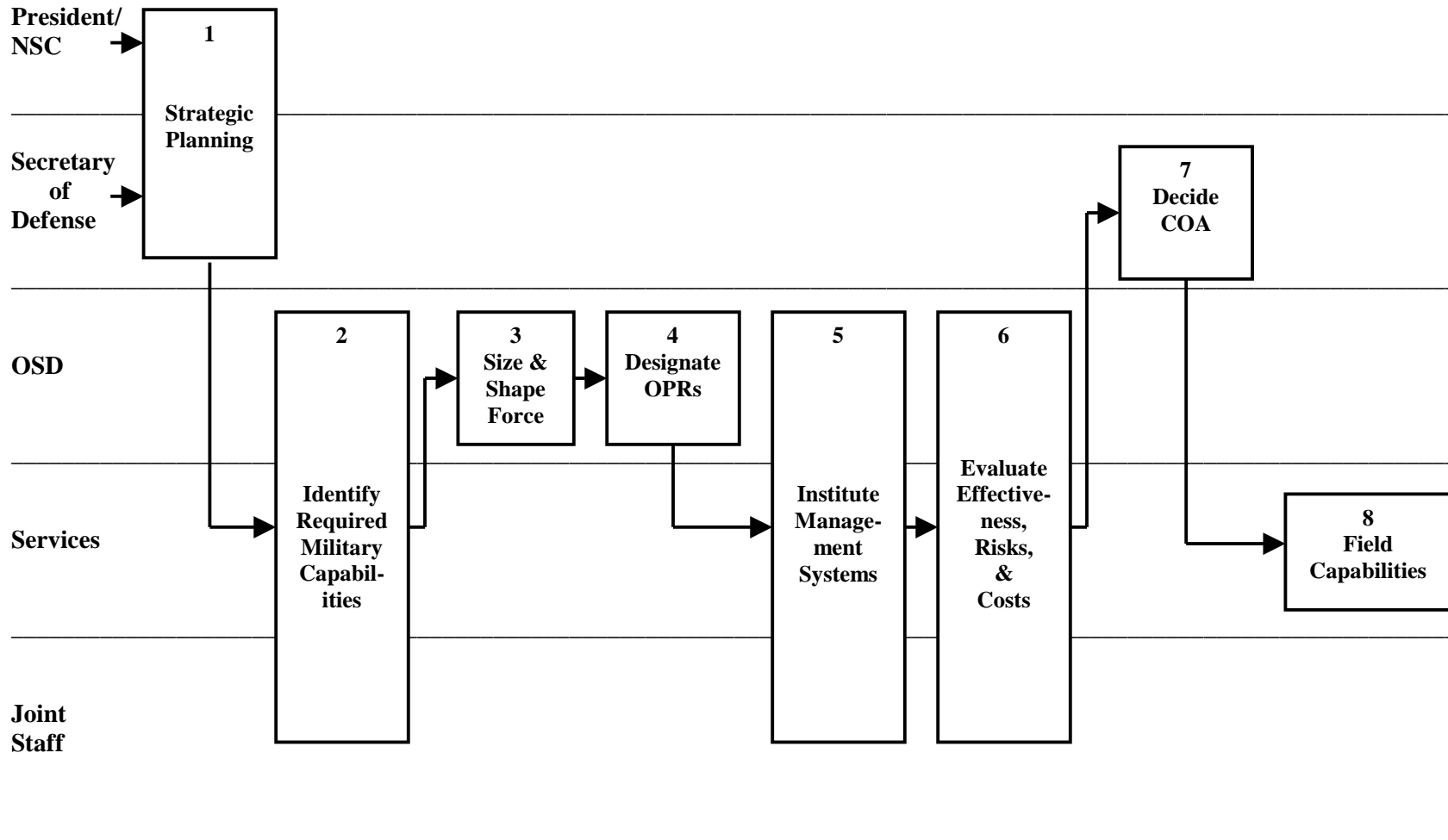

Figure 7. Defense Reform Game Plan

National Security Study Group Staff, Contractors, Consultants, and Advisors

Executive Director

Charles G. Boyd

Deputy Executive Director

Arnold Punaro

Chief-of-Staff

Hank Scharpenberg

Study Group Coordinator

Pat Allen Pentland (primary author)

Study Group Members

Patti Benner Antsen
Lyntis Beard
Keith A. Dunn
Adam Garfinkle
Frank Hoffman
Charles Johnson
Jim Locher
Williamson Murray

Research Staff

Erin C. Conaton, Research Staff Director
Chris Dishman
Garrick Groves
Christopher Hall
Mark Kohut
Kelly Lieberman
Rachel Schiller
Betsy Schmid

Support Staff

James Freeman, Administrative Officer
Annette Atoigue
Carmen Augustosky
Marilyn Bridgette
Jamie Finley
John Gardner
Marvin Goodwin
Michele Hutchins
Diane Long
Jonathan Nemceff
Gerald Posey
Tom Prudhomme
Paula Siler
Cynthia Waters

Contractors

Fred Frostic and George Raach, from Booz-Allen & Hamilton

Consultants

Charles Barry
Paul Byron Pattak

Advisors

General Michael P.C Carns, USAF (Ret.)
M. Thomas Davis
Joseph Eash (DoD)
Katherine Schinasi (GAO)

Note: Only individuals who produced or commented on sections of this Addendum are listed. Not every individual endorsed every nuance in the report.

