

# EFFECTS OF SPRAY MIXTURES ON DROPLET SIZE UNDER AERIAL APPLICATION CONDITIONS AND IMPLICATIONS ON DRIFT

B. K. Fritz, W. C. Hoffmann, W. E. Bagley

**ABSTRACT.** *There is a concerted effort within the spray application industry to develop and implement a Drift Reduction Technology (DRT) Program, which would encourage applicators to adopt technologies that are shown to mitigate off-target movement of sprays. The use of simulated or mimic sprays for atomization studies in high-speed wind tunnels allow researchers to limit the amount of active ingredients used in spray tests and facilitate the testing and certification of DRTs. However, it is important that these simulated and mimic sprays have the same physical and atomization characteristics of sprays containing active ingredients. Studies were conducted to compare droplet size generation from four spray formulations, one of which was an active ingredient and three which were potential mimics and to use the collected data to examine an application management practice as a potential DRT. These sprays were atomized using two nozzles placed in high-speed airstreams (45 to 63 m/s in 2-m/s increments) in a wind tunnel and the droplet spectra measured via a laser diffraction instrument.*

*In general, the volume median diameter (VMD) decreased by 30% to 50% as the airspeed increased. There were significant differences in droplet size between mimic sprays and those with active ingredient sprays. Results from AGDISP modeling showed increased downwind deposition with increased airspeed as a result of the increased number of finer droplets in the spray. The AGDISP results also showed differing amounts of downwind deposition at similar airspeeds from the different formulations. Downwind deposition modeling based on a simulated multi-pass spray application with reduced airspeeds near the downwind spray area border showed that the addition of the slower-speed passes near the edge can reduce total off-target movement. The results from these studies show that while mimic and simulated sprays can give similar atomization results and follow similar trends in effects of droplet size from changes in airspeed, active ingredients can have a significant effect on the atomization of spray solutions.*

**Keywords.** *Aerial application, Glyphosate, Spray adjuvant, Droplet size, Spray drift, AGDISP.*

Spray drift, which the Environmental Protection Agency (EPA) defines as the movement of pesticide spray droplets through the air post-application off-target of the applied location has been, and will continue to be, a major concern for the application industry (EPA, 2001). The atomization process of converting liquid into spray droplets depends on a number of physical parameters include formulation physical properties (Hewitt et al., 1993; Hanks, 1995; Hoffmann et al., 1998; Hewitt et al., 2002), spray volume, nozzle type (Bouse, 1994; Hoffmann and Kirk, 2005; Kirk, 2007), working pressure (Giles, 1997; Kirk, 2007), and ambient conditions at the time of application (Kirk, 2007). Additionally, application techniques and best management practices employed can also influence the potential off-target movement. These are all parameters that researchers and industry explore and

modify in an effort to reduce spray drift. As the number of technologies and methodologies aimed at reducing spray drift increase, EPA has recognized the need to be able to test and rate these technologies to give applicators credit for their use. Proposed testing programs to this end were proposed by Sayles et al. (2004) and Kosusko et al. (2006) and have been recognized by the EPA as a framework for drift reduction technology (DRT) evaluations. The present DRT Program is an EPA-led initiative with the stated goal to “achieve improved environmental and human health protection through drift reduction by accelerating the acceptance and use of improved and cost-effective application technologies (EPA 2006).” The first step in this process is the development of a set of protocols, standard operating procedures, and data quality assurance steps to insure scientific validity and repeatability (EPA, 2002).

The major component of the EPA DRT protocols is measurement of droplet size for specific technologies which are compared to a reference system operating under the same conditions. The Spray Drift Task Force (SDTF) compiled a database of reported spray drift data and found that droplet size was a critical factor influencing spray drift (Hewitt et al., 2002). The present protocols detail the use of water and emulsifiable concentrate (EC) “blank” solutions as mimics of typical active ingredient spray solutions. These blank spray solutions were selected for their physical properties which are meant to be representative of typical aqueous and

---

Submitted for review in April 2009 as manuscript number PM 7972; approved for publication by the Power & Machinery Division of ASABE in September 2009.

The authors are **Bradley K. Fritz, ASABE Member Engineer**, Agricultural Engineer, **W. Clint Hoffmann, ASABE Member Engineer**, Agricultural Engineer, USDA-ARS, College Station, Texas; and **William E. Bagley, ASABE Member**, Wilbur-Ellis Company, San Antonio, Texas. **Corresponding author:** Bradley K. Fritz, USDA-ARS, 2771 F&B Road, College Station, TX 77845; phone: 979-260-9584; fax: 979-260-9386; e-mail: brad.fritz@ars.usda.gov.

## Report Documentation Page

Form Approved  
OMB No. 0704-0188

Public reporting burden for the collection of information is estimated to average 1 hour per response, including the time for reviewing instructions, searching existing data sources, gathering and maintaining the data needed, and completing and reviewing the collection of information. Send comments regarding this burden estimate or any other aspect of this collection of information, including suggestions for reducing this burden, to Washington Headquarters Services, Directorate for Information Operations and Reports, 1215 Jefferson Davis Highway, Suite 1204, Arlington VA 22202-4302. Respondents should be aware that notwithstanding any other provision of law, no person shall be subject to a penalty for failing to comply with a collection of information if it does not display a currently valid OMB control number.

1. REPORT DATE

**APR 2009**

2. REPORT TYPE

3. DATES COVERED

**00-00-2009 to 00-00-2009**

4. TITLE AND SUBTITLE

**Effects of Spray Mixtures on Droplet Size Under Aerial Application Conditions and Implications on Drift**

5a. CONTRACT NUMBER

5b. GRANT NUMBER

5c. PROGRAM ELEMENT NUMBER

6. AUTHOR(S)

5d. PROJECT NUMBER

5e. TASK NUMBER

5f. WORK UNIT NUMBER

7. PERFORMING ORGANIZATION NAME(S) AND ADDRESS(ES)

**U.S. Department of Agriculture, USDA-ARS, 2771 F&B Rd, College Station, TX, 77845**

8. PERFORMING ORGANIZATION REPORT NUMBER

9. SPONSORING/MONITORING AGENCY NAME(S) AND ADDRESS(ES)

10. SPONSOR/MONITOR'S ACRONYM(S)

11. SPONSOR/MONITOR'S REPORT NUMBER(S)

12. DISTRIBUTION/AVAILABILITY STATEMENT

**Approved for public release; distribution unlimited**

13. SUPPLEMENTARY NOTES

14. ABSTRACT

**There is a concerted effort within the spray application industry to develop and implement a Drift Reduction Technology (DRT) Program, which would encourage applicators to adopt technologies that are shown to mitigate off-target movement of sprays. The use of simulated or mimic sprays for atomization studies in high-speed wind tunnels allow researchers to limit the amount of active ingredients used in spray tests and facilitate the testing and certification of DRTs. However, it is important that these simulated and mimic sprays have the same physical and atomization characteristics of sprays containing active ingredients. Studies were conducted to compare droplet size generation from four spray formulations one of which was an active ingredient and three which were potential mimics and to use the collected data to examine an application management practice as a potential DRT. These sprays were atomized using two nozzles placed in high-speed airstreams (45 to 63 m/s in 2-m/s increments) in a wind tunnel and the droplet spectra measured via a laser diffraction instrument. In general, the volume median diameter (VMD) decreased by 30% to 50% as the airspeed increased. There were significant differences in droplet size between mimic sprays and those with active ingredient sprays. Results from AGDISP modeling showed increased downwind deposition with increased airspeed as a result of the increased number of finer droplets in the spray. The AGDISP results also showed differing amounts of downwind deposition at similar airspeeds from the different formulations. Downwind deposition modeling based on a simulated multi-pass spray application with reduced airspeeds near the downwind spray area border showed that the addition of the slower-speed passes near the edge can reduce total off-target movement. The results from these studies show that while mimic and simulated sprays can give similar atomization results and follow similar trends in effects of droplet size from changes in airspeed, active ingredients can have a significant effect on the atomization of spray solutions.**

15. SUBJECT TERMS

16. SECURITY CLASSIFICATION OF:			17. LIMITATION OF ABSTRACT <b>Same as Report (SAR)</b>	18. NUMBER OF PAGES <b>9</b>	19a. NAME OF RESPONSIBLE PERSON
a. REPORT <b>unclassified</b>	b. ABSTRACT <b>unclassified</b>	c. THIS PAGE <b>unclassified</b>			

**Standard Form 298 (Rev. 8-98)**  
Prescribed by ANSI Std Z39-18

EC spray formulations. Evaluation of these testing protocols has raised concerns as to whether these two solutions can indeed be representative of actual spray formulations. Mimic spray solutions are often used in place of agrochemicals in spray atomization and field tests with the intent that the mimic spray has similar physical properties and thus similar atomization characteristics (Hewitt et al., 2002). Mimics of “real-world” solutions are used to limit the use of solutions containing active ingredients. These mimics allow users to test equipment without having to use personal protective equipment, such as respirators and chemical suits, while ensuring that the droplet size spectra is similar to that obtained with active ingredient (Hoffmann et al., 2007). It is important that if a mimic spray solution is used that it generates the same droplet sizes as a solution containing an active ingredient, which requires testing of both solutions under similar conditions.

As part of this research, spray droplet size distributions generated across a range of airspeeds for an active ingredient formulation applied using a typical agricultural aerial application nozzle were measured. Within the realm of the DRT program, the term “technologies” is broadly used encompassing nozzle types, spray adjuvants, mechanical means, land structures such as hedge rows, and management practices. Using the droplet size data collected across the multiple application airspeeds, a management practice scenario that takes advantage of potential decreased application airspeeds near a field edge and the associated potential increases in droplet size is briefly explored using the AGDISP model.

The objectives of this work were to compare droplet size generation from four spray formulations, one of which was an active ingredient and three which were potential mimics and to use the collected data to examine an application management practice as a potential DRT.

## METHODS

Droplet sizing tests were conducted under aerial application conditions in the USDA-ARS high-speed wind tunnel (HSWT). The USDA-ARS HSWT consists of a high-speed centrifugal blower powered by a 48.5-kw (65-hp)

gasoline engine (fig. 1). The blower speed is controlled by adjusting the engine’s throttle. The high-speed air generated by the blower exhausts through a 30- × 30-cm outlet. Prior to leaving the outlet, the high-speed air passes through air straighteners mounted inside the tunnel. Airspeed is measured directly at the outlet using a pitot tube attached to an airspeed indicator. A 30-cm section of aircraft boom is mounted directly at the tunnel’s outlet. The boom is affixed to a pair of linear slides and a linear motor to allow it to be traversed vertically across the length of the outlet. The boom section is plumbed to a pressured spray tank. The center of the boom has a fitting to mount the required check valves and nozzles. A pressure gauge is also plumbed to the boom to monitor pressure at the nozzle. A movable 40- × 40-cm plexiglass tunnel (not shown in fig. 1 for clarity) is positioned inline with the airstream flush against the tunnel’s outlet. This section is moveable to allow access to the spray boom and nozzle. The plexiglass tunnel has a pair of access holes downwind of the nozzle through which the laser diffraction instrument operates.

A total of 108 replicated spray tests, comprised of two nozzle configurations, four spray formulations, two application rates, and nine airspeeds were completed for this study. Each treatment combination was replicated three times in the HSWT. The specific testing protocol, nozzle configuration, spray formulations, and physical property measurement procedures are discussed in the following sections.

## SPRAY FORMULATIONS

The four spray formulation included:

- Water + Non-ionic surfactant (NIS) (0.25% v/v R – 11, Wilbur-Ellis, Devine, Tex.);
- EC Blank (Water + 9.2% v/v Aromatic 200 [Exxon Mobil Corporation, Irving, Tex.), 0.35% v/v Toximul 3473 (Stepan Company, Northfield, Ill.), and 0.45% v/v Toximul 3474 (Stepan Company, Northfield, Ill.);
- PowerMax (Monsanto Company, St. Louis, Mo.) EPA Reg. No. 524-549, Active ingredient: Glyphosate: N-(phosphonomethyl) glycine, in the form of its potassium salt: 1 quart/acre rate

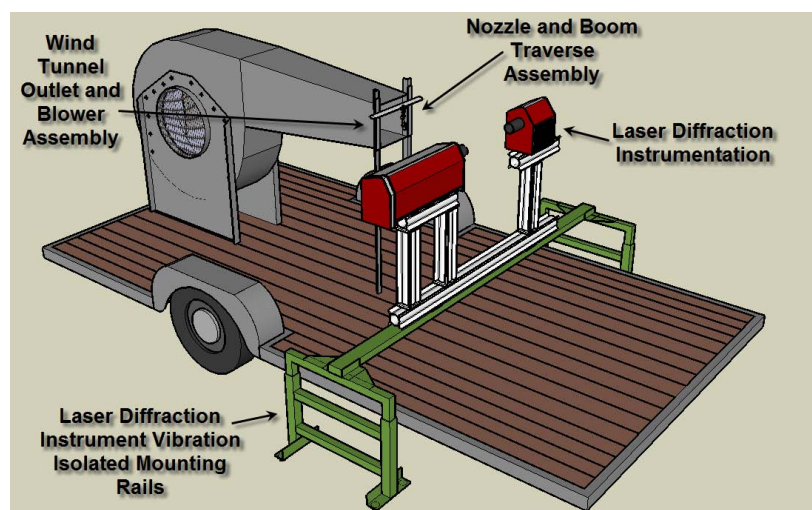

Figure 1. USDA-ARS high-speed wind tunnel.

- Low Mole Amine (Same formulation of the PowerMax solution without the glyphosate)

The PowerMax solution was selected due to several glyphosate-based herbicide drift incidences. The Water + NIS and EC Blank solutions were selected based on their recommended use in the EPA DRT evaluation program (Hoffmann et al., 2009). The Low Mole Amine was chosen as it is the same as the PowerMax but with the active ingredient removed to examine how much impact the active ingredient has with respect to physical properties and atomization. This allowed for comparison of droplet sizes across the four solutions. The PowerMax and Low Mole Amine (LMA) solution were mixed at spray application rates of 18.7 and 46.8 L/ha (2 and 5 gpa) to investigate the effects of diluting with water.

#### PHYSICAL PROPERTY MEASUREMENTS

The dynamic surface tension and viscosity of each formulation was measured. Dynamic surface tension was measured with a SensaDyne Surface Tensiometer 6000 (Chem-Dyne Research Corp., Mesa, Ariz.) using the maximum bubble pressure method. The gas flow rate settings were varied until surface age values were found on either side of the target time of 0.02 s. The 20-ms time was used based on Spray Drift Task Force work that suggested that this surface lifetime is representative of a typical hydraulic agricultural hydraulic nozzle atomization process (Hewitt et al., 2002). These values were then used to interpolate the value at 0.02 s. Then, a table of percent flow rate settings was built in 5% increments to include the previous settings. This table was calibrated using 200 proof ethanol and pure water. The probes were lowered into the sample and the dynamic surface tension, bubble rate, bubble age, and temperature were measured at each setting in the table. The dynamic surface tension at 20 ms was linearly interpolated from the results. The tests were replicated three times. Viscosity was measured with a Brookfield Synchro-Lectric Viscometer (Model LVT, Brookfield Engineering, Middleboro, Mass.) using a UL adapter 0.1- to 100-cps range. The spindle was inserted into the sample. The motor was started and run until the dial reading stabilized and the reading was recorded.

#### AIRSPPEEDS

For each formulation and nozzle combination, the nine airspeeds tested were 45, 47, 49, 51, 54, 56, 58, 60, and 63 m/s (100, 105, 110, 115, 120, 125, 130, 135, and 140 mph).

#### NOZZLE CONFIGURATIONS

The two nozzle configurations were selected to represent two different application scenarios. The first configuration (CP-03 nozzle; CP Products, Tempe, Ariz.) with a 30° deflector, 3.2-mm (0.125-in.) orifice at 240 kPa (35 psi) and the nozzle body with 0° orientation represented a situation where the spray liquid experiences higher shear stress and subsequent secondary atomization from high-speed air as the spray impacts the high-speed air at a 30° angle. Treatment 2 (CP11TT nozzle; CP Products, Tempe, Ariz.) with a 4008 flat fan orifice at 276 kPa (40 psi) with 0° orientation resulted in much less shear stress on the fluid as a result of the liquid being emitted parallel to the airstream resulting in the spray liquid having a lower velocity relative to the airstream. Bouse

et al. (1994) provided a more complete description of droplet shear in high-speed airstreams.

#### DROPLET SIZING MEASUREMENTS

A Sympatec Helos laser diffraction droplet sizing system (Sympatec Inc., Clausthal, Germany) was used to measure droplet size. The Helos system uses a 623-nm He-Ne laser and was fitted with an R5 lens, which resulted in a dynamic size range of 0.5 to 875 μm in 32 sizing bins. The Sympatec traversed vertically through the spray plume using a forklift mounted frame. For each combination of nozzle configuration and spray formulation, three independent replications were conducted. A replication comprised of operating the nozzle for 15 s at a distance of 61 cm (24 in.) from the laser beam of the droplet measurement system. During the 15 s, the Sympatec was vertically traversed through the entire spray plume. Tests were performed within the guidelines provided by ASTM Standard E1260: Standard Test Method for Determining Liquid Drop Size Characteristics in a Spray Using Optical Nonimaging Light-Scattering Instruments (*ASTM Standards*, 2003).

The most common term used to describe spray droplet size spectra is volume median diameter ( $D_{V0.5}$ ) (*ASTM E1620, ASTM Standards*, 2004).  $D_{V0.5}$  is the droplet diameter (μm) where 50% of the spray volume or mass is contained in droplets of lesser diameter.  $D_{V0.1}$  and  $D_{V0.9}$  values, which describe the proportion of the spray volume (10% and 90%, respectively) contained in droplets of the specified size or less, were measured. The percent volume less than 100 μm, which is an indicator of the “driftable” portion of a spray, was also computed.

#### AGDISP MODELING

For the AGDISP modeling work, the application aircraft modeled was an AT-402 with a 20-m (65-ft) swath and a 3-m release height. No canopy was used, but the surface roughness was set to 0.8 cm (0.3 in). Wind speed was set to 2.24 m/s (5 mph) and perpendicular to the spray swaths. Temperature was set at 21°C (70°F) with a relative humidity of 60% and moderate daytime stability. Evaporation effects were not considered. Modeling results included deposition from 0 to 100 m downwind of the first spray swath (i.e. edge of the field) and the vertical spray at 30 m (100 ft) downwind. Using the measured droplet size data for the PowerMax solution mixed at the 18.7 L/ha rate for both the CP11TT and the CP-03 nozzle configurations across all airspeeds, AGDISP was used to predict the resulting downwind deposition at 30 m (100 ft) to examine the potential impact that changes in airspeed, and thus in droplet size, have on downwind movement.

An additional series of modeling simulations were conducted to explore the potential for exploiting the relationship between airspeed and droplet size as a method to minimize off-target movement. The droplet size data for the PowerMax solution at the 18.7-L/ha rate applied with the CP11TT nozzles at the 54- and 63-m/s airspeeds were used, with modifications to account for flowrate adjustments due to changes in airspeed. For this modeling work, it was assumed that the aircraft was outfitted with a flow-control valve tied to GPS measured groundspeed. This would result in a decrease flowrate needed to maintain the same application rate at the decreased airspeed. Flow controllers

typically modify flowrate via changes in spray pressure. Flowrate for each selected nozzle at 240 kPa is 2.8 L/min which would require 49 nozzles for the selected aircraft setup at an airspeed of 63 m/s. When the aircraft slows to 54 m/s, the flow controller would reduce the spray pressure to 172 kPa reducing the per nozzle flowrate to 2.4 L/min and changing the resulting droplet spectra as well. Additional droplet sizing measurements were made to generate these data. With airspeed decreasing from 63 to 54 m/s, droplet VMDs increased from 223 to 269  $\mu\text{m}$ , while  $D_{V0.1}$  and  $D_{V0.9}$  values increased from 85 to 97  $\mu\text{m}$  and 399 to 495  $\mu\text{m}$ , respectively. The percent volume less than 100  $\mu\text{m}$  decreased from 13.3% to 10.6%.

Both of these operational treatments were incorporated into a 20-pass application starting at the edge of a field with the first pass and moving upwind 20 m (i.e. swath width) with each successive pass. This simulates a field being sprayed by an aircraft. Initially, all 20 passes were made at the 63-m/s airspeed. Additional application scenarios examined the effects of making near-field-edge passes at the 54-m/s airspeed, with the thought that the slower airspeed, which produces a larger droplet spray, would reduce off-target movement. Each additional application scenario added an additional 54 m/s pass near the edge of the field, until all 20 passes were made at 54 m/s. For example, the first scenario had all 20 passes at 63 m/s; the second had one pass at the field edge made at 54 m/s, and the other 19 at 63 m/s; the third had two passes near the edge of the field made at 54 m/s, and the other 18 at 63 m/s; and so on.

#### STATISTICAL ANALYSES

The statistical analyses used the SAS GLM procedure (Littell et al., 1998) to test the effects of the nozzle configuration, spray solution, and/or application rate. Statistical significance between means was specified at the 0.05 level of significance and separated by Duncan's mean separation.

## RESULTS

### PHYSICAL PROPERTY MEASUREMENT RESULTS

The dynamic surface tension and viscosity results are given in table 1.

#### Effects of Nozzles on Spray Droplet Size

As expected, and by design, the two nozzle configurations were highly significantly different ( $p < 0.0001$ ) across all spray solutions and airspeeds. Therefore, the effects of spray solution and/or rate were independently analyzed for each

Table 1. Physical properties for the spray formulations used in the droplet sizing study.

Solution	Dynamic Surface Tension (mN/m @ 20 m/s)	Viscosity (cP @ 20°C)
Water + NIS	46.5	1.0
EC Blank	39.6	1.6
PowerMax @ 18.7 L/ha	41.4	1.4
PowerMax @ 46.8 L/ha	42.1	1.1
Low mole amine @ 18.7 L/ha	48.9	5.2
Low mole amine @ 46.8 L/ha	49.6	1.8

treatment. The analyses are presented by Treatment for Clarification.

#### Comparison of EC Blank and Nonionic Surfactant Solution

As the airspeed increased there was a steady decrease in all droplet size measurements. The  $D_{V0.5}$  decreased from 377 to 245  $\mu\text{m}$  as the airspeed increased from 45 to 63 m/s for the CP11TT nozzle with the EC blank solution (fig. 2). The  $D_{V0.5}$  decreased from 337 to 203  $\mu\text{m}$  as the airspeed increased from 45 to 63 m/s for the CP-03 nozzle with the NIS solution (fig. 3).

With the CP11 TT nozzle (i.e. the low shear atomization condition), there were significant differences ( $P=0.05$ ) between the  $D_{V0.5}$  values measured for both the EC blank and NIS solutions from 45- to 54-m/s airspeeds (fig. 4). There were no significant differences between solutions from 56 to 63 m/s. This is a result of an increasing influence of air shear in the atomization process, which tends to override nozzle and formulation effects. With the CP-03 nozzle (i.e. the higher shear atomization condition), there were no significant differences between solutions. The greater shear impact of the nozzle 30° deflection was a dominate factor in the atomization process reducing the effects seen from formulation differences.

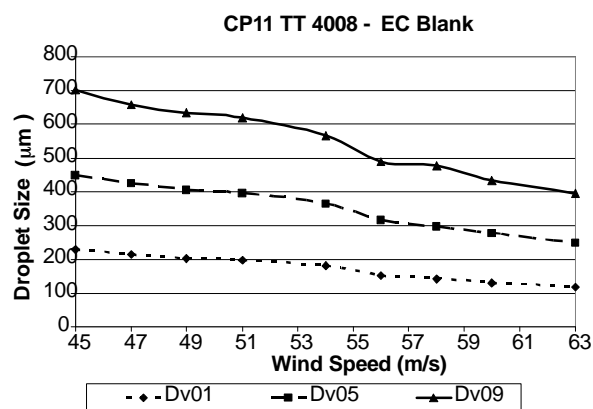

Figure 2. Effects of increasing airspeed on droplet size for the EC blank solution.

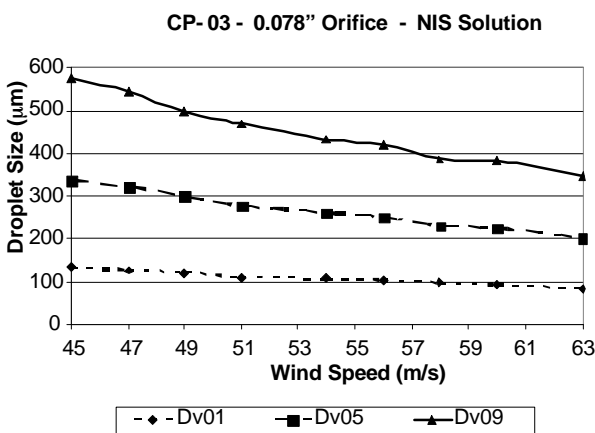

Figure 3. Effects of increasing airspeed on droplet size for the nonionic surfactant (NIS) solution.

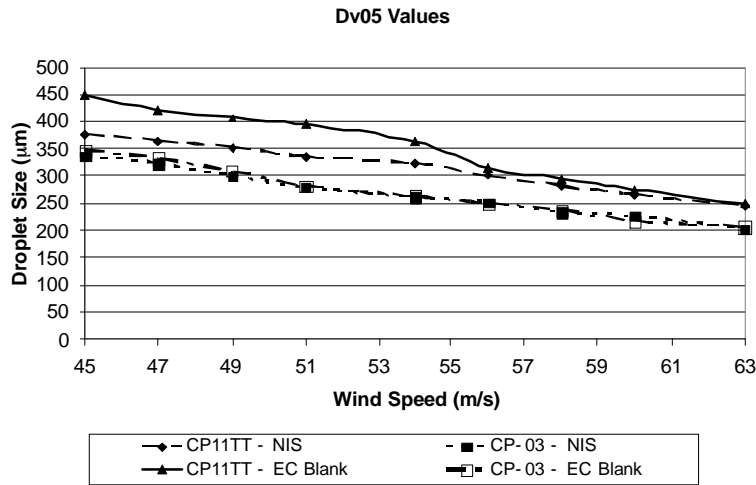

Figure 4. Comparison between measured DV0.5 values for the NIS and EC Blank solutions via different airspeeds with two nozzles.

### Comparison of PowerMax and Low Mole Amine Solutions

**45 m/s Airspeed.** For a CP11TT flat fan nozzle, the Low Mole Amine (LMA) solution resulted in significantly larger droplets than the PowerMax solution at the 18.7- and 46.8-L/ha spray rates (fig. 5 and 6). The LMA created significantly smaller droplets at the 18.7-L/ha spray rate with the CP-03 nozzle but not at the 46.8-L/ha spray rate. No

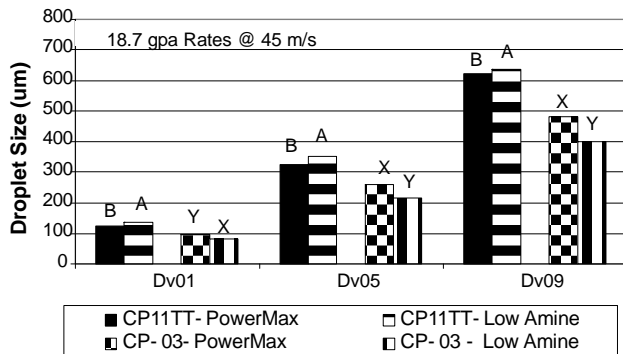

Figure 5. Droplet sizes for PowerMax and Low Mole Amine solutions at 18.7-L/ha spray rate in a 45-m/s airstream. (Within each droplet size category and nozzle type, means with the same letter are not significantly different.)

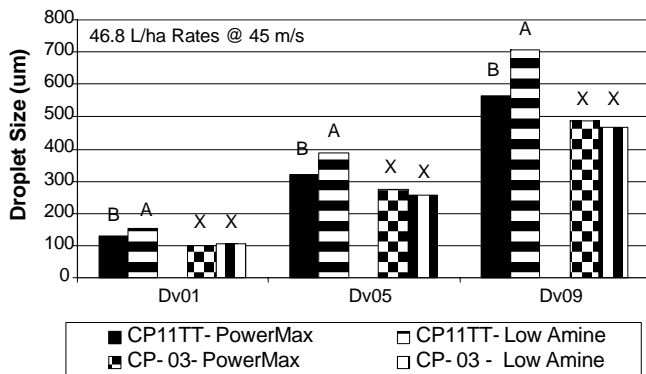

Figure 6. Droplet Sizes for PowerMax and Low Mole Amine solutions at 46.8-L/ha spray rate in a 45-m/s airstream. (Within each droplet size category and nozzle type, means with the same letter are not significantly different.)

difference in droplet size from the CP-03 nozzles at the higher spray rate was likely due to a combination of the greater atomization influence due to the nozzle orientation and the addition of enough water to the spray mixture to mask the influences of the formulation.

**63 m/s Airspeed.** At 63 m/s, the LMA solution generated smaller droplets than the Powermax solution for both nozzles at both the 18.7- and 46.8-L/ha spray rates (fig. 7 and 8). The only deviation was the DV0.1 values for both nozzles at the 46.8-L/ha spray rate. While the values were statistically different, the numerical differences were 4 and 9 µm for the CP11TT and CP-03 nozzles, respectively. The greater influence of the airspeed tended to lessen the differences in droplet sizes observed.

### Percent of Spray Volume Contained in Droplets Less than 100 µm

As the airspeeds increased from 45 to 63 m/s, the percent of spray volume contained in droplets less than 100 µm (% <100 µm) increased by 2-2.5X (fig. 9). The % Vol 100 µm increased from around 5% at 45 m/s for the CP11TT to 13% at 63 m/s (fig. 9). The percent volume 100 µm increased from around 10% at 45 m/s for the CP-03 to 16-20% at 63 m/s

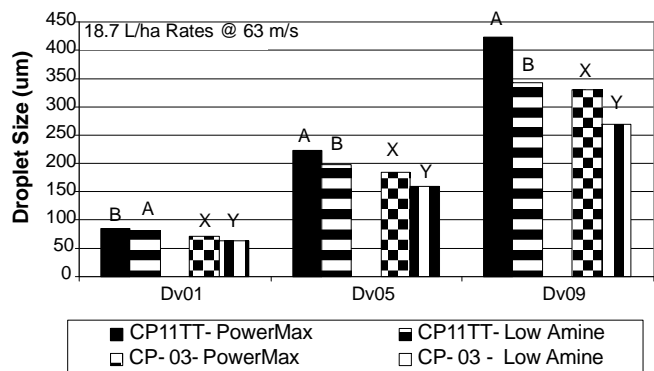

Figure 7. Droplet sizes for PowerMax and Low Mole Amine solutions at 18.7-L/ha spray rate in a 63-m/s airstream. (Within each droplet size category and nozzle type, means with the same letter are not significantly different.)

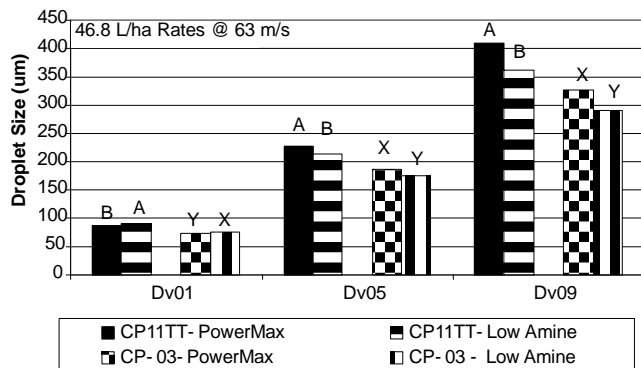

Figure 8. Droplet sizes for PowerMax and Low Mole Amine solutions at 46.8-L/ha spray rate in a 63-m/s airstream. (Within each droplet size category and nozzle type, means with the same letter are not significantly different.)

(fig. 9). These increases can have a significant effect on the off-target movement of these sprays and applicators must be aware of this portion of the spray to help them mitigate drift.

### AGDISP MODELING RESULTS

#### Airpeed vs. Drift at 30 m for PowerMax at 18.7 L/ha

Generally, as airspeed increased and droplet size decreased, the AGDISP-predicted deposition 30-m downwind increased (table 2). For the PowerMax at the 18.7-L/ha rate applied with the CP-03 nozzle, there was a decrease in the 30-m deposition at the 47- to 56-m/s airspeeds as compared to the 45-m/s airspeed. Even though the  $D_{V0.5}$  decreased from 260 to 228 µm, the relative span also decreased from 1.49 to 1.35, which indicates a narrowing in the size distribution and thus a reduction in the smaller, driftable droplets.

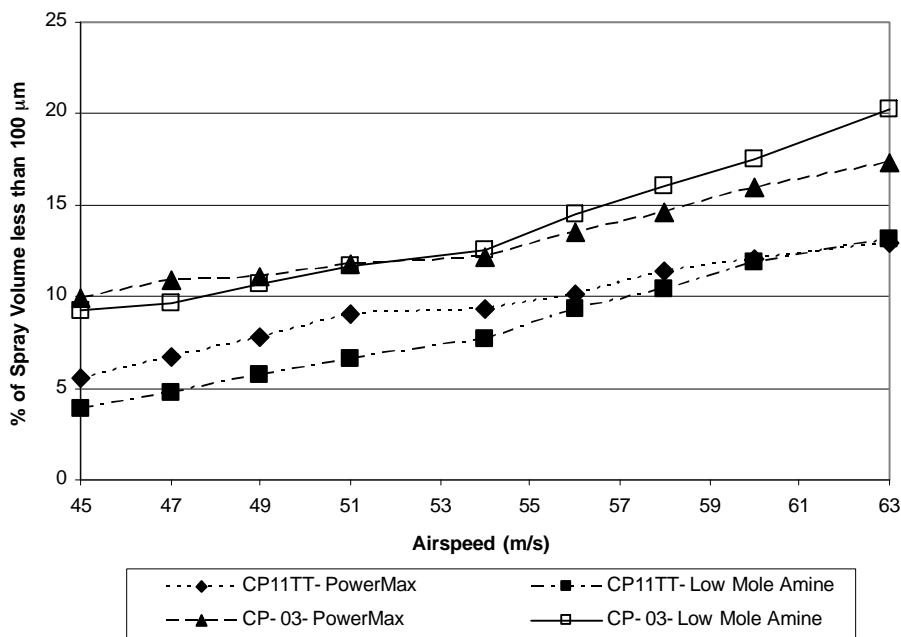

Figure 9. Percent of spray volume contained in droplets less than 100 µm for PowerMax and Low Mole Amine solutions in 45- to 63-m/s airstreams.

Table 2. AGDISP modeled deposition at 30 m based on droplet size data measured for the PowerMax solution at the 18.7-L/ha spray rate as applied through the CP11TT and CP-03 nozzles at 45- to 63-m/s airspeed.

Airspeed (m/s)	CP11TT				CP-03			
	PowerMax at 18.7 L/ha				PowerMax @ 18.7 L/ha			
	$D_{V0.5}$ (µm)	RS <sup>[a]</sup>	Modeled Deposition at 30 m (L/ha)	Percent Increase in Deposition vs. 45-m/s Level	$D_{V0.5}$ (µm)	RS <sup>[a]</sup>	Modeled Deposition at 30 m (L/ha)	Percent Increase in Deposition vs. 45-m/s Level
45	326	1.54	0.00039	0	260	1.49	0.00057	0.0
47	317	1.55	0.00045	16.9	255	1.42	0.00047	-16.7
49	301	1.52	0.00045	15.3	249	1.38	0.00052	-7.9
51	290	1.52	0.00043	10.1	239	1.33	0.00049	-13.8
54	276	1.47	0.00048	24.8	215	1.32	0.00059	3.1
56	262	1.48	0.00054	39.2	228	1.35	0.00055	-2.4
58	248	1.48	0.00058	50.3	205	1.35	0.00069	21.5
60	232	1.40	0.00058	50.3	193	1.37	0.00083	45.6
63	223	1.52	0.00077	99.2	184	1.41	0.00096	69.7

[a] RS = Relative Span calculated as  $(D_{V0.9} - D_{V0.1})/D_{V0.5}$ .



### Changes in Airspeed in a Simulated Field Application for Drift Minimization

Deposition at 0-, 50-, and 100-m downwind was compared over all application scenarios. For these analyses, spray applications or passes made at 54 and 63 m/s will be termed low-speed and high-speed passes; respectively. At 0-m downwind, a reduction in deposition of 12% occurred with one low-speed pass included (fig. 10). Adding additional low-speed passes did result in minor decreases of downwind deposition up to an additional five low-speed passes, but beyond that, further additional low-speed passes provided no change in deposition. At 50-m downwind, a reduction in deposition of 10% occurred with three low-speed passes included (fig. 10). While additional passes did further decrease deposition, these changes were minimal. There was a 10% decrease in off-target movement with three, low-speed passes and a 14% decrease with 20 low-speed passes. At 100-m downwind the greatest step decrease occurred with two-low speed passes (<4% at one-low speed passes and >8% at two-low speed passes) and while additional reductions occurred with increasingly more 54 m/s passes, stepwise decreases were minimal after three low-speed passes. These lower speed passes would have minimal impact on the productivity, expressed as hectare sprayed per hour, of an agricultural aircraft. If a field boundary (i.e. spray pass) was 1 km long, it would take 18.5 s to make a low-speed pass and 15.8 s to make a high-speed pass. Therefore, three low-speed passes would only add 8 s to the time required to spray a field.

### CONCLUSIONS

A total of 108 replicated spray tests, comprised of two nozzle configurations, four spray formulations, two application rates, and nine airspeeds were completed for this

study. Based on the results presented, the following conclusions were made:

- $D_{V0.5}$  for all treatments decreased by 30% to 50% as the airspeed increased from 45 to 63 m/s. As the airspeeds increased from 45 to 63 m/s, the percent of spray volume contained in droplets less than 100  $\mu\text{m}$  ( $\% <100 \mu\text{m}$ ) increased by 2-2.5X. There were significant differences in the droplet sizes measured for the PowerMax formulation and the three potential mimic sprays.
- The two EPA DRT evaluation spray formulation blanks (Water + NIS and the EC blank) were not representative of either the PowerMax formulation physical properties or the atomization characteristics for the nozzles and airspeeds selected. Additionally, the Low Mole Amine solution used in these tests was significantly different from the PowerMax solution, in terms of physical properties and atomization characteristics, reflecting how significant an effect the active ingredient has on the spray formulation.
- DRT evaluations that required the use of mimic (i.e. non-active ingredient containing spray formulation) spray solutions in place of active ingredient spray solutions would require preliminary testing to determine an acceptable mimic in terms of physical properties and atomization characteristics.
- AGDISP modeling demonstrated that the addition of slower-speed passes near the edge of a field can potentially reduce the off-target movement and deposition of applied material. Two or three lower-speed passes near the edge of the spray field are enough to result in 6% to 10% reductions in off-target movement. The loss in productivity (i.e. ha sprayed per hour) for an aerial applicator to make three low-speed passes on the downwind edge of a field is negligible, while the decrease in off-target movement of spray is significant.

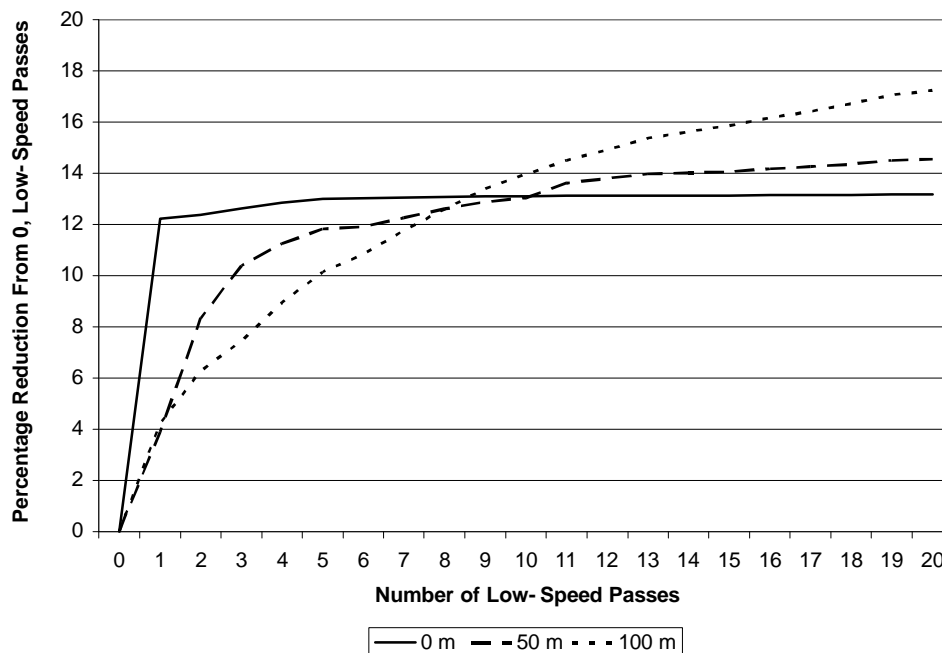

Figure 10. Percentage reduction in deposition at 0-, 50-, and 100-m downwind by number of spray passes made at 54 m/s as compared to all 20 spray passes made at 63 m/s (i.e. no 54-m/s passes).

## ACKNOWLEDGEMENTS

The authors would like to thank P. Jank, C. Harris, and L. Denham for their help on this project. This study was supported in part by a grant from the Deployed War-Fighter Protection (DWFP) Research Program, funded by the U.S. Department of Defence through the Armed Forces Pest Management Board (AFPMB). Appreciation is also expressed to Carolyn Baecker, CP Products Inc., for providing the nozzles for this study.

## REFERENCES

- ASTM Standards*. 2003. E 1260. Standard test method for determining liquid drop size characteristics in a spray using optical nonimaging light-scattering instruments. West Conshohocken, Pa.: ASTM Intl.
- ASTM Standards*. 2004. E 1620. Standard terminology relating to liquid particles and atomization. West Conshohocken, Pa.: ASTM Intl.
- Bouse, L. F. 1994. Effect of nozzle type and operation on spray droplet size. *Trans. ASAE* 37(5): 1389-1400.
- EPA. 2006. Pesticide spray drift reduction technologies: Verification and incentives for use. Washington, D.C.: U.S. Environmental Protection Agency. Available at: [www.epa.gov/etop/forum/problem/progressreports/pest-spray-9-15-06.html](http://www.epa.gov/etop/forum/problem/progressreports/pest-spray-9-15-06.html).
- EPA. 2002. Environmental technology verification program, quality management plan. EPA Publication No. EPA/600/R 03/021. Washington, D.C.: Office of Research and Development, U.S. Environmental Protection Agency.
- EPA. 2001. Pesticide registration (PR) notice 2001-x draft: Spray and dust drift label statements for pesticide products. Washington, D.C.: U.S. Environmental Protection Agency. Available at: [www.epa.gov/PR\\_Notices/prdraft-spraydrift801.htm](http://www.epa.gov/PR_Notices/prdraft-spraydrift801.htm).
- Giles, D. K. 1997. Independent control of liquid flow rate and spray droplet size from hydraulic atomizers. *Atomiz Sprays* 7(2): 161-181.
- Hanks, J. E. 1995. Effect of drift retardant adjuvants on spray droplet size of water and paraffinic oil applied and ultralow volume. *Weed Tech.* 9(2): 380-384.
- Hewitt, H. J., E. W. Huddleston, R. Sanderson, and J. B. Ross. 1993. Effect of adjuvants and formulations on aerial spray drift potential. *Pest Sci.* 37(2): 209-211.
- Hewitt, A. J., D. R. Johnson, J. D. Fish, C. G. Hemansky, and D. L. Valcore. 2002. Development of the spray drift task force database for aerial applications. *Environ. Tox. Chem.* 21(3): 648-658.
- Hoffmann, W. C., J. R. Lingren, J. R. Coppedge, and I. W. Kirk. 1998. Application parameter effects on efficacy of a semiochemical-based insecticide. *Appl. Eng. in Agric.* 14(5): 459-463.
- Hoffmann, W. C., and I. W. Kirk. 2005. Spray deposition and drift from two "medium" nozzles. *Trans ASABE* 48(1): 5-11.
- Hoffmann, W. C., T. W. Walker, V. L. Smith, D. E. Martin, and B. K. Fritz. 2007. Droplet size characterization of hand-held atomization equipment typically used in vector control. *J. American Mosq. Control Assoc.* 23(3): 315-320.
- Hoffmann, W. C., Fritz, B. K and Lan, Y. 2009. Evaluation of a proposed drift reduction technology (DRT) high-speed wind tunnel testing protocol. *J. ASTM Intl.* JAI Paper JAI102122.
- Kirk, I. W. 2007. Measurement and prediction of atomization parameters from fixed-wing aircraft spray nozzles. *Trans. ASABE* 50(3): 693-703.

Kosusko, M., K. Bullock, N. Birchfield, and A. Hewitt. 2006.

Development of a test plan to verify pesticide drift reduction technologies. ASABE Paper No. 061010. St. Joseph, Mich. ASABE.

Littell, R. C., P. R. Henry, and C. B. Ammerman. 1998. Statistical analysis of repeated measures data using SAS procedures. *J. Anim. Sci.* 76(4): 1216-1231.

Sayles, G., N. Birchfield, and J. Ellenberger. 2004. US EPA's research proposal for encouraging the use of spray drift reduction technologies. In *Proc. Int. Conf. on Pesticide Application for Drift Management*, 204-209. Waikoloa, Hawaii. Publisher: Washington State University. Available at: [pep.wsu.edu/drift04/proceedings.html](http://pep.wsu.edu/drift04/proceedings.html).

## APPENDIX

**Table 1A. AGDISP modeled deposition at 15- and 30-m downwind for the CP11TT and CP-03 nozzles and the Water + NIS spray solution.**

Airspeed (m/s)	Water + NIS Solution			
	CP11TT		CP03	
	Modeled Deposition at 15 m (uL/m <sup>2</sup> )	Modeled Deposition at 30 m (uL/m <sup>2</sup> )	Modeled Deposition at 15 m (uL/m <sup>2</sup> )	Modeled Deposition at 30 m (uL/m <sup>2</sup> )
45	0.071	0.011	0.125	0.021
47	0.072	0.009	0.139	0.021
49	0.086	0.010	0.153	0.022
51	0.092	0.010	0.200	0.028
54	0.091	0.012	0.203	0.028
56	0.124	0.013	0.246	0.034
58	0.143	0.016	0.284	0.041
60	0.151	0.018	0.309	0.046
63	0.227	0.030	0.416	0.060

**Table 2A. AGDISP modeled deposition at 15- and 30-m downwind for the CP11TT and CP-03 nozzles and the EC Blank solution.**

Airspeed (m/s)	EC Blank Solution			
	CP11TT		CP03	
	Modeled Deposition at 15 m (uL/m <sup>2</sup> )	Modeled Deposition at 30 m (uL/m <sup>2</sup> )	Modeled Deposition at 15 m (uL/m <sup>2</sup> )	Modeled Deposition at 30 m (uL/m <sup>2</sup> )
45	0.018	0.002	0.233	0.026
47	0.022	0.002	0.098	0.011
49	0.033	0.002	0.110	0.013
51	0.036	0.002	0.159	0.018
54	0.046	0.003	0.189	0.017
56	0.075	0.009	0.215	0.025
58	0.117	0.013	0.252	0.031
60	0.141	0.015	0.321	0.044
63	0.180	0.023	0.361	0.049

**Table 3A. AGDISP modeled deposition at 15- and 30-m downwind for the CP11TT and CP-03 nozzles and the PowerMax at 46.8-L/ha solution.**

Airseed (m/s)	PowerMax @ 46.8 L/ha			
	CP11TT		CP03	
	Modeled Deposition at 15 m (uL/m <sup>2</sup> )	Modeled Deposition at 30 m (uL/m <sup>2</sup> )	Modeled Deposition at 15 m (uL/m <sup>2</sup> )	Modeled Deposition at 30 m (uL/m <sup>2</sup> )
45	0.424	0.072	0.615	0.116
47	0.517	0.105	0.683	0.118
49	0.574	0.107	0.687	0.113
51	0.605	0.106	0.721	0.102
54	0.643	0.122	0.789	0.121
56	0.665	0.110	0.893	0.150
58	0.773	0.126	0.986	0.167
60	0.804	0.155	1.139	0.196
63	0.928	0.165	1.291	0.219

**Table 5A. AGDISP modeled deposition at 15- and 30-m downwind for the CP11TT and CP-03 nozzles and the Low Mole Amine at 18.7-L/ha solution.**

Airseed (m/s)	Low Mole Amine @ 18.7 L/ha			
	CP11TT		CP03	
	Modeled Deposition at 15 m (uL/m <sup>2</sup> )	Modeled Deposition at 30 m (uL/m <sup>2</sup> )	Modeled Deposition at 15 m (uL/m <sup>2</sup> )	Modeled Deposition at 30 m (uL/m <sup>2</sup> )
45	0.302	0.058	0.702	0.108
47	0.413	0.080	0.721	0.116
49	0.418	0.072	0.691	0.108
51	0.439	0.061	0.735	0.113
54	0.511	0.067	0.844	0.126
56	0.563	0.086	0.906	0.137
58	0.682	0.095	1.089	0.159
60	0.765	0.127	1.188	0.179
63	0.912	0.132	1.350	0.216

**Table 4A. AGDISP modeled deposition at 15- and 30-m downwind for the CP11TT and CP-03 nozzles and the PowerMax at 18.7-L/ha solution.**

Airseed (m/s)	PowerMax @ 18.7 L/ha			
	CP11TT		CP03	
	Modeled Deposition at 15 m (uL/m <sup>2</sup> )	Modeled Deposition at 30 m (uL/m <sup>2</sup> )	Modeled Deposition at 15 m (uL/m <sup>2</sup> )	Modeled Deposition at 30 m (uL/m <sup>2</sup> )
45	0.207	0.039	0.295	0.057
47	0.219	0.045	0.287	0.047
49	0.233	0.045	0.287	0.052
51	0.263	0.043	0.294	0.049
54	0.259	0.048	0.372	0.059
56	0.293	0.054	0.347	0.055
58	0.326	0.058	0.404	0.069
60	0.340	0.058	0.488	0.083
63	0.404	0.077	0.552	0.096

**Table 6A. AGDISP modeled deposition at 15- and 30-m downwind for the CP11TT and CP-03 nozzles and the Low Mole Amine at 46.8-L/ha solution.**

Airseed (m/s)	Low Mole Amine @ 46.8 L/ha			
	CP11TT		CP03	
	Modeled Deposition at 15 m (uL/m <sup>2</sup> )	Modeled Deposition at 30 m (uL/m <sup>2</sup> )	Modeled Deposition at 15 m (uL/m <sup>2</sup> )	Modeled Deposition at 30 m (uL/m <sup>2</sup> )
45	0.139	0.026	0.424	0.083
47	0.179	0.027	0.385	0.067
49	0.217	0.042	0.380	0.064
51	0.242	0.041	0.382	0.063
54	0.253	0.037	0.447	0.074
56	0.307	0.047	0.469	0.076
58	0.336	0.052	0.518	0.087
60	0.379	0.062	0.600	0.108
63	0.430	0.076	0.674	0.122