

Improving the Utility of a Binocular HMD in a Faceted Flight Simulator

Michael P. Browne

SA Photonics

San Francisco, CA

m.browne@saphotonics.com

Kirk Moffitt

Human Factors Consultant

La Quinta, CA

kirkmoffitt@earthlink.net

Marc Winterbottom

Air Force Research Laboratory

Mesa, AZ

Marc.Winterbottom@mesa.afmc.af.mil

ABSTRACT

Faceted simulator displays are widely used because they are relatively compact and economical. One drawback, however, is that viewing distance changes depending on where users are looking. This variation creates a challenge for the integration of binocular head mounted displays (HMDs), because confusing imagery and visual fatigue can result when the user views symbology presented by the HMD at one distance and simulator imagery at different distances. Understanding the best approach to presenting symbology with a binocular HMD in a faceted simulator has become an important issue, with the deployment of the F-35 Joint Strike Fighter and its binocular HMD. Successful integration of a binocular HMD would not only allow current faceted simulators to be retrofit with the F-35 simulator HMD, but would also allow future simulators to have either a dome or faceted design, thus affording acquisition agencies greater flexibility. Binocular HMDs are becoming more prevalent, so solving this integration issue will likely become important for multiple platforms.

We performed an experiment to quantify the best method of presenting symbology on a binocular HMD when used with a faceted simulator display. Five viewing conditions were tested: 1) HMD converged to 36", 2) HMD converged to 42", 3) dynamic HMD vergence, 4) monocular presentation on the HMD, and 5) on-screen presentation. Screen distances ranging from 36" to 54" were tested.

Our results suggest that adaptive vergence is the preferred solution. Both static vergence conditions and the monocular condition resulted in lower comfort scores and poorer performance. The on-screen condition, although rated comfortable, does not represent the real-world flight condition where symbology is displayed using an HMD. Although additional evaluations under more operational conditions remain to be completed, these results indicate that adaptive vergence is a viable solution for the integration of binocular HMDs into faceted flight simulator displays.

ABOUT THE AUTHORS

Michael Browne is the Vice President of Product Development at SA Photonics in San Francisco, California. He has a Ph.D. in Optical Engineering from the University of Arizona's Optical Sciences Center. Mike has been involved in the design, test and measurement of head mounted display systems since 1991. At Kaiser Electronics, Mike led the design of numerous head mounted display and rear-projection display systems, including those for the F-35 Joint Strike Fighter. Mike leads SA Photonics' efforts in the design and development of person-mounted information systems, including head-mounted displays and night vision systems.

Kirk Moffitt is a human factors consultant specializing in real and virtual displays and controls. He holds a Ph.D. in Engineering Psychology, and has 28 years of industry experience. He is the co-editor of the McGraw-Hill text *Head Mounted Displays: Designing for the User*. His clients have included military, medical, industrial and entertainment companies. Dr. Moffitt has also taught courses in human factors and statistics for the University of Southern California, and seminars on HMD design for SPIE and other organizations.

Marc Winterbottom is a Research Psychologist at the Air Force Research Laboratory in Mesa, Arizona. His research focuses on immersive decision environments, intuitive learning, and visual perception, particularly as it relates to display technologies for simulation and training applications. He received a M.S. degree in Human Factors Psychology from Wright State University and a B.A. degree in Psychology from Purdue University.

Report Documentation Page

Form Approved
OMB No. 0704-0188

Public reporting burden for the collection of information is estimated to average 1 hour per response, including the time for reviewing instructions, searching existing data sources, gathering and maintaining the data needed, and completing and reviewing the collection of information. Send comments regarding this burden estimate or any other aspect of this collection of information, including suggestions for reducing this burden, to Washington Headquarters Services, Directorate for Information Operations and Reports, 1215 Jefferson Davis Highway, Suite 1204, Arlington VA 22202-4302. Respondents should be aware that notwithstanding any other provision of law, no person shall be subject to a penalty for failing to comply with a collection of information if it does not display a currently valid OMB control number.

1. REPORT DATE 2009		2. REPORT TYPE		3. DATES COVERED 00-00-2009 to 00-00-2009	
4. TITLE AND SUBTITLE Improving the Utility of a Binocular HMD in a Faceted Flight Simulator				5a. CONTRACT NUMBER	
				5b. GRANT NUMBER	
				5c. PROGRAM ELEMENT NUMBER	
6. AUTHOR(S)				5d. PROJECT NUMBER	
				5e. TASK NUMBER	
				5f. WORK UNIT NUMBER	
7. PERFORMING ORGANIZATION NAME(S) AND ADDRESS(ES) SA Photonics, San Francisco, CA				8. PERFORMING ORGANIZATION REPORT NUMBER	
9. SPONSORING/MONITORING AGENCY NAME(S) AND ADDRESS(ES)				10. SPONSOR/MONITOR'S ACRONYM(S)	
				11. SPONSOR/MONITOR'S REPORT NUMBER(S)	
12. DISTRIBUTION/AVAILABILITY STATEMENT Approved for public release; distribution unlimited					
13. SUPPLEMENTARY NOTES Interservice/Industry Training, Simulation, and Education Conference (IITSEC) held in Orlando, FL on 30 Nov - 3 Dec, 2009.					
14. ABSTRACT					
15. SUBJECT TERMS					
16. SECURITY CLASSIFICATION OF:			17. LIMITATION OF ABSTRACT Same as Report (SAR)	18. NUMBER OF PAGES 11	19a. NAME OF RESPONSIBLE PERSON
a. REPORT unclassified	b. ABSTRACT unclassified	c. THIS PAGE unclassified			

Improving the Utility of a Binocular HMD in a Faceted Flight Simulator

Michael P. Browne

SA Photonics

San Francisco, CA

m.browne@saphotonics.com

Kirk Moffitt

Human Factors Consultant

La Quinta, CA

kirkmoffitt@earthlink.net

Marc Winterbottom

Air Force Research Laboratory

Mesa, AZ

Marc.Winterbottom@mesa.afmc.af.mil

INTRODUCTION

Our previous work (Browne, Moffitt, & Winterbottom 2008) investigated visual anomalies while using a binocular head mounted display (HMD) in a faceted flight simulator (a simulator with multiple flat “tiles” instead of a dome). These anomalies included subject reports of floating, buried or confusing symbology, doubling of symbology or the background imagery, symbology slanted relative to the simulator screen, and general viewing discomfort. Our primary conclusion was that these visual anomalies could be problematic when integrating binocular HMDs into faceted flight simulators.

The viewing discomfort subjects reported was likely caused by diplopia – or double imaging. Diplopia occurs often in the real world when we look at multiple objects located at different viewing distances. When directing our attention to a given object, we subconsciously suppress double vision of objects at other distances. Diplopia is problematic when using a binocular HMD in a faceted simulator because there are some circumstances, such as targeting an enemy aircraft, where the user must view both the out the window display (target) and the HMD image (targeting reticle) simultaneously, as shown in Figure 1.

Vergence angle is a strong depth cue – an object is seen as closer in depth when the eyes are converged (angled inward) and more distant when the eyes are diverged (becoming more parallel). Figure 1-left shows the position of the two eyes when verged for the out the window (OTW) image. If the HMD symbology is in front of the OTW image, as could occur in a faceted display, then that image falls on non-matching locations in the two eyes, creating a double image of the HMD symbology. Alternatively, if the user shifts their vergence to the HMD symbology's depth, then the OTW image will appear doubled (Figure 1-right).

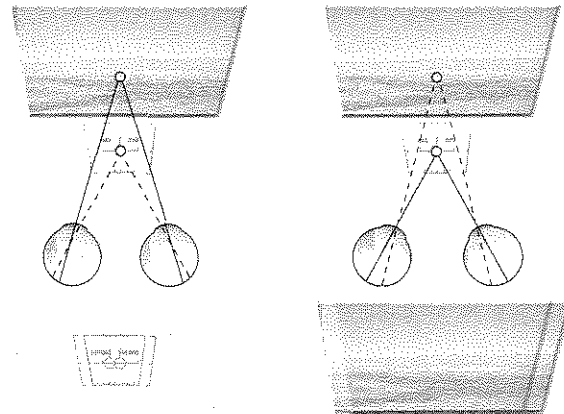

Figure 1. Graphical Depiction Of Diplopia Caused By Concentrating On Two Objects At Different Distances Simultaneously. Concentrating On The OTW Scene (Shown To The Left) Causes A Diplopic Image Of The Reticle. Concentrating On The Reticle Causes A Diplopic Image Of The OTW Scene.

The specific flight simulator display design of interest for this investigation is the M2DART (Mobile Modular Display for Advanced Research and Training), a simulator display system that can be reconfigured and deployed for a variety of training tasks around the globe yet still provide panoramic imagery (Wight, Best & Peppler, 1998). The key to this design is the use of a faceted display and rear projection. These facets range in viewing distance from as close as 36 inches to a practical maximum of 54 inches. This range of viewing distances creates the potential for vergence mismatch central to our investigations.

Figure 2 demonstrates a simplified overhead view of a faceted simulator like the M2DART. The green line represents the HMD symbology, presented at a fixed vergence distance. Shown also are two OTW display facets (one straight ahead, one angled on the right). As the user looks at different locations within the faceted simulator, the difference in distance between the HMD symbology (green line) and the display facet changes.

When the user is looking straight ahead (Figure 2-left), there is no distance difference. When the user looks at the seam between the display facets (Figure 2-center) there is a significant distance difference at the center of the field of view. When the user looks at the right facet (Figure 2-right) there is a constantly varying distance difference. If these distance differences get too large, the user will report visual anomalies, including eyestrain, confusing imagery and diplopia.

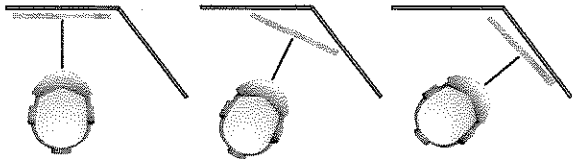

Figure 2. Simplified Overhead View Showing The Distance Difference Between The HMD Image Plane And Two Adjoining Screens Of A Faceted Display System.

Since the development of the M2DART, a variety of manufacturers have developed similar faceted display designs (e.g. Boeing VIDS, L3 SimuSphere, Glass Mountain Optics WASP). These display systems are used widely across the services for a variety of training applications. As such, we expect that as long as there are faceted simulators, the potential exists for vergence mismatch when using a binocular HMD.

In an aircraft, all of the information that the pilot views outside the cockpit is at or near optical infinity (distances from 30 feet and beyond). No matter where the pilot looks, the vergence is basically the same. Therefore, the HMD can be designed such that for aircraft use, its symbology is also converged to optical infinity. Because of this, there is no vergence mismatch between the OTW scene and the HMD symbology for an HMD used in an aircraft. The monochrome HMD symbology in an aircraft will appear distinct from the real world, and may appear closer in distance, but should not appear blurry, doubled or slanted relative to the OTW scene.

Despite the optical equivalence of the HMD symbology and real-world imagery, there is substantial evidence that the pilot switches attention between the two (e.g., McCann, Foyle, & Johnston, 1993; McCann, Lynch, Foyle, & Johnston, 1993). This attention switching is not driven by binocular disparity and focus, but by dissimilar visual imagery and information. We postulated that increased visual disparity will lead to an increase in attention switching (and an increase in time to perform a task) and

designed the performance experiment to test this hypothesis.

Future military aircraft are likely to have an HMD that supports visual cueing with symbology and imagery. The Joint Strike Fighter (JSF) will be the first US fighter jet with a binocular HMD that serves as a primary flight instrument. Although a dome display may be a good solution for the F-35 and other platforms, a number of concerns have been raised about using dome simulators. The first is that if all faceted simulators have to be replaced with dome simulators, it will be at a large cost. The second concern is the size of the training system footprint and visual system complexity, which drive cost factors associated with training device installation and sustainment. These issues make the integration of a binocular HMD into smaller, more cost-effective faceted displays of particular interest.

The above concerns make the compatibility of faceted simulators with binocular HMDs an urgent problem in training F-35 pilots. The goal of the present experiment was to quantify vergence mismatch effects identified in our first experiment (Browne, Moffitt and Winterbottom, 2008). We also wanted to identify the best solutions for improving symbology appearance, viewing comfort and pilot performance for a binocular HMD integrated with a faceted display.

In our previous work, we tried a number of HMD viewing conditions but no single HMD configuration prevented all the problems associated with integrating a binocular HMD with a faceted display. Binocular symbology converged to one simulator viewing distance appeared diplopic or doubled at other distances. Monocular symbology avoided this vergence mismatch, but was rated by most observers as less comfortable to view compared to binocular symbology. Both binocular and monocular symbology appeared slanted relative to the simulator screen whenever the symbology was not viewed straight-ahead. On-screen symbology exhibited no binocular problems and was rated as comfortable to view, but this solution does not utilize an HMD and creates a training situation that is not representative of what users will see in flight.

In the virtual world of HMD symbology, vergence can be manipulated electronically by adjusting the horizontal binocular disparity. Electronically shifting the left- and right-eye symbology creates the perception of a change in depth. An inward shift brings the symbology forward, while an outward shift pushes the symbology away. We used this concept to

design an adaptive viewing condition that electronically and automatically adjusts the vergence of the HMD depending on where the user is looking within the faceted display. One of the goals of our current experiment was to validate this approach both in terms of comfort and performance.

METHODS

Observers

Thirteen observers (twelve male and one female), ages 25 to 63, participated in our experiments. All had experience with the design, marketing or use of HMDs. Four participants described themselves as “very familiar” with HMDs. Four subjects were fighter pilots, three of whom had extensive experience with the monocular joint helmet mounted cueing system (JHMCS) HMD. The interpupillary distance (IPD) of each subject was measured with an L8 pupilometer, model NH-L8. Eye dominance was determined by noting which eye was used for sighting through an aperture. Eight participants were right-eye dominant and five were left-eye dominant. Following helmet fitting and HMD adjustment, the resting position of vergence was measured using nonius targets with a dark background. Intact stereo vision was ascertained by presenting three depth planes of symbols, and asking the subject to identify the close, intermediate and distant figures. Finally, a binocular acuity level of 2.6 minutes or 20/52 was verified with on-screen “tumbling Es” presented at the straight-ahead viewing distance of 36 inches. Six of the participants wore eyeglasses, three of whom had progressive lenses.

Stimuli and Apparatus

A Rockwell-Collins Optronics SimEye SXL50 STM binocular see-through HMD was used for our experiment. This HMD, shown in Figure 3, was designed as a simulator HMD for the F-35 Joint Strike Fighter. It has a 1280 x 1024 pixel format, 40 x 30 degree field-of-view (FOV), and monochrome green imagery. Focus of this unit was 0.9 diopter (not accounting for chromatic aberration) with a nominal optical vergence distance of 34.5” (88 cm). This HMD has a see-through transmission of >70% and was set to a nominal luminance of 6.5 fL. This HMD clasps onto an HGU-55/P military flight helmet. Three helmet sizes were available for this study: M, L & XL.

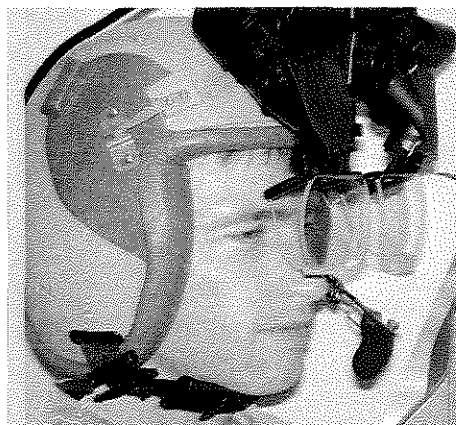

Figure 3. SimEye SXL50 HMD.

A Sony SXRD 3-panel LCOS (liquid crystal on silicon) 1920 x 1080 pixel monitor with a nominal luminance of 35 fL (at the brightest portion of the sky) was used to present the out-the-window (OTW) imagery. The Sony monitor had a horizontal dimension of 52”, as shown in Figure 4. The straight ahead viewing distance was 36” and the nominal viewing position was 9” in from the left edge of the screen. This allowed us to test viewing distances ranging from 36” (straight ahead) to 54” (near the upper right hand corner). These distances encompassed the minimum and maximum viewing distances of the M2DART.

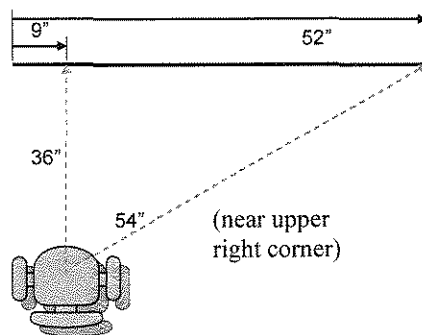

Figure 4: Layout of Simulator Screen and Subject Positioning

The trade-off involved with replicating the M2DART viewing conditions on a single monitor was that our experiment presented symbology at a more severe apparent slant angle than found in the M2DART. Some observers commented on this slant but we think that overall the conclusions for our experiment transfer to the M2DART.

A PC computer with nVidia GeForce graphics cards provided the imagery for both the HMD and monitor. A Polhemus Liberty tracker transmitted head position

and angle relative to the OTW display. Testing took place in an area surrounded by black curtains with a nominal illuminance of 1.5 fc. HMD luminance, monitor luminance and room illuminance were periodically tested to ensure nominal levels were maintained.

The experimental tasks used an HMD reticle and an OTW image of a desert scene including sky, mountains, and a distant city. The HMD reticle, shown in Figure 5, subtended a total of 8 x 6 degrees, with the center circle subtending 1.5 degrees. Each target on the OTW display was a 51 x 22 pixel helicopter image subtending 2.1 x 0.9° degrees at the straight-ahead 36" screen position. The helicopter was gray with a green center dot to aid in centering the reticle on it. A photo of a person wearing the HMD and viewing the monitor is shown in Figure 6.

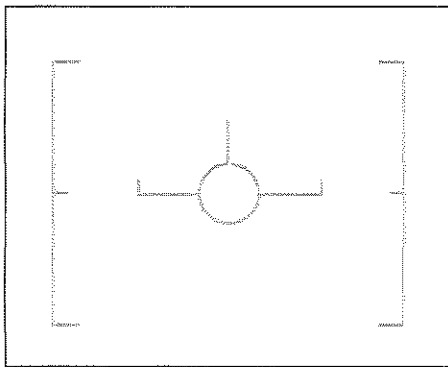

Figure 5. Targeting HMD Reticle



Figure 6. Subject Looking For A Target

Procedure

We asked subjects to complete four activities as part of our experiment: boresighting, reticle distance preference, viewing comfort and visual search and

performance. Each of these activities are discussed further in the next sections.

Boresighting

To calibrate the head-tracker prior to each series of trials, the system was boresighted to the relevant target locations. To do this, a target was presented on the OTW display and the subject aligned the HMD reticle with the target and pressed a mouse button.

Reticle Distance Preference

The apparent viewing distance of the HMD reticle can be changed by electronically shifting the images on the left and right eye microdisplays inside the HMD. We measured the preferred reticle distance for each of ten screen targets located along horizontal lines that divided the display vertically into quarters, and at distances of 36" to 54" in 2" increments. The primary purpose of this exercise was to establish preferred positions for the HMD vergence as a function of viewing distance. We used this information to set vergence dynamically for the adaptive viewing condition in the viewing comfort and performance experiments.

Participants began with the straight-ahead 36" target and adjusted the apparent viewing distance of the HMD reticle inward and outward using the left and right buttons of a mouse. They were instructed to put the reticle at the position that they felt would work best for them to complete a targeting task, not necessarily at the same distance as the screen. Target presentation progressed from left to right until the final 54" target was completed. For each target, head-tracker information was recorded with the reticle distance (stored as the lateral shift of the left- and right-image on the HMD display). Figure 7 shows approximately how the HMD imagery appeared relative to the OTW image for near, approximately equal, and more distant vergence settings.

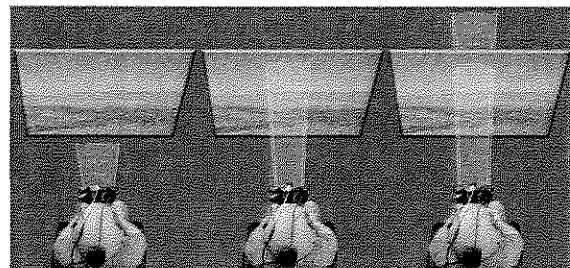

Figure 7. Appearance Of HMD Symbology Relative To OTW Imagery As The Viewer Electronically Adjusted Vergence Settings On The HMD

Viewing Comfort Rating

We expanded on our initial work to check viewing comfort as a function of viewing condition (Browne et al.). We changed the experiment to include better control over the reticle distance independent of subject interpupillary distance. We also checked viewing comfort over more distances and included an adaptive condition along with the fixed binocular, monocular and on screen conditions. For this adaptive condition, we used the head tracker to indicate where the subject was looking and changed the vergence such that the reticle viewing distance was approximately the same as the distance from the user to the OTW display.

Each trial started with practice targets located at three screen positions. Subjects were instructed to first preview the task by rotating their head to position the reticle over each target to see what different vergence mismatches looked like.

Once the practice session was over, the subject returned to the starting position, positioned the reticle over the 36" straight-ahead target and called out a rating of viewing comfort: "Not uncomfortable to view", "Somewhat uncomfortable to view" or "Very uncomfortable to view". This sequence was repeated for seven targets located from 36 to 54 inches along the horizontal mid-line in 3" increments.

The not/somewhat/very uncomfortable ratings were adapted from similar scales with approximately equal intervals (e.g., Babbitt & Nystrom, 1989). Subjects were instructed that "Not uncomfortable to view" means that the image may look unusual, but not blurry, doubled or confusing. You could easily view this image for a period of time. "Very uncomfortable to view" means the image may be blurry, doubled or confusing—something you would not want to view for any length of time. "Somewhat uncomfortable to view" describes a viewing comfort between these two extremes.

Five viewing conditions were tested: 1) Vergence set to the preferred reticle distance for the 36" target, 2) Vergence set to the preferred reticle distance for the 42" target, 3) An adaptive distance that adjusted the reticle to the user preferred distance for each target, 4) Monocular, presented in the right-eye, and 5) On-Screen, where the reticle was drawn on the OTW display.

Visual Search and Performance

In this experiment we investigated whether the viewing condition is simply a comfort and perception issue, or

if visual performance was also affected. Participants were asked to search for helicopter targets located at ten locations on the screen. These locations ranged in distance from 36" to 54" in 2" increments. The helicopter could appear in any of 10 positions, but all positions were randomly presented three times during the course of the experiment. When a target was located, the subject aligned the HMD reticle with the target and the reticle changed to a "missile lock" configuration (four arrows surrounding the targeting reticle, as shown in Figure 8). After one second of accurate alignment (representing a "missile lock"), a three-digit number was displayed on the reticle and another three-digit number was displayed on-screen. For the on-screen viewing condition, both numbers were displayed on-screen. These spatially adjacent numbers were compared by the participant. The participant was instructed to push the left mouse button if they were the same, and the right button if different. If an error was made, the subject was required to enter the correct response. After a correct response, a new target randomly appeared at one of the remaining locations, and the subject continued the search task. The numbers were displayed against a dark background to ensure consistent contrast across all target locations.

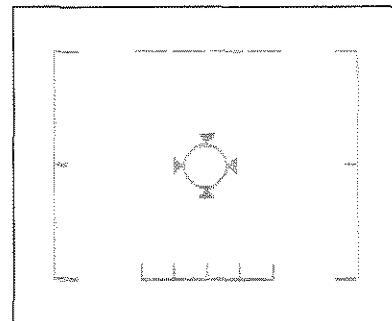

Figure 8: Lock Reticle

The five viewing conditions tested in the viewing comfort experiment were also used for this experiment. The preference data from the first experiment were used to adjust reticle distance for the adaptive condition. Three sequential trials were run for each condition. We randomized the order of presentation of each viewing condition across subjects to minimize learning and fatigue effects on the aggregate data.

We designed this experiment to replicate conditions in a real simulator environment where operators must redirect their attention between HMD symbology and on-screen imagery. The primary data from this task were total time to find and compare numbers at the ten

target locations. We also recorded single target times from acquisition to response.

RESULTS

Viewing Comfort Ratings

The results of the viewing comfort experiment are shown in a Marimekko chart (Figure 9). We feel this type of chart provides a good graphical representation of user comfort as a function both of viewing condition and of viewing distance. Each cell depicts the count of each rating choice for 13 participants. The proportion

of each cell which is shaded white gives an indication of the comfort of each viewing condition. For example, all subjects rated the on-screen viewing condition at 36" (located in the lowest, left-most cell) as comfortable, thus it is shaded completely white. On the other hand, the binocular 36" viewing condition at a 54" target distance was rated very uncomfortable by almost every subject, so that its cell (upper right-most cell) is shaded almost completely black.

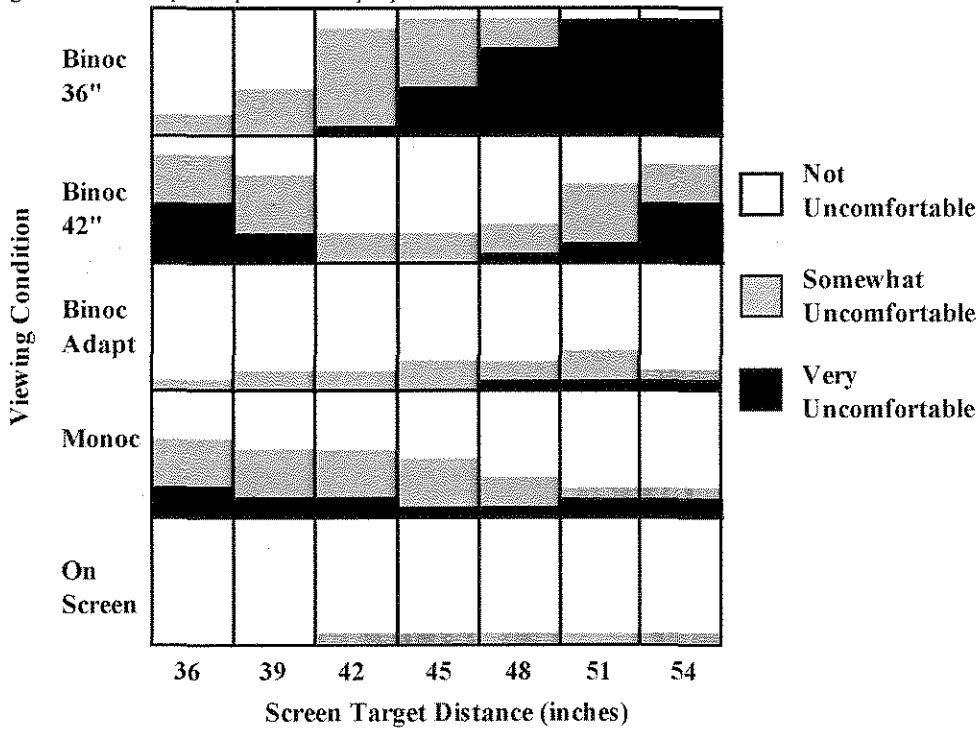

Figure 9. Comfort Ratings For The Five Viewing Conditions At Seven Target Distances

The rating of viewing comfort at each on-screen target distance was dependent on the viewing condition. The binocular 36" reticle shows a striking decrease in comfort as the target distance moves beyond 36". For the 42" reticle, the most comfortable viewing is found at 42" and 45", while nearer and further target distances resulted in greater reports of discomfort. These results indicate that a fixed-distance HMD reticle only results in comfortable viewing at or near a corresponding target distance, in general agreement with Browne, et al.

The binocular adaptive viewing condition used the preference data from the first experiment to adjust the HMD reticle distance based on target distance. The results in Figure 9 show mostly comfortable viewing at all target distances. The few somewhat or very uncomfortable ratings for the more distant targets may result from the increase in reticle/screen slant angle. This angle may look confusing to some participants when presented in the context of this experiment. Despite these minor issues, the binocular adaptive viewing condition was very successful at mitigating vergence mismatch compared to the other HMD-based methods.

Results from Browne, et al, plus our previous experience with monocular HMDs indicate that monocular viewing is problematic, and the data for the monocular condition appear to confirm this expectation. The most discomfort was found at the closer target distances but some subjects even found the more distant targets uncomfortable to view with a monocular presentation.

The on-screen reticle was in perfect correspondence with the screen target and imagery in terms of depth, but it resulted in a high degree of slant relative to the line-of-sight, and it decreased in angular size with distance. Even so, this viewing condition was rated as most comfortable to view, in agreement with Browne, et al. (2008).

Visual Search and Performance

We calculated the median search time (time to find the target and achieve “lock”), the median response time (time between “lock” and a correct response on the number matching task) and the total time (sum of search and response times). The average search time for all ten targets ranged from 38 to 41 seconds, and the effect of viewing condition was not significant. Although we measured large differences in the ratings of comfort for the five viewing conditions, it did not translate into a difference in overall performance or in search time. Both of these metrics include a disproportionate amount of time searching for the next target. The amount of time spent on searching for a target might be too coarse of a measure to identify differences in performance among viewing conditions.

In contrast, response time was directly related to the reticle viewing condition. We defined response time as the elapsed time between target acquisition and a correct manual response. We feel that response time is a good metric for proving our hypothesis that the bigger the disparity is between HMD and OTW imagery, the longer it will take the subject to make a correct response. While differences in background imagery and target location could affect the time to find each target, the effect on response time should be minimal.

We found significant effects for Viewing Condition [$F(4, 48) = 3.69, p < .05$]; Target Position [$F(9,108) = 5.07, p < .001$]; and the interaction of Viewing Condition and Target Position [$F(36,432) = 1.74, p < .01$].

The aggregate median response times across viewing conditions are shown in Figure 10. The adaptive viewing condition had the quickest aggregate median response time of 1115 msec. Just slightly slower was the onscreen condition, with a time of 1157 msec. The fixed vergence conditions were more than 10% slower than the adaptive or onscreen cases and the monocular viewing condition provided the longest response times.

The data show rather large error bars (standard deviation), representing the significant subject to subject variation for each viewing condition, but we believe that the trend is obvious with adaptive and onscreen taking the least time and monocular taking the most. This indicates that not only are the fixed vergence conditions and the monocular condition less comfortable, but they also have an impact on user performance, at least for a targeting task.

Figure 11 shows how the response time varies as a function not only of viewing condition but also of target location. We split the viewing conditions into two graphs so that the data is easier to visualize. The adaptive data appears on both graphs. Since it was the most likely condition to be implemented in a real system, we wanted to ensure that we could compare all other viewing conditions to it.

There is a large variation in response time across viewing conditions for the very near targets, with relatively rapid responses for some viewing conditions (on-screen and adaptive) and others (binocular 36” and 42”) with significantly slower response times. In the mid-distances, there were differences between the viewing conditions, but no obvious trends. At the far distances performance for all viewing conditions worsened, while corresponding ratings of “somewhat” and “very uncomfortable” were only found with binocular 36” and 42” conditions. We attribute this increased response time at the longest target distances to the fact that the font size and contrast were reduced when viewed from these distances. Numerous subjects stated that the numbers were very hard to read at the longer target distances. We tried to balance the experiment by not making the numbers too easy to read at the short distances so that there would be the potential for a noticeable difference between different viewing conditions. We may need to increase the readability of the compared numbers for future experiments.

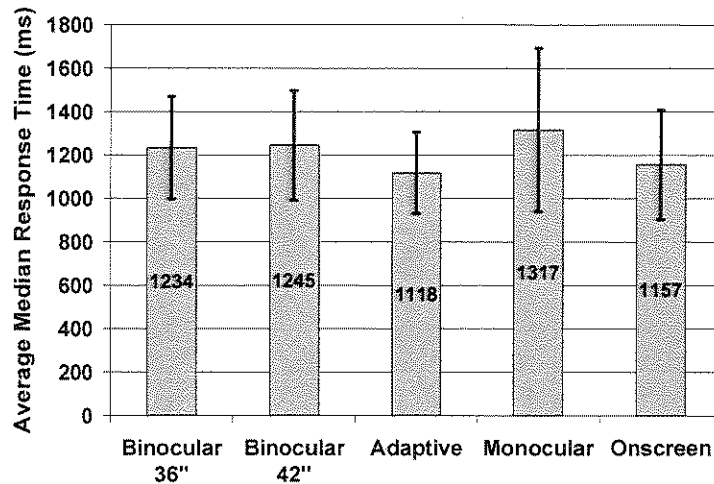

Figure 10. Average Median Response Time As A Function Of Viewing Condition

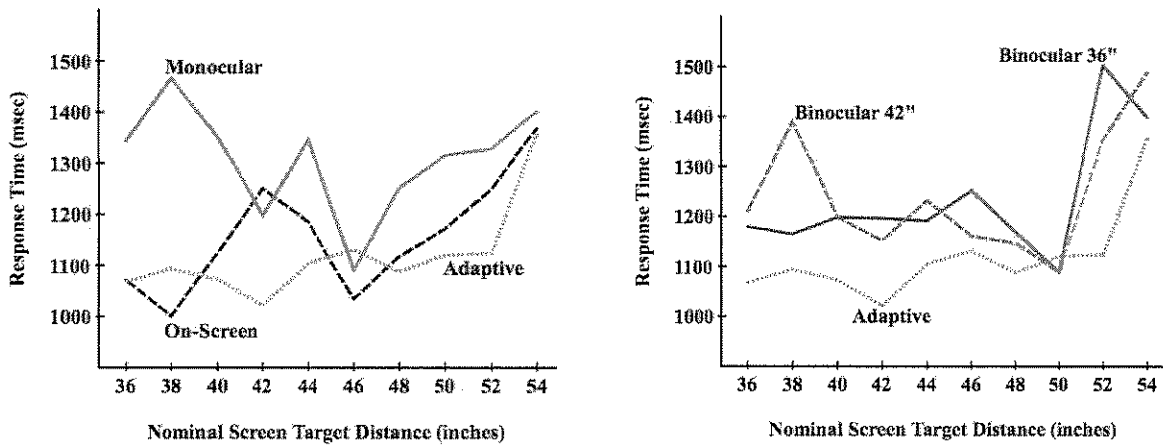

Figure 11. Average Median Response Time As A Function Of Viewing Condition And Target Distance

DISCUSSION

We investigated the effect of five viewing conditions on viewing comfort and visual performance for a binocular HMD integrated with a faceted OTW display. Our experiments confirmed that setting the HMD reticle to a single viewing distance is not a good solution for the 36" to 54" range of viewing distances found in the M2DART faceted simulator display. We not only found that a static vergence viewing condition was uncomfortable to view over many viewing distances but also that a static vergence negatively impacted performance on a targeting task. In addition, for a fixed vergence the question always remains to what distance should the vergence be set? If it is set at the straight ahead distance of 36", all other locations have a vergence setting which is too close and the

more distant OTW positions will be uncomfortable to view. If the dioptric average distance of 42" is chosen, most users are not satisfied with the viewing comfort straight ahead at 36", or at larger distances of 54".

Monocular viewing was also found to be uncomfortable to view, primarily at close screen distances, but some users found it uncomfortable even at the longer target distances. These problems extended to the performance task as well, where the monocular condition produced the slowest response times of all conditions tested at any viewing distance.

These problems with monocular imaging are interesting because most current HMD systems used in U.S. fighter jets and helicopters are monocular (JHMCS, DASH, IHADSS). In fact, a number of the

subjects who were pilots and had flown JHMCS expressed concern about the comfort of monocular HMD imagery once they experienced binocular HMD imagery. Whether or not this monocular discomfort and reduction in performance can be solved with training is beyond the scope of this experiment, but it suggests future research into the efficacy of monocular imaging for both simulation and flight hardware.

The adaptive condition was more comfortable to view compared to any of the other viewing conditions with the exception of on-screen. This condition also showed the best visual performance in the search task, providing the shortest response times of any viewing condition tested.

The on-screen condition was the most comfortable to view and resulted in good response time performance, second only to the adaptive condition. There are a number of issues; however, with using on-screen symbology to train pilots, including the fact that the on-screen symbology follows the slant of the simulator screen and does not look geometrically correct. This was especially true at the farthest distance of 54". In addition, using on-screen symbology will have significant visual differences to users compared to using symbology presented by an HMD. Since the HMD is a primary flight instrument for the F-35 aircraft, we believe that it would be much better to train users with imagery in the simulator that looks as it will in flight.

One additional concern is that although vergence is changed dynamically with the adaptive viewing condition, we do not change the focus of the HMD as the user looks at different OTW distances. Normally, focus and vergence are coupled, so objects at the same depth will appear in focus, and objects at a different depth could appear blurred. Although dynamic vergence would manipulate vergence independently of focus, which can potentially be problematic for large discrepancies (Hoffman, Girshick, Akeley, & Banks, 2008), we believe the small distances we are concerned with will be within a comfortable range and within the depth of focus of the eye (Winterbottom, Patterson, Pierce, Covas, & Winner, 2007).

Winterbottom, et al showed that depth of focus was not likely to be an issue provided the difference in depth between two images was within a reasonable dioptic range, as it is for our experiment and in the M2DART. Hoffman, et al (2007) showed that decoupling of vergence and accommodation can potentially create discomfort (at a 0.67 diopter (D) separation). The maximum separation of 0.18 D used in our experiment

and in the M2DART was much less than the 0.67 D tested by Hoffman, et al and thus unlikely to cause discomfort. The maximum distance difference in the M2DART represents a worst case. Other faceted simulators, with smaller facets, would require dynamic vergence adjustments of even less than the 0.18 D range that we tested over.

In summary, we believe that adaptive vergence provides a viable solution for integrating a binocular HMD with faceted display systems. This recommendation is supported not only by viewing comfort data, but also by user performance data. We believe these results apply not only to the M2DART, but also to other faceted simulator displays with similar viewing distance ranges.

We will seek to confirm our conclusions by integrating the F-35 simulator HMD with dynamic vergence control into a state-of-the-art faceted display system with pilots executing realistic training tasks under more operational conditions.

Development of an adaptive vergence control system would provide existing users of faceted display systems with a solution for integrating binocular HMDs for future training applications, and provide acquisition agencies with additional alternatives when evaluating competing display system designs for training systems requiring binocular HMDs in simulators.

ACKNOWLEDGEMENTS

The research reported here was made possible via Small Business Innovative Research (SBIR) Phase II contract FA8650-08-C-6844 sponsored by the Air Force Research Laboratory. In addition, we acknowledge the assistance of Casey Wimsatt in performing the software coding, database design, hardware interfacing and for providing valuable input into the construction of the experiment. We thank Mr. John Sepanski and the Air Combat Command for their continuing support of this project.

REFERENCES

- Babbitt, B. A., & Nystrom, C. O. (1989). Questionnaire construction manual (Research Product 89-20). Fort Hood TX: U.S. Army Research Institute for the Behavioral and Social Sciences.

- Browne, M. P., Moffitt, K., & Winterbottom, M (2008). Vergence mismatch effects in a binocular see-through HMD. The Interservice Training, Simulation & Education Conference (I/ITSEC). Orlando FL.
- Hoffman, D., Girshick, A., Akeley, K., and Banks, M. (2008). Vergence-accommodation conflicts hinder visual performance and cause visual fatigue. *Journal of Vision*, pp. 1-30.
- McCann, R.S., Foyle, D.C. and Johnston, J.C. (1993). Attentional limitations with head-up displays. In R.S. Jensen (Ed.), *Proceedings of the Seventh International Symposium on Aviation Psychology*, 70-75. Columbus: Ohio State University.
- McCann, R.S., Lynch, J., Foyle, D.C. and Johnston, J.C. (1993). Modeling attentional effects with head-up displays. *Proceedings of the Human Factors and Ergonomics Society 37th Meeting* (pp. 1345 – 1349). Santa Monica CA: Human Factors and Ergonomics Society.
- Wight, D. R., Best, L. G., & Pepler, P. W. (1998). M2DART: A real-image simulator visual display system (AFRL-HE-AZ-TR-1998-0097). Mesa AZ: Air Force Research Laboratory.
- Winterbottom, M., Patterson, R., Pierce, B., Covas, C., and Winner, J. (2007). Depth of focus and visual recognition of imagery presented on simultaneously viewed displays: implications for head-mounted displays. *Human Factors*, pp. 907-919.