



Methodology for Composite Durability Assessment

Stephen W. Tsai
Stanford University

John L. Townsley
The Boeing Company

September 2003
SAMPE Technical Conference
Dayton, OH

Approved for Public Release, Distribution Unlimited

Report Documentation Page

Form Approved
OMB No. 0704-0188

Public reporting burden for the collection of information is estimated to average 1 hour per response, including the time for reviewing instructions, searching existing data sources, gathering and maintaining the data needed, and completing and reviewing the collection of information. Send comments regarding this burden estimate or any other aspect of this collection of information, including suggestions for reducing this burden, to Washington Headquarters Services, Directorate for Information Operations and Reports, 1215 Jefferson Davis Highway, Suite 1204, Arlington VA 22202-4302. Respondents should be aware that notwithstanding any other provision of law, no person shall be subject to a penalty for failing to comply with a collection of information if it does not display a currently valid OMB control number.

1. REPORT DATE 2003	2. REPORT TYPE N/A	3. DATES COVERED -	
4. TITLE AND SUBTITLE Methodology for Composite Durability Assessment		5a. CONTRACT NUMBER	
		5b. GRANT NUMBER	
		5c. PROGRAM ELEMENT NUMBER	
6. AUTHOR(S)		5d. PROJECT NUMBER	
		5e. TASK NUMBER	
		5f. WORK UNIT NUMBER	
7. PERFORMING ORGANIZATION NAME(S) AND ADDRESS(ES) The Boeing Company		8. PERFORMING ORGANIZATION REPORT NUMBER	
9. SPONSORING/MONITORING AGENCY NAME(S) AND ADDRESS(ES)		10. SPONSOR/MONITOR'S ACRONYM(S)	
		11. SPONSOR/MONITOR'S REPORT NUMBER(S)	
12. DISTRIBUTION/AVAILABILITY STATEMENT Approved for public release, distribution unlimited			
13. SUPPLEMENTARY NOTES The original document contains color images.			
14. ABSTRACT			
15. SUBJECT TERMS			
16. SECURITY CLASSIFICATION OF:			17. LIMITATION OF ABSTRACT UU
a. REPORT unclassified	b. ABSTRACT unclassified	c. THIS PAGE unclassified	
			18. NUMBER OF PAGES 34
19a. NAME OF RESPONSIBLE PERSON			



Contents



- 1. Introduction**
- 2. Accelerated Durability Assessment**
- 3. Strain Invariant Failure Theory**
- 4. Micromechanics Analysis**
- 5. Accelerated Testing Methodology**
- 6. Analysis Results**
- 7. Conclusions**



Objectives



AIM-C : Accelerated Insertion of Materials – Composites

(Funded by DARPA and managed by NavAir)

The goal of the AIM-C program

- (1) Accelerate the insertion of new materials and processes
- (2) Evaluate the effects of material, processing, and design on the performance of composite structures

Our objective is to analyze

- **Environmental effects** (temperature, moisture)
- **Durability** (creep and fatigue life, residual strength)



State of the Art in Composite Analysis



No principal stresses or strains

- Composites are highly orthotropic and viscoelastic

Involves numerous parameters

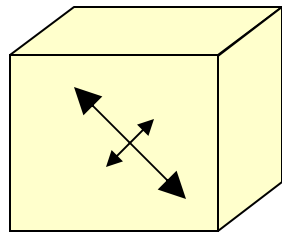

isotropic materials

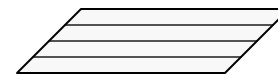
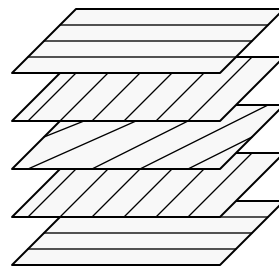

Ply failure



Laminate failure

$$\begin{aligned} &E_x, E_y, E_z, G_{xy}, G_{xz}, G_{yz} \\ &\sigma_x, \sigma_y, \sigma_z, \tau_{xy}, \tau_{xz}, \tau_{yz} \\ &X, X', Y, Y', S \end{aligned}$$

Composite materials

Smallest level of imperfection is at the fiber / matrix level

Infinite combinations of parameters must be tested



Contents



- 1. Introduction**
- 2. Accelerated Durability Assessment**
- 3. Strain Invariant Failure Theory**
- 4. Micromechanics Analysis**
- 5. Accelerated Testing Methodology**
- 6. Analysis Results**
- 7. Conclusions**



Analytical Models

Strain Invariant Failure Theory (SIFT)

- Predicts initial and final failure of composite structures

Micromechanics

- Predicts 3-D ply properties and strain magnification factors

Accelerated Testing Methodology (ATM)

- Rapid generation of durability database as master curves

Linear Cumulative Damage Law (LCD)

- Life estimation under combined fatigue/creep loads
- Residual strength prediction



Analysis Architecture

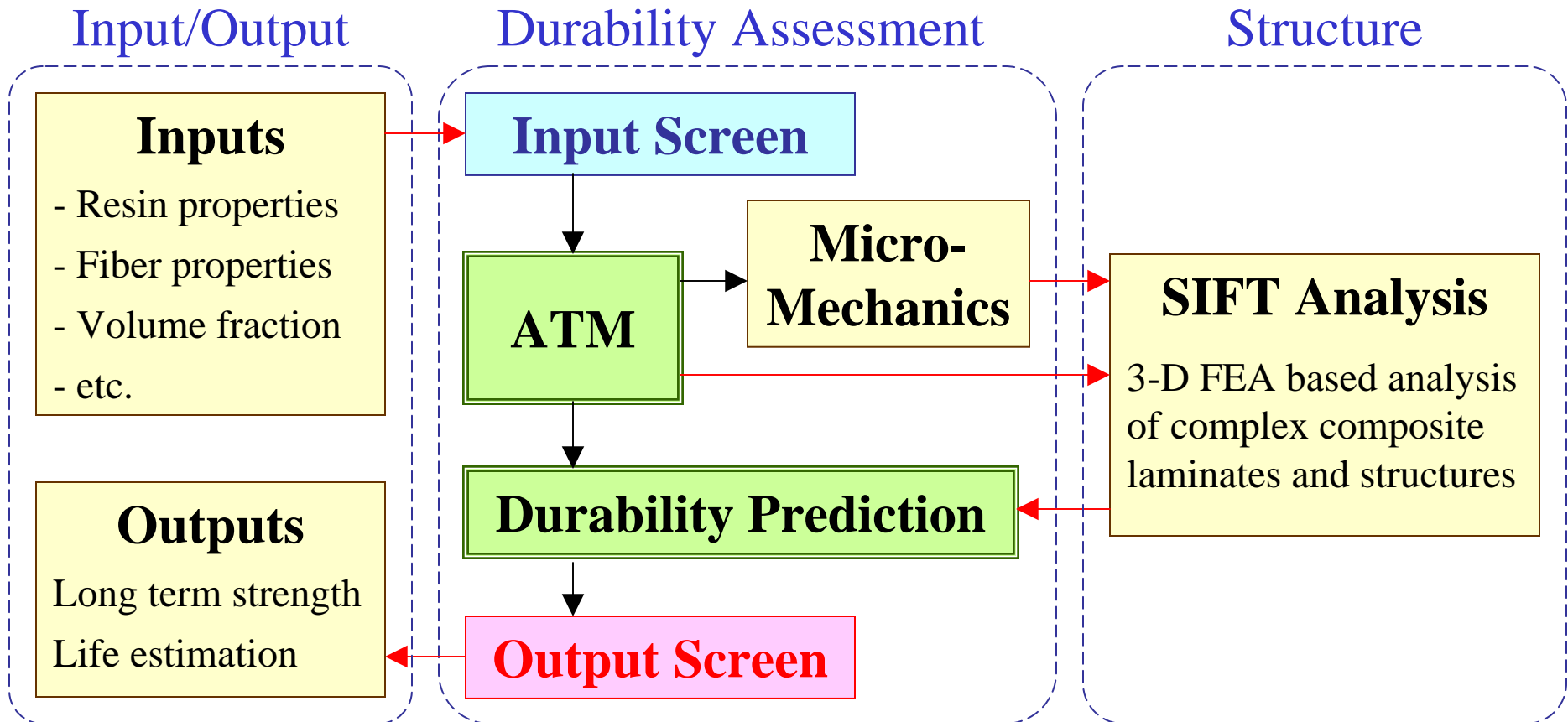



Verification Process



Evaluation of NASA HSR Data

- Mainly residual modulus and strength after thermal and mechanical load cycles
- IM7/5250-4 and IM7/K3B

IM7/K3B quasi-isotropic laminates after 3 types of thermal and mechanical load cycles (Gates, 2003)

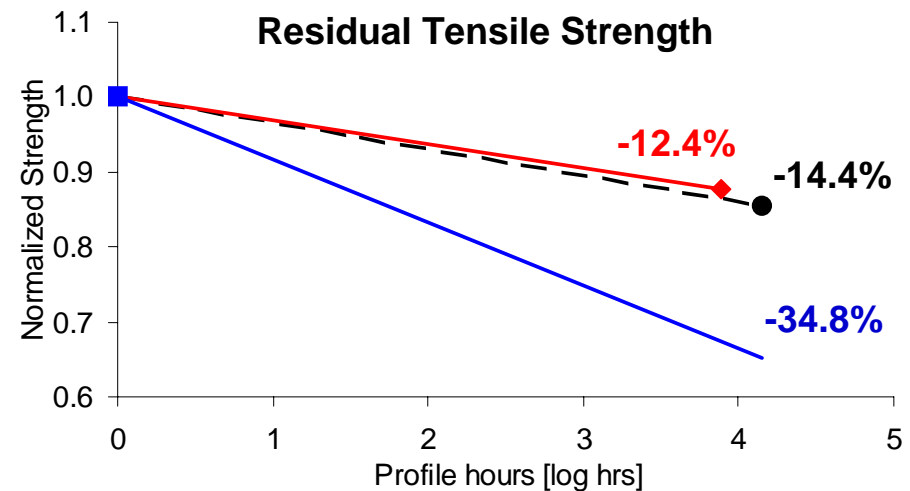
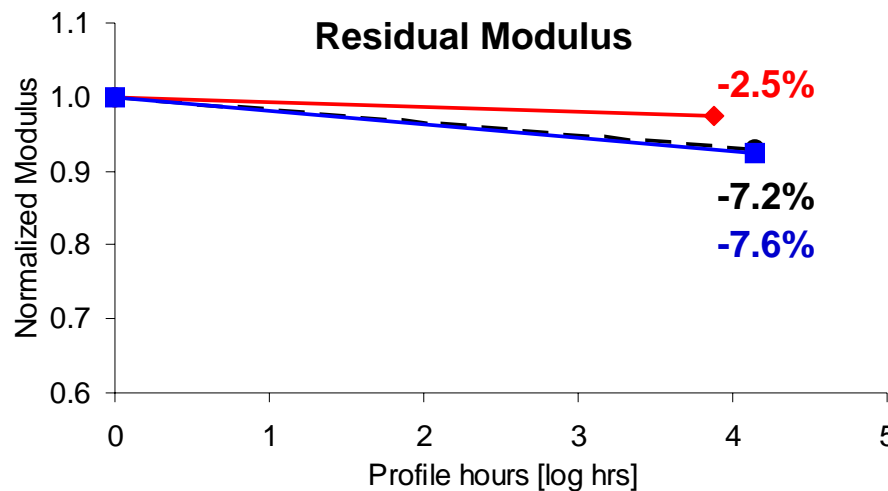
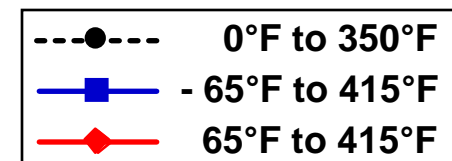

Use for the verification of the durability assessment methodology



Contents



- 1. Introduction**
- 2. Accelerated Durability Assessment**
- 3. Strain Invariant Failure Theory**
- 4. Micromechanics Analysis**
- 5. Accelerated Testing Methodology**
- 6. Analysis Results**
- 7. Conclusions**



Strain Invariant Failure Theory (SIFT)

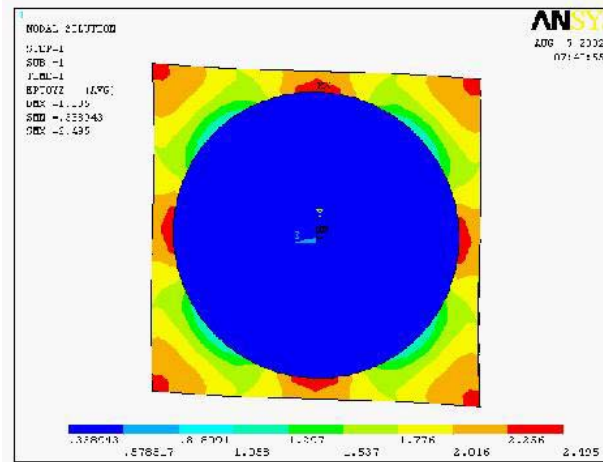
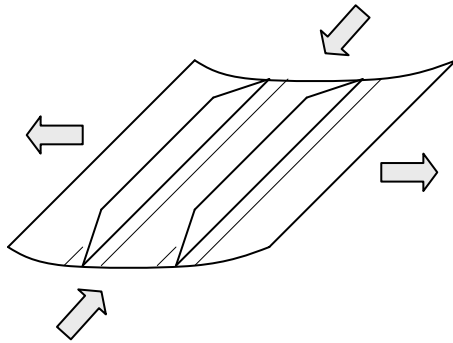

dilatational

$$J_1 = \epsilon_1 + \epsilon_2 + \epsilon_3$$

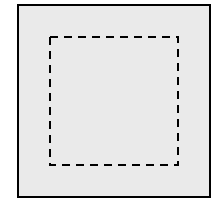

distortional

$$\epsilon_{vM} = [\{ (\epsilon_2 - \epsilon_3)^2 + (\epsilon_1 - \epsilon_3)^2 + (\epsilon_1 - \epsilon_2)^2 \} / 2]^{1/2}$$

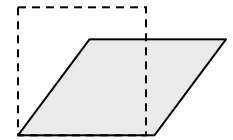

3-D macro strains
due to mechanical
and thermal loads

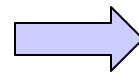

3-D micro strains
at various locations
in the fiber and resin

+

Micro thermal strains
due to CTE mismatch
of fiber and resin

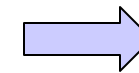

Strain invariants
in the resin
and in the fiber

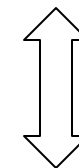
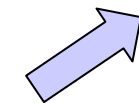

compare

Critical invariants



Final Failure Prediction Using MER



Maximum Energy Retention (MER) monitors retained and dispersed strain energies during the progressive damage to predict the final failure (2002, Gosse)

Schematic of MER used in the Stanford software

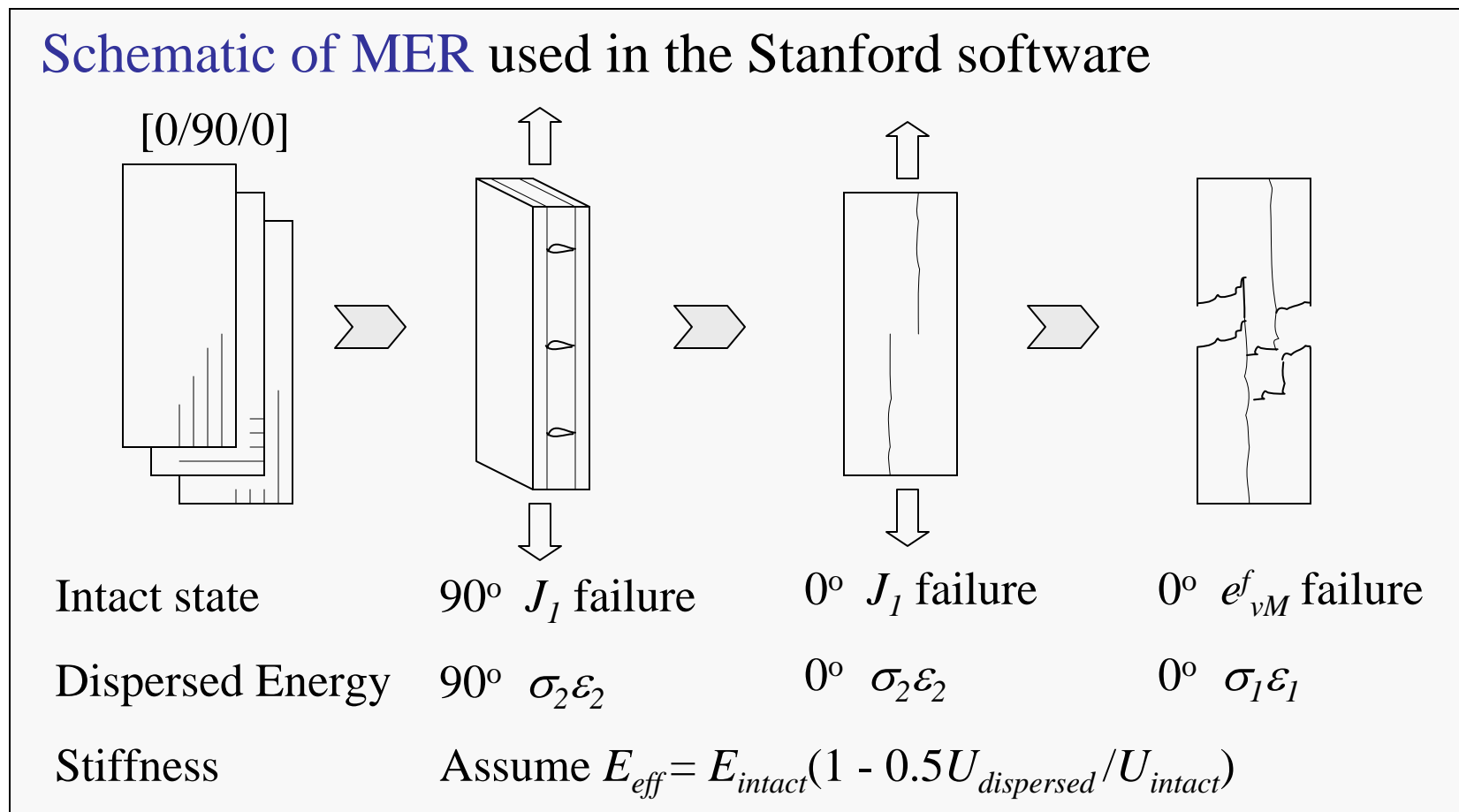



Examples of Failure Envelopes

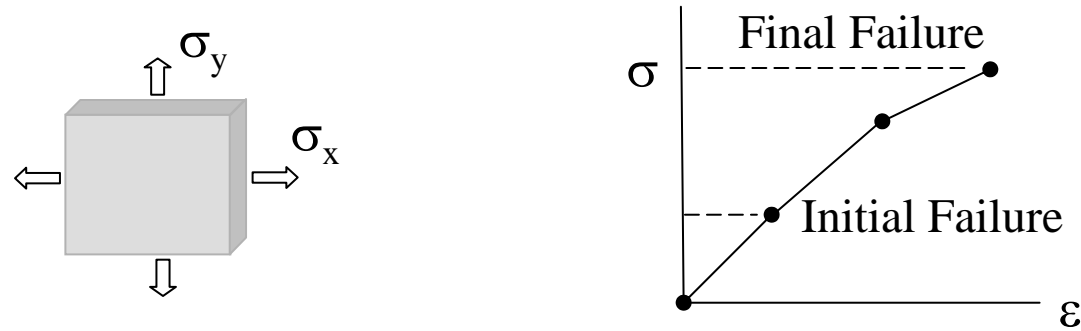

AS4/3501-6 [0/90/45/-45] Bi-axial Failure Envelope

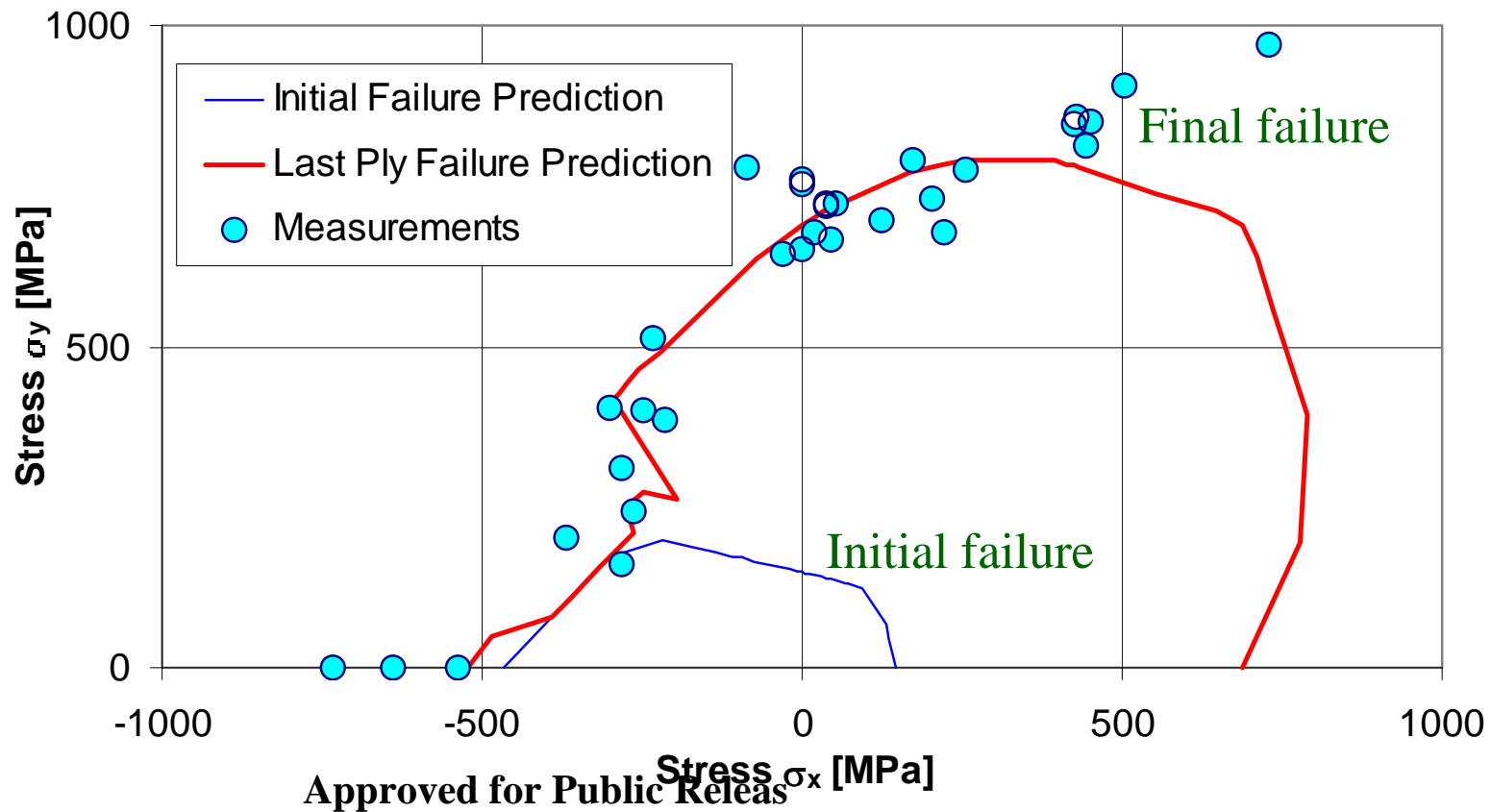



Contents



- 1. Introduction**
- 2. Accelerated Durability Assessment**
- 3. Strain Invariant Failure Theory**
- 4. Micromechanics Analysis**
- 5. Accelerated Testing Methodology**
- 6. Analysis Results**
- 7. Conclusions**



Micromechanics Finite Element Models



Cross-sectional view of continuous fiber composites

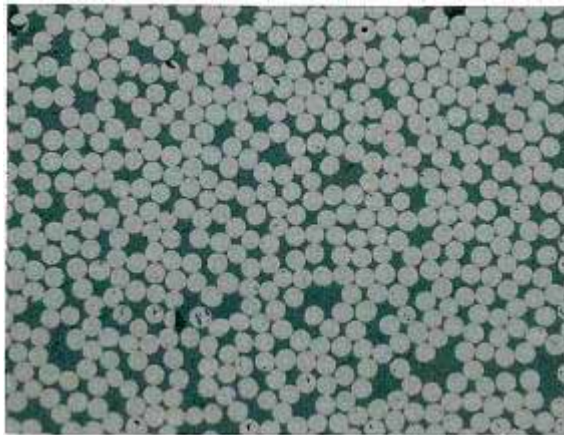

Square Array Model

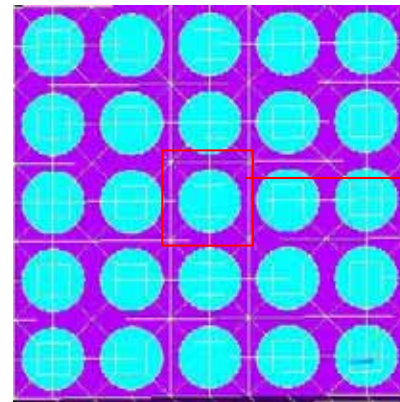

Unit Cells

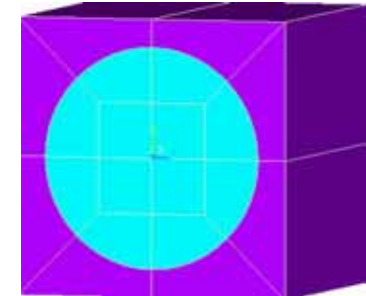

Hexagonal Array Model

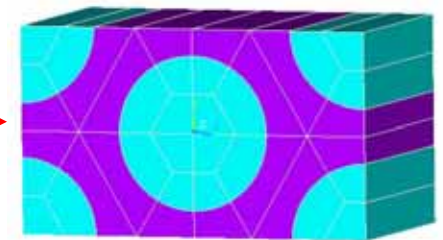
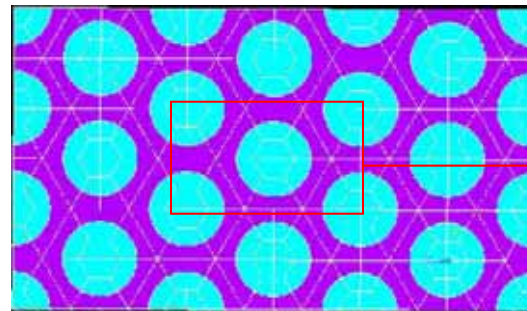

Predicts 3-D ply properties and strain magnification factors as functions of V_f , E_f , and E_m .

Approved for Public Release, Distribution Unlimited



Evaluation of Random Fiber Array

Finite element model (Ha, 2003)

* $V_f = 0.60$

* Number of fibers = 120

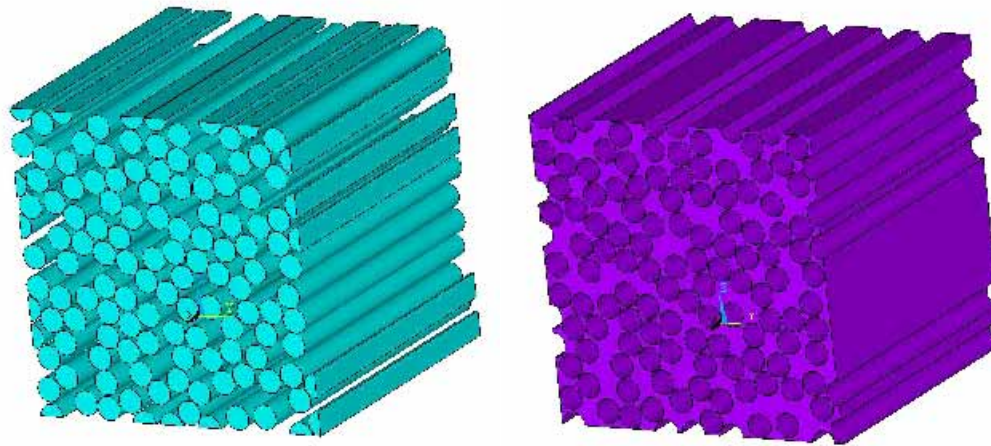

Magnification

Modulus

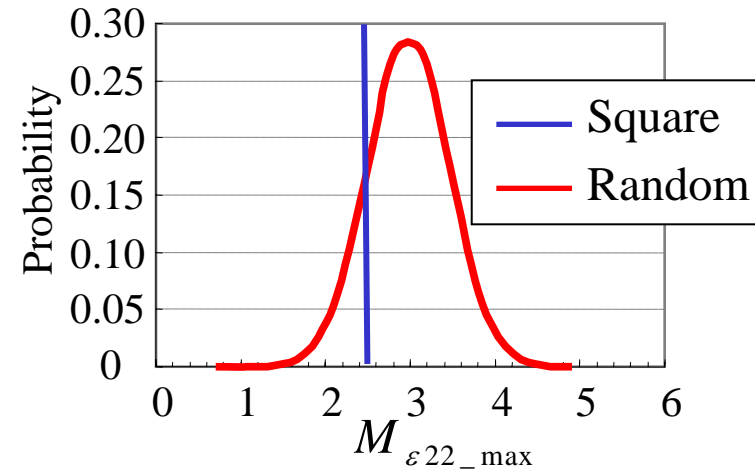
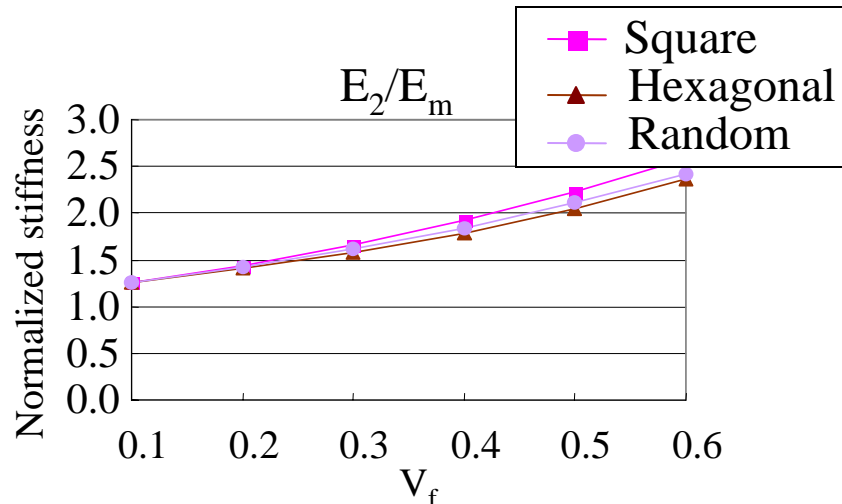

Identical to idealized array

Distribution of microscopic failures



Contents



- 1. Introduction**
- 2. Accelerated Durability Assessment**
- 3. Strain Invariant Failure Theory**
- 4. Micromechanics Analysis**
- 5. Accelerated Testing Methodology**
- 6. Analysis Results**
- 7. Conclusions**



Accelerated Testing Methodology



Series of tests at elevated temperature

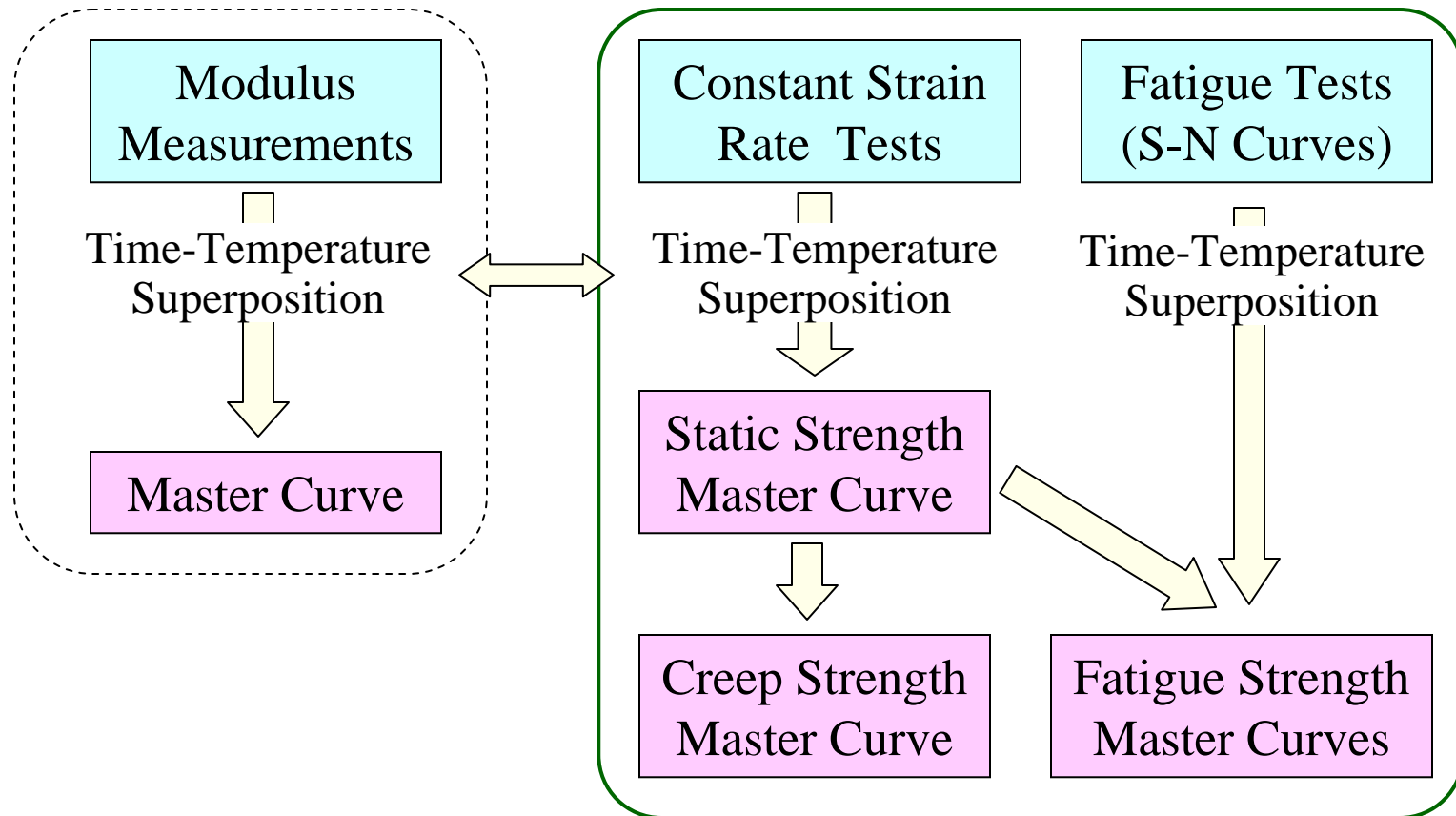

Predictions for wide ranges of temperature and time to failure



Time-Temperature Superposition (TTSP)



Assumption: Same shape for any temperature = Master Curve

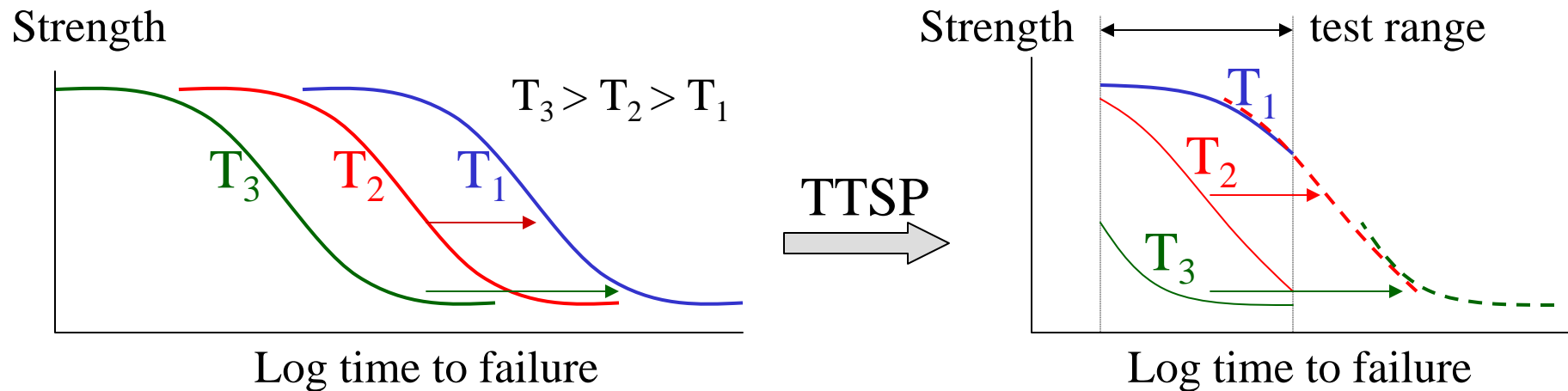

Curves can be superposed by horizontal shifts

⇒ **Master curve** can be generated from the fragments of curves at different temperatures

⇒ **Accelerated evaluation of long term performance**

Shift factors

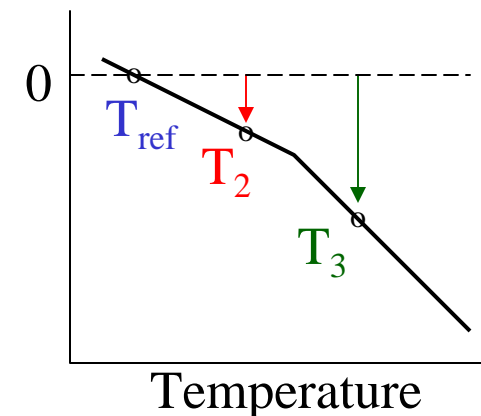



Time-Temperature Shift Factors

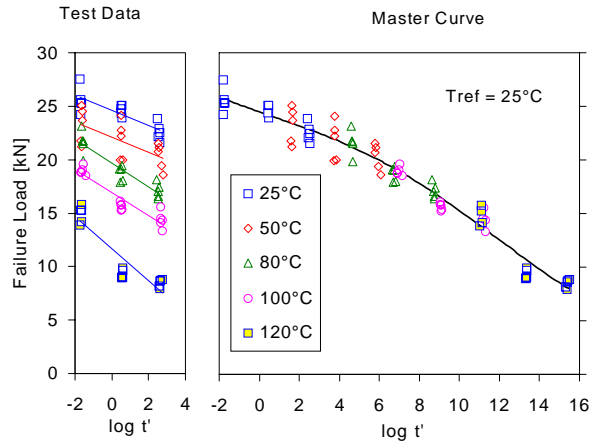

CFRP Bolted Joint Strength

- CFRP Bolted Joint Strength
- Creep Compliance of CFRP
- △ Creep Compliance of Resin
- × Storage Modulus of Resin

Temperature [°C]

0 50 100 150

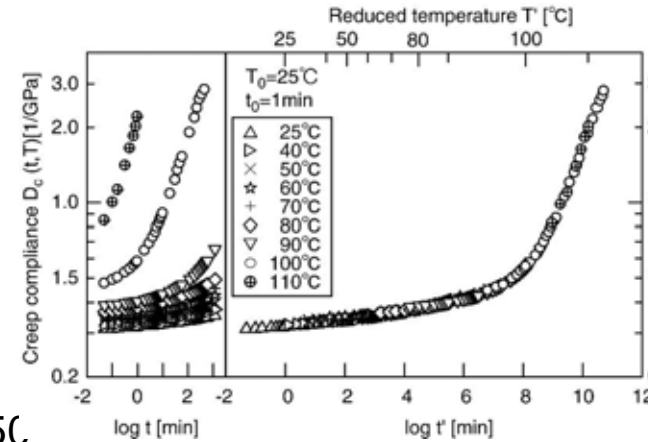

Creep Compliance of Resin

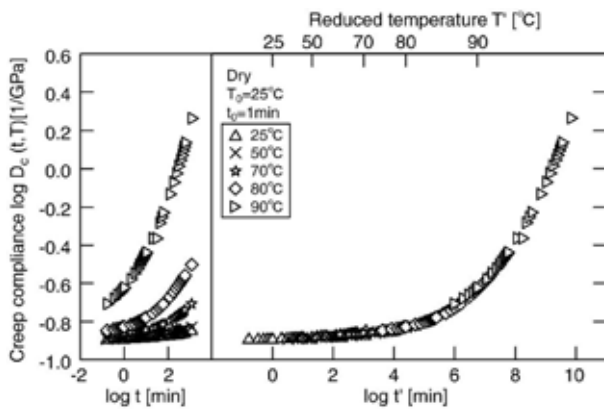

Creep Compliance of CFRP

Shift Factors

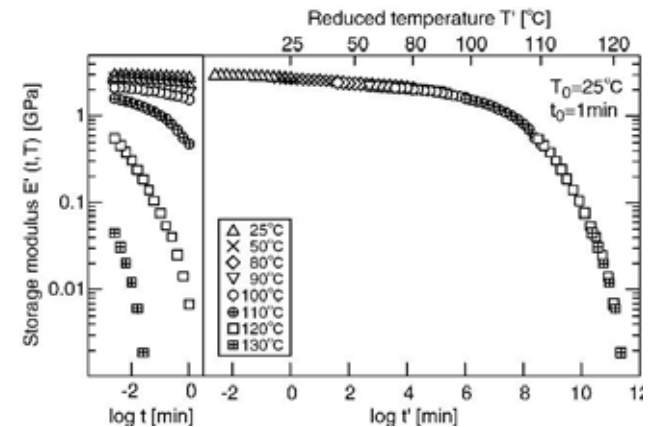
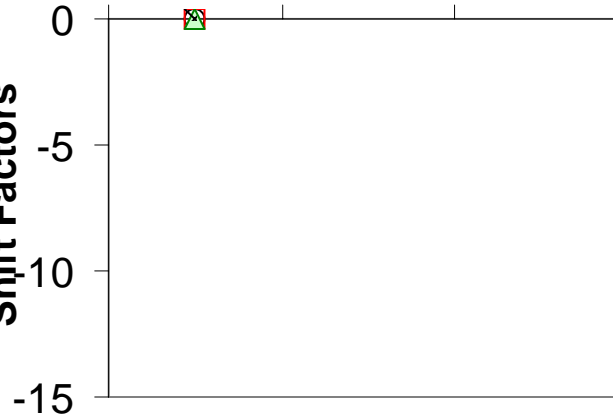

Storage Modulus of Resin

Same shift factors for various cases with common resin system



Creep Life Prediction

Linear Cumulative Damage Law (LCD) relates static and creep failures

Static loading

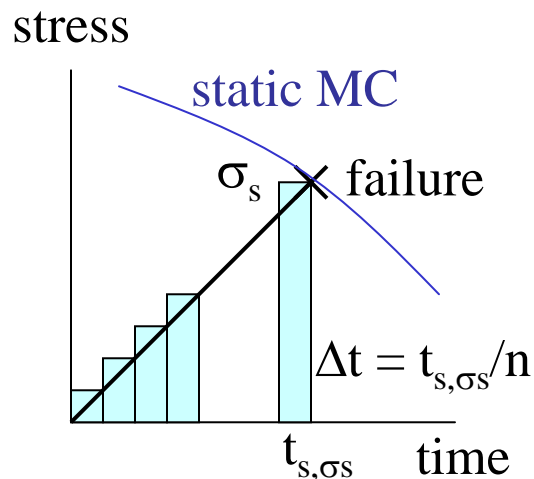

Creep loading

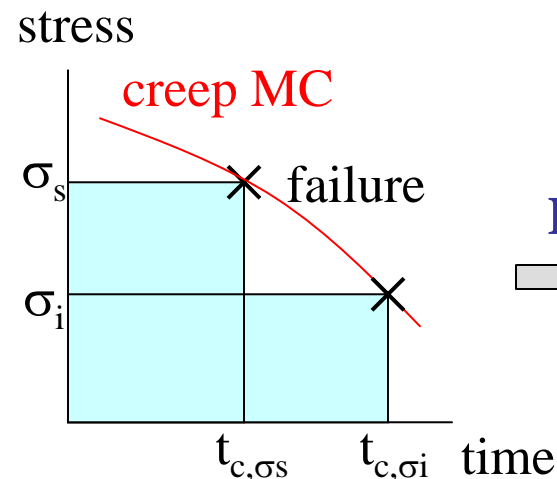

LCD
→

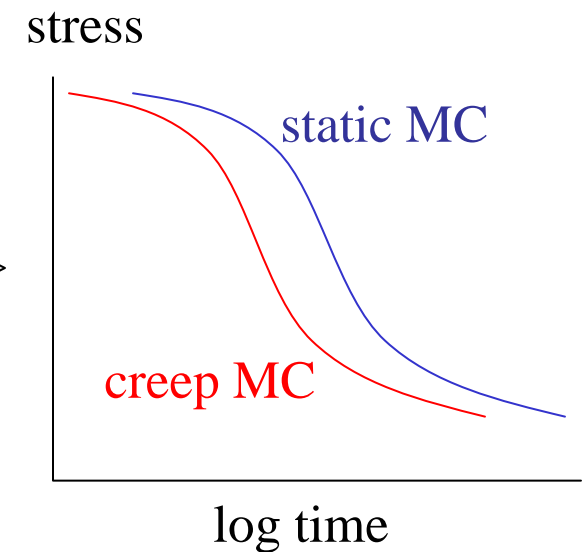

Static (constant strain rate) loading considered as series of creep loads with increasing stress level.

Using LCD,

$$\frac{\Delta t}{t_{c, \sigma_1}} + \frac{\Delta t}{t_{c, \sigma_2}} + \frac{\Delta t}{t_{c, \sigma_3}} + \frac{\Delta t}{t_{c, \sigma_4}} + \dots = 1 \Rightarrow t_{c, \sigma} = f(t_{s, \sigma})$$



Creep Life Predictions and Measurements



CFRP Bolted Joint Tensile
Creep Test (Miyano)

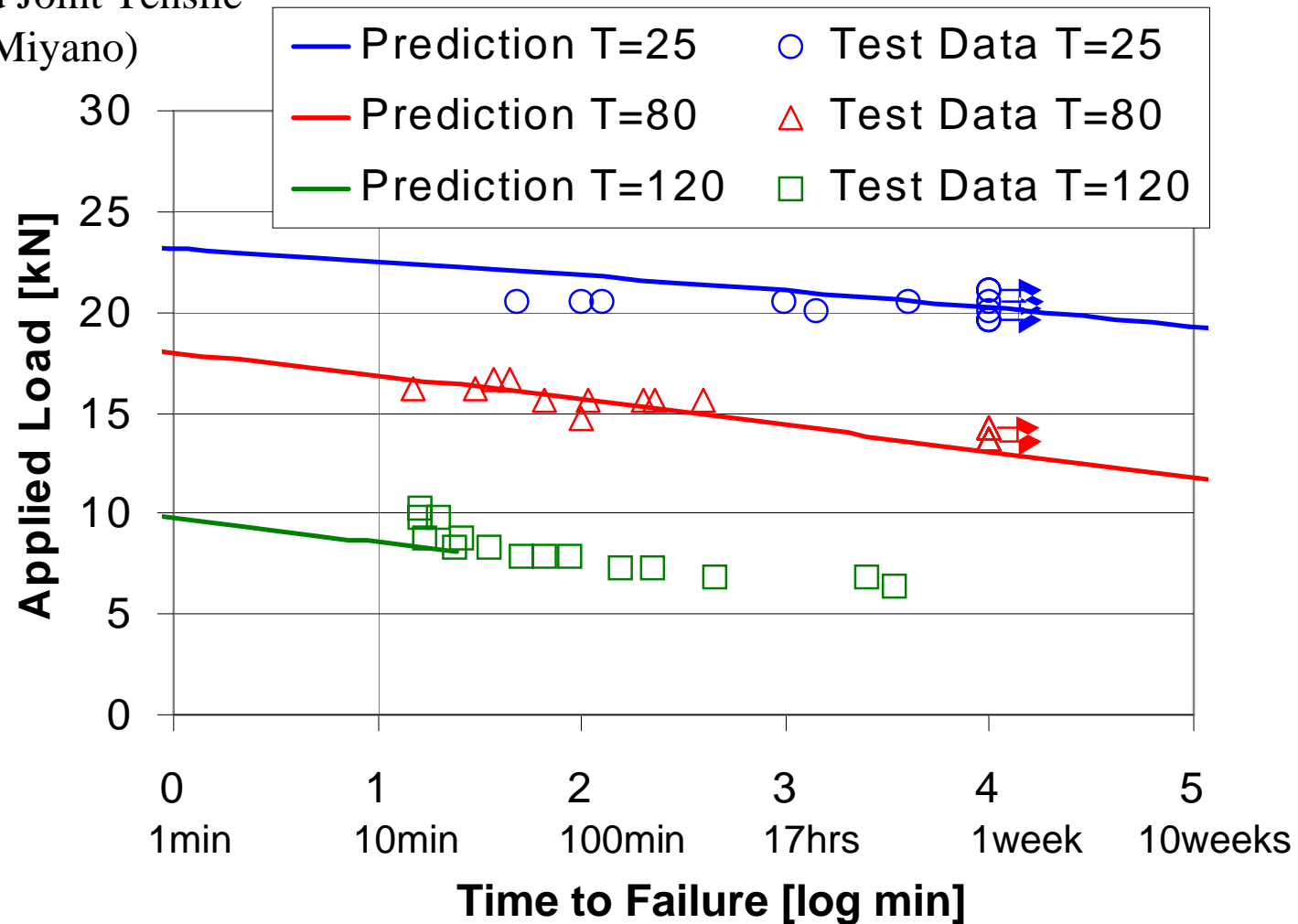

Creep life predictions agree with the creep test measurements

Approved for Public Release, Distribution Unlimited



Fatigue / Creep Life Prediction

Creep and fatigue are related when rate dependence is considered

This allows

- Linear interpolation for arbitrary stress ratio ($R = \sigma_{min} / \sigma_{max}$)
- Life prediction for combination of creep and fatigue loads using LCD

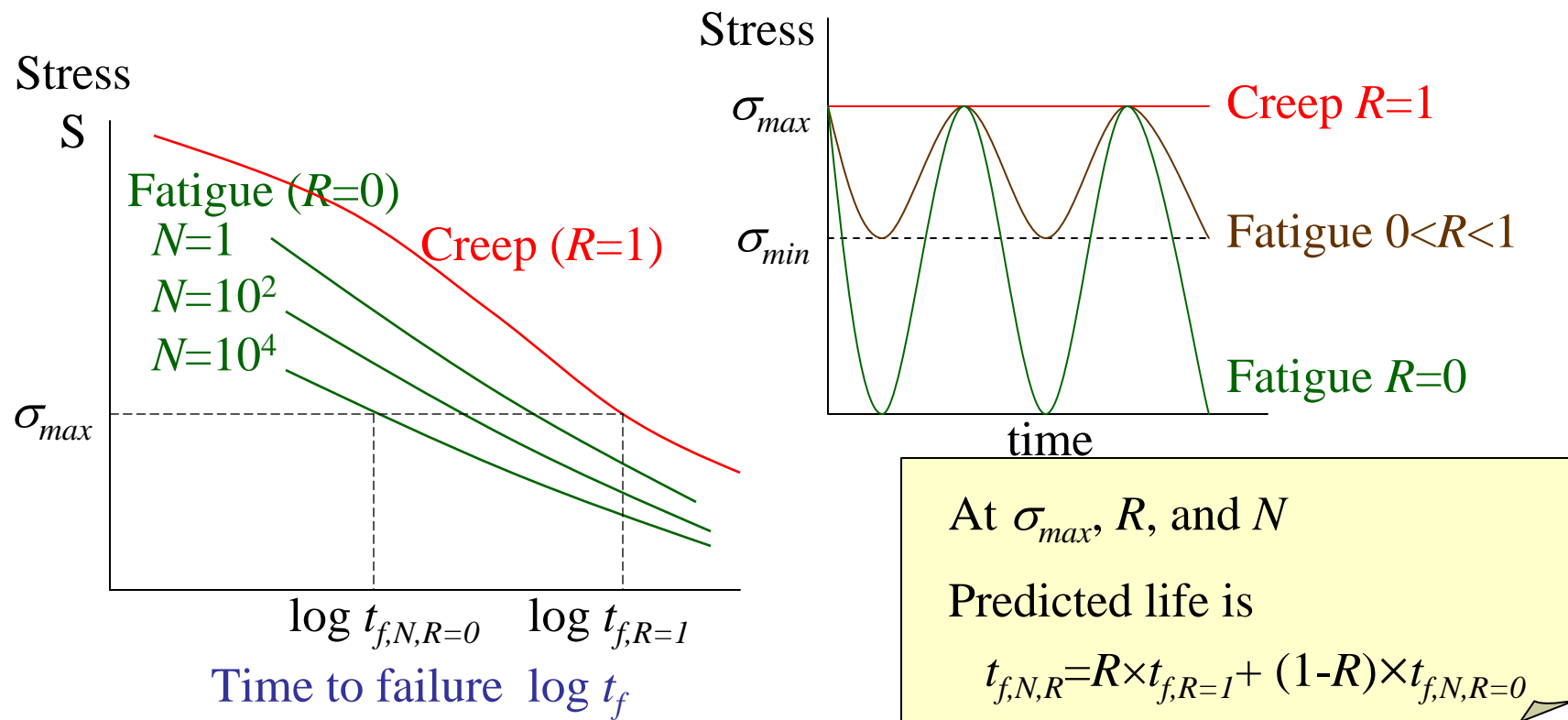



Prediction based on Master Curves

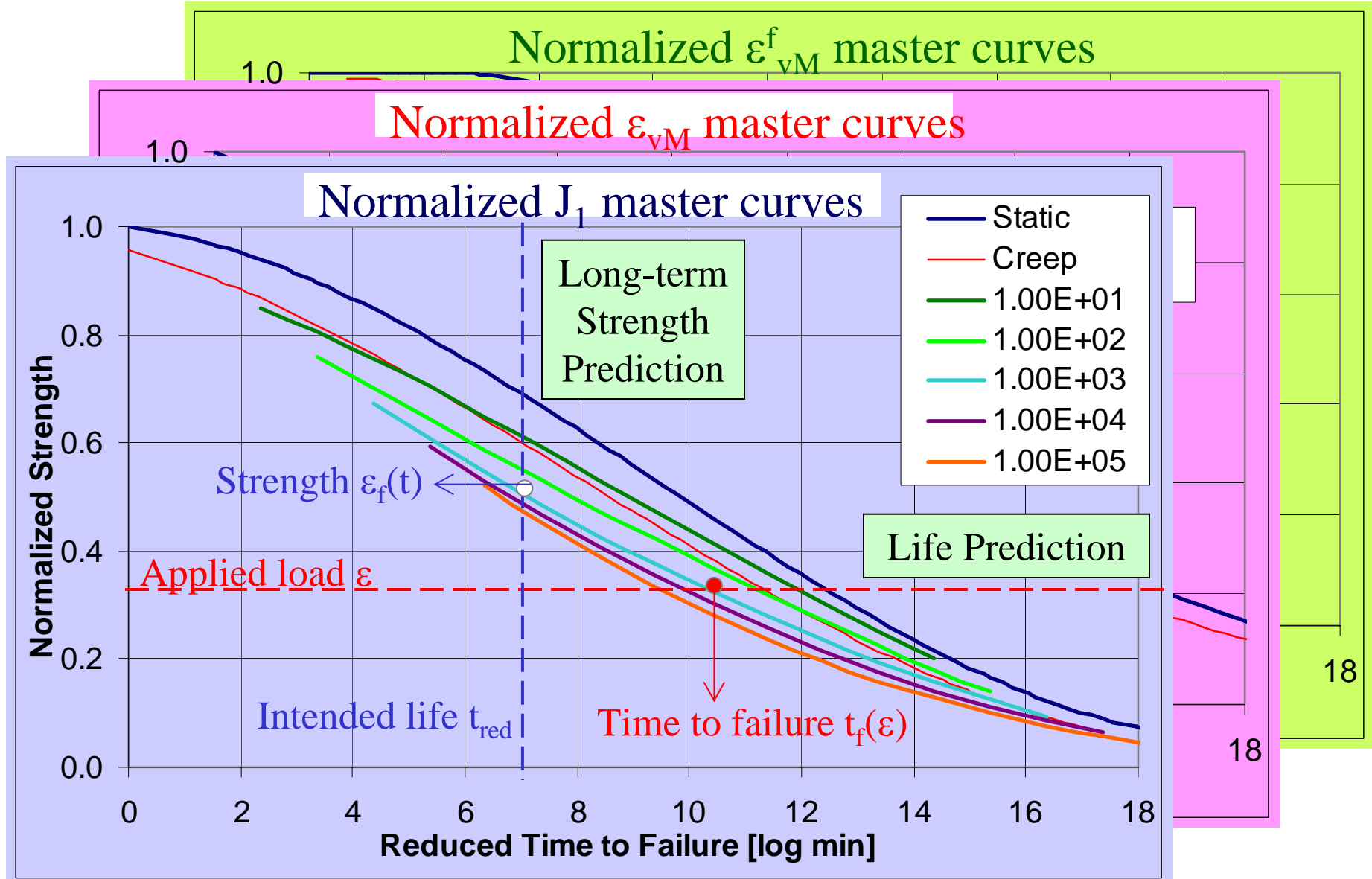

Approved for Public Release, Distribution Unlimited



Fatigue / Creep Combined Load

Linear Cumulative Damage (LCD) = Miner's Rule

with respect to time

only if correct frequencies are used

$$\frac{t_1}{t_{f,1}} + \frac{t_2}{t_{f,2}} + \frac{t_3}{t_{f,3}} + \frac{t_4}{t_{f,4}} + \dots = 1$$

⇒ Require ATM

Example: Simplified flight load

Applied strain

Temperature

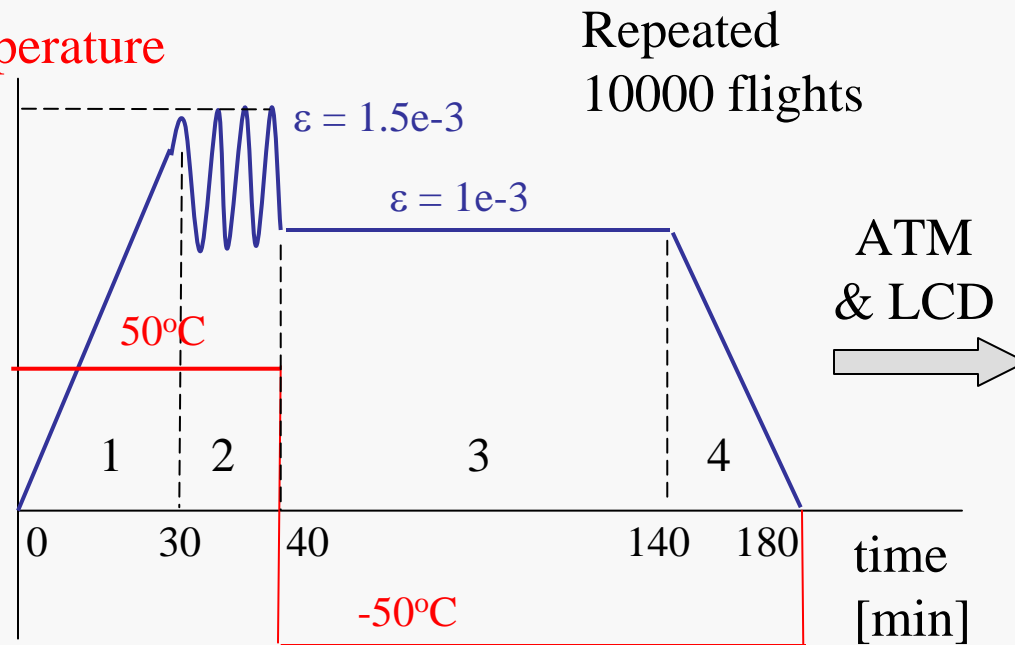

i	t _i	t _{f,i}	Δ _i
1	10 ^{5.5}	10 ^{6.4}	0.11
2	10 ^{5.0}	10 ^{5.2}	0.57
3	10 ^{6.0}	10 ²⁴	0.00
4	10 ^{5.6}	10 ²⁵	0.00
sum			0.68

$$\text{Life} = 1 / 0.68 = 1.5$$



Residual Strength Prediction

Linear Cumulative Damage (LCD)

$$\frac{t_1}{t_{f,1}} + \frac{t_2}{t_{f,2}} + \frac{t_3}{t_{f,3}} + \dots = 1$$

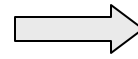

After a damage of λ

$$\lambda + \frac{t_1}{t_{f,1}} + \frac{t_2}{t_{f,2}} + \frac{t_3}{t_{f,3}} + \dots = 1$$

Residual strength at time to failure t_f = CSR strength at $t_f/(1-\lambda)$

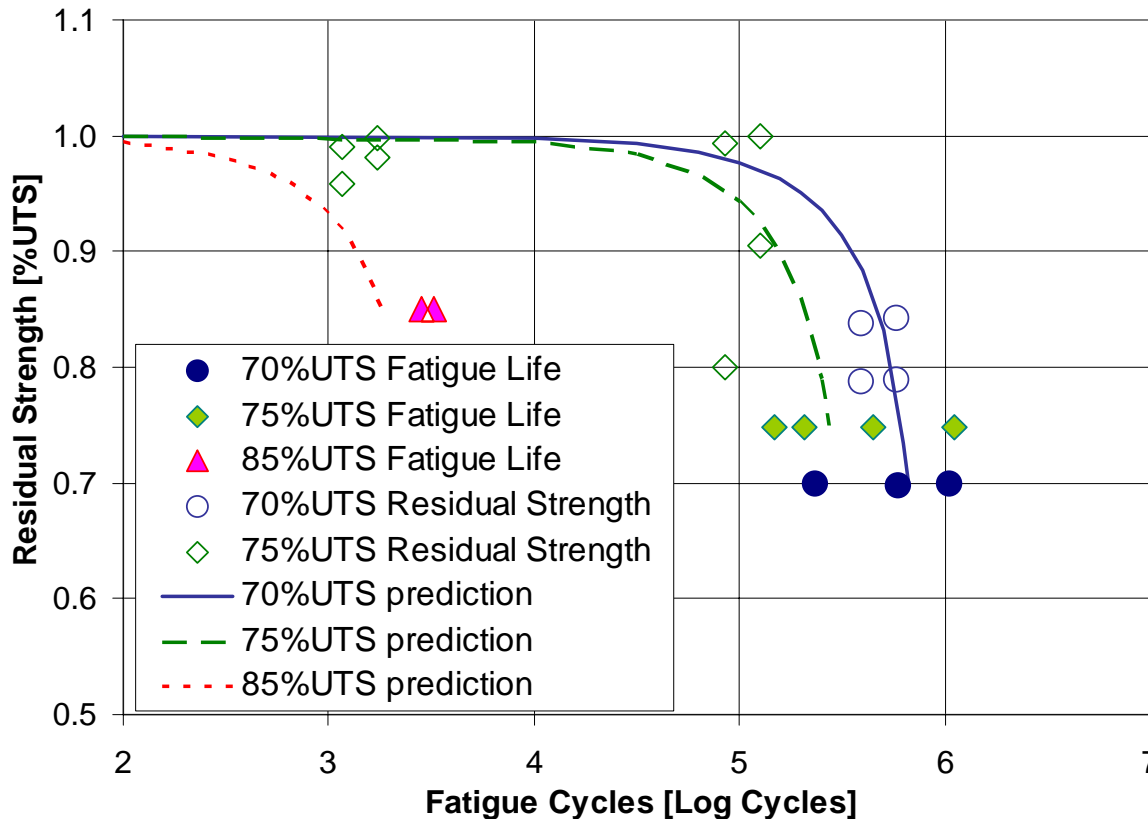

Residual strength of graphite/epoxy laminate (test data from Verghese et al, 2001)



Effects of Moisture

Reversible effects

- reduced modulus
- reduced strength
- lower T_g
- swelling of the resin

Temperature-Moisture Superposition

(2002, Miyano and Sekine)

$$T_{eff} = T + a_M M, \text{ where } a_M = \text{Moisture shift factor}$$

Irreversible effects

- fiber/matrix interface failure
- ...

Micromechanics analysis
of interface failure

CFRP [0] flexural strength
(Miyano, 2001)

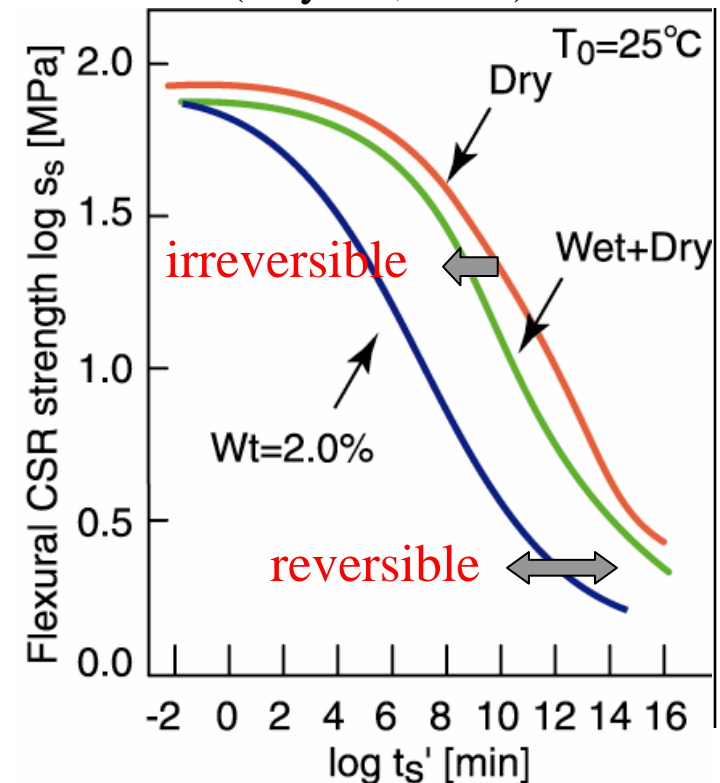



Load Independent Degradation



Separate the long-term degradation to

Load-dependent degradation

- Creep/fatigue failures
- Due to applied or hygro-thermally induced stress

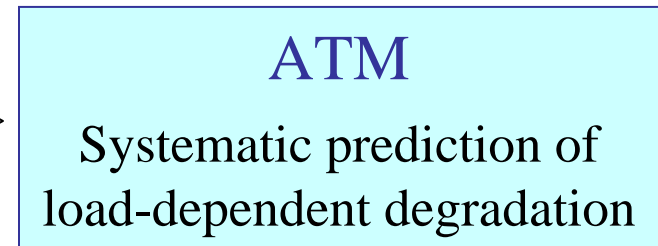
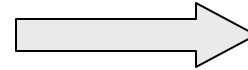

Load-independent degradation

- Assume no effect of applied loads
- Chemical degradation due to oxidization, UV, etc.

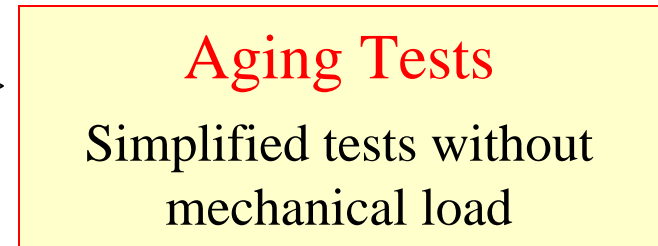
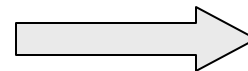

Master curves from ATM

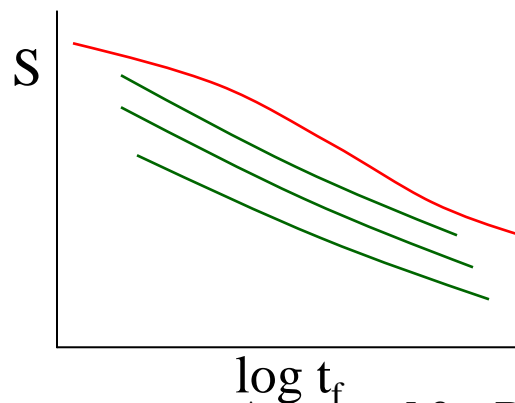

Degradation factors from aging tests
(Thermal stability models by Boeing)

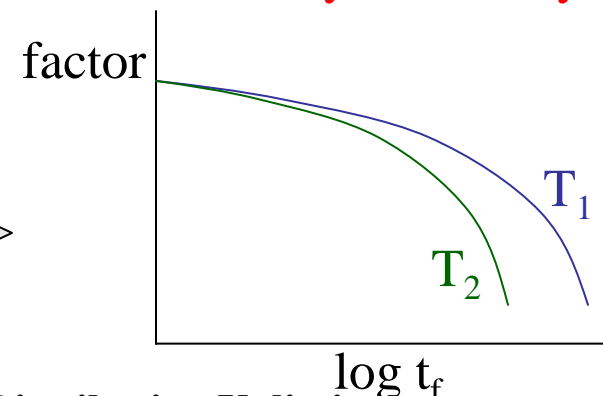

Approved for Public Release, Distribution Unlimited



Contents



- 1. Introduction**
- 2. Accelerated Durability Assessment**
- 3. Strain Invariant Failure Theory**
- 4. Micromechanics Analysis**
- 5. Accelerated Testing Methodology**
- 6. Analysis Results**
- 7. Conclusions**



Conventional Carpet Plot

Applied load
 $N_1 = 1 \text{ MPa-m}$
 $N_2 = 0 \text{ MPa-m}$
 $N_6 = 0 \text{ MPa-m}$

Last ply failure stress for various laminates

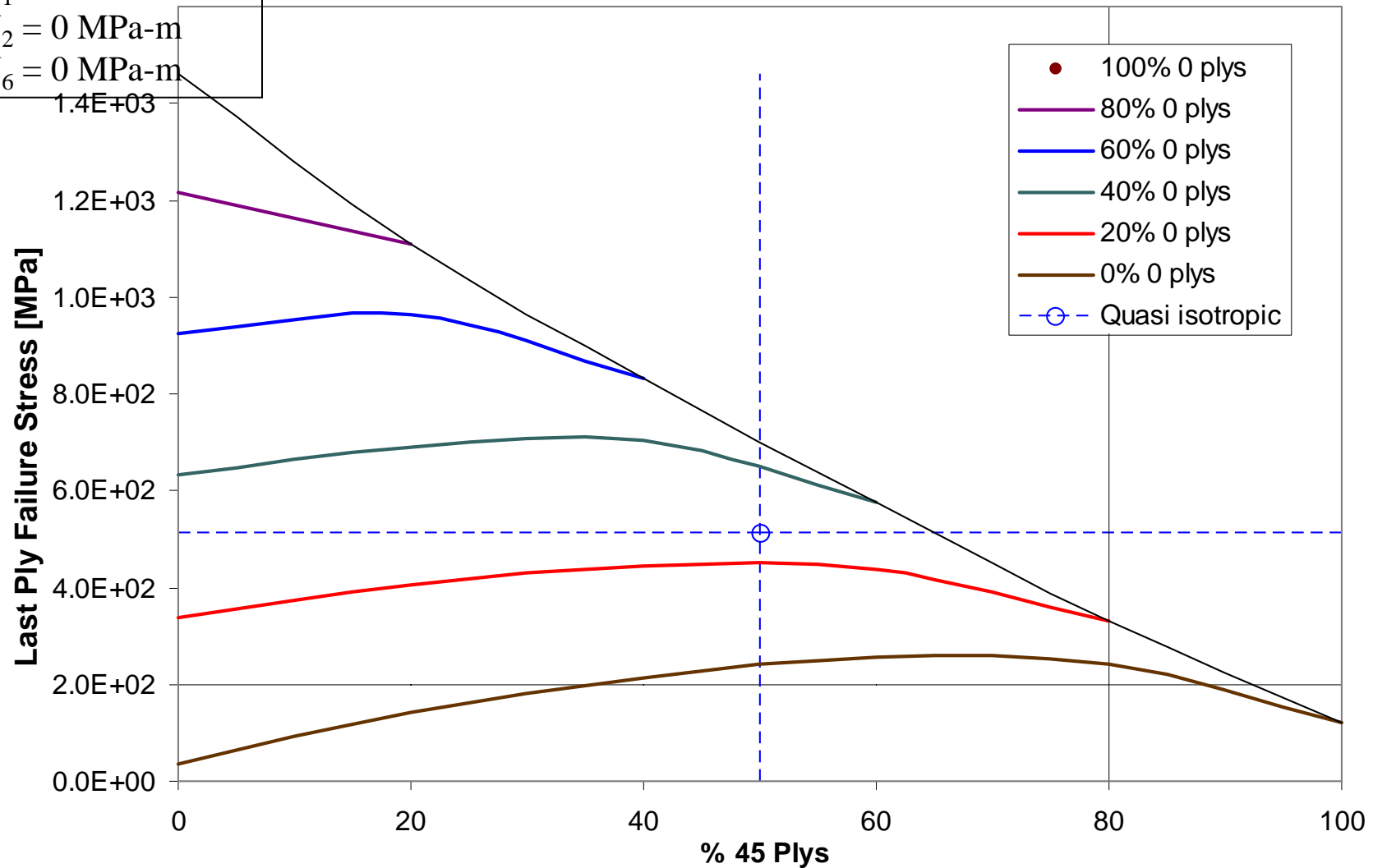



Electronic Carpet Plot Output

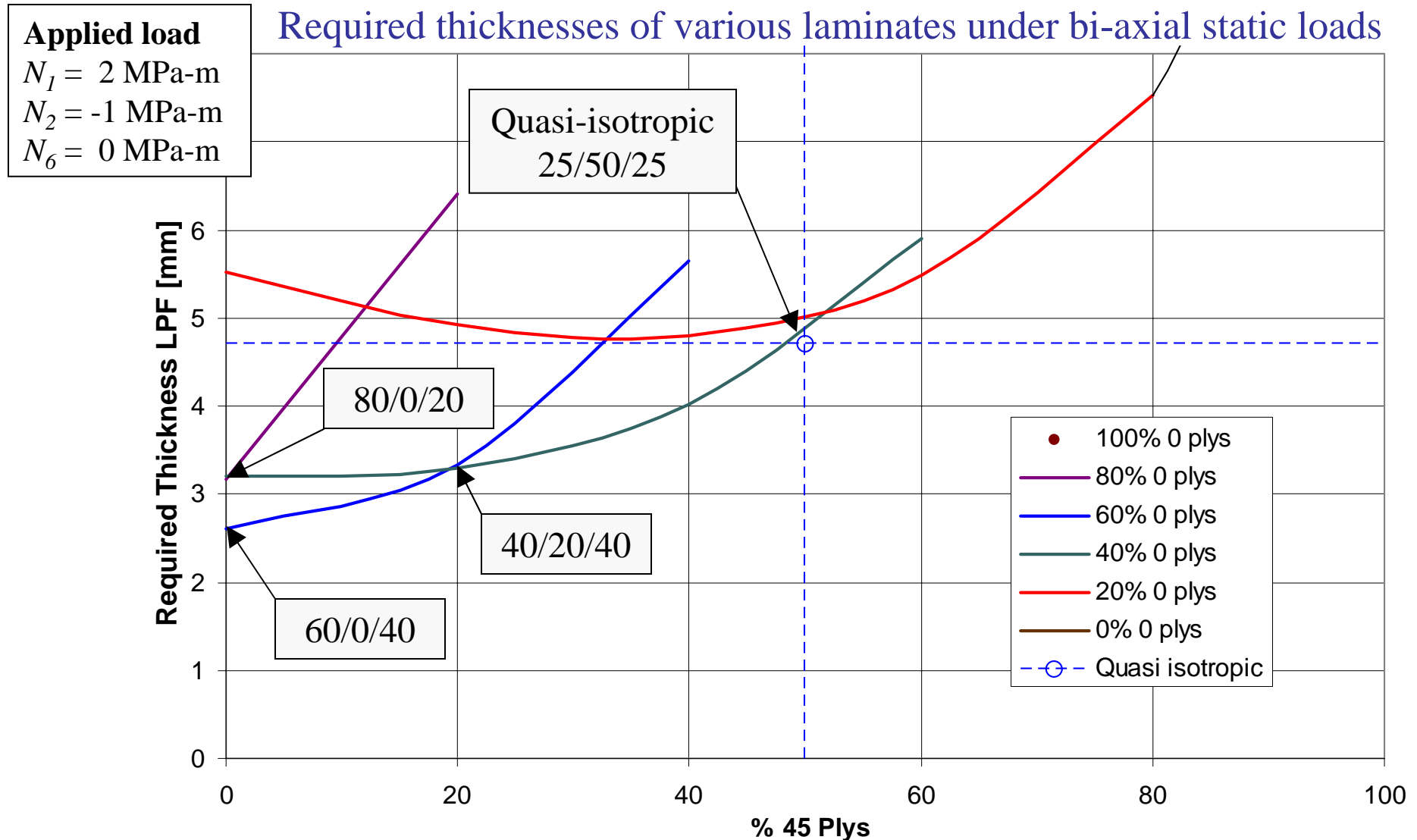

Up to 50% reduction in required thickness using wide ranges of ply orientations



Electronic Carpet Plot – Multiple Loads



Required thicknesses of various laminates under multiple fatigue/creep loads

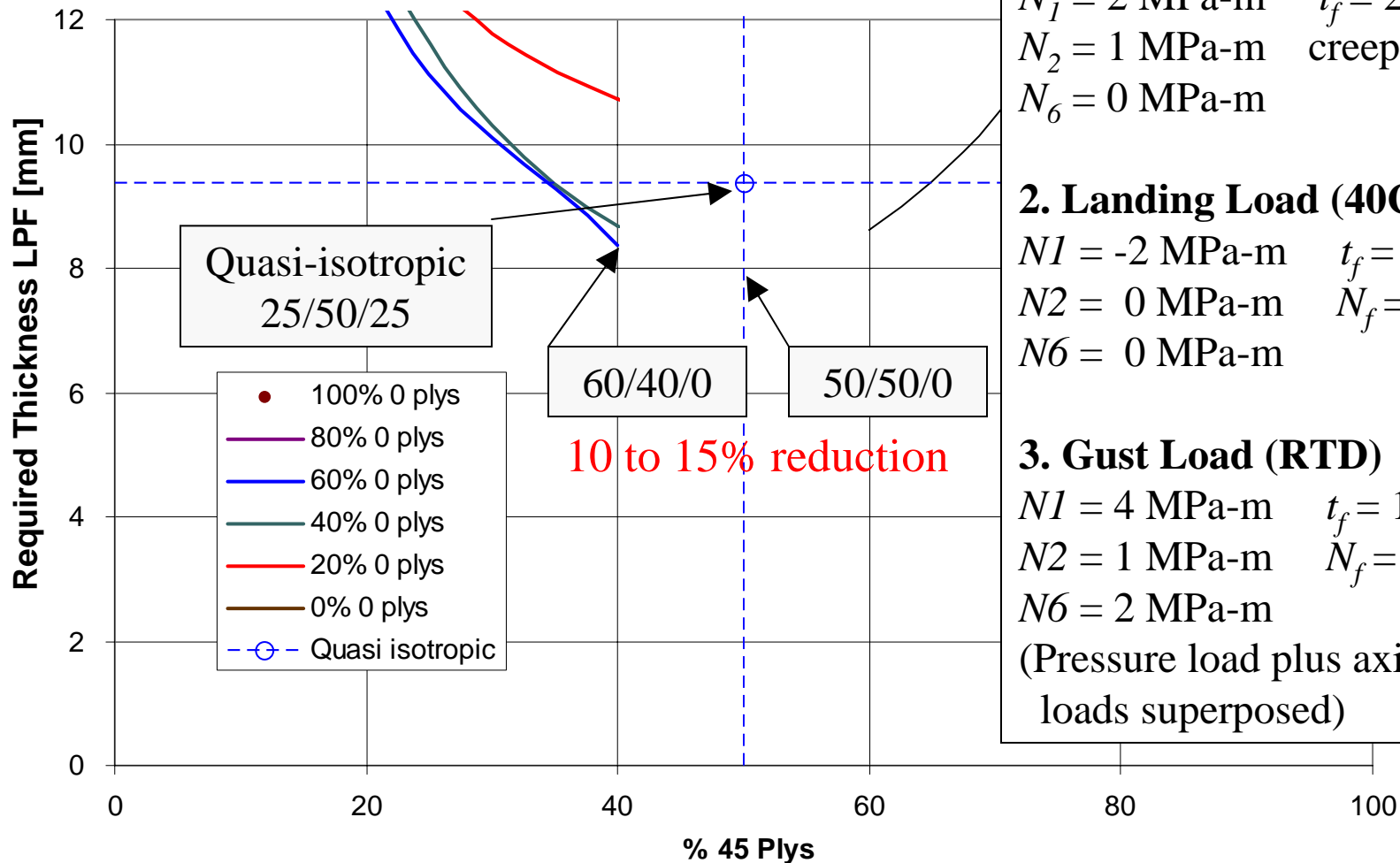

1. Pressure Load (RTD)

$N_1 = 2$ MPa-m $t_f = 20$ years
 $N_2 = 1$ MPa-m creep load
 $N_6 = 0$ MPa-m

2. Landing Load (40C, 0.5%)

$N1 = -2$ MPa-m $t_f = 50000$ min
 $N2 = 0$ MPa-m $N_f = 50000$ cycles
 $N6 = 0$ MPa-m

3. Gust Load (RTD)

$N1 = 4$ MPa-m $t_f = 100$ min
 $N2 = 1$ MPa-m $N_f = 100$ cycles
 $N6 = 2$ MPa-m
(Pressure load plus axial and shear loads superposed)

Optimum layup for multiple loads are not obvious

Approved for Public Release, Distribution Unlimited



Parameter Study



Initial and final fatigue strength ratios of quasi-isotropic laminate for RTD (room temperature dry) to HTW (hot wet) conditions

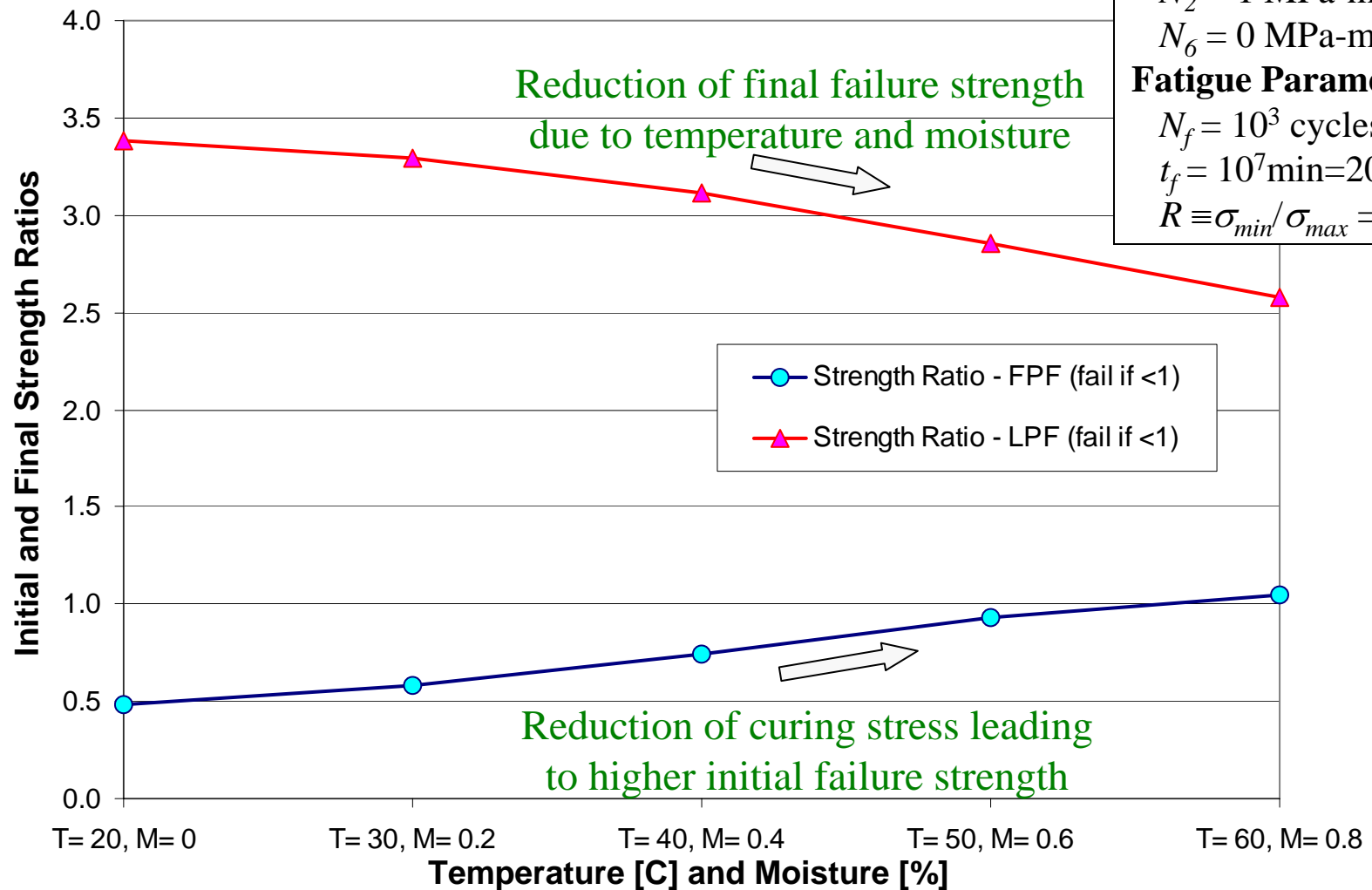

Applied load
 $N_1 = 2 \text{ MPa-m}$
 $N_2 = 1 \text{ MPa-m}$
 $N_6 = 0 \text{ MPa-m}$
Fatigue Parameters
 $N_f = 10^3 \text{ cycles}$
 $t_f = 10^7 \text{ min} = 20 \text{ years}$
 $R \equiv \sigma_{min} / \sigma_{max} = 0$



Conclusions



Accelerated Testing Methodology (ATM) allows rapid generation of durability database as master curves.

Strain Invariant Failure Theory (SIFT) relates basic material durability database to the durability of composite laminates and structures

ATM/SIFT combination provides framework for evaluating the effects of various parameters associated with material selection, processing, design, loads, and environmental conditions.



Acknowledgements

AIM-C Program

This effort was jointly accomplished by the Boeing led team and the United States Government under the guidance of NAST. This work was funded by DARPA/DSO and administered by NAST under Technology Investment Agreement N00421-01-3-0098. We acknowledge the guidance and support of **Dr. Steve Wax and Dr. Leo Christodoulou** of DARPA/DSO for this effort. The technical monitor for the program is **Dr. Ray Meilunas** of NAVAIR. We also acknowledge Boeing leadership in AIM-C and especially the Durability Task: **Gail Hahn, Karl Nelson, and Charles Saff** of Boeing

Durability Analysis Research

- Prof. Stephen W. Tsai and Prof. Richard M. Christensen of Stanford University
- Prof. Yasushi Miyano of Kanazawa Institute of Technology
- Prof. Sung Kyu Ha of Hanyang University