

BLAST INJURY

Translating Research into Operational Medicine

James H. Stuhmiller, PhD

Edited by:

William R. Santee, PhD

COL Karl E. Friedl, PhD



United States Army Medical Research and Materiel Command
Fort Detrick, Maryland



Report Documentation Page

Form Approved
OMB No. 0704-0188

Public reporting burden for the collection of information is estimated to average 1 hour per response, including the time for reviewing instructions, searching existing data sources, gathering and maintaining the data needed, and completing and reviewing the collection of information. Send comments regarding this burden estimate or any other aspect of this collection of information, including suggestions for reducing this burden, to Washington Headquarters Services, Directorate for Information Operations and Reports, 1215 Jefferson Davis Highway, Suite 1204, Arlington VA 22202-4302. Respondents should be aware that notwithstanding any other provision of law, no person shall be subject to a penalty for failing to comply with a collection of information if it does not display a currently valid OMB control number.

1. REPORT DATE 20 MAY 2008		2. REPORT TYPE		3. DATES COVERED 00-00-2008 to 00-00-2008	
4. TITLE AND SUBTITLE Blast Injury: Translating Research Into Operational Medicine				5a. CONTRACT NUMBER	
				5b. GRANT NUMBER	
				5c. PROGRAM ELEMENT NUMBER	
6. AUTHOR(S)				5d. PROJECT NUMBER	
				5e. TASK NUMBER	
				5f. WORK UNIT NUMBER	
7. PERFORMING ORGANIZATION NAME(S) AND ADDRESS(ES) Department of Defense, Washington, DC				8. PERFORMING ORGANIZATION REPORT NUMBER	
9. SPONSORING/MONITORING AGENCY NAME(S) AND ADDRESS(ES)				10. SPONSOR/MONITOR'S ACRONYM(S)	
				11. SPONSOR/MONITOR'S REPORT NUMBER(S)	
12. DISTRIBUTION/AVAILABILITY STATEMENT Approved for public release; distribution unlimited					
13. SUPPLEMENTARY NOTES					
14. ABSTRACT					
15. SUBJECT TERMS					
16. SECURITY CLASSIFICATION OF:			17. LIMITATION OF ABSTRACT	18. NUMBER OF PAGES	19a. NAME OF RESPONSIBLE PERSON
a. REPORT unclassified	b. ABSTRACT unclassified	c. THIS PAGE unclassified			



Preprint
BI-QP-JHS-CH10
Borden Institute

This chapter was originally submitted to the Borden Institute, US Army Medical Department, Office of The Surgeon General, AMEDD Center & School, for publication in *Quantitative Physiology: Problems and Concepts in Military Operational Medicine*, a book in the *Textbooks of Military Medicine* series. Because changes may be made before publication, this preprint is made available with the understanding that it will not be cited or reproduced without the permission of the publisher.

APRIL 2008

APPROVED FOR LIMITED PUBLIC RELEASE

For more than 25 years, the Military Operational Medicine Research Program (MOMRP) has been a world leader in the study of blast-related injury. This research has produced insights, data, and predictive models that set standards for human exposure, guide the design of protective systems, and allow quick responses to the questions generated in a rapidly changing battle environment. The work of MOMRP continues to address the new blast issues of the 21st century.

Introduction

This chapter describes pioneering biomedical research that forms the basis of our current knowledge of blast injury mechanisms. Much of this knowledge, learned decades ago, can be applied directly to solving the blast injury problems of today. For example, our understanding of primary blast lung injury, learned from nearly two decades of large animal blast injury research, was successfully applied to solving the current problem of protecting our warfighters from novel explosive weapons.

The primary goal of the Department of Defense (DoD) Blast Injury Research Program is to focus our energies and limited resources on biomedical research that addresses blast injury knowledge gaps. The key to achieving this goal is understanding what has already been learned about blast injury. Understanding what we know about blast injury is just as important as understanding what we don't know. As the first comprehensive review of the Army's extensive investment in developing blast injury models, this chapter helps to provide access to the extensive repository of primary blast research reports and data.

I urge everyone in the blast injury research community to read this chapter. If you require additional information, please contact the DoD Blast Injury Research Program Coordination Office at 301-619-9801.

Michael J. Leggieri, Jr.
DoD Blast Injury Research Program

Chapter 10

BLAST INJURY: TRANSLATING RESEARCH INTO OPERATIONAL MEDICINE

JAMES H. STUHMILLER, PhD*

INTRODUCTION

- Blast Injury Taxonomy
- Post-World War II Research
- Occupational Limits of Blast Exposure
- Military Operational Medicine Research Program (Blast Injury Research)

FIRST-GENERATION INJURY MODELING

- Observed Blast Injuries
- Exploratory Injury Models
- Lung Injury
- INJURY Software, Versions 1.0 to 4.3
- Simple Waves
- The Blast Test Device
- Blast in Enclosures
- Computational Fluid Dynamics

SECOND-GENERATION INJURY MODELING

- INJURY Software, Versions 5.0 to 7.1
- Replacement of the Z-line in Military Standard 1474
- Secondary Blast Injury Modeling
- Tertiary Blast Injury Modeling
- Combined Injury Modeling
- Closing of the Blast Test Site

THIRD-GENERATION INJURY MODELING

- Finite Element Modeling
- Finite Element Modeling in Blast Injury
- INJURY Software, Version 8
- Toxic Gas Inhalation
- Blast Effects Behind Body Armor

FOURTH-GENERATION INJURY MODELING

- Performance Endpoints
- Central Nervous System Injury
- Blast Traumatic Brain Injury Mechanisms
- Biomechanical and Physiological Response Models

SUMMARY

* Senior Vice President and General Manager, Simulation, Engineering, and Testing, L-3 Communications, 10770 Wateridge Circle, San Diego, California 92121

INTRODUCTION

In 1864, during the American Civil War, the 48th Pennsylvania regiment was made up primarily of men who had been coal miners in civilian life. As the siege of Petersburg, Virginia, dragged on, the idea arose to dig a tunnel under the Confederate lines. It was dug, filled with gunpowder, and the fuse lit on July 30, 1864. The initial explosion killed 280 Confederate soldiers. But, ironically, the subsequent Battle of the Crater led to casualties totaling 1,500 Confederate and 4,000 Union soldiers, not counting any who were wounded or missing.¹

In 1968, fuel-air explosives were introduced in the Vietnam War to clear densely forested areas, minefields, and enemy soldiers. The tremendous blasts from dispersed clouds of kerosene literally crushed everything below. The Russians further perfected these thermo-baric weapons and used them in Afghanistan and the Chechen Republic.

In 1979, during developmental testing of a new M198 howitzer (Rock Island Arsenal, Rock Island, Ill), firing of the most energetic rounds generated blast pressures in the crew locations, which slightly exceeded the limits of Military Standard 1474 (“Noise Limits for Military Materiel”). By regulation, soldiers could not be exposed to such intense noise, so further testing was stopped. Because the capability to fire the energetic rounds was a key element in the mission of the howitzer, fielding of a critical weapon system was effectively blocked.

On October 23, 1983, the First Battalion, 8th Marines Headquarters building in Beirut, Lebanon, was destroyed by a terrorist truck laden with compressed gas-enhanced explosives.² The resulting explosion and the collapse of the building killed 241 marines, sailors, and soldiers. Use of massive amounts of low-tech explosives to produce mass casualties has become an increasingly common tactic in modern, asymmetric warfare and in civilian terrorism.

As of October 2005, improvised explosive devices (IEDs) have accounted for one third of all American deaths in Iraq. Roadside bombs were used in World War II by Belorussian guerillas to derail Nazi trains as part of the “rail war,”³ in Northern Ireland against the British Army, in Afghanistan against the Russian Army, in Lebanon against the Israelis, and now against the United States throughout the Middle East. In 2005, the US military invested \$3.3 billion in IED countermeasures, primarily through improved armor and other technologies.⁴

As these previously described examples show, for hundreds of years, blasts from explosions have been a threat on the battlefield, a threat to civilians from acts of terrorism, and a threat to soldiers in training. For

more than 25 years, the Military Operational Medicine Research Program (MOMRP) of the US Army Medical Research and Materiel Command (USAMRMC; Fort Detrick, Md) has been a leading world research organization in the study of blast-related injury. The MOMRP program has

- conducted extensive animal tests to establish injury patterns, elucidate injury mechanisms, and provide critical data for establishing injury standards;
- developed mathematical models of physiological response in both animals and humans to extrapolate test data to situations of military relevance;
- developed injury criteria that are used throughout the military and civilian communities to estimate injury potential and set safe limits of exposure; and
- developed instrumentation to standardize the measurement of blast environments for injury assessment.

This research covers the traditional blast-effect categories:

- *primary effects*—those resulting from the crushing effects of blast overpressure,
- *secondary effects*—those resulting from the impact of debris accelerated by the blast wave and following winds, and
- *tertiary effects*—those resulting from impacts with walls and the ground caused by accelerating the body itself.

In addition, other effects have been studied—for example, incapacitation, injury, and lethality from the inhalation of gases generated by explosives and effects on sensory systems, including auditory injury. Research findings have assisted in human protection in areas other than blast, including the development of better body armor, automobile safety systems, and less injurious nonlethal weapons.

Many of the key findings of the MOMRP blast research program have been published in peer-reviewed literature. Hardware and software for the characterization and analysis of blast pressure have been widely distributed. Nonetheless, other results appear only in technical reports and are less accessible. The purpose of this publication is to provide an overview of the USAMRMC blast research program, to show how quantitative physiology has provided useful solutions to operational medicine, and to indicate future directions of research.

Blast Injury Taxonomy

The violent consequences of being near an explosion can produce a wide range of injuries that can be organized into a taxonomy (Table 10-1). The high pressures of the blast can crush the body and cause internal injury. These injuries are called primary blast injuries. Strong winds behind the blast front can hurl fragments and debris against the body and cause the same blunt trauma or penetration injuries that would occur if the material were propelled by other means. This class of injuries is called secondary injuries. The strong winds behind the blast front and the pressure gradient in the wave can exert significant forces that can accelerate the body and cause the same blunt trauma that would occur in a fall or a car crash. This class of injuries is called tertiary injuries. The extreme heat and light released by the explosion can cause burning and blindness, whereas inhaling the toxic fire gases can lead to immediate incapacitation or delayed lethality. This class of injuries is called quaternary injuries. Finally, any of these traumas can lead to subsequent effects caused by disruption of the body's biochemical or neurological system. This class of injuries is called collateral injuries. Although blast provides a unique process by which projectiles are propelled, bodies are accelerated, and trauma is caused, the resulting injuries and sequelae can also result from other traumatic events.

Injuries that result from crushing overpressure, however, are truly unique to blast. These primary blast injuries occur because the body is not a solid, incompressible mass; it has air-containing organs that will crush under the external load. Crushing allows the outer shell of the body in those regions to move rapidly inward, thus distorting the air-containing tissue and producing local, large stresses. Injuries to the lung, gastrointestinal (GI) tract, and upper respiratory tract (URT) are common manifestations of this effect. Rapid distortion of the air-containing organs can transmit stress to neighboring solid organs as well. Contusions to the heart, for example, arise in part from the strong stress waves that develop in the lung. Large deformations of the body can also lead to stresses in solid organs that result in damage (eg, liver and spleen lacerations). Finally, rapid volumetric changes outside the normal physiological range can disrupt systemic processes. Creation of air emboli by forcing gas across the air-blood barrier of the lung and creation of large pressure transients in the vascular system may be responsible for brain injury and cell death.

The study of blast injury can be roughly divided into two objectives: (1) to characterize primary blast injuries, processes that are not investigated in other trauma research; and (2) to relate blast to projectile impact

characteristics, whole-body motion, and extreme heat, light, or atmospheric environmental conditions that, in turn, lead to nonprimary injuries. The first objective has required new research, whereas the second objective has required adaptation of previous research. Together, a complete, quantitative physiological understanding of blast injury has emerged.

Post-World War II Research

Following development of nuclear weapons, research into blast injury centered on the effects of extremely large blasts—in particular, establishment of lethality criteria for a wide range of conditions. Biological injuries from blast were categorized as primary, secondary, and tertiary, but there was little attempt to understand the mechanism of these injuries. During this period, empirical models of lethality were used.

In the United States, the majority of blast biology research was conducted at the Blast Test Site at Kirtland Air Force Base (Albuquerque, NM). The Lovelace Foundation for Medical Education and Research (Albuquerque, NM) operated this site from the 1950s until 1980, under the sponsorship of various defense agencies concerned with nuclear weapon effects or, in the 1970s, with fuel-air explosions. Animals ranging from mice to steers, as well as test dummies, were used to estimate lethality from blast in the open, in buildings, in foxholes, and with combinations of blast and thermal effects. (See the comprehensive history of the Blast Test Site.⁵)

Lethality correlations developed during this time have become part of nuclear weapons assessment and Army field manuals. The so-called Bowen curves relate lethality to the strength of the blast, as measured by peak pressure and duration.^{6,7} An empirical scaling based on body mass allows the same correlations to be used for all large animals and humans.

Occupational Limits of Blast Exposure

Whereas the Bowen curves provide a criterion for lethality, Military Standard 1474 provides a criterion for hearing protection during occupational exposure to blast.⁸ The standard is based on a 1965 report of the National Research Council Committee on Hearing, Bioacoustics, and Biomechanics (CHABA; Washington, DC) that sets noise limits for occupational environments.^{9,10} The Military Standard, using a relation adopted from CHABA that depends on amplitude and duration of the overpressure, limits the number of impulse noise (blast) exposures that can be received in a day. If hearing protection (plugs or muffs) is worn, a greater number of exposures is allowed. The standard

TABLE 10-1
TAXONOMY OF BLAST INJURY

Category	Characteristics	Body Part Affected	Types of Injuries
Primary	<p>Unique to high-order explosives, results from the envelopment of the body in the overpressurization wave.</p> <p>Body surface and internal organs are rapidly distorted because the body contains highly compressible tissues (air-containing organs) that undergo rapid volume changes.</p>	<p>Gas-filled structures are most susceptible because they suffer the greatest distortion—upper airways, lungs, gastrointestinal tract, and middle ear.</p> <p>Internal distortions of air-containing organs cause distortion of neighboring solid organs—heart, liver, spleen, and kidneys.</p> <p>Differential loadings within the body, especially the vascular system, can cause upset that can be transmitted to other parts of the body.</p>	<p>Blast lung (pulmonary barotrauma).</p> <p>Tympanic membrane rupture and middle ear damage.</p> <p>Abdominal hemorrhage and perforation; globe (eye) rupture.</p> <p>Concussion (traumatic brain injury without physical signs of head injury).</p> <p>Laceration of the liver, spleen, and kidneys.</p> <p>Contusion to the heart.</p> <p>Distortion and rupture of the great vessels.</p> <p>Air emboli introduced across the air–blood boundary of the lung.</p> <p>Surges in blood flow and pressure that may lead to tissue injury in the brain.</p>
Secondary	<p>Impact on the body from flying debris and bomb fragments.</p>	<p>Any body part may be affected.</p> <p>Depends on the speed, mass, and shape of the impacting object.</p>	<p>Any injury associated with impact of high-speed objects. These modes are not unique to blast; however, blast provides a different way of propelling the objects.</p> <p>Penetrating ballistic (fragmentation) or blunt injuries.</p> <p>Eye penetration (can be occult), skull fracture, etc.</p>
Tertiary	<p>Whole-body acceleration caused by the blast wind.</p> <p>Uneven forces on the body caused by the blast winds.</p>	<p>Any body part may be affected.</p> <p>Depends on the surface condition that the body impacts.</p> <p>Primarily head/neck and extremities that can be accelerated relative to the torso.</p>	<p>Any injury associated with whole-body motion and impact. These modes are not unique to blast; however, blast provides a different way of accelerating the body.</p> <p>Typical injuries that would occur in falls or car crashes. Fractures, contusion, and closed- and open-head injuries, etc.</p> <p>Traumatic amputation; muscle tears.</p>

Table 10-1 *continued*

Category	Characteristics	Body Part Affected	Types of Injuries
Quaternary	All explosion-mediated injuries not associated with pressure or wind effects. High temperatures. Toxic gases.	Any body part may be affected. Body surfaces, eyes. Respiratory system.	Burns (flash, partial, and full thickness). Asphyxia. Injury or incapacitation from inhaled toxic fire gases.
Collateral	Secondary consequences of trauma. Exacerbation or complications of existing conditions.	Systemic responses from massive trauma.	Not unique to blast. Angina, hyperglycemia, and hypertension. Asthma, chronic obstructive pulmonary disease, or other breathing problems from dust, smoke, or toxic fumes.

contains a special limit, called the Z-line, corresponding to the auditory limit of 5 shots/day when wearing protection. Exposure above the Z-line is prohibited, because of the potential for nonauditory injury. Although it is unlikely that any data to support this limit existed when the CHABA originally met, it is understandable that, at some level—no matter how effective hearing protection is—there will be a risk of injuries to other parts of the body from blast. In 1965, no occupational noise approached the Z-line limit.

As noted previously, the M198 howitzer, a critical new weapon system, exceeded blast noise limits and could not be fielded. It fell on USAMRMC and MOMRP to address this issue. It had always been suspected that the Z-line was a conservative limit, but it was not known at what level internal injury would first appear or how it would manifest.

To solve the immediate crisis of the M198 howitzer, a human volunteer study was organized.¹¹ Starting from distances known to be safe, the volunteers moved closer to the howitzer until they were at the crew positions. Medical examination showed that hearing could be protected and that no internal injuries were sustained. The M198 testing proceeded, and the system was fielded, although a training restriction on the number of exposures above the Z-line was made. Additionally, USAMRMC initiated a research program for blast injury to develop a replacement standard for the Z-line. Until a new standard was developed, similar human-rated qualification of weapons systems would be conducted whenever the Z-line was exceeded.¹²

Military Operational Medicine Research Program (Blast Injury Research)

From the beginning, the MOMRP blast research program was model-based. The decision to use a model-based system came from a balanced assessment of the immediate and long-term benefits of animal, physical surrogate, and mathematical model approaches. On one extreme, a test of the actual threat against a human under the exact conditions of interest is the least ambiguous way to determine an effect and one that requires no understanding of the internal mechanisms. This is ethically not possible for conditions that produce injury and is impractical to define the range of conditions. On the other extreme, a mathematical model that captured every mechanical, chemical, and biological aspect of the human body can provide a simulation basis for studying any situation without risk to an individual. Given the state of knowledge and computing, this goal exceeds any reasonable endeavor. In between these extremes are combinations of animal, physical surrogate, and mathematical models that describe some part or scale of the interaction (Figure 10-1). The goal of the MOMRP effort is to use the appropriate mix of tools to derive the best possible immediate answer, while continuing to develop incrementally better mathematical models that will expand the generality of our understanding.

The first problem addressed was the interpretation of the pressure signal. Unlike the idealized waveforms that had been encountered and characterized in large-

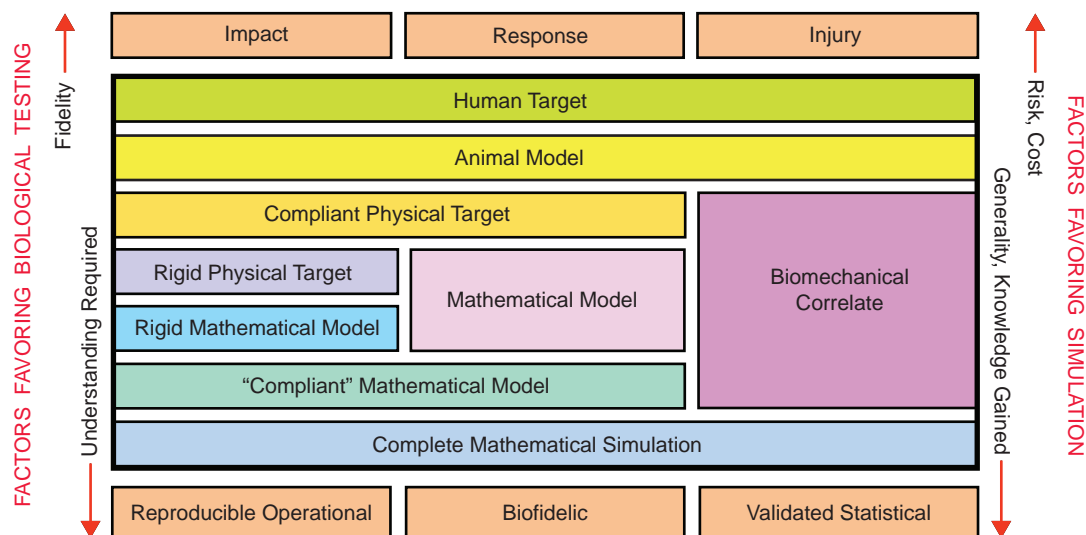

Fig. 10-1. Animals, physical surrogates, and mathematical models. Illustration: Courtesy of L-3/Jaycor, San Diego, California.

scale explosions, the howitzer waveform contained two peaks. This form confounded the simple empirical correlates that existed and, because they varied in magnitude and time of separation from place to place around the howitzer, were suspected to be artifacts of the test geometry or the instrumentation. Jaycor, Inc (San Diego, Calif), developed a mathematical model of the propagation of the blast from the muzzle of the weapon, accounting for the nonlinear reflection from the ground. The model proved conclusively that the waveforms were from those interactions. Furthermore, the model was able to provide a complete map of the hazardous areas around the gun, for all gun elevations and charge types, without requiring extensive physical measurements. With this model, analysis of other weapon systems could also be made with data from only a few measurement locations for calibration.¹³

Using the results of the model as a guide, animal studies were formulated and conducted at the Blast Test Site. From 1980 until its closure in 1998, the focus of the research was injury, not lethality. Studies spanned blast conditions that produced no observable effects to serious, life-threatening injury and death. Great care was taken to document pathologies observed in all organs. Primarily sheep were used as test subjects to provide consistency across all studies. This 18-year effort produced nearly 2,000 animal exposures that represent the most extensive collection of blast-related injury data in the world. Subsequently, a comprehensive pathology scoring system for blast injuries was developed.

The earliest injury tests were focused on establishing a threshold level of blast overpressure, below which

injury would not occur. Unfortunately, such a level could not be determined definitively, because small probabilities of injury required a large number of animals to estimate thresholds with confidence. These low-level tests did show, however, that the air-containing organs (ie, lungs, GI tract, and trachea/larynx) were the first organs to be injured.¹⁴

Next, tests were designed to determine if URT injury occurred before lung and GI injuries, with the thought that a harmless precursor injury could be used as an indicator of impending, more serious, internal injury. This hypothesis was based on auditory experience in which a temporary threshold shift (a minor, transient hearing loss) always preceded permanent hearing loss and, therefore, allowed human subjects to be used to establish safe boundaries. Unfortunately, blast-caused URT injury occurs at essentially the same levels that cause lung and GI injuries.

Finally, tests were conducted to establish a universal blast exposure dose that could predict injury from the blast pressure signal alone, eliminating the need to conduct animal or human tests. The logical candidate, based on the trends seen in structural damage from blast, was impulse—the time integral of the pressure signal. Impulse, however, did not provide a universal correlate with blast injury.

Failure of these attempts to identify simple patterns of markers in blast injury was amplified when blasts in enclosures were studied. Results of these studies underscored the need to understand actual anatomical dynamics and root causes of primary blast injury. Mathematical modeling helped guide research and establish criteria.

FIRST-GENERATION INJURY MODELING

First-generation models correlated injury to mechanical responses of the body, rather than to the characteristics of the blast pressure itself. This biomechanically based criteria was driven by failure of pressure-based correlates to predict injury for simple waves in the free field or for complex waves in enclosures.

The mechanism of injury was hypothesized to consist of three causal steps: (1) blast waves create temporal and spatial loading distributions on the external body surface; (2) the body deforms under the loading and causes internal stresses and strains in the tissues; and (3) when these tissue stresses exceed material limits, injury occurs. Computational power, both in terms of computer speed and simulation software, was in its infancy in the early 1980s; however, mathematical modeling made significant contributions. Four organ systems were considered in first-generation injury modeling: (1) the tympanic membrane, (2) the trachea, (3) the GI tract, and (4) the lung.

Observed Blast Injuries

Blast can cause a wide range of injuries. As the explosive levels grow, the magnitude of the forces acting on the body grows, and the extent of the body response increases. Occupational standards, however, focus on identifying the organs most easily injured and on setting acceptable levels of lesser injuries.

From testing at the Blast Test Site, a clear pattern of blast injuries emerged. Over time, as more data have been collected, these patterns have been reaffirmed; and, using the animal tests currently available, the patterns

could be assigned statistical significance. To observe the pattern of injury from a range of tests that used different explosive weights, ranges, heights of burst, orientations, and number of exposures, it is necessary to select a single characteristic of exposure. One such parameter is the charge weight per characteristic volume. In the free field, this volume is a sphere with a radius equal to the distance to the test subject; in enclosures, this volume is the volume of the enclosure. Surprisingly, and, perhaps fortuitously, this quantity provides a good correlation and similar numerical values for the thresholds in all cases.

The average explosive weight per volume, at which minor and severe injuries are seen for each organ group, is shown in Figure 10-2 for tests in enclosures. A similar trend exists for the free-field tests. Organs can be separated into three groups having similar characteristics. The air-containing organs (larynx, trachea, lung, and GI tract [forming the first group]) show the first signs of injury at approximately the same blast intensity, which is well below that seen in other groups. The liver and spleen (Figure 10-3) fall into a second group, whereas the kidney, pancreas, and gallbladder form the third group. Clearly, the air-containing organs are the most vulnerable and, therefore, require the greatest consideration for occupational exposure. All organs are seriously injured at similar blast intensity. Lethality, which is primarily due to a multiple organ failure, is seen at this same level.

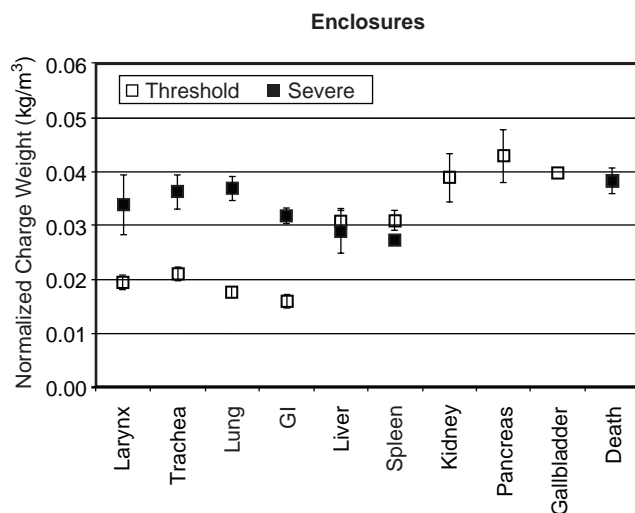

Fig. 10-2. Observed blast injury. GI: gastrointestinal
Illustration: Courtesy of L-3/Jaycor, San Diego, California.

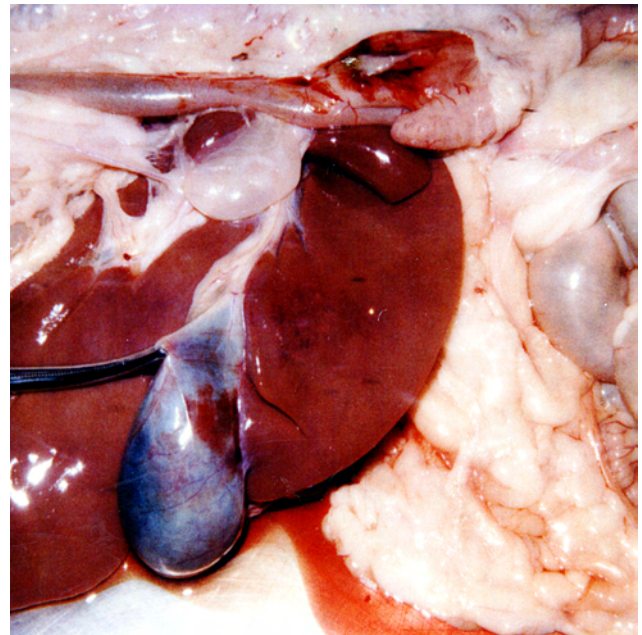

Fig. 10-3. Liver injury resulting from blast.
Photograph: Courtesy of L-3/Jaycor, San Diego, California.

Exploratory Injury Models

Mathematical modeling of biological systems is particularly difficult, because every aspect of the system (geometry, material properties, and strengths) is complex and determined by ever smaller structures, all the way down to the cells themselves. Therefore, each aspect of the model must be guided and validated by experimental data.

Tympanic Membrane Injury Modeling

Tympanic membrane rupture is a common blast injury and one that occurs at blast levels usually well below any of the internal injuries. Although not considered a life-threatening injury, eardrum rupture can be extremely painful and may or may not be associated with hearing loss. In the mid-1980s, eardrum rupture was a concern of blast exposure in training and in combat. Thus, an effort to develop a mathematical model of the process was undertaken. Finite element modeling (FEM) was used to model the stapes and the membrane. The stresses at which the membrane tore were based on independent tissue properties measurements. The model was subsequently validated against in vitro data to establish biomechanically based injury criterion.¹⁵

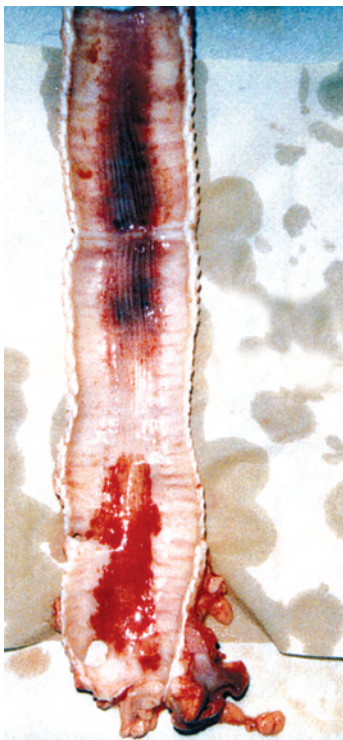

Fig. 10-4. Tracheal injury resulting from blast. Photograph: Courtesy of L-3/Jaycor, San Diego, California.



Fig. 10-5. Gastrointestinal injury resulting from blast. Photograph: Courtesy of L-3/Jaycor, San Diego, California.

Tracheal-Laryngeal Injury Modeling

Initial interest in establishing URT injury as a precursor to more serious internal injury prompted the need for a model that could be used to extrapolate URT injuries from animal to humans. Blast-induced tracheal injury is often striated in appearance, corresponding to the cartilage between the bony rings. In extreme conditions, it can present as a confluence of hemorrhagic tissue (Figure 10-4). The trachea was selected for modeling because of its geometric simplicity and because material properties were available from the literature. Blast loading on the neck was used as the external boundary condition, and injury was correlated with peak stress that developed in the tissue. This model predicts the mechanical response of the larynx, and the general trends of the injury are correlated with stress in the tissues.¹⁶

Gastrointestinal Injury Modeling

GI injury from blast appears first as small petechia in the gut lining, grows in hemorrhagic area as blast intensity increases, and can reach frank rupture. In sheep, the injury most commonly appears in the cecum, although large blasts produce injury throughout the GI tract (Figure 10-5). GI injury—especially rupture of the tract wall—can lead to sepsis and death, and can complicate treatment of other injuries, especially those in the lung.

Rabbit experiments confirmed that GI injuries were associated with sections of the tract containing air bubbles. The bubbles collapsed during the overpressure phase of the wave and then violently reexpanded. If the bubble was close to the tract wall, this rapid volumetric change led

to deformation of the wall. The effect varied with bubble size, overpressure, and tract contents. For large overpressure, the stresses became so great that rupture of the wall occurred. Once the mechanism was established, surrogate GI models were developed that allowed this bubble-wall interaction phenomena to be further studied.¹⁷⁻²⁰

With these surrogate observations as a guide, a mathematical model of the bubble dynamics and wall response was developed.²¹ The model produces the same dynamic response and, when coupled with material properties and the strength of the tract wall, can provide a predictive model for GI injury from blast.

Because lung injury was eventually selected as the primary injury to set blast exposure limits, the GI model was not pursued. The model suggested, however, that GI injury may be greater in sheep than in humans because the sheep is a ruminant with much more gas in the intestines. A summary of the early blast data analysis and model development is found in the publication *Modeling of the Non-Auditory Response to Blast Overpressure: Characterization and Modeling of Thoraco-Abdominal Response to Blast Waves*.²²

Lung Injury

Even though all of the air-containing organs are injured, Walter Reed Army Institute of Research (WRAIR) physicians determined that injury to the lung is of greatest

concern and should be used to set exposure standards. As a result, modeling research efforts focused on understanding lung injury mechanisms and developing predictive lung models.

Most organs of the body are liquid-filled, some are air-filled, but the lung is a complex matrix of more than 500 million small air sacs (or alveoli), with tens of millions of connecting airways.²³ Under normal physiological motion, this structure acts as a simple balloon that fills and empties, with a pressure drop from inside to outside that is modest and reflects the resistance of the many small airways. Under the rapid motion caused by blast, however, air cannot flow fast enough through the airways, and the lung acts as a collection of isolated air bubbles—a foam. Foams have the interesting physical property that their speed of sound (the speed at which a volumetric disturbance in one part of the material can be spread to other parts) is only 30 to 40 m/s—one tenth that of air and one fiftieth that of water.^{24,25} This low speed of sound causes the lung parenchyma directly behind the moving chest wall to be crushed and severely injured, if the chest wall velocity is great enough. The injury produces a characteristic surface hemorrhage pattern predominantly on the blast side in the free field, but can involve the entire lung when the blast is enclosed (Figure 10-6).

In the early 1980s, Jaycor began working with Professor Y C Fung at the Bioengineering Department at

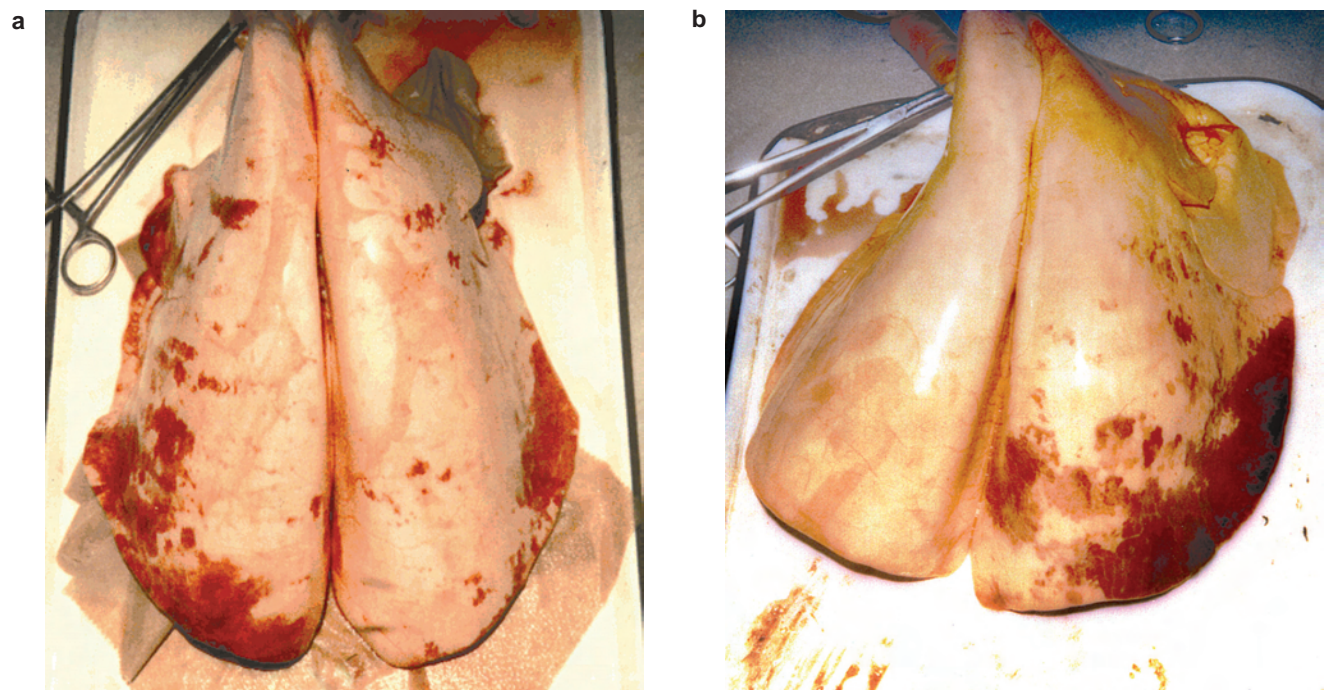

Fig. 10-6. Lung injury resulting from blast. (a) Complex waves. (b) Freefield waves. Photographs: Courtesy of L-3/Jaycor, San Diego, California.

the University of California, San Diego, to collect data that would support the development of a lung injury model. Professor Fung had already been studying the material properties of lung tissues.²⁶ Over the subsequent several years, he and his colleagues established the key dynamic properties of lung tissue under the rapid motion associated with blast.²⁷ They confirmed the low speed of sound and determined its variation with transpulmonary pressure. This group also established the correlation of internal lung pressure with edema—the breakdown of the alveolar walls.²⁸ They measured the properties of the whole lung and lung tissue for both small animals and humans, and they showed that the material properties were similar. Experiments were conducted to elucidate the injury process, and mechanisms of injury at the tissue level were proposed.^{28,29} Jaycor, in one of the first applications of finite element analysis of biological systems, developed a two-dimensional model of the thorax under blast loading to quantify these tissue injury processes.^{30,31} That model reproduced the slow speed of the internal pressure waves in the lung, showing that the highest values of these pressures were located on the pleural surface of the blast side, the heart, and the spinal process. These locations are similar to lung contusion observed in animals exposed to blast.

INJURY Software, Versions 1.0 to 4.3

Finite element analysis, although insightful, was too problematic initially to be used as a means to understand the hundreds of animal tests that were being collected or to be used as a replacement for the Z-line. Consequently, simpler models were used: modeling the inertia of the chest wall and the density and speed of sound of the lung to create the so-called pleural surface model (Figure 10-7).²² When blast pressure acts on the chest wall, it accelerates, creating a pressure wave in the lung tissue, which in turn pushes back against the chest, thus slowing it down.³² The mechanical model was also validated against closely spaced blast loads that produce a double-peaked wave within the lung.³³ The total work (or the sum of all force expended in all directions) done on the lung represents the magnitude of damage caused by crushing the alveoli. This irreversible work

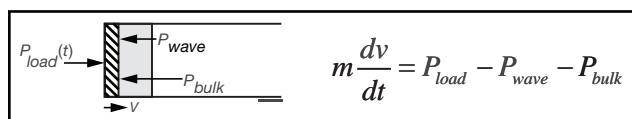

Fig. 10-7. Pleural surface model of chest–lung interaction. Illustration: Courtesy of L-3/Jaycor, San Diego, California.

(caused by forces exceeding the tensile strength of the tissue) was the first biomechanical correlate of lung injury. Normalized work, which is the irreversible work divided by the product of the lung volume and ambient pressure, has proven to be a reliable predictor of blast lung contusion that can be applied across species, body weight, and altitude. The final version of the pleural surface model was published in 1996.³⁴

Work also proved to be a correlate of lethality. The Bowen curves, developed decades earlier as empirical correlates of lethality observed in the free field, were shown to correspond to a particular work value. This finding not only provides a rational basis for the lethality curves, but also provides a way to make lethality estimates in situations other than the free field. The lethality criteria based on work also allowed other lethality observations, such as the reduction of lethality for slow-rising blast waves, to be explained with a single theory.³⁴

The first versions of the INJURY software (Jaycor, Inc)—versions 1.0 through 4.5—were developed to solve the pleural surface model equations and provide a prediction of the probability of injury. The input to this analysis is the so-called free field or side-on pressure measurement, which is converted to torso load with formulas for wave reflection. Effects of body orientation are accounted for by the angle of the chest to the blast direction. The medical staff at WRAIR used these versions of INJURY software to make case-by-case health hazard assessments of weapon systems.

Simple Waves

Use of a biomechanical model to describe blast injury requires knowledge of torso loading. Loading distributions can be quite complex, even for simple, free-field blast waves. A blast wave in the free field has a relatively simple description. The explosion produces a high-pressure region that evolves into a shock front that moves at a speed greater than the speed of sound. The pressure decreases behind the shock and can even drop below the ambient pressure. Tables of experimentally determined values and elegant theories and correlations capture these data.³⁵ When a blast wave strikes the ground, it creates a reflected wave with a second shock front. The incident and reflected waves can interact with one another and, if the blast is strong enough, produce a third shock wave, the so-called Mach wave, that moves parallel to the ground. Above a certain height, called the triple point, where the three shocks intersect, one observes the incident and reflected waves; below the triple point, one observes only the Mach wave (Figure 10-8). As can be seen, even free-field explosions produce complicated blast patterns.

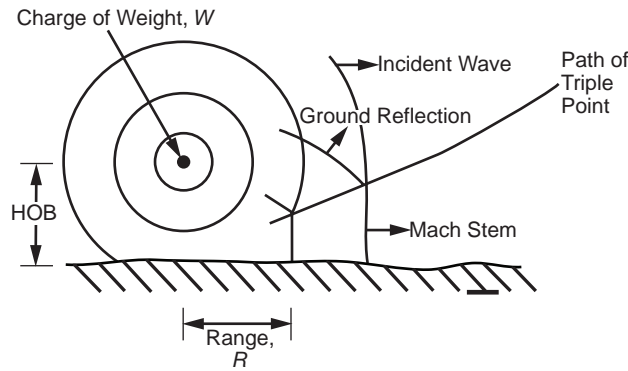

Fig. 10-8. Mach stem and triple point. HOB: height of burst
Illustration: Courtesy of L-3/Jaycor, San Diego, California.

When a shock wave hits a body, another complicated interaction occurs. The surface of the body facing the blast source acts as a reflector, producing its own reflected wave; but, because it is generally curved, not flat, there can be many reflected shock waves. As the wave passes around the body, the angle of the incident wave to the surface changes, altering the strength of the reflected waves; at the side, there is no reflected wave. Near this location, the flow from the blast separates from the body and creates a region behind the body that has a pressure lower than the incident wave, but higher than ambient. Consequently, the loading pattern on a standing human in a simple blast wave is quite complex: (a) the chest, assuming facing the blast, receives a loading that can be 2 to 8 times greater than the incident wave; (b) the sides receive a loading comparable with the incident wave; and (c) the back feels a loading that is a fraction of the incident wave. These interactions can be calculated with computational fluid dynamics (CFD) simulations.³⁶⁻³⁸ If the torso is above the triple point, then the distribution is even more complicated because the body is hit by two waves: (1) the incident component and (2) the reflected component.

For an animal standing on all fours, there is even more complication. One part of the wave passes over the back of the animal in the manner described previously, but the other part of the wave passes under the animal and creates additional reflections off the ground. The chest, which is normally facing downward, can receive a blast loading that consists of multiple shock interactions.

Clearly, even in the "simple" geometry of the free field, the blast loading on the body required to determine blast injury can be quite complex. Characterizing the torso loading in terms of a single, free-field pressure measurement was not adequate.

The Blast Test Device

Because the blast loading in the free field was not easily inferred from a free-field pressure gauge, a new instrument was developed. Eventually known as the Blast Test Device (BTD), it consists of a metal cylinder, supported from the ends, with the approximate diameter of the sheep chest and with four surface-mounted pressure gauges evenly spaced around the cylinder (Figure 10-9). One pressure gauge is oriented facing the oncoming blast wave, with the other gauges corresponding to the sides and back. The BTD is oriented in the same direction as the test subject, vertically for a standing human or horizontally for a standing animal.³⁹

Since its inception, the BTD has been the preferred instrument for providing loading data for blast injury analysis. Because it measures the loading directly, there is no need to interpret the instrument output, correct for gauge orientation, account for being in or out of the Mach wave, or other factors that are required when free-field gauges are used. Over the years, the BTD has been placed directly on the ground to simulate a soldier firing from a prone position, propped up in a seat simulating a passenger in a vehicle, and hung from vertical supports to simulate suspended animals in an enclosure.



Fig. 10-9. Blast Test Device.
Photograph: Courtesy of L-3/Jaycor, San Diego, California.

Blast in Enclosures

In the late 1980s, increased importance of Military Operations on Urban Terrain (MOUT) emphasized the need to train on weapons fired from buildings or enclosures. Initial animal studies showed that these situations are far more dangerous than their free-field counterparts and showed what appeared to be non-intuitive trends (eg, that animals farther away from the explosive, but in a corner, are much more severely injured than animals closer to the blast, but along a wall). These findings meant that the explosive charge weight and the distance, which had been mainstays of characterizing free-field blast, were no longer sufficient factors to consider.

Blasts in enclosures, often called complex exposures, led to attempts to extend previous injury and lethality correlations. Even though the Bowen curves provided a correlation of lethality in the free field, it could not be applied to complex waves. Although the peak pressures were about the same as would occur at the same distance from the same charge in the free field, the durations were much longer because of the wave reflections from the walls. If the Bowen curves were used, they would often predict lethality in benign conditions. Ad hoc changes were proposed to the definition of duration in an attempt to explain the data, but were not satisfactory.

The BTM proved to be the perfect instrument for characterizing the effects of blast in an enclosure. BTM measurements in corners showed the strong blast loading on the *back side* of the instrument, the side away from the blast and facing the corner. In many pressure traces, clusters of very large peaks were observed in the side or back gauges that had never been seen in the free field. When the pressure measurements from the back side of the BTM were used in INJURY software, the large work values calculated explained the occurrence of injury in the lung lobes *away* from the blast.

Although the BTM measurements offered a plausible explanation for the injuries seen in enclosures, the

complexity and violence of the pressures measured had not been anticipated. It seemed likely that these pressures were from a convergence of waves coming to the corner from many reflective paths, but there was also concern that some or all of the effects may be artifacts of the pressure gauges in such harsh environments. Although simple ray-tracing techniques had adequately described the howitzer blast in the open, they proved inadequate to capture the complex reflections and interactions of the blast waves in an enclosure.

Computational Fluid Dynamics

CFD represents the numerical solution of the highly nonlinear, highly coupled, fluid dynamics equations. The science and art of CFD were first developed to support nuclear weapon design and effects analysis; but, by the late 1980s, the technique was used in all areas of engineering.

This technique was adapted to blasts in enclosures to provide a rational understanding of “complex” blast. Simulations using the Equation Independent Transient Analysis Computer Code (EITACC; Jaycor, Inc) were made to understand the data from the BTM. Simulations could reproduce, with remarkable fidelity, the details of pressure measurements.³⁸ As computer power rapidly grew in the early 1990s, CFD was used routinely to analyze complex waves (eg, to determine the effects of other objects in an enclosure on the blast loading).³⁶

The first-generation models provided a way to predict injuries to the tympanic membrane, URT, GI, and, most importantly, the lung. These models, although simple, were based on biomechanical principles and had parameters that could be rationally determined from anatomy and tissue property measurements. The emerging importance of explosions in enclosures prompted development of new blast instrumentation, the BTM, and use of state-of-the-art CFD tools.

SECOND-GENERATION INJURY MODELING

The second generation of injury modeling extended the single-degree-of-freedom models of primary blast injury to use the data directly from the BTM and to standardize the health hazard assessment process. Also, models for secondary and tertiary injuries were developed. The collaborative work between MOMRP and the Joint Non-Lethal Weapon Program (JNLWP) on projectile impact injury for nonlethal weapons led to the development of models to capture modes of impact injury to all

parts of the body that could be used to assess secondary blast injury. The collaborative work between MOMRP and the National Highway Traffic Safety Administration (NHTSA) led to models of injury from whole-body impacts that could be used to evaluate tertiary blast injury. Finally, a cooperative project between MOMRP and the Defense Nuclear Agency explored the combined over-pressure and thermal injuries and the collateral effects of compromised immune systems.

INJURY Software, Versions 5.0 to 7.1

Previous versions of INJURY software that considered the loading from a single side of the body successfully predicted free-field blast injury. In the free field, the injury is primarily in the lobes on the blast side. Complex wave exposures, however, showed the importance of loading from all sides of the body and, consequently, the pathology showed injury to all lung regions. The refinements of the INJURY software benefited from the growing number of animal data collected with BTDs at the Blast Test Site.⁴⁰

Total Work on the Lung

The first change in INJURY software was to compute the normalized work from four calculations with the pleural surface model, one for each of the BTD measurements. The work was summed and correlated with overall observed pathology. This simple approach explained the injury trends, especially the increased hazard in corners of enclosures.

Whole-Body Loading

The importance of simultaneous loading from all sides of the body led researchers to consider more complete biomechanical descriptions of thoracic motion. The Lobdell model, developed at General Motors Corporation (Detroit, Mich), is used in the automotive industry to characterize chest impacts and has been calibrated by cadaver studies.⁴¹ The model accounts for the entire torso mass and—therefore, can be used to estimate whole-body acceleration from blast—replicates the dynamic force–distance relationships of large chest deformations with a combination of springs and dampers. The Lobdell model, however, is not anatomically based; it characterizes the chest with an equivalent mass, but not an equivalent area. For solid-body impacts, only the chest mass is needed; but, for blast waves that are described by a pressure (force/area), a chest area must be assigned.

To determine the effective area of the chest acted on by a blast wave, a finite element model of the thorax based on the National Library of Medicine’s (Bethesda, Md) Visible Human Project data set was developed.⁴² The internal organs were resolved as separate anatomical regions and materials. Material properties of the lung were based on earlier, established measurements; the heart treated as a liquid-filled sac; and the ribs and chest wall muscles combined into a single material whose elastic properties were selected from data in the

literature. The model was validated for the same impact conditions that had been used to calibrate the Lobdell model, including both frontal and side impacts.

The validated finite element model was examined using a series of tests for which blast loadings and lung pathology were known in detail. The resulting prediction of internal pressure distribution closely matched the observed pathology patterns. The total normalized work was determined from the calculated chest wall motion, which also agreed with the simpler INJURY software estimates. Finally, the fully validated model was used to determine the effective area that should be associated with the Lobdell model. The frontal area presented to the blast could be divided into the part that is deformed by the blast and the part that moves with the entire torso. The resulting modified Lobdell model (Figure 10-10) agrees with the more detailed finite element model with respect to chest compression, total normalized work, and whole-body motion. The pleural surface model was replaced by the modified Lobdell model in the next generations of INJURY software.⁴³

Effects of Multiple Exposures

Based on animal test data available at the development of the first versions of INJURY software, it was believed that there was no cumulative injury to the lung from blast (ie, the lung was injured on first exposure, or it was never injured, no matter how many

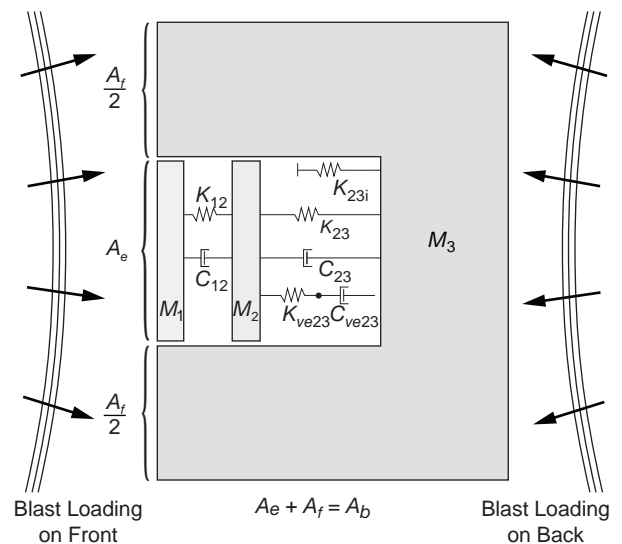

Fig. 10-10. Modified Lobdell model. Illustration: Courtesy of L-3/Jaycor, San Diego, California.

times the blast was applied). As more data were collected, it became clear that there was a cumulative effect in lung injury and that this effect was critical to determining the occupational exposure.

The animal data set was analyzed using a model of tissue fatigue to account for cumulative damage. Multiple logistic regressions, incorporating the fatigue factor, were used to produce correlations for four levels of lung contusion: (1) trivial (small petechia), (2) slight (less than 5% of the lung surface area contused), (3) moderate (less than 30% of area contused), and (4) severe (more than 50% of area contused).

Probabilistic Prediction

Multioutcome logistic regression was used to generate correlations between normalized work and each level of lung injury severity. This advanced mathematical technique brings the greatest statistical power to the development of the correlation and allows INJURY software to predict not only the expected injury, but also the most likely distribution within a population (Figure 10-11).

Full Coupling to the Blast Test Device

The interface to INJURY software was changed to allow the software to directly use the pressure data

files taken from the BTD. Data format standards were established, and standardized reports were generated with each analysis.⁴⁴ A tightly coupled instrument and software analysis procedure was established that continues to be used.

Replacement of the Z-line in Military Standard 1474

From the release of the first version of INJURY software, health hazard assessments for nonauditory blast have been made based on its analyses. As the BTD gained acceptance, evaluation of occupational exposure conditions in which nonauditory blast injury was suspected used the BTD-INJURY software combination to estimate the probability of lung injury. Initially, the assessments were done by WRAIR physicians, and the upper limit on exposure was the occurrence of 1% of the most trivial lung injuries. To transition the technology to the US Army Center for Health Promotion and Preventative Medicine (CHPPM; Aberdeen Proving Ground, Md), the Executive Agent for the Army's Health Hazard Assessment (HHA) Program, it was necessary to standardize the procedure and to interpret the predictions in terms of a risk assessment code (RAC).

The RAC, used by CHPPM to assess the health hazards of military materiel, is a score from 1 to 5 that indicates the potential consequences of the

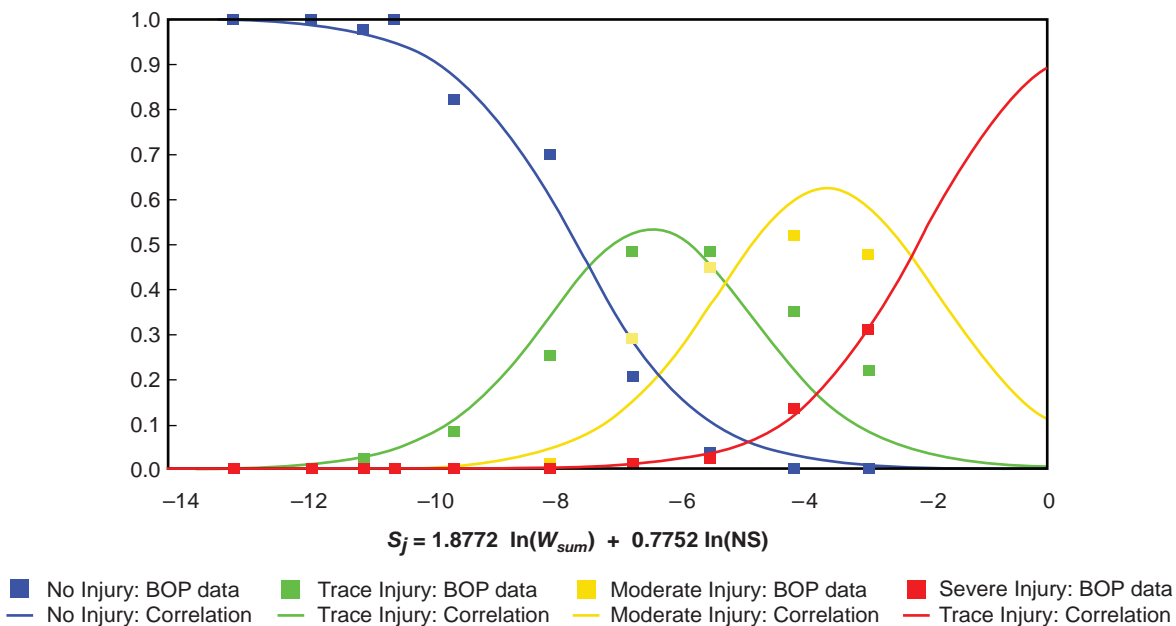

Fig. 10-11. Probabilistic prediction of lung injury. BOP: blast overpressure; NS: not significant; W_{sum} : sum of normalized work from all sides of the body
Illustration: Courtesy of L-3/Jaycor, San Diego, California.

hazard. A RAC of 5 represents a hazard that is negligible, whereas a RAC of 1 represents a hazard with catastrophic consequences.

A second form of the blast injury assessment software called BOP-HHA (Jaycor, Inc)⁴⁵ can analyze data from a complex test series in which multiple positions, explosive strengths, and repeated shot data are collected. The software determines the probability of each of the four levels of primary blast injury, from the trivial to the most severe, and incorporating both biological and shot-to-shot variabilities. These probabilities are used along with the hazard matrix to determine the RAC.

MOMRP sponsored a human volunteer study at the Blast Test Site from 1989 through 1997.⁴⁶⁻⁵¹ The test procedure exposed groups of individuals, each wearing hearing protection, to an increasing sequence of blast noise conditions. (See Figure 10-12 for an example of volunteers being exposed to blast from a simulated mortar.) Pretest audiograms established baseline hearing profiles for each individual and ensured proper fitting of the protective devices. Post-test audiograms established the temporary threshold



Fig. 10-12. Volunteers being exposed to simulated mortar blasts. Photograph: Courtesy of L-3/Jaycor, San Diego, California.

shift at a range of auditory frequencies. Temporary threshold shifts of 25 dB were taken as the recoverable failure limit for exposure of an individual. Long-term tracking of each individual showed that all hearing returned to baseline levels.

The study produced about 2,000 subject-exposure tests designed to determine the effects of blast intensity and number of exposures on recoverable failure. As would be expected, the percentage of failures increases monotonically with blast intensity and with number of exposures. The design of the experiment envisioned groups of 64 subjects progressing through the exposure matrix. That number of subjects would allow an estimate of the probability of failure at the 95% confidence level. Invariably, some subjects dropped out of each group, causing the significance of the results for a particular exposure condition to drop below the target confidence level.⁵²

An independent statistical analysis of the volunteer data was conducted using logistic regression analyses.⁵³ The subject-exposure tests were pooled into a pass-fail outcome with blast intensity, duration, and number of exposures as independent variables. The large number of data gave the analysis considerable statistical power and resulted in an estimate of the failure criteria with a narrow confidence band. Results showed that the observed threshold for failure, a 25-dB temporary threshold shift, is nearly 10 dB higher than the current Military Standard limit. In addition, the analysis showed that the best correlation of blast injury *decreases* with duration, but is consistent with data on the risk of short duration exposure, such as rifle fire.

Taken together, the estimated human threshold tolerance to both auditory and nonauditory blast injuries are greater than that previously indicated in Military Standard 1474. Formal revisions of the Military Standard to incorporate model-based criteria for both auditory and nonauditory injuries are undergoing consideration for adoption by the HHA Program.

Secondary Blast Injury Modeling

In occupational settings, primary blast injury is the only concern. In combat, where blasts are much larger, debris can be propelled at the soldiers by the blast and lead to impact trauma or secondary blast injury. MOMRP has developed a biomechanical model of the impact trauma that can be used to evaluate this hazard.

In 1996, an interagency collaboration was formed—involving USAMRMC; the Armament, Research, Development, and Engineering Center

(ARDEC); the National Institute of Justice (Washington, DC); and the US Department of Transportation (Washington, DC)—to quantify projectile impact injuries in terms of the characteristics of the projectile (mass, velocity, shape, and composition) and the region of the body impacted. The research collected and reviewed all previous studies and mathematical models on impact injury and selected the most credible set that would describe the widest range of blunt trauma and penetrating injuries. A software program, the Interim Total Body Model (ITBM; Jaycor, Inc), was developed and distributed to the sponsoring organizations.⁵⁴

The ITBM software depends on the characterization of the impact loads from the projectiles. Specialized instrumentation for measuring the magnitude, duration, and extent of the forces delivered by the projectiles was developed.^{55,56} A specialized test apparatus was developed to accelerate various projectiles at controlled speeds onto the instrumentation for determination of dynamic properties and other test protocols for static properties. The combination of the testing apparatus, protocol, and model estimation became the standard for nonlethal weapon assessment.

WRAIR conducted swine tests to determine internal injuries from nonlethal projectile impacts. Test conditions covered an injury spectrum from mild skin bruising to through-and-through thorax penetration.

Subsequent to this initial work, the Joint Non-Lethal Weapon Directorate (JNLWD; Quantico, Va) was formed, and in 2005, a Memorandum of Agreement between USAMRMC and JNLWP was formalized to share technology and resources. Under this agreement, joint research continued on blunt trauma from projectiles that includes model development, and animal and postmortem human subject testing. This research benefits both organizations by providing fundamental blunt trauma injury data to support USAMRMC soldier protection research programs and JNLWD nonlethal weapons assessment programs.

This partnership has produced new biomechanically based models for a wide range of secondary blast (impact) injuries. A finite element model of skin response under impact has produced a model for penetration injury that takes into account the detailed anatomical structure and clothing.⁵⁷ This model has been validated against animal studies at the Air Force Research Laboratory (Brooks City Base, Tex) and historical data collected from the literature. Similarly, a biomechanically based correlate for rib

fracture has been developed that accounts for the detailed anatomical structure and material properties of bone.⁵⁸ Similar cross-applications of head injury, skull fracture, and abdominal injury are being pursued. The ITBM, the Advanced Total Body Model (ATBM), and derivative applications provide the best estimation of injury from secondary blast effects.

Tertiary Blast Injury Modeling

The third mode of injury results from whole-body translation caused by the blast pressure differential and blast winds. These forces can hurl the body itself into surrounding objects and cause subsequent tertiary injuries. Although these injuries can result from blast, they are not unique to blast and have been studied in many other circumstances. In 1993, MOMRP began a collaborative effort with NHTSA (Washington, DC) on head and neck injuries—the most significant injuries that occur from body impacts. This collaboration has produced models of closed-head injury and head-neck injury that can be applied to tertiary blast injuries.

Combined Injury Modeling

Complications of exposure to nuclear explosions include the following:

- physical trauma from the blast wave,
- burn trauma from thermal radiation, and
- disturbance to the immune system from the ionizing radiation.

Because of the possibility of sepsis and secondary infection, reduced immune function is especially dangerous when it occurs along with injury to the gut. In 1990, the Defense Nuclear Agency, now the Defense Threat Reduction Agency (Fort Belvoir, Va), approached MOMRP for assistance in defining a relationship between blast and GI injury that could be used to assess battlefield consequences. As part of the joint work, Jaycor developed mathematical models and a visual assessment of the nuclear battlefield showing where combined injury effects could occur. In addition, a cellular-based model of the response of the immune system to ionizing radiation was developed.⁵⁹ This model incorporated stem cell dynamics and the interaction of white cells with opportunistic infections. The results generalized the standard, empirical response curves previously used into a form that could study a wider range of exposures and interventions.

Closing of the Blast Test Site

New residential communities around Kirtland Air Force Base objected to the noise from the blasts, making it increasingly difficult to schedule tests at the Blast Test Site. Furthermore, the success of biomechanical modeling in understanding and predicting blast injury greatly reduced the need for new animal studies. Consequently, in 1998, the Blast Test Site in Albuquerque, New Mexico, was closed.

Although the original questions about blast injury had been answered, data that had been collected for more than four decades of research could never be reproduced. With this realization, Colonel Karl Friedl identified materials of irreplaceable historical value (eg, the original investigator notes from studies conducted at Hiroshima) and sent them to national libraries. Other remaining materials were shipped to Jaycor for safekeeping.

Under MOMRP support, these blast data are undergoing sorting, cataloging, and electronic preservation. Figure 10-13 provides an example of the data that can be retrieved from the database with IISYS software (Jaycor, Inc). This process continually supports MOMRP's ongoing blast injury programs, including the refinement and extension of INJURY software, the refinement of HHA software for occupational exposure, and studies of injury from thermobaric explosives.

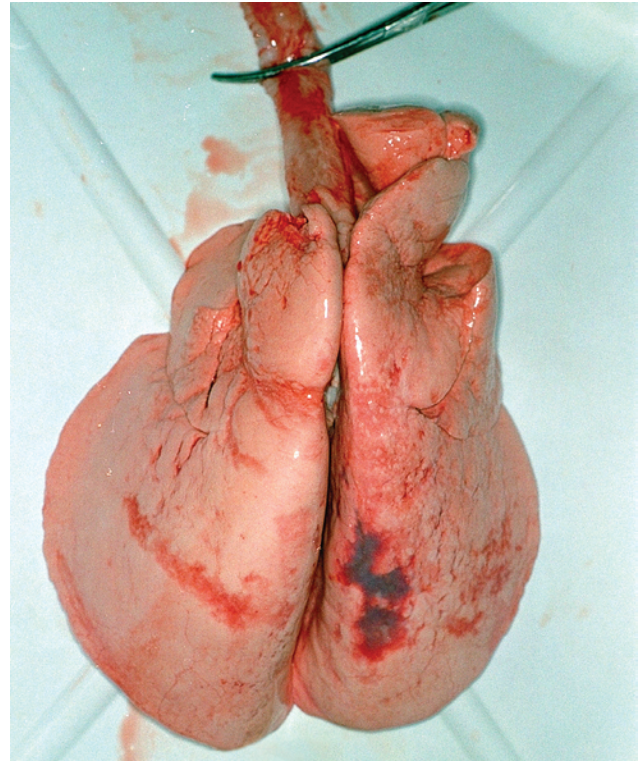

Fig. 10-13. Example of blast injury data retrieved and displayed using IISYS software.
Photograph: Courtesy of L-3/Jaycor, San Diego, California.

THIRD-GENERATION INJURY MODELING

The third generation of injury modeling expands the anatomical and physiological fidelities of the injury process. These models use finite element analyses to capture the mechanical response of the body to blast trauma, and high-fidelity, systemic simulations to capture the physiological response to inhaled toxic gases. Finite element models allow predictions of regional injury patterns and the effects of protective clothing. Physiological models extend the effects of blast to include inhalation injury, incapacitation, and delayed lethality.

Finite Element Modeling

FEM is a mathematical tool developed for analyzing engineering structures that is finding increasing application in biomechanics and trauma assessment. The approach breaks the object to be studied—in this case the human body—into small volumes or elements. The elements correspond to parts of different tissues or organs, and they can be irregular in shape so that the anatomy is accurately represented. Because each

element represents part of a single tissue, its mechanical properties are considered uniform. Each of the elements interacts with its neighboring elements through the common boundaries. As one element moves and changes shape, these forces and motions (stresses and strains) are transmitted to neighboring elements.

A simulation begins with application of an external loading, from the blast overpressure or a projectile impact, and the calculation advances in time to the motion and distortion of the whole body and all of its internal elements. Every part of each tissue experiences stresses and strains as the body responds to the external load; when those quantities exceed the material strength of the tissue or the organ, damage occurs. The power of the FEM approach is that, in principle, if the anatomy is adequately resolved by enough elements, if the material properties of each tissue are adequately known, and if the limiting stress/strain is known, then injury from any trauma can be predicted.

Each of these aspects (geometric features, material properties, and failure limits) are only imperfectly known, however, so FEM is still very much an art. First, the human body is extremely complicated, with structures on

every scale down to the cells; consequently, it is not possible to generate a complete anatomical representation. Judgment must be used to resolve the anatomical features that are most important for the process being studied. Second, almost no biological tissue is truly homogeneous; rather, it is made up of finer structural elements that make the apparent material properties dependent on the scale of elements being used. Again, judgment is needed to select material "constitutive" relations and their parameters that will capture the most relevant responses at the scales of interest. Finally, most tissues, because of their complex composite nature, do not have simple failure stresses and strains. The mechanism of damage can be partial, cumulative, and sometimes self-correcting. Furthermore, the most important damage is often functional, rather than structural, so that simple mechanical failure is not the critical endpoint. For example, rupture of a blood vessel can either lead to a small blood loss that is self-correcting or it can lead to a fatal hemorrhage, with only a slight difference in the extent of the material failure.

Despite the considerable challenges facing the application of these engineering concepts to biological systems, powerful results have been achieved and, in time, many of the difficulties noted previously will be overcome by the relentless increase in computational power.

Finite Element Modeling in Blast Injury

One of the first applications of FEM to blast injury was the study of wave propagation in the lung under blast loading.^{30,60} This work was conducted when FEM software was in its infancy, but was able to demonstrate the critical nature played by the lung's unique material properties on concentrating and distributing loading. The lung, because it has the compressibility of air but a density 100 times greater than air, has a very low speed of sound—only about 30 to 40 m/s. When the chest wall moves at a fraction of that speed (eg, 10 m/s), considerable pressures can build up at the inner surface of the thorax wall. When the velocities become greater than 20 m/s, the equivalent of shock waves can be produced that are very destructive. These insights helped guide the early INJURY software models.

The next application was rupture of the tympanic membrane.⁶¹ In this case, the geometry of the affected organ is far simpler than other parts of the body. The mechanical structure of the outer ear consists of the tympanic membrane, a tissue of well-known geometry and material properties; the ossicular chain, again with well-known geometry and properties; and the cochlea that, although it has complex internal structure, acts only as a flexible base for purposes of determining the load on the ear drum. This model was able to provide a biomechanical explanation and a predictive model for

tympanic membrane rupture. It even explained some of the unique tearing patterns seen in this kind of injury.

The first application of FEM to the whole thorax was used to calibrate the Lobdell model that was described previously. The Lobdell model is a nonphysiological model of thorax response under impulsive loading. The model specifies a mass of the sternum region, but not an area. Because blast waves apply a pressure (force/area) to the body, it is necessary to determine the area that corresponds to the Lobdell model mass so that the model can be used to compute the chest motion. For this purpose, a FEM of the human thorax was constructed from the Visible Human Project data set. The anatomical detail was quite limited, with the model only resolving the chest wall, lung, heart, and diaphragm. Because these are composite tissues, material properties were estimated from composites of the underlying tissue materials. The model was calibrated against human cadaver studies using impact masses. From these simulations, the Lobdell model could be reinterpreted in terms of the true physiological elements and, in particular, the equivalent area of loading determined. This model was then used to study blast loading, and a correlation was developed to translate pressure loading into forces that could be applied to the masses in the Lobdell model. This key correlation forms the basis of the INJURY software, versions 5.0 to 7.1.

The joint research program between MOMRP and NHTSA on blast and car crash injury produced a series of finite element models of the human skull that were used to set skull fracture injury criteria. Here, the geometry is relatively simple and can be accurately determined by medical imaging. Jaycor developed mathematical transformations to produce FEM models of the skull directly from imaging, including the resolution of the composite structure of the inner and outer tables and the diploe.⁶²⁻⁶⁴ These studies produced biomechanically based head-injury criteria that could be used in the automotive field for impact against large areas (windshields) and for tertiary blast injury. These same biomechanical models are used to predict focal skull fractures that arise from the head hitting very small protrusions or the secondary blast projectiles.⁶⁵ These models are also being used to study the effects of head protection⁶⁶ and the creation of a single skull fracture criterion for all insults. These models are used in the ITBM.

These four examples of FEM application were developed to improve or validate other simpler injury models and correlations. Beginning in 2000, MOMRP began a program with Jaycor to model the blunt trauma that occurs behind body armor when the armor stops a high-speed bullet with FEM as the final product. These models reproduce the anatomy in far greater detail than used previously, and required new medical imagery and new mathematical treatment to analyze, segment, and build robust elements. The models developed have

been validated with animal tests in which medical imaging is used to produce subject-specific models that are validated against instrumented animal tests.

Starting in 2003, MOMRP and JNLWD formulated a collaborative research program to apply these high-fidelity thoracic response models to the impact of projectiles. The result is ATBM, which uses finite element simulation to determine rib fracture and lung contusion based on projectile-specific, subject-specific, and location-specific conditions. JNLWP uses ATBM to provide the most accurate estimate of nonlethal weapon effects. The same model increases the fidelity of estimation of secondary blast injury.

In addition to better biomechanical response, ATBM computes the trajectory and impact locations of projectiles, including the determination of impact locations on individuals in a crowd. This capability, when applied to secondary blast injury, allows for computing the statistics of both injury locations and injuries under realistic combat conditions.

INJURY Software, Version 8

The latest version of INJURY software, released in 2005 from the MOMRP Web site, introduces further anatomical refinement (Figure 10-14). Account is taken of the fundamental anatomical difference between sheep (narrow chest, wide sides—for which the majority of the injury data have been determined) and humans (broad chest, narrow sides—for which the model is applied). In addition, body orientation is accounted for by distinguishing the front and back in the Lobdell model. This generation of the model has been validated against Blast Test Site data that have been carefully quality checked, and the code offers a red-yellow-green characterization of the relative hazard of the blast exposure.

Toxic Gas Inhalation

In addition to the mechanical blast injuries, explosives produce toxic gases that, when inhaled, can lead to disorientation, incapacitation, or death. Both health hazard and survivability assessments require a means to estimate the probability of these endpoints from exposure to gases generated by blast or the resulting fires.

The Live Fire Test Program (LFTP; Director of Operational Test and Evaluation) is a US Department of Defense organization responsible for overseeing and evaluating the survivability of US systems and vehicles from enemy weapon systems. In 1994, the LFTP invited MOMRP to participate in the formulation of human effects from enemy weapon fire in the areas of blast and toxic gas. MOMRP entered into a series of projects with Jaycor to evaluate existing toxic gas exposure standards,

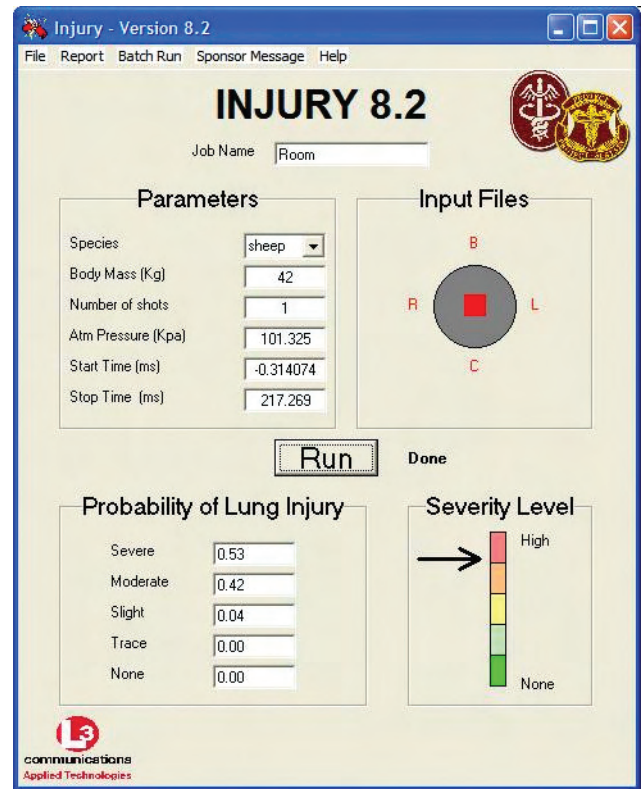

Fig. 10-14. INJURY software, version 8.2, used to estimate lung injury from blast exposure. Photograph: Courtesy of L-3/Jaycor, San Diego, California.

identify shortcomings, and demonstrate improvements that could be made in the near term to assist the LFTP. Small animal tests were conducted that highlighted the shortcomings of existing standards.⁶⁷ These projects resulted in the airway blood chemistry model that was used to expand toxic gas survivability assessments. This work identified that the shortcomings of existing standards arose from their lack of a physiological basis, both to scale results from animals to humans and to account for critical physiological responses.

Following this initial evaluation, an effort to develop a detailed physiological model of the body's response to toxic gas inhalation was undertaken. This effort produced a series of source books that reviewed and summarized existing models and experimental data from which the research effort had been planned. The first book of this series reviewed all previous models, mechanisms, and assessments of biological effects caused by toxic gas inhalation.⁶⁸ The all-existing test data—from books, reports, and papers—were collected in a second book.⁶⁹ These data were digitized and analyzed to evaluate current standards and to identify missing data that would be needed to construct a physiologically based model. The third book

of this series reviewed all control-of-breathing models, because ventilation was the dominant physiological factor missing from previous models.⁷⁰

These reviews clearly identified the lack of knowledge of ventilation changes that occur during toxic gas inhalation; thus, an extensive series of small animal tests have been conducted at WRAIR and at the Lovelace Respiratory Research Institute (Albuquerque, NM). These studies on ventilation effects, coupled with a compilation of thousands of previous animal tests on incapacitation and lethality, provide the basis for developing physiologically based models.

The first version of the Toxic Gas Assessment Software (TGAS, Jaycor, Inc) provides estimates of immediate incapacitation from any combination of seven toxic gases: (1) carbon monoxide, (2) hydrogen cyanide, (3) hydrogen chloride, (4) nitrogen dioxide, (5) acrolein, (6) low oxygen, and (7) carbon dioxide. The gases can vary in concentration over time, and TGAS accounts for animal species, mass, and activity. TGAS estimates ventilation changes and tissue absorption to compute a body-weight-normalized internal dose, accounting for all of the factors described previously. The normalized internal dose is used to determine a dose-response curve that is species and exposure independent. The model predicts the probability of immediate incapacitation that can provide a toxicological assessment of survivability for both military and civilian applications.⁷¹

TGAS version 2.0 provides estimates of immediate incapacitation and immediate and delayed lethality from combinations of these same gases.⁷² Many irritant gases produce lung injury that can lead to death long after exposure. Because the exposure levels that can cause these effects might be much smaller than those that cause incapacitation, it is necessary to set standards based on the most limiting condition.

Explosions often occur in enclosures or vehicles that have fire suppression systems. These systems often contain halide compounds, which can break down by pyrolytic processes and introduce acid gases into the enclosure atmosphere. These acid gases are toxic themselves and have a strong effect on ventilation. Furthermore, the explosion can cause secondary fires that release other complex toxic gases. The combination of these primary and secondary effects of explosions leads to an even more complex mixture of noxious gases that must be considered to determine incapacitation and lethality.

In the past 30 years, physiologically based pharmacokinetic (PBPK) models have been developed to describe the physiological effects of the inhalation of harmful organic gases. These models are used to set internal dose limits, based primarily on blood con-

centration levels, for each compound. This internal dose approach allows animal data to be scaled to humans and allows effects due to time-varying gas concentrations to be estimated from data collected under constant conditions. The primary use of PBPK models has been in setting short-term environmental exposures, but these results are readily assimilated into the TGAS framework.

The first step taken was to survey the current literature on PBPK modeling and the known mechanisms of interaction of halocarbon materials with the body. The development of PBPK models involves replicating with mathematics the transport, metabolism, and elimination of inhaled chemicals. Furthermore, the chemical and physiological parameters used by these models must be estimated from *in vitro* tissue measurements or limited animal testing. These quantities generally have large variations in their values and require a systematic means to come to a single, accepted value. The mathematical basis for PBPK models, their variation in application, the techniques for establishing parameter values, and the methods for interpreting and using the results are summarized in a comprehensive source book.⁷³ Although PBPK models are used in many aspects of physiology, considerable literature exists just for halocarbons. Not only are these substances important to fire-extinguishing applications, but also many are ozone depleting and are being eliminated from global use for environmental reasons. The sheer number of possible compounds that vary in importance—depending on their environmental impact, chemical composition, and/or pyrolytic effects—makes this area extremely complex. These compounds and the PBPK models that have been developed to understand their biological effect are discussed in a second source book.⁷⁴ Finally, not only are the chemical and biological impacts of these substances complex, but also so is the regulation that controls their use and replacement. Because devising appropriate fire protection schemes is a component of blast mitigation, the regulatory landscape of this complex area is analyzed and summarized in a third source book.⁷⁵

PBPK models include a respiratory component that determines the amount of chemical inhaled during the exposure. Because these models have been developed at different times and by different researchers, there is little consistency in the selection of normal physiological parameters, especially ventilation. Furthermore, all of the models assume that ventilation is unaffected by the gases inhaled and ignore any interaction in ventilation caused by gas mixtures. A PBPK model (which uses common physiological parameters) has been developed that has been recalibrated against all halocarbon test data available in the literature. Furthermore, this model

has been coupled to the TGAS version 2.0 model for describing ventilation changes from chemical and exercise effects. The combined model can analyze more than 30 gases in combination and is designated TGAS version 2.0P.⁷⁶

TGAS versions 1.0 to 2.0P account for ventilation changes with factors that vary with the external concentrations of the gases. The animal studies, however, show that these ventilation changes vary with time in a complex way. Many of the changes do not occur for several minutes in small animals, corresponding to the time required for critical blood chemistry changes to occur. Because of large differences in the ventilation-to-body mass ratio between small animals and humans, these effects might take longer to occur. Because some toxic gases suppress ventilation, whereas others enhance it, ventilation is critical to properly account for the temporal and species effects in extrapolating small animal results.

To account for these complex ventilation changes, a Dynamic Physiological Model (DPM) was developed.⁷⁷ The DPM includes models of ventilation, circulation, and metabolism and, most importantly, models of the neural control systems that govern these processes. The neural controls are driven, in turn, by blood chemistry changes

sensed by chemoreceptors in the carotid arteries and the medulla oblongata of the brain. Consequently, the DPM contains extensive blood chemistry models and models for the metabolism in the brain. This model reproduces most of the significant ventilatory changes seen in animal tests and provides a physiologically based means to extrapolate these critical changes to humans (Figure 10-15).

Blast Effects Behind Body Armor

As the US military is engaged in urban and asymmetric warfare, soldiers are increasingly exposed to blasts from nonmilitary explosives. In the Afghanistan and Iraq conflicts, nearly 65% of all casualties are from blast injury. Because of the concern that ballistic body armor may have some unexpected amplifying effect on blast injury, the Natick Soldier Center (Natick, Mass) has teamed with MOMRP to make a scientific determination of the effects of body armor on blast injury.

MOMRP is assisting this effort in two key areas. First, the considerable experience of WRAIR in animal tests has been applied to assisting the Natick Soldier Center to conduct animal tests that will provide hard evidence of the effect of blast on armor and the resulting injury.

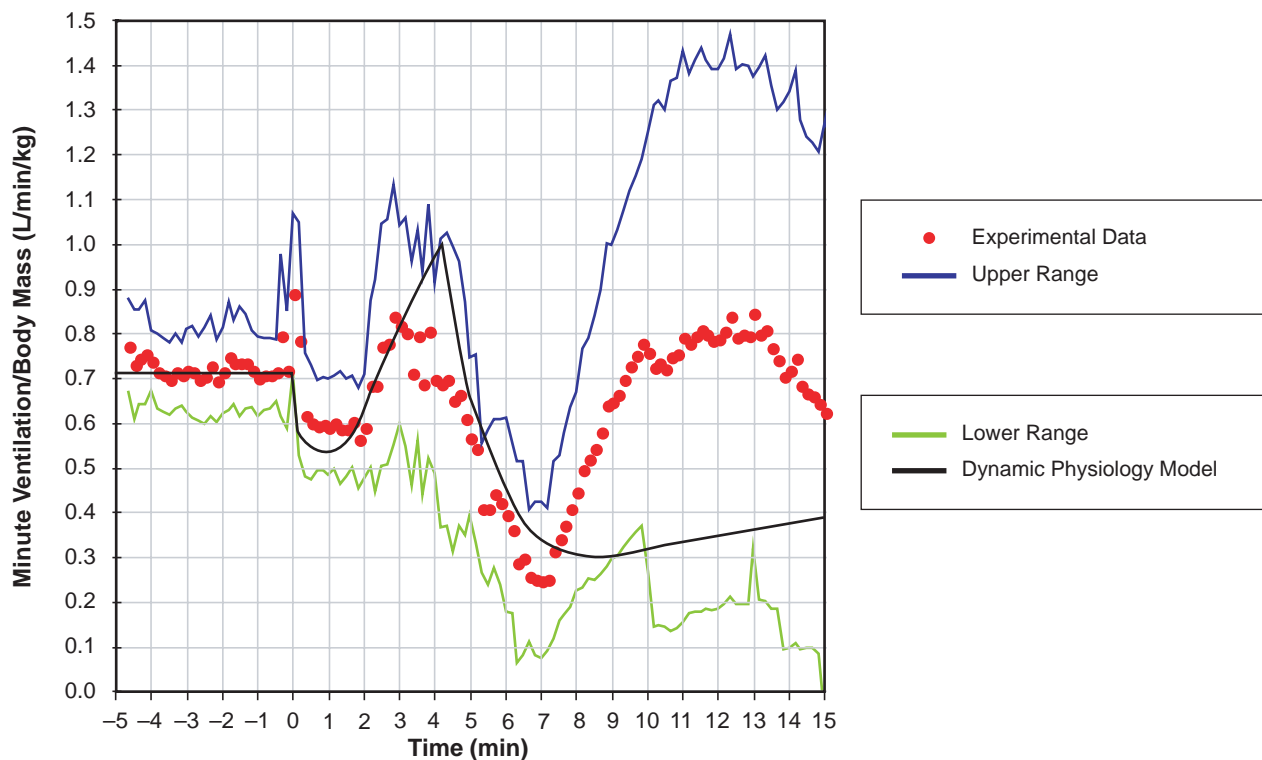

Fig. 10-15. Ventilation response to acute carbon monoxide exposure. Illustration: Courtesy of L-3/Jaycor, San Diego, California.

The experience of Jaycor is being used to analyze test data, utilize mathematical models to interpret animal results, and extrapolate the findings in humans. This effort is providing further validation of the INJURY software model, especially in extreme environments where lethality occurs.

FOURTH-GENERATION INJURY MODELING

The fourth generation of injury modeling *integrates* mathematical models of the mechanical response of the body with those describing the physiological and systemic responses. These integrated models will predict physical and cognitive performance consequences, not just pathological outcomes, and will address neurocognitive injury that occurs through secondary processes. These models are important steps toward a complete, quantitative understanding of biological response to all traumas.

Performance Endpoints

Previous modeling of blast effects has focused on predicting injury and lethality. Although these are important endpoints, they do not characterize the complete hazard caused by blast nor the full operational impact. At exposures far less than required to produce immediate incapacitation and death, blast can degrade the physical and mental performances of the warfighter, with the consequence that he may be unable to accomplish the mission or to protect and defend against other lethal threats.

The goal of the Physical and Cognitive Performance Modeling Project is to develop and validate mathematical models that predict these performance endpoints. The work will combine the finite element models used to characterize the physical damage of blast trauma with the DPM used to characterize the physiological consequences. The integrated finite element model consists of models that describe the head, neck, thorax, and abdominal regions (Figure 10-16). The DPM is used to estimate oxygen delivery and incapacitation in hypoxic and toxic gas exposures⁷⁸⁻⁸² (Figure 10-17). Integration of these two modeling systems will produce a complete description of the physical and physiological responses to blast trauma.

Central Nervous System Injury

The possibility that blast is responsible for the traumatic brain injury (TBI) observed in returning warfighters has become an issue of national importance. Similar concerns exist in sports and automotive safety. Blast-induced TBI involves a complex and not fully understood mechanical pathway that is different from that encountered in civilian settings. The ability to assess the magnitude of this risk, prevent its occur-

To support armor evaluation, a specialized BTM to measure the force under clothing and armor is being developed. This new device, coupled with a new series of INJURY software models, will provide the assessments needed to determine the vulnerability of current protection systems.

rence, and detect and diagnose it may be enhanced by a predictive methodology that can link traumatic events to meaningful neurocognitive measures and clinical

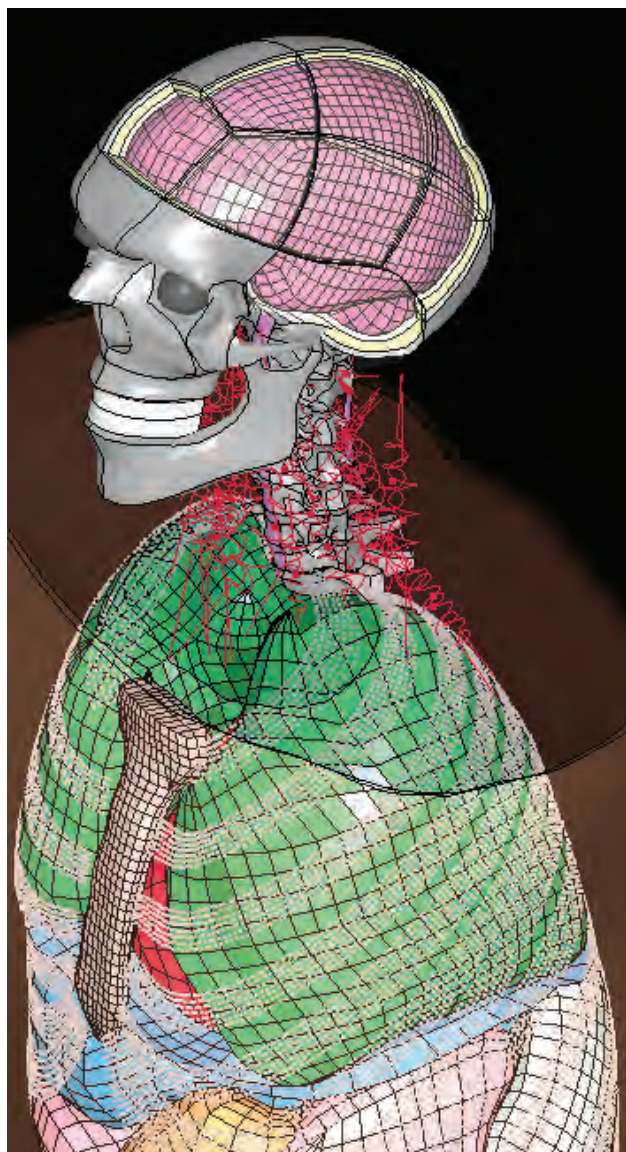

Fig. 10-16. Integrated finite element model of the head, neck, thorax, and abdominal regions. Illustration: Courtesy of L-3/Jaycor, San Diego, California.

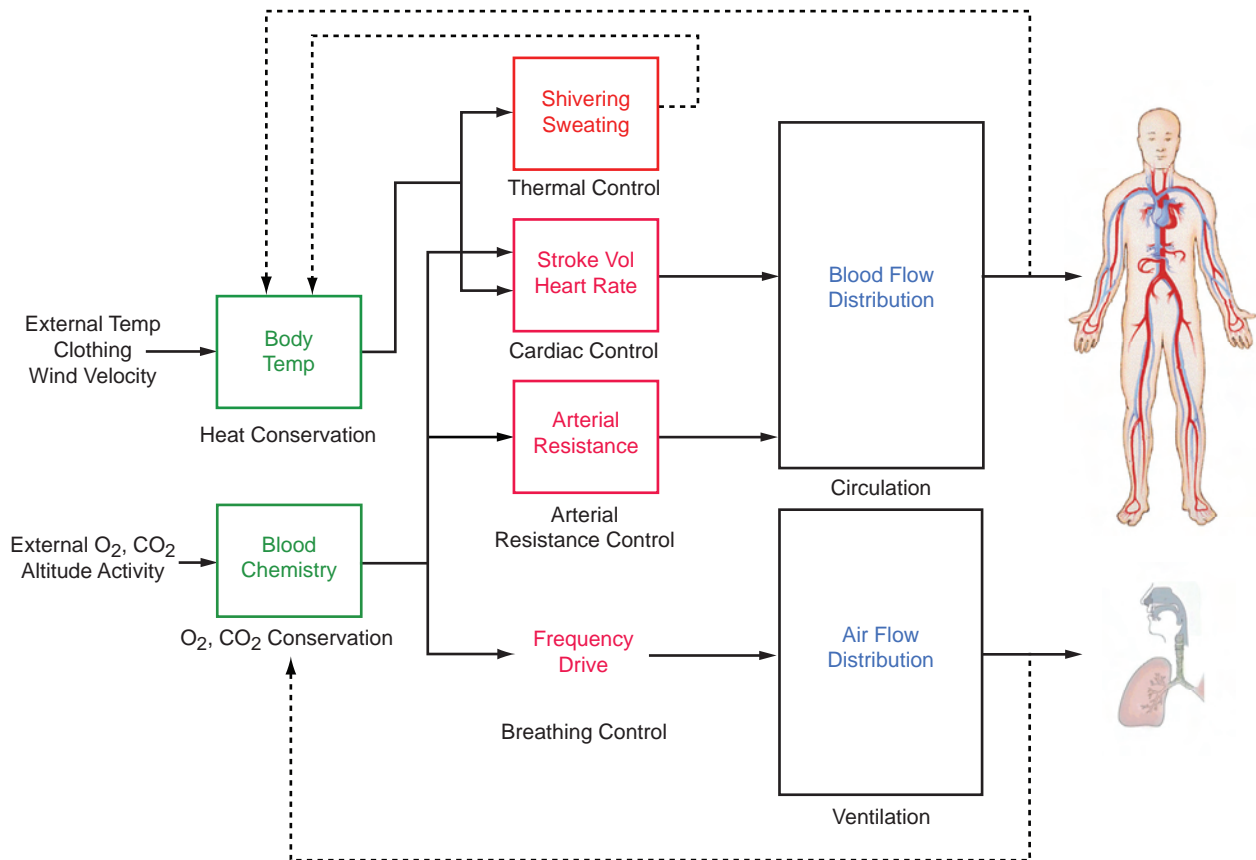

Fig. 10-17. Schematic diagram of circulatory and respiratory systems in the Dynamic Physiology Model. Temp: temperature; Vol: volume
Illustration: Courtesy of L-3/Jaycor, San Diego, California.

outcomes. The Predictive Model of the TBI project will use focused laboratory and clinical tests to strengthen the links in the causal path and mathematical modeling to tie the links together into a usable predictive methodology.

Epidemiological data from Operation Enduring Freedom/Operation Iraqi Freedom (OEF/OIF) are correlating mild TBI to blast. A recent study indicated that 59% of blast-injured patients from OEF/OIF admitted to Walter Reed Army Medical Center had at least mild TBI.⁸³ In that study, data were provided by Dr Deborah Warden, Director of the Defense and Veterans Brain Injury Center, based on patients seen at Walter Reed Army Medical Center. Of the 450 patients with brain injuries treated between January 2003 and February 2005, most brain injuries were caused by IEDs, and closed-brain injuries outnumber penetrating ones. It is believed that cases are likely underreported because of lack of prompt diagnosis. Mild TBI adds a significant, long-term challenge to patient recovery and rehabilitation, especially when other permanent

disabilities are involved, such as loss of extremities that require the patient to learn new skills. It has also been observed that mild TBI from the current conflict accounts for a larger proportion of casualties than in other recent US wars.

Extreme head trauma from blunt impact leads to massive damage and hemorrhaging that have been studied extensively. Thresholds for high-mass, low-speed impact head injury have been based on tissue pathological observations in primates and postmortem human subjects. Although these thresholds are not based on biomechanics and neurological modeling, they have served the automotive safety needs. Mild TBI is now being seen in returning soldiers, as well as in sports, and has a far more subtle injury mechanism, a more subtle clinical outcome, and a much lower threshold. Thresholds for these lower level injuries will not be developed readily from epidemiological data alone and are not easily studied in animal models. A greater understanding of the underlying mechanical processes will be required. Furthermore, blast presents

additional challenges because the primary mechanism of action is not blunt impact to the head, may involve other mechanical pathways, and is far more rapid than almost all previous head injury causes.

Causal Links of Trauma-Caused Brain Injury

It is generally accepted that TBI is caused by local mechanical stresses in the brain that disrupt neural cells and tissues (primary injury), which, in turn, leads to functional disruption through metabolic and biochemical processes (secondary cascade), resulting in the clinically observed neuropsychological consequences. Although the physical, chemical, and neurological processes are not rigorously quantified, there is ample evidence that the primary injuries lead to the neurological consequences that are seen in patients with TBI.

Mechanically caused primary injury has been observed in animal models for both impact and blast trauma. In blast animal models, astrocyte and microglial responses have been seen,^{84,85} as well as changes in apoptotic mechanisms.⁸⁶ Histological studies have detected degenerating neurons in the cerebral cortex and hippocampus of rats 1 and 5 days after blast exposure.^{87,88} Evidence of ultrastructural and functional changes following blast neurotrauma has also been observed.^{88,89} Chemical alterations leading to motor and cognitive dysfunction follow diffuse TBI in rats.^{90,91} In isolated tissue tests, injury to cells resulting from the application of rapid mechanical forces has been observed in endothelial cells,⁹² in axons,^{93–96} and in cortical astrocytes and neurons.⁹⁷ Evidence of tension as a regulator of axonal activity has also been observed.⁹⁸ In addition to tension and shear-induced cellular injury, there is also evidence of cellular damage from direct pressure effects. Cavitation, which has been shown to occur at moderate head acceleration, leads to large local pressures (thousands of atmospheres) upon vapor bubble collapse.⁹⁹ This mechanism has been confirmed in lithotripsy studies.¹⁰⁰ Depolymerization of spindle microtubules has been observed at very high static pressures (680 atm) and in ultrasound exposures (low-pressure amplitudes, but rapid fluctuations).

The blast-induced primary mechanical damage to cellular structures starts a secondary cascade of effects, including ion channel disruption, apoptosis, and necrosis. These secondary processes lead to functional and metabolic dysfunctions that are observable in advanced magnetic resonance imaging (MRI). Quantification of the link between observable microscopic damage and MRI parameters is the fourth link in the predictive chain. Observation of secondary brain injury, in the form of biochemical alterations, has

been observed in blast injury.^{101–104} More importantly, however, it is well known that secondary injury is a complex cascade of physiological events caused by the residual metabolic, biochemical, endocrinological, and immunological alterations initiated by primary injuries.^{105,106}

These secondary effects are readily observable with magnetic resonance spectroscopy (MRS). MRS is a powerful in vivo method to detect neurochemicals within the brain that are relevant to brain processes. The most widely used methods are ¹H-MRS and ³¹P-MRS that detect compounds with hydrogen and phosphorus. Recent studies have shown that the absolute concentrations or ratios of concentrations, particularly *N*-acetyl aspartate (NAA), correlate with neuropsychological tests, cognitive dysfunction, and early detection and longitudinal change.¹⁰⁷ MRS has provided correlates with the following:

- cognitive decline in the aging brain,¹⁰⁸
- cognitive outcomes in children,¹⁰⁹
- the Wechsler Memory Scale;^{110,111}
- genetically based Williams syndrome;^{112,113} and
- diseases such as bipolar disorder,^{114,115} Alzheimer's,^{116,117} and schizophrenia.¹¹⁸

MRS has correlated with posttraumatic stress disorder (PTSD) in combat veterans,^{119–121} combat veterans with evidence of biochemical change,¹²² prisoners of war,¹²³ and nonprisoners of war.¹²⁴ In some studies, however, patients with PTSD did not score differently on attention, memory, or learning tests,¹²⁵ nor did they show lower levels of NAA.¹²⁶ Proton MRS also has mood disorders.^{127–133} MRS imaging has correlated with functional independence measure,¹³⁴ Glasgow Outcome Scale, and neuropsychological performance.¹³⁵

Blast Traumatic Brain Injury Mechanisms

Once mechanical stresses have created primary cellular injury in the brain tissue, subsequent biochemical, metabolic, and neurological processes will lead to neurocognitive dysfunctions and adverse clinical outcomes. The unique challenge of blast TBI is to determine how the external stressors (mechanical, chemical, and electrical) created by exposure to explosions create and amplify those of primary cellular injury. The Predictive Model of the TBI project will build on the 25 years of blast model experience and tools to determine a quantitative connection. The following sections frame the nature and magnitude of the blast stressors that are likely to be involved in blast TBI.

Characterization of Blast Exposure

Blast injury is initiated by the mechanical loading of the blast wave on the body, with secondary effects of the toxic gas and electromagnetic pulse released by the explosive. The strongest blast waves for which there is a high probability of survival have a peak pressure of ~20 atm and a duration of a few milliseconds. Using CFD and data compiled in the Blast Overpressure Database, there is adequate information to characterize blast threats faced by US warfighters and to select conditions that will be meaningful for laboratory investigation. Characterizing the blast effects is the first step in developing an end-to-end predictive model.

IEDs can span an explosive energy range from the equivalent of a few pounds of TNT (trinitrotoluene) in pipe bombs to thousands of pounds in truck bombs. Distances from these explosions to the warfighter can also vary, and the blast loading can be amplified by reflections inside enclosures. The ranges of interest for studying TBI, however, are those exposures that will not otherwise produce severe injury or death. The biomechanically based INJURY software, used throughout the military to estimate blast injury for all levels from occupational exposure limits to survivability estimates,¹³⁶⁻¹³⁸ is used to select exposure conditions that are in a meaningful range (Figure 10-18). Based on INJURY analyses and confirmed by the extensive blast

overpressure data repository, it is concluded that the strongest blast waves for which there is a high probability of survival have a peak pressure of about 20 atm and a duration of a few milliseconds.

Pathway of Internal Disturbances

Acceleration of the brain from direct blast loading to the head or a surge of blood into the brain from blast loads to the torso can produce pressure excursions, flow pulses, and mechanical stress far outside the normal physiological range that can cause tissue and cellular damage. Furthermore, temporary disruption of oxygen delivery from immediate neurological response and electrical disruption of cellular processes from the explosion-generated electromagnetic pulse may further compound these primary injuries. Modeling these pathways is a critical part of building a Predictive Model and designing protective solutions.

Acceleration Effects. A blast wave travels at ~300 m/s, so one side of the head/body is affected a fraction of a millisecond before the other. This differential pressure can accelerate the head, and simulations show that, at the maximum survivable peak values, the head can be accelerated up to 300 g's. Jaycor has determined that the threshold for mild TBI, based on sports injury reconstruction,¹³⁹ is 50 g's, so that head acceleration from blast is certainly a potential injury pathway. Ac-

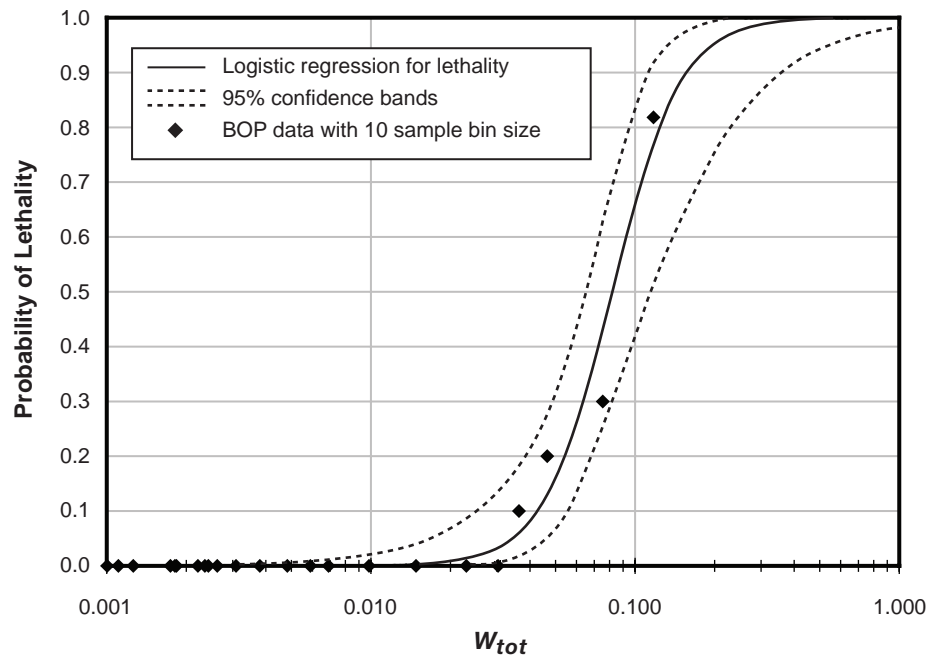

Fig. 10-18. INJURY correlation of lethality. BOP: blast overpressure; W_{tot} : W_{sum} corrected for the number of exposures. Illustration: Courtesy of L-3/Jaycor, San Diego, California.

celeration also introduces a hydrostatic pressure gradient in the brain, with a pressure difference equal to the acceleration \times density of the brain \times half the width of the brain. For a 300 g acceleration, the brain could experience regions of compression as great as 3 atm on the impact (coup) side. Accelerations greater than 80 g's are capable of lowering pressure in the brain to a point wherein cavitation occurs on the opposite (contrecoup) side. Collapse of the vapor bubbles can lead to large pressures in excess of 1,000 atm,¹¹⁶ which can cause considerable local damage. This phenomenon has been demonstrated in surrogate models and in mathematical simulations,^{140,141} and is one of the primary injury mechanism candidates in head impact.¹⁴⁰⁻¹⁴⁶ Simulations further show that small flexure of the skull can extend the cavitation to large areas of the brain.¹⁴¹ The biomechanical FEM of the head provides a way of translating external loading into stress in the brain tissue (Figure 10-19).

Vascular Surge. Distortion of the thorax and abdomen is observed under blast loading, arising from the presence of air-containing organs in the torso. In the thorax, the inward moving chest wall produces a compression wave in the lung that not only does dam-

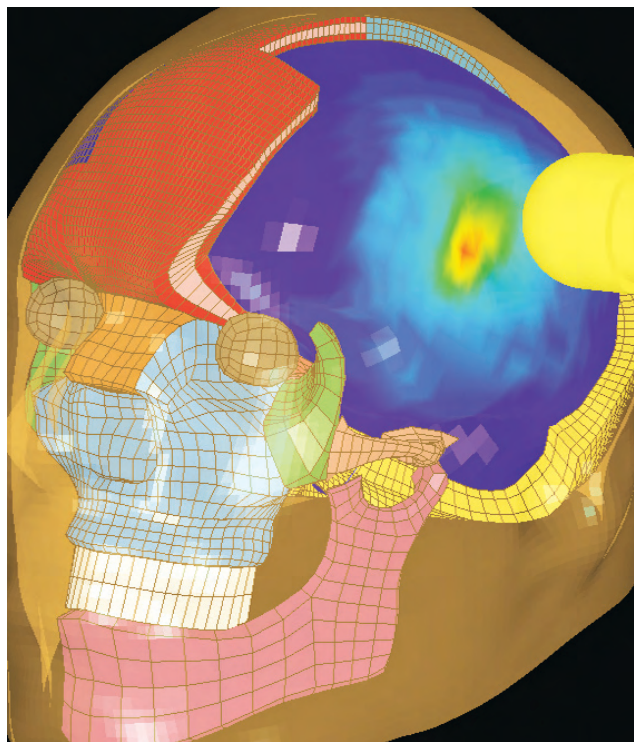

Fig. 10-19. Deformations of the skull coupled with head acceleration can create regions of high stress concentration within the brain.

Illustration: Courtesy of L-3/Jaycor, San Diego, California.

age to the lung tissue, but can also exert a compressive force on the heart. The application of blast loading to the abdomen produces a direct coupling, through the abdominal contents, to the diaphragm, leading to an upward motion that also exerts a force on the heart—a “blast punch to the gut.” Both of these processes can lead to a surge in blood flow. Brain injury from blast animal models, whose heads were protected from the direct blast,¹⁰⁰ might be explained by this mechanism. Finite element analysis shows that a 20-atm blast loading against the torso produced a small, volumetric surge of blood from the heart of about 0.2 mL as a result of the load transmitted to the heart through the lungs; but it also produced a 10-mL surge as a result of loading delivered through the abdomen (Figure 10-20). Assuming the normal distribution of blood flow, about 2 mL of the surge will be delivered to the brain. When this volumetric surge reaches the brain, the sudden increase of blood volume produces a subsequent pressure increase. Simulations using the L-3/Jaycor head model estimate that an intracranial pressure of nearly 10 atm can result. Combined with the increased crushing effect of personal body armor, this mechanical pathway is being studied in the project.

Mechanical trauma caused by the blast waves, blast winds, or secondary impacts is most likely the primary cause of TBI. Nonetheless, there are auxiliary effects that are associated with explosives that could augment or aggravate the mechanical injury.

Hypoxic Effects. It is commonly observed that animals exposed to blast suffer disruptions in ventilation and cardiac output for 10 s following blast exposure and reductions of these outputs that persist for many minutes. In addition, explosions produce noxious gases that have other acute effects on these processes. In our studies, the effect of toxic gas on oxygenation of the blood has shown that brain ischemia effects can occur in minutes under acute conditions. This process has been quantified with the DPM.¹⁴⁷

Electromagnetic Pulse. The overpressure of the explosion accelerates hot, ionized gases in the fireball to a velocity exceeding the ambient speed of sound, and the rapid motion of charged particles results in a radiated electromagnetic pulse (EMP). Soloviev et al^{148,149} provide a summary of field data collected from conventional high explosives (1–5 kg) and a theoretical model that can be used for extrapolation. They conclude that, in the far field of these explosions, the electric field component of the EMP acts as an electric quadrupole—that is, the strength decreases as the fourth power of distance—with strength proportional to the explosive weight.

It is well established that significant thermal effects are produced from continuous, incident power levels greater than 100 mW/cm². At this flux of energy, the

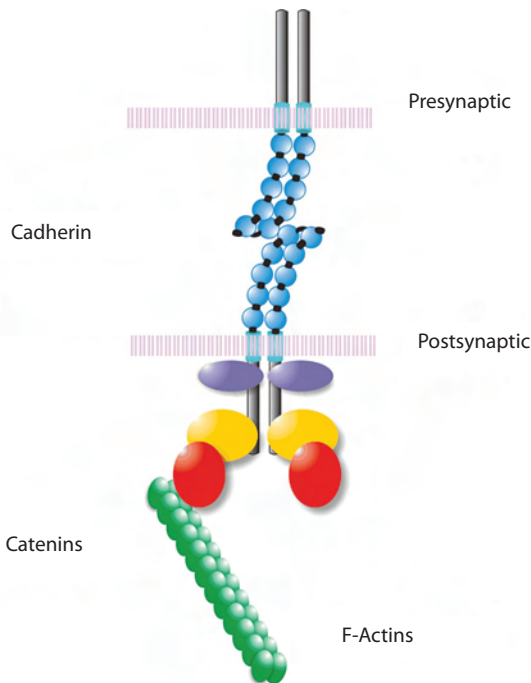

Fig. 10-20. Schematic diagram of mechanical response model for binding structures in neurological cells. Illustration: Courtesy of L-3/Jaycor, San Diego, California

body cannot dissipate the heat rapidly enough, and tissue temperatures rise, leading to a wide range of physiological effects and damage. A few tests have looked at nonthermal effects on cerebral tissues of short duration-pulsed exposures (perhaps like repeated blast exposure) or modulated high-frequency exposures. Servantie et al¹⁵⁰ saw changes in the electroencephalogram in rats at pulsed exposures: 0.1- μ s pulses, average power 5 mW/cm²; and 500 to 600 pulses/s, for 10

days. Bawin et al¹⁵¹⁻¹⁵⁴ observed changes in Ca²⁺ release in chicken cerebral tissue after 10 minutes of exposure to 0.75 mW/cm² of modulated 450 MHz radiation, which is an energy dose of 450 mW-s/cm². At 10 m from a 100-kg explosive, the blast wave is predicted to produce only 1% lethality, whereas Soloviev's relation predicts that the EMP energy dose will be about 500 mW-s/cm². Therefore, there is a possibility that blast-generated EMP, under the right circumstances, may augment the Ca²⁺ channel disruption that is initiated by primary mechanical injury.

Biomechanical and Physiological Response Models

The Predictive Model of the blast TBI project will build on Jaycor's integrated finite element models of blast and trauma responses. Additionally, the parallel work to integrate FEM and DPM will greatly assist the blast TBI project. Surrogate, large and small animal testing, and clinical examination of civilian and military patients with TBI will provide quantitative data for each causal link and a validation of the overall predictive methodology.

The research partnership between USAMRMC and NHTSA has advanced finite element models of the head that combine anatomical geometry with the mechanical properties of the tissues to give a powerful calculation tool. This partnership has spurred a number of studies into dynamics of the entire brain,¹⁵⁵ tissue properties,¹⁵⁶⁻¹⁶¹ and individual cells.^{94,162} Because of the availability of high-resolution anatomy and dynamic tissue properties, the ability to determine local mechanical stresses within the brain is well advanced.

As in decades past, the USAMRMC/MOMRP foresight of developing fundamental mathematical tools to understand blast/trauma injury may allow an issue of national importance to be addressed quickly, with the potential for developing both a scientific understanding and a strategy for prevention and mitigation.

SUMMARY

For more than 25 years, MOMRP has been a world leader in the study of blast-related injury. This research has produced insights, data, and predictive models that set standards for human exposure, guide the design of protective systems, and allow quick responses to the questions generated in a rapidly changing battle environment.

The work of MOMRP continues to address the new blast issues of the 21st century. Together with its partners, MOMRP is researching injury to the central nervous system; protection of current body armor from emerging thermobaric weapons; and prediction

of performance decrement, both physical and cognitive, under the stress of blast and other trauma.

The decision (made decades before) to use mathematical modeling as a lens to focus the understanding of data; to guide future experiments; and to project understanding to complex, real-life scenarios on the battlefield has resulted in a capability that is responsive to new challenges. Furthermore, the ability to simulate biomechanical and physiological aspects of the body under traumatic circumstances can be applied to interests of health, safety, and performance of soldiers.

REFERENCES

1. Corrigan J. *The 48th Pennsylvania in the Battle of the Crater: A Regiment of Coal Miners Who Tunneled Under the Enemy*. Jefferson, NC: McFarland & Company; 2006.
2. Friedman TL. *From Beirut to Jerusalem*. New York, NY: Farrar, Straus and Giroux; 1990.
3. Petrouckevitch N. *Victims and Criminals: Schutzmannschaft Battalion 118*. Ottawa, Ontario, Canada: National Library of Canada; 2000.
4. Capaccio T. More US troops die in Iraq bombings even as armoring improves. Available at: <http://www.Bloomberg.com>. Accessed May 23, 2007.
5. Martinez BS. *Blast Overpressure Research Program, Kirtland AFB, 1951–1998*. San Diego, Calif: Jaycor, Inc; 1999.
6. White CS, Jones RK, Damon EG, Fletcher ER, Richmond DR. The biodynamics of air blast. In: *AGARD Conference Proceedings No. 88 on Linear Acceleration of Impact Type (Porto, Portugal)*. Albuquerque, NM: Lovelace Foundation for Medical Education and Research; 1971.
7. Bowen IG. *Biological Scaling in Primary Blast*. Albuquerque, NM: Lovelace Foundation for Medical Education and Research; 1965.
8. US Department of Defense. *Department of Defense Design Criteria Standard: Noise Limits*. Huntsville, Ala: US Army Missile Command; 1997: 107. DoD Military Standard 1474AD.
9. Kryter KD, Ward WD, Miller JD, Eldredge DH. Hazardous exposure to intermittent and steady-state noise. *J Acoust Soc Am*. 1966;39(3):451–464.
10. Ward WD, ed. *Proposed Damage-Risk Criterion for Impulse Noise (Gunfire) (U)*. Washington, DC: National Academy of Sciences, National Research Council Committee on Hearing, Bioacoustics, and Biomechanics; 1968.
11. Patterson JHJ, Mozo BT, Marrow RH, McConnel RW, Lomba-Gautier L. *Direct Determination of the Adequacy of Hearing Protective Devices for Use with the M198, 155 mm Towed Howitzer*. Fort Rucker, Ala: US Army Aeromedical Research Laboratory; 1985.
12. Patterson JHJ, Mozo BT. *Direct Determination of the Adequacy of Hearing Protection for Use with the VIPER*. Fort Rucker, Ala: US Army Aeromedical Research Laboratory; 1987.
13. Stuhmiller JH, Chan FWK, Chuong CJ, et al. *Test Planning, Collection and Analysis of Pressure Data Resulting from Weapon Systems*. San Diego, Calif: Jaycor, Inc; 1981.
14. Stuhmiller LM, Stuhmiller JH. *Analysis of Blast Overpressure Injury Data*. San Diego, Calif: Jaycor, Inc; 2000.
15. Stuhmiller JH. *The Mechanisms and Prediction of Primary Blast Injury of the Lung*. San Diego, Calif: Jaycor, Inc; 1990.
16. Stuhmiller JH, Phillips YY, Dodd KT. *Considerations in Developing a Mechanistically-Based Model of Blast-Induced Injury to Air-Containing Organs*. San Diego, Calif: Jaycor, Inc; 1986.
17. Yu JHY, Vasel EJ. *Experimental Investigation of Gastro-Intestinal Injury Mechanism*. San Diego, Calif: Jaycor, Inc; 1984.
18. Yu JHY, Vasel EJ. *Experimental Study of the Correlation Between Gastro-Intestinal Injury and Blast Loading*. San Diego, Calif: Jaycor, Inc; 1984.
19. Vasel EJ, Yu JHY, Stuhmiller JH. *Surrogate Models of Blast Dynamics of the Gastrointestinal Tract*. San Diego, Calif: Jaycor, Inc; 1987.

20. Vasel EJ, Yu JHY, Stuhmiller JH. *Modeling of the Non-Auditory Response to Blast Overpressure: Blast Dynamics of Surrogate Models of the Gastrointestinal Tract*. San Diego, Calif: Jaycor, Inc; 1990.
21. Stuhmiller JH, Yu JHY, Vasel EJ. Use of surrogate and analytical models to understand the parameters controlling blast injury to the gastro-intestinal tract. In: *Proceedings of the 3rd Workshop on Launch Blast Overpressure*. Aberdeen Proving Ground, Md: US Army Ballistic Research Laboratory; 1987.
22. Stuhmiller JH. *Modeling of the Non-Auditory Response to Blast Overpressure: Characterization and Modeling of Thoraco-Abdominal Response to Blast Waves*. Vol 1. San Diego, Calif: Jaycor, Inc; 1985. Project Summary.
23. Ochs M, Nyengaard JR, Jung A, et al. The number of alveoli in the human lung. *Am J Respir Crit Care Med*. 2004;169(1):120–124.
24. Rice DA. Sound speed in the upper airways. *J Appl Physiol*. 1980;49(2):326–336.
25. Rice DA. Sound speed in pulmonary parenchyma. *J Appl Physiol*. 1983;54:304–308.
26. Fung YB, Patitucci P, Tong P. Stress and strain in the lung. *J Eng Mech*. 1978;104:201–223.
27. Fung YC, Yen MR, Zeng YJ. *Lung Dynamics and Mechanical Properties Determination*. San Diego, Calif: Jaycor, Inc; 1984.
28. Fung YC, Yen MR. *Experimental Investigation of Lung Injury Mechanisms*. San Diego, Calif: Jaycor, Inc; 1984.
29. Fung YC, Yen RT, Tao ZL, Liu SQ. A hypothesis on the mechanism of trauma of lung tissue subjected to impact load. *J Biomech Eng*. 1988;110(1):50–56.
30. Stuhmiller JH, Chuong CJ, Phillips YY, Dodd KT. Computer modeling of thoracic response to blast. *J Trauma*. 1988;28: S132–S139.
31. Stuhmiller JH, Chuong CJ, Dodd KT, Phillips YY. Computer modeling of thoracic response to blast. In: *Proceedings of the 5th International Symposium on Wound Ballistics (Gothenberg, Sweden)*. Baltimore, Md: Lippincott Williams & Wilkins; 1985.
32. Vander Vorst MJ, Dodd KT, Stuhmiller H, et al. Calculation of the internal mechanical response of sheep to blast loading. In: *Proceedings of the 10th International Symposium on Military Applications of Blast Simulation in Kurhaus (Bad Reichenhall, West Germany)*. San Diego, Calif: Jaycor, Inc; 1987.
33. Vander Vorst MJ, Stuhmiller JH. *Modeling of the Non-Auditory Response to Blast Overpressure: Calculation of Parenchymal Pressure Due to Double Peak Loading*. San Diego, Calif: Jaycor, Inc; 1987.
34. Stuhmiller JH, Ho KH, Vander Vorst MJ, Dodd KT, Fitzpatrick T, Mayorga M. A model of blast overpressure injury to the lung. *J Biomechan*. 1996;29(2):227–234.
35. Baker WE. *Explosions in Air*. Austin, Tex: University of Texas Press; 1973: 268.
36. Masiello PJ, Stuhmiller JH. *Comparisons of EITACC Code Predictions with Measured Data for the 1990 Complex Waves Study: Measured Data Intercomparisons*. San Diego, Calif: Jaycor, Inc; 1992.
37. Klein HH, Stuhmiller JH. *The EITACC Code for Modeling Blasts in Enclosures*. San Diego, Calif: Jaycor, Inc; 1990.
38. Chan PC, Klein HH. A study of blast effects inside an enclosure. *ASME J Fluids Eng*. 1994;116:450–455.
39. Yu JH, Vasel EJ, Stuhmiller JH. *Modeling of the Non-Auditory Response to Blast Overpressure: Design and Field Test of a Blast Overpressure Test Module*. San Diego, Calif: Jaycor, Inc; 1990.
40. Stuhmiller JH. Biological response to blast overpressure: a summary of modeling. *Toxicology*. 1997;121:91–103.
41. Lobdell TE, Kroell CK, Schneider DC, Hering WE, Nahum AM. Impact response of the human thorax. In: *Symposium on Human Impact Response*. Warren, Mich: General Motors Research Laboratory; 1972.

42. Masiello PJ. *Finite Element Model of a Human Thorax Utilizing Visible Man Data*. San Diego, Calif: Jaycor, Inc; 1995.
43. Stuhmiller JH, Masiello PJ, Ho KH. Biomechanical modeling of injury from blast overpressure. In: *RTO/HFM Specialists' Meeting on "Models for Aircrew Safety Assessment: Uses, Limitations and Requirements."* Neuilly-sur-Seine Cedex, France: NATO Research and Technology Organisation, 1998. RTO MP-20 AC/323(HFM)TP/7.
44. Masiello PJ. *INJURY 7.1: A Computer Code for Health Hazard Assessment of Air Blast Induced Lung Injury*. San Diego, Calif: Jaycor, Inc; 2002.
45. Masiello PJ. *BOP-HHA 2.0 Computer Code*. San Diego, Calif: L-3 Communications; 2006.
46. Johnson DL. *Blast Overpressure Studies with Animals and Man: A Walk-Up Study*. Albuquerque, NM: EG&G Special Projects; 1994.
47. Johnson DL. *Blast Overpressure Studies, Task Order 1*. Albuquerque, NM: EG&G Management Systems, Inc; 1996.
48. Johnson DL. *Blast Overpressure Studies: Direct Determination Exposure Limits for Intensive Reverberant Impulse Noise, Task Orders 1 and 4—Firing from an Enclosure Simulator*. Albuquerque, NM: EG&G Management Systems, Inc; 1997.
49. Johnson DL, Patterson JH. *Effectiveness of a Leaking Earmuff Versus a Leaking Earplug*. Fort Rucker, Ala: US Army Aeromedical Research Laboratory; 1997.
50. Johnson DL, Patterson J Jr. Rating of hearing protector performance for impulse noise. In: *Hearing Conservation Conference*. Cincinnati, Ohio: EG&G Special Projects; 1992.
51. Johnson DL. *Blast Overpressure Studies with Animals and Man, Task Order 3: Comparison of Blast Overpressure Effects on Two Versions of ACAPS*. Albuquerque, NM: EG&G Special Projects; 1991.
52. Patterson JH Jr, Mozo BT, Gordon E, Canales JR, Johnson DL. *Pressures Measured Under Earmuffs Worn by Human Volunteers During Exposure to Freefield Blast Overpressures*. Fort Rucker, Ala: US Army Aeromedical Research Laboratory; 1997.
53. Chan PC, Ho KH, Kan KK, Stuhmiller JH, Mayorga MA. Evaluation of impulse noise criteria using human volunteer data. *J Acoust Soc Am*. 2001;110(4):1967–1975.
54. Stuhmiller JH. *Interim Total Body Model: A Model of Impact Injury*. San Diego, Calif: Jaycor, Inc; 2000.
55. Yu JHY. *A Laboratory Device for the Measurement of Load and Impact Area of Nonlethal Weapons*. San Diego, Calif: Jaycor, Inc; 1997.
56. Yu JH. *A Field Test Device for the Measurement of KE-NLW Impact Loads*. San Diego, Calif: Jaycor, Inc; 1997.
57. Huang J, Shen W. *ATBM: An Advanced Total Body Model for Injury Risk Assessment of NLW Systems, Part III: Developing Biomechanically-based Criteria for NLW Impact Induced Penetration*. San Diego, Calif: Titan Corporation; 2004.
58. Shen W, Niu Y, Stuhmiller JH. Biomechanically based criteria for rib fractures induced by high-speed impact. *J Trauma*. 2005;58(3):538–545.
59. Stuhmiller JH, Stuhmiller LM, Dillingham JT. *Combined Injury Effects on the Nuclear Battlefield*. San Diego, Calif: Jaycor, Inc; 1991.
60. Chuong CJ, Stuhmiller JH. Thoracic responses to blast waves—a finite elements approach. In: *Proceedings of the 4th International Conference on Mechanics in Medicine and Biology*. Buffalo, NY: The State University of New York; 1984.
61. Stuhmiller JH. Use of modeling in predicting tympanic membrane rupture. *Ann Otol Rhinol Laryngol Suppl*. 1989;140:53–60.
62. Vander Vorst MJ, Chilton WE, Stuhmiller JH, Stuhmiller L. *Automated Finite Element Modeling of the Skull*. San Diego, Calif: Jaycor, Inc; 1993. J2837-00-93-019.

63. Bandak FA, Vander Vorst MJ, Stuhmiller LM, Chilton WE, Stuhmiller JH. An imaging-based computational and experimental study of head injury, Part 1: skull fracture model. In: *Head Injury '94 International Symposium*. Washington, DC; 1994.
64. Bandak FA, Vander Vorst MJ, Stuhmiller LM, Mlakar PF, Chilton WE, Stuhmiller JH. An imaging-based computational and experimental study of skull fracture: finite element model development. *J Neurotrauma*. 1995;12(4):679–688.
65. Vander Vorst M, Chan PC. Biomechanical criterion for focal skull fracture. In: *IROCOBI Conference on the Biomechanics of Impact*. Bron, Cedex, France: International Research Council on the Biomechanics of Impact; 2006.
66. Vander Vorst M, Chan P, Zhang J, Yoganandan N, Pintar F. A new biomechanically based criterion for lateral skull fracture. In: *Proceedings of the 47th Annual Meeting of AAAM*. Key Biscayne, Fla: Association for the Advancement of Automotive Medicine; 2004.
67. Smith SM, Stuhmiller JH, Januszkiewicz AJ. Evaluation of lethality estimates for combustion gases in military scenarios. *Toxicology*. 1996;115:157–165.
68. Stuhmiller LM. *Immediate Incapacitation Source Book*. San Diego, Calif: Jaycor, Inc; 2001.
69. Stuhmiller L. *Acute Toxic Effects Data Book*. San Diego, Calif: Jaycor, Inc; 2001.
70. Stuhmiller L. *Control of Respiration Source Book*. San Diego, Calif: Jaycor, Inc; 2001.
71. Stuhmiller JH, Stuhmiller LM. *An Internal Dose Model for Interspecies Extrapolation of Immediate Incapacitation Risk from Inhalation of Fire Gases*. San Diego, Calif: Jaycor, Inc; 2002.
72. Stuhmiller JH, Stuhmiller LM. An internal dose model of incapacitation and lethality risk from inhalation of fire gases. *Inhal Toxicol*. 2006;18:347–364.
73. Stuhmiller LM. *Physiologically Based Pharmacokinetic Modeling Source Book*. San Diego, Calif: Jaycor, Inc/Titan Corporation; 2005: 581.
74. Stuhmiller LM. *PBPK Models for Halocarbons Source Book*. San Diego, Calif: Jaycor, Inc/Titan Corporation; 2005: 519.
75. Stuhmiller LM. *Halocarbon Regulations Source Book*. San Diego, Calif: Jaycor, Inc/Titan Corporation; 2005: 186.
76. Ng LJ, Stuhmiller LM, Stuhmiller JH. Incorporation of acute dynamic ventilation changes into a standardized physiologically based pharmacokinetic model. *Inhal Toxicol*. 2007;19(3):247–263.
77. Stuhmiller JH, Stuhmiller LM. A mathematical model of ventilation response to inhaled carbon monoxide. *J Appl Physiol*. 2005;98(6):2033–2044.
78. Stuhmiller JH, Stuhmiller LM. *TGAS 1.0 Model of Immediate Incapacitation*. San Diego, Calif: Jaycor, Inc; 2001.
79. Stuhmiller JH, Stuhmiller LM. *An Internal Dose Model for Interspecies Extrapolation of Immediate Incapacitation Risk from Inhalation of Fire Gases*. San Diego, Calif: Jaycor, Inc; 2002.
80. Stuhmiller J, Stuhmiller L. *A Mathematical Model of Ventilation Response to Inhaled Carbon Monoxide*. San Diego, Calif: L-3 Communications/Jaycor; 2005.
81. Stuhmiller JH, Long DW, Stuhmiller LM. An internal dose model of incapacitation and lethality risk from inhalation of fire gases. *Inhal Toxicol*. 2006;18:347–364.
82. Ng LJ, Stuhmiller LM, Stuhmiller JH. Incorporation of acute dynamic ventilation changes into a standardized physiologically based pharmacokinetic model. *Inhal Toxicol*. 2007;19(3):1–17.
83. Okie S. Traumatic brain injury in the war zone. *N Engl J Med*. 2005;352(20):2043–2047.

84. Kaur C, Singh J, Lim MK, Ng BL, Yap EP, Ling EA. The response of neurons and microglia to blast injury in the rat brain. *Neuropathol Appl Neurobiol.* 1995;21(5):369–377.
85. Kaur C, Singh J, Lim MK, Ng BL, Yap EP, Ling EA. Ultrastructural changes of macroglial cells in the rat brain following an exposure to a non-penetrative blast. *Ann Acad Med Singapore.* 1997;26(1):27–29.
86. Cernak I, Chapman SM, Hamlin GP, Vink R. Temporal characterisation of pro- and anti-apoptotic mechanisms following diffuse traumatic brain injury in rats. *J Clin Neurosci.* 2002;9(5):565–572.
87. Moochhala SM, Md S, Lu J, Teng CH, Greengrass C. Neuroprotective role of aminoguanidine in behavioral changes after blast injury. *J Trauma.* 2004;56(2):393–403.
88. Cernak I, Wang Z, Jiang J, Bian X, Savic J. Ultrastructural and functional characteristics of blast injury-induced neurotrauma. *J Trauma.* 2001;50(4):695–706.
89. Cernak I, Wang Z, Jiang J, Bian X, Savic J. Cognitive deficits following blast injury-induced neurotrauma: possible involvement of nitric oxide. *Brain Inj.* 2001;15(7):593–612.
90. Cernak I, O'Connor C, Vink R. Inhibition of cyclooxygenase 2 by nimesulide improves cognitive outcome more than motor outcome following diffuse traumatic brain injury in rats. *Exp Brain Res.* 2002;147(2):193–199.
91. Cernak I, Vink R, Zapple DN, et al. The pathobiology of moderate diffuse traumatic brain injury as identified using a new experimental model of injury in rats. *Neurobiol Dis.* 2004;17(1):29–43.
92. Owatverot TB, Oswald SJ, Chen Y, Willie JJ, Yin FC. Effect of combined cyclic stretch and fluid shear stress on endothelial cell morphological responses. *J Biomech Eng.* 2005;127(3):374–382.
93. Bain AC, Raghupathi R, Meaney DF. Dynamic stretch correlates to both morphological abnormalities and electrophysiological impairment in a model of traumatic axonal injury. *J Neurotrauma.* 2001;18(5):499–511.
94. Pfister BJ, Weihs TP, Betnebaugh M, Bao G. An in vitro uniaxial stretch model for axonal injury. *Ann Biomed Eng.* 2003;31(5):589–598.
95. Bain AC, Meaney DF. Tissue-level thresholds for axonal damage in an experimental model of central nervous system white matter injury. *J Biomech Eng.* 2000;122(6):615–622.
96. Smith DH, Wolf JA, Lusardi TA, Lee VM, Meaney DF. High tolerance and delayed elastic response of cultured axons to dynamic stretch injury. *J Neurosci.* 1999;19(11):4263–4269.
97. LaPlaca MC, Cullen DK, McLoughlin JJ, Cargill RS 2nd. High rate shear strain of three-dimensional neural cell cultures: a new in vitro traumatic brain injury model. *J Biomech.* 2005;38(5):1093–1105.
98. Heidemann SR, Buxbaum RE. Mechanical tension as a regulator of axonal development. *Neurotoxicology.* 1994;15(1):95–107.
99. Pecha R, Gompf B. Microimplosions: cavitation collapse and shock wave emission on a nanosecond time scale. *Phys Rev Lett.* 2000;84(6):1328–1330.
100. Williams JC Jr, Woodward JF, Stonehill MA, Evan AP, McAteer JA. Cell damage by lithotripter shock waves at high pressure to preclude cavitation. *Ultrasound Med Biol.* 1999;25(9):1445–1449.
101. Cernak I, Savic J, Malicevic Z, et al. Involvement of the central nervous system in the general response to pulmonary blast injury. *J Trauma.* 1996;40(suppl 3):S100–S104.
102. Cernak I, Savic J, Malicevic Z, Zunic G, Radošević P, Ivanović I. Leukotrienes in the pathogenesis of pulmonary blast injury. *J Trauma.* 1996;(suppl 3):S148–S151.

103. Cernak I, Savic VJ, Lazarov A, Joksimovic M, Markovic S. Neuroendocrine responses following graded traumatic brain injury in male adults. *Brain Inj.* 1999;13(12):1005–1015.
104. Cernak I, Savic VJ, Kotur J, Prokic V, Veljovic M, Grbovic D. Characterization of plasma magnesium concentration and oxidative stress following graded traumatic brain injury in humans. *J Neurotrauma.* 2000;17(1):53–68.
105. Trudeau DL, Anderson J, Hansen LM, et al. Findings of mild traumatic brain injury in combat veterans with PTSD and a history of blast concussion. *J Neuropsychiatry Clin Neurosci.* 1998;10(3):308–313.
106. Murdoch J, Hall R. Brain protection: physiological and pharmacological considerations, Part I. The physiology of brain injury. *Can J Anaesth.* 1990;37(6):663–671.
107. Ross AJ, Sachdev PS. Magnetic resonance spectroscopy in cognitive research. *Brain Res Brain Res Rev.* 2004;44(2–3):83–102.
108. Ross AJ, Sachdev PS, Wen W, Valenzuela MJ, Brodaty H. Cognitive correlates of ¹H MRS measures in the healthy elderly brain. *Brain Res Bull.* 2005;66(1):9–16.
109. Hunter JV, Thornton RJ, Wang ZJ, et al. Late proton MR spectroscopy in children after traumatic brain injury: correlation with cognitive outcomes. *AJNR Am J Neuroradiol.* 2005;26(3):482–488.
110. Kopecek M, Hajek T. Fronto-cerebellar loop and declines in the performance intelligence scale. *Psychiatry Clin Neurosci.* 2005;59(6):748.
111. Staffen W, Zaluner H, Mair A, et al. Magnetic resonance spectroscopy of memory and frontal brain region in early multiple sclerosis. *J Neuropsychiatry Clin Neurosci.* 2005;17(3):357–363.
112. Reiss AL, Eckert MA, Rose FE, et al. An experiment of nature: brain anatomy parallels cognition and behavior in Williams syndrome. *J Neurosci.* 2004;24(21):5009–5015.
113. Vicari S, Bates E, Caselli MC, et al. Neuropsychological profile of Italians with Williams syndrome: an example of a dissociation between language and cognition? *J Int Neuropsychol Soc.* 2004;10(6):862–876.
114. Deicken RF, Pegues MP, Anzalone S, Feiwell R, Soher B. Lower concentration of hippocampal *N*-acetylaspartate in familial bipolar I disorder. *Am J Psychiatry.* 2003;160(5):873–882.
115. Hamakawa H, Kato T, Shiori T, Inubushi T, Kato N. Quantitative proton magnetic resonance spectroscopy of the bilateral frontal lobes in patients with bipolar disorder. *Psychol Med.* 1999;29(3):639–644.
116. Weiss U, Bacher R, Vonbank H, Kemmler G, Lingg A, Marksteiner J. Cognitive impairment: assessment with brain magnetic resonance imaging and proton magnetic resonance spectroscopy. *J Clin Psychiatry.* 2003;64(3):235–242.
117. Chantal S, Labelle M, Bouchard RW, Braun CM, Boulanger Y. Correlation of regional proton magnetic resonance spectroscopic metabolic changes with cognitive deficits in mild Alzheimer disease. *Arch Neurol.* 2002;59(6):955–962.
118. Delamillieure P, Constans JM, Fernandez J, et al. Proton magnetic resonance spectroscopy (¹H MRS) in schizophrenia: investigation of the right and left hippocampus, thalamus, and prefrontal cortex. *Schizophr Bull.* 2002;28(2):329–339.
119. Menon PM, Nasrallah HA, Reeves RR, Ali JA. Hippocampal dysfunction in Gulf War syndrome. A proton MR spectroscopy study. *Brain Res.* 2004;1009(1–2):189–194.
120. Mohanakrishnan Menon P, Nasrallah HA, Lyons JA, Scott MF, Liberto V. Single-voxel proton MR spectroscopy of right versus left hippocampi in PTSD. *Psychiatry Res.* 2003;123(2):101–108.
121. Schuff N, Neylan TC, Lenoci MA, et al. Decreased hippocampal *N*-acetylaspartate in the absence of atrophy in post-traumatic stress disorder. *Biol Psychiatry.* 2001;50(12):952–959.

122. Freeman TW, Cardwell D, Karson CN, Komoroski RA. In vivo proton magnetic resonance spectroscopy of the medial temporal lobes of subjects with combat-related posttraumatic stress disorder. *Magn Reson Med*. 1998;40(1):66–71.
123. Brown S, Freeman T, Kimbrell T, Cardwell D, Komoroski R. In vivo proton magnetic resonance spectroscopy of the medial temporal lobes of former prisoners of war with and without posttraumatic stress disorder. *J Neuropsychiatry Clin Neurosci*. 2003;15(3):367–370.
124. Villarreal G, Petropoulos H, Hamilton DA, et al. Proton magnetic resonance spectroscopy of the hippocampus and occipital white matter in PTSD: preliminary results. *Can J Psychiatry*. 2002;47(7):666–670.
125. Neylan TC, Lenoci M, Rothlind J, et al. Attention, learning, and memory in posttraumatic stress disorder. *J Trauma Stress*. 2004;17(1):41–46.
126. Kimbrell T, Leulf C, Cardwell D, Komoroski RA, Freeman TW. Relationship of in vivo medial temporal lobe magnetic resonance spectroscopy to documented combat exposure in veterans with chronic posttraumatic stress disorder. *Psychiatry Res*. 2005;140(1):91–94.
127. Brambilla P, Stanley JA, Nicoletti MA, et al. ¹H magnetic resonance spectroscopy study of dorsolateral prefrontal cortex in unipolar mood disorder patients. *Psychiatry Res*. 2005;138(2):131–139.
128. Brambilla P, Stanley JA, Nicoletti MA. ¹H magnetic resonance spectroscopy investigation of the dorsolateral prefrontal cortex in bipolar disorder patients. *J Affect Disord*. 2005;86(1):61–67.
129. Cecil KM, DelBello MP, Sellars MC, Strakowski SM. Proton magnetic resonance spectroscopy of the frontal lobe and cerebellar vermis in children with a mood disorder and a familial risk for bipolar disorders. *J Child Adolesc Psychopharmacol*. 2003;13(4):545–555.
130. Kumar A, Thomas A, Lavretsky H, et al. Frontal white matter biochemical abnormalities in late-life major depression detected with proton magnetic resonance spectroscopy. *Am J Psychiatry*. 2002;159(4):630–636.
131. Weber-Fahr W, Ende G, Braus DF, et al. A fully automated method for tissue segmentation and CSF-correction of proton MRSI metabolites corroborates abnormal hippocampal NAA in schizophrenia. *Neuroimage*. 2002;16(1):49–60.
132. Friedman SD, Brooks WM, Jung RE, Hart BL, Yeo RA. Proton MR spectroscopic findings correspond to neuropsychological function in traumatic brain injury. *AJNR Am J Neuroradiol*. 1998;19(10):1879–1885.
133. Huda A, Guze BH, Thomas A, et al. Clinical correlation of neuropsychological tests with ¹H magnetic resonance spectroscopy in hepatic encephalopathy. *Psychosom Med*. 1998;60(5):550–556.
134. Yoon SJ, Lee JH, Kim ST, Chun MH. Evaluation of traumatic brain injured patients in correlation with functional status by localized ¹H-MR spectroscopy. *Clin Rehabil*. 2005;19(2):209–215.
135. Friedman SD, Brooks WM, Jung RE, et al. Quantitative proton MRS predicts outcome after traumatic brain injury. *Neurology*. 1999;52(7):1384–1391.
136. Stuhmiller JH, Masiello PJ, Ho KH. Biomechanical modeling of injury from blast overpressure. In *RTO HFM Specialists' Meeting on Models for Aircrew Safety Assessment: Uses, Limitations and Requirements*. Dayton, Ohio: Wright-Patterson Air Force Base; 1998. RTO MP-20.
137. Stuhmiller JH, Ho KH, Vander Vorst MJ, Dodd KT, Fitzpatrick T, Mayorga M. A model of blast overpressure injury to the lung. *J Biomech*. 1996;29(2):227–234.
138. Stuhmiller JH. Biological response to blast overpressure: a summary of modeling. *Toxicology*. 1997;121:91–103.
139. Zhang L, Yang KH, King AI. A proposed injury threshold for mild traumatic brain injury. *J Biomech Eng*. 2004;126(2):226–236.
140. Chan PC, Yu JHY, Stuhmiller JH. *A Fluid Dynamic Study of the Skull–Brain Interaction, Part I: Experimental Study*. San Diego, Calif: Jaycor, Inc; 1996.

141. Chan PC, Yu JHY, Stuhmiller JH. *A Fluid Dynamic Study of the Skull–Brain Interaction, Part II: Computational Study*. San Diego, Calif: Jaycor, Inc; 1996.
142. Nahum AM, Smith RW. An experimental model for closed head impact injury. In: *Proceedings of the Twentieth Stapp Car Crash Conference*. Society of Automotive Engineers. San Diego, Calif: Department of Surgery, University of California–San Diego; 1976.
143. Nahum AM, Smith R, Ward CC. Intracranial pressure dynamics during head impact. In: *Proceedings of the Twenty-first Stapp Car Crash Conference*. Society of Automotive Engineers. San Diego, Calif: Department of Surgery / Naval Civil Engineering Laboratory, University of California–San Diego; 1977.
144. Nahum AM, et al. Intracranial pressure relationships in the protected and unprotected head. In: *Proceedings of the Twenty-third Stapp Car Crash Conference*. Society of Automotive Engineers. San Diego, Calif: University Hospital / Naval Construction Battalion Center, University of California–San Diego; 1979.
145. Nahum A, et al. Experimental studies of side impact to the human head. In: *Proceedings of the Twenty-fourth Stapp Car Crash Conference*. Society of Automotive Engineers. San Diego, Calif: University of California–San Diego; 1980.
146. Bandak FA. On the mechanics of impact neurotrauma: a review and critical synthesis. *J Neurotrauma*. 1995;12(4):635–649.
147. Stuhmiller JH, Stuhmiller LM. A mathematical model of ventilation response to inhaled carbon monoxide. *J Appl Physiol*. 2005;98(6):2033–2044.
148. Soloviev SP, Surkov VV, Sweeney JJ. Quadrupolar electromagnetic field from detonation of high explosive charges on the ground surface. *J Geophys Res*. 2002;107(B6):2119.
149. Soloviev SP, Sweeney JJ. Generation of electric and magnetic field during detonation of high explosive charges in boreholes. *J Geophys Res*. 2005;110:B01312.
150. Servantie B, Servantie AM, Etienne J. Synchronization of cortical neurons by a pulsed microwave field as evidenced by spectral analysis of electrocorticograms from the white rat. *Ann NY Acad Sci*. 1975;247:82–86.
151. Bawin SM, Sheppard AR, Mahoney MD, Adey WR. Influences of sinusoidal electric fields on excitability in the rat hippocampal slice. *Brain Res*. 1984;323(2):227–237.
152. Adey WR, Bawin SM, Lawrence AF. Effects of weak amplitude-modulated microwave fields on calcium efflux from awake cat cerebral cortex. *Bioelectromagnetics*. 1982;3(3):295–307.
153. Bawin SM, Adey WR. Sensitivity of calcium binding in cerebral tissue to weak environmental electric fields oscillating at low frequency. *Proc Natl Acad Sci USA*. 1976;73(6):1999–2003.
154. Bawin SM, Adey WR, Sabbot IM. Ionic factors in release of $^{45}\text{Ca}^{2+}$ from chicken cerebral tissue by electromagnetic fields. *Proc Natl Acad Sci USA*. 1978;75(12):6314–6318.
155. Prange MT, Margulies SS. Regional, directional, and age-dependent properties of the brain undergoing large deformation. *J Biomech Eng*. 2002;124(2):244–252.
156. Velardi F, Fraternali F, Angelillo M. Anisotropic constitutive equations and experimental tensile behavior of brain tissue. *Biomech Model Mechanobiol*. 2006;5(1):53–61.
157. Lim CT, Zhou EH, Quek ST. Mechanical models for living cells—a review. *J Biomech*. 2006;39(2):195–216.
158. Nicolle S, Lounis M, Willinger R, Paliarne JF. Shear linear behavior of brain tissue over a large frequency range. *Biorheology*. 2005;42(3):209–223.
159. Marquez JP, Genin GM, Zahalak GI, Elson EL. Thin bio-artificial tissues in plane stress: the relationship between cell and tissue strain, and an improved constitutive model. *Biophys J*. 2005;88(2):765–777.

160. Lippert SA, Rang EM, Grimm MJ. The high frequency properties of brain tissue. *Biorheology*. 2004;41(6):681–691.
161. Miller K, Chinzei K. Mechanical properties of brain tissue in tension. *J Biomech*. 2002;35(4):483–490.
162. Koay EJ, Shieh AC, Athanasiou KA. Creep indentation of single cells. *J Biomech Eng*. 2003;125(3):334–341.