

**United States Air Force  
Guide to Operational  
Surveillance  
of  
Medically Important  
Vectors and Pests**



**“Operational Entomology”**

Version 2.1, 15 August 2006; first published 1 November 2002

# Report Documentation Page

Form Approved  
OMB No. 0704-0188

Public reporting burden for the collection of information is estimated to average 1 hour per response, including the time for reviewing instructions, searching existing data sources, gathering and maintaining the data needed, and completing and reviewing the collection of information. Send comments regarding this burden estimate or any other aspect of this collection of information, including suggestions for reducing this burden, to Washington Headquarters Services, Directorate for Information Operations and Reports, 1215 Jefferson Davis Highway, Suite 1204, Arlington VA 22202-4302. Respondents should be aware that notwithstanding any other provision of law, no person shall be subject to a penalty for failing to comply with a collection of information if it does not display a currently valid OMB control number.

1. REPORT DATE <b>01 AUG 2006</b>		2. REPORT TYPE <b>N/A</b>		3. DATES COVERED <b>-</b>	
4. TITLE AND SUBTITLE <b>USAF Guide to Operational Surveillance of Medically Important Vectors and Pests Operational Entomology</b>				5a. CONTRACT NUMBER	
				5b. GRANT NUMBER	
				5c. PROGRAM ELEMENT NUMBER	
6. AUTHOR(S)				5d. PROJECT NUMBER	
				5e. TASK NUMBER	
				5f. WORK UNIT NUMBER	
7. PERFORMING ORGANIZATION NAME(S) AND ADDRESS(ES) <b>USAF Armed Forces Pest Management Board</b>				8. PERFORMING ORGANIZATION REPORT NUMBER	
9. SPONSORING/MONITORING AGENCY NAME(S) AND ADDRESS(ES)				10. SPONSOR/MONITOR'S ACRONYM(S)	
				11. SPONSOR/MONITOR'S REPORT NUMBER(S)	
12. DISTRIBUTION/AVAILABILITY STATEMENT <b>Approved for public release, distribution unlimited</b>					
13. SUPPLEMENTARY NOTES <b>The original document contains color images.</b>					
14. ABSTRACT					
15. SUBJECT TERMS					
16. SECURITY CLASSIFICATION OF:			17. LIMITATION OF ABSTRACT <b>UU</b>	18. NUMBER OF PAGES <b>116</b>	19a. NAME OF RESPONSIBLE PERSON
a. REPORT <b>unclassified</b>	b. ABSTRACT <b>unclassified</b>	c. THIS PAGE <b>unclassified</b>			

# **USAF Guide to Operational Surveillance of Medically Important Vectors and Pests**

## **“Operational Entomology”**

### **Forward**

This Operational Entomology guide is an interim effort to expeditiously place critical information associated with planning and executing surveillance of disease vectors and pests into the hands of deployed personnel for protecting Air Force personnel and assets against vectorborne diseases, and other related biological threats. This guide is written for use by both civil engineering and medical personnel from airman to commander. Brand name products shown or discussed in this guide are not endorsed by the U.S. Air Force or any of its members, but are shown for demonstration purposes only.

### **Acknowledgements**

Substantial contributions from a number of medical entomologists and other individuals since 1986 have formed the basis of this guide. Contributors include Steven Valder, James Swaby, Jim Goodwin, Will Rogers, Chad McHugh, Jerome Goddard, Terry Carpenter, Dennis Pinkovsky, Armando Rosales, Craig Forcum, Keith Blount, Doug Burkett, James Roberts, Robert Gholson, Duane Meighan, and David Bowles who also served as editor of this guide. Arlene Schirmer prepared many of the line illustrations. Will Goldsmith took many of the photographs in this guide. David Hill provided invaluable technical expertise to produce this electronic version.

## Table of Contents

### Section 1. Introduction

- Purpose
- Background

### Section 2. Operational Vector and Pest Surveillance

- Basic Approach to Surveillance
- Types of Surveillance Programs

### Section 3. Sampling Equipment

- Sampling Equipment
  - Solid-State Army Miniature (SSAM) trap
  - ABC style trap
  - Encephalitis Vector Survey Trap
  - CDC Fay-Prince Trap
  - UV-light traps
  - Ovitrap
  - Light sticks
  - Mosquito dipper
  - Mosquito Concentrator
  - Mosquito breeders
  - Emergence trap
  - Gravid trap
  - Red box
  - Aspirators
  - “Turkey” baster
  - Burrow traps
  - Fly traps
  - Schudder fly grill
  - Insect sweep net
  - Aquatic dipnet
  - Tick drag cloth/burrow swabs/flagging
  - Glue boards and sticky-type traps
  - Rodent traps
  - Accessory tools and equipment

### Section 4. Surveillance Techniques

- Mosquitoes
  - Adults
  - Larvae and Pupae
  - Eggs
- Black Flies
  - Adults
  - Larvae and Pupae
- Sand Flies
  - Adults
  - Larvae
- Biting Midges

Tsetse Flies  
Filth Flies  
Fleas  
Human Lice  
Cone-nosed Bugs or Kissing Bugs  
Bed Bugs  
Ticks  
Mites  
Snails  
Rodents

**Section 5. Sampling and Interpreting Surveillance Data**

**Section 6. Packing and Shipping**

**Section 7. Taxonomic Classification**

**Section 8. Biology of Pest/Vector Mosquitoes**

**Section 9. Point Source and Psychological Threats**

**Section 10. Common Vectorborne Diseases and Zoonoses of Military Importance**

**Section 11. Hazardous Plants**

**Section 12. Venomous Snakes**

**Section 13. Sources of Assistance for Vector/Pest Identification and Information**

**Section 14. Personal Protection From Arthropods**

Chemoprophylaxis  
Vaccination (Immunization)  
Avoidance  
Tick Removal  
Barriers  
Repellents  
Personal Use Pesticides  
Education  
Repellent Safety  
Wear of Treated Uniforms  
The DoD Repellent System  
Supply Information  
Repellent Information Contacts  
Guidance for Applying Insect/Arthropod Repellent Lotion (NSN 6840-01-284-3982)  
Guidance for Treating BDUs with the IDA Kit (NSN 6840-01-345-0237)  
Guidance For Applying Permethrin Aerosol (NSN 6840-01-278-1336) To The BDUs

**Section 15. Prevention, Treatment, and Control of Schistosomiasis**

**Section 16. Integrated Pest Management**

Definitions  
Contingency Considerations  
Components of pest management.  
    Technical Information.  
    Human Safety.  
    Environmental Concern.  
Pest Management Actions  
    Pest Exclusion.  
    Inspection.

- Non-Chemical Measures
  - Cultural Measures
  - Biological Controls
  - Mechanical/Physical Controls
  - Chemical Measures
- Disinsection
- Pest management in medical treatment facilities and laboratories
  - Non-chemical controls
  - Mechanical controls
  - Chemical controls
  - Contingency considerations
- Foreign quarantine actions
  - Interception
  - Control of regulated pests
  - Inspection
  - Pest suppression/elimination
- Records and Reports
- Other reporting responsibilities
- Mosquito Abatement
  - Introduction
  - Long-term methods
  - Stream and pond management
  - Stream flushing
  - Impounded water
  - Aquatic vegetation management
  - Coastal marshes
  - Fish
  - Pumping
  - Filling and grading
  - Ditching
  - Temporary methods
  - Larval management
  - Adult control

[Section 17. Selected References](#)

[Section 18. Notes](#)

## Section 1. Introduction

### Purpose

The intended purpose of this guide is to present the reader with a sound understanding of the principles of vector/pest surveillance in operational environments, equipment use and design, and basic vector/pest identification.

### Background

Infectious diseases historically have resulted in more casualties during U.S. wars than have battle injuries (Figure 1; Injuries in the Military, A Hidden Epidemic, Armed Forces Epidemiology Board, Nov 96)

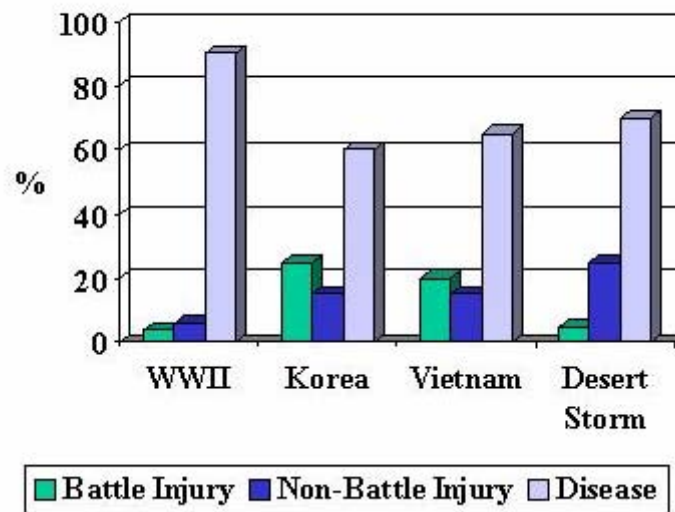


Figure 1. Disease impacts on major U.S. conflicts.

Arthropod vectors transmitted the majority of diseases contracted by U.S. military forces during these wars, and some severely impacted mission success. Examples of diseases that have produced mass casualties among U.S. military forces include malaria, dengue, sand fly fever, scrub typhus, leishmaniasis, and plague. These diseases continue to pose a threat to deployed military forces. There are many other diseases, vectors and pests that can impact military forces and operations (Table 1). Some species of insects, plants, vertebrates are pests that can seriously affect military operations by spreading disease, reducing the efficiency of military personnel or destroying property. Military organizations often use the terms applied biology or entomology to describe pest management efforts. Operations are much broader than just the field of entomology. They typically involve other pests and reservoirs such as bats, birds, rodents, snails, snakes, domestic livestock, feral dogs and cats, and miscellaneous small animals. The term "applied biology" more correctly describes the range of pests encountered during operations.

Threats from vectors and pests can be grouped into three broad categories with respect to their potential impact on deployed military forces:

Militarily significant (e.g., disease)- can incapacitate or kill military members and potentially halt the mission.

Psychologically significant (e.g., aversions to biological threats whether real or not)- can impair the ability of members to properly perform their duties.

Morale impairing (e.g., pests in food)- can lower morale of forces already under stress due to other factors related to deployment.

## **Section 2. Operational Vector and Pest Surveillance**

Sound medical intelligence is the foundation of preventive medicine. Surveillance that deals specifically with vector-borne diseases, disease vectors, and other biological hazards is a significant part of medical intelligence. Understanding and acting on these threats can prevent potential degradation of the mission. Surveillance of vectors and pests also is the basis for determining what, when, and if control measures should be implemented. Vector control must never be implemented unless surveillance shows there is an actual or potential problem that must be halted. Better understanding of the types and numbers of vector species in a deployed area and the diseases they transmit affords a better opportunity for their control, and ultimately a healthier force.

### **Basic Approach to Surveillance**

Surveillance is the process of determining the presence of vectors and pests and of estimating their general population levels. Such information is the basis for developing a risk assessment that in turn can be used to qualitatively or quantitatively predict the occurrence of vectorborne disease or pest outbreaks. There are many methods, techniques and equipment that can be used to accomplish surveillance. Properly accomplished surveillance of disease vectors and medical pests during deployments, particularly those to less-developed countries, answers some important questions, including:

- Do vectors and medical pests in the deployment area threaten the health and morale of deployed personnel?

Determine who is at risk Available medical intelligence seldom gives more than a general idea of the vector-borne disease threat in an area. Existing intelligence **MUST BE** validated and refined or “ground-truthed” on site.

- Where, by geographical area and type of terrain; and when, by season and time of day; could vectors and medical pests occur in the area of operations?

Not all disease vectors may be present in a given area, or their occurrence may be associated with different times of day or seasons.



-Where and when pest controllers should apply control measures against vectors and pests?

Communication between the organization providing surveillance and the organization providing control is essential for effective control.

-Do control measures implemented actually control the target vectors and pests?

Post-control surveillance serves as a validation of control efforts. If control measures are not working, alternative methods can be devised.

### **Types of Surveillance Programs**

There are three general types of surveillance programs that can be used during a deployment.

Baseline Survey- these are conducted to determine the types of vectors and pests occurring in the area of operations, their respective breeding sites or source habitat, and seasonal activity patterns.

Operational Survey- data collected in an operational survey are used specifically to aid pest management personnel in making decisions on when to start or stop control measures. The decision to start control or management activities is based on the data collected from this type of survey when it is determined that the vectors/pests are occurring in population densities greater than that observed in baseline surveys.

Specific Survey- these surveys are completed when a specific vector or pest species is targeted for surveillance beyond that of the baseline or operational surveys. For instance, this could include a survey for bed bugs in a dwelling where the inhabitants are demonstrating symptoms of parasitism by these insects.

The first step in undertaking a surveillance program in an operational setting is to examine area maps to determine which topographical features and water sources might offer potential breeding sources and serve as likely sites for surveillance. Basic ecological and meteorological knowledge of the geographical location will add immeasurably to successful surveillance efforts. Ideally, surveillance sites should be located between local populated areas or other potential disease sources in populated regions or between the populated areas and vector breeding sources. After potential breeding sources have been identified and traps have been set, their locations and positions, ideally using Geographic Positioning System (GPS) coordinates, should be recorded as permanent record of your surveillance program.

### **Section 3. Sampling Equipment**

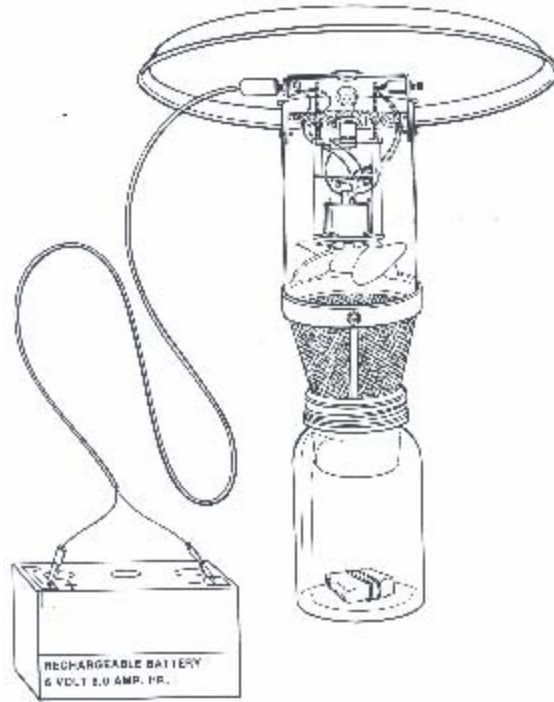
Although there are many different methods and sampling devices available for collecting vectors and pests, not all of them are likely to be used in an operational environment due to practical, logistical or security reasons. Indeed, the equipment and techniques used for base level surveillance in a non-operational environment may be quite different than that described here. Whether at base level or deployed, an integrated sampling approach using as many collection methods as practically possible will maximize the quantity and diversity of species collected. The methods and sampling

devices described here are those that are most commonly used by military entomologists under operational conditions or are readily available through supply channels. A few of these sampling devices can be constructed on site with available materials.

## **Sampling Equipment and Tools**

### **Solid-State Army Miniature (SSAM) trap**

These traps are small, light-weight and battery operated, and have solid-state circuitry. They generally run on 6 volts supplied by 4 D-cell batteries or preferably rechargeable 6-volt, 10 Amp hour (AH) gel-cell batteries. A photoelectric switch allows for the trap start operating by itself at dusk. A rain shield can be fitted to the trap for use in damp conditions. The fan remains running until the battery is disconnected to prevent live mosquitoes from escaping through the top of the trap. For field use, at least two batteries are needed for each trap, so one battery can be charged while the other one is in use. SSAM traps should be baited with carbon dioxide (CO<sub>2</sub>) to enhance attractiveness to mosquitoes. CO<sub>2</sub> can be supplied by a regulated compressed gas container, or through placement of dry ice in a padded envelope that is suspended above the trap. CO<sub>2</sub> can also be supplied from live animals. SSAM traps can be fitted with net collection cages if live specimens are required for viral studies, or with glass or plastic killing jars if dead specimens are acceptable. If desired, a fine-mesh collection bag can be added to retain tiny dipterans such as sand flies. Ideally, several SSAM traps can be used in an area to conduct mosquito surveillance. In all but the most heavily infested areas, these traps typically collect few mosquitoes (~5 per night) when used without CO<sub>2</sub> attractant. The addition of CO<sub>2</sub> will normally increase trap collections 5-10 times. Light normally is emitted 360° attracting insects from available habitats. The CDC miniature light trap is similar in design and purpose to the SSAM trap, but it lacks solid-state circuitry. CDC traps are no longer available through the federal supply system, but are mentioned here because some of these traps may still be present in the inventory of deploying units.



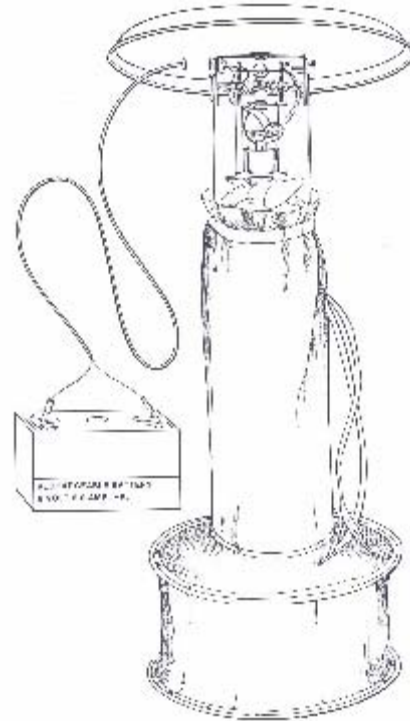
**Figure 2. Illustration of SSAM trap with gel-cell battery and collection jar**



**Figure 3. SSAM trap with collection jar shown properly suspended from tree limb**



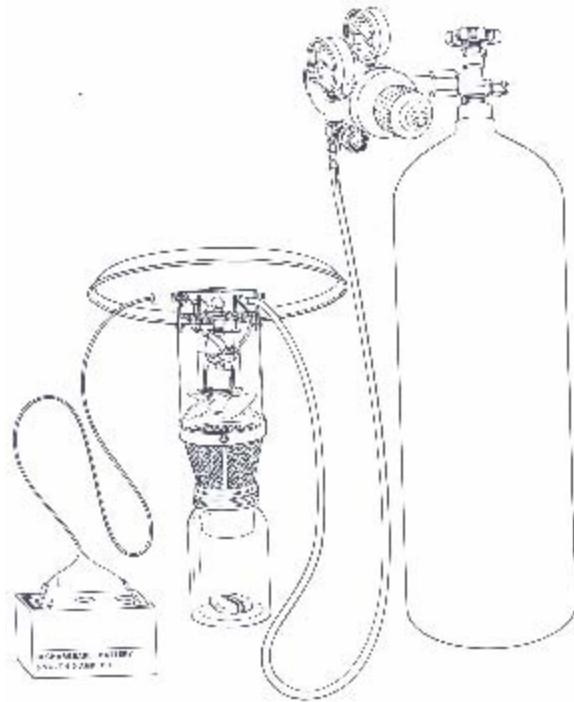
**Figure 4. SSAM trap close-up**



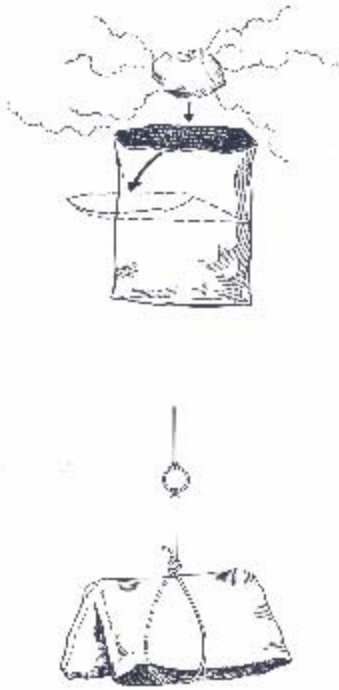
**Figure 5. Illustration of SSAM trap with collection net**



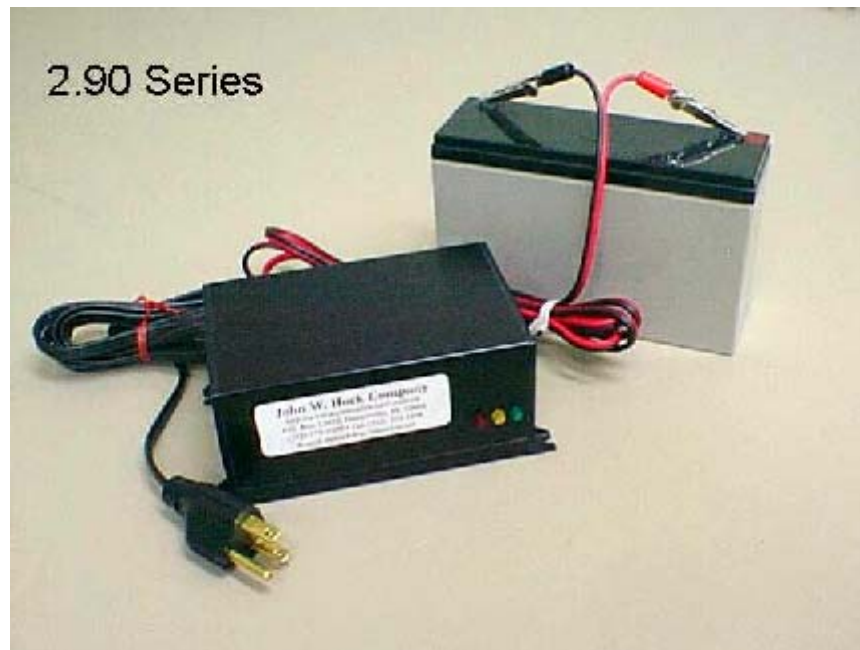
**Figure 6. SSAM trap with collection net shown suspended from tree limb**



**Figure 7. Illustration of SSAM trap with pressurized, regulated carbon dioxide source**



**Figure 8. Configuration for placing carbon dioxide (dry ice) in padded mailing envelope**



**Figure 9. Gel-cell battery with charger**

### **ABC Style trap**

ABC traps work similarly to SSAM traps, but they come fitted with an insulated 2-liter container that holds up to four pounds of dry ice, and a formed plastic rain shield. The ABC trap design

eliminates trapping variability caused by windy conditions, temperature changes, and humidity. These traps are powered by a rechargeable gel-cell battery.



**Figure 10. ABC style trap**

### **Encephalitis Vector Survey Trap**

The Encephalitis Vector Survey trap (EVS) primarily uses CO<sub>2</sub> to attract mosquitoes. The basic trap design consists of a black, plastic, insulated bucket with holes in the bottom that allow the CO<sub>2</sub> to escape, and an electric trap motor and propeller, and collection net. Mosquitoes attracted to the dispersing CO<sub>2</sub> are drawn into the collection net by the air current produced by the trap motor. A small light in the trap acts as a secondary attractant. The EVS trap is powered by 3 D-cell batteries. Several days of use can be obtained from a single set of batteries making this trap a good choice for deployments. A plastic rain shield comes with the trap and can be used to protect the trap and batteries during damp conditions. Trap components can be stored inside the plastic bucket for shipping and storage.



**Figure 11. EVS trap**

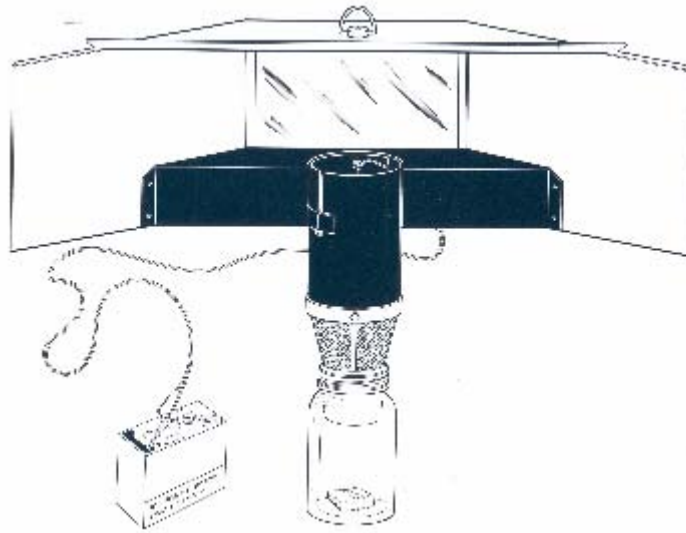


**Figure 12. EVS trap suspended from tree limb**

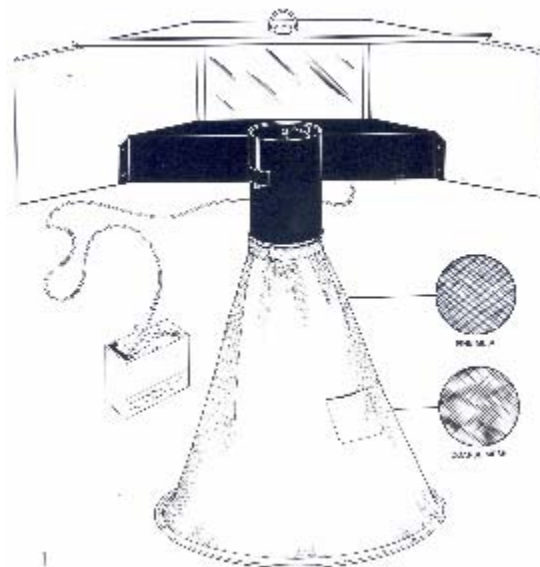
**CDC Fay-Prince Trap**



This and the newer improved omni-directional Fay-Prince are one of the few commercially available traps that will collect adults of both sexes of day-flying *Aedes* (e.g., *Aedes albopictus* and *Ae. aegypti*) and certain other mosquitoes. Effectiveness of this trap is greatly enhanced with CO<sub>2</sub>. The design is based upon the attractiveness of contrasting gloss black and white panels and employs a wind-orienting cover. A cylinder houses a suction motor and also supports the collection bag or killing jar. Fay-Prince traps do not use light and are powered with a 6 V batteries.



**Figure 13. CDC Fay-Prince trap with gel-cell battery and collection jar**



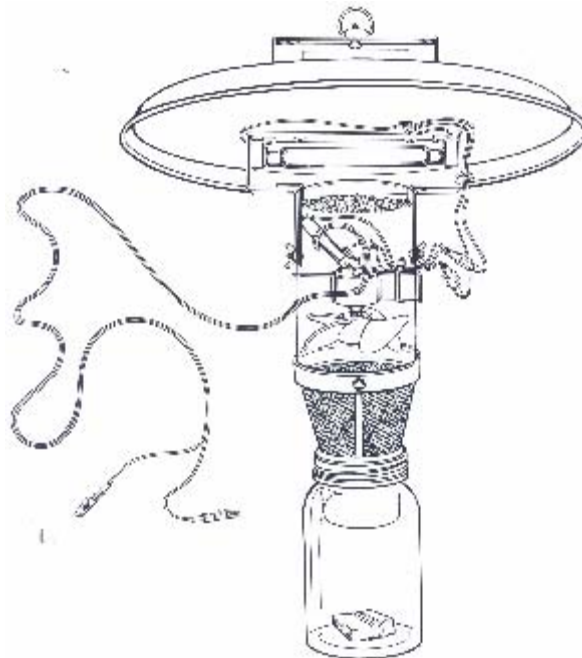
**Figure 14. CDC Fay-Prince trap with gel-cell battery and collection net**



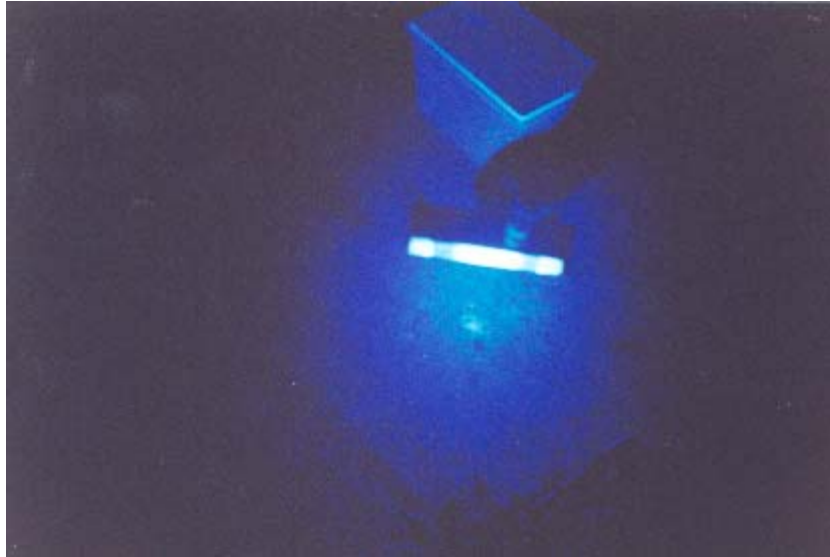
**Figure 15. CDC Fay-Prince trap suspended from tripod**

### **UV-light traps**

Ultraviolet (UV)-light attracts a greater number and diversity of certain flies (e.g., biting midges and sand flies) and other insects than incandescent light. Both SSAM and Fay-Prince traps can be fitted with UV-light bulbs for this purpose. Up- and down-draft versions of these traps are available. When compared to traps using incandescent light, UV-light traps will collect a greater diversity and more mosquitoes when no CO<sub>2</sub> is available as an additional attractant. Wand style UV-collecting lights powered by rechargeable gel battery packs are also available commercially.



**Figure 16. SSAM trap fitted with UV-light bulb**



**Figure 17. UV-light trap shown in use.**

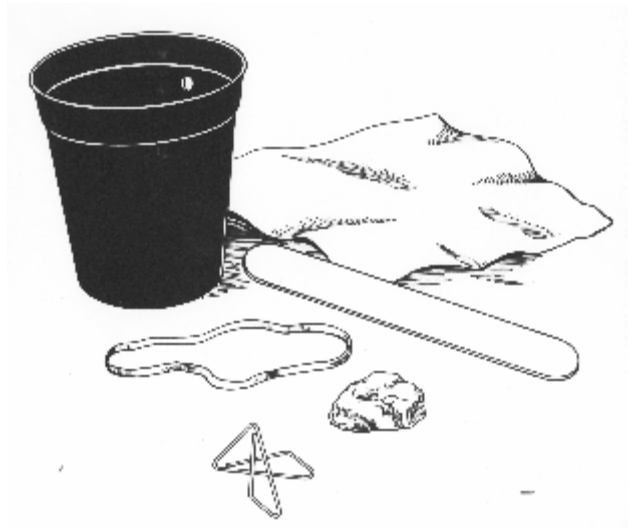
### **Ovitrap**

Ovitrap traps are used to collect the eggs of certain day-flying, container inhabiting *Aedes* (*Stegomyia*) mosquitoes including *Aedes aegypti* and *Ae. albopictus*. Ovitrap traps provide a means of qualifying the presence or absence of these mosquitoes that are not normally collected in standard commercially available mosquito light traps. These mosquitoes are known as container inhabiting *Aedes* because they prefer to lay their eggs in a variety of natural and artificial containers. As the eggs and larvae are virtually identical, adults must be reared from the immature stages to determine species identification. *Aedes aegypti*, *Aedes albopictus* and other *Stegomyia* species are of great concern because of their ability to transmit diseases (e.g., dengue and yellow fever) to deployed forces.

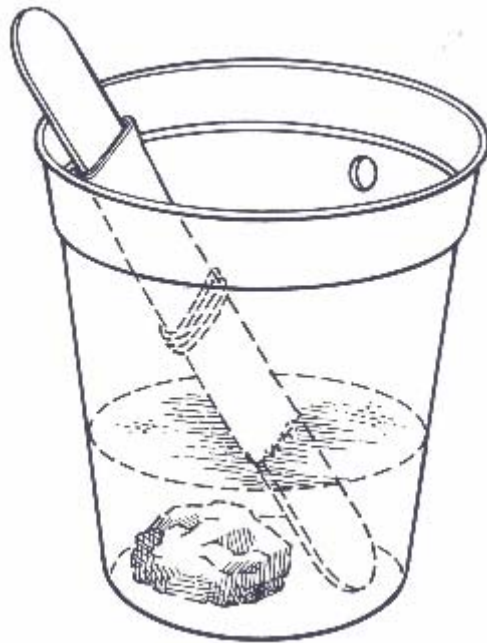
Ovitrap traps consist of glass or plastic containers, of approximately one-pint capacity, painted or colored flat black or other dark color. A wooden tongue depressor wrapped in light colored cotton muslin cloth, germination paper, or paper toweling and attached with rubber bands is placed inside the jar and held in place with a large paper clip. The jar is then filled about half full of water, which ideally should come from a natural source that is attractive to mosquitoes (not too clean, not chlorinated, etc.). If possible, punch a drain hole approximately ½ inch below the lip of the jar to prevent overfilling. A clean stone or other chemically neutral weight should be added to the bottom of the jar as a counterweight to hold the ovitrap in place. Enough water should be added to the cup to keep the paddle moist until the next collection, but not so much that the ovipaddle is entirely submerged and oviposition is prevented.

Ovitrap traps should be checked at time intervals sufficient to ensure that they do not become dry. In most areas, 250 to 300 ml of water in a 12-oz ovitrap (1/3 full) will be sufficient for about a week. Ovitrap traps are not a stock-listed item, but they can easily be fabricated on-site from available materials. In some areas, collection effectiveness can be enhanced by placing two ovitrap traps side-by-

side, one with hay infusion (described in gravid trap section) and one with water as described. Female mosquitoes will deposit their eggs in the cleaner ovitrap.



**Figure 18. Parts of an ovitrap**



**Figure 19. A properly prepared ovitrap**

### **Light sticks**

Light sticks emit light when the plastic tube containing the reactive chemicals is flexed allowing those chemical to mix. Once reacted, light sticks produce light for up to 12 hours. They are waterproof and do not produce heat. Although many different colors of light sticks are available

commercially, yellow is the preferred color when used for attracting insects. Light sticks are inexpensive, readily available through a variety of commercial sources, and they have a shelf life up to 4 years if properly stored.



**Figure 20. Light stick**

### **Mosquito dipper**

The mosquito dipper is a simple and standard tool for conducting larval mosquito surveillance. It consists of a white plastic cup attached to a handle approximately 3 ft long. Mosquito dippers are available commercially at nominal costs, or they can be constructed on-site from available materials.



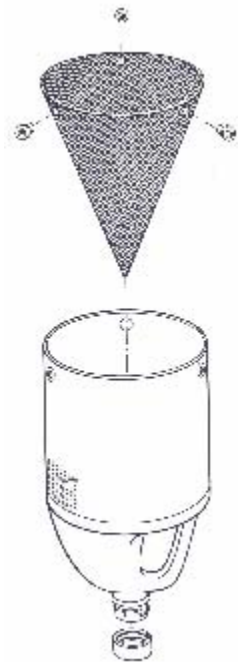
**Figure 21. Illustration of a mosquito dipper**

## Mosquito Concentrator

Mosquito concentrators are used to filter large amounts of water to concentrate larval mosquitoes and separate them from debris. The concentrator consists of a 1-gallon plastic container with the bottom removed and fitted with a wire screen. Concentrated mosquitoes can be removed through the bottom drain. This device can be easily made on location from available materials.



**Figure 22. A mosquito concentrator**



**Figure 23. Components of a mosquito concentrator**

## Mosquito breeders

These rearing containers work by placing a water sample containing mosquito larvae and pupae in the lower portion of the container to approximately one-half full. As adults emerge they fly through an inverted cone into the dry upper chamber where they can be collected. The entire container can be refrigerated for the purpose of calming specimens, or captured specimens can be asphyxiated with CO<sub>2</sub> through the vented top of the container. Mosquito breeders can be purchased from commercial sources, or manufactured from local supplies. For *Aedes aegypti* and/or *Ae. albopictus*, zip-lock bags thumb-tacked by the corner to a wall will suffice. Feed larvae alpha-pellets or fish food.



**Figure 24. A mosquito breeder**



**Figure 25. A mosquito breeder with bottom container filled with mosquito infested water**

## Emergence trap

Emergence traps are available commercially or can be fabricated on-site. There are a variety of styles, but the basic premise of these traps is to collect insects emerging from their aquatic or terrestrial habitats. Emergence traps offer the advantage of allowing the investigator to determine with certainty the species emerging from a particular habitat.

## Gravid trap

The gravid trap is designed primarily to collect gravid *Culex* mosquitoes. The trap consists of the trap body, collection bag, and oviposition bucket/pan. Organically rich water infusions made with aged hay, sod, dead vegetation, or feces is placed in the bottom of the pan approximately 1 inch below the opening of the trap entrance. Female mosquitoes attracted to the water as a place to oviposit are subsequently drawn into the collection bag by the traps fan. Because gravid traps collect mostly females ready to lay eggs, they are also likely to have taken a recent blood meal. A higher proportion of mosquitoes from gravid trap collections will be infected with arboviruses or other pathogens if present in the area. As a result, gravid traps offer an ideal collection tool for capturing adult female *Culex* for virus screening. A 6V gel-cell battery powers the trap. This trap can be ordered with a photoelectric eye to permit night-time only operation. Approximately one handful of hay should be added per gallon of water and allowed to stand for 5-7 days, stirring ever couple of days for a typical hay infusion media. Some media modifications add a teaspoon/gallon of brewers yeast and lactalbumin at the start of the infusion. Other successful infusions have been made using sod, grass clippings, or livestock feces. Pour media through strainer prior to use (screen or cheese cloth). Oak leaf or infusions made from other materials have been successful for increasing non-*Culex* species such as *Aedes albopictus* or *Ae aegypti*. Gravid traps are relatively inexpensive and should be part of any integrated surveillance program.



**Figure 26. A gravid trap**



## Red box

These structures serve as artificial resting sites for mosquitoes. The interior of these resting sites is often painted red, or some other dark color as dark colors seem to be attractive to certain groups of mosquitoes. The size of the red boxes is not critical although units (12 X 12 inches) may be more manageable. Also, boxes should be large enough that the mosquitoes can see them easily and that an aspirator or other collection device can be introduced into the box to collect them. Red boxes can be permanent; wooden boxes, clay pots, etc., or they can be fashioned in the field by spraying the interior of a cardboard box with red spray paint. Ideally, red boxes should be oriented towards the prevailing wind direction in order to optimize attractiveness to flying mosquitoes.



**Figure 27. A collapsible red box being assembled**



**Figure 28. A properly assembled red box**



**Figure 29. Collecting mosquitoes from a red box with a mechanical aspirator**

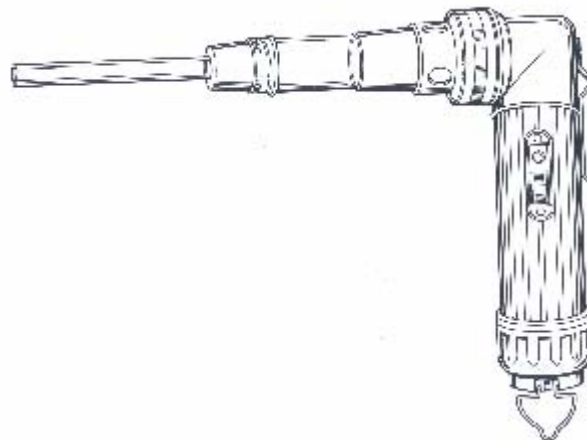
### **Aspirators**

Aspirators are used to collect flying insects that are too small to grab with forceps or too excitable to collect by hand. Aspirators come in several sizes and styles from multiple commercial sources, and they can be either mechanical or mouth-operated (designed for either blowing or inhalation).

Mouth aspirators that can be obtained with HEPA filters are useful for removing mosquitoes from trap nets, or resting collections. Smaller mechanical battery powered aspirators can be used, but these aspirators rarely have sufficient suction power for collections. Several larger backpack or hand held type aspirators are very useful for certain types of sampling. Commercial versions of both gas-powered and 12 V battery-powered backpack aspirators are available. These backpack units use either modified leaf blowers or powerful 12 Volt motors attached to a 4-inch hose ending in a collection cup. Excellent hand-held larger units are also available. These later, more powerful aspirators are excellent for making representative resting collections in a variety of habitats (e.g., edge of vegetation, barns, inside homes, tree holes, under bridges, etc.). The gas-powered versions are perfect for outdoor work, while the 12 V battery versions do not kick up as much dust and are not as noisy/disruptive. The later are ideal for indoor collections including *Aedes aegypti* in yellow fever/dengue endemic areas. Aspirator collections are ideal for capturing large numbers of mosquitoes that should be used for pathogen testing to determine field infection rates.



**Figure 29B. A mechanical aspirator in use**



**Figure 30. Illustration of a flashlight style mechanical aspirator**



**Figure 31. A mechanical aspirator (left) compared with a military issue flashlight (right)**



**Figure 32. A traditional, mouth-operated aspirator**

### **Cooking Baster**

A standard kitchen or “turkey” baster can be a valuable and inexpensive tool for sampling mosquito larvae inhabiting tree holes and other small containers. The tip can be fitted with a piece of tubing (Tygon or similar) to sample habitats that are difficult to reach such as narrow tree holes.



**Figure 33. A turkey baster and white plastic sampling pan**

### **Burrow traps**

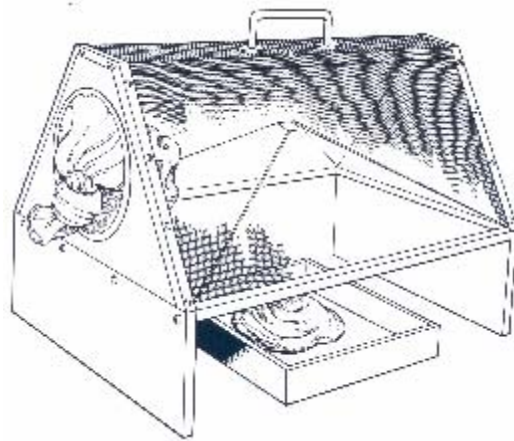
These traps consist of a cylindrical tube with an inverted cone at one or both ends. The trap is inserted into animal burrow or similar places, and as insects fly out for feeding or other activities they are captured in the trap. Emergence traps can be purchased from commercial sources or fabricated on site from plastic bottles and funnels. Emergence traps are excellent tools for collecting sand flies and biting midges emerging from animal burrows.



**Figure 34. A burrow trap**

## Fly traps

Fly traps, sometimes known as Dodge traps, are primarily intended for filth fly surveillance. They can be variously designed, but the basic configuration consists of a screened cage with a funnel type entrance mounted in the bottom. The trap is suspended over decaying organic materials such as food, meat, or feces. Filth flies attracted to the bait fly upwards and are collected by the trap. Fly traps also can be constructed from available materials on location.



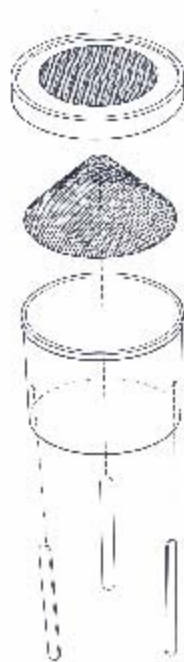
**Figure 35. A commercially manufactured fly trap with animal feces as bait.**



**Figure 36. A commercially manufactured fly trap**



**Figure 37. An illustration of a fly trap constructed from available materials**



**Figure 38. Components of a fly trap made from an ice cream container, tongue depressors, and screen wire**

### **Scudder fly grill**

A fly grill consists of several crossed wooden slats approximately 1 inch wide and 2-3 feet long. The fly grill is placed over an attractant or bait, and the number and types of flies landing on it during a given time period (e.g., 1 minute) are counted. Records of the types and numbers of flies observed on the grill can be recorded to help determine what management actions should be taken. Fly grills can be easily constructed from available material on location.

### **Insect sweep net**

Sweep nets are used to collect insects and other arthropods in heavy vegetation and brush. These nets consist of a heavy muslin or sail cloth bag attached to a rigid, wire frame and a wooden or aluminum handle. Sweep nets are not useful for collecting delicate insects such as mosquitoes, but they may be useful for collecting larger insects such as adult horseflies (Tabanidae) and black flies (Simuliidae). A wide variety of sweep nets are available commercially and they are relatively inexpensive.



**Figure 39. An insect sweep net being used to collect insects**

### **Aquatic dipnet**

These nets are similar to the insect sweep net, but they are designed for collecting organisms from aquatic environments. They can be used to collect the larval stages of horse, deer and black flies and snails in areas endemic for schistosomiasis. They are of less value for collecting mosquito larvae. The net consists of a heavy muslin bag on a steel frame with a sturdy wooden handle. Aquatic nets are available for a variety of commercial sources.

### **Tick drag cloth/burrow swabs/flagging**

Tick drags are made from a large (at least three feet square) piece of flannel, canvas or other cloth. A piece of wood or similar material is attached along one side of the cloth to give it rigidity, and a piece of rope is attached by tying one end of the rope to each end of the wood. The rope is used to pull the tick drag through tick habitats. Burrow swabs and flags are simply a square of flannel or other “fuzzy” material attached to the end of a piece of heavy-gauge wire (such as a straightened-out clothes hanger) with rubber bands.

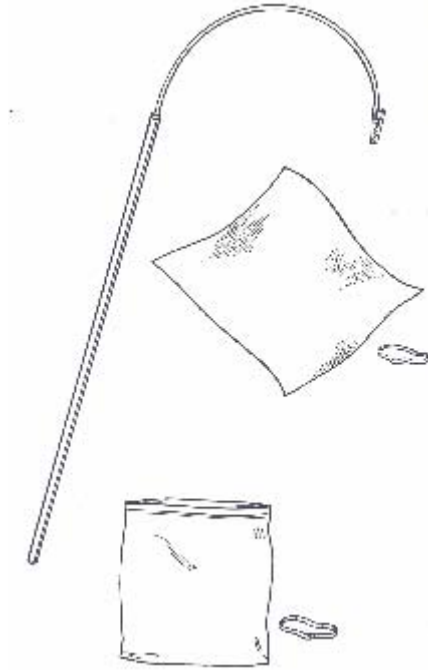




**Figure 40. Illustration of a tick drag**



**Figure 41. Illustration of a burrow swab**



**Figure 42. Components of a burrow swab**

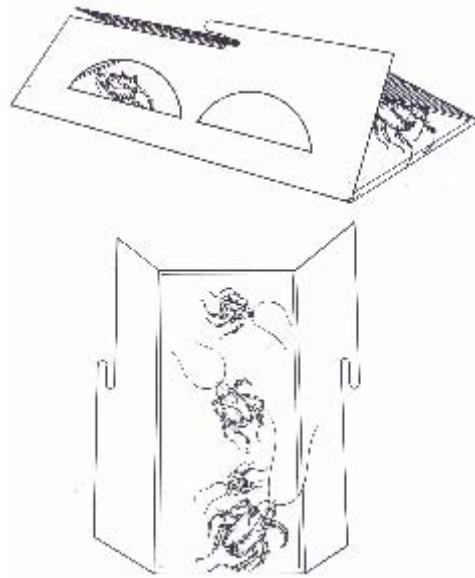


**Figure 43. A properly assembled burrow swab**

### **Glue boards and sticky-type traps**

The premise of these traps is that the animal becomes stuck in the sticky substance and cannot free itself. They are highly effective for surveillance and control of many types of pests including flies, spiders, roaches, fleas, scorpions, lizards, snakes, and rodents. Glue boards and sticky traps can be

bought commercially as individual traps, or they can be easily constructed from available materials coated with sticky material purchased in bulk.



**Figure 44. Illustration of a sticky-type trap for crawling insects**



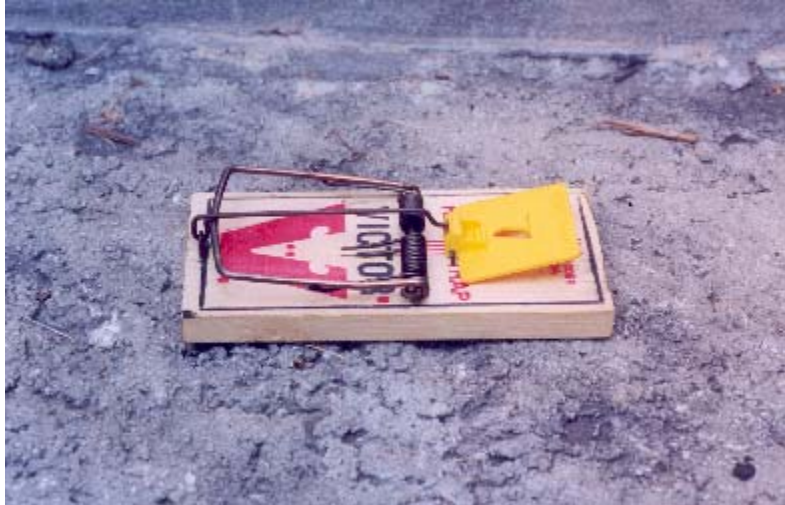
**Figure 45. A fly tape**



**Figure 46. A suspended fly tape**

### **Rodent traps**

A wide variety of rodent traps are available for use on deployments. The most commonly used rodent traps include snap traps, Sherman traps, cage traps, and glueboards and sticky traps. Sherman and cage traps should be used in instances when the capture effort is not intended to kill the animal. All of these traps are highly effective when set along rodent travel corridors and baited appropriately. Ideally, baits should be those that the animal cannot remove from the trap without being captured.



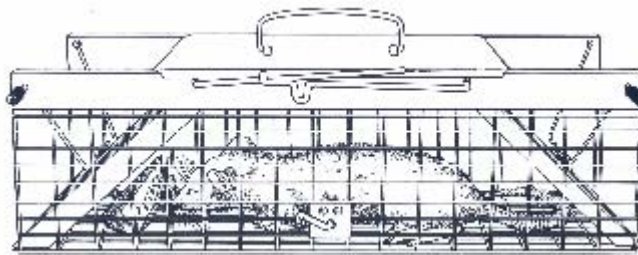
**Figure 47. A snap trap for rats and similar sized rodents.**



**Figure 48. A live trap for mice.**



**Figure 49. A cage-style animal trap for large rodents and other similar sized mammals**



**Figure 50. Illustration of a rat in a live trap**



**Figure 51. A Sherman trap collapsed**



**Figure 52. A Sherman trap opened (end view)**



**Figure 53. A Sherman trap opened (side view)**



Figure 54. A Sherman trap deployed along an exterior building wall



Figure 55. Sticky type traps for rodents



Figure 56. Illustration of a rat captured by a sticky trap



## Accessory Tools and Equipment

The following accessory tools and equipment are valuable assets during field entomological surveillance. Securing these items prior to deployment is strongly suggested because they may not be locally available in the area of operations.

**Table 1. Accessory Tools and Equipment**

ITEM	RECOMMENDED SIZE/QUANTITY
Alcohol, isopropyl, 70% .....	2 quarts
Box, insect storage .....	2
Brush, nylon (ex. Toothbrush) .....	1
Brush, wire .....	1
Comb, Barber's, fine .....	1
Cups, disposable paper (small) .....	1 box
Dowel Rod, wood, 1/4-1/2 in diameter, 3 ft. length .....	2
Forceps, Jeweler's .....	5
Flashlight .....	2
Gloves, disposable rubber/silicone .....	10 pairs or 1 box
Hammer, claw .....	1
Jars, storage, plastic (Nalgene, 1 pint) .....	6
Knife, pocket .....	1
Labels, Paper, pressure sensitive adhesive .....	100
Magnifying lens, 10X (minimum) .....	2
Nails, 10D .....	1 box
Notebook .....	1
Paper, labelling (ragbond) .....	12 sheets
Paper clips (large, butterfly style) .....	24 (or 2 boxes)
Pencils or permanent, india ink pens (ex. Pigma pen) .....	12
Permanent markers (ex. Sharpie) .....	6
Petri dishes, plastic 50 X 9 mm .....	1 gross
Pins, insect #2 (100 per package) .....	2
Pipet, dropper, glass, rubber bulb .....	12
Pliers (slip-joint) .....	1
Pliers (long nose) .....	1
Pliers, diagonal cutting .....	1
Pocket utility tool (ex. Leatherman) .....	1
Rope, nylon .....	100 feet
Rubber bands (various sizes) .....	100
Screwdriver, straight tip (small) .....	1
Screwdriver, straight tip (large) .....	1
Screwdriver, phillips (small) .....	1
Screwdriver, phillips (large) .....	1
Scissors, small .....	2
Scissors, large .....	1
Tape, duct (roll) .....	1
Tape, electrical (roll) .....	1
Towels, paper .....	2 bundles
Tray/pan, utility, white pastic (ca. 9 X 3 X 15 in.) .....	2
Twine, cotton (16 ply roll) .....	1
Vials, screwcap with polyseal liner (4 dram) .....	1 gross
Wash bottle .....	2
Wrench, adjustable (ex. Vise Grip) .....	1
Wrench, adjustable crescent, 1 inch gape .....	1
Wrenches, Allen (set) .....	1

## Section 4. Surveillance Techniques

### Mosquitoes

There are many different sampling methods and techniques for collecting mosquitoes. A proper surveillance program should use an integrated approach using multiple surveillance methods to maximize the numbers collected and species diversity. Moreover, surveillance data should always

be interpreted in view of the influence of environmental conditions, species-specific mosquito behavior such as activity patterns and habitat preferences. Failure of a trap or method to produce mosquitoes on a given night may be heavily influenced by these extraneous factors.

## Adults

In most areas of the world, adult mosquitoes can transmit serious disease in addition to being annoying pests.

### Biting and Landing Counts

A biting count survey is the simplest and most accurate technique for determining precisely what species of mosquitoes are biting humans in an area. Biting count surveys involve one person removing his shirt and acting as “bait.” A second person uses an aspirator or other collection device to collect mosquitoes that bite the “bait.”



**Figure 57. Technique for conducting a landing/biting count survey**

- Biting count surveys can be conducted during the day or during the night. A flashlight can be used to locate mosquitoes at night.

- A single person can act as both “bait” and collector by removing shoes and socks, rolling up the pants legs to the knee (or wearing shorts) and collecting those mosquitoes that bite.

**Never use biting count surveys if there is any possibility of mosquito-borne disease activity in an area.**

The landing count survey is similar to the biting count survey, but the “bait” remains fully clothed. Mosquitoes are removed from the bait's clothing by a second person as they land. **Since some species of mosquitoes can bite through one or even two layers of clothing, never use landing count surveys if there is the possibility of a mosquito-borne disease in the area.**

## Resting Counts

Resting count surveys are accomplished by collecting mosquitoes from places where they rest when they are not actively seeking blood meal. Resting mosquitoes are captured with an aspirator or other collection device. Ideal resting places include areas that are cooler and darker than the general surroundings and in undisturbed areas out of wind currents. Areas near breeding places or places where preferred hosts congregate are usually the best areas to focus searches. Examples of such areas include:

- Under and inside buildings and other structures. Mosquitoes typically rest on vertical surfaces close to the ceiling.
- Under bridges and culverts near the water that serve as larval habitat.
- In animal pens, barns, chicken houses, outdoor toilets, tires, and other places near the favored hosts of the mosquito.



**Figure 57B. Tires are an excellent place to find immature and adult mosquitoes**

- Within human dwellings, look under furniture, in closets, behind pictures, in open cabinets, and similar areas.
- Red boxes also can be used to collect mosquitoes for resting count surveys. Red boxes should be placed 4 to 6 feet above the ground in relatively undisturbed areas. Ideally they should face

the prevailing morning wind direction if this is known for the area. Mosquitoes tend to ride the wind and can find the red boxes more easily if their heads are facing the right direction.

- Resting count surveys can also be done in houses, offices and hotel rooms by spraying the area thoroughly with a “bug bomb”, and then returning to recover dead mosquitoes from floors, tables and other horizontal surfaces. Covering the floor with a sheet or other light colored material will make it easier to find dead mosquitoes.

### **Nets**

Sweep nets or aerial (“butterfly”) nets have extremely limited use in surveying for mosquitoes, but might be used if no other methods are available. Sweep the net back and forth in tall grass and underbrush where adult mosquitoes may be resting when they are not actively looking for a blood meal.

- Aerial nets have a light-weight mesh bag that becomes easily damaged rapidly and subsequently useless when used as described.
- Sweep nets, used for surveying for grasshoppers, beetles and other agricultural pests, are equipped with a heavy, durable canvas bag. Unfortunately, the bag often fills with leaves, twigs and other debris, and mosquitoes trapped become damaged or difficult to find.

### **Light Traps**

One of the easiest ways to collect mosquitoes is to take advantage of the strong attraction many species have to light. Light trapping is a relatively easy means of trapping large numbers of many species of mosquitoes. However, many of these traps are not suitable for operational environments because of size, weight and maintenance restrictions. The most common and appropriate type of light traps for use in operational environments are the SSAM, EVE, and ABC style traps. They should be placed within 4 feet of the ground, and fitted with a protective rain shield if weather conditions might produce precipitation. Ensure the trap and battery source are secured to prevent them being damaged by wind or animals. Always make sure light trap is functioning before deploying.



**Figure 58. A deployed SSAM trap**



**Figure 59. A deployed EVE trap**



**Figure 60. A deployed ABC trap**



**Figure 61. A deployed ABC trap suspended just above ground level**



**Figure 62. A collection bag from a CO<sub>2</sub>-baited ABC trap containing thousands of mosquitoes.**

Because most mosquito species are attracted to carbon dioxide (CO<sub>2</sub>), including some species that aren't attracted to light, CO<sub>2</sub> is often used to enhance light trap operation. CO<sub>2</sub> may also be used alone during daylight hours to capture day biting mosquito species that are not active at night.

- Dry ice, which is solid CO<sub>2</sub>, is often used as a CO<sub>2</sub> source. Dry ice can be placed in a padded mailing envelope or wrapped in a newspaper section and hung near the light trap. CO<sub>2</sub> can also be supplied from a compressed cylinder. A sophisticated CO<sub>2</sub> delivery system is not necessary.
- Typically only blood-feeding insects are attracted to CO<sub>2</sub>. Therefore, traps that are CO<sub>2</sub>-baited usually are almost free of “trash” insects that are normally found in catches from light-baited traps.

Some mosquito species are not attracted to traps routinely used for mosquito surveillance and special traps must be devised for their capture.

Prince-Fay traps should be placed low to the ground, secured, and supplemented with CO<sub>2</sub> to make them more attractive to mosquitoes. To maximize, capture efficiency, two Fay-Prince traps should be placed back-to-back to capture specimens from all angles.

Many traps have been designed to attract mosquitoes to various types of live bait within the traps. The mosquitoes may be captured in collection devices before they reach the bait, or they may be collected from the body of the bait as they attempt to feed.

To be effective, live traps must be placed where mosquitoes are located. To trap mosquitoes living in swamps, place the traps in the swamps and bait them with the animal on which the mosquito of interest normally feeds. To trap mosquitoes that feed on birds in treetops, bait a live trap with birds (e.g., young chickens) and raise the trap to the level where the mosquitoes are found.

## **Larvae and Pupae**

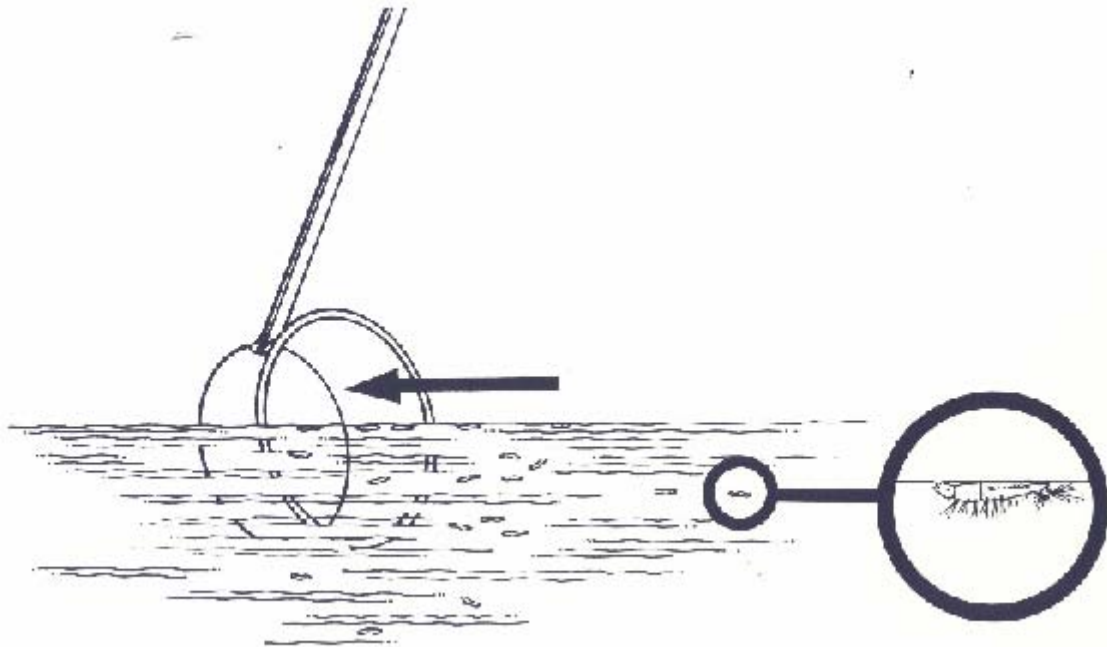
Proper surveillance for immature mosquitoes is an important consideration during deployments. Breeding sites include tree holes, clogged rain gutters, catch basins and other artificial containers, temporary pools, roadside ditches, ponds, swamps, and marshes. Although most larval collecting is done with a white dipper, a turkey baster or syringe may be necessary to sample water receptacles with small openings, such as tree holes or certain artificial containers. These methods of mosquito surveillance are labor intensive and for this reason may not be used during routine installation mosquito surveillance programs. Nevertheless, the adults of some mosquito species may not be attracted to light or CO<sub>2</sub> and larval surveillance may give the only indication that a given species is in a deployment area. Also, when larval identifications are analyzed in conjunction with adult records, you can often determine whether your area of operations is producing its own mosquito problem or whether adults are invading from surrounding areas. Finally, larval surveys show the exact areas where mosquitoes are breeding and consequently where control efforts can be focused. Mosquito larvae may occur in any type of water occurring in nature except for salt water and hot springs. To do a larval mosquito survey it is necessary to find the water and remove any mosquito larvae in it for identification. This is not always as easy as it sounds.

- Most larval surveillance is done with a mosquito dipper, shown in Figure 63. The dipper is used to sample surface water (lakes, streams, swamps, temporary pools, etc.) for the presence of mosquito larvae. Larvae are removed from the dipper with a pipette or soft larval forceps and stored in 70% alcohol or other appropriate preservative. The techniques for dipping Anophiline and Culicine mosquitoes are different. *Anopheles* mosquito larvae have short breathing tubes and they are positioned essentially horizontal to the water surface. In this instance dipping should be done as shown in Figure 64. However, culicine larvae tend to drop in the water column when disturbed so the dipping technique should be done as shown in Figure 65. Both styles should be done at potential mosquito breeding areas in order to capture the diversity of species present.

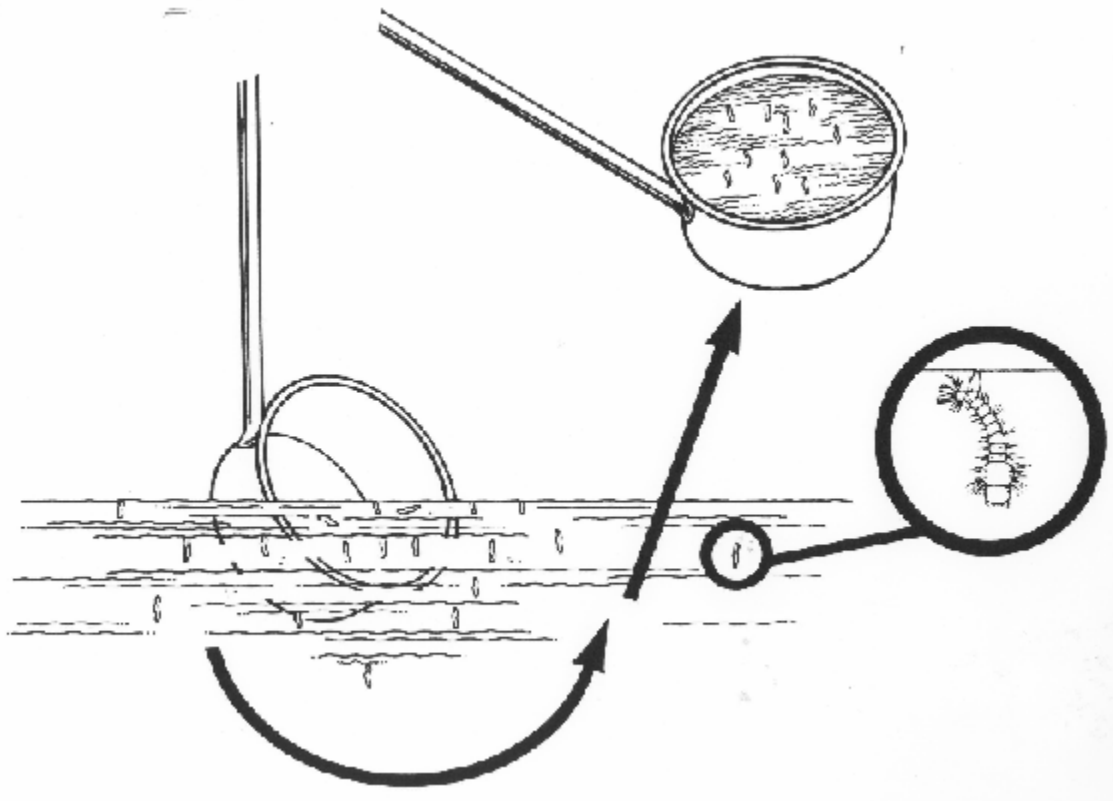




**Figure 63. Dipping mosquito larvae from stagnant water.**



**Figure 64. Illustration of the proper dipping technique for anopheline mosquito larvae**



**Figure 65. Illustration of the proper dipping technique for culicine mosquito larvae**

- Persistence is important. Although a disease vector may be common enough in a deployment area to be a real threat to troop health, the larvae may be widely dispersed, in very low numbers, or distributed over a very large surface area (for example, rice paddies, swamps). It may take dozens of dips to find larvae in such situations, but they can be found if looked for hard enough. A mosquito concentrator can be used to filter large amounts of water to collect mosquito larvae when densities are low.



**Figure 66. Straining water through a mosquito concentrator.**

- Larvae inhabiting small, localized breeding areas may be as difficult to find as larvae in large, dispersed breeding areas. Small ground pools, tree holes and artificial containers as small as snail shells may generate significant amounts of mosquitoes, yet be overlooked by personnel doing larval surveillance. Although the dipper is the most common method of collecting larval mosquitoes, there are other techniques and devices that are more useful in some situations.

- Mosquito larvae in jars, cans and other small artificial containers may be poured into a dipper and then removed. They may also be poured through a kitchen strainer, removed with forceps and placed in preservative solution for identification, or placed in a mosquito breeder for rearing to the adult stage.

- A small kitchen strainer is also useful for removing mosquitoes from water standing in rubber tires -- a favorite breeding area for *Aedes aegypti* and *A. albopictus*, as well as several other species.

- A kitchen (turkey) baster is useful for removing larvae from small areas such as tree holes, banana leaf axils, tires, and drain spouts. It may be useful to attach a short length of tubing to the end of the baster to reach water deep in a tree hole or similar habitat.



**Figure 66B. A Turkey baster can be used to collect mosquito larvae from such places as banana leaf axils**

## **Eggs**

There is only one medically important group of mosquitoes for which surveillance for eggs, called ovitrapping, is practical to the extent that it can be used as a good surveillance tool. This group includes *Aedes aegypti*, *Ae. albopictus* and a few other related species. Ovitrap should be placed at ground level in a dark, secluded place. Place a rock in the bottom of the cup for ballast if it is likely to be blown or tipped over.

Female mosquitoes deposit their eggs on the surface of the paddle above the surface of the water.

Eggs from different mosquito species look different under the microscope, but the eggs of *Aedes* are tiny, dark and oval-shaped. However, because all eggs laid in ovitraps do not necessarily belong to vector species, identification should be left to personnel trained to identify them.

Eggs captured on ovipaddles can be allowed to dry and then be placed into a water in a mosquito breeder for rearing. Ideally, water used to hatch mosquito eggs should be enriched with organic material such as a single piece of dry pet food, dry grass or other vegetation, or similar materials.

The number of ovitraps used in an operational setting varies according to the situation. However, a minimum of 10 ovitraps is recommended for the average area of operations. Ovitrap should be placed at ground level in sheltered, shaded areas such as under bushes near dwellings or other buildings, or near tire- or equipment-storage yards. Water placed in the ovitrap should be enriched

with organic matter as described above. In arid climates, the water level in the trap should be checked at least once daily. The location of each jar should be carefully documented so that all can be checked each week. Remove the paddle, carefully drain off excess water, and package it for shipment, or rear the larvae in mosquito breeders. If ovitraps yield negative results initially, they should be redeployed to other suitable locations.



**Figure 67. A deployed ovitrap**



**Figure 68. A deployed ovitrap**

## **Black Flies**

Black flies (Family Simuliidae, also called buffalo gnats) are vicious biters and some species in Africa and Central and South America can transmit onchocerciasis. In areas where there is no threat of onchocerciasis, black flies may make their presence known by their painful bites and no further formal surveillance is necessary. If there is a possibility that black flies may transmit onchocerciasis based on previous reports of disease activity in a given region, specimens should be captured for species identification.

### **Adults**

Adult black flies can be captured during biting or landing surveys, and feeding activity occurs during daylight which makes such techniques fairly simple. Sweep nets can be used to collect adults resting on stream-side vegetation, but this method has limited surveillance value. Light traps also can be used to collect black flies, and they are attracted to both incandescent (white) and UV-light.

### **Larvae and Pupae**

Black fly larvae and pupae use short strands of silk-like material that they produce to attach themselves to rocks and vegetation emergent from bodies of water. Most species prefer rapidly moving, well-aerated streams. Immature forms of a few species may be attached to vegetation floating in still water with a high organic content. Larvae and pupae can be removed manually from their substrate for identification.

## **Sand Flies**

Sand flies (Family Psychodidae) can be aggressive biting pests, and some species are vectors of sand fly fever, bartonellosis and leishmaniasis. Sand flies are very small (<2 mm) and when at rest generally hold their wings in an upright or V-position.

### **Adults**

Sand flies often rest in rodent burrows and can be captured by inserting burrow traps in the burrow entrance. SSAM traps placed near rodent burrows and suspended just above the ground are an excellent means of capturing sand flies. If using light traps, they should be equipped with solid wall killing jars or fine mesh bags, as most species are small enough to escape through the holes in a mosquito collection bag. A field collection bag can be made by cutting the foot section from a pair of pantyhose. This portion of the hose slips over the bottom of a SSAM trap and the elastic nature of the pantyhose will keep it attached to the trap. CO<sub>2</sub> can be used to make the trap more attractive. Sand flies may be aspirated from rodent holes, tree holes, rocky areas, tree bark, latrines or other areas where they rest.

Sand flies may also be trapped in mineral oil or olive oil spread on a flat or cylindrical piece of plastic and placed near a rodent hole, tree hole or other area where adult sand flies rest or feed.

Flies will fly randomly into the coated plastic and become stuck in the oil. Placing a source of chemical light (cyalume tube) behind the plastic plate or within the cylinder can enhance attraction of sand flies to these devices. Although this technique may work, it poses difficulties when identifying captured specimens because of the oil film deposited on their bodies. In the New World, a sweep net can be used to capture sand flies resting on vegetation.

## **Larvae**

Sand fly larvae are small, difficult to find and identify. Surveillance for this group normally is based entirely on the adults so larval surveillance is not discussed here.

## **Biting Midges**

No-see-ums, sand gnats, biting midges (Family Ceratopogonidae) can be severe biting pests. Biting midges will make their presence known by their bites and this is the most direct form of surveillance. If capture of specimens is necessary, a CO<sub>2</sub>-baited SSAM trap or UV-light trap with a killing jar or fine-mesh collection bag can be used. Surveillance for biting midges is based on the adult. Larvae are primarily aquatic to semi-aquatic, and surveillance techniques are not presented here.

## **Tsetse Flies**

Tsetse flies (Family Glossinidae) are vectors of African trypanosomiasis (African sleeping sickness) and can pose a significant threat to force health during deployments to central Africa. These flies are easy to distinguish from other flies because the proboscis is approximately one-half the body length and is directed straight forward. Adults tsetse flies are attracted to livestock (or humans), and “imitation” livestock (large squares of dark material) or animal skins. This behavior can serve as an excellent source for collecting specimens and they can be netted with a sweep net. Livestock may be tethered in tsetse fly areas or slowly led, while flies attracted to the animals can be netted. Tsetse flies do not oviposit. Rather, a single larva develops in the female fly's body and is “larviposited” immediately before it pupates. The pupa can be found buried in loose dirt and sand and can be collected by excavating and sieving this material. However, this is labor-intensive method that may not merit the time invested.

## **Filth Flies**

Certain species of the fly families Muscidae, Calliphoridae and Sarcophagidae are known as “filth” flies because they breed in, and feed on feces, corpses, other carrion and garbage. Under certain conditions, they are capable of mechanically transmitting gastrointestinal (diarrheas and dysenteries) and perhaps other types of diseases to humans. However, filth flies usually are more important as nuisances than as disease vectors. Filth flies are best controlled through environmental sanitation -- pesticides should only be used as supplemental control measures. Environmental control in many countries is difficult due to a cultural acceptance of garbage and feces in the environment. Filth fly populations usually grow explosively 7-10 days after a natural disaster, due to increase breeding opportunities offered by garbage, dead animals and even dead people.

Several methods have been developed for capturing and estimating the size of filth fly populations. If fly management is the main objective, trapping also can be an effective control tool in addition to a surveillance method. Otherwise the presence of a large population may obviate a requirement for surveillance. Only a few flies may constitute a nuisance and because all filth flies have similar habits, the “eyeball” method of surveillance will usually suffice. If the “eyeball” method discloses large amounts of filth flies, surveillance for fly larvae (maggots) should be conducted to find the source. Look for concentrations of feces, garbage, dead animals or other organic matter. Such accumulations of organic material should be easy to find and control maggots in such areas.

Fly traps should be placed close to the ground, and they should be checked at least weekly for flies and any other pests, such as stored product pests. The fly trap is essentially a screen cage with a funnel-type entrance. To use it, simply place it over bait selected to attract several species of domestic flies (spoiled milk, feces, food, etc.). Fly trap counts can give a quantitative index of fly populations, but remember to be consistent in trap locations, time of day collected, and the bait material used.

Use of the fly grill requires a person who is proficient at recognizing the various kinds of flies. To use it, place the grill over an attractant (such as garbage on a dump), and count the number of flies landing on the grill, or a predetermined portion of it, in a given period of time (usually 1 minute). With practice, it is possible to keep counts on several species at once. Maintain records of grill counts before and after actions such as breeding reduction, pesticide treatment, etc., because the counts can help demonstrate the effectiveness of management measures and determine when additional management techniques are needed.

### **Fleas**

Fleas are normally associated with rodents in the wild, and can be recovered from rodent burrows by swabbing. The burrow swab should be inserted into the rodent hole, then removed slowly, while rotating the handle. Fleas in the rodent hole will be briefly trapped in the folds and fibers of the cloth. They can be removed with forceps and placed in a vial of alcohol for subsequent identification. An easier method is to take many 4x4-inch squares of cloth to the field, and place each piece of cloth positive for fleas in an individual ziplock bag for removal after the fleas have been refrigerated or frozen to incapacitate them.

Fleas also can be removed from the bodies of trapped rodents. However, this is a complex and potentially dangerous task and should not be attempted without employing stringent safety measures. This technique is addressed further in the section on rodent surveillance.





**Figure 69. Using a burrow trap to sample for fleas.**

### **Human Lice**

Body lice are always a threat when large numbers of people are thrown together in close proximity after a disaster and live in unsanitary conditions. They will spread rapidly from infested to uninfested people -- if epidemic typhus is introduced, there is potential for an explosive epidemic. Mass delousing of infested people may become necessary in such situations. The presence of lice normally can be determined by visually examining suspected individuals and their clothing.

### **Cone-nosed Bugs or Kissing Bugs**

These insects feed off most domestic pets and the wild animals, and they are most often surveyed by finding them in direct association with their animal host. Common resting sites include the inside of mammal dens and nests. When inside human dwellings, kissing bugs typically hide in cracks and crevices of wall, or in loosely aggregated building materials such as thatched roofs in rural villages of Central and South America. Surveillance efforts should be focused on such areas. Because kissing bugs occurring in Mexico, Central and South America often are infected with *Trypanosoma cruzi*, the parasitic agent of Chagas' disease, careful attention should be given to their surveillance in these regions.

### **Bed Bugs**

Bed bugs are likely to be found only in the tufts, seams, and folds of mattresses and other bedding covers during early infestations. In areas of heavy infestation, bed bugs can be found in crevices in the bedsteads. Bed bugs also can be found in floor cracks, under carpets, behind loose wallpaper or

wall pictures, and similar structures. Houses and buildings with bird nests or roosts also can become infested with bed bugs. The human bed bug (*Cimex lectularius*) and its relatives (Family: Cimicidae) form a small group of bloodsucking insects. However, these insects have never been shown to transmit any human diseases. The bite of bed bugs often is painless, but a toxic saliva injected during feeding will later cause severe itching and an inflamed welt. A series of two to three welts are often produced in close proximity. Individual sensitivity and welt size may vary widely. Surveillance should include checking any place that offers protection, such as areas behind baseboards, under loose rugs or wallpaper, and bedding materials. For dense infestations, dark spots of fecal matter or blood and the cast skins may provide good clues to their presence. Glue traps, used to capture cockroaches or rodents, also are excellent means of detecting bat bugs and bed bugs. Place these next to baseboards and other places frequented by these insects. Control measures always should include removing or excluding host animals such as bats and bird that may be serving as permanent hosts.

### Ticks

Various species of hard and soft ticks are capable of transmitting numerous diseases, some of which can be life-threatening. Specific tick identification is necessary to determine disease threat. Hard tick surveillance takes advantage of the “questing” behavior of ticks in their habitat. Hungry hard ticks climb onto vegetation to wait for a suitable host for attachment. Ticks can be easily captured by using a tick drag, CO<sub>2</sub>, or by removal from host animals.



**Figure 70. A tick drag being used to sample for ticks along an animal trail**

Ticks adhere to the cloth of the tick drag as it is pulled through vegetated areas where ticks are questing. Collected ticks can be removed with forceps and held for identification. The best areas to drag for ticks are along animal trails where the vegetation is about knee level or shorter. Some designs of drags are pushed ahead of their operator rather than pulled. This may reduce the probability of ticks getting on the operator rather than the drag.

Tick drag operators can protect themselves from ticks while pulling the tick drag by wrapping

masking tape, sticky-side out, around the pant legs in one or two places (above the ankle and above the knee). Ticks will adhere to the tape, will not bite the operator and the tape serves as an additional source of surveillance.

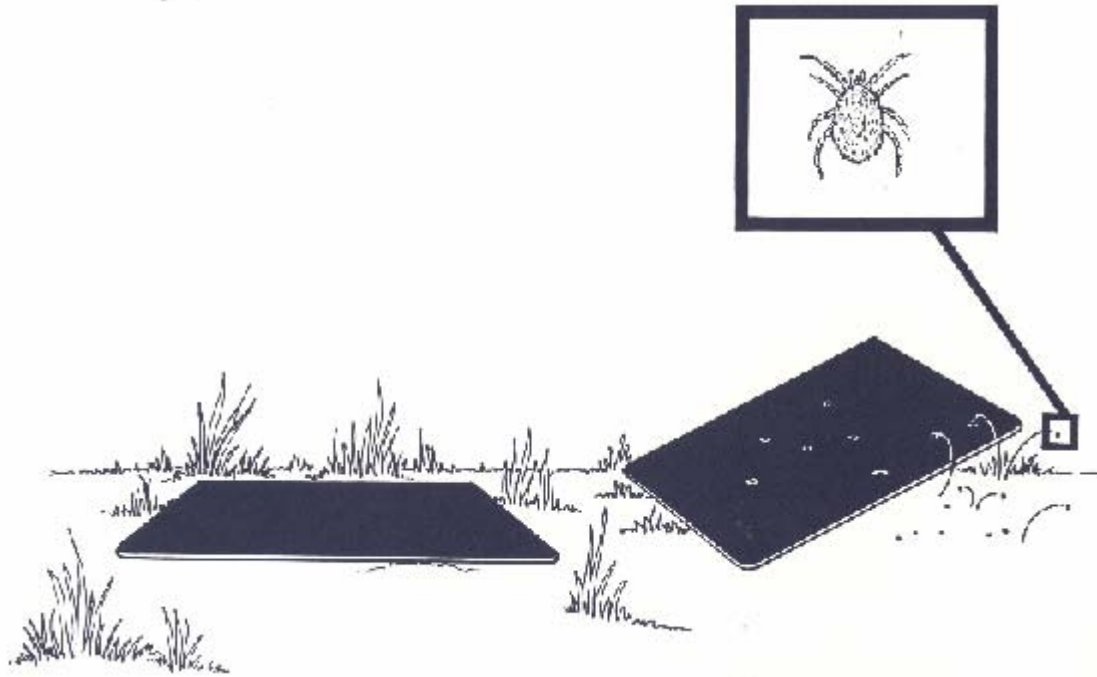
Ticks are attracted to CO<sub>2</sub>, and if they are active in a given area this attraction can be used for surveillance. Put a large block of dry ice (several pounds) on a sheet, board, piece of cardboard, or similar structure placed on the ground. Return in about 2 hours and examine both sides of the substrate for ticks. The long exposure time is necessary because ticks crawl slowly and take a long time to get to the CO<sub>2</sub> source, even though attraction is strong. However, this method may not be practical in all operational settings.

Some soft ticks, unlike hard ticks, are painful biters. However, soft ticks are only infrequently encountered in comparison to hard ticks. Although some soft ticks are attracted to CO<sub>2</sub> and may be captured as described for hard ticks, the best way to survey for most species in this group is visual inspection of their habitats: animal burrows, caves, cracks in rocks, abandoned buildings, etc. However, this is a difficult and time consuming effort best performed by well trained personnel.

### **Mites**

Larval mites of the genus *Leptotrombidium* transmit scrub typhus in parts of the eastern hemisphere. Else where, chigger mites (*Trombicula* and other genera) readily parasitize people resulting in itching, irritating bites. As a rule of thumb, if rodents are present then so are mites. Chigger mites are very small and are typically less than 1 mm in gross size.

Mites can be surveyed using the “black plate” method. The “black plates” (dark-colored construction paper, paper plates or similar objects) are placed on the ground in mite habitat such as grassy or brushy areas with high rodent populations. The mites are primarily rodent parasites and run around in these areas when not feeding on the rodents. Plates should be placed directly on the ground or ground cover. The plates have no particular attraction for the mites, but they crawl randomly on the plates and can be seen against the dark surface.



**Figure 71. An illustration of the black plate method of sampling parasitic mites.**

After at least an hour, examine both sides of the plates for small (smaller than a pin head), rapidly moving white, yellow, orange or red spots. Remove with a small camelhair (or similar) brush and place in alcohol for subsequent identification. Mites may be removed from an inflexible surface by wetting a small paint brush in alcohol, touching it to the mite, and then dipping the brush with the adhered mite into a vial of alcohol. The mite will float free in the alcohol. If construction paper or other flexible material is used, roll in a cone, place the small end of the cone over the vial and tap sharply. Mites will fall into the vial.

### **Snails**

Snails can be found in most types of aquatic habitats. However, snails that are the intermediate hosts of schistosomiasis, typically are semi-aquatic and are associated with standing water such as backwater areas of streams drainage ditches, and marshes. Snails can be found feeding on the surface of woody debris, vegetation, rocks, and similar structures though most can be found with in approximately one meter above or below the water line. Specimens can be collected by hand and placed directly into buffered alcohol, or collected in bulk with an aquatic dipnet. Living specimens can be examined for the presence of schistosome cercariae in the laboratory.

Snail densities can be estimated by counting all snails in a 1-meter stretch of stream near bank. Generally, low snail densities are considered those below 10/m<sup>2</sup>, moderate densities are those between 10-20/m<sup>2</sup>, and high densities are those greater than 20/m<sup>2</sup>. Although greater snail densities pose a greater chance of schistosomiasis infection in unprotected individuals, the presence of any snails can potentially pose a health risk. ALL standing or impounded water in the range of

schistosomiasis should be considered suspect for the presence of the parasitic cercariae. When collecting snails by hand from such water sources, always wear latex or rubber gloves for protection

## **Rodents**

Most rodent surveillance is accomplished to determine rodent presence and infestation levels in warehouses, dwellings and similar structures. Species determination is not particularly important. Surveillance in this case is usually done by visual survey for feces, damage, rub marks and sightings of dead or live rodents, or sometimes with live or snap traps or glueboards. Commensal rodents usually do not cause the problems in the field as they normally do at permanent installations, but other wild rodents may become nuisances or serve as reservoirs of disease. Rodents, as well as their ectoparasites, occasionally must be collected to determine the presence of known, or perhaps new, vector-reservoir systems.

### **Trapping rodents:**

Snap traps can be used, but must be used correctly to ensure that ectoparasites, particularly fleas, are recovered. Rat traps available through the National Supply System are too large and mouse traps are too small. The preferred trap is a “museum special”, which is intermediate in size and must be local purchased. Snap traps work better if the triggers are “expanded” with hardware cloth, thin metal, etc.



**Figure 72. Removing a rodent captured in a snap trap**

At sunrise or sunset, set 50 to 100 traps in a line in areas where rodents are active. Areas such as fence lines, along paths, where a wooded area meets a grassy area, etc., are ideal. Bait the traps with chewed oatmeal or other useful bait, and place the traps five to ten feet apart as rapidly as possible. As soon as the last trap is set go back to the first trap and start picking up the traps. If rodents are caught, put each rodent and the trap that caught it in a separate ziplock bag to make sure parasites remain associated with their hosts. Speed is essential. Fleas will leave a dead host as soon as its body temperature drops two or three degrees.



**Figure 73. Snap traps can be highly effective for sampling and controlling rodents**

Live capture traps of several varieties are effective in trapping rodents for ectoparasite surveys. These do not kill the rodent so immediate pickup is not as essential. They may be set in the evening and collected the next morning. If Sherman or similar solid-wall traps are used, they must be picked up very early in the morning or the sun will raise the temperature within the trap to levels lethal to the rodent, and ectoparasites will leave. As with snap traps, live capture traps with their contained rodent should be placed in individual ziplock bags so ectoparasites will not be separated from their hosts.

When the rodents are returned to the laboratory, they must be sacrificed (if living) and their ectoparasites removed. If identification of rodents in the field is impossible or impractical, the rodent should be prepared so it can be identified by an authority on rodents.

Live traps containing rodents can be placed in a killing chamber -- a large jar containing several gauze pads soaked with chloroform or similar anesthetic. This will put the rodent to sleep painlessly and continued exposure will kill it. Check the ziplock bag for ectoparasites and place any found in a vial of alcohol. Rodents also can be euthanized by placing them into a container with dry ice to which a little water has been added.

When the rodent is dead, remove it from the trap and check the trap and killing chamber for ectoparasites, which will also be dead. Place any parasites found in a vial of alcohol. Then the rodents must be processed in one of two ways to remove their parasites. Use a nit comb or small, stiff-bristled brush to vigorously brush the rodent, against the grain of the hair, into a white enamel cake pan or similar container. The ectoparasites will be brushed out of the hair and into the cake pan. Remove them and store in a vial of alcohol, along with any ectoparasites that were removed from the ziplock bag, trap and killing chamber. Or, fill a wide-mouth one-gallon jar or similar container half to three quarters full of water to which a small amount of surfactant or “non-sudsing” detergent has been added. Add the rodent and shake vigorously for one minute.

This will cause the ectoparasites to become detached. Remove the rodent from the jar, pour the water through filter paper and transfer any ectoparasites from the filter paper to alcohol.

It is sometimes necessary to identify the rodent from which the ectoparasites were removed, so host-parasite associations can be determined. In the field, a trained mammalogist or entomologist would prepare a “study skin” and this, plus the skull of the rodent, would allow identification by a properly trained individual. Rodents may be frozen and held for identification if available personnel are not able to make a specific determination.”

**Due to the risk of infection by hantavirus associated with rodents, handling rodents in the field without appropriate protective equipment is not recommended -- rodent collections should only be done where absolutely necessary and by trained personnel.**

Rodents can spread many diseases to humans and will bite, and they also will eat food supplies. During natural disasters, when living conditions are stressed, rodent infestations are particularly problematic. When dealing with rodents in a disaster in an OCONUS location, rodent control with anything but “deadly force” may be difficult. Recommended control techniques include:

- Environmental sanitation – living areas should be clean, and free of trash, waste and harborage. This will reduce the likelihood of reservoir and vector species seeking shelter or food in areas where troops may contact them. If an area is contaminated with rodent feces/urine, it should be disinfected. If there is minimal risk, a face mask should be worn that excludes dust particles, rubber gloves, and disposable or washable coveralls. Where there is a known significant risk, a virus-rated HEPA-filtered respirator, impermeable gloves and boots, and disposable clothing must be worn.

Dead rodents should be grasped with an inverted zip-locked plastic bag and the bag zipped closed with a gloved hand. Bare hands and arms should never be exposed to dead rodents and their fleas. The area where the dead rodent is found should be disinfected with soapy bleach water—do not vacuum or sweep dry surfaces before mopping. Steam clean or shampoo rugs and furniture if appropriate.

- Exclusion (rodent proofing) – use in small areas (storage, medical facilities, etc.) to prevent rodents from entering.
- Deadly force – use of traps, rodenticides, fumigants to kill rodents. However, always ensure that fleas associated with the rodents or their burrows are controlled prior to or at the same time that the rodents are killed.

<b>Common Name</b>	<b>Norway Rat</b>	<b>Roof Rat</b>	<b>House Mouse</b>
<b>Scientific Name</b>	<i>Rattus norvegicus</i>	<i>Rattus rattus</i>	<i>Mus musculus</i>
<b>Color</b>	Gray to reddish-brown to black	Gray brown to Black	Gray

<b>Body Characteristics</b>	Thick, blunt nose	Slender, pointed Nose	Petite, pointed Nose
<b>Length Head + Tail</b>	12-18 inches	14-18 inches	6-7 inches
<b>Tail Length vs. Body Length</b>	Shorter than head and Body	Longer than head & body	Same length as Body
<b>Weight</b>	10-17 ounces	4-12 ounces	1/2-3/4 ounces
<b>Ears</b>	Short, rounded	Large, prominent	Large, prominent
<b>Droppings</b>	3/4" long; both ends blunt	1/2" long; 1 or both ends pointed	1/4" long; 1 or both ends pointed
<b>Habitat</b>	Sewers, trash piles, basement, cellars, holes in ground	Trees and vines attics, rafters	Pantry/kitchen; rarely found in trash piles
<b>Habits</b>	Burrower	Climber	Terrestrial
<b>Living Range</b>	100-200 feet	100-150 feet	10-50 feet
<b>Feeding Habits; Preferences</b>	Omnivore; meats, garbage, grain, sewage, pet food	Omnivore; fruit, grain, nuts, snails, pet food	Omnivore; grain, cereals, fruits, sweets
<b>Food Consumption</b>	1 and 1/2 ounce/day	1 ounce/day	1/10 ounce/day
<b>Sexual Maturity</b>	3-5 months	3-5 months	1 and 1/2 months
<b>Gestation Period</b>	22 days	22 days	19 days
<b>Young Per Litter</b>	8-12	8-12	5-6
<b>Litters Per Year</b>	4-7	4-7	8
<b>Weaned Per Year</b>	20	20	30-35
<b>Lifespan</b>	1 to 7 years	1 to 7 years	1 year

Commensal rodents can be easily distinguished on the basis of body morphology and the shape of their fecal pellets.

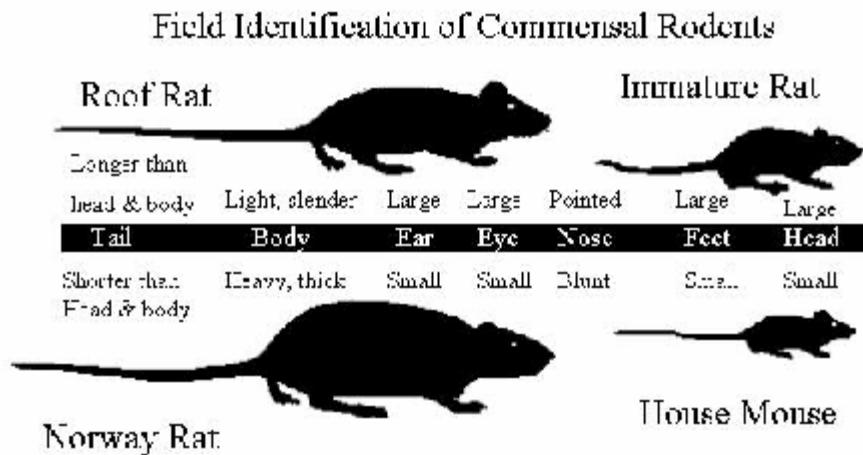
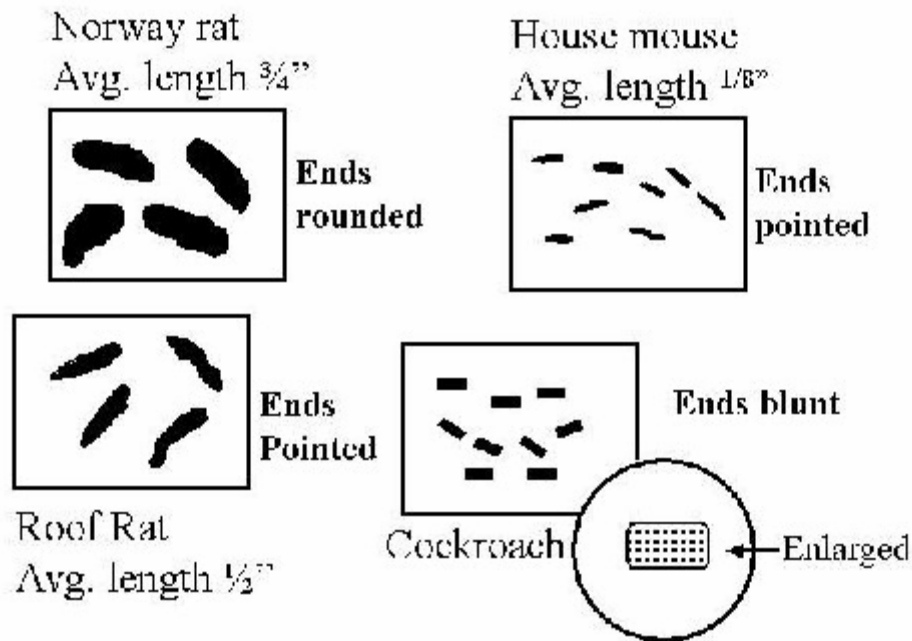


Figure 74. Some common morphological features of commensal rodents





**Figure 75. Differences in fecal pellets of commensal rodents**

## Section 5. Sampling and Interpreting Surveillance Data

Estimating population density for a vector or pest is the most common use of arthropod sampling data after the determination of their presence or absence from the area of operations. For instance, it is important to know that a potential malaria vector, *Anopheles*, occurs in the area of operations, but a more important and pertinent question concerns the population density of this vector. Large vector populations often are associated with an increased likelihood of outbreaks of disease. For military deployments, measures of relative abundance of vector/pest populations are the most practical means of assessing their size.

Sampling for obtaining an estimate of population density can be most easily achieved through a systematic approach. Systematic sampling involves using a predetermined approach such as placing light traps or ovitraps at the same locations and for the same amount of time, or taking the same number of dips with a mosquito dipper with the same form and spacing as used in previous efforts. A similar approach is to develop a serial sampling approach where trapping is conducted at the same locations, but at different times or dates to account for seasonality of the vectors.

The actual number of samples to be taken depends on the personnel available to conduct the work, and the complexity of the area of operations and associated vector/pest habitats. However, surveillance should always strive to use a minimum of three (3) concurrent samples of each type in an immediate sampling area to account for natural variation. For example, use three SSAM traps or ovitraps in the same immediate area if possible. Sampling should also be accomplished on a

scheduled basis when possible to account for weather related changes and seasonality. The extent and location of all continued sampling should be based on sound baseline information determined at the outset of the deployment.

In order to implement control or management decisions, an action threshold must be established based on surveillance data. Although baseline surveillance provides the important initial information of presence or absence of a vector or pest, abundance data collected during additional surveillance can provide important insight into their relative population dynamics. For example, if the number of female mosquitoes increased beyond a pre-established abundance index, then control measures may be warranted. The action threshold will be unique for each group of pests or vectors and operational location. However, if vector/pest populations are large and serve as a continuing threat to force health, then establishment of an action threshold may be irrelevant. Calculation of an abundance index is the foundation for determining an action threshold. For example, a weekly abundance, or trap index (TI) for adult female mosquitoes collected in light traps can be calculated as:

$$TI = \frac{\text{Total female mosquitoes trapped}}{\text{Total trap nights}}$$

Where total trap nights is calculated by multiplying the number of traps used by the number of nights operated.

This index of abundance can be modified as appropriate for specific species of mosquitoes, or other vectors (e.g., sand flies, larval dipping, tick drags), and can also be adapted to evaluate mosquito population dynamics among different days, especially following control measures to determine if they were effective.

## **Section 6. Packing and Shipping**

Proper packing and shipping of arthropod specimens helps ensure fast, accurate identifications. However, poorly packaged specimens can prove difficult if not impossible to identify. Some specific problems encountered include:

- Damaged specimens caused by crowding or improper packing (no mosquito should touch any other specimen).
- Stale specimens (they should not be held for more than one week before shipping).
- Male mosquitoes and non-target insects included in collections.
- Incompletely labeled containers.
- Incorrectly addressed shipments.
- Label information rubbed off or lost in transit.

### **Packing**

Properly packed, specimens have the best chance of arriving in good enough condition for the consultant to identify them. Proper packing protocol is as follows:

Containers of specimens should be properly identified with the following information:

Name of installation (base, camp, site, etc.)

Collection site (examples: Site No. 1, Alligator Swamp, Bldg. 33 -- always assign a site number to each collection site)

Method of collection (be sure to indicate type of trap, e.g., NJ light trap, SSAM light trap w/ CO<sub>2</sub>, dipper, etc.)

Collection date (day, month, and year)

Collector (e.g., A1C Joe Bagadonuts)

**Adult Specimens.** Adult specimens should be mailed as soon as possible after collection. Punctual recovery of adult mosquitoes from the traps will prevent loss and damage due to spiders, lizards, and other predators. To avoid injury to the delicate scale patterns, carefully separate the female mosquitoes from other captured. Moisture can also cause damage, so prevent condensation inside the kill jar whenever possible. Wet or moist mosquitoes should be allowed to air dry for 1/2 to 1 hour prior to packing. The necessary packing materials are facial tissue (such as Kleenex, not toilet paper) and plastic petri dishes or plastic water culture dishes (NSN 6640-01-030-9012). Figure 1 illustrates how to pack mosquitoes in petri dishes. Larger-sized petri dishes (NSN 6640-240-0035) may be necessary when submitting very large collections. Other adult arthropods can be shipped in a manner similar to this, and very sturdy specimens (such as ticks) can be shipped in vials.

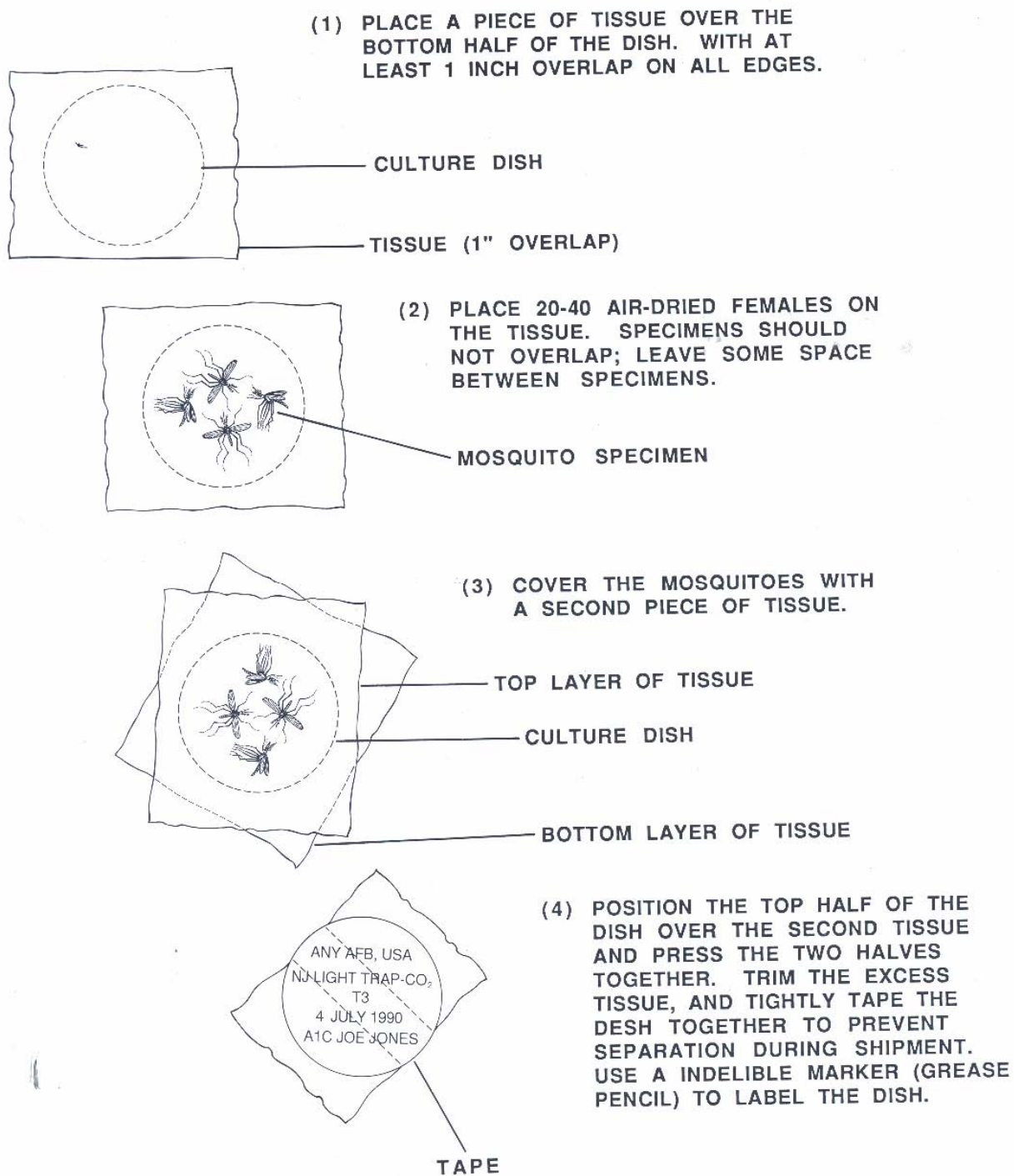
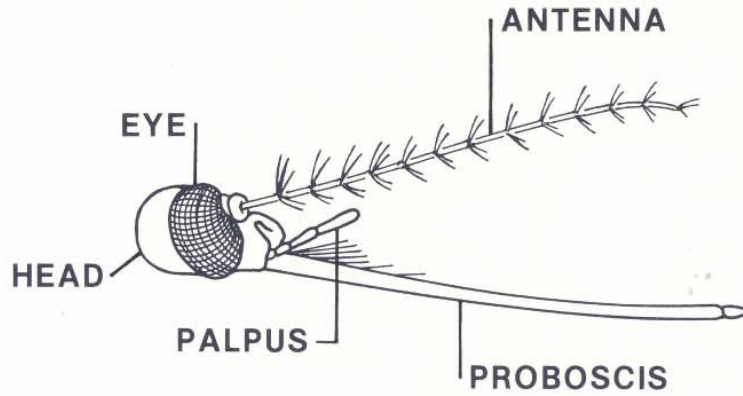
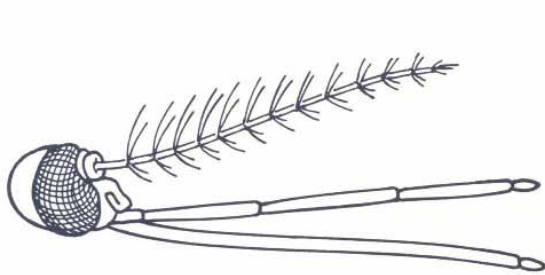


Figure 76. An illustration of the proper technique for packing adult mosquitoes for shipping.

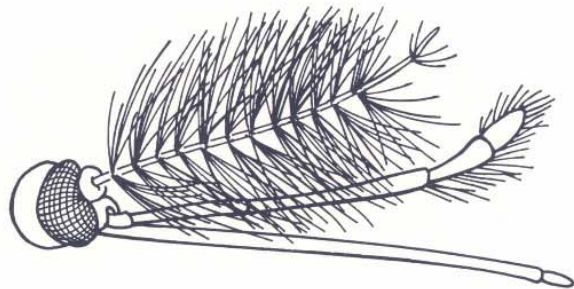
## HEAD APPENDAGES OF MOSQUITOES



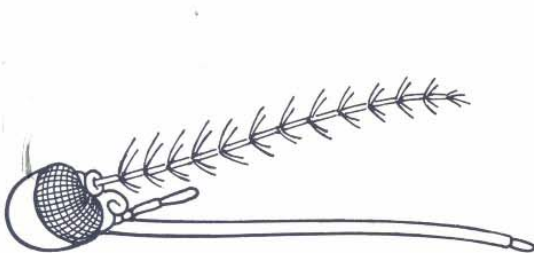
**MOUTHPARTS OF FEMALE MOSQUITO**



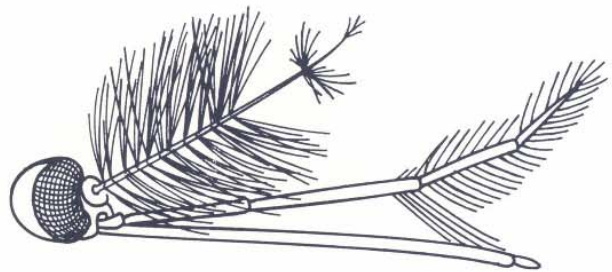
**FEMALE ANOPHELES HEAD**



**MALE ANOPHELES HEAD**



**FEMALE CULICINE HEAD**



**MALE CULICINE HEAD**

**Figure 77. An illustration of the head appendages of adult mosquitoes.**

**Larvae.** Larval specimens from one collecting site must be kept separate from larvae from other sampling sites. Larvae should be killed in hot (but not boiling) water to minimize distortion, and shipped to the consultant in vials or vacutainers containing 70-80% isopropyl or ethyl alcohol. Collection data, written on a piece of file card in pencil or India ink, are best placed directly in each vial. Specify the type of breeding site, (e.g., salt marsh, temporary pool, sewer drain, carcass, etc.) because such information can often help the consultant identify the larvae. Fill the container as full as possible prior to capping and remove air bubbles with a syringe. The stopper on the vial or vacutainer should be secured with tape as an extra precaution against leakage.

**Eggs.** Place paddles or red velour strips removed from mosquito ovitraps into individual plastic zip-lock bags or twist-tie the bags closed. Be sure to include collection data and site number on each plastic bag. Identification of eggs of arthropods other than mosquitoes is often not possible, but they can be packed in a similar fashion.

### Shipping

Pack petri dishes in a cardboard box or mailing tube large enough so that dishes are cushioned on all sides by at least 1 inch of packing material (styrofoam chips, cellucotton, wadded tissue, or paper towels work well). Wrap vacutainers with paper and pack them carefully in a box or mailing tube with packing material surrounding them. Similarly, cushion and package plastic bags containing ovitrap paddles or red velour strips. Shipping containers should be taped shut to prevent accidental opening en route.

Specimens should be shipped to an appropriate office or organization capable of providing identification services (see below). The place of shipment will vary depending on the deployment location, and the point of contact could be an entomologist with the U.S. Navy or U.S. Army. **NEVER SHIP LIVE SPECIMENS UNLESS YOU FIRST CONTACT THE INTENDED RECIPIENT AND THEY HAVE AGREED TO ACCEPT THE SHIPMENT.** If you have questions regarding packing and shipping of mosquitoes or other arthropod specimens, contact the medical entomology consultant for the area of deployment, or other appropriate individuals to determine the correct procedures (refer to Section 12 for a list of contacts that can provide such information).

Shipping from deployed locations can sometimes be a challenge because you may have to go through international mail systems. If feasible, using redeploying military personnel as couriers to the CONUS is one option for specimens of military importance. The shipments must be properly packaged and easy for the courier to mail if this is to be successful, and the mailing costs should be prepaid, or (best) stamps should be preapplied. Civilians must have collecting and export permits from the host country as well as US Fish and Wildlife Service Form 377, import permit, to take any specimens across national borders. Check with the appropriate customs authorities to see what regulations may apply to military personnel transiting the particular borders. **Do not attempt to “smuggle” specimens through foreign customs -- the repercussions of being caught far outweigh the potential loss of scientific data.**

## Section 7. Taxonomic Classification

The following scheme summarizes the hierarchy of taxonomic nomenclature used for all organisms and should be a useful guide for interpreting nomenclatural information in technical references. An example of the nomenclature of mosquitoes is provided.

Kingdom: Animalia

Phylum: Arthropoda

Class: Insecta

Order: Diptera

Family: Culicidae

Subfamily: Anophelinae (anophelines)

Genus: *Anopheles*

Subfamily: Culicinae (culicines)

Genera: *Aedes*                      *Mansonia*  
*Coquillettidia*      *Ochlerotatus*  
*Culex*                              *Orthopodomyia*  
*Culiseta*                          *Psorophora*  
*Deinocerites*                  *Uranotaenia*  
*Haemagogus*                  *Wyeomyia*

Subfamily: Toxorhynchitinae

Genus: *Toxorhynchites*

## Section 8. Biology of Pest/Vector Mosquitoes

Understanding mosquito biology is essential for effective surveillance and control programs. This section includes a general overview of the classification and bionomics of mosquitoes as well as more detailed information on important vector/pest species.

### Adults

Adult mosquito populations usually consist of about half males and half females. The males ordinarily emerge first and remain near the breeding site where they mate with the later-emerging females. Only female mosquitoes bite, and for most species a blood meal is required before eggs are produced. Females tend to travel greater distances and live longer than males. Flight habits vary

according to species and are affected by such diverse factors as wind speed and host availability. In the United States, *Aedes aegypti* flies only short distances (<100yds) and it usually breeds in and around human dwellings. Most anophelines have a flight range of about 1 to 2 miles, but some species may travel 20 miles or more. Accurate estimates of the average life span of the adult stage have been determined for only a few species. Estimates range from a few days for some to more than 6 months for overwintering females.

Female mosquitoes feed upon a wide variety of animal hosts ranging from cold-blooded amphibians to humans. Host selection is determined by a combination of host availability and by the innate host preference of the particular mosquito species. Daily biting activity varies according to species and season. Some mosquitoes bite mainly during the day, others at night, while still others show maximum activity during dusk and dawn. A few species do not blood-feed, but subsist entirely upon nectar or other plant exudates.

### Larvae

Mosquito larvae are found in virtually all kinds of aquatic environments except the rapidly flowing portions of streams and deep open waters of lakes and seas. Typical larval habitats include permanent ponds and marshes, temporary pools, tree holes, plant axils and leaves, and artificial containers. Larvae feed upon smaller organisms and detritus in the water. All mosquito larvae must come to the surface of the water for air, except those in the genera *Coquillettidia* and *Mansonia*, which obtain air by piercing the underwater portions of plants.



**Figure 78.** A sewage lagoon that provides excellent habitat for larval mosquitoes such as *Culex*.





**Figure 79. A livestock watering trough that can provide habitat for mosquito larvae.**

The larval period, which consists of four developmental instars, requires from 4 days to many months to complete depending upon the species and environmental conditions. Mosquito larvae molt (shed their skins) at the end of each instar. The final instar molts to become a pupa -- a nonfeeding transitional stage between the larva and the adult.

Mosquito larvae swim in two different ways: by undulations of the body and by propulsion with mouth brushes. When near the top of the water, anopheline larvae lie parallel to the surface and move by undulating, while culicines hang head down and move by using their oral brushes. Larvae are affected by both the abiotic (physical and chemical characteristics) and biotic (other organisms) factors of the water in which they develop. Abiotic factors such as temperature, light penetration, salinity, and gas content may limit development. Important biotic factors include pathogens, parasites, predators, competitors, and protective vegetation.

**Table 3. Biological data on medically important mosquitoes in the United States.**

<b>Mosquito Species</b>	<b>Larval Habitat(s)</b>	<b>Biting Activity</b>	<b>Flight Range</b>	<b>Transmits etiologic agent of</b>
<i>Aedes</i>				
<i>Aegypti</i>	AC	C, D	Less than 0.5 mi	DG, YF
<i>Albopictus</i>	AC, TH, RH	D	Less than 0.5 mi	DG, (CE), (WNV)
<i>Vexans</i>	FW, GP, IP	C, N	1-5 mi	CE, (EEE), (WNV)
<i>Anopheles</i>				
<i>Crucians</i>	SM, FS, LM	C	1-2 mi	(M), (VEE), (EEE)
<i>Freeborni</i>	RF, DD	C	1-2 mi	M, (WEE), (SLE)
<i>Quadrimaculatus</i>	FW, GP, LM	C	0.5-1 mi	M, (WNV)
<i>Coquillettidia</i>				
<i>Perturbans</i>	FS, GP, LM	C	1-2 mi	(EEE), (VEE), (WNV)
<i>Culex</i>				
<i>Nigripalpus</i>	GP, FW, DD	C	0.5-1 mi	SLE, (WNV)
<i>Pipiens/quinqüefasciatus</i>	AC, SCB, GRP	C, N	Less than 0.5 mi	SLE, (WEE), (VEE), (WNV)
<i>Restuans</i>	WP, GRP, DD	C, N	1-2 mi	(EEE), (WEE), (WNV)
<i>Salinarius</i>	GP, LM, FS	C, N	1-5 mi	(EEE), (WNV)
<i>Tarsalis</i>	IP, RF, GRP	C, N	1-2 mi	WEE, SLE
<i>Culiseta</i>				
<i>Inornata</i>	GRP, DD	C, N	1-2 mi	(WEE), (CE)
<i>Melanura</i>	FS, WP	C, N	0.5-1 mi	EEE, (WNV)
<i>Mansonia</i>				
<i>Titillans</i>	FS, GP, LM	C, N	1-5 mi	(VEE)
<i>Ochlerotatus</i>				
<i>Dorsalis</i>	SM, LM	D	10-20 mi	(WEE)
<i>Japonicus</i>	RH, AC	D	0.5-1 mi	(WNV)
<i>Melanimon</i>	IP, FW	D	1-2 mi	WEE, CE
<i>Mitchellae</i>	GP, FW	D	0.5-1 mi	(EEE)
<i>Nigromaculis</i>	IP, FW	D	1-2 mi	(EE), (CE)
<i>Sollicitans</i>	SM	C	5-10 mi	EEE, (WNV)
<i>Taeniorhynchus</i>	SM	C, N	5-10 mi	VEE, (CE)
<i>Triseriatus</i>	TH, AC	D	0.5-1 mi	CE
<i>Trivittatus</i>	GP, WP, FW	C, N	0.5-1 mi	CE, (WNV)
<i>Psorophora</i>				
<i>Columbiae</i>	IP, RF, GRP	C, N	1-5 mi	VEE, (WNV)
<i>Discolor</i>	IP, RF, GRP	C, N	1-5 mi	VEE

<sup>1</sup>AC = artificial containers; DD = drainage ditches; FS = freshwater swamps; FW = flood waters; GP = grassland pools; GRP = ground pools; IP = irrigated pastures; LM = lake margins; RF = rice fields; RH = rock holes along streams; SCB = sewer catch basins; SM = saltwater marshes; TH = tree holes; WP = woodland pools

<sup>2</sup>C = crepuscular (dusk and dawn); D = day; N = night

<sup>3</sup>Values given are estimates of normal flight ranges. For some species, seasonal migratory flights may be 10X these values.

<sup>4</sup>Parentheses indicate secondary or suspected vectors, otherwise, primary vectors. CE = California group encephalitis; DG = dengue; EEE = Eastern equine encephalitis; M = malaria; SLE = St. Louis encephalitis; VEE = Venezuelan equine encephalitis; WEE = Western equine encephalitis; YF = Yellow fever.

## Section 9. Point Source and Psychological Threats

- **Point Source Threats** -- things of obscure origin that can cause severe injury or death in a very short period of time.

- **Psychological Threats** -- things that do not kill or threaten health, but can make life extremely unpleasant.

### Point Source Threats

There are many different potential point source threats that can impact any given deployment. Following are some examples of more common point source threats and a brief description of their potential impact to military personnel.

Although the most potentially dangerous animals likely to be encountered are invertebrates, large wild animals are capable of killing or maiming people. Death from wild animals occurs only rarely through predation while most attacks are through accidental or intentional mauling and stampeding due to territorial infringements. Caution should also be exercised when in the presence of domesticated livestock. For example, captive water buffalo (carabaos) in Southeast Asia are notoriously bad-tempered, and range bulls in Australia have been known to kill unwary trekkers.

A number of smaller wild carnivores can be found during any deployment. Although these animals might attack if cornered, the most significant risk they present is from rabies. Never assume that any wild animals are exempted from rabies infection. Even domestic cows and llamas occasionally become infected with rabies. However, the most dangerous animal in many countries is the dog and the primary threat is from rabies. Packs of wild and semi-wild dogs occur in some areas of the world. Dog packs have been a problem in Mideast deployments, especially in landfill areas or where food is available. Rabies is hyperenzootic in many developing countries and can represent a significant health threat. Commensal rodents, particularly roof rats and Norway rats, serve as reservoirs for several disease, and hosts for parasites that can infect people.

Damage caused by rats and other rodents is often unfamiliar to most Americans. Rats can become aggressive when cornered or hungry and may give painful bites. Occasionally such bites require hospitalization, and rats also have been known to kill or maim individuals unable to defend themselves. This is particularly true during contingency operations to disrupted environments such as those associated with war, conflict, or natural disasters.

**Reptiles** other than snakes are not often encountered, but contact with large reptiles including alligators and crocodiles is a realistic possibility in some parts of the world. Venomous snakes are addressed in Section 13.

**Spiders**, in general, are harmless to people. However, a few species are capable of causing serious damage or death in victims.

Black widow spiders, *Latrodectus* spp. are among the most dangerous spiders in the world. They are normally timid, medium-sized spiders (<1 inch long), and shiny black in color. The abdomens are variously marked with red spots or other shapes. The red hour glass on the Southern black widow, *Latrodectus mactans*, is perhaps the most recognized mark among these spiders. Representative of this group of spiders occur worldwide. Other widow spiders of importance occur in the Middle East, Africa, Asia, and throughout the Western Hemisphere. Other examples include the Brown Widows (cosmotropical, common in the South), Red Widow (Central and southern Florida), and Northern Widow (Northern Florida to southern Canada). These widow spiders should be considered moderately dangerous. Black widows normally will not bite unless provoked or contacted by accident. Toxicity of the venom is highly variable depending on the species.

- The neurotoxic venom of some species is up to 15 times more potent than rattlesnake venom.
- Bites are not very painful and may not be felt initially, or there may be slight localized reddening and swelling. However, envenomizations usually result in severe muscular pain, rigid “boardlike” abdominal cramping, tightness of the chest, difficulty breathing, and nausea.
- Black widow bites can be variously misdiagnosed as ruptured ulcer, acute appendicitis, renal ulcer, or food poisoning.
- Mortality rate can be 4-5% without treatment.
- Antivenin is available and useful if used within 3 hours after envenomization -- treat symptoms that may develop.

The genus *Loxosceles* (recluses or fiddlebacks) are commonly distributed throughout the Americas. The brown recluse, *Loxosceles reclusa*, is perhaps the most recognized member of this group. The fiddle-shaped mark on the cephalothorax, long legs and sleek, brown coloration are characteristic of this group.

- The brown recluse bite is not particularly painful and may not be felt at all. Multiple bites in a single attack are not uncommon.
- The venom is necrotic, and destroys the tissues of the victim. However, not all bites cause necrosis and the extent of necrosis is highly variable among victims ranging from a small “pimple” to severe “craters” that may take months to heal. A

typical bite results in a lesion the size of a dime or smaller, raised around the edges and sunken in the center. There may or may not be a scab in the center. If the lesion is large, involves key tissues, or if there are systemic complications, additional medical care may be needed.

The Sydney funnel web spider (*Atrax robustus*) is considered to be the most venomous and dangerous spider in the world. This relatively large (up to 3 inches long) spider is capable of killing an adult human and several deaths have been attributed to its bite. However, deaths are still considered rare. These spiders tend to tightly grip the victim and bite repeatedly. An antivenom is available in Australia. Fortunately, these dangerous spiders are restricted to a radius of approximately 100 miles around Sydney, Australia.

Tarantulas are widely feared, but they are not considered to be dangerous. Their bites are similar to a bee or wasp sting. Their fangs are quite large approaching the size of a pair of large needles and bites are quite painful.

**Scorpions** have painful stings and several species can be deadly to humans. Generally, small species with slender claws are the most dangerous, whereas larger species with big claws tend to be less venomous -- however, untrained personnel should never attempt to gauge the danger potential of scorpions based on size alone.

- Most areas of the world have one or more species of particularly dangerous scorpions.
- In Chihuahuan and Sonoran deserts of North America and Mexico, there are only a few dangerous species of scorpion. Stings from these species typically do not swell or redden. Those of most other scorpions in North America do one or both.

**Honeybee** stings kill more people annually around the world than poisonous snakes. Bee stings are painful, but, for most people, that is the only effect. Others however, can have an allergic reaction to the sting and can die from anaphylactic shock. A single bee sting can result in death.

- Deaths caused by honeybee stings are due to anaphylactic shock. An initial sting sensitizes the body's immune system, a subsequent sting, which may occur years later, causes shock and sometimes death.
- Africanized honey bees are becoming more widely distributed in the United States since crossing the border from Mexico in the early 1990s. These bees are more aggressive, attack in larger numbers and pursue further, but their venom has no more toxicity than "tamer" races of honey bees.
- If you are "investigated" by a honey bee, do not antagonize it. This could cause the bee to sting and release an "alarm pheromone" which signals other bees to attack.
- If attacked, literally "run for your life"-- get indoors, in a vehicle, tent, any kind of shelter, if possible, and if not, run through brush in a zig-zag pattern to disorient the bees.

- Honey bee stingers are barbed and they, along with the attached venom gland, will remain imbedded in the skin because they are pulled from the bees abdomen following the attack. As long as the stinger remains inserted in the skin, the venom gland will continue to pump venom into the host until the supply is exhausted. To prevent this from occurring, the stinger(s) should be removed as quickly as possible using a straight, sharp edge such as a fingernail, credit card, knife blade or similar tools. Never attempt to remove a stinger with the fingertips as this may actually force more venom into the victim.

**Fire ants** in the southern United States and southward through South America can be a severe problem because of their unusually large numbers and potent venom.

- Their venom is necrotic, like that of the brown recluse spider, but not as potent. Characteristically, a blister forms, the liquid within solidifies and when the blister goes away there is a small pit that may persist several weeks.
- Normally one does not get just one fire ant sting, and the stings are often quite numerous, because they swarm their victim and release a chemical signaling others to sting, often overwhelming their victim as a result.

**Wasps** and **hornets** are present in virtually all areas of the world except the poles. They resemble each other in appearance, and in having painful stings. Unlike honeybees, wasps and hornets have straight stingers and they can sting multiple times. Most stings caused by wasps and hornets only cause pain and are more a nuisance than anything else, and are rarely fatal.

**Centipedes** normally are harmless, but larger species are capable of inflicting painful itching “bites.” The “bite is actually produced by the first pair of legs which are modified into claws capable of injecting venom. Centipede “bites” have a characteristic appearance, a series of paired puncture wounds caused by the centipede “chewing” with its poison claws to inject poison.

**Chiggers** are small mites, which insert their mouthparts into pores and inject their saliva. This affects the surrounding cells and causes intense and long-lasting itching. They will characteristically crawl up the body until they reach an area constricted by clothing (sock top, underwear band, etc.) and feed in that area. Throughout Asia, chigger mites are capable of transmitting scrub typhus.

**Scabies** mites also cause severe and very long-term itching. The mites burrow beneath the skin surface and live out their life cycles there. Scabies is spread by dermal contact, and they can be found on most parts of the body but most commonly on hands, feet, groin, folds of buttocks and under breasts. The rash caused by scabies is very easy to detect. Scabies may lead to secondary infection if scratched with dirty fingernails (all bites can be infected this way).

**Biting bugs**, including wheel bugs, giant water bugs, backswimmers, bed bugs, (*Cimex lectularius*) can inflict very painful bites with their piercing-sucking mouthparts; some can inject non-lethal toxic venom. The pain stops spontaneously in one to four hours. Although such bites are not life-threatening, severe psychological distress may result. More information on bed bugs is presented in Section 4.

**Blister beetles** are not a severe pest in terms of pain and suffering, but they can inflict fairly serious lesions.

- Blister beetles are soft-bodied beetles 1/4 to 1 inch long, in various colors and color patterns, with a well-defined “neck” and “shoulders.”
- When crushed against skin, they release a substance that causes a large, painless blister or vesicle. The lesion requires careful management and there is danger of secondary infection. If a blister ruptures additional blistering may occur where the fluid touches the skin. Thus, scratching can lead to extensive damage in some individuals.

**Urticating insects**, primarily caterpillars that have hollow hairs filled with poison can be encountered around the world. When contacted by humans, hairs embed, break off, and release venom. Venom causes local and sometimes systemic reaction. This produces an urticarial rash. An example is the puss caterpillar.

- The lesion from puss caterpillar contact often looks like an outline of the caterpillar. Stings are extremely painful, and the victim may be sick for 2 or 3 days. Some require overnight hospitalization for supportive care.
- First aid is to remove hairs with adhesive tape -- stick on the area, then pull off. Then cleanse the wound with alcohol. Secondary exposure of patient care providers does occur and medical staff should wear protective gloves and take care not to come into contact with the hairs.

**Head and Body Lice** have seldom been a problem to troops since World War II, however, the possibility of epidemic typhus is ever-present, especially in refugee situations like those faced during many recent humanitarian assistance deployments. The crab or pubic louse does not vector disease but causes severe itching where it feeds. Proper personnel hygiene and permethrin treated clothing serve to prevent louse infestation among U.S. military forces.

**Fleas** can be a problem in areas where dogs and cats roam free in urban areas, and in “wild” areas where wild rodents and their fleas can be contacted. Fleas normally are not a severe nuisance, but can be when they are present in large numbers. Flea bites feel like a strong pin prick, producing reddening, swelling, itching. Site encampments should be located in areas distant from rodent burrows and their associated fleas. **Tunga fleas** (chigoes) found in tropical areas differ from other fleas in that they burrow into the skin, often under toenails. Chigoes should be removed in a sterile manner to prevent secondary infection, which can lead to autoamputation of the digit under extreme conditions like those encountered in contingency conditions.

**Biting Flies** rank among the most annoying insect pests and can be a severe distraction for military members in an operational environment. For example, **horseflies** and **deerflies** can cause severe biting trauma. They tear a wound into the flesh with their mouthparts and then lap up the blood -- the bite is very painful. In some areas these flies occur in large numbers, thus making outdoor activities difficult. **Stable Flies** (or dog flies) are very persistent, painful biters and they occur

throughout most of the Americas. **Black flies** have painful, irritating bites, and because they are fairly strong flyers, they can become a nuisance some distance from breeding sites. **Sand flies**, although small in size, have very irritating bites. **Biting midges** (no-see-ums, sand gnats) arguably are the most irritating of all the small flies that feed on people. They occur periodically, at certain times of the day, but can drive people inside at those times. Some people become very allergic to no-see-um bites and experience reactions that resemble the lesions produced from contact with blister beetle. **Mosquitoes** can cause serious annoyance problems in addition to spreading diseases, and their bites can produce itchy wheals that can become secondarily infected. **Tsetse flies** can inflict painful bites in addition to being vectors of African sleeping sickness, and they can pose a significant threat to force health during deployments to central Africa. More details on selected biting flies is presented in **Section 4**.

**Land leeches** are blood feeders with a largely tropical distribution. The wounds they produce are usually painless, but because of anticoagulants injected at the feeding site to prevent their hosts' blood from clotting, the wounds often bleed for a long time. Such wounds can become easily infected if not kept sterile, or infested by other opportunistic insects. Leeches also can be a source of psychological distress.

**Allergens** originating from arthropods can cause a multitude of problems. The tussock moth is a hairy caterpillar whose hairs are not venomous but when molting in large numbers, hairs are shed and may be ingested, inhaled, or rubbed into skin, causing severe allergic "hay fever" symptoms.

### **Psychological Threats**

Vector and pest organisms can pose psychological threats. Often this is a cumulative effect -- the more negative experiences, the greater the negative impact on health and welfare. Many things can have direct and serious effects on deployed troops, and sometimes these impacts develop cumulatively. Their importance increases with the number and diversity of the pests, the quality or lack of quality in field conditions, the ability to escape the pests, and fatigue and stress. Nuisance pests can, in some situations, be a worse threat to the mission by depleting morale than actual disease. This is particularly true when disease incidence in an area is low and pest incidence is high. Be sensitive to the non-vector effects of insects and other animals, particularly if there is a way to lessen the impact of such effects on deployed personnel. Psychological threats can be divided into two general categories:

**Entomophobia** -- irrational fear of insects (usually includes other arthropods, such as spiders, ticks, mites, etc.), or the damage they are capable of inflicting or the diseases they carry.

**Delusory parasitosis** -- an emotional disorder characterized by the unfounded belief that parasites of some sort, usually insects or mites, are living on or around the body.

Our perceptions of insects, true or untrue, cause us to fear them irrationally. Out of ignorance, disgust, and fear, we give insects attributes that they do not have. For example, neither cockroaches nor any other insects carry AIDS, but the media portrays them in exaggerated ways, thus convincing many people that they are experiencing a problem that is actually non-existent. Examples of insects or diseases that can produce severe psychological stress in deployed military forces include:



**Cockroaches** in particular are loathed and often unnecessarily feared. One study showed 42% of people surveyed disliked and feared insects outside the home, and 88% disliked or feared insects inside the home.

**Insects** and **insect parts** in food can depress certain people, and particularly Americans who generally are not accustomed to such things. Many places in the world tolerate a large load of bugs in the food -- in fact, insects may be the main course. Americans have been conditioned to expect perfectly uncontaminated food, even if an unappetizing item has no taste and has been heated to the point it is sanitary. Even the thought that an insect may have crawled across the plate is repugnant.

**Leishmaniasis**, a disfiguring disease transmitted by sand flies, is one that can elicit strong negative responses among the uninformed due to fear of contracting the disease even though chances are small and treatment is available.

**Elephantiasis**, caused by filarial worms spread through mosquito bites, is another example of something that has a significant psychological effect. The severe disfigurement accompanying chronic cases can produce irrational fear of contracting the disease, even though the risk is low for individuals who practice personal protection and are on occasional deployments of relatively short duration.

**Myiasis**, or infestation of human flesh by fly larvae, is unusual, but serious when it occurs. Depending on the species, these flies may feed on living or dead tissue produced from injury. Such infestations can cause severe psychological distress on military forces.

## Section 10. Common Vectorborne Diseases and Zoonoses of Military Importance

The intent of this section is not to serve as a definitive source of information about diseases or their treatments. Rather it is intended to be a summary of the common human diseases and zoonoses, their known vectors, and their generalized distributions. This may help the reader better estimate the suite of disease and vector threats for their particular area of operations. A summary of these diseases is shown in Table 4.

**Table 4. Common Vector-borne diseases and zoonoses of military importance**

<u>Disease</u>	<u>Primary Vector/Host/Reservoir</u>	<u>Distribution</u>
	<b><u>Mosquitoes</u></b>	
Malaria	<i>Anopheles</i> spp.	Worldwide in tropical and temperate areas
Dengue	<i>Aedes aegypti</i>	Worldwide in tropical areas
Japanese encephalitis	<i>Culex</i> spp.	Asia
Yellow fever	<i>Aedes aegypti</i>	South America, tropical Africa
	<b><u>Sand Flies</u></b>	

Leishmaniasis *Phlebotomus* and *Lutzomyia* spp. Old and New World tropics

**Tsetse Flies**

African trypanosomiasis *Glossina* spp. Sub-Saharan Africa

**Cone-nosed / Kissing Bugs**

American trypanosomiasis *Rhodnius*, *Triatoma*, *Panstrongylus* spp. Central and South America

**Body Lice**

Louse-borne typhus, Epidemic typhus *Pediculus humanus humanus* Worldwide

**Fleas**

Plague Various species Worldwide

Endemic typhus (Flea-borne typhus) Various species Worldwide

**Mites**

Scrub typhus *Leptotrombidium* spp. Asia, Western Pacific

**Ticks**

Lyme disease *Ixodes* spp. Worldwide

Human granulocytic ehrlichiosis *Ixodes* spp. North America, Asia, Europe

Human monocytic ehrlichiosis *Amblyomma americanum* North America

Spotted fevers Various species Worldwide

Rocky Mountain spotted fever *Dermacentor* spp.

North Asian tick-borne typhus *Dermacentor*, *Haemaphysalis* spp.

Mediterranean spotted fever *Rhipicephalus sanguineus*, *Haemaphysalis leachi*, *Hyalomma rufipes*

Oriental spotted fever *Dermacentor taiwanensis*, *Haemaphysalis flava*

Queensland tick typhus *Ixodes holocyclus*

Tick-borne encephalitis *Ixodes persulcatus* Europe, Asia

Crimean-Congo hemorrhagic fever *Hyalomma* spp. Asia, Europe, North Africa

	<b><u>Snails</u></b>	
Schistosomiasis	Various freshwater snails	Africa, Asia, Middle East, South America
	<b><u>Rodents</u></b>	
Hantaviral diseases	Various rodents	Worldwide
Leptospirosis	Various rodents	Worldwide
	<b><u>Other</u></b>	
Rabies	Various mammals	Worldwide

## Section 11. Hazardous Plants

Most plants are not harmful, but contact with certain plants can cause symptoms ranging from minor irritation to death. Awareness of potentially harmful plants in a deployment area will help avoid injuries from them, and help you to successfully use them in a survival situation. Know the threat for the particular area you will be deployed to, and warn deploying troops how to avoid trouble with plants. Forewarned is Forearmed.

Hazardous plants generally cause harm through ingestion or contact with poisonous plants, or inhalations of pollen or poisons carried by the smoke of burning vegetation.

### General Rules for Avoiding Problems with Hazardous Plants

Be able to identify plants with absolute certainty and to know its uses or dangers. Many times this is not possible.

Avoid eating or touching plants unnecessarily, and always avoid all mushrooms.

Toxicity of plants varies with the individual and the situation.

Some plants require contact with a large amount of the plant material before causing an adverse reaction while others will cause death with only a small amount of contact.

### Plants and their Poisons

Alkaloids: Poison Hemlock, Tomato  
 Cyanogenic Glycosides: Apricots, Cherries (seeds, leaves, bark)  
 Anthraquinone Glycosides: Aloe, Rhubarb  
 Cardioactive Glycosides: Digitalis, Adonis  
 Saponin Glycosides: Yams, Agave  
 Coumarin Glycosides: Wormwood, Buckeyes  
 Oxalates: Rhubarb, Purslane  
 Resins: Milkweeds, Rhododendron

Phytotoxins: Castor Bean (Ricin)

**Hazardous plants can be difficult to distinguish positively:**

- Many poisonous plants closely resemble their edible relatives or other edible plants.
- Certain plants are safe to eat in a season or stage of growth but poisonous at other times.
- Some contain both edible and poisonous parts.
- Some are poisonous raw but specific preparation methods may make them edible.
- Some are poisonous in one area, but less so or not at all in others.

**Ingestion Hazards**

**Signs and Symptoms of Ingestion Hazards**

- Nausea
- Vomiting, diarrhea, abdominal cramps
- Depressed heartbeat and respiration
- Headaches, hallucinations
- Dry mouth
- Unconsciousness/coma
- Death

Ingestion poisoning can be very serious and can lead to death very quickly due to effects on the gastrointestinal system or central nervous system.

**First Aid for Ingestion Hazards**

Try to remove the poisonous material from the victim's mouth and stomach as soon as possible.

Induce vomiting by stimulating the back of the throat to initiate the gag reflex or by administering warm salt water, or

Dilute the poison by administering large quantities of water or milk.

**Prevention of Ingestion Hazards**

Never eat any plant or mushroom unless you have positively identified it first. Mushroom identification is very difficult and must be precise. Some mushrooms cause death very quickly, and have no known antidote. Mushrooms are not recommended for consumption because of the danger of poisoning and possible death. In a situation where you must consume plants to survive, keep a record of all plants eaten and any effects, to avoid repeating mistakes. Examples of plants that can produce ingestion hazards include oleander, water hemlock, castor bean, and chinaberry. However, many other species are known to produce ingestion hazards.

## Contact Hazards

The principal harmful contact effects include:

Direct injury due to sharp parts (spines or sharp edges) that pierce, cut, or scratch

Minor to severe cuts, scratches, punctures, and abrasions accompanied by pain and bleeding, with possibility of secondary infection. Some grasslike plants have long knifelike leaves set with minute, sharp teeth that can cut severely. The tips of some spine-leaved plants are needle sharp and break off readily in the flesh, sometimes requiring the assistance of a doctor to remove them.

Thoroughly clean cuts, scratches and punctures with soap and water or alcohol to remove contamination, dress with antibiotic, and keep clean. Remove spines or thorns as soon as possible, using care not to exacerbate the wound, contaminate it, or inflict more punctures during the removal process. Infections associated with punctures from plants can be very dangerous.

When necessary, plants should be cleared from areas in which people work or play. Wear protective clothing and heavy gloves to prevent cuts during contact.

Examples of plants that can cause contact hazards include stinging nettle, cactus, yucca, and briars. However, many other plants can produce contact hazards.

Toxic effects from plant substances that get on the skin upon contact with the plant

Many different plants can produce toxic effects in people. Among the worst of these however, are poison oak and poison ivy (addressed below), Poison sumac (*Toxicodendron vernix*), Poisonwood (*Metopium toxiferum*), Manchineel (*Hippomane mancinella*), and all members of the spurge family (ex. *Euphorbia* spp.).

Reactions to toxic plants can be localized or spread over the body, and they may be persistent and spread to other areas by scratching. Symptoms may take from a few hours to several days to appear. Contact in or around the eyes and other sensory organs or membranous areas is especially dangerous. Some plants may be handled with immunity for years and then suddenly be reactive. Individuals are sometimes affected more often by wet leaves than by dry when working with similar toxic plants.

### Poison Ivy and Poison Oak

All parts of the plant (roots, leaves, stems) secrete an oily substance, which may be rubbed off onto clothing, hands, arms, or face. People who have not been outside can become afflicted by handling clothing contaminated with the oil from these plants. Oil may also be carried by smoke from burning vegetation. Severe, incapacitating outbreaks from poison ivy are not uncommon. At first the skin begins to itch, later many small blisters develop. If the victim scratches the blisters, it will greatly aggravate the condition, but cannot spread the eruptions to other parts of the body. Getting a

rash on sensitive tissues, especially the eyes and the genitalia are especially dangerous. One trait the poison oaks and ivies have in common is their cluster of three leaflets, more or less pointed at tip and base and broadened, often irregularly, at the middle. All species of *Toxicodendron* are similar in their effect on the human epidermis. These plants may be handled with immunity for years and then suddenly have an outbreak. An attack does not make one immune; in fact, victims become more and more susceptible.

### **First Aid for Toxic Effects**

When the poisonous plant is first contacted or initial symptoms appear, try to remove the poison by washing with soap and water.

If water is not available, and blisters have not developed, wipe the skin repeatedly with dirt or sand to adsorb the poison - Do not use dirt if blisters have developed because it may break them open and lead to infection

After the poison has been removed, keep the affected area clean and dry.

Medications are available to neutralize the poison.

If specific medication is not available, the individual may bathe with baking soda to help neutralize the oil, followed by lathering with soap and a very thorough rinsing. Care should be taken not to rub wrists and arms with the towel. When bathing is impractical, exposed skin should be washed with alcohol.

Clothing worn in the field may be contaminated with the poisonous oil, so shirt, socks, pants, and boots (both the sides and the soles) should be washed in hot, soapy water. Sometimes clothes must be discarded if the wearer is extremely sensitive.

### **Prevention of Toxic Effects**

Individuals susceptible to dermatoses due to plant poisons should be especially careful to avoid brushing against those plants, and stay out of the underbrush if possible.

Never burn a poisonous plant because the smoke may be as harmful as the plant.

The danger of being affected by toxic substances in plants is greater when perspiring because skin pores are more open and poisons are able to penetrate the skin more easily or more deeply.

Poisons from plants can also get on clothing and equipment and then affect people touching contaminated equipment, and also can be carried by smoke from burning plants. Cutting, mowing, or otherwise affecting the integrity of the plant greatly increases the chance of contamination.

## Section 12. Venomous Snakes

Snakes can negatively impact military operations. Their presence alone is sufficient to cause anxiety among troops, sometimes enough to negatively impact performance. However, only venomous snakes pose a serious health threat to people. If bitten by a venomous snake, the victim may be temporarily or permanently disabled, and in some cases killed. Venomous snakes are found almost everywhere, therefore their potential impact on military operations is worldwide. The great majority of snakes are harmless, and usually only a few species in any region are venomous. If poisonous species can be positively distinguished from harmless varieties, then the safest approach is to assume that all snakes are venomous. In other words, leave them alone and unmolested.

About 2,400 species of snakes exist in the world, of which approximately 800 are venomous to some degree. Around the world, an estimated 1,700,000 people are bitten by venomous snakes each year, and 40,000 - 50,000 (0.3%) of these bite victims die. In less-developed countries, bites and deaths are often under-reported, so risk estimates are likely lower than actual risks. Snakes can be classified in several families, but only three are of importance for our purposes:

Viperidae -- All vipers are venomous. This family includes the true vipers and the pit vipers (pit vipers are sometimes placed in a separate family, Crotalidae, by taxonomists). Their venom is primarily hemotoxic although some species have a neurotoxic component to their venom. Envenomization can cause pain, blistering, hemorrhaging, and digestion of tissue around the bite wound. The venom is transmitted through hollow, erectable fangs on the upper front of the mouth. The best-known members of this family are the rattlesnakes and moccasins (cottonmouths and copperheads). Vipers are distributed throughout the world in temperate, subtropical, and tropical climates.

Elapidae --All elapids are venomous. This family contains both land-dwelling and aquatic species. Elapids are distributed throughout the world in subtropical and tropical climates. Their venoms are primarily neurotoxic causing paralysis of the nervous system leading to death by suffocation when the respiratory system becomes paralyzed, but some are cardiotoxic causing the heart to stop beating. Venom is transmitted through deeply grooved or hollow fangs that are fixed in an erect position at the front of the mouth. Among the most dangerous of the elapids are the coral snakes, cobras, kraits, mambas, and the sea snakes. Sea snakes are sometimes placed in a separate family, the Hydrophidae; some are pelagic, forming rafts of snakes extending for miles in the open sea.

Colubridae --This family contains about 1,600 species, of which, only 400 are venomous to some extent. They are distributed throughout the world in temperate, sub-tropical, and tropical climates. Their venoms are hemotoxic and is transmitted through enlarged and grooved teeth at the rear of the mouth. For this reason, colubrids are known as “rear-fanged” snakes. Among the most dangerous are the Boomslang and the Bird Snake of Africa, the Yamakagashi of the Orient, and the South American Hognose Snake.

## **Snakebite and Venoms**

All snakes will avoid contact with humans. Most incidents of snakebite, at least in more industrialized countries, occur when a snake is handled or attacked, with fewer incidents occurring from accidentally stepping on snakes or threatening them unintentionally. Most snake bites do not cause death in adults even if untreated. The death rate from untreated bites for most venomous snakes is 10-20%, although a few species have higher rates and many species have much lower rates. Most venomous snakes are simply not that venomous and the majority of bites are not 100% effective in delivering venom. This may be due to having partially empty glands or making poor strikes with only one fang partially entering the victim. The saliva in some nonvenomous snakes is suspected of having an almost equivalent effect of an actual venom on prey. Thus there are several reports of rather mild reactions in humans after the bites of ordinarily nonvenomous snakes such as water and hognose snakes, both of which lack grooved teeth and venom glands.

## **Snakebite Avoidance**

Prior to deployment, learn to recognize venomous species in the area of operations. Almost every country has at least one available book and usually several pamphlets on venomous local snakes. In most areas, recognition of at least the genera of poisonous species is not difficult. If you know which species are harmless and which are venomous, avoiding accidents with venomous species is easier.

In nonagricultural areas, the main causes of snakebite can be attributed to handling venomous snakes either in public displays or private collections and misguided attempts to kill or torment wild venomous snakes. With few exceptions, venomous snakes are not aggressive and will not strike unless they feel threatened. The cardinal rule of Public Health is: "If it's not your snake, don't touch it."

In areas where venomous snakes may occur, careful attention should be given to where hands and feet are placed. Unless you step directly on a snake or put your hand on one, the snake usually will retreat. When lifting objects, lift from behind, not from in front. Never poke your hand into a crevice or hollow log or under a ledge without first examining it carefully.

## **Surveillance, Prevention, and Control**

Surveillance: The first step in surveillance is to gather information about which snakes occur in the area of interest. This will enable you to brief your people about the threat, to prepare necessary prevention and control measures, and to ensure medics are prepared to treat any bites (procure antivenin if available or identify local sources). The next step is direct observation once you are onsite. Using caution, look for snakes in places humans will be, then work your way out from human habitation into surrounding areas from which snakes might invade. If snakes are found, appropriate steps should be taken to brief the risk, place the areas off-limits, remove the snakes if necessary, or ensure necessary control methods are implemented.

Prevention: Avoiding snake habitat, making snake-infested areas off-limits, and reducing snake harborage are the best means of preventing encounters from snakes. Reducing harborage should



include cutting grass and removing woodpiles, rock piles, construction debris, dumps, dense undergrowth, and similar shelters. If such material is to be used, it should be elevated a few inches off the ground. Rodent control also will reduce snake populations, because rodents are commonly a large part of many species diets. Block holes in foundations, crawl spaces, foundations, ceilings, and roofs with copper wool, mortar, caulk, etc. Keep doors, windows, and vents closed when not in use. Repellents have not been shown to be very effective, however, in closed containers where people will not be exposed, paradichlorobenzene (“moth balls” or “moth flakes”) reputedly will discourage snake infestation.

Control: Snakes can be captured or live trapped and relocated away from operating areas. Capturing with a “catch pole” is safe if done properly. A damp cloth or burlap laid on the floor or ground may offer snakes favorable harborage, where they can be captured and removed. Ensure that everybody in the area knows the purpose of the trapping material so that they will not disturb it, and check the trap frequently to remove any snakes. Cage traps (“Havahart<sup>R</sup>” type) may be effective if the mesh is fine and strong enough to retain the snake, however they should be baited with live bait (mice, rabbits, birds, etc.).

Glue traps are effective and preferable to snap traps if protected or endangered snakes are likely to be caught. Since glue traps do not kill, but aggravate the snake and make it more aggressive, these traps must be used judiciously and never in close quarters with people. Use a large glue surface, and the board must be anchored to the floor to prevent the snake from carrying it off. Place the glue trap away from poles, ropes, pipes, trees, shrubs, or other objects that might provide leverage for the snake to pull itself off the glue. To remove a snake from the glue, pour cooking oil over it to break down the glue, and help the snake remove itself with a stick or pole.

Expanded-trigger rat traps can be used to kill snakes in certain situations where there is no other choice. The traps should be placed in pairs next to walls where snakes might traverse -- no bait is necessary -- and wired to a stake or pole. Simple clubbing works well, but drowning or shooting are also effective -- be aware of possible conflicts with host nation laws. Shooting snakes is only rarely appropriate, due to the hazards of discharging firearms. There are no poisons or chemicals registered to repel or kill snakes.

### **Section 13. Sources of Assistance for Vector/Pest Identification and Information**

Air Force Institute for Environmental Safety and Occupational Health Risk Analysis (AFIERA)-- Primary USAF pest management consultant.

USAF School of Aerospace Medicine Department of Public Health (USAFSAM/AE)— Medical consultants, lots of experience in many areas.

USAFE Command Entomologist -- Civil Engineering and medical entomology responsibilities.

Medical Entomology in the Pacific, Det. 3 AFIERA, Operating Location at Kadena AB, Okinawa -- medical entomology pest management consulting and other responsibilities.

U. S. Army Preventive Medicine Detachments—Entomologists are present at most Preventive

Medicine Detachments.

U. S. Navy-- Disease Vector Ecology and Control Centers (DVECCs), Navy Medical Research Units (NAMRUs), Navy Environmental Preventive Medicine Units (NEPMUs), Navy Medical Research Institute of Infectious Diseases (NAMRIID), including overseas locations can be tapped for expertise and supplies.

Armed Forces Pest Management Board (AFPMB) – Information, coordination – Contingency Liaison Office answers inquires, assists in solving problems, coordinates support.

Defense Pest Management Information Analysis Center (DPMIAC) – Information, primarily, but will refer issues to appropriate authority for support.

Local Entomologists and Public Health Support -- Most countries have public health personnel (usually government officials) and many have medical/veterinary entomologists (more often at universities and institutes).

## **Section 14. Personal Protection From Arthropods**

Arthropods can affect us in many ways, including directly -- bites, stings, allergic reactions, morale degradation -- and indirectly -- transmission of diseases. Arthropod-borne diseases have always been important factors in military operations.

Personnel must be made aware of the hazards they may face on a deployment and how to protect themselves. This includes using only approved food and water sources, not swimming in contaminated water, reporting animal bites, practicing good personal hygiene, avoiding contact with all animals (wild, domestic, or stray), and using proper personal protective methods and equipment (PPE).

There are six methods of personal protection from arthropods: chemoprophylaxis, vaccination (immunization), avoidance, barriers, repellents, and personal use pesticides.

### **Chemoprophylaxis**

Chemical (medication) that is ingested before exposure to a disease, and then circulates in the body and kills the pathogen. Some pathogens are resistant to many chemoprophylactic compounds, and there is not a chemoprophylactic for every disease. Chemoprophylaxis does not change the immune system, thus requiring continuous use before, during, and after the deployment.

Examples: antimalarials such as mefloquine, chloroquine, doxycycline.

### **Vaccination (Immunization)**

Vaccination is prevention of a disease by the introduction of very small doses of live or killed disease organisms before exposure to the disease. Vaccination changes the immune system,

allowing the body's natural defenses to resist the disease. However, vaccination does not provide immediate protection because a period of time is required for the immune system to establish protection, and some vaccines require periodic boosters to remain effective. For example vaccines for yellow fever, plague, and Japanese B encephalitis. The yellow fever vaccine takes 10-11 days following the injection to provide 100% protection for 18 years (a booster is given every 10 years for assurance). No vaccine is 100% effective so individuals must take personal responsibility for protecting themselves by avoidance and appropriately using insect repellents.

### **Avoidance**

Avoid dwelling places of vector and pests. Do not utilize areas where the vector lives. Example: Thatch huts in South America serve as a home for kissing bugs, the vector of Chagas' disease.

Avoid vector and pest breeding places. Unless absolutely necessary, do not put the base camp next to a swamp that produces swarms of mosquitoes.

Avoid terrain features that attract or harbor pests and vectors. Some areas are particularly attractive to certain vectors. For example, ticks are "edge dwellers" -- they are more abundant in transitional vegetation along trails and between woods and meadows.

Avoid times of peak abundance of pests and vectors. Some *Aedes* mosquito species primarily bite during daylight hours. Other mosquitoes feed primarily at dusk and dawn. Stay inside or use protective methods during these times to limit potential for harm.

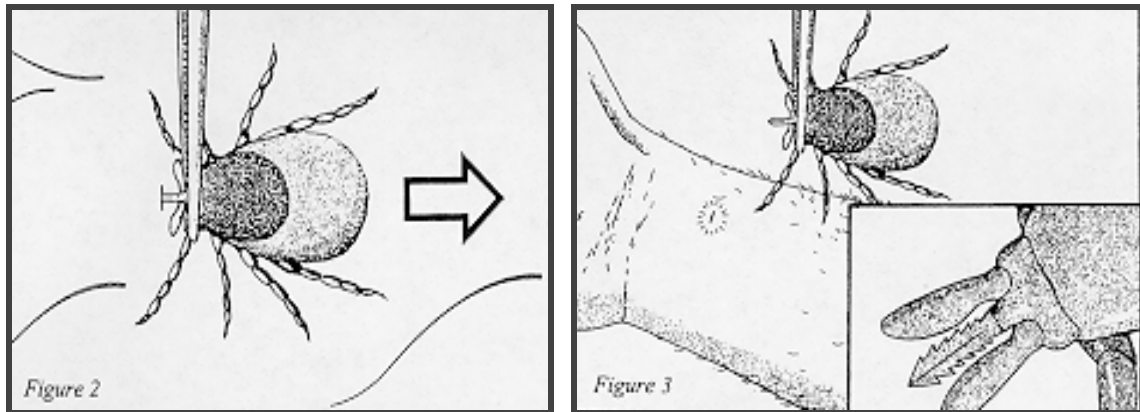
### **Tick Removal**

Search for and remove ticks from the body as soon as possible. The longer the tick remains attached, the more engorged and difficult it becomes to remove. Also, the longer a tick remains attached, the more likely the chance of disease transmission. Ticks may shed pathogens in their feces, and may contaminate cuts or abrasions if handled with bare fingers, and pathogens also can be introduced through the mucus membranes of the nose or eyes. There are several inappropriate ways of removing attached ticks including covering them with vaseline, applying fingernail polish or similar chemicals, burning them off with fire or matches, and detaching them with various commercial "gadgets." However, such methods may actually do more harm than good, generally do not work as intended, and should not be used. The most appropriate method for removing an attached tick is to:

- Place the tips of medium-tipped forceps around the area where the mouthparts enter the skin.
- With steady slow motion, pull the tick away from the skin or slide the removal device along the skin (read the directions for each commercial tool). Do not jerk, crush, squeeze or puncture the tick.
- After removal, place the tick directly into a sealable container. Disinfect the area around the bite site using standard procedures.

- If possible, keep the tick alive for testing for tick-borne pathogens. Place it in a labeled (date, patient), sealed bag or vial with a lightly moistened paper towel then store at refrigerator temperature.

- If forceps are unavailable and index finger and thumb must be used, protect them with rubber gloves, plastic or even a paper towel.



**Figure 79B. Proper method for removing ticks**

### **Barriers**

Oils (e.g., baby oil, Avon Skin-So-Soft<sup>R</sup> skin softener) -- Present a physical barrier to some arthropods but do not repel or kill effectively. These last only a short while, so will require frequent reapplication.

Screens -- Window screens, tent screens, etc., provide a physical barrier to keep pests and vectors away. Use existing screens, have them made if not otherwise available. Improvise with bed nets to screen areas. Some vectors such as sand flies are small enough to go through normal-sized screen so such screens should be treated with residual pesticides such as permethrin when possible.

Bed net -- Excellent barrier that is very effective at preventing disease transmission. Bed nets should be treated with permethrin to maximize their effectiveness. Arthropods such as sand flies are small enough to pass through bed net mesh and mosquitoes can bite through the mesh where it is touched by bare skin. Treating a bed net with permethrin will prevent such attacks.

- Suspend from poles with ties and check for holes. DO NOT suspend net over poles.
- Tuck edges under mattress or sleeping bag to seal it so it does not fall out and permit vectors access to the sleeping area.
- Check for insects under the net and remove or kill them with a personal use pesticide.
- Keep the body from contacting the net while sleeping to prevent vectors from feeding through the mesh.



**Figure 80. Insert tapered end of support post into corner hole**



**Figure 81. Tie corners of bed net to support post—do not drape net over the posts**



**Figure 82. Tuck edges of bed net under sleeping bag and between poles**

Tropical parka -- treated with DEET or permethrin is an effective tool to prevent vectors from landing .



**Figure 83. The tropical parka**

Head net -- Works well in protecting the head and face, but may not be well accepted by troops in the field.

The uniform -- Provides an excellent barrier when worn properly -- loose fit, pants tucked into boots, sleeves pulled down, collar buttoned up if necessary, etc. Uniforms should be treated with permethrin which acts as a repellent and residual insecticide.

## Repellents

Repellents are chemicals that repel attacking insects and other arthropods when applied to skin, clothing, or other surfaces.

DEET -- for exposed skin and/or clothing (tropical parka primarily) application.

- DEET cream formulation-- 33.3% extended duration DEET lotion.
- DEET and sun screen combination -- 19% DEET lotion, SPF 15, "Sunsect."

Permethrin -- for fabric application only -- the uniform, tropical parka, bed net, and tent primarily. Do not use permethrin on Nomex® or Gortex® fabric items (flight suit, aircrew BDUs, CVC) because it will not bind to them and is easily washed off. There are three general methods of application:

- Aerosol -- 0.5%, 6 oz. can. Effective for up to six hot washings with detergent following application
- Individual Dynamic Absorption (IDA) Kit -- concentrate, plastic bag kit. Effective for up to 50 hot washings with detergent or the life of the uniform under field conditions. This is the most efficient and effective means of treating a uniform.
- Pesticide applicator application of 40% permethrin concentrate -- requires pesticide applicator certification, 2-gallon sprayer, and respirator mask.



**Figure 84. DoD repellents (Permethrin aerosol, DEET, IDA kit)**

## Personal Use Pesticides

Pyrethroid aerosol space sprays can be used to control insects that invade the bed net or personal quarters, including contract quarters such as hotel rooms. Personal use pesticides should be taken on deployed rather than purchased locally upon arrival at the deployed location. Foreign pesticides may be of unknown formulation or purity, and the label may not be in English. Examples of personal use pesticides include d-phenothrin, resmethrin, and pyrethrum. Permethrin, in addition to being a repellent, is also a personal use pesticide -- it not only repels, but it also kills arthropods.



**Figure 85. d-Phenothrin personal use pesticide**

## Education

Education is very important to personal protection -- so that one knowing how to protect oneself is an important part of “Integrated Disease Management”. Integrated Disease Management is the combination of personal protection methods to further protect oneself from arthropods and arthropod-borne disease. Medical personnel should be the most knowledgeable individuals on any deployment on Integrated Disease Management issues to protect themselves. Commanders have to be educated about the safety, use, and importance of personal protection, as do those who use it -- the troops. They have to believe in it or it won't be used, and they also have to have their own supply on deployments.

Avoid use of unsafe, scientifically unproved personal protection methods. For example:

- Do not use flea collars -- they are not designed for use on human skin and are toxic.



- Do not eat match heads -- can cause severe poisoning.
- Do not bet your health or your life on “folk remedies” or baby oil or Avon Skin-So-Soft<sup>R</sup> when much more effective repellents are available.

### **Repellent Safety**

DEET Safety -- DEET has compiled an excellent safety record over 40 years of use and is used as insect repellent by 50-100 million people around the world each year. The polymer base in the 33% extended duration cream formulation slows absorption and evaporation, so less is absorbed into the skin and the repellency lasts longer. Most problems seen with DEET are associated with improper use -- ingesting it, spraying it into the eyes, applying it to irritated skin, over-applying, etc.

Precautions for the use of DEET – This repellent should be used strictly according to the label and not applied excessively – Do not use DEET or another repellent or pesticide unless there is a reason. Limit exposure of pregnant troops, but weigh use against the realistic threat of contracting a disease. If DEET must be used, a concentration of 15% or less is recommended. Application to children, such as in humanitarian operations (or at home) should also be judicious. The American Academy of Pediatrics and the U.S. Centers for Disease Control recommend 10% or less concentration, used sparingly, and avoiding application to the child’s hands. Use baby or mineral oil as a barrier on infants and small children.

Permethrin Safety -- Permethrin has been used by millions of individuals among the general public for over 20 years and has an excellent safety record. The National Academy of Sciences Committee on Toxicology determined that permethrin is unlikely to cause adverse health effects for people exposed to a treated uniform for up to 18 hours a day, 7 days a week, over a period of 10 years during a 75 year lifetime. Permethrin is currently used by millions of people around the world every year, with no unusual negative results (fewer than those experienced with some other commonly used “over the counter” items). The safety of permethrin is due to its very low mammalian toxicity, which results from its low absorption and quick and efficient detoxification by the human body.

Precautions for use of Permethrin – Permethrin should be used strictly according to the label and all safety information observed. Never apply permethrin to the skin, and do not use it unnecessarily. Wear of permethrin-treated clothing by pregnant women should be judicious; the IDA kit, factory treatment, and liquid spray should not be used. The 0.5% aerosol permethrin applied to external surfaces of the uniform would present the least exposure. Treated clothing presents little risk to children but should be avoided with infants. Wear should be judicious -- weigh disease threat vs. relative risk of chemical exposure.

### **Wear of Treated Uniforms**

You may choose to keep separate treated uniforms ready for field or deployment use, and wear untreated uniforms in office environments. You may choose to dry clean treated items to remove pesticide when no longer needed, and re-treat before you go back into an environment where

arthropod protection would be needed. Chlorofluorocarbon-based solvents remove 100% of the permethrin; perchloroethylene solvent removes approximately 85% of the permethrin.

### DoD Repellent System

The DoD Repellent System includes treatment of the uniform with permethrin, use of DEET on exposed skin, and proper wear of the uniform to achieve maximum protection.

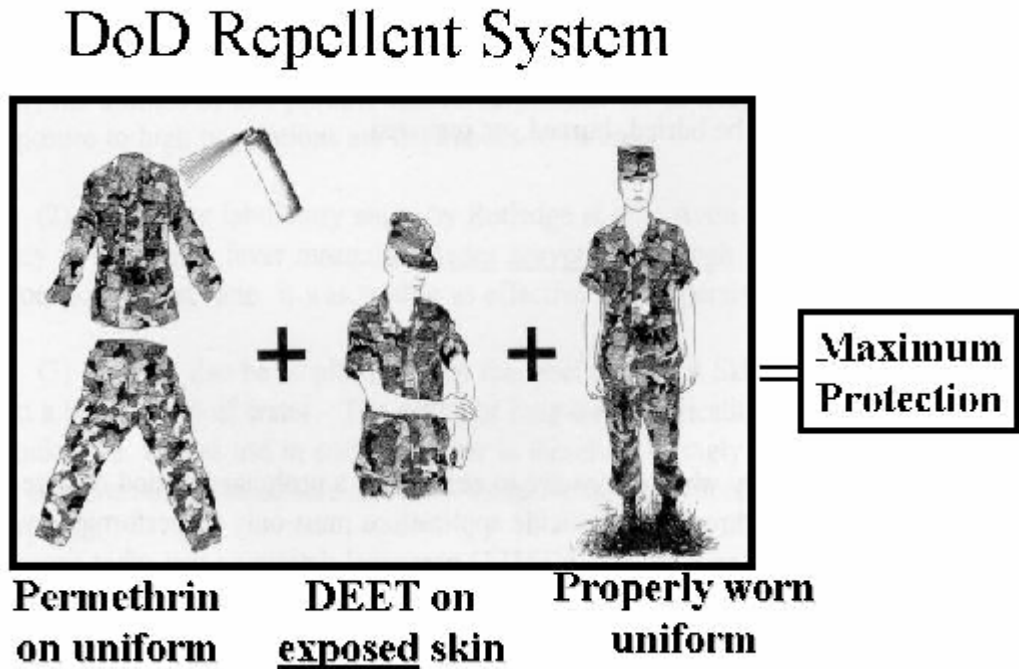


Figure 86. Illustration of the DoD repellent system

Up to a 99.94% reduction in mosquito biting rates can be achieved with this system.

Table 5. Effect of DEET Use and Permethrin Treatment of the Uniform on Mosquito Biting

	No. of Bites per 8-9 Hr Day	% Reduction	% of Bites on Exposed Skin	% of Bites through Uniform
Untreated Uniform no DEET on Skin	2,287	n/a	83	17
Untreated Uniform DEET on Skin	99	96	12	88
Treated Uniform No DEET on Skin	54	98	99.99	0.01
<b>Treated Uniform DEET on Skin</b>	<b>2</b>	<b><u>99.94</u></b>	<b>100</b>	<b>0</b>

**Source:** C. Schreck et al.: “The effectiveness of permethrin and DEET, alone or in combination, for protection against *Aedes taeniorhynchus*,” Am. J. Trop. Med. Hyg. 33(4), pp. 725-730.

### **Supply Information**

Coordinate with medical and base supply in advance -- talk to medical, base, wing commanders and show the line how they benefit. Have what you need ready to go for when you need it. If you find yourself deploying to a vector-borne disease hot spot and need your repellents “a week ago Thursday,” call the **Emergency Supply Operations Center -- DSN 695-4865, Commercial (804) 279-4865**, and tell them what you want, how much you need, and where you want it. If you have problems with the ESOC, call the **Chief, ESOC, at DSN 695-5460**. The ESOC should only be utilized for genuine emergencies, not routine supply orders or failure to prepare in advance when time was available.

### **Repellent Information Contacts**

Defense Supply Center Richmond  
DSCR-JDTB  
8000 Jefferson Davis Highway  
Richmond, VA 23297-5810  
DSN 695-3995, Commercial (804) 279-3995  
<http://www.dscr.dla.mil>

Contingency Liaison Officer  
Armed Forces Pest Management Board  
Forest Glen Section, WRAMC  
Washington, DC 20307-5001  
DSN 295-7476, Commercial (301) 295-7476  
<http://www.afpmb.org>

Defense Pest Management Information Analysis Center / AFPMB  
Forest Glen Section, Walter Reed Army Medical Center  
Washington, DC 20307-5001  
DSN 295-7479, Commercial (301) 295-7479  
<http://www.afpmb.org>

USAFSAM Medical Entomologists  
USAFSAM/ATR  
2602 West Gate Road  
Brooks AFB, TX 78235-5252  
DSN 240-1956, Commercial (210) 536-1956  
<http://wwwsam.brooks.af.mil/web/eh/entomology/usafento.htm>

**Emergency Supply Operations Center**  
DSN 695-4865, Commercial (804) 279-4865

Table 6. Recommended “Most Needed” Items for DoD Deployment

National Stock Number	Item
6840-01-284-3982	33% DEET lotion (Insect Repellent, Personal Application)
6840-01-288-2188	19% DEET/SPF-15 sunscreen combination (Sunsect)
6840-01-278-1336	0.5% Permethrin aerosol (Insect Repellent, Clothing Application)
6840-01-345-0237	IDA Kits (permethrin uniform treatment)
6840-01-067-2137	Personal Use Pesticide (D-trans Allethrin and Resmethrin, 0.15% and 0.2% minimum, respectively)
6840-01-067-6674	Personal Use Pesticide (2% d-phenothrin)
8415-01-035-0846	Parka, Fabric Mesh, Insect Repellent (small)
8415-01-035-0847	Parka, Fabric Mesh, Insect Repellent (medium)
8415-01-035-0848	Parka, Fabric Mesh, Insect Repellent (large)
8415-00-935-3130	Head Net, Insect
7210-00-266-9736	Bed net (Insect Bar, Cot Type)
7210-00-267-5641	Bed net poles (Poles, Insect Bar)

## **Guidance for Applying Insect/Arthropod Repellent Lotion (NSN 6840-01-284-3982)**

Thoroughly read and understand the product label before using --you must comply with the label instructions; this guidance is provided to aid in understanding and following the label instructions.

### Precautions

- Apply only to exposed skin -- do not apply the lotion to skin that is not exposed.
- Do not allow the lotion to get into the eyes.
- Do not apply to the lips.
- Do not apply to sensitive skin, including genitals, skin that is excessively sunburned, poison ivy-irritated, cut, abraded, or blistered, etc.
- Keep out of the reach of children.
- May be applied to fabrics, but may damage certain synthetics, plastics, and surface finishes -- avoid contact with plastic eyeglass lenses and frames, watch crystals, calculators, and similar items.
- Will not damage nylon, cotton, or wool fabrics, the M17 individual protective mask, does not affect the infrared signature, and can be used with sunscreen and camouflage face paint.

### Application

- Dispense a small amount of the product into the hand -- to cover an area the size of the forearms, 2.5 milliliters (a strip about 2 and 1/2 inches long and 1/4 inch wide [see diagram on side of tube]) is appropriate -- use less if less area is to be treated.
- Rub hands together and apply the lotion in a thin coat, evenly and thoroughly to both forearms.
- Repeat for other exposed areas.
- To apply to the head, apply a small amount to the face, ears and neck, avoiding contact with eyes and lips.
- Wipe excess lotion from hands after application to avoid transferring to eyes, mouth, and plastic items.
- Repeat as necessary -- Do not reapply if not receiving bites or arthropods are not interfering with effectiveness.
- Provides 6 hours of at least 95% protection against a variety of mosquitoes in a tropical environment, 10 hours in a hot, dry environment, and 12 hours in a forested, wet environment.

- Although the 33% DEET lotion polymer resists removal by water, extended soaking in water, friction with vegetation, soil, or equipment, wiping, etc., will remove the lotion and necessitate reapplication.
- When the tube is empty, wrap it in a piece of paper or something similar and dispose of it in the trash.

If used in conjunction with sunscreen or camouflage paint, apply these first, then the lotion. If the lotion gets in the eyes, flush with lots of water -- if irritation persists, get medical attention. Once you return from the area where the repellent was needed, you may choose to wash it off.

The extended duration formulation slows evaporation of the DEET at a concentration sufficient to repel arthropods longer -- Higher concentrations of DEET do not provide longer or better repellency than this formulation.

### **Guidance for Treating BDUs with the IDA Kit (NSN 6840-01-345-0237)**

Thoroughly read and understand the product label before performing applications -- you must comply with the label instructions -- this guidance is provided to aid in understanding and following the label instructions.

- Do not apply to underwear or other undergarments, hat, or Nomex<sup>R</sup> fabric items.
- Use in a well-ventilated area, and allow uniform to dry in a well-ventilated area.
- Wear the gloves provided with the kit during the treatment.
- Fold up the BDU shirt and pants separately, roll them up separately, and tie each up with the string provided in the kit.
- Place 3/4 of a canteen cup (~1 quart) of clear water into each bag -- do not use more than 3/4 of a canteen cup or there will be solution left over that requires special disposal.
- Wearing the protective gloves provided, pour the contents of the small bottle of permethrin into each bag, drop the bottle and cap in, ziplock securely closed, and shake two times to mix.
- Unzip the bag and place the BDU shirt in one and the pants in the other, then ziplock them securely.
- Let stand 3 hours or more (overnight is OK) to absorb all the liquid.
- Again wearing the protective gloves provided, untie the shirt and pants, shake them out, and hang them to dry for 3-4 hours or until completely dry.
- Mark the date treated in the shirt collar and pants waistband.

- Do not re-treat the uniform unless told to do so by medical authorities -- one treatment is good for the operational life of the uniform under most conditions.
- Do not re-use the bags or other kit materials -- zip closed and dispose of them in a trash can.
- Do not wear the uniform until it is thoroughly dry -- contact with wet treatment may irritate skin.
- If there is liquid solution left over from the treatment, use it to treat another outer clothing item.
- Once you return from the area where the repellent was needed, you may choose to have the uniform dry cleaned to remove remaining permethrin for daily wear where vectors and vector-borne diseases are not a threat. Dry cleaning with chlorofluorocarbon solvent will remove all the permethrin from the BDUs; perchloroethane solvent will remove 85% of the permethrin.
- Be sensible about where you treat your uniform -- don't treat it inside a billeting room, by the swimming pool, etc., and don't leave a lot of kit materials in one person's room or in the lobby; lodging personnel may not be as well informed as you are, and may object to pesticide odors or containers they perceive as hazardous waste.

## **Guidance For Applying Permethrin Aerosol (NSN 6840-01-278-1336) To BDUs**

Thoroughly read and understand the product label before performing applications -- you must comply with the label instructions -- this guidance is provided to aid in understanding and following the label instructions.

- Do not apply onto your or anyone else's skin.
- Do not apply to the uniform while it is being worn.
- Do not apply to underwear or other undergarments, or hat.
- Keep out of the reach of children.

Permethrin is a very safe product, but always follow all safety procedures to minimize unnecessary contact with the product, and adhere strictly to the label instructions.

- Use in a well-ventilated area, preferably with no breeze -- If a slight breeze is unavoidable, stand upwind of the spray, for stronger breezes, stop spraying until the wind calms down.
- Wear rubber gloves (such as dishwashing gloves) when applying the chemical and when handling treated clothing while the treatment is still wet.
- Spread clothing out onto the ground, on grass if possible.
- Hold the can 6-8 inches away from the clothing while spraying -- spray only the outside surfaces.
- Apply the spray until you see the color of the clothing darken as it gets wet -- continue spraying the rest of the BDUs on the outside for the same color change effect.
- Turn the uniform over and treat the other side.
- Use 3/4ths to 4/5ths of the can to treat the BDU set, and the remainder to treat your mosquito netting, tropical parka, tent fly, window screens, boot eyelets, etc.
- When the can is empty, wrap it in newspaper or something similar, and dispose of it in a trash can.
- Allow the uniform to thoroughly air dry (2-4 hours) before wearing -- do not dry it in a laundry dryer.
- Do not wear the uniform until it is thoroughly dry -- contact with wet treatment may irritate skin.



Once dry, the treatment is good for 6 hot washes with detergent or 6 weeks, after which it must be re-treated.

Once you return from where the repellent was needed, you may choose to have the uniform dry cleaned to remove the permethrin for wear where vectors and vector-borne diseases are not a threat. Dry cleaning with chlorofluorocarbon solvent will remove all the permethrin; perchloroethane solvent will remove 85% of the permethrin. .

Be sensible about where you treat your uniform – do not treat it in a billeting room, by the swimming pool, etc., and don't leave a bunch of containers in one person's room or in the lobby -- lodging personnel may not be as well informed as you are and they may object to pesticide odors or containers.

## **Section 15. Prevention, Treatment, and Control of Schistosomiasis**

Schistosomiasis is second only to malaria in terms of its socioeconomic impact and the toll it takes on human health. The cycle of transmission can be interrupted through avoidance, sanitation, management of snail hosts, and treatment of infected persons. In tropical and subtropical regions, assume that all water is infested with schistosomes until shown otherwise. The best method of preventing the disease is to avoid contact with infested water. In countries where the disease is endemic, contact with fresh water should be avoided (no risk for sea water). Only purified drinking and bathing water (boiled at least 10 minutes or chlorinated) should be used. Fresh vegetables should be well-cooked and salads should be avoided because the vegetables may have been washed with infected water, allowing the cercariae to attach themselves to the leaves. If you must pass through streams or swamps, wear high waterproof boots or hip-waders --snails abound in shallow, slow-flowing water where they feed on organic waste and aquatic vegetation. Contact with fresh water should especially be avoided during the hours of bright daylight when the cercariae emerge from the snails and are most active. If you accidentally come into contact with fresh water, rub your skin immediately with rubbing alcohol and a dry towel to reduce the possibility of infection.

Repellents do not prevent penetration of the skin, and there is no vaccine or medication available to prevent the establishment of the infection. Although progress has been made in the development of a vaccine for the schistosomes that affect domestic animals, attempts to develop a similar vaccine for human schistosomes are not yet promising.

The tropical weight and temperate weight battle dress uniforms provide substantial, though not complete, protection from penetration by infective forms if there are no rips, tears, or holes in them and the pants are tucked into the boots and exposed skin does not contact infested water. When contact with water is unavoidable, the most practical method of breaking the chain of infection is to control the intermediate host snails of the parasite. The goal of chemical control is to reduce host snail populations to levels at which transmission ceases or is substantially reduced. Eradication of the snails is the only assurance of non-transmission, but may not be possible or practical. In contingency situations, expedient control can be achieved by application of chemical molluscicides. Bayluscide is toxic to snails and their eggs but not toxic to man or overly biocidal. It is available as a wettable powder or emulsifiable concentrate. However, Bayluscide is not EPA-registered since it has no uses in the US. Bayluscide can be ordered by normal requisition processes (NSN 6840-12-

308-4377, 25% emulsifiable concentrate, 110 lb. drums), but only for delivery outside the US, and delivery may take up to 3 months. Local officials at the deployed site may have information on emergency suppliers. Molluscicides may be applied area-wide or focally, appropriate to the ecology of the host species.

## **Section 16. Integrated Pest Management**

To understand the principles of integrated pest management an understanding of certain common terms is required.

Integrated Pest Management (IPM): A comprehensive approach to pest control or prevention that considers various chemical, physical, and biological suppression techniques, the pest's habitat, and the interrelationship between pest populations and the ecosystem. IPM uses all appropriate technology and management to bring about pest prevention and suppression in a cost-effective, environmentally sound manner. This means neither the elimination of pesticides nor an emphasis on these chemicals. Pesticides must be used with discrimination, rather than as the item of choice. Although pesticides are purposely put into our environment when required, their toxicity requires a special responsibility of the user to be fully knowledgeable of their potential negative impacts and to use preventive, non-toxic or least toxic alternatives on a priority basis. IPM considers the pest's impact on people and the environment and then integrates only the appropriate cultural, mechanical, physiological, biological, chemical and regulatory measures needed to attain adequate pest management. Routine surveillance of pests is an essential part of any pest management program or effort. Without surveys, true integrated pest management is not possible.

Pest Prevention: The application of pest management measures in advance of large pest populations. Prevention aims to keep the pest population sufficiently low, so as not to adversely impact people or the environment.

Pest Control: A term describing pest management techniques used during most of the 20th century, which generally resulted only in a lower pest population and never really achieved control. This approach relied almost exclusively on chemical controls.

Pest Eradication: A formal approach normally used to eliminate a species of great medical or economic importance from a specific geographic area. With international trade and travel, such efforts are very difficult and expensive to maintain. The military doesn't normally use this approach in its own operations except in the context of fumigation, but military units are often involved in larger, government-wide programs and in the required quarantine follow-up actions aimed at achieving or maintaining pest eradication.

### **Contingency Considerations**

In most contingency operations, pest management personnel should conduct control procedures just as in a normal installation setting. However, major differences will occur because forces will be operating in a contingency or combat environment, where unit positions are constantly changing. Also, there will generally be limited pest management resources, and operating conditions will be more primitive, often with much more demanding time constraints. Because of these differences,

techniques such as pest exclusion should be applied on a very limited basis. Focus most pest management efforts on faster acting methods, like chemical pesticides. But never let these conditions be an excuse not to implement all available non-chemical procedures (for example, bednetting, screening) before using chemical methods. When contingency operations occur, supporting engineering services, including pest management, are provided by activation of Prime BEEF (Base Engineer Emergency Force) and RED HORSE (Rapid Engineer Deployable, Heavy Operational Repair Squadron, Engineer) teams. During contingency operations, medical personnel continue to perform a surveillance role and the engineering element a management role. Since Air Force units normally operate from established bases, unit support from the preventive medicine or pest management engineering units is received directly. Unit field sanitation teams give this support before deployment, using 2-gallon pesticide sprayers and selected premixed pesticides, such as those normally included in self-help programs on fixed installations. Pest management support beyond this level is given by preventive medicine or engineering units.

### **Components of Pest Management**

If pest management is to be an integrated approach, it is necessary to have a general knowledge of the components of any pest management effort.

Technical Information. The most important, but often overlooked, element of any pest management effort is ensuring that knowledge exists at all levels of the program. This is especially true today because the use of pesticides is one of very few times when we deliberately place a toxic agent into the environment with the purpose of killing a living organism. No agency can afford to have uneducated or misinformed people responsible for distributing such toxicants. This is why the DOD places such a strong emphasis on educating and training not only pest managers, but all people involved in control programs from the pest management professional to a person involved in a self-help program in military quarters.

Human Safety. Human safety is the most important concern in any pest management effort. The most common hazard occurs when workers apply pest management chemicals.

Environmental Concern. Second only to human health in importance are the environmental concerns that must be addressed before pest management procedures begin. Over a number of years, indiscriminate use of pest management chemicals has caused many adverse conditions people are now just beginning to understand. DOD is involved in a major effort to reverse these conditions. DoD has become a program leader among the nation's many government agencies in establishing strong environmental protection programs. Two of its major elements include maintaining safe storage facilities and properly disposing of pesticide wastes.

### **Pest Management Actions**

Pest Exclusion. Most established installation pest management effort involves pests of offices, facilities and quarters. In these areas, cost-effective pest management is often achieved during the design and construction phase by "building in" pest exclusion or "building out" the pests. New buildings should never be constructed until a qualified pest management professional or consultant reviews the plans to determine if building design will enhance or deter pest management efforts,

particularly in highly sensitive areas such as kitchens, food storage areas, laboratories, health care facilities, etc. One of the best ways to keep pest populations low is to install easily cleaned equipment. Another key to long-term management is to use materials that help keep pests like rodents, birds and termites from gaining entrance into a building. If preplanning isn't possible, modifications may be needed if pest barriers are lacking. These modifications are almost always more expensive, don't blend into the overall architectural design, and may disrupt normal operations in the structure.

Inspection. Inspection is an important and often overlooked element of any successful pest management effort. Inspections may be formal or informal and should include pre- and post-treatment surveys. Periodically inspect every aspect of the program to determine if the techniques used are effective and achieve desired results. If chemicals are used, make sure pest management actions do not compromise human safety and environmental concerns. Use inspections to identify and help correct potential problems, as well as educate and evaluate worker performance.

### **Non-Chemical Measures.**

Cultural Measures. These measures include techniques such as sanitation, vegetation management and water management. Sanitation is probably the single most important pest management technique available. Commanders at all levels generally recognize the need for good sanitation and strictly enforce the high level of general sanitation required by DOD and service policies, directives and regulations around kitchens, and health care facilities. However, many people do not often recognize that a lack of sanitation, even in the less obvious situations, may negatively impact pest management efforts. Building occupants and workers need to recognize these conditions for the potential problem they present and correct them as one of the first steps in achieving good management. If the pest managers cannot achieve this type of cooperation, especially in food processing and handling facilities or medical facilities, they should respond by reporting it through channels to the proper command authority. However, do not allow poor sanitation to become a crutch or excuse for not carrying out other pest management measures. Instead, be willing to explore and apply alternative corrective control methods. In addition to sanitation, two other common cultural techniques used are water management and vegetation management. Water management is essential to control water-breeding pests such as mosquitoes or aquatic weeds. Techniques include ditching, draining, filling areas of standing water, periodically flooding slow moving streams or rivers, and adjusting water levels in ponds and lakes. Vegetation management may include plant or tree selection (to prevent species attractive to problem pests), mowing, weed control and brush removal.

Biological Controls. Biological controls are those that involve the regulation of pest organisms using their natural enemies. When these actions occur in nature with no human assistance, it's called natural control. With insects, there is a growing number of parasites, pathogens, and predators available to control a given pest population. While many biological control techniques are not a total answer, and may be of limited success alone, they are good methods for use in a true pest management effort. They have improved in recent years so they are easily used. They are also environmentally safe because the control organisms are very "species-specific." This means they attack only the organism requiring control without causing damage to desirable animals or vegetation. Examples of biological controls include the use of predatory fish and insects, parasites, fungi, bacteria, nematodes, and sterile males of a pest species.

Mechanical/Physical Controls. These are direct or indirect nonchemical measures used to destroy pests outright or to make the environment unsuitable for their entry, dispersal, survival, or reproduction. In existing structures, these controls are mostly corrective in nature because pest managers often use equipment that makes a direct physical impact on the pest involved. Because of this equipment, and the time spent maintaining it, mechanical/physical controls are often more expensive than other categories of IPM. Examples include rat and mousetraps, sealing off cracks and crevices where cockroaches may harbor, removing and destroying wasp nests from building eaves, temperature manipulation to reduce an insect's ability to reproduce and survive, and controlling moisture under buildings to prevent the growth of wood-destroying fungi. In new construction, mechanical techniques are the best ways to exclude pests. Although they work best if done during initial construction, they are still a necessary element that should be accomplished even through structural additions or modifications. Although these methods may be more expensive initially, they are more economical over time. Also, these methods can reduce or eliminate hazards to people and the environment other methods may cause.

Chemical Measures. In the past, chemical pesticides have been the largest and most widely used pest management technique. But as previously indicated, to conduct a true pest management effort, a number of appropriate methods should be combined to achieve pest reduction with the least potential hazard to people and the environment. Pest managers can apply this "combined approach" idea to chemical control efforts. Chemical control often is thought of as using pesticides to kill pests, but there are also chemicals available, such as pheromones, which serve to trap insects, confuse them, or regulate their growth. Nevertheless, pest managers will regularly need to include pesticides in most comprehensive pest management efforts. Make sure to consider all other useful pest management techniques before deciding to use pesticides.

If a controlled pesticide is being used in IPM, DOD policy states that it must be applied by a trained pesticide applicator. Any pesticides classified as restricted-use or state-limited-use must be applied by a certified applicator. DOD certification costs are often offset by improved efficiency, reduced hazard risks and general program savings over time. Certification of all applicators lets the supervisor use individual operators for all types of pesticide applications in their areas of certification, thus increasing flexibility and efficiency.

### **Disinsection**

Using pesticides in aircraft is typically called "aircraft disinsection". Available nonchemical measures don't sufficiently prevent insects from entering aircraft, so it's mandatory to conduct some chemical pest management measures on aircraft moving from quarantined areas to other areas of the world. Foreign and domestic quarantine regulations may require disinsecting military aircraft with approved aerosol. Aircraft crews must know about these requirements and be trained to properly use approved aerosols before such missions. Although this treatment is usually sufficient for insects of medical importance, it isn't considered adequate for killing many agricultural pests. In such situations, it may be necessary to use residual sprays on aircraft to provide control over a longer term, up to 4 weeks. Contact appropriate Professional Pest Management Personnel for information about residual pesticides approved for aircraft disinsection and their use. Also give special attention to the airfield and airfield loading areas. In such situations, consider using attractant traps,

mechanical measures (for example, use of pavement or other types of hard stands), as well as space and residual insecticides to treat surrounding areas.

For flight safety reasons, using fumigants on aircraft is prohibited. So controlling rats, mice and snails on aircraft depends on surveillance, as well as trapping or hand removing pests found on cargo and loading areas. If fumigation is necessary, cargo must be off loaded (if necessary), fumigated and completely aerated consistent with label directions before it is loaded. If infested cargo entered the aircraft before it was fumigated, make sure to survey and treat the empty aircraft, if necessary.

In addition to pest management efforts that occur during normal aircraft operations, pest management on aircraft in contingency operations becomes even more critical. There is much less aircraft down-time and pest management personnel must avoid increasing down-time typically caused by quarantine operations. The key to successful pest management operations in these situations will depend on the ability to give quality service in minimum time.

Because military aircraft may visit multiple foreign airports during any operational period, all appropriate quarantine procedures must be followed. Basic regulations and detailed instructions concerning such procedures are published in Air Force Regulation 161-4, Army Regulation 40-12 and SECNAVINST 6210.2 Series, *Quarantine Regulation of the Armed Forces*.

### **Pest Management In Medical Treatment Facilities and Laboratories**

There are no pests that are unique to hospitals or labs, but there are unique situations in the hospital and laboratory environment that mandate extra care at all stages of the pest management program. This extra care includes close coordination between pest managers and the hospital or lab staff. Without this joint effort, the program will fail and adequate health care, research or testing will not be delivered to patients and other people.

Special hazards are presented by pests in medical treatment facilities. Ants, cockroaches, flies, crickets, spiders and rodents are the pests most often encountered in a Medical Treatment Facility (MTF). Other pests, such as mosquitoes and stored product insects, also may occur in the MTF and require proper management as well. While the presence of these pests in the home or workplace might be considered a nuisance, their occurrence in a hospital or clinic can create major problems for the staff and the health and safety of the patients using the facility.

#### **Non-chemical controls:**

Periodic inspections are especially important in the medical treatment facility (MTF). As with other programs, pest managers must make a thorough inspection before beginning any pest management effort. Include inside and outside areas in the survey to help locate all critical areas, such as shipping and receiving, trash collection areas, intensive care units, emergency rooms and kitchens. These areas all have either a high potential for pest development or present a situation where pesticide use is restricted. The knowledge gained about facility work flow and staff activities will help identify how pests are entering and moving through the facility. After the management program begins, it is equally important to determine its success on a regular basis. Take care to avoid disturbing patients or visitors. Check all sites that were treated and question staff members on the presence of pests in

their work areas. Use sticky traps to reinforce visual inspection. Survey records to show pest population trends and to monitor pesticide effectiveness should be maintained.

Unsatisfactory levels of sanitation should be coordinated with area supervisors to ensure that all problems within their control are corrected prior to treatment. Specific areas to consider for these inspections are detailed in Technical Information Manual (TIM) 20, Pest Management in Health Care Facilities.

Satisfactory pest management cannot be accomplished without the cooperation of the MTF staff who must be educated on the health threat caused by pests in their MTF. Inspection results and site infestation and sanitation ratings must be presented to key staff members, along with an explanation of what needs to be done to improve the situation. Physicians, nurses and administrators should be informed of all details of the plan in advance. These professionals need to know about the pesticides, methods of application and the work schedule before treatment starts so their approval is ensured and they are confident patient care will not be compromised during pest management activities.

### **Mechanical controls:**

The mechanical controls listed here are based on a policy of pest exclusion. If pests can be prevented from entering a MTF, the need to use pesticides will be considerably reduced.

- Caulk or seal all crevices around doors, windows and vents.
- Place tightly fitting screens on all windows that can be opened.
- Trim and clear vegetation from around buildings and outdoor equipment.
- Repair all water leaks.
- Use sticky cockroach traps as a surveillance tool.
- Check all exterior doors to ensure they fit tightly and have no holes.
- Inspect incoming supplies for pests.
- Keep outside water drains clean of debris.

### **Chemical controls:**

Many pesticides are labeled for use in MTF, but pest managers need to ensure approval by the health care staff for any pesticides planned for use to ensure they will not have any impact on patients or sensitive equipment. Refer to Material Data Safety Sheets (MSDS) to make sure all pesticide characteristics are covered. Pesticides ideally should have low volatility, low odor, and an ability to remain effective in areas subject to constant washing. Bait stations, insect growth regulators and carbamate pesticides have been used with success in MTF.

Contingency considerations. In contingency operations, most established MTF and laboratories will expand to capacity to handle people evacuated from operational areas and to handle additional tests or evaluations. This will usually be done by opening up contingency wards or laboratory wings not operational during normal operations. Inspect these facilities and begin pest management operations before they open. In the contingency area, MTF and laboratories often have the same pest problems described above, but due to the nature of contingency environments, pest management may be more difficult since long-term measures are often neither practical or possible.

### **Foreign Quarantine Actions**

The U.S. military presence throughout the world creates special problems and responsibilities for those who help move people and material between countries. With nations only hours away from each other, the risk of accidentally introducing disease vectors and agricultural pests into a non-infested area is greater than ever. Disease vectors and agricultural pests may be introduced into this country in or on people, domestic animals, cargo, cargo containers, packing materials, household effects, foodstuffs, souvenirs, or soil on bags, boxes, vehicles, or other military equipment. This is particularly true with retrograde equipment or material. "Retrograde" refers to items returned to the U.S. from a foreign area, normally equipment items that are reintroduced into the supply system, for repair or for salvage.

Interception. Once the danger to health and agriculture from introduced species was established, Congress passed laws to help prevent introduction of any new potential pests. Program responsibility is assigned to the U.S. Department of Agriculture (USDA); the U.S. Department of Health and Human Services Public Health Service (USDHHS, PHS), and the Bureau of Customs, U.S. Treasury Department. DOD responsibilities are described in AR 40-12, AFR 161-4, and SECNAVINST 6210.2, Series Quarantine Regulations of the Armed Forces. These regulations authorize inspectors from the USDA, PHS, and Customs to board Armed Forces vessels and aircraft for thorough examination, subject to security restrictions. Full cooperation with these representatives is required, and liaison with them must be maintained.

Protection of foreign countries. In addition to protecting the U.S. from introduction of foreign species, quarantine regulations also help protect other nations from introduction of domestic disease vectors and agricultural pests. SECNAVINST 6210.2, AR 40-12 and AFR 161-4 Series also provides for compliance with quarantine regulations promulgated by proper authority in foreign ports.

### **Control of regulated pests.**

Inspection. Detecting disease vectors and agricultural pests is critically important if we are to prevent their introduction into any country. Other governmental agencies are responsible for quarantine enforcement and usually conduct inspections, but DOD personnel transporting people and retrograde material from country to country must also be alert to evidence of infestation. Information that a disease vector or agricultural pest is especially abundant at a foreign air or seaport should be sent to quarantine officials, port commanding officers, and the professional pest management personnel commands, so they are forewarned of possible infestations in arriving cargo. The USDA, through its Animal and Plant Health Inspection Service (APHIS), has established training programs



to certify U.S. military personnel to conduct quarantine inspections and certify cargo and equipment as pest free before shipment. Such programs are essential for areas that ship large quantities of retrograde cargo.

Pest suppression/elimination. To prevent the spread of disease vectors and agricultural pests from other countries, the U.S. military must conduct extensive pest management programs at all foreign departure terminals. Depending on the pest species present, here are some actions designed to maximize control efforts:

- Conduct disease vector control in the vicinity of loading docks and aircraft parking ramps.
- Eliminate mosquito breeding near transportation terminals or treat them periodically with an appropriate larvicide.
- Pursue a rodent control program that eliminates rodent harborage and conduct rodent poisoning or trapping as needed.
- Do not store supplies and equipment directly on the ground. Doing so increases access to them by many species of arthropods, mollusks, and nematodes. If ground storage is unavoidable, establish control measures that adequately protect supplies. This should include actions to exclude trees, shrubs, and grass near transportation terminals that may provide harborage for pests.
- Remove all soil from supplies before loading to prevent pests such as insects, nematodes, and weed seeds from contaminating supplies.
- As directed, fumigate infested materials before packing. Many common household and stored products pests causing extensive damage in the U.S. were introduced here in furniture and agricultural commodities before the establishment of present quarantine laws.
- Make sure materials and crates used for packing meet USDA specifications.
- Some fresh produce (e. g., citrus, potatoes, salad vegetables) is procured overseas for shipboard consumption. Make sure this produce isn't off-loaded in the continental United States or in other areas where agricultural pests present a threat. Also take care not to store foreign products where pests can migrate and infest other stored goods.

If a pest listed as quarantined is found in or on military retrograde cargo, immediate action must be taken to eliminate the infestation. Normally, this is the only time the U.S. military takes pest eradication measures on a large scale basis.

### **Records and Reports**

The success and continuity of a sound IPM program is often determined by the availability of accurate operational records and reports. The best way to ensure timely and proper management measures, justify funds and personnel, and meet supply and equipment requirements is to maintain detailed records. Such records also help support the value of long-term and preventive management

actions. Specific forms for record keeping include Department of Defense Form 1532-1, Pest Management Maintenance Record, and DD Form 1532, Pest Management Report.

Other reporting responsibilities. In addition to the reports dealing exclusively with pest management, there are several other reports which should give information on pest management activities. These reports provide information to decision makers and can have a direct positive effect on the pest management effort. These reports include:

- Preventive medicine reports (command health reports, epidemiological reports).
- Veterinary activities reports (AR 40-657, AFR 163.2, and NAVSUPINST 4355.4, and Marine Corps Order (MCO) P10110.31).
- Product quality deficiency reports (Standard Form 368) - used to report material and equipment deficiencies, such as label errors, and insufficient active ingredients, and so on.
- Reports of discrepancy (Standard Form 364) - used to report packaging discrepancies, such as leaking containers, labels missing, and so on.
- Unit training reports.

### **Mosquito Abatement (Management)**

Introduction. Mosquitoes often present the most problems with annoyance and disease transmission on deployments and this section is presented specifically to address this potential problem. Mosquito abatement methods may be either long term or temporary programs directed against larvae or adults. Larvae management includes using larvicides and eliminating breeding sources by improving water drainage or using other methods of water management. Managing adults may involve applying insecticidal aerosols and sprays over infested areas, using residual sprays, chemical barriers, and/or personal protection methods such as screens, nets, and repellents.

Long-term methods. Long-term abatement methods focus on controlling water where mosquitoes breed. Ditching, pumping, filling and similar measures can take much time, labor and equipment to give long-term results. Their high initial cost, both to implement and to maintain equipment, must be weighed against the cost of temporary measures, such as insecticide application, on a scheduled and continuing basis, but results are much more effective and permanent when conducted properly.

#### **Stream and pond management:**

Improving natural draining. Shallow sluggish streams and ponds containing plant growth provide excellent conditions for mosquito breeding. Increasing the water flow rate and reducing its surface area to decrease mosquito breeding; this is often less expensive than other methods. Obtain instruction from maintenance engineers to plan and carry out this operation.

Stream flushing. Where existing drainage control includes small dams, it may be possible to use these systems for mosquito abatement. To do this, periodically release collected water, either

manually or by automatic siphon, to flush the stream below the dam. The stream must have sufficient channel capacity to prevent the stream from flooding over its banks. This can be a very effective means of abatement if it is possible to flush a stream more often than it takes for the specific mosquito species breeding in it to complete its aquatic development.

Impounded water. Mosquito abatement in impounded water depends on reservoir preparation, water level fluctuation and proper shoreline maintenance. Clear reservoirs to provide a clean water surface after impoundment between maximum and minimum water levels. Fill or alter depressions between minimum and maximum water levels to drain during water level fluctuations of the lake or pond. Accomplish winter impounding after the normal breeding season ends. Lower the water level at intervals not to exceed 10 days to strand eggs, larvae and pupae at the margin, strand protective debris, and expose larvae to predators. Changes to water levels may involve a cyclical fluctuation, a seasonal recession, or a combination of these methods. Shoreline drainage, removing and burning driftwood, and controlling growth of shoreline vegetation should all be a part of this action so water level fluctuation will not cause an increased breeding area for another pest species.

Aquatic vegetation management. Aquatic vegetation protects mosquito larvae and pupae from wave action and natural enemies and, in some cases, may seriously interfere with larvicidal applications on the water surface. If such vegetation is a serious problem, its elimination becomes an essential part of mosquito abatement. Either chemical or mechanical removal may be the proper procedure, depending on the type of vegetation, size of area, and how the water is used. Give consideration to soil erosion and effects of any vegetation management techniques on fish and wildlife. Obtain technical assistance from the natural resources management staff or the command entomologist/EFD applied biologist before undertaking aquatic weed management.

Coastal marshes. A thorough knowledge of the species and habits of the mosquitoes is necessary to effectively conduct management of these areas. Salt content in the water may seriously affect or limit the breeding of some species. Opening channels to let sea water enter breeding areas, or excluding sea water to reduce salt content may measurably reduce mosquito breeding. Use tide gates to prevent salt water from leaking in natural water courses or ditches. Two or more gates are sometimes used side by side. Any effort to manage coastal marshes for mosquito abatement should first be coordinated with a command entomologist or EFD applied biologist for such programs.

Fish. Surface feeding fish are sometimes used as a supplementary control measure against mosquito larvae. The most useful are killifishes (*Fundulus spp.*) in salt water and top minnows (*Gambusia, Labistes and Panchax spp.*) in fresh water. If such fish are available in an operational area, they can be translocated for this purpose, if practical.

Pumping. Use pumps to drain water when the area to be drained is at or below the water level of an adjacent body of water. Several standing pools may be drained into one, and the water pumped from this pool to the selected outfall.

Filling and grading. Fill and grade shallow pools to prevent mosquitoes from breeding in such places as beneath buildings, on improved grounds, or beside roadways. Filling may reclaim valuable land areas, as well as eliminate mosquito breeding. If hydraulic filling is recommended, take care not to block natural drainage. Cracks and low areas are likely to form as the fill settles, and will afford

breeding places when flooded. Pest managers can effectively treat these areas with mosquito larvicides.

Ditching. Adequate ditching should remove water so ground surfaces become dry and ditch levels return to normal within 4-7 days (depending on climate and species) after the ditch is filled by heavy rainfall or irrigation. Soil texture, topography, vegetation, rainfall, and water movement during tides in salt marshes are important factors. In designing drainage systems, care must be used to prevent creating mosquito breeding areas in new locations.

Temporary methods. Larvicides and adulticides are the most important temporary mosquito abatement methods, and they can be used to give immediate relief from mosquitoes and when more permanent measures are lacking or in planning. Temporary methods are often much less costly than permanent measures. In some instances, such temporary methods may be less expensive than permanent systems provided they do not adversely affect people or the environment. Also, temporary methods often are necessary to rapidly reduce disease vectors during an arthropod-borne disease epidemic or during short-term operations in an endemic disease area.

Larval management. To temporarily manage mosquito breeding, treat water surfaces with insecticides, or eliminate small water accumulations in temporary containers. Breeding areas include most types of ground water accumulations, as well as containers such as tin cans, cisterns, wells, reservoirs, fire barrels, roof gutters, tires, catch basins, etc. All such water-holding containers must be treated for effective management to be achieved.

Larviciding can be done with many forms of pesticides. Solutions, emulsions, suspensions, dusts or granules can be applied with ground-operated equipment. Granular formulations should be used where a heavy plant cover must be penetrated.

Containers such as empty tin cans and old tires, in which mosquitoes may breed, should be eliminated as much as possible. Treat those that cannot be eliminated with larvicide to prevent breeding. Solicit the help of all people in the area to eliminate temporary water containers.

Adult control. Adult mosquitoes in indoor areas can be effectively controlled with residual chemicals for treating potential resting surfaces, and space sprays. Adequately screening occupied structures is also essential where mosquitoes occur. Screens with apertures equivalent to 18 x 16 mesh are essential to keep disease-bearing and pest mosquitoes, flies, and other insects from entering buildings. Ultra Low Volume (ULV) space treatments are ideal for outdoor mosquito control. In areas where breeding is continuous or the population is dominated by migratory species, ULV space sprays alone are seldom satisfactory unless done on a repetitive basis. Such repetitive treatments are usually very expensive and pose some risk to people or the environment. When properly applied on a non-repetitive schedule, ULV space treatments will leave a small residual deposit that is not dangerous or unsightly. Exterior residual sprays have limited value in protecting single residences or small camps. For larger areas where ULV treatments are not possible, residual spray should be applied to vegetation surfaces within a radius of 100 feet or more around the site to protect people and kill mosquitoes resting in the vegetation.

## **Section 17. Selected References**

AMA Handbook of Poisonous and Injurious Plants, K. F. Lampe and M. A. McCann, American Medical Association, Chicago, 1985.

Personal Protective Measures Against Insects and Other Arthropods of Military Importance, Armed Forces Pest Management Board Technical Information Memorandum No. 36.

Guide to Poisonous and Toxic Plants, US Army Environmental Hygiene Agency, Technical Guide No. 196, Aberdeen Proving Ground, MD, 1994.

Guide to Entomological Surveillance During Contingency Operations, U.S. Army, Walter Reed Army Institute of Research, 2001.

US Army Field Manual 21-76, Survival, June 1992.

Tick-borne Diseases: Vector Surveillance and Control, Armed Forces Pest Management Board Technical Information Memorandum No. 26.

The World of Venomous Animals, M. Freiberg and J. G. Walls, T. F. H. Publication, Inc., Ltd., Neptune City, NJ, 1984.

Truman's Scientific Guide to Pest Control Operations, G. W. Bennett, J. M. Owens and R. M. Corrigan, Advanstar Communications, Duluth, MN, 1988.

## **Section 18. Notes**