



NAVFAC
Naval Facilities Engineering Command

ENGINEERING SERVICE CENTER
Port Hueneme, California 93043-4370

TECHNICAL REPORT

TR-2279-ENV

FINAL REPORT – COST AND PERFORMANCE REVIEW OF ELECTRICAL RESISTANCE HEATING (ERH) FOR SOURCE TREATMENT

Prepared by
Arun Gavaskar, Battelle
Mohit Bhargava, Battelle
Wendy Condit, Battelle

Prepared for
Naval Facilities Engineering Service Center

March 2007

Approved for public release; distribution is unlimited.

REPORT DOCUMENTATION PAGE			Form Approved OMB No. 0704-0811		
The public reporting burden for this collection of information is estimated to average 1 hour per response, including the time for reviewing instructions, searching existing data sources, gathering and maintaining the data needed, and completing and reviewing the collection of information. Send comments regarding this burden estimate or any other aspect of this collection of information, including suggestions for reducing the burden to Department of Defense, Washington Headquarters Services, Directorate for Information Operations and Reports (0704-0188), 1215 Jefferson Davis Highway, Suite 1204, Arlington, VA 22202-4302. Respondents should be aware that notwithstanding any other provision of law, no person shall be subject to any penalty for failing to comply with a collection of information, if it does not display a currently valid OMB control number.					
PLEASE DO NOT RETURN YOUR FORM TO THE ABOVE ADDRESS.					
1. REPORT DATE (DD-MM-YYYY) March 2007		2. REPORT TYPE Final		3. DATES COVERED (From - To)	
4. TITLE AND SUBTITLE FINAL REPORT – COST AND PERFORMANCE REVIEW OF ELECTRICAL RESISTANCE HEATING (ERH) FOR SOURCE TREATMENT			5a. CONTRACT NUMBER		
			5b. GRANT NUMBER		
			5c. PROGRAM ELEMENT NUMBER		
6. AUTHOR(S) Arun Gavaskar, Battelle Mohit Bhargava, Battelle Wendy Condit, Battelle			5d. PROJECT NUMBER		
			5e. TASK NUMBER		
			5f. WORK UNIT NUMBER		
7. PERFORMING ORGANIZATION NAME(S) AND ADDRESSES Commanding Officer Naval Facilities Engineering Service Center 1100 23 rd Avenue Port Hueneme, CA 93043			8. PERFORMING ORGANIZATION REPORT NUMBER TR-2279-ENV		
9. SPONSORING/MONITORING AGENCY NAME(S) AND ADDRESS(ES) Commanding Officer Naval Facilities Engineering Service Center 1100 23 rd Avenue Port Hueneme, CA 93043			10. SPONSOR/MONITORS ACRONYM(S)		
			11. SPONSOR/MONITOR'S REPORT NUMBER(S)		
12. DISTRIBUTION/AVAILABILITY STATEMENT Approved for public release;; distribution is unlimited					
13. SUPPLEMENTARY NOTES					
14. ABSTRACT This cost and performance report is a critical review of technical and performance data from four recent Navy projects and one National Aeronautic and Space Administration (NASA) project involving the use of Electrical Resistance Heating (ERH) for treatment of source zones containing dense nonaqueous-phase liquid (DNAPL) or high concentrations of volatile contaminants. ERH is a remediation technology that involves passing electrical current through saturated or unsaturated soil, resulting in increased subsurface temperatures usually to the boiling point of water. The soil is heated by the passage of current through the electrodes and not by the electrodes themselves. ERH increases the subsurface temperatures beyond the boiling point of the contaminants like chlorinated volatile organic compounds (CVOCs) causing them to transition into the vapor phase to be removed through vapor recovery wells. ERH does not directly remove contaminants from the subsurface but rather it creates the changes in physical, chemical, and biological conditions that facilitate their removal from the subsurface or their in situ transformation to potentially non-toxic compound.					
15. SUBJECT TERMS Electrical resistant heating (ERH), Naval Facilities Engineering Service Center (NFESC), remediation, nonaqueous-phase liquid (DNAPL)					
16. SECURITY CLASSIFICATION OF:			17. LIMITATION OF ABSTRACT	18. NUMBER OF PAGES	19a. NAME OF RESPONSIBLE PERSON
a. REPORT	b. ABSTRACT	c. THIS PAGE			19b. TELEPHONE NUMBER (include area code)
U	U	U	U	132	

Final Report

**Cost and Performance Review of
Electrical Resistance Heating (ERH) for
Source Treatment**

Prepared For:

Naval Facilities Engineering Service Center (NFESC)
Port Hueneme, California

Prepared By:

Arun Gavaskar, Mohit Bhargava, and Wendy Condit
Battelle
Columbus, Ohio

February 15, 2007

EXECUTIVE SUMMARY

The five Electrical Resistance Heating (ERH) projects at the Navy and the National Aeronautics and Space Administration (NASA) sites provide a wealth of information on the performance of this remediation technology under different site conditions, and the lessons learned from these early applications serve as a good guide for future users. The five sites included in this review are Naval Weapons Industrial Reserve Plant (NWIRP) Bedford, Cape Canaveral Air Station, Naval Complex Charleston, former Naval Air Station (NAS) Alameda, and Marine Corps Base (MCB) Camp Lejeune.

Performance data from these sites indicate that ERH treats dense nonaqueous-phase liquid (DNAPL) source zones through a variety of mechanisms. The primary mechanism in most source zone applications is the volatilization and recovery of chlorinated volatile organic compound (CVOC) contaminants by the application of electrical energy, which gets converted to heat in the aquifer. The following masses of target CVOCs were recovered from the treated aquifer at these sites by this mechanism:

- Approximately 90 lb of total volatile organic compound (VOC) mass was recovered aboveground from the captured vapors at the NWIRP Bedford site.
- An estimated 4,283 lb (1,947 kg) of trichloroethene (TCE) were recovered from the subsurface at Cape Canaveral Air Station.
- An estimated 234 lb of perchloroethene (PCE) (and 247 lb of total CVOCs) were recovered aboveground at Naval Complex Charleston.
- More than 3,000 lb of VOCs were recovered from the subsurface at former NAS Alameda.
- An estimated 48,000 lb of chlorinated solvent was recovered from the subsurface at MCB Camp Lejeune.

In the short-term, mass removal by volatilization and capture from the subsurface is often the primary mechanism of treatment. CVOC volatilization and capture are facilitated by heating, which favorably modifies CVOC properties, such as solubility (increases), viscosity (decreases), Henry's Law constant (increases), octanol-water co-efficient (decreases), and aqueous diffusion rate (increases).

In the short- and long-term, other potential treatment mechanisms that often come into play are enhanced biodegradation and abiotic reactions, such as hydrolysis. Indicators of some of these reactions occurring were present at all five sites reviewed.

The review of ERH application at these five sites provides considerable information on the performance and challenges in implementing the technology at different types of sites. The lessons learned from the review are summarized as follows:

- In addition to contaminant removal and recovery goals, one design goal of the ERH treatment should be to reach the desired temperatures in all portions of the target treatment zone.
- Thermocouple bundles at several depths at several locations in the treatment zone are a cost-effective way of obtaining important temperature information.
- The design temperatures should be based on the adjusted boiling points of the individual CVOCs and of water (after accounting for depth). The adjusted boiling points of CVOCs in the aquifer are lower than their normal boiling points

as pure phase in air because many CVOCs form minimum boiling azeotropes with water (the boiling point of the CVOC in an aquifer is expected to be below the normal boiling points of both the CVOC and water).

- Daily recovery rates of CVOCs in the vapor phase increase sharply when the adjusted boiling points of the individual major components are reached, and increase sharply again when the boiling point of water has been reached.
- The actual boiling points of the CVOCs and water in an aquifer could be different from the theoretical predictions of normal boiling points (of pure phase) and adjusted boiling points (minimum boiling azeotropes of CVOC in water) due to several reasons. Firstly, these predictions of adjusted boiling points are based on our understanding of binary systems, whereas a typical aquifer is a mixture of more than two components. Secondly, the presence of non-volatile solutes (e.g., chloride, sulfate, etc.) in the groundwater can drive the boiling points upwards. That said however, the experience at the five sites reviewed does seem to show increased recovery of CVOCs at certain critical temperatures predicted by these adjusted boiling points.
- In general, the best results are achieved when the actual boiling point of water (the normal boiling point of water of 100 °C, adjusted for depth) is reached in the aquifer. When this temperature is reached and maintained for several days, CVOC and DNAPL removal is likely to be more complete. If the site characteristics make this difficult, at least the adjusted boiling points of the major parent CVOCs should be reached.
- Achieving the desired temperatures is more difficult in low-permeability formations than in higher-permeability aquifers. Drying around the electrodes, depression of the water table, and the inefficiencies of heating newly unsaturated regions of the aquifer can reduce heating efficiency. Considerably slower heating and longer durations may be required at low-permeability sites.
- In the short-term, aquifer temperature is the best parameter that indicates successful DNAPL removal. Therefore, achievement of design temperatures in all parts of the target aquifer is a good performance goal.
- Temperatures and daily CVOC mass recovery rates can be used together to determine a suitable exit point for the ERH application.
- In the longer-term, continued groundwater monitoring is a good indicator of DNAPL removal performance. A rebound in CVOC levels in a monitoring well would indicate that there still is residual DNAPL mass in the vicinity.
- In addition to volatilization and steam stripping, enhanced biodegradation and other abiotic reactions at elevated temperatures were an active mechanism at all five sites. Degradation of some components of organic matter at elevated temperatures and the consequent increase in the availability of a carbon source is advantageous for bioremediation.
- Accumulation of *cis*-1,2-DCE after ERH treatment at sites, such as Bedford and Cape Canaveral, may indicate that suitable microbial populations to take the treatment to completion may not be present at some sites or may be small enough that they would require additional stimulation to treat byproducts, such as *cis*-1,2-DCE and 1,1-DCA. At other sites, such as Camp Lejeune, byproducts, such as *cis*-1,2-DCE, themselves degraded substantially in the 6 months following the

end of ERH application. Because the aquifer temperature remains elevated for several months following ERH application (cooling is slow at many sites), enhanced biological and abiotic reactions can alleviate residuals, as long as suitable microbial populations are present.

- Experience in engineering the ERH application has grown over the years. Many of the operational challenges at these sites were addressed by the vendor in innovative ways. The ERH application, including the vapor recovery system, has to be engineered differently for different sites, taking into account factors such as the permeability of the formation, groundwater recharge rates, depth of water table below ground surface (initial thickness of vadose zone), properties of the target CVOCs, and locations of DNAPL.

CONTENTS

EXECUTIVE SUMMARY	ii
FIGURES	vi
TABLES	vii
ACRONYMS AND ABBREVIATIONS	ix
SECTION 1.0: INTRODUCTION	1
1.1 Report Organization	1
1.2 ERH Technology Description	2
SECTION 2.0: ERH APPLICATION AT NWIRP BEDFORD.....	5
2.1 Introduction	5
2.2 Geology and Hydrogeology	5
2.3 Contamination Distribution	6
2.4 Technology Implementation.....	6
2.5 Performance Evaluation Approach.....	6
2.6 Technology Performance.....	7
2.7 Cost.....	9
2.8 Discussion	9
SECTION 3.0: ERH APPLICATION AT CAPE CANAVERAL AIR STATION	28
3.1 Introduction	28
3.2 Geology and Hydrogeology	28
3.3 Contamination Distribution	29
3.4 Technology Implementation.....	29
3.5 Performance Evaluation Approach.....	30
3.6 Technology Performance.....	31
3.7 Cost.....	35
3.8 Discussion	36
SECTION 4.0: ERH APPLICATION AT CHARLESTON NAVAL COMPLEX.....	53
4.1 Introduction	53
4.2 Geology and Hydrogeology	53
4.3 Contamination Distribution	53
4.4 Technology Implementation.....	53
4.5 Performance Evaluation Approach.....	54
4.6 Technology Performance.....	54
4.7 Cost.....	55
4.8 Discussion	56
SECTION 5.0: ERH APPLICATION AT FORMER NAS ALAMEDA.....	68
5.1 Introduction	68
5.2 Geology and Hydrogeology	68
5.3 Contamination Distribution	68
5.4 Technology Implementation.....	68
5.5 Performance Evaluation Approach.....	69
5.6 Technology Performance.....	70
5.7 Cost.....	71
5.8 Discussion	71

SECTION 6.0: ERH APPLICATION AT MCB, CAMP LEJEUNE.....	85
6.1 Introduction	85
6.2 Geology and Hydrogeology	85
6.3 Contamination Distribution	85
6.4 Technology Implementation.....	86
6.5 Performance Evaluation Approach.....	87
6.5.1 Subsurface Temperature And Vapor Monitoring	87
6.5.2 Groundwater Monitoring	87
6.5.3 Air Monitoring.....	87
6.5.4 System Monitoring	87
6.6 Technology Performance.....	88
6.7 Cost.....	90
6.8 Discussion	91
 SECTION 7.0: SUMMARY OF CONCLUSIONS AND DISCUSSION	 108
7.1 Heating Efficiency and Temperatures	108
7.2 Enhanced Biodegradation and Abiotic Destruction Mechanisms	112
7.3 Operational Issues	113
7.4 Performance Monitoring	114
7.5 Costs	115
7.6 Summary of Lessons Learned	116
 SECTION 8.0: REFERENCES	 121

FIGURES

Figure 1-1. A General Schematic Layout of an ERH System Being Applied (GWRTAC, 2003)	3
Figure 2-1. Location of NWIRP Bedford	16
Figure 2-2. Geologic Cross-Section of Bedford Treatment Site Area and Vicinity (Tetra Tech, 2003).....	17
Figure 2-3. Electrode Construction and Geologic Stratification Detail	18
Figure 2-4. Groundwater Gradient at Bedford, ERH Site.....	19
Figure 2-5. TCE ($\mu\text{g/L}$) Distribution in the Pilot Test Area	20
Figure 2-6. ERH Layout at Bedford Site	21
Figure 2-7. CVOC Concentrations in MW-58IR.....	22
Figure 2-8. CVOC Concentrations in MW-56I.....	23
Figure 2-9. CVOC Concentrations in MW-50I.....	24
Figure 2-10. Temperatures Versus Time In ERH Treatment Area	25
Figure 2-11. Temperature Versus Depth Profiles in TMP-5 (Near MW-58IR).....	26
Figure 2-12. Temperature Versus Depth Profiles in TMP-1 (near MW-50I)	27
Figure 3-1. Cape Canaveral Site Location Map.....	42
Figure 3-2. Geological Cross-Section of Cape Canaveral Treatment Area	43
Figure 3-3. Contaminant Distribution Profile at Cape Canaveral Site.....	44
Figure 3-4. System Layout.....	45
Figure 3-5. Temperature Profile at TMP-1 and TMP-2	46
Figure 3-6. Temperature Profile at TMP-3 and TMP-4	47
Figure 3-7. Soil Boring and Monitoring Well Locations	48
Figure 3-8. TCE Concentrations in Soil (mg/kg) Before ERH Application	49
Figure 3-9. Temperature Mapping at 5 ft bgs in ERH Plot and Surrounding Aquifer.....	50
Figure 3-10. Unconfined (Surficial) and Semi-Confined Aquifers at Cape Canaveral	51

Figure 3-11.	Deep (Semi-Confined Aquifer) Monitoring Well Locations	52
Figure 4-1.	ERH Site Layout and Monitoring Wells Location Map.....	61
Figure 4-2.	Geological Cross-Section at Charleston Site.....	62
Figure 4-3.	PCE Distribution Before and After ERH Treatment.....	63
Figure 4-4.	ERH System Layout at Charleston Site.....	64
Figure 4-5.	Subsurface Thermocouple Temperature at 7 ft bgs.....	65
Figure 4-6.	Subsurface Thermocouple Temperature at 11 ft bgs.....	66
Figure 4-7.	Daily Recovered Mass of PCE and Total CVOCs	67
Figure 5-1.	Site 5 Location at Former NAS Alameda.....	78
Figure 5-2.	Geological Cross-Section at Site 5	79
Figure 5-3.	Site 5 CVOC Plumes Location.....	80
Figure 5-4.	Layout of ERH Electrode and Thermocouple Arrays in CVOC Plume.....	81
Figure 5-5.	System Layout.....	82
Figure 5-6.	CVOC Mass Removal Rates	83
Figure 5-7.	Temperature Distribution at 12 ft bgs	84
Figure 6-1.	Horizontal Extent of DNAPL Source Areas	99
Figure 6-2.	Vertical Geologic Cross-Section and Distribution of DNAPL	100
Figure 6-3.	ERH Layout at Site 89.....	101
Figure 6-4.	Temperature Versus Depth Profile After Few Weeks of ERH Application at the Site.....	102
Figure 6-5.	Temperature Versus Depth Profile.....	103
Figure 6-6.	Temperature Versus Depth Profile.....	104
Figure 6-7.	Temperature Versus Depth Profile.....	105
Figure 6-8.	Temperature Versus Depth Profile Around System Shutdown.....	106
Figure 6-9.	Cumulative VOC Mass Removed During ERH Application	107

TABLES

Table 2-1.	Bedford Site Groundwater Sampling Data.....	11
Table 2-2.	Bedford Water Level Measurement Data.....	12
Table 2-3.	Subsurface Temperature Data from Thermocouples.....	13
Table 2-4.	Contaminants Boiling Temperatures	14
Table 2-5.	Bedford Vapor Sample Results	14
Table 2-6.	Electrical Resistive Heating Costs at NWIRP, Bedford.....	15
Table 3-1.	Distribution of Pre- and Post-Demonstration TCE Concentrations (mg/kg) in the SPH Plot Soil.....	37
Table 3-2.	Changes in Groundwater Parameters	40
Table 3-3.	Surface Emissions Sampling Results	41
Table 4-1.	CVOC Concentrations in Groundwater Inside the Treatment Zone	57
Table 4-2.	CVOC Concentrations in Groundwater Outside the Treatment Zone.....	59
Table 4-3.	Summary of Costs of ERH Application at Charleston	60
Table 5-1.	Groundwater Parameters in Existing Wells at ERH Site	73
Table 5-2.	Groundwater Parameters in New Wells 6S and 7S	75
Table 5-3.	Subsurface Temperatures (°C) at ERH Site	76
Table 5-4.	Electrical Resistance Heating Costs at Alameda Point	77
Table 6-1.	VOC Concentrations in the Recovered Vapor Phase	93
Table 6-2.	Monitoring Wells, Inside Treatment Zone at Shallow Depth (5 to 10 ft bgs).....	94
Table 6-3.	Monitoring Wells Inside Treatment Zone at Intermediate Depth (20 to 25 ft bgs).....	96
Table 6-4.	Monitoring Wells Outside the Treatment Zone.....	97
Table 6-5.	Electrical Resistive Heating Costs at Camp Lejeune	98

Table 7-1. Contaminants Boiling Temperatures	119
Table 7-2. Characteristics of ERH Application Sites	119
Table 7-3. Illustrative Summary of Costs and Operating Features of the ERH Applications	120

ACRONYMS AND ABBREVIATIONS

AMRAD	Advanced Medium Range Air-to-Air Missile Development
AOC	area of concern
AWS	air/water separator
bgs	below ground surface
BOD	biochemical oxygen demand
BRAC	Base Realignment and Closure Act
BSU	Bay Sediment Unit
CATOX	catalytic oxidizer
cm/s	centimeter per second
COC	contaminant of concern
CVOC	chlorinated volatile organic compound
DCA	dichloroethane
DNAPL	dense nonaqueous-phase liquid
DO	dissolved oxygen
DRMO	Defense Reutilization Marketing Office
ERH	Electrical Resistance Heating
ESB	Engineering Support Building
ESTCP	Environmental Security Technology Certification Program
FID	flame ionization detector
FWBZ	first water-bearing zone
GAC	granular activated carbon
gpm	gallons per minute
IDC	Interagency DNAPL Consortium
IR	Installation Restoration
ISCO	in-situ chemical oxidation
KO	knock-out
LNAPL	light, nonaqueous-phase liquid
MCB	Marine Corps Base
MFGU	Middle Fine Grained Unit
MW	monitoring well
NAPL	nonaqueous-phase liquid
NAS	Naval Air Station
NASA	National Aeronautic and Space Administration
NWIRP	Naval Weapons Industrial Reserve Plant
O&M	operation and maintenance
ORP	oxidation reduction potential

ACRONYMS AND ABBREVIATIONS (continued)

PCA	tetrachloroethane
PCE	perchloroethene
PCU	power control unit
POTW	publicly owned treatment works
ppmv	parts per million by volume
PV	present value
PVC	polyvinyl chloride
QA	quality assurance
RCRA	Resource Conservation and Recovery Act
scfm	standard cubic foot per minute
SPH	six phase heating
SVE	soil vapor extraction well
SWBZ	second water-bearing zone
TCA	trichloroethane
TCE	trichloroethene
TDS	total dissolved solids
TMP	temperature monitoring points
TMW	thermocouple wells
TOC	total organic carbon
U.S. EPA	United States Environmental Protection Agency
UV	ultraviolet
VC	vinyl chloride
VOC	volatile organic compound

Section 1.0: INTRODUCTION

This cost and performance report is a critical review of technical and performance data from four recent Navy projects and one National Aeronautic and Space Administration (NASA) project involving the use of Electrical Resistance Heating (ERH) for treatment of source zones containing dense nonaqueous-phase liquid (DNAPL) or high concentrations of volatile contaminants.

ERH is a remediation technology that involves passing electrical current through saturated or unsaturated soil, resulting in increased subsurface temperatures usually to the boiling point of water. The soil is heated by the passage of current through the electrodes and not by the electrodes themselves. ERH increases the subsurface temperatures beyond the boiling point of the contaminants like chlorinated volatile organic compounds (CVOCs) causing them to transition into the vapor phase to be removed through vapor recovery wells. ERH does not directly remove contaminants from the subsurface but rather it creates the changes in physical, chemical, and biological conditions that facilitate their removal from the subsurface or their in situ transformation to potentially non-toxic compounds.

The Navy has conducted several full-scale and pilot-scale demonstration projects using ERH technology. This report evaluates the results of ERH projects that were conducted at the following five sites:

- Pilot-scale demonstration at Site 3, Naval Weapons Industrial Reserve Plant (NWIRP) Bedford, Massachusetts. The report reviewed was *Draft Closeout Report for Thermal Treatment Pilot Test, Naval Weapons Industrial Reserve Plant, Bedford, Massachusetts* (Tetra Tech, 2005a).
- Full-scale ERH Application at Area of Concern 607 at Charleston Naval Complex, Charleston, South Carolina. The report reviewed was *Interim Measure Completion Report/CMS Work Plan/Investigation Work Plan-AOC 607, Zone- F, Charleston Naval Complex, Charleston, South Carolina* (CH2M-Jones, 2003).
- *Demonstration of Resistive Heating Treatment of DNAPL Source Zone at Launch Complex 34 in Cape Canaveral Air Station, Florida* (Battelle, 2003).
- Full-scale ERH application at IR Site 5 at Former Naval Air Station (NAS) Alameda, California. The report reviewed was *Field Activities Report, DNAPL Source Removal Action, Installation Restoration Site 5, Plume 5-1, Alameda Point, Alameda, California* (Shaw, 2005a).
- *Pilot Scale Implementation of ERH at Site 89 at Marine Corps Base (MCB), Camp Lejeune, North Carolina* (CH2M-Hill, 2002; Shaw, 2005b).

The current document is intended to be a synopsis of the results of these technology applications and a consolidation of the lessons learned for future applications.

1.1 Report Organization

This report is organized into the following sections:

Section 1.0: Introduction. This section provides the report framework, an introduction to the ERH technology, and the variations of this technology currently being demonstrated.

Section 2.0: ERH Application at NWIRP Bedford.

Section 3.0: ERH Application at Cape Canaveral Air Station.

Section 4.0: ERH Application at Charleston Naval Complex.

Section 5.0: ERH Application at former NAS Alameda.

Section 6.0: ERH Application at MCB Camp Lejeune.

Section 7.0: Summary of Conclusions. This section summarizes the conclusions and lessons learned from the ERH application at these five sites.

Section 8.0: References. This section lists the references used to prepare this report.

1.2 ERH Technology Description

ERH, as with other thermal technologies, has its origin in the petroleum industry, where it was developed to heat oil sands and shales to enhance oil recovery. Developed in early the 1990s by the Pacific Northwest National Laboratory, ERH uses an electrical current to heat less permeable soils, such as clays and fine-grained sediments, so that water and contaminants trapped in these relatively conductive regions are vaporized and ready for vacuum extraction. It is a promising technology for in situ remediation. This technology has been demonstrated as an effective technology for the removal of volatile and some semi-volatile contaminants from soil and groundwater. Such contaminants generally include the DNAPL contaminants comprising of CVOCs, such as trichloroethene (TCE) and perchloroethene (PCE) and also the light, nonaqueous-phase liquid (LNAPL) contaminants such as petroleum hydrocarbon products.

In the short-term, mass removal by volatilization and capture from the subsurface is often the primary mechanism of treatment. CVOC volatilization and capture are facilitated by heating, which favorably modifies CVOC properties, such as solubility (increases), viscosity (decreases), Henry's Law constant (increases), octanol-water co-efficient (decreases), and aqueous diffusion rate (increases). In the short- and long-term, other potential treatment mechanisms that often come into play are enhanced biodegradation and abiotic reactions, such as hydrolysis. Indicators of some of these reactions occurring were present at all five sites reviewed.

During ERH application, electric current is passed into the subsurface through vertical, angled, or horizontal electrodes. Electrodes are generally installed in the less permeable subsurface soil matrix through conventional drilling techniques that are used to install monitoring wells. Electric current, passed through the electrodes into the subsurface, is conducted through the moisture present in the subsurface soil where the resistance it encounters leads to a uniform heating of the subsurface. Contaminants present in the groundwater are consequently vaporized and then vacuum extracted by the aboveground installed soil vapor extraction system or the vacuum system, as shown in Figure 1-1. Although silt and clay soils exhibit low permeability, they are more electrically conductive than sand due to increased porosity and moisture content. In addition, surface of clay particles are naturally charged. Electrically conductive regions of the soil heat up more vigorously and quickly as they attract a greater electric current. Therefore, ERH is claimed to be an effective method of heating less permeable soils where DNAPL tend to accumulate.

Rise in the temperature of the aquifer is measured by the thermocouple wiring. Typically, thermocouple wires are bundled with uniform distance to be placed at various depths. The whole treatment area is covered with a site cap or plenum to mitigate any fugitive emissions that might occur from the subsurface. This site cap consists of horizontal wells, gravel, insulating material and a final cover of a black and ultraviolet-(UV) resistant polyethylene liner.

Soil vapor extraction (SVE) wells are used to extract volatized vapor resulting from the heating of the vadose and saturated zone. The extracted vapor sometimes contains groundwater together with some other liquids within the treatment area. This extracted vapor mixture passes through an air/water

separator (AWS) tank where the residual contaminants in the vapor are removed through gravity and the condensed steam is channeled through a storage tank and a series of granular activated carbon (GAC) tanks to remove CVOCs before being re-injected into the subsurface. The recovered vapor from the AWS passes through a heat exchanger, cooling tower, and another small AWS to be condensed. This condensate is transferred to the storage tank and passed through the GAC unit. A vacuum blower is used to create a negative pressure to extract the vapor and liquids in the treatment area under the cover. The discharge of the blower is sent to a catalytic oxidizer (CATOX) with a hydrochloric acid scrubber to treat the remaining VOCs in the residual vapor before being discharged to the atmosphere.

The whole treatment system is supplied power through the power control unit (PCU) or the voltage control system, as shown in Figure 1-1. The PCU is a generally skid-mounted electrical control system which includes a transformer and other electrical equipment to supply electric currents to pre-constructed electrodes. A transformer is used to convert electrical power down to six separate electrical phases and to adjust the utility voltage to the appropriate level for subsurface heating. The PCU is capable of isolating the transformer to force ERH current to flow only between the electrodes. The PCU is designed to operate in such a way that the electricity will not be transferred away from the ERH field to outside the treatment area. At or near the main PCU unit, it is generally recommended that an emergency power switch is installed for the system shut-off in case of system failure.

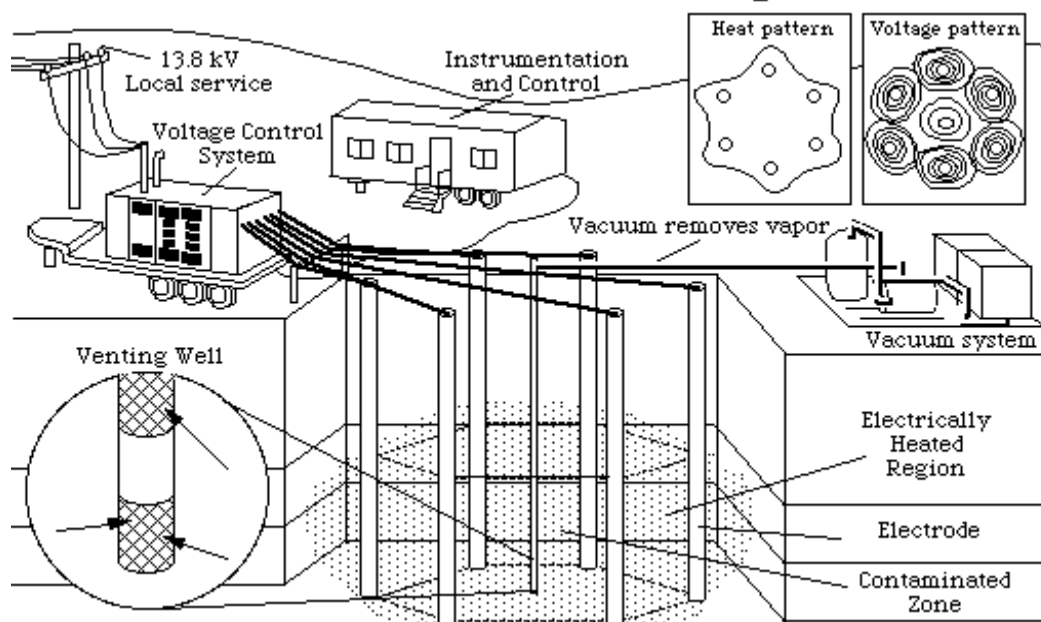

Figure 1-1. A General Schematic Layout of an ERH System Being Applied (GWRTAC, 2003)

ERH application has generally been described to be undertaken in two different patterns of electrode installation: three-phase or six-phase. However, electrode installation in the field may not conform to any of the above two patterns and may depend on the site-characterization to attack the hot spots of the contaminants in whatever pattern they are. Three-phase installation is observed when the electrodes are installed uniformly in a triangular pattern with an electrode at each of the three end-points of a triangle, and in a six-phase installation the pattern of electrodes is hexagonal with a neutral electrode installed at the mid-point of the hexagon. Figure 1-1 shows a six-phase ERH application.

There are certain advantages and disadvantages of ERH application. Advantages are rapid remediation, less dependence on soil heterogeneities and site geology, no introduction of environmentally sensitive chemicals into the aquifer, and promotion of biotic and abiotic processes that speed up contaminant degradation at elevated temperatures. Some disadvantages of ERH are the relatively higher capital investment (for installation of the electrodes), high power consumption, potentially longer heating time requirements in difficult geology, and the need to capture and manage the vapors generated.

Section 2.0: ERH APPLICATION AT NWIRP BEDFORD

2.1 Introduction

NWIRP Bedford is located in the Town of Bedford in Middlesex County, Massachusetts, approximately 15 miles from Boston (Figure 2-1). It is a 46-acre facility which currently is not in use. Located on the Hartwell Hills, the facilities mission was to design, fabricate, and test prototype weapon equipment, such as missile guidance and control systems (Tetra Tech, 2005b).

In 1983 and 1984, benzene, TCE, PCE, and 1,2-dichloroethene (1,2-DCE) were detected in some of the water supply wells of the town of Bedford, located northwest of NWIRP. This led to a series of investigations by the Navy to determine if the contamination was emanating from the NWIRP facility. The results of these investigations determined that the NWIRP facility was responsible for the contamination and that the subsurface was also contaminated with dense, nonaqueous-phase liquids (DNAPL) and a dissolved-phase plume of chlorinated volatile organic compounds (CVOCs). The DNAPL present in the source area was presumed to be responsible for the presence of the dissolved-phase CVOC plume in the groundwater at this site.

The exact location, timing and mechanism of the release(s) of the CVOCs is not documented for this site. The only evidence of a spill that exists is the reported rupture of a 55-gallon aboveground storage tank containing 1,1,1-trichloroethane (TCA) that was located near the Components Laboratory. The contents of the tank are thought to have infiltrated into an underground storm drain line that conveyed the material from the location where it entered the drain to the storm drain discharge. TCE and 1,1,1-TCA were both frequently used in the Components Laboratory, but there is no documentation of their release into the subsurface from inside the laboratory. It is also hypothesized that solvents disposed into storm drains in the paint shop in the Facility Storage Building and the Advanced Medium Range Air-to-Air Missile Development (AMRAD) Building could have contributed to the observed groundwater contamination at the site; however, these releases have not been verified with sampling data.

2.2 Geology and Hydrogeology

Hartwells Hill is comprised of bedrock overlain by glacial deposits of sandy, silty and clayey till (Figure 2-2). The maximum thickness of the sandy till on this hill is 73-ft, but the thickness varies. The silty till layer is 4 to 75 ft thick, with the thickest portion being on the western slope of the hill. The clayey till reaches a maximum thickness of 96 ft beneath the hill but is absent at certain locations such as the flanks of the hill. Figure 2-3 shows the geologic layers encountered in the pilot treatment area during the installation of the ERH electrodes.

Beneath Hartwells Hill, groundwater occurs at depths from 25 to 40 ft below ground surface (bgs). The sandy till is the principal water bearing unit; however, the silty and clayey till and the bedrock are also saturated. Groundwater in this area occurs under unconfined conditions and is recharged by the infiltrating precipitation through the unsaturated zone at the top of Hartwells Hill. The direction of groundwater flow is westerly away from Hartwells Hill towards the wetlands (see Figure 2-4). Permeability tests (i.e., slug tests) and geotechnical laboratory tests indicate a low hydraulic conductivity in the pilot test area ranging from an average of 3.5×10^{-5} centimeters per second (cm/s) to 11.20×10^{-7} cm/s (Tetra Tech, 2005b). This low hydraulic conductivity may have had a bearing on the ERH performance at this site because of the dramatic lowering of the water table and low recharge rate encountered during heating.

2.3 Contamination Distribution

Site 3 consists of a source area of a dissolved phase plume of CVOCs, which is present near the Facility Storage Building and the Components Laboratory migrating down the hills into the Wetlands in the north-west direction. Figure 2-5 shows the concentrations of TCE, the primary contaminant at this site, in various locations near the pilot treatment area. Other contaminants in the groundwater are 1,1,1-TCA, 1,2-DCE, 1,1-DCA, and PCE. The ERH pilot test was performed in an area located approximately 50 ft north of the Components Laboratory (Figure 2-5). The pilot test area was 40 ft wide by 80 ft long with an average treatment depth of 35 ft resulting in a treatment volume of 112,000 cubic ft or 4,148 cubic yards (Tetra Tech, 2005b).

2.4 Technology Implementation

The actual ERH field operation occurred between April 16, 2003 (mobilization started) and November 14, 2003 (demobilization complete). Including pre-treatment and post-treatment monitoring activities, the timeline was as follows:

- Pre-treatment groundwater sampling: June 25-July 1, 2003
- Mobilization, installation of equipment, and start-up/shakedown: April 16-July 30, 2003
- ERH operation: For 53 days beginning July 31 to September 22, 2003, when electrodes were shut down
- Mid-process groundwater sampling: September 10-14
- Post-treatment groundwater sampling: October 2-14, 2003
- Vapor recovery system shut down: October 9, 2003
- Demobilization: November 10-14, 2003
- Long-term monitoring/groundwater sampling: 11 months after electrode shutdown until August 2004.

In order to remediate the pilot area, 24 electrodes with 20-inch boreholes were installed approximately 60 ft bgs at Site 3 (see Figure 2-6). Electrodes were spaced almost 14 ft apart from each other. Due to drilling complication, two electrodes were installed at 50-55 ft bgs instead of the regular 60 ft depth installation. There were five temperature monitoring points (TMP) to record and monitor the subsurface temperature. The aboveground recovery system had four 1,000-lb GAC units to treat the extracted vapor and a 30 gallon liquid GAC vessel to treat the groundwater. The vapor recovery wells were co-located with each electrode borehole. At Site 3, the average soil vapor flow rate was measured to be around 49 standard cubic ft per minute (scfm). By the end of the Site 3 ERH Pilot Test, weekly average power input to the treatment area was 324 kW. The overall Site 3 energy usage for the pilot test was 616,786 kW-hrs.

2.5 Performance Evaluation Approach

Figure 2-6 shows the location of the monitoring wells in relation to the treatment plot, the electrodes (and co-located vapor recovery wells), and temperature monitoring points (TMP-1 to TMP-5). Because of a pronounced lowering of the water table during heating, only three intermediate-depth treatment zone wells (MW-58IR, MW-56I, and MW-50I) were sampled during the mid-process and post-treatment sampling event. Of these three wells, only MW-58IR was sampled in accordance with the Quality Assurance (QA) Plan (low-flow purging). The other two wells had very little water and had to be sampled with a bailer, without sufficient purging. Because of the slow groundwater recharge in the low-

permeability aquifer (~order of 10^{-5} to 10^{-7} cm/s hydraulic conductivity on average) dewatering of large portions of the treatment zone led to drying of all the shallow wells in the treatment zone. Therefore, the three intermediate wells sampled during all events provide the best information on the progress of the treatment due to heating.

2.6 Technology Performance

To illustrate the observed contaminant removal, only the trends in TCE and *cis*-1,2-DCE are shown in Table 2-1 and Figures 2-7, 2-8, and 2-9. As seen in Table 2-1 and Figure 2-7, MW-58IR performed the best, reducing groundwater TCE concentration by 98.5% by the time of mid-process sampling (September 2003) and by 99.7% by post-treatment sampling (October 2003). As seen in Figure 2-7, TCE continued to remain low through the long-term monitoring event (August 2004). DCE levels dropped sharply during the mid-process and post-treatment sampling events, but showed a slight increase during the long-term monitoring. These TCE and DCE trends in MW-58IR illustrate the ideal outcome from DNAPL source remediation, whereby indications are that substantial DNAPL mass has been removed by the initial aggressive treatment and minor amounts of residuals are biodegrading. Because residual TCE levels are low, DCE generation and accumulation (due to microbe-driven anaerobic reductive dechlorination of TCE) are also limited.

MW-56I and MW-50I showed considerable reduction in TCE, but did not perform as well as MW-58IR (see Table 2-1 and Figures 2-8 and 2-9). In MW-56I, which had the highest pre-treatment TCE concentration among the three wells, TCE declined by 97.1% by the time of the mid-process sampling, and by 91.9% by the time of the post-treatment sampling, with the concentration dropping from a pre-treatment 42,000 $\mu\text{g/L}$ to a mid-process 1,200 $\mu\text{g/L}$. Subsequently, TCE concentrations rose to a post-treatment 3,400 $\mu\text{g/L}$ and by the time of the long-term monitoring event in August 2004, had rebounded to 10,000 $\mu\text{g/L}$. DCE levels initially declined from 3,000 to 170 $\mu\text{g/L}$, but subsequently rose to 470 $\mu\text{g/L}$ in the post-treatment event and 3,018 $\mu\text{g/L}$ in the long-term monitoring event. Although groundwater recharge from surrounding contaminated areas is a possibility (the treatment pilot area lies in the midst of a larger area of contamination, especially on the north and west sides), it is also possible that higher DNAPL TCE residuals have persisted in this location due to inadequate heating, especially at greater depths, as discussed below. The sharp rebound in TCE and substantial increase in DCE are indicative of higher post-treatment TCE residuals in this location and the subsequent anaerobic dechlorination stimulated by the persisting elevated temperatures.

In MW-50I too, TCE levels dropped from 3,500 $\mu\text{g/L}$ (pre-treatment) to 890 $\mu\text{g/L}$ (mid-process) and to 680 $\mu\text{g/L}$ (post-treatment). TCE subsequently rose to 1,000 $\mu\text{g/L}$. After declining from 1,822 to 430 $\mu\text{g/L}$ (post-treatment), DCE levels increased sharply to 5,493 $\mu\text{g/L}$, indicating the possibility of residual post-treatment DNAPL TCE at this location.

The case for recontamination of the treatment zone due to recharge is that both MW-56I and MW-50I lie close to the northern edge of the treatment plot, where contamination levels just outside the treatment plot are much higher (291,000 $\mu\text{g/L}$ of TCE in MW-55I). MW-58IR is on the southeast corner of the treatment area, which is not as contaminated. Table 2-2 shows the dramatic lowering of the water table that occurred during the heating. Although water level measurements could not be collected because of safety considerations during the mid-process event (when the water table probably was at its lowest), the readings taken immediately post-treatment (October 10, 2003) show a drop of 15 ft in MW-58IR, 21 ft in MW-56I, and 19 ft in MW-50I. In fact, in Table 2-2, the most recharge among the treatment zone wells appears to have occurred in wells MW-50I and MW-56I, where water levels rebounded by 7 and 5 ft, respectively, between October 10 and 23. The least recharge appears to have occurred in MW-58IR, the well that showed the best CVOC removal performance among these three wells.

However, it is not clear that recharge alone accounts for the rebound in TCE soon after treatment in MW-56I and for the high residual TCE and DCE levels in MW-50I after treatment. Heat application was stopped on September 22, 2003. Figure 2-10 shows that on October 14, the average temperature in TMP-5 (which is closest to MW-58IR) was greater than 90°C and the average temperature in TMP-1 (which is closest to MW-50I) was greater than 80°C, which presumably means that the temperatures at some depths were greater than these averages. With significant recharge, temperatures would have dropped more sharply, in conjunction with sharply rising water levels. Water levels, on the other hand, remained substantially depressed (see Table 2-2) in the post-treatment events on October 10, October 23, and November 6, and were still relatively depressed a year later in August 2004.

There are some variations in heating efficiency at various locations and at various depths in the treatment zone that also could account for the differences in CVOC removal performance. It is interesting to examine Tables 2-2 and 2-3, which show the water levels and temperatures, respectively, recorded in the monitoring wells before, during, and after the treatment. The thick vertical line in Table 2-3 indicates the depth of the depressed water table near TMP-1 (near MW-50I) and TMP-5 (near MW-58IR), as measured on October 10, 2003, immediately after the thermal application. On the left of this line are temperatures where the water has been boiled off (and the soil is unsaturated) and on the right of this line are the temperatures where the soil is still saturated (it is possible that during the ERH application, the water table was depressed even further than these measurements indicate). One apparent trend is that in the shallower depths above the depressed water table (where the soil became unsaturated), temperatures declined at several intervals in both TMP-1 and TMP-5, between August 27 (mid-process) and September 17 (mid-process). This may indicate that after the soil at these depths became unsaturated, heating may not have progressed as efficiently as when the soil was saturated.

The variability in boiling points of water and CVOCs with depth (due to increased pressure from the aquifer above) are as shown in Table 2-4. It appears in Table 2-3 that at some depths, especially below the depressed water table, temperatures never reached the boiling point of either water or TCE. For example, in TMP-1, which is near MW-50I (the well that showed the least TCE removal among the treatment zone wells), temperatures reached 97, 90, 77, and 58°C at 45, 50, 55, and 60 ft bgs. The boiling points should be approximately 115-120°C for water and 85-92°C for TCE at these depths. Another interesting observation is that unlike in MW-58IR and MW-56I where DCE levels declined to very low levels, in MW-50I, DCE levels declined, but persisted at 510 and 430 µg/L in mid-process and post-treatment sampling events. This indicates that the boiling point of *cis*-1,2-DCE (65-72°C at 45-60 ft depth) may not have been reached at some depth intervals near MW-50I.

On the other hand, at TMP-5, which is closer to MW-58IR, temperatures were much higher below the depressed water table, indicating more efficient heating at this location. At 55 ft bgs, temperatures reached 109°C. Consequently, TCE and DCE removal was much more substantial in MW-58IR, compared to MW-50I. Figures 2-11 and 2-12 show the temperature-depth profiles near MW-58IR (TMP-5) and MW-50I (TMP-1), respectively, and illustrate the same trends. Heating was generally better at shallower depths than at deeper intervals. At shallower depths though, as the aquifer lost water and became drier, temperatures started dropping again; the outermost shallow temperature profiles for both TMP-1 and TMP-5 occur on August 27, 2003, indicating that temperatures at several depths peaked well before ERH application was stopped. At around the time of these temperature peaks (August 27), vapor sampling showed that TCE and PCE concentrations peaked in the extracted vapor, (see Table 2-5, vapor sampling events of August 22 and 28, 2003). At deeper intervals, the temperature profiles move progressively outwards, although the temperature increases become progressively smaller as the temperature exceeds that of CVOC boiling points and approaches that of the water boiling point. If electricity and heat application had continued for a few more days, perhaps more volatilization and recovery of PCE, TCE, and DCE would have been evident, as the temperatures in the deeper layers near the clay aquitard rose to the boiling points of TCE (92°C) and then water (120°C).

2.7 Cost

The total project cost was approximately \$1,170,662. Cost details are provided in Table 2-6.

2.8 Discussion

The heating and contaminant recovery performance of the ERH application at the Bedford site was mixed. For example, near monitoring well MW-58IR, both temperature (TMP-5) and groundwater CVOC data are in congruence and indicate relatively good heating of the aquifer and recovery of much of the DNAPL in the vicinity. Near this location, the aquifer was heated to the boiling temperatures of TCE (73-92°C), PCE (88-107°C), and *cis*-1,2-DCE (54-72°C) at all depths. Consequently, CVOC mass recoveries were good for the various CVOC compounds and TCE concentration dropped by 99.7% in this well (MW-58IR). Subsequent (post-treatment, long-term) TCE and *cis*-1,2-DCE rebound were muted at this location (MW-58IR), thus indicating that very little DNAPL remains in this vicinity.

Near monitoring well MW-50I (and thermocouples TMP-1), the groundwater CVOC and temperature data indicate that heating was not very efficient and considerable DNAPL may remain in the vicinity of this location. Temperatures at shallower portions of the aquifer in this location appear to have exceeded the boiling point of TCE, PCE (at some depths), and *cis*-1,2-DCE on August 27, 2003, at around the time that CVOC mass recovery in the vapor phase was also at a maximum. Subsequently, however, temperatures dropped when the water table dropped and the shallower portions of the aquifer became unsaturated. Because of the tight soils and low permeability of the aquifer, recharge probably was not fast enough to keep the water table from dropping in the treatment zone. Although water was added at the electrodes through drip lines, electricity conductance and heating efficiency may have decreased in the newly unsaturated zone. Under the depressed water table, in the deeper portions of the aquifer, temperatures at this location (TMP-1) did not reach the boiling point of TCE or PCE at some depths. At 55 ft bgs (right above the clay aquitard), maximum temperature reached was 77°C, barely above the boiling point of *cis*-1,2-DCE at this depth. Consequently, CVOC mass recoveries were not very good at this location and some DNAPL mass probably remains at this location (MW-50I), as indicated by the longer term rebound in TCE and DCE concentrations.

The fact that many CVOCs (e.g., PCE and TCE) form minimum boiling azeotropes with water would indicate that the CVOCs potentially can boil at temperatures well below their normal boiling points (boiling point of pure compound at 1 atm). For example, TCE (normal boiling point of 87 °C) and PCE (normal boiling point of 121 °C) form azeotropes with minimum boiling points of 73 and 88 °C at 1 atm pressure (near the water table), thus potentially allowing these components to boil at lower temperatures. However, the experience at this and other sites seems to indicate that temperatures do have to reach close to that of the boiling point of water for good recovery of these organic compounds to occur. One reason for this could be that as some CVOC mass volatilizes off and CVOC concentrations in water become lower in some parts of the aquifer, the boiling temperature of the mixture may start approaching that of water. At none of the locations at depths close to the clay (50-55°C) does the Bedford aquifer temperature appear to have reached that of the boiling point of water. The highest temperature recorded was 109°C at TMP-5 on September 17, 2003 (five days before the electrodes were turned off). It is unclear whether continued ERH application would have enabled the aquifer to reach the boiling point of water or whether drying of the low-recharge aquifer and any consequent drop in electrical heating efficiency would have limited temperature to below the boiling point of water. At shallow depths in some locations (e.g., 20-30 ft bgs at TMP-1) too, the temperature does not appear to have reached the boiling point of water, despite the drop in the water table. After the water table dropped, temperatures declined still further at these locations. Only at the shallower intervals (20-25 ft bgs) in TMP-5 and TMP-3 does the temperature appear to have reached the boiling point of water. Also, it should be noted that whereas these azeotropic minimums have been determined for binary mixtures of a single CVOC compound and

water, the groundwater at most sites is a complex mixture of several CVOCs and this may affect the actual boiling temperatures of the system.

Another reason why the actual boiling points of the CVOCs and water may vary from their azeotropic minimums is the presence of native non-volatile solutes (e.g., chloride, sulfate, sodium, etc.) in the groundwater. These non-volatile solutes tend to depress vapor pressures and can cause elevation of boiling points.

The tight soils and low hydraulic conductivity (10^{-5} to 10^{-7} cm/s) of the aquifer make it a difficult remediation environment for any technology, especially ones that involve the distribution of material reagents, such as chemical oxidants or reductants. ERH has the potential to overcome the limitations of a tight formation because electric current can potentially travel through the pore water in tighter silts and clays just as well as (or better than) in more permeable sands. However, the drying of the aquifer (creation of unsaturated zones in the aquifer) due to the slow recharge of groundwater from surrounding areas introduces another element into the equation that is not yet well understood. The ERH vendor's Web site states that electrical current will flow through the soil as long as there is at least 3% moisture by weight. Also, the portions of the aquifer that dry out come under the vacuum applied by the vapor recovery system and, therefore, the boiling points of the CVOCs and water in these regions should be lower. In this case, boiling of liquids in the newly unsaturated zone could occur at lower temperatures.

From a historical perspective, ERH initially was developed to treat the vadose zone. But the temperature data from the Bedford site (and other sites reviewed in this report) indicates that the efficiency of the electricity flow and heating declines when the treated zone becomes unsaturated (no water flow into monitoring wells), leading to a drop in temperatures in the region.

Recharge of groundwater from surrounding contaminated regions of the aquifer could be a contributing factor in the persistent CVOC levels in some wells immediately after ERH treatment and in the rebound in TCE and *cis*-1,2-DCE levels in the longer term (MW-50I and MW-56I). Water levels did rebound in these wells between mid-process and post-treatment (and post-treatment and long-term) monitoring events. However, the water table rebound is relatively slow (which is the reason drying occurred in the first place), as attested to by the slow drop in temperatures in the aquifer in the days following the end ERH application. The relative contributions of recharge (from outside the treatment zone) versus rebound (from inside the treatment zone) to the persistent CVOC levels is unclear from the data. However, regions of the aquifer where temperatures reached the boiling points of the CVOCs fared much better in terms of CVOC mass removal than regions where these temperatures were not reached.

In summary, despite the non-uniform heating in the target zone and the inability to reach CVOC and/or water boiling temperatures in all parts of the target aquifer, an estimated 90 lb of CVOC mass was recovered from the aquifer on the basis of vapor sampling. The temperature measurements indicate that most of this mass may have been recovered from the shallow portions of the aquifer throughout the target treatment zone and from the deeper regions in some parts of the target aquifer. The rebound in TCE and *cis*-1,2-DCE in some monitoring wells indicates that some DNAPL mass probably remains, especially near the base of the aquifer, near the clay. At future sites with low-permeability aquifers, heating probably may have to be slowed enough to avoid drying of the aquifer; the goal would be to reach water boiling temperatures throughout the target aquifer zone and maintain the aquifer at these temperatures for some period of time. Biodegradation of parent compounds (TCE and PCE) was stimulated by the elevated temperatures and this should help treat residual CVOCs and DNAPL faster than natural attenuation alone. Some accumulation of *cis*-1,2-DCE in the aquifer indicates that the microbial populations necessary for complete dechlorination may not have grown to suitable levels yet, or may be absent in the formation.

Table 2-1. Bedford Site Groundwater Sampling Data

Date Collected	6/30/2003	9/10/2003	10/3/2003	10/14/2003	8/18/2004	8/18/2004 (Duplicate)	Percent Removal
Sampling Event	Pre-Test Bladder Pump	Mid-Process Peristaltic Pump/Bailer	Post-Test Bladder Pump	Post-Test Bailer	Long-Term Monitoring Bladder Pump	Long-Term Monitoring Bladder Pump	
Sample Collection Method	Bladder Pump	Peristaltic Pump/Bailer	Bladder Pump	Bailer	Bladder Pump	Bladder Pump	
Contaminants of Concern (COCs)	(µg/L)	(µg/L)	(µg/L)	(µg/L)	(µg/L)	(µg/L)	%
MONITORING WELL MW-58IR							
1,2-Dichloroethene (total)	570	3	5.8J	30	130	--	--
(1,2-DCE)							
Trichloroethene (TCE)	6400	93	19	46	33	--	98.5
MONITORING WELL MW-56I							
1,2-Dichloroethene (total)	3000	170	--	470	3018	2217	--
(1,2-DCE)							
Trichloroethene (TCE)	42000	1200	--	3400	10000	9500	97.1
MONITORING WELL MW-50I							
1,2-Dichloroethene (total)	1822	510	--	430	5493	5193	--
(1,2-DCE)							
Trichloroethene (TCE)	3500	890	--	680	1000	970	74.6

Data not available.

Table 2-2. Bedford Water Level Measurement Data

Monitoring Well Location	Well Screen Interval (ft bgs)	Water Level Measurements Below Top of Casing and Measurement Date (ft bgs)											
		2003										2004	
		7/2	10/10	10/23	11/6	11/19	12/4	12/17	12/3	1/22	1/22		
SITE 3 MONITORING WELL LOCATIONS INSIDE THE PILOT TEST TREATMENT AREA													
MW-55S	20	30	19.7	NR	28.9	28.88	28.56	28.34	27.98	27.37	25.46	25.46	25.46
MW-55I	34	44	18.92	34.04	31.1	29.92	28.8	28.04	26.61	25.57	24.57	24.57	24.57
MW-56S	26	36	16.49	NA	NA	NA	28.94	27.63	26.24	23.33	23	23	23
MW-56I	30	40	17.2	38.33	33.01	30.05	27.02	26.67	NA	22.71	23.07	23.07	23.07
MW-58S	20	30	14.6	NA	NA	NA	27.97	27.08	25.97	23.31	23.18	23.18	23.18
MW-58IR	40	50	15.23	29.8	30.75	29.07	27.27	26.95	NA	23.1	23.44	23.44	23.44
MW-50S	20.5	30.5	18.1	NA	NA	NA	28.99	28.23	27.71	25.5	25.05	25.05	25.05
MW-50I	41	51	19.36	38.5	31.43	29.57	28.96	28.71	27.93	26.11	25.74	25.74	25.74
SITE 3 MONITORING WELL LOCATIONS OUTSIDE THE PILOT TEST TREATMENT AREA													
MW-57S	26	36	18.52	NR	30.92	29.8	28.67	28.47	27.97	25.92	25.52	25.52	25.52
MW-57I	36	46	20.2	29.6	29.6	28.53	28.04	27.74	27.58	26.69	25.71	25.71	25.71

NA: Information not Available; NR: Not Recorded; "S" in Monitoring Well Location: Shallow; "I": Intermediate
 Monitoring Well MW-50R is not listed since it is a bedrock well with a screen interval of 104 to 114 ft bgs.

Table 2-3. Subsurface Temperature Data from Thermocouples

TMP Location	Date (Week Ending)	TMP Average Temperature (°C)		Subsurface Interval Temperature Average (ft bgs/°C) *										
		20-55 ft	5-60 ft	5	20	25	30	35	40	45	50	55	60	
SUBSURFACE TEMPERATURES INSIDE THE PILOT TEST TREATMENT AREA														
TMP-1	8/27/2003	90	83	46	82	97	101	105	102	91	79	66	48	
	9/17/2003	91	83	47	78	89	95	98	100	97	90	77	58	
TMP-3	8/27/2003	90	82	51	92	97	98	100	94	87	80	70	50	
	9/17/2003	99	91	52	97	100	102	104	104	100	95	86	65	
TMP-4	8/27/2003	83	75	48	94	98	99	92	83	75	67	57	37	
	9/17/2003	97	88	50	91	97	100	101	101	101	96	85	60	
TMP-5	8/27/2003	94	85	49	102	104	105	102	91	88	84	75	54	
	9/17/2003	106	98	56	101	102	104	107	107	110	109	109	78	
SUBSURFACE TEMPERATURES OUTSIDE THE PILOT TEST TREATMENT AREA														
TMP-2	8/27/2003	36	34	35	39	41	39	36	33	31	33	31	23	
	9/17/2003	49	46	35	38	51	51	49	48	48	49	45	33	

* The thick vertical lines in the table indicate the pre-treatment (left) and post-treatment water level in wells adjacent to the thermocouple monitoring points

Table 2-4. Contaminants Boiling Temperatures

Compound	Boiling Temperature of Compound in degrees Celsius (°C) In Various Medium	
	Air	Water
	(23 ft bgs)	(55 ft bgs)
Pure water	100	120
1,1-Dichloroethane (DCA)	57	71
1,1-Dichloroethene (DCE)	32	48
<i>cis</i> -1,2-Dichloroethene (<i>cis</i> -DCE)	59	72
Tetrachloroethene (PCE)	121	107
1,1,1-Trichloroethane (TCA)	74	84
Trichloroethene (TCE)	87	92

Table 2-5. Bedford Vapor Sample Results

Sample Collection/ Analysis Date	Vapor Sample Results (Site 3 Pilot Test Operations)									
	Primary VOCs (ppmv)					VOC concentrations total (ppmv)				
	<i>cis</i> -1,2-DCE	1,1-DCA	1,1,1-TCA	TCE	PCE	Primary VOCs	Other VOCs	Total VOCs		
7/31/2003	37.8	2.1	1.8	4.6	4.6	13.1	5.1	18.2		
8/7/2003	2.1	0.52	0.34	0.18	1.2	4	6.6	10.9		
8/14/2003	2	0.48	12	59	15	88.5	20.2	108.64		
8/22/2003	7.4	0.83	6.1	150	17	181.3	39.8	221.13		
8/28/2003	10	1.1	1.1	100	16	128.2	19.2	147.4		
9/6/2003	2.6	0.21	0.39	17	2	22.2	4.62	26.82		
9/11/2003	4	0	0	26	4	34	6.34	41		
9/11/2003 (Dup)	3.7	0.24	0.25	24	3.8	32	6.17	38		

Dup – Duplicate

Table 2-6. Electrical Resistive Heating Costs at NWIRP, Bedford

Item	Basis	Cost
<i>Vendor Cost</i>		
Design, planning		\$27,500
Mobilization, setup	Approx. 6 weeks (includes drilling)	\$451,000
Operation		\$65,900
Power consumption	620,000 kW-Hrs	\$71,000
Demobilization		\$42,700
	Vendor Total Cost	\$658,100
<i>Site Incurred Cost</i>		
Site preparation	Electrician, utility clearing	\$10,010
Waste disposal	GAC and drill cuttings	\$47,165
Analytical		\$9,500
	Site Incurred Cost	\$66,675
<i>Data Management and Reporting</i>		
Work plan		\$19,000
Health and Safety plan		\$8,500
QA/QC plan		\$27,000
Final Report		\$43,387
	Data Management Cost	\$97,887
<i>Project Oversight and Management</i>		
Operation/Maintenance & Oversight	H&S, QC, Engineering, etc.	\$170,000
Management	Spread over several task orders	\$86,000
Admin, Procurement, Cost Controls		\$92,000
	Project Management Cost	\$348,000
	Total Cost	\$1,170,662

Notes:

- (a) Power consumption could be part of vendor's or site's costs, depending on nature of contract (\$71,000 was budgeted but due to a metering error actual costs were lower).
- (b) Site Incurred Cost includes costs over a 2 year period in order to monitor soil temperatures as site cooled after pilot study.

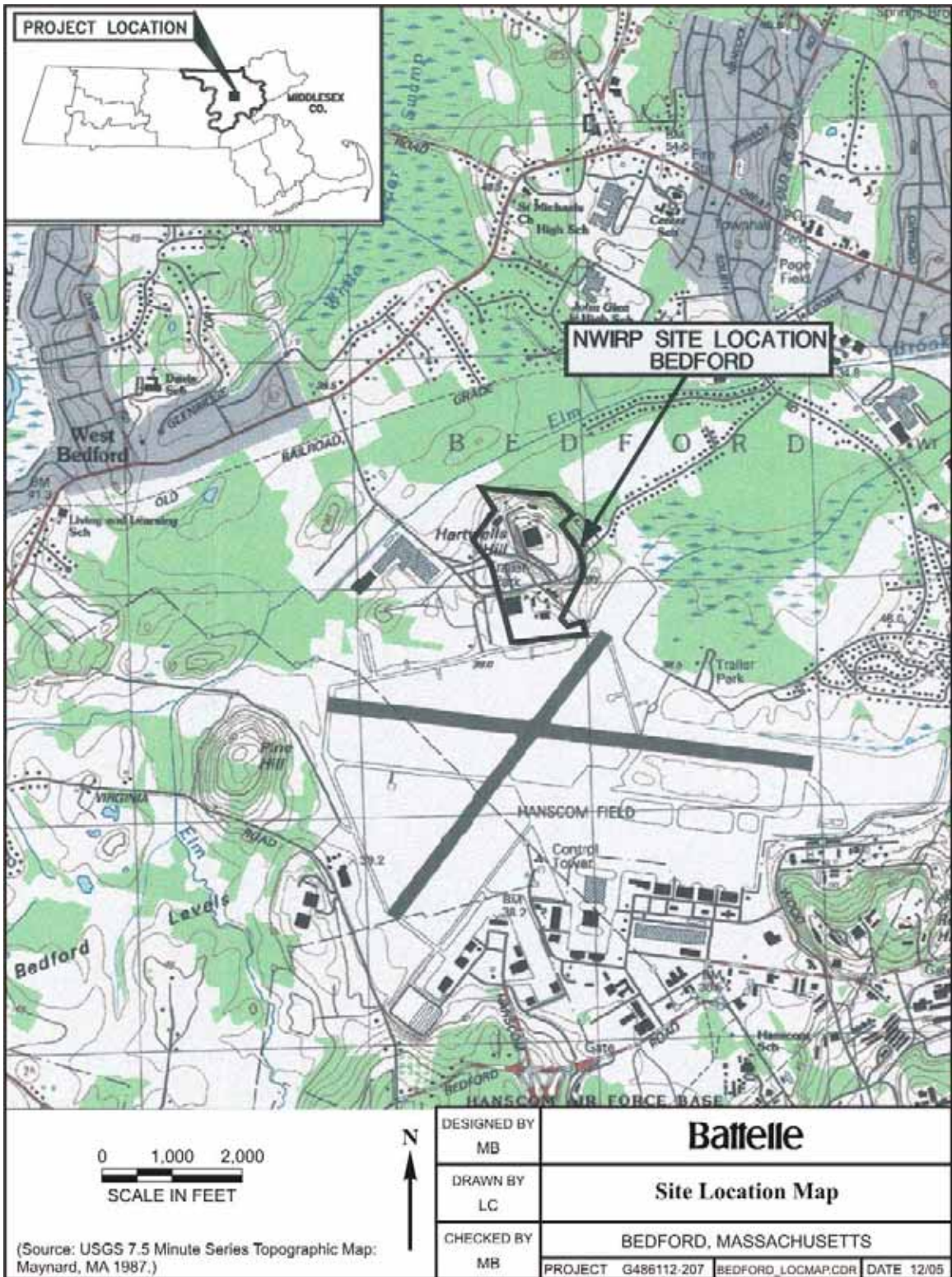

Figure 2-1. Location of NWIRP Bedford

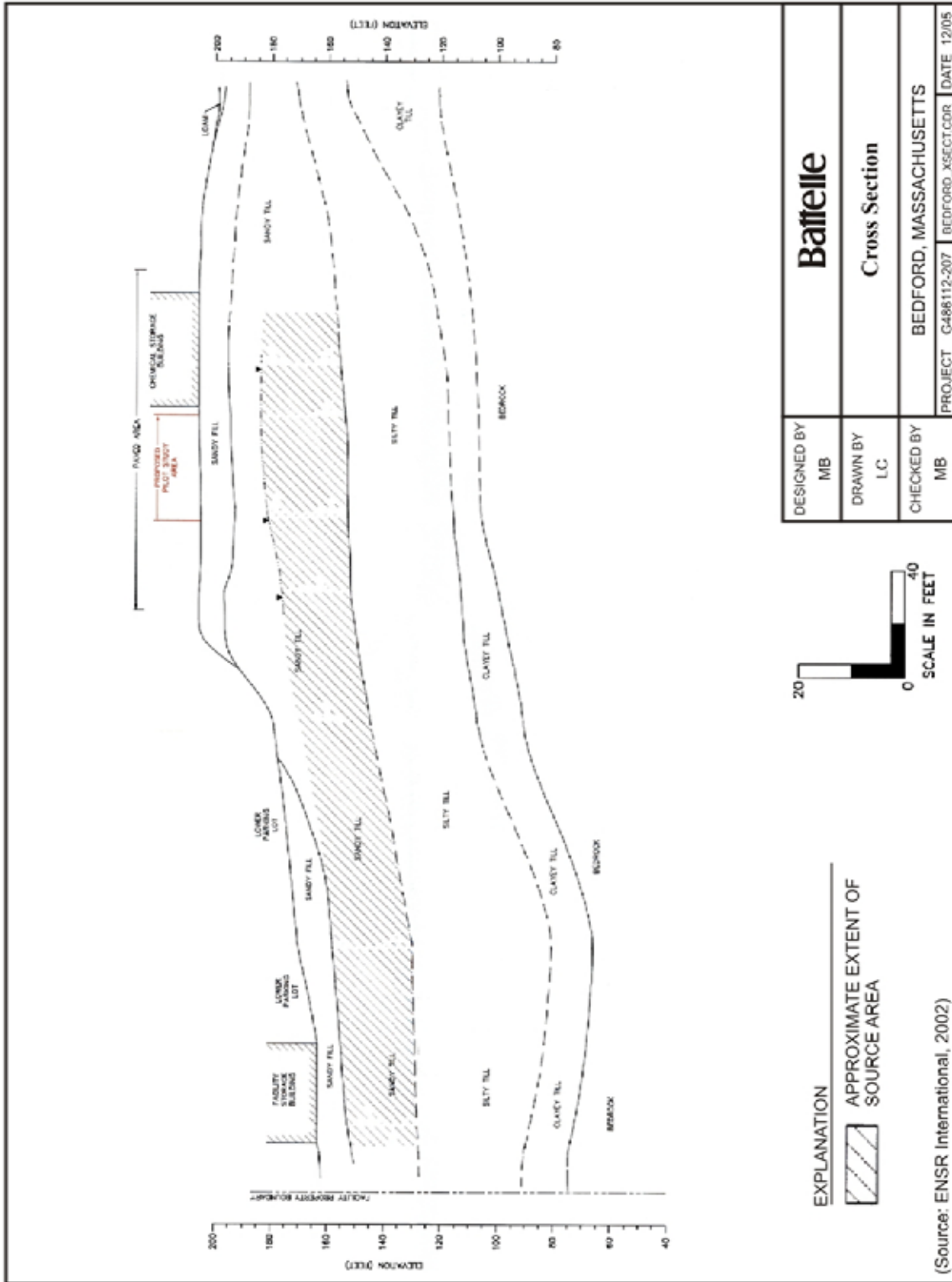

Figure 2-2. Geologic Cross-Section of Bedford Treatment Site Area and Vicinity (Tetra Tech, 2003)

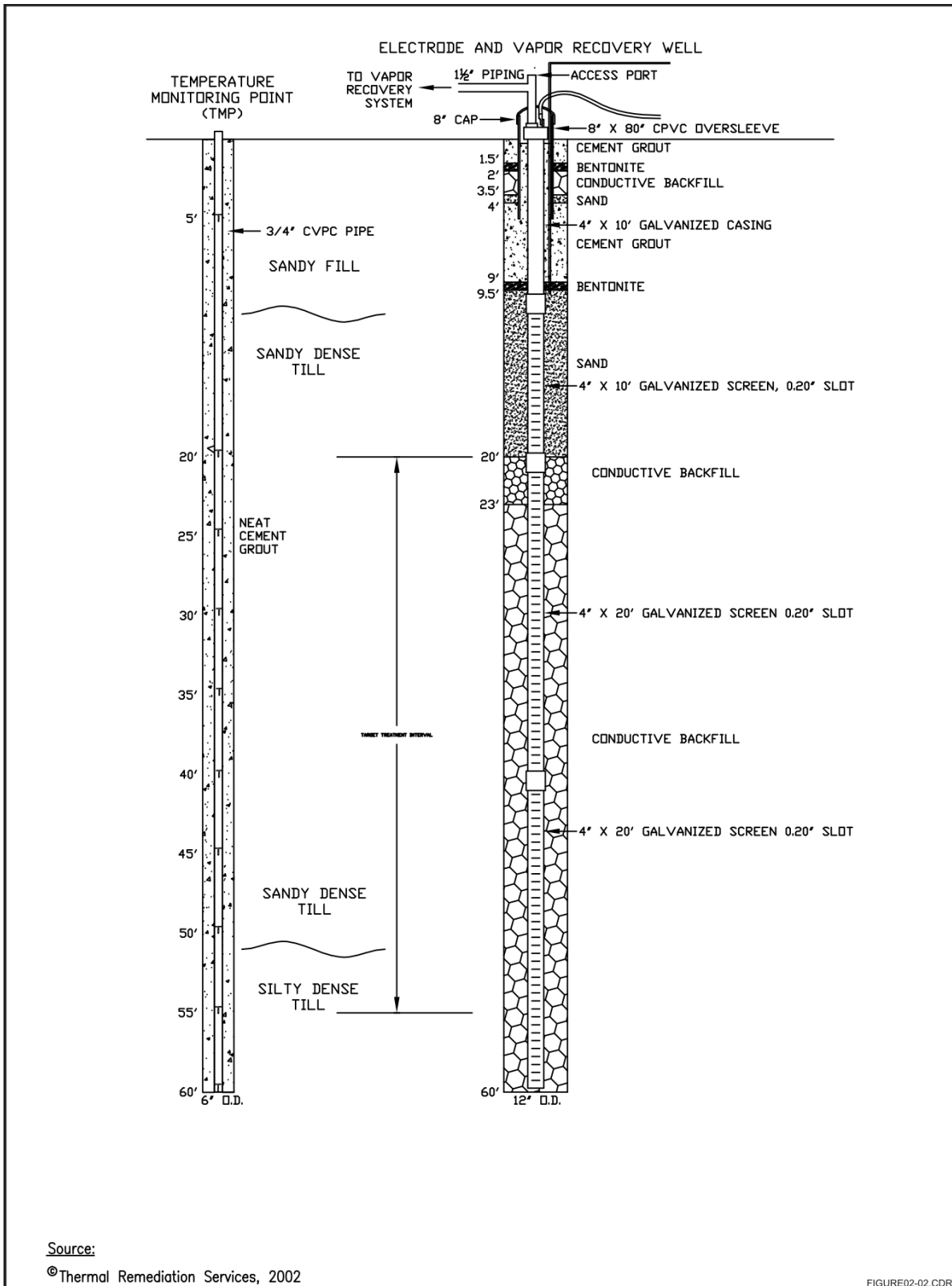
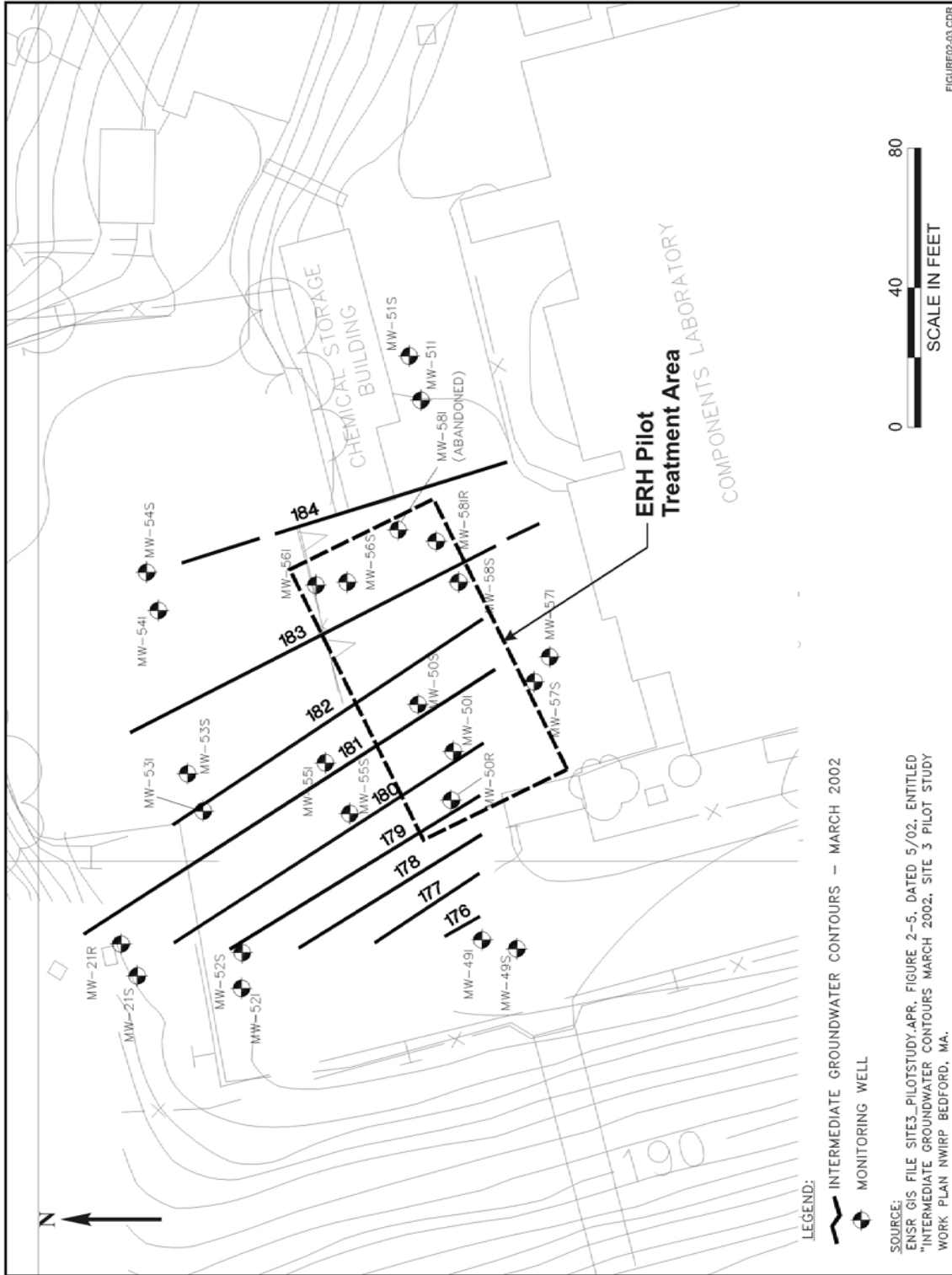

Figure 2-3. Electrode Construction and Geologic Stratification Detail



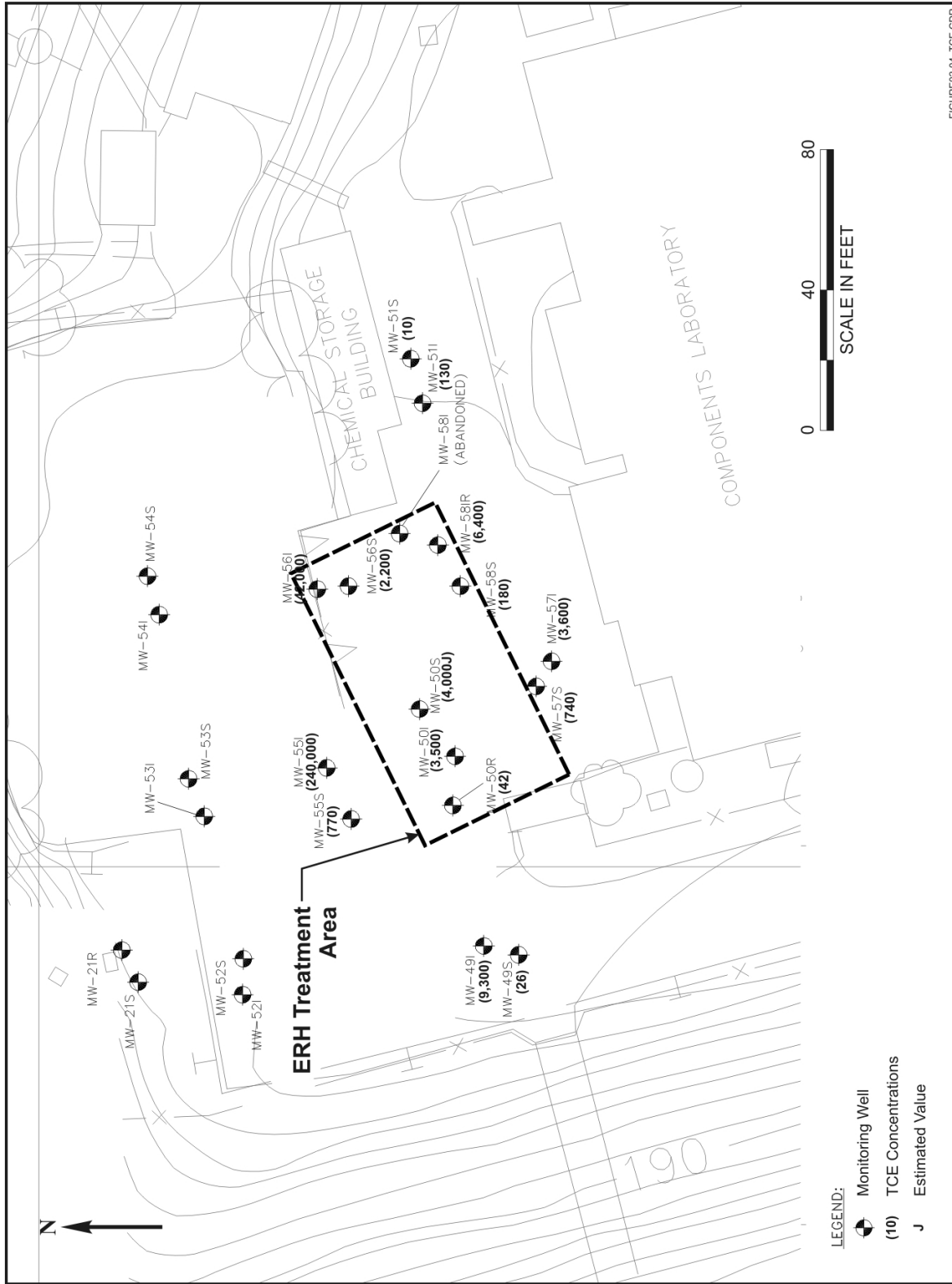

Figure 2-5. TCE (µg/L) Distribution in the Pilot Test Area

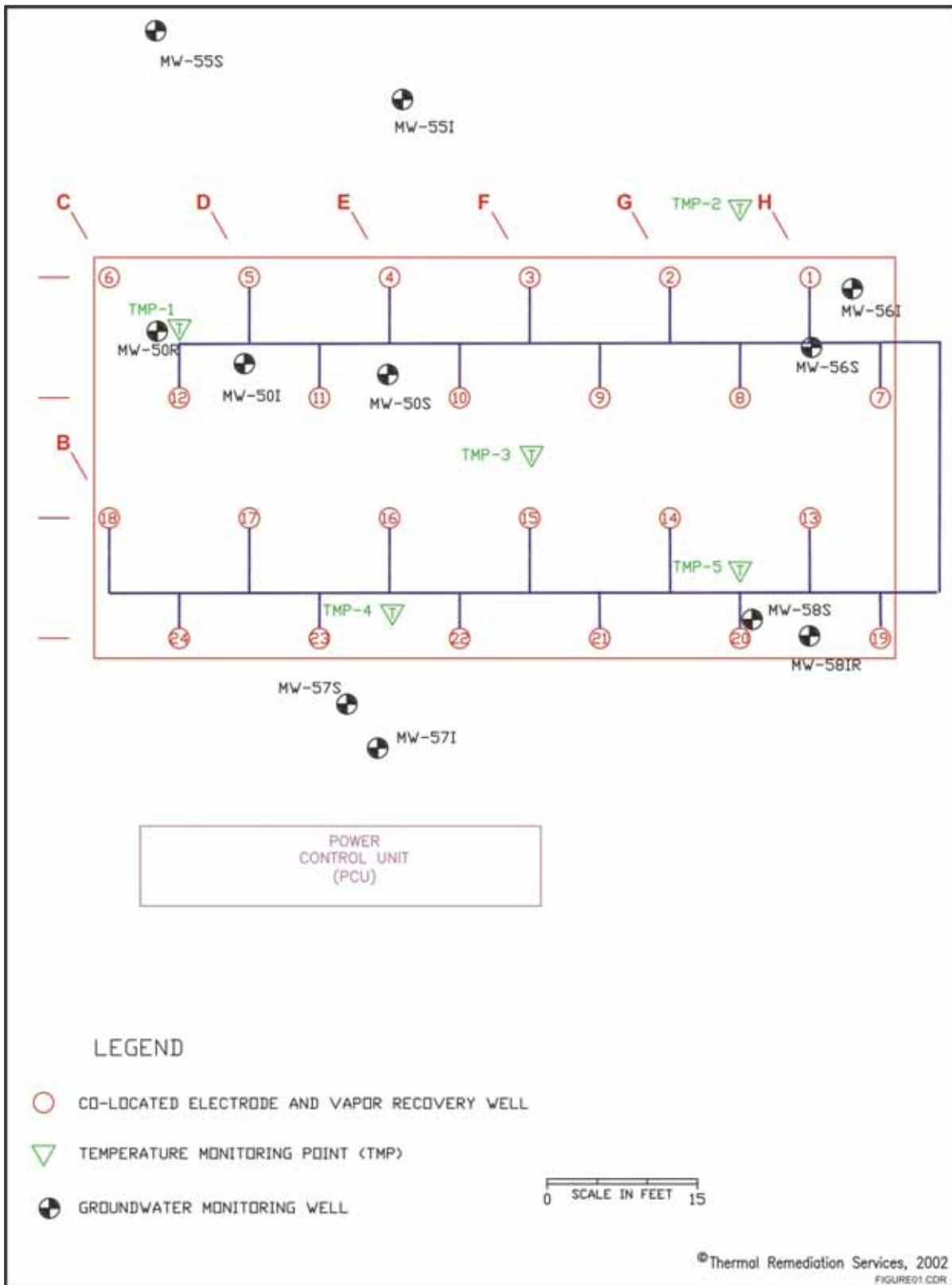

Figure 2-6. ERH Layout at Bedford Site

MW-58IR Contaminants of Concern

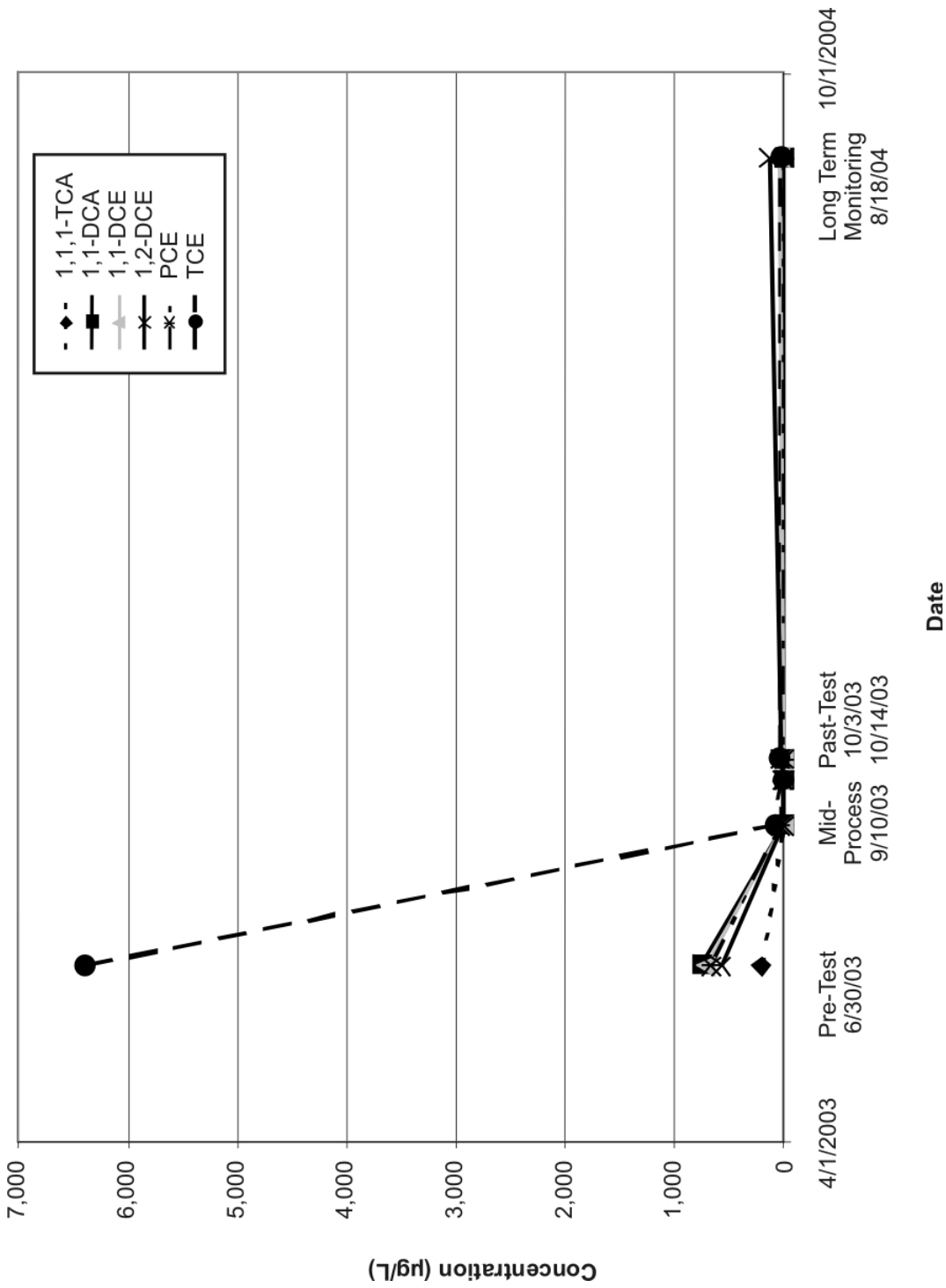

Figure 2-7. CVOC Concentrations in MW-58IR

MW-56I Contaminants of Concern

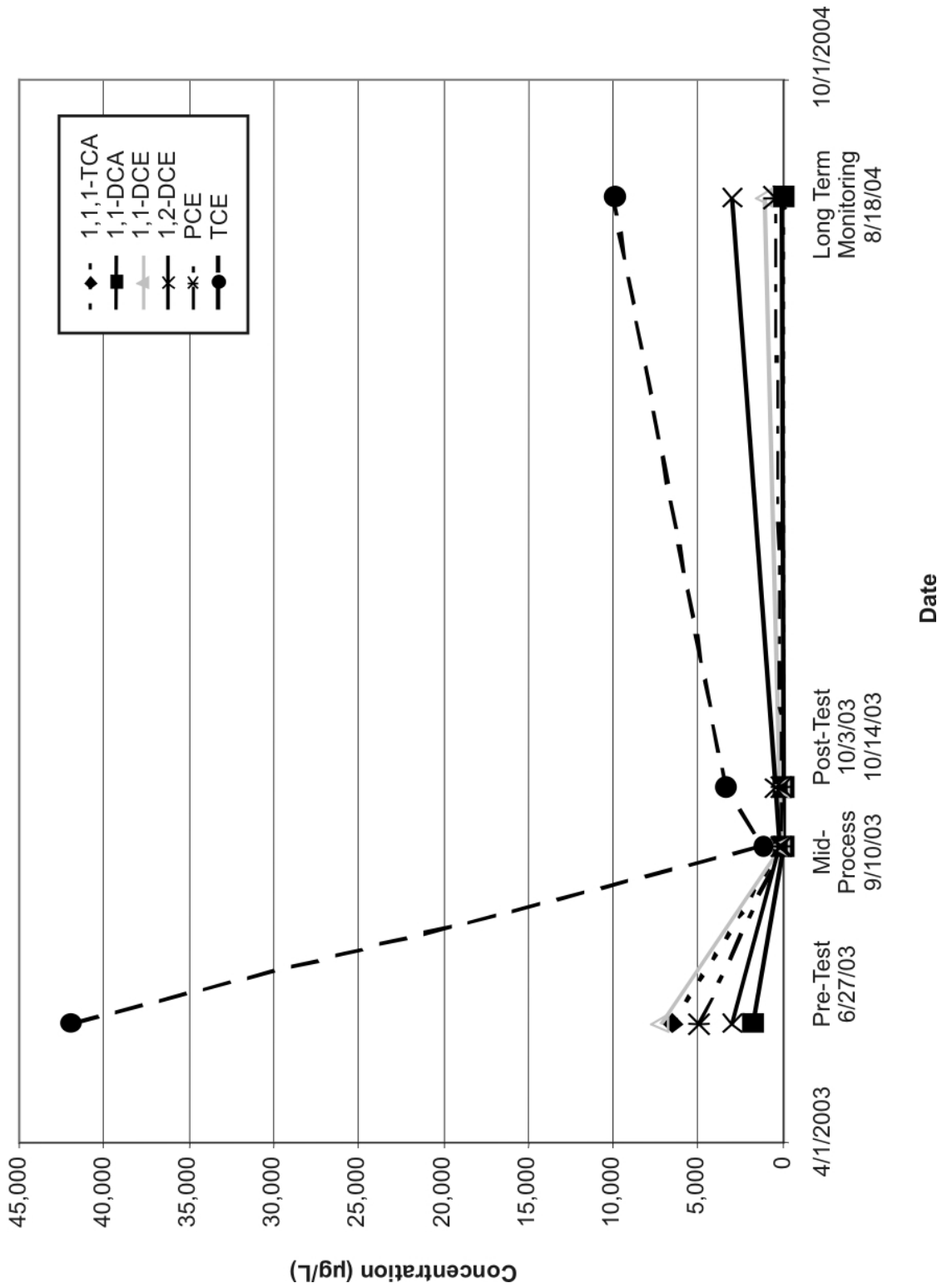

Figure 2-8. CVOC Concentrations in MW-56I

MW-50I Contaminants of Concern

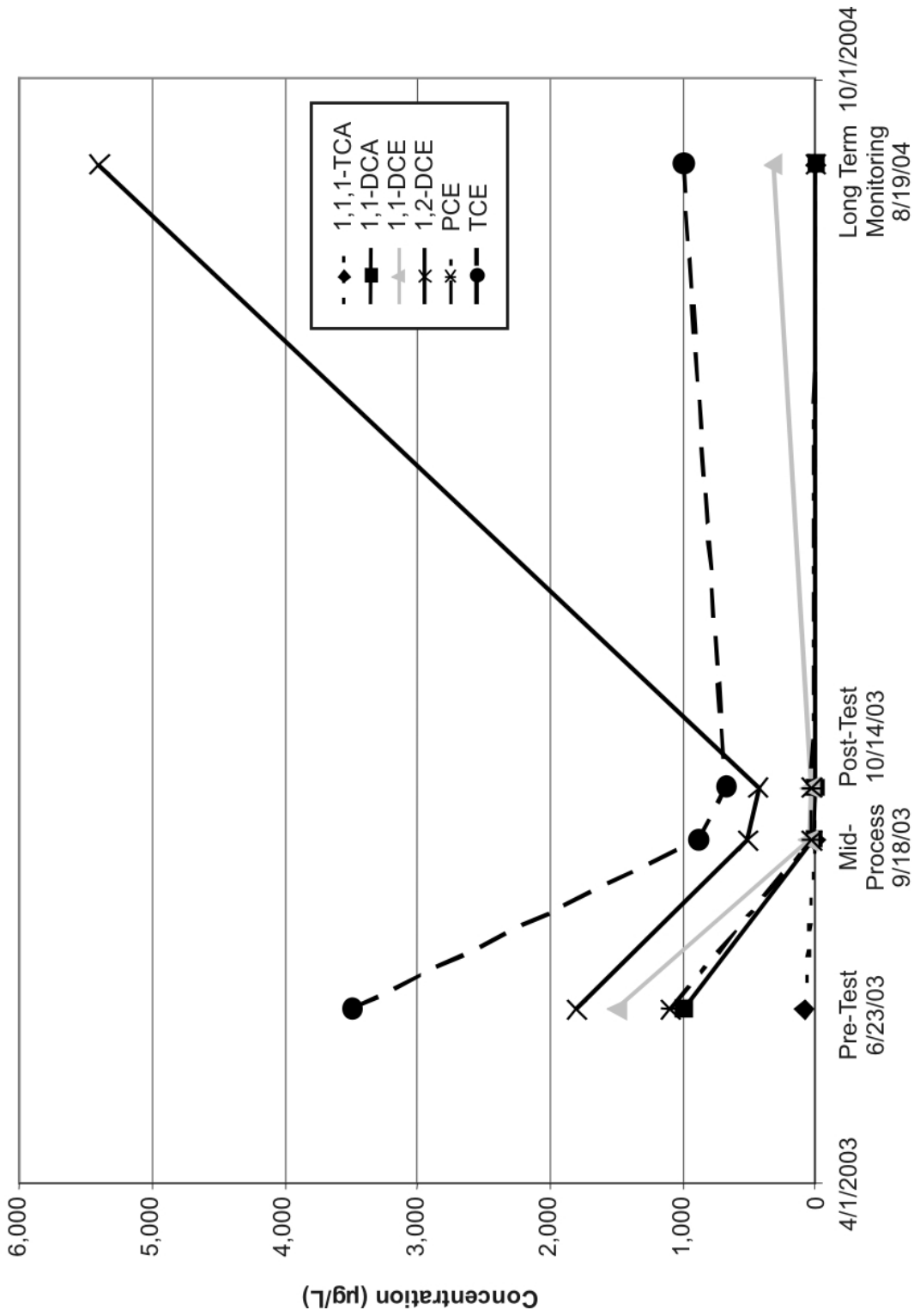
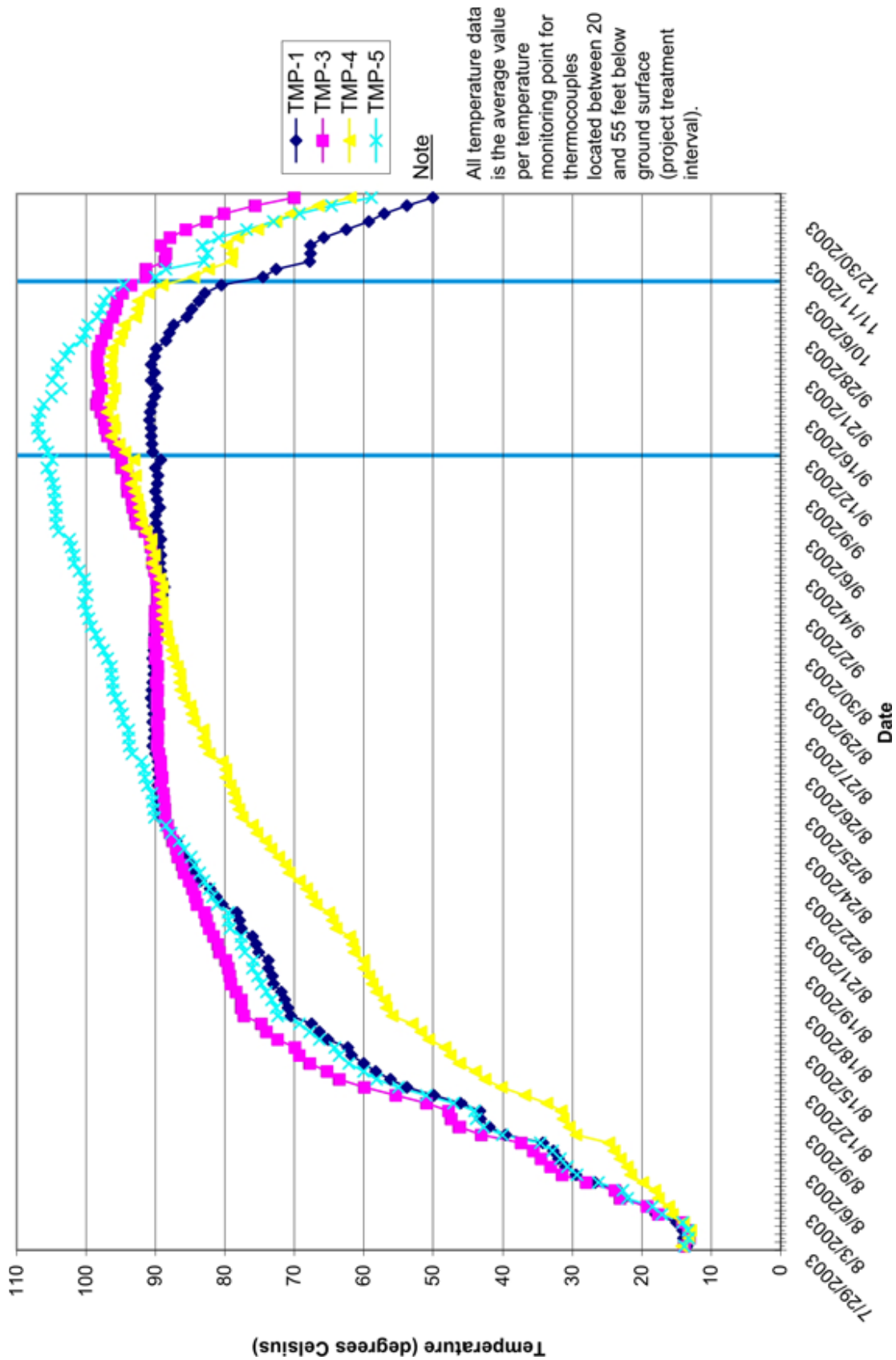

Figure 2-9. CVOC Concentrations in MW-50I



Note
 All temperature data is the average value per temperature monitoring point for thermocouples located between 20 and 55 feet below ground surface (project treatment interval).

Figure 2-10. Temperatures Versus Time in ERH Treatment Area

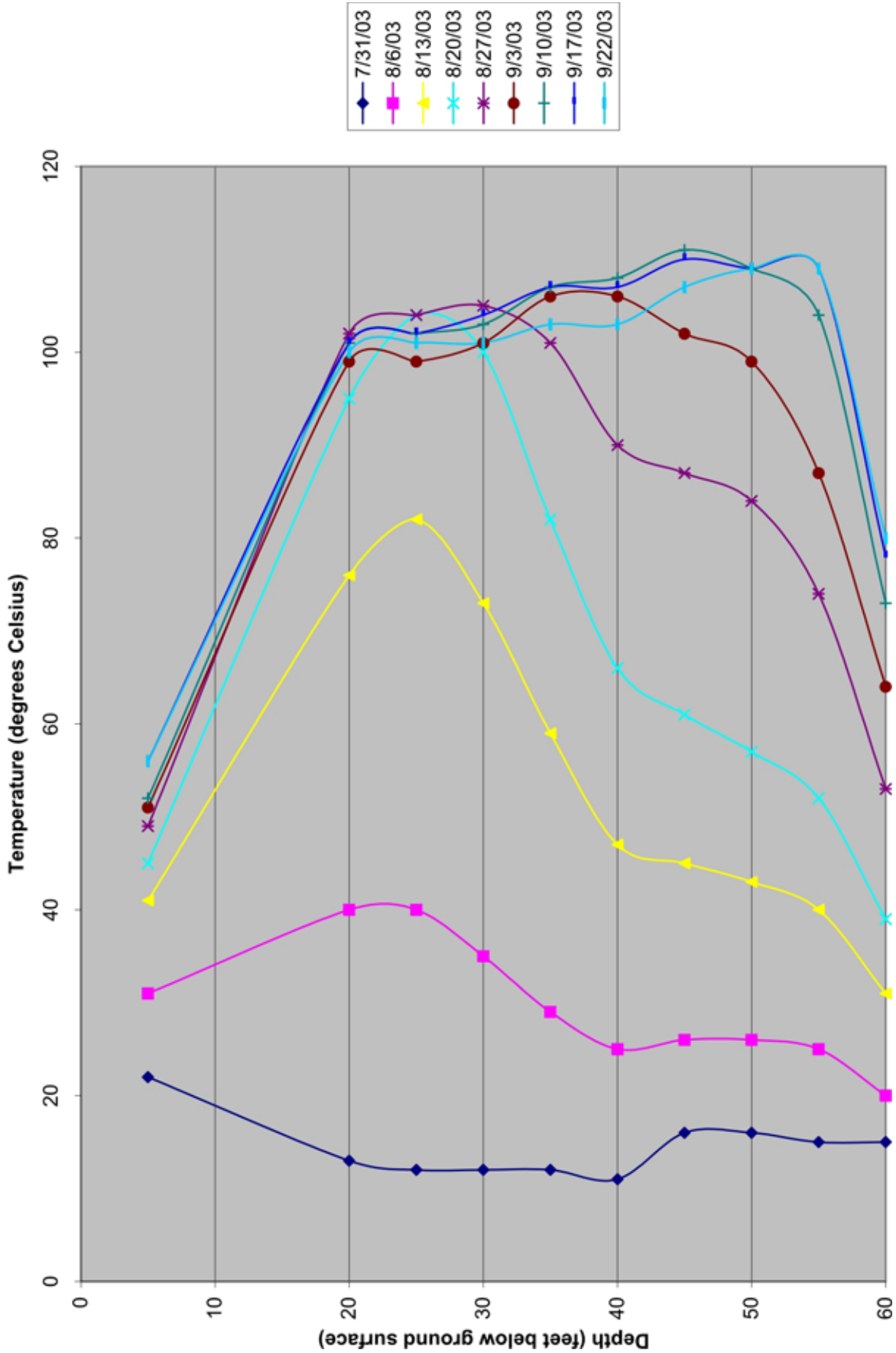

Figure 2-11. Temperature Versus Depth Profiles in TMP-5 (Near MW-58IR)

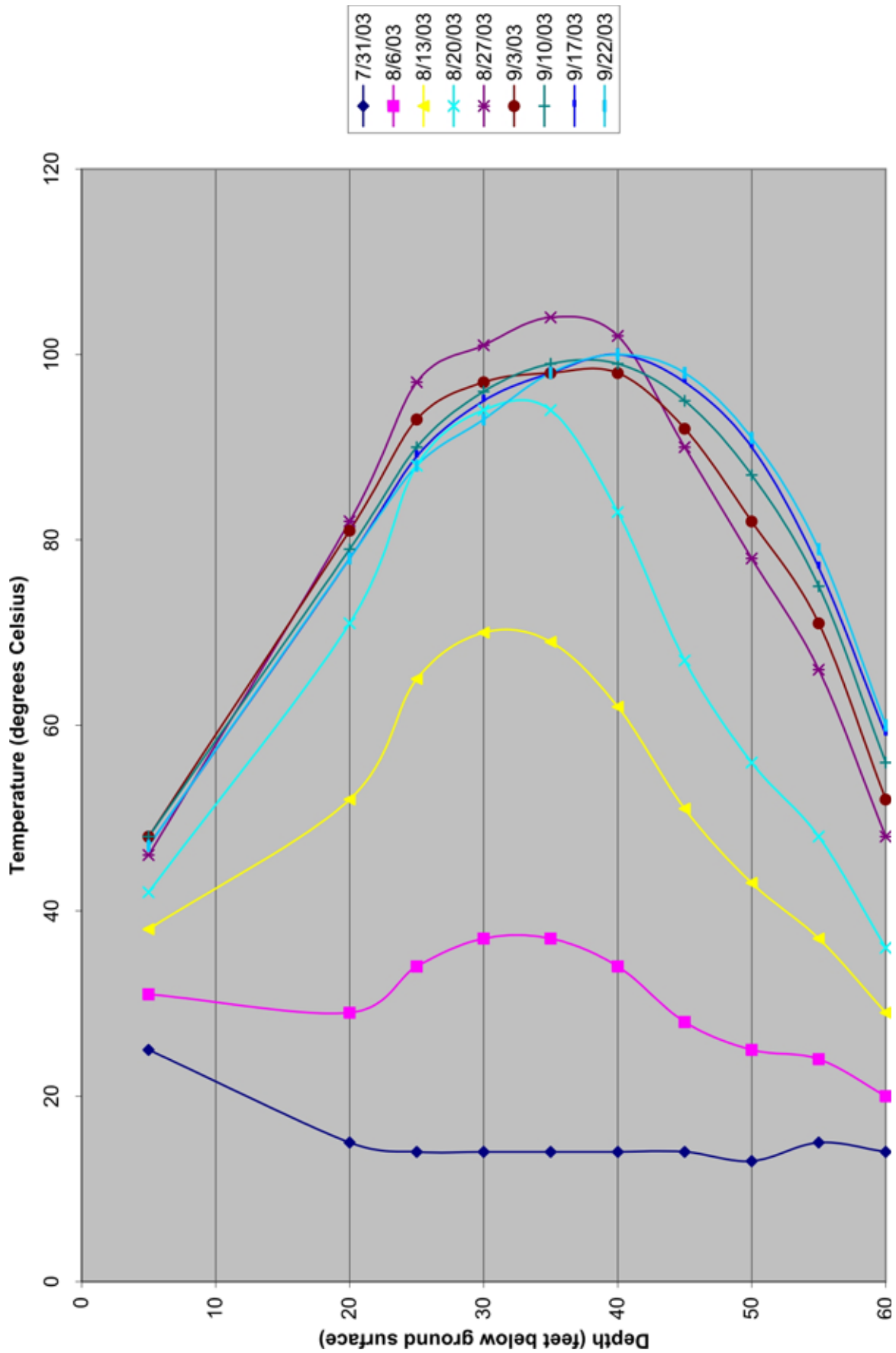

Figure 2-12. Temperature Versus Depth Profiles in TMP-1 (near MW-50I)

Section 3.0: ERH APPLICATION AT CAPE CANAVERAL AIR STATION

3.1 Introduction

Launch Complex 34 at Cape Canaveral Air Station in Florida (Figure 3-1) served as a launch site for Saturn rockets from 1960 to 1968. Historical records indicate that the rocket engines were cleaned on the launch pad with chlorinated solvents and rocket parts were cleaned in the Engineering support building. These practices led to the discharge of chlorinated solvents in drainage pits. Site characterization efforts led to the delineation of a large DNAPL source zone in the near vicinity of the Engineering Support building, which instigated the Interagency DNAPL Consortium (IDC) to consider various source zone remediation technologies. IDC was aware of the problems faced by conventional DNAPL remediation technologies like pump-and-treat, for example presence of residual DNAPL even after the technology has been applied for a long time. To counter such issues and also to use and demonstrate the capabilities of the latest innovative approaches for source zone treatment, IDC decided to divide the source zone area into three different plots and use each plot for a different technology demonstration. ERH, steam injection, and in situ chemical oxidation technologies were chosen as the demonstration technologies at this site. This report focuses on the ERH application at this site.

3.2 Geology and Hydrogeology

A surficial aquifer and a semi-confined aquifer comprise the major aquifers in the Launch Complex 34 area. The surficial aquifer extends from the water table to approximately 45 ft bgs in the Launch Complex 34 area. A clay unit separates the surficial aquifer from the underlying aquifer (Hawthorne aquifer). All three surficial layers (Upper Sand Unit, Middle Fine-Grained Unit, and Lower Sand Unit, Figure 3-2) demonstrate a relatively flat hydraulic gradient. A brief description of the three units is provided as follows:

Upper Sand Unit (15-20 ft thick):

- Gray fine sand and shell fragments as sediments.
- The aquifer here has a direct recharge from the surface and is unconfined.
- Hydraulic conductivity ranged from 4.0 to 5.1 ft/day.
- Porosity was 0.26.

Middle Fine-Grained Unit (5-15 ft thick):

- Gray, fine-grained silty/clayey sand.
- The aquifer here has low-permeability and is in a semiconfining layer.
- Hydraulic conductivity ranged from 1.4 to 6.4 ft/day.
- Porosity was 0.34.

Lower Sand Unit (10-20 ft thick):

- Gray fine to medium-sized sand and shell fragments with a semiconfined aquifer.
- Hydraulic conductivity ranged from 1.3 to 2.3 ft/day.
- Porosity was 0.29.

Lower Clay Unit (1.5-3 ft thick):

- Greenish-gray sandy clay with thin low permeability confining unit.
- Porosity was 0.44.

3.3 Contamination Distribution

Site characterization efforts have demonstrated a presence of 20,600 kg to 40,000 kg of chlorinated solvents comprising CVOC (such as TCE and PCE) which are common DNAPL contaminants. The highest levels of TCE were found in the groundwater in the Lower Sand Units (see Figure 3-3). Much of the DNAPL was found in the Middle Fine-Grained Unit and the Lower Sand Unit.

3.4 Technology Implementation

In June 1999, a detailed pre-demonstration characterization of the ERH test plot near the Engineering Support Building (ESB) was conducted to initiate the performance assessment of the ERH technology. From September 1999 to July 2000, when the ERH field application was conducted, subsurface data were collected to monitor the progress of the demonstration; the vendor collected additional aboveground data to aid in the operation of the technology. Figure 3-4 shows the layout of the ERH equipment and monitoring points in the test plot. In August-December 2000, the post-demonstration assessment of the ERH plot was conducted after all parts of the aquifer had cooled to 90°C or less.

The ERH heat application began on August 18, 1999, and continued until July 12, 2000, with two major breaks in between. The SVE system was operated for two more months until September 19, 2000 so that continuing vapors from the hot aquifer could be recovered. Over the course of the demonstration, a total of 1,725,000 kW-hrs of energy was applied to the subsurface. The applied voltage ranged from 100 to 500 V, which resulted in an electrical current of 10 to 400 amps.

At this site, the vendor used a novel electrode design consisting of an electrical cable attached to a ground rod within a graphite backfill, instead of the traditional pipe electrode. However, this new design, coupled with excessive rainfall and a rising water table, resulted in insufficient heating of the upper part of the aquifer. Therefore, between February 24 and March 2, 2000, the vendor installed ground rods near each electrode to heat the 3- to 10-ft-bgs ground interval. Figures 3-5 and 3-6 show the temperature measurements collected across various depths at thermocouple monitoring points TMP-1, TMP-2, TMP-3, and TMP-4 (Current Environmental Solutions, 2001).

The first major interruption of the ERH operation occurred on September 10, 1999, when a major hurricane (Hurricane Floyd) hit Cape Canaveral, followed by a second hurricane (Hurricane Irene) on October 17, 1999. The power supply was damaged and the water table rose significantly, from about 6 ft bgs before the demonstration to almost 1.5 ft bgs in monitoring well PA-2. In low-lying areas of the test plot, the groundwater was probably near the ground surface. Elevated TCE levels discovered in ponded surface water in a ditch along the west side of the ERH plot indicated that some TCE migrated from the plot during this period. It is probable that infiltration of cooler rainwater from the storms caused the rising TCE vapors to condense near the ground surface. In addition, the rising water table submerged the SVE wells rendering them useless; it is probable that some TCE volatilized to the atmosphere during this time.

In October 1999, the vendor installed six horizontal wells in the northern half of the cell and seven shallow vertical wells in the southern half of the cell near the building. In addition, a surface cover (plenum) was placed over the plot to improve vapor capture. In October 1999, the vendor also installed a drainage diversion system consisting of a sandbag cutoff wall on the east side of the plot and a sump pump to divert the water through a PVC pipe to the drainage collection area in the west. Also, PVC risers on the six monitoring wells inside the plot were removed and replaced with stainless steel risers. Due to these modifications and the repairs resulting from the hurricanes, the ERH system was operated only for six weeks during the first heating cycle. The second heating cycle started on December 12, 1999, and continued for 13 weeks, until March 24, 2000.

On March 24, 2000, operations were interrupted to replace the transformer, a major piece of equipment, because its lease had run out. A replacement transformer was obtained and installed in April, but the third heating cycle could begin only on May 11, 2000, due to an unusually heavy space shuttle launch schedule that necessitated work stoppages. The third heating cycle continued for eight weeks until July 12, 2000, when the IDC determined that VOC extraction rates had declined significantly. The SVE system remained operational until September 19, 2000, by which time subsurface temperatures had fallen below 95°C, indicating that steaming had stopped.

One concern with the ERH technology was the high voltage (up to 500 V) required to be delivered to the subsurface. Despite all the difficulties involving hurricanes and flooding of the plot, the vendor successfully controlled the transport and distribution of the large amounts of electricity involved. At all times, both the ground surface was successfully insulated from the electric current running through the aquifer. The ground surface above the ERH plot was available for other activities during the voltage applications. This successful management of the high voltage application is probably the most important safety achievement of the demonstration.

The voltage application was turned off whenever monitoring wells were sampled inside the test plot and all sampling events were conducted safely. Because the monitoring well screens were completely submerged under the water table, there was a tendency for steam pressure to build up in the monitoring wells. A pressure gauge and pressure release valve was installed on each monitoring well inside the plot and along the perimeter. System operators and sampling personnel wore Level D personal protective equipment at the site. No injuries were encountered during the demonstration.

The ERH system at the Launch Complex 34 used 13 electrodes (see Figure 3-4). Three of the electrodes were installed at an angle of 18° to provide heat to the 15 ft of test plot. The electrodes were completed slightly above the Lower Clay unit. Each electrode consisted of two conductive intervals: one from 23 to 30 ft bgs (to provide heat to the middle fine-grained portion), and the other from 38 to 45 ft bgs (to mitigate the potential of downward migration of DNAPL by providing a hot floor). Twelve soil vapor extraction wells with 2 ft screens to depths of 4 to 6 ft bgs were installed to recover the vapors. The vapor was treated with a 20,000-lb vessel of GAC after it passed through the air water separator, heat exchanger, condensate collection drum and a centrifugal blower. Additional treatment of the off gas to remove vinyl chloride was accomplished by potassium permanganate impregnated onto silica.

3.5 Performance Evaluation Approach

Detailed soil sampling was used as the main tool for determining TCE/DNAPL mass removal. Figure 3-7 shows the locations of the soil cores. The spatial distribution data from the preliminary characterization were used to determine a statistically significant number and location of soil samples required to obtain good coverage of the ERH plot. A systematic unaligned sampling scheme was used to conduct pre- and post-demonstration soil coring at 12 locations in a 4 × 3 grid in the test plot. Continuous soil samples were collected at every 2-ft vertical interval in each core, resulting in nearly 300 soil samples in the ERH plot during each event. A vertical section (approximately 200 g of wet soil) from each 2-ft interval was collected and extracted with methanol in the field; the methanol extract was sent to a certified laboratory for analysis. In this manner, the entire soil column was analyzed from ground surface to aquitard at each coring location. Pre-demonstration evaluation of this extraction method with Launch Complex 34 soil showed between 72 and 86% TCE removal or displacement from the test plot. Steps were taken during the post-demonstration soil sampling to cool the retrieved cores and to minimize volatilization losses from the hot soil.

The TCE concentrations (mg/kg of dry soil) obtained by this method were considered “total TCE.” The portion of the total TCE that exceeded a threshold concentration of 300 mg/kg was considered “DNAPL.”

This threshold was determined as the maximum TCE concentration in the dissolved and adsorbed phases in the Launch Complex 34 soil; any TCE concentration exceeding this threshold would be DNAPL.

Two data evaluation methods were used to estimate TCE/DNAPL mass in soil:

- Contouring is a depiction addressing the spatial variability of a parameter on a selected plot. A linear distribution of the parameter (TCE concentration in soil) between the sampled points is assumed. Better results can be obtained by more evenly distributing the sampling points. A software program (EarthVision™) was used for contouring the test area at Cape Canaveral.
- Kriging is a geostatistical interpolation tool that takes into consideration the spatial correlations among the sampled data in making inferences about the parameter value at the unsampled points.

Monitoring wells were installed inside the test plot (PA-13 and PA-14) and outside the test plot, as shown in Figure 3-7, to evaluate the impact of ERH on the target aquifer and surrounding regions.

3.6 Technology Performance

Figures 3-5 and 3-6 show the temperature profiles over time, superimposed on the TCE extraction rate in the vapor phase. At thermocouple locations TMP-1, TMP-2, and TMP-3, which are inside the test plot, temperatures rose to 100°C or higher across all depths, except for the periods when power was turned off for the reasons discussed above. The maximum extraction rate was reached in early March 2000 after water boiling temperature had been reached and sustained for several days at most spatial locations. Heating was not very efficient at TMP-4, which lies along the eastern boundary of the plot.

The analysis of the soil samples is shown in Table 3-1. Figure 3-8 illustrates the results of the soil sampling for one horizontal slice in the lower sand unit, where most of the DNAPL resides. The results of the TCE/DNAPL mass removal evaluation by soil sampling show the following:

- Linear interpolation of TCE concentrations between sampled points indicated that there was 11,313 kg of total TCE in the ERH plot before the demonstration; approximately 10,490 kg of this TCE mass was DNAPL. Approximately 90% of the total TCE mass and 97% of the DNAPL mass was removed from or degraded within the plot due to the ERH application. This predicted removal exceeds the 90% DNAPL removal target proposed at the beginning of the demonstration.
- A statistical evaluation of the pre- and post-demonstration TCE concentrations confirmed these results. Kriging, a geostatistical tool that takes the spatial variability of the TCE distribution into account, indicated that between 7,498 and 15,677 kg of total TCE was present in the test plot before the demonstration. The wide range indicates the uncertainty in estimating the mass of a heterogeneously distributed contaminant from a limited (although relatively large) number of soil samples. After the ERH treatment, there was between 1,031 to 1,545 kg of TCE mass in the test plot. These are the 80% confidence interval bounds. Kriging indicated that between 80 and 93% of the total TCE was removed from the test plot following the technology application.
- The greatest change in TCE/DNAPL mass was observed in the Lower Sand Unit, followed by the Middle Fine-Grained Unit. The Upper Sand Unit showed the least removal. This shows that heating was most effective in the deeper portions

of the aquifer. Limitations due to the new electrode design used at Launch Complex 34 and the loss of vadose zone encountered during high-rainfall events may have contributed to lower heating/steam stripping efficiency in the shallower regions of the aquifer. The temperature distribution in the test plot determined in May 2000, towards the end of the ERH field application, showed relatively good heating in all three aquifer units – Upper Sand Unit, Middle Fine-Grained Unit, and Lower Sand Unit.

- Most of the DNAPL present in regions that would be considered difficult to access was removed from the test plot by ERH. Considerable DNAPL was removed from the region immediately above the aquitard (Lower Clay Unit) and from under the building.
- The TCE/DNAPL mass removal was relatively high under the building, indicating that these regions could be efficiently accessed by using angled electrodes outside the building. Any remediation of DNAPL further under the building would probably require electrodes that are installed inside the building.

Groundwater monitoring was conducted through shallow, intermediate, and deep monitoring wells, with locations shown in Figure 3-7. The results of the groundwater analysis are summarized in Table 3-2. Application of the ERH technology caused the following changes in the treated aquifer:

- Dissolved TCE levels declined in several monitoring wells in the ERH plot, although none of the wells showed post-demonstration concentrations of less than 5 µg/L, the federal drinking water standard, or 3 µg/L, the State of Florida groundwater target cleanup level. *cis*-1,2-DCE levels remained above 70 µg/L and increased considerably in some wells. Vinyl chloride (1 µg/L State of Florida target) levels could not be accurately determined because higher TCE and *cis*-1,2-DCE levels elevated the detection limits of vinyl chloride. This indicates that, in the *short-term*, removal of DNAPL mass from the targeted aquifer caused groundwater TCE concentrations to decline. Dissolved-phase CVOCs were not as efficiently removed, especially from the upper portions of the aquifer, probably due to the lower heating/stripping efficiency in the shallower regions.
- The TCE degradation product *cis*-1,2-DCE appeared to be accumulating in the groundwater in the test plot. *cis*-1,2-DCE itself is subject to drinking water standards (70 µg/L) and its buildup in the plot could be a concern. Its accumulation in the plot may indicate that the degradation rate of *cis*-1,2-DCE is not as fast as the degradation rate of TCE under the conditions prevalent in the aquifer.
- Groundwater pH and dissolved oxygen levels remained relatively constant, but chloride, sodium, potassium, sulfate, alkalinity (carbonate), and TDS levels rose sharply. TDS levels were above the secondary drinking water standard of 500 mg/L both before and after the demonstration, classifying the aquifer as brackish. Sources of these dissolved solids could include evaporative residue, saltwater intrusion, displacement of exchangeable sodium from aquifer minerals, migration from the in-situ chemical oxidation (ISCO) plot, and/or CVOC degradation.
- Biological oxidation demand and total organic carbon (TOC) levels in the groundwater generally increased. These increases could be due to degradation or

dissolution of some components of humic and fulvic matter in the aquifer under the heat treatment.

- The groundwater levels of iron, chromium, and nickel remained relatively constant.
- Slug tests conducted in the ERH plot before and after the demonstration did not indicate any noticeable changes in the hydraulic conductivity of the aquifer.

The reduction in TCE/DNAPL mass in the plot could have resulted from one or more of the following pathways:

- Aboveground recovery. Vapor sampling conducted by the ERH vendor indicates that 1,947 kg of total TCE was recovered in the vapor extraction system. The initial estimate of total TCE mass in the subsurface was 7,498 to 15,677 kg.
- Degradation by biological or abiotic processes. There are indications that some TCE may have been degraded due to the heating in the ERH plot.
 - The sharp increase in *cis*-1,2-DCE levels in several monitoring wells inside the plot and perimeter indicate the possibility that some TCE may have degraded by reductive dechlorination. Microbial counts in soil and groundwater samples before and after the demonstration indicate that microbial populations survived the heat treatment in most parts of the plot. If TCE degradation to *cis*-1,2-DCE has been hastened, it is unclear as to the time frame over which *cis*-1,2-DCE itself may degrade. Accumulation of *cis*-1,2-DCE shows that the rate of degradation of TCE may be much faster than the rate of *cis*-1,2-DCE degradation.
 - The sharp increase in chloride, which would have been a strong indicator of dechlorination of CVOCs, proved to be inconclusive. Sodium, potassium, sulfate, alkalinity, and TDS increased sharply, concomitant with the increase in chloride – these are all seawater constituents. The possibility of the increase in chloride was caused by saltwater intrusion during the ERH application. Also, potential vaporization of the water may have resulted in the increased chloride concentrations.
 - Abiotic processes that may have degraded TCE include reductive dechlorination by the steel shot in the electrodes, hydrolysis, and/or oxidation. Any of these processes could have been promoted by the heating in the plot.
- Migration to surrounding regions. There are indications that some TCE may have migrated to regions surrounding the ERH plot.
 - Monitoring wells (IW-17S and IW-17I) outside the western perimeter of the plot showed a sustained increase in TCE concentrations during and after the demonstration. TCE was found in transient surface water that appeared along a ditch on the western side of the plot, following the two hurricane events. It is possible that when the water table rose to the ground surface, the vapor extraction piping in the plot was submerged. A limited number of exploratory soil cores collected in the regions surrounding the ERH plot after the demonstration did not show any signs of fresh DNAPL deposits. However, temperature mapping of the

surrounding regions indicates hot water outflow to the west of the test plot (see Figure 3-9). The data also suggest influx of cold water near the bottom of the heated zone.

- DNAPL appeared in two of the wells (PA-2I and PA-2D) on the eastern side of the plot. It is not clear which of the two technologies, ISCO or ERH, caused DNAPL to migrate. ISCO, which was applied in the neighboring test plot (80 ft away), created strong hydraulic gradient that could potentially displace any mobile DNAPL in the aquifer. ERH generates heat-induced convection gradients that could displace mobile DNAPL or mobilize residual DNAPL. On the other hand, the PA-2 well cluster was installed in a region that was showing dissolved TCE levels close to its solubility before the demonstration. It is possible that DNAPL would have eventually appeared in these wells regardless of the neighboring remediation activities.
- Soil core samples from the vadose zone above the ERH-treated aquifer did not show any noticeable increase in TCE concentrations.
- The surficial aquifer under the Launch Complex 34 site is underlain by a relatively thin clay layer, which separates it from the semi-confined aquifer below (see Figure 3-10). After the ERH and ISCO demonstrations, three wells (see Figure 3-11) were installed into the semi-confined aquifer – one in the parking lot to the north (PA-20), one in the ISCO plot (PA-21) and one in the ERH plot (PA-22). All three wells showed elevated levels of dissolved TCE, but the levels were especially high in PA-22. Groundwater in PA-22 also had elevated temperature (44 to 49°C); it is not clear whether the elevation in temperature was caused by conduction or convection. The soil cores collected during the installation of these wells showed the presence of DNAPL in the Lower Clay Unit and confined aquifer below the ISCO plot and below the ERH plot, but not under the parking lot, which is outside the suspected DNAPL source zone. TCE concentrations were particularly high in soil and groundwater samples collected from under the ERH plot. Because these wells were installed only after the demonstration, it is unclear as to when the DNAPL migrated to the confined aquifer. The ERH treatment heated the base of the aquifer and probably the aquitard fairly well and the buoyancy of the water would probably create vertically upward gradients. It is possible that the DNAPL penetrated the aquitard gradually over time, long before the demonstration.
- The power outage and recharge resulting from two events of hurricanes during the operation may have caused losses of TCE.
- Losses during sampling of hot soil cores: It is possible that some CVOC losses occurred during post-demonstration sampling of the hot (90°C or less) soil cores. This would cause an underestimation of the TCE/DNAPL mass remaining in the ERH plot after the demonstration. However, all precautions had been taken to minimize any such losses. By the time the post-demonstration soil sampling was done, the plot had cooled to 90°C or less, indicating that steam generation had subsided. Each time the soil sample barrel was retrieved from the ground, it was

immediately capped at both ends and submerged in an ice bath until the core temperature cooled to ambient.

- Surface emission tests conducted inside and around the plot on several occasions during and immediately following the ERH application showed noticeably elevated levels of TCE compared to background level (see Table 3-3). These tests were conducted by placing a box with its open top facing the ground. The inside of the box was flushed with hydrocarbon-free air and then allowed to sit for several hours with a continuous air flow into which any CVOCs emanating from the ground would equilibrate. Samples of this air were collected in Summa canisters and analyzed for VOCs. The elevated levels of CVOCs in the surface emissions indicated that the vapor capture system was not as efficient as would be desired and some CVOC vapors were migrating to the atmosphere. Interestingly, ambient air measurements conducted at shoulder level (see Table 3-3) did not show any noticeable elevation in CVOC levels, probably due to dispersion of vapors in the ambient air. Quantifying these surface emissions is difficult and was not attempted.

3.7 Cost

The total project cost was \$868,000. The total cost of the ERH application was \$613,000 including ERH treatment and waste disposal, but not including site characterization costs as outlined below. The vendor incurred a total cost of approximately \$569,000 for ERH treatment of the 75-ft × 50-ft × 45-ft test plot at Launch Complex 34. This total includes the design, equipment, mobilization/demobilization and operation costs. In addition, NASA incurred a cost of \$44,000 for off-site waste disposal. Aboveground wastes requiring disposal included the condensate (shipped to the on-site wastewater treatment plant), spent carbon (shipped to the supplier for regeneration), and the permanganate-impregnated silica (shipped to a local landfill).

A comparison of the cost of ERH treatment of the DNAPL source the size of the ERH plot and an equivalent (2 gpm) pump-and-treat system for plume control over the next 30 years was conducted to evaluate the long-term economic impact of the technology. The present value (PV) of building and operating a pump-and-treat system for 30 years was estimated as \$1,406,000. Assuming that ERH application was effective and displacement did not occur, the ERH application cost, thus, is less than the PV of a 30-year pump-and-treat application.

This comparison assumes that natural attenuation would be sufficient to address any residual source. Also, in the absence of source treatment, the plume emanating from this relatively large DNAPL source may be expected to last much more than 30 years. ERH treatment and natural attenuation require none of the aboveground structures, recurring operational costs, and maintenance that pump-and-treat systems require. Anecdotal evidence indicates that, at many sites, pump-and-treat systems are operational only about 50% of the time. The impact of this downtime and the associated maintenance costs should also be considered. In general, the economics favor DNAPL source treatment over a pump-and-treat system at this site.

Site characterization costs were not included in the cost comparison because a good design of either a source treatment (e.g., ERH) or plume control (e.g., pump and treat) remedial action would require approximately the same degree of characterization. The site characterization conducted in February 1999 is typical of the characterization effort that may be required for delineating a 75-ft × 50-ft × 45-ft DNAPL source; the cost of this effort was \$255,000, which included a work plan, 12 continuous soil cores to

45 ft bgs, installation of 36 monitoring wells, field sampling, laboratory analysis of samples, field parameter measurements, hydraulic testing, data analysis, and report.

3.8 Discussion

The ERH application at Launch Complex 34 generated the desired temperatures (100 to 120°C, depending on depth) in most parts of the test plot, even in difficult spots, such as immediately above the aquitard and under the building. The aquifer at this site is mostly sandy, with an intermediate fine sand or silt unit. Hydraulic conductivity in the predominantly sandy aquifer is relatively high, but groundwater gradients are low, leading to a relatively stagnant groundwater zone.

Heating in the shallower regions of the test plot was somewhat hampered by the deficiencies of the new electrode design and by the transient rise in the water table during the hurricanes. However, temperatures reached the boiling point of water in both shallow and deep portions of the aquifer near the aquitard. CVOC recovery rates measured in the captured vapor reached a peak when the aquifer temperatures reached those for water boiling (100-115°C, depending on depth). When heat application was stopped for several weeks to change the transformer, temperatures fell. When ERH was restored, temperatures once again rose to boiling and CVOC recovery rates in the captured vapor spiked up again. This indicates that reaching water boiling temperatures is important to achieve good recovery of DNAPL. Extensive soil sampling before and after the ERH application showed that DNAPL had mostly been removed from various parts of the target aquifer, including from the layers near the aquitard.

Of an estimated 7,498 to 15,677 kg of total TCE present in the test plot (based on soil concentrations), an estimated 1,947 kg were recovered in the captured vapors (based on periodic sampling of the vapors). Post-treatment soil sampling showed that an estimated 1,031 to 1,545 kg of total TCE remained in the target aquifer, indicating that between approximately 6,000 to 14,000 kg of TCE had left the treatment plot. The discrepancy between the mass of TCE leaving the test plot and the mass of TCE recovered in the vapor capture system can potentially be accounted for by a combination of enhanced biodegradation, hydrolysis, abiotic degradation, migration to the surrounding aquifer, and/or losses to the ambient air.

Enhanced biodegradation at elevated temperatures is indicated by the persistence of microbial counts in the treatment zone and by the increase in *cis*-1,2-DCE levels in the groundwater. In addition, biochemical oxygen demand (BOD) levels in the groundwater increased after the heat treatment, indicating that heating was breaking down soil organic matter into more bio-available components, thus enhancing its role as a carbon source for increased microbial growth. A substantial increase in chloride levels in the groundwater occurred after ERH application, but is difficult to attribute solely to biodegradation. Other groundwater components, such as sodium and sulfate, increased substantially, which may indicate that some saltwater intrusion may have occurred.

Hydrolysis rates are expected to increase with increased temperature and this could account for some of the TCE loss. Elevation of TCE levels in the surrounding wells are more difficult to evaluate because the pre-treatment TCE levels in the surrounding aquifer were already close to the solubility of TCE in water. However, vapor losses to the ambient air may have been a substantial pathway, as elevated TCE levels were measured in surface emissions (close to the ground) several times during the ERH application. Simultaneous measurements of the ambient air in the test plot at shoulder levels did not show elevated TCE levels. This indicates that TCE vapors dissipate quickly near the ground. Vapor capture is a challenge that the technology needs to engineer for in every application. The demonstration at Cape Canaveral was one of the first to address DNAPL source zone. In subsequent years, the engineering of vapor capture systems is expected to have improved.

Table 3-1. Distribution of Pre- and Post-Demonstration TCE Concentrations (mg/kg) in the SPH Plot Soil (Page 1 of 3)

Top Depth	Bottom Depth	Pre-Demo SB1	Post-Demo SB201	Pre-Demo SB2	Post-Demo SB202	Pre-Demo SB3	Post-Demo SB203	Pre-Demo SB4	Post-Demo SB204
0	2	8	0.8	NA	ND	9.2	1	ND	1
2	4	5	1.8	NA	ND	0.9	ND	4.6	3
4	6	0.3	2.9	1.7	2.9	0.1 J	1	5.1	ND
6	8	3	1.4	0.7	6.7	0.3 J	3	48.7	5
8	10	11	18	0.4 J	40.2	0.3 J	90	0.2 J	6
10	12	9	13	0.7	29.2	0.3 J	114	4.6	32
12	14	12	ND	ND	9.4	0.3 J	61	NA	NA
14	16	NA	ND	1.1	1.9	0.6	126	8.3	NA
16	18	4	NA	0.7	53	1.3	97	6.5	19
18	20	122	ND	2.5	111	1.0	71	6.0	2
20	22	315	28	2	4,295	8.9	NA	54.1	83
22	24	1,935	60	50	1,248	NA	NA	60	105
24	26	820	3,927	108	102	183	258	9,051	240
26	28	526	401	292	353	109	247	185	195
28	30	941	467	458	5,561	35	1,217	167	403
30	32	19,091	385	295	390	5	287	12,669	197
32	34	349	211	174	465	17	56	112	263
34	36	624	254	176	102	35.5 D	77	100	178
36	38	1,025	265	440	429	1.4 J	308	288	425
38	40	5,874	318	558	474	27	302	848	139
40	42	5,677	186	5	250	115	186	160	388
42	44	368	146	249	335	204	34	167	364
44	46	33,100	364	251	8	220	41	30,223	NA
46	48	37,537	270	41,044	NA	NA	NA	NA	NA

Table 3-1. Distribution of Pre- and Post-Demonstration TCE Concentrations (mg/kg) in the SPH Plot Soil (Page 2 of 3)

Top Depth	Bottom Depth	Pre-Demo SB5	Post-Demo SB205	Pre-Demo SB6	Post-Demo SB206	Post-Demo SB7	Post-Demo SB207	Pre-Demo SB8	Post-Demo SB208
0	2	ND	6	ND	6	0.6	ND	0.3 J	2
2	4	ND	1	ND	ND	0.1	0	0.2 J	1
4	6	ND	12	ND	6	ND	6	ND	5
6	8	ND	5	ND	3	ND	61	1.1	72
8	10	ND	10	ND	55	1.0	ND	0.5 J	ND
10	12	0.3 J	10	ND	69	0.0	ND	0.8	ND
12	14	ND	17	ND	71	ND	ND	1.2 J	24
14	16	ND	122	ND	76	0.2	1	342	6
16	18	ND	197	1.9	164	0.0	1	0.5 J	27
18	20	5.2	89	ND	119	10	ND	1.7	NA
20	22	27.7	61	3.9	224	31	58	217	33
22	24	1,835	NA	18.6	135	NA	85	329	12
24	26	260	177	10.8	213	143	516	330	29
26	28	5,880	177	69.1	235	330	367	184	31
28	30	542	102	54.6	105	140	186	182	34
30	32	902	150	17.0	86	125	196	157	NA
32	34	5,345	140	17.5	63	91	389	294	52
34	36	23,362	64	11.4	35	139	403	113	63
36	38	8,062	146	20.5	99	260	159	141	2
38	40	28,168	236	11.2	89	113	82	NA	11
40	42	6,534	97	18.8	149	217	511	209	4
42	44	37,104	129	5.8	126	8,802	273	6,711	52
44	46	NA	NA	313.1	NA	NA	NA	NA	160

Table 3-1. Distribution of Pre- and Post-Demonstration TCE Concentrations (mg/kg) in the SPH Plot Soil (Page 3 of 3)

Top Depth	Bottom Depth	Pre-Demo SB9	Post-Demo SB209	Pre-Demo SB10	Post-Demo SB210	Post-Demo SB210B	Pre-Demo SB11	Post-Demo SB211	Pre-Demo SB12	Post-Demo SB212
0	2	ND	ND	ND	ND	3	4.1	6	ND	ND
2	4	0.9	ND	ND	ND	2	2.8	2	ND	3
4	6	ND	4	ND	3	23	2.1	3	ND	10
6	8	ND	5	3.9	26	20	2.7	49	NA	12
8	10	6.5	1	2.8	NA	NA	0.7	1	ND	16
10	12	0.5	1	ND	NA	NA	1.1	NA	2.4	ND
12	14	ND	5	1.9	ND	ND	ND	ND	0.4 J	1
14	16	0.8	4	ND	6	ND	1.2	NA	ND	1
16	18	0.4	13	ND	NA	1	1.6	2	NA	ND
18	20	5	3	0.7	10	6	ND	3	ND	5
20	22	14	28	30.9	90	16	9.2	14	15.3	4
22	24	29	34	92.4	46	49	NA	8	40.1	6
24	26	26	64	106	265	569	94	4	112.1	20
26	28	84	36	98	117	310	167	13	256.9	10
28	30	30	28	40.3	170	77	49	319	29.6	7
30	32	2.5	11	4.8	287	27	43.7	102	2.2	3
32	34	ND	NA	ND	209	344	21.4	79	0.4	23
34	36	1.4	5	ND	428	315	2.0	71	0.2 J	1
36	38	ND	74	ND	264	124	0.0	14	0.7	3
38	40	3.4	54	13.9	242	219	0.4	9	0.5 J	ND
40	42	51	77	12.6	257	236	36.0	2	16.1	1
42	44	67	52	25.4	101	297	46.0	ND	36.5	2
44	46	NA	NA	11.8	59	NA	NA	NA	1.5	8

NA: Not available

ND: Not detected

Solid horizontal lines demarcate Middle Fine Grained Unit (MFGU).

Table 3-2. Changes in Groundwater Parameters

Groundwater Parameter (Applicable Groundwater Standard, If Any) (mg/L)	Aquifer Depth	Pre-Demonstration (mg/L)^(a)	Post-Demonstration^(b) (mg/L)^(a)
TCE (0.003)	Shallow	935 to 1,100	647 to 820
	Intermediate	960 to 1,070	60 to 174
	Deep	730 tot 892	3 to 920
<i>cis</i> -1,2-DCE (0.070)	Shallow	4 to 6	14 to 95
	Intermediate	5 to 26	9 to 80
	Deep	2 to 23	3 to 52
Vinyl chloride (0.001)	Shallow	<5	0.022 to <50
	Intermediate	<5	<0.010 to 1.7
	Deep	<5 to <83	0.032 to <50
pH	Shallow	6.9 to 7.1	6.3 to 7.6
	Intermediate	7.4 to 7.5	7.1 to 7.4
	Deep	7.2 to 7.5	6.5 to 6.8
ORP	Shallow	-130 to -108	-107 to -44
	Intermediate	-118 to -74	-89 to -68
	Deep	-142 to -106	-250 to -97
DO	Shallow	0.28 to 0.31	0.60 to 0.63
	Intermediate	0.27 to 0.40	0.99 to 1.11
	Deep	0.10 to 0.62	0.71 to 0.81
Calcium	Shallow	97 to 143	7 to 233
	Intermediate	60 to 70	14 to 153
	Deep	93 to 113	819 to 1,060
Magnesium	Shallow	23 to 37	<1 to 54
	Intermediate	54 to 74	1.2 to 77
	Deep	90 to 113	30 to 51
Alkalinity	Shallow	337 to 479	588 to 898
	Intermediate	351 to 465	243 to 434
	Deep	343 to 410	231 to 421
Chloride (250)	Shallow	37 to 38	141 to 383
	Intermediate	66 to 123	156 to 233
	Deep	11 to 774	3,520 to 4,800
Manganese (0.050)	Shallow	0.022 to 0.963	<0.015 to 0.079
	Intermediate	0.023 to 1.1	<0.015 to 0.11
	Deep	<0.015 to 0.02	0.021 to 0.16
Iron (0.3)	Shallow	0.78 to 3	<0.25 to 0.52
	Intermediate	0.33 to 11	<0.05 to 0.45
	Deep	<0.05 to 0.31	<0.25
Sodium	Shallow	17 to 24	113 to 467
	Intermediate	33 to 120	97 to 258
	Deep	325 to 369	1,530 to 3,130
TDS (500)	Shallow	548 to 587	1,330 to 1,750
	Intermediate	712 to 724	870 to 925
	Deep	1,030 to 1,980	7,220 to 10,600
BOD	Shallow	<3 to 20	32 to 42
	Intermediate	<3 to 9	3 to 4
	Deep	6 to 13	288 to 360
TOC	Shallow	6 to 6	35 to 45
	Intermediate	7 to 23	9 to 15
	Deep	9 to 40	270 to 300

(a) All reported quantities are in mg/L, except for pH (unitless), conductivity (mS/cm), and oxidation reduction potential (ORP) (mV).

(b) Post-demonstration monitoring was conducted twice (December 2000 and June 2001) because some of the PA wells (PA-13 and PA-14) were plugged during the demonstration while their casings were being repaired. The cleaning process was performed after the initial post-demonstration monitoring in December 2000. Therefore, the results from the monitoring in June 2001 were incorporated in this table and the interpretation.

Table 3-3. Surface Emissions Sampling Results

Sample ID	Sample Date	TCE ppb (v/v)	Sample ID	Sample Date	TCE ppb (v/v)
PRE-DEMONSTRATION					
CP-SE-1	11/17/1999	< 0.39	CP-SE-3	11/17/1999	< 0.41
CP-SE-2	11/17/1999	< 0.39			
DURING DEMONSTRATION					
SPH-SE-1	10/08/1999	2.1	SPH-SE-8	01/18/2000	78
SPH-SE-2	10/08/1999	3.6	SPH-SE-9	01/18/2000	35
SPH-SE-3	10/08/1999	2.0	SPH-SE-10	04/11/2000	0.93
SPH-SE-4	10/22/1999	13,000	SPH-SE-11	04/11/2000	0.67
SPH-SE-5	10/22/1999	12,000	SPH-SE-12	04/11/2000	<0.37
SPH-SE-6	10/22/1999	13,000	SPH-SE-13	04/11/2000	1,300
SPH-SE-7	01/18/2000	23			
POST-DEMONSTRATION					
SPH-SE-21	08/30/2000	<0.42	SPH-SE-27	11/30/2000	3,100
SPH-SE-22	08/30/2000	0.61	SPH-SE-28	11/30/2000	10,000
SPH-SE-23	08/30/2000	<870	SPH-SE-29	12/01/2000	11,000
SPH-SE-24	08/31/2000	500	SPH-SE-30	12/02/2000	9.0
SPH-SE-25	09/01/2000	59	SPH-SE-31	12/02/2000	0.71
SPH-SE-26	09/01/2000	17	SPH-SE-32	12/04/2000	<0.40
BACKGROUND			AMBIENT AIR AT SHOULDER LEVEL		
DW-SE-1	10/01/1999	< 0.42	SPH-SE-14	05/09/2000	<0.39 ^(a)
DW-SE-2	10/08/1999	< 0.44	SPH-SE-15	05/09/2000	<0.39 ^(a)
DW-SE-3	10/25/1999	0.44	SPH-SE-C27	09/01/2000	<0.88
DW-SE-4	10/22/1999	6,000^(b)	DW-C1	04/11/2000	2.1^(c)
DW-SE-5	01/17/2000	< 0.38	DW-C2	05/09/2000	<0.39
DW-SE-6	04/11/2000	0.43	DW-C3	05/09/2000	<0.39
DW-SE-7	04/11/2000	0.86	DW-11	08/31/2000	13
DW-SE-8	04/11/2000	0.79	DW-12	09/01/2000	<27
DW-SE-36	12/06/2000	<0.40	DW-C21	08/31/2000	0.86 ^(c)
DW-SE-37	12/06/2000	0.49	DW-C22	09/01/2000	<0.58 ^(c)
DW-SE-38	12/07/2000	<0.40			

ppb (v/v): parts per billion by volume

- (a) SPH-SE-14/15 samples were collected at an ambient elevation east and west edge of the resistive heating plot without using an air collection box.
- (b) Background sample (10/22/1999) was collected immediately after SPH-SE-6 sample (the last sample for the sampling set in October 1999), which had an unexpectedly high concentration of 13,000 ppbv. This may indicate condensation of TCE in the emissions collection box at levels that could not be removed by the standard decontamination procedure of purging the box with air for two hours. In subsequent events (1/17/2000 background), special additional decontamination steps of cleaning the box with methanol and air dry were adapted to minimize carryover.
- (c) A Summa canister was held at shoulder level to collect an ambient air sample to evaluate local background air.

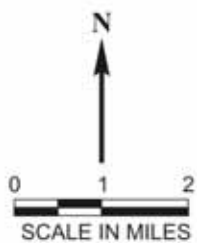
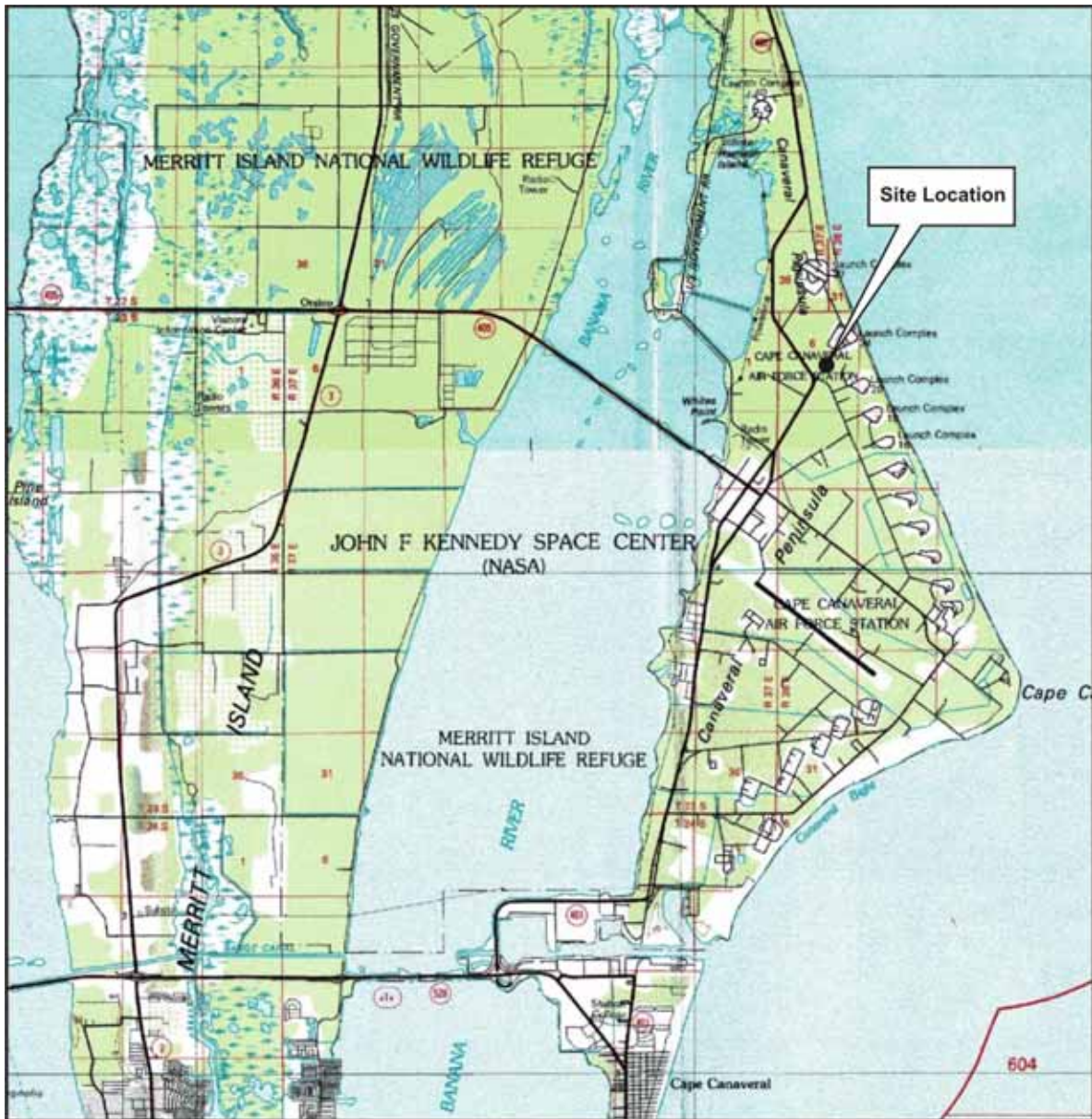

(Source: USGS, 1977)

DESIGNED BY MB	Battelle		
DRAWN BY LC	Site Location Map		
CHECKED BY MB	CAPE CANAVERAL, FLORIDA		
	PROJECT	G486112-207	CC LOCMAP.CDR DATE 12/05

Figure 3-1. Cape Canaveral Site Location Map

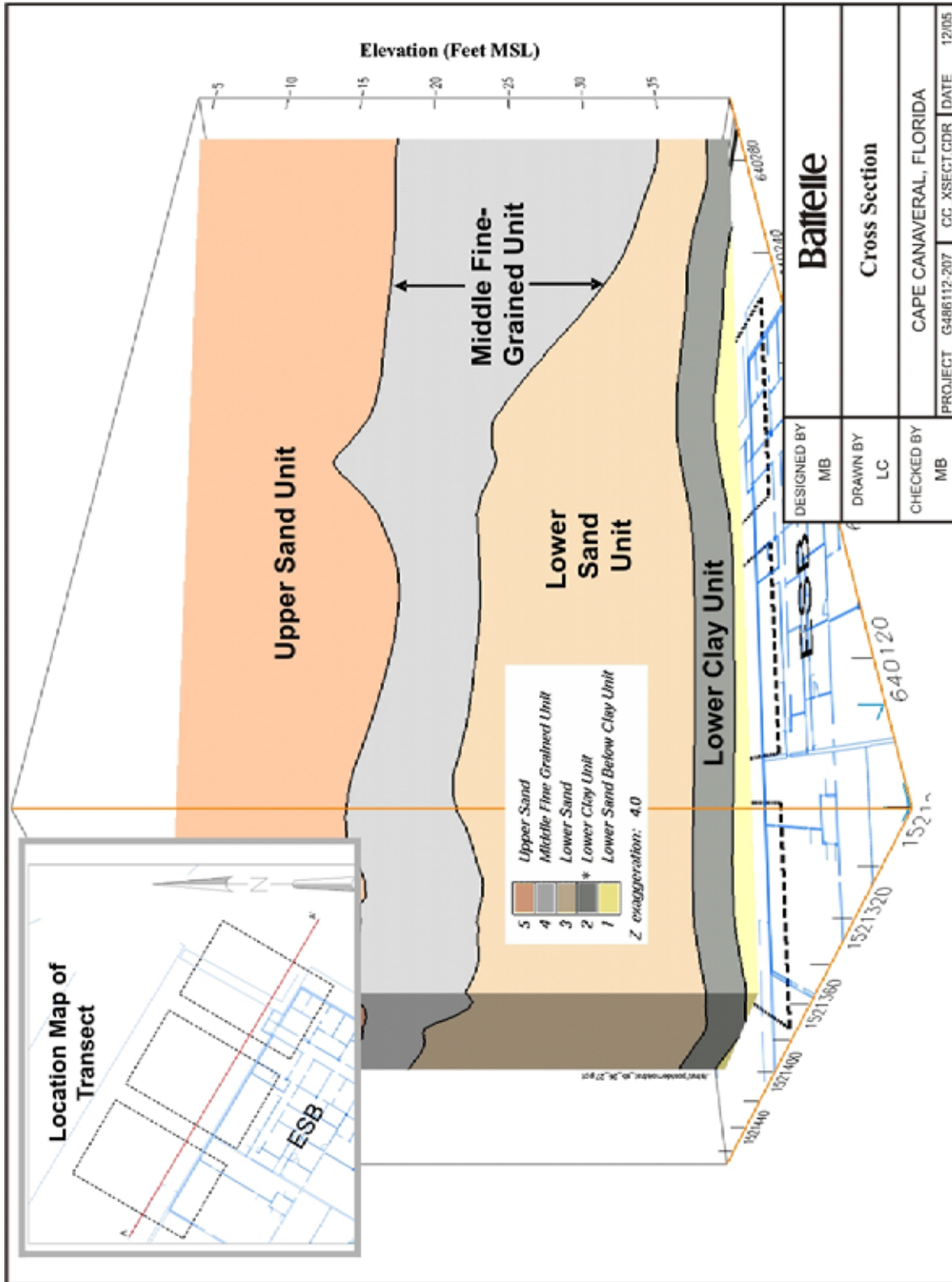

Figure 3-2. Geological Cross-Section of Cape Canaveral Treatment Area

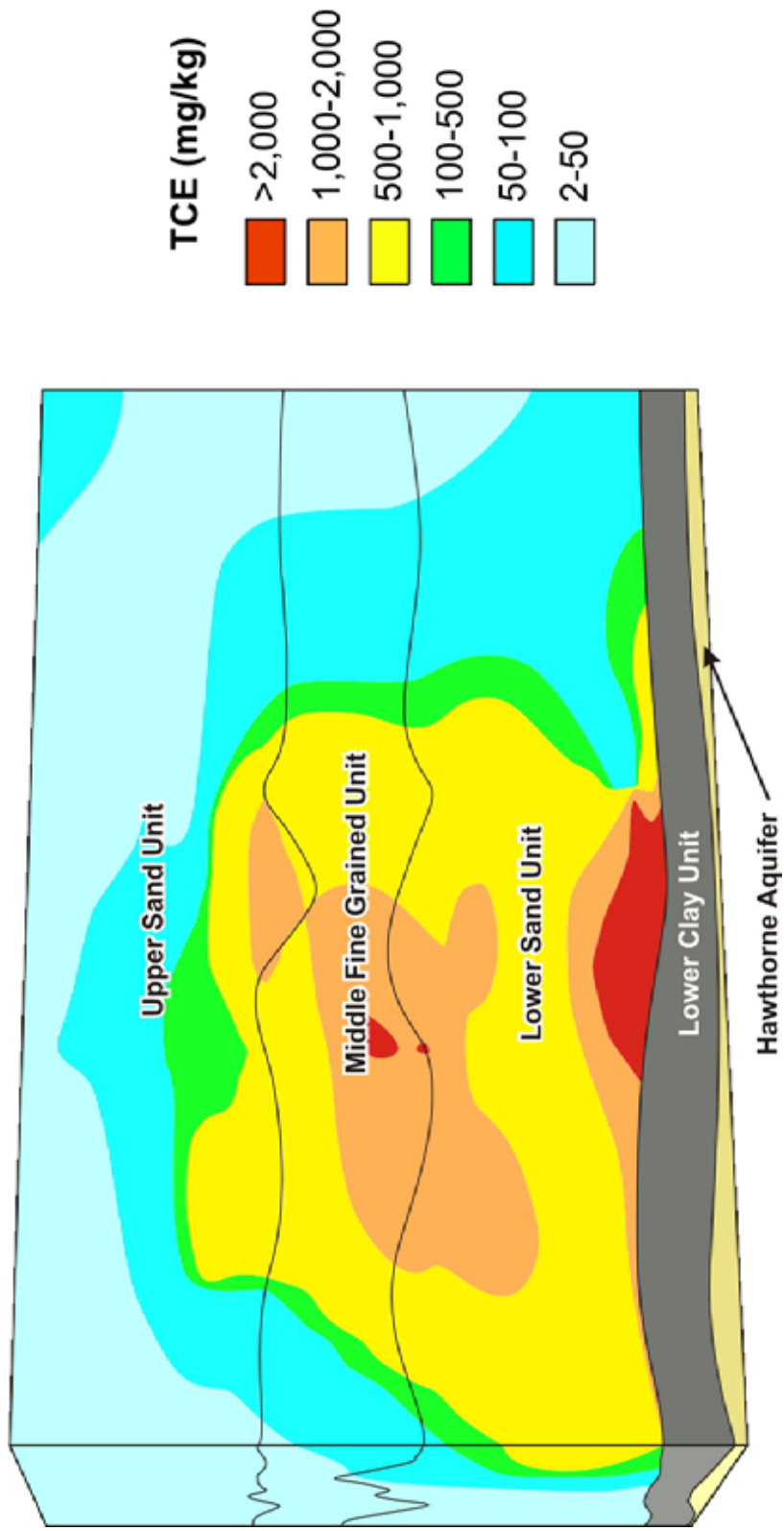

Figure 3-3. Contaminant Distribution Profile at Cape Canaveral Site

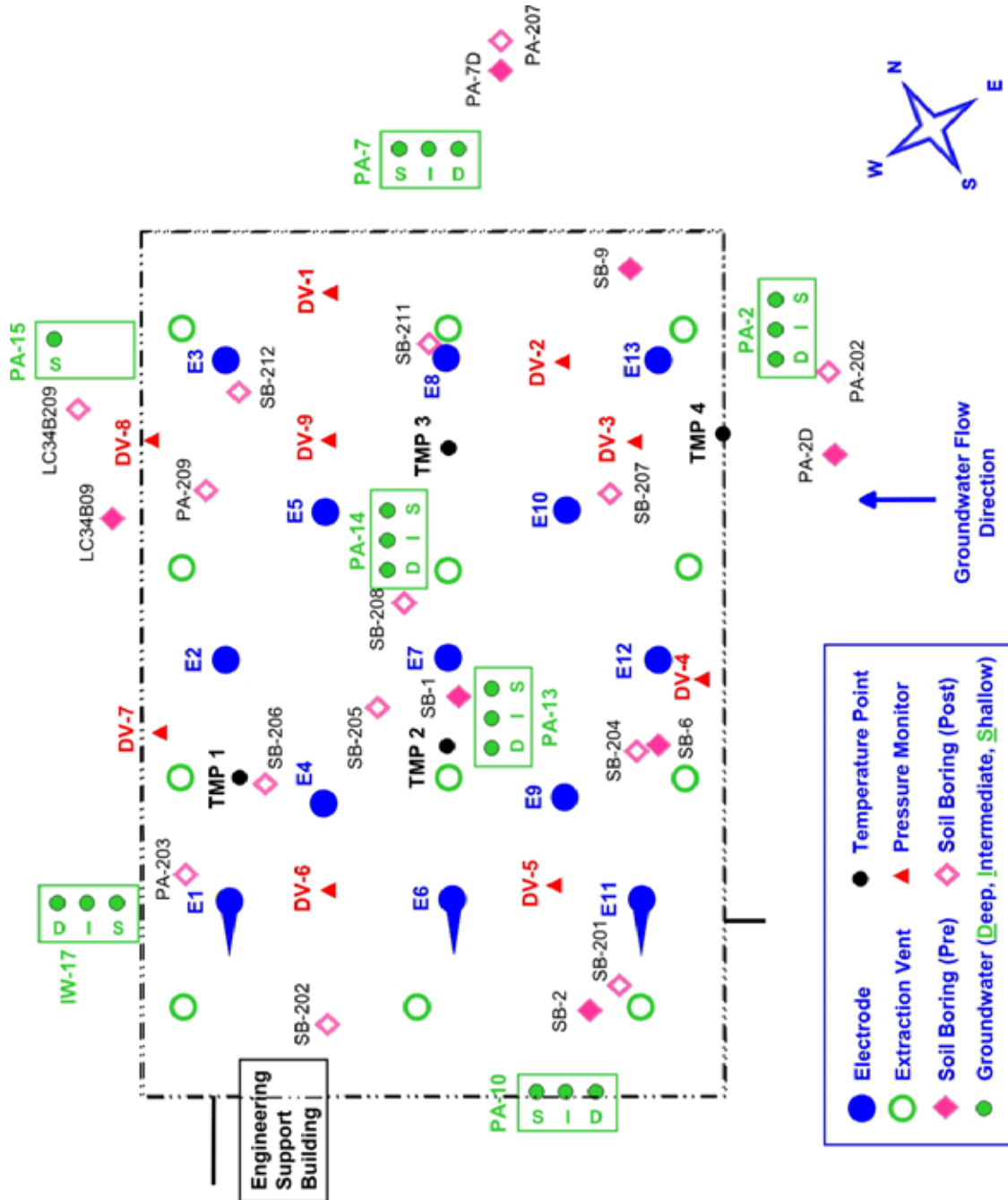
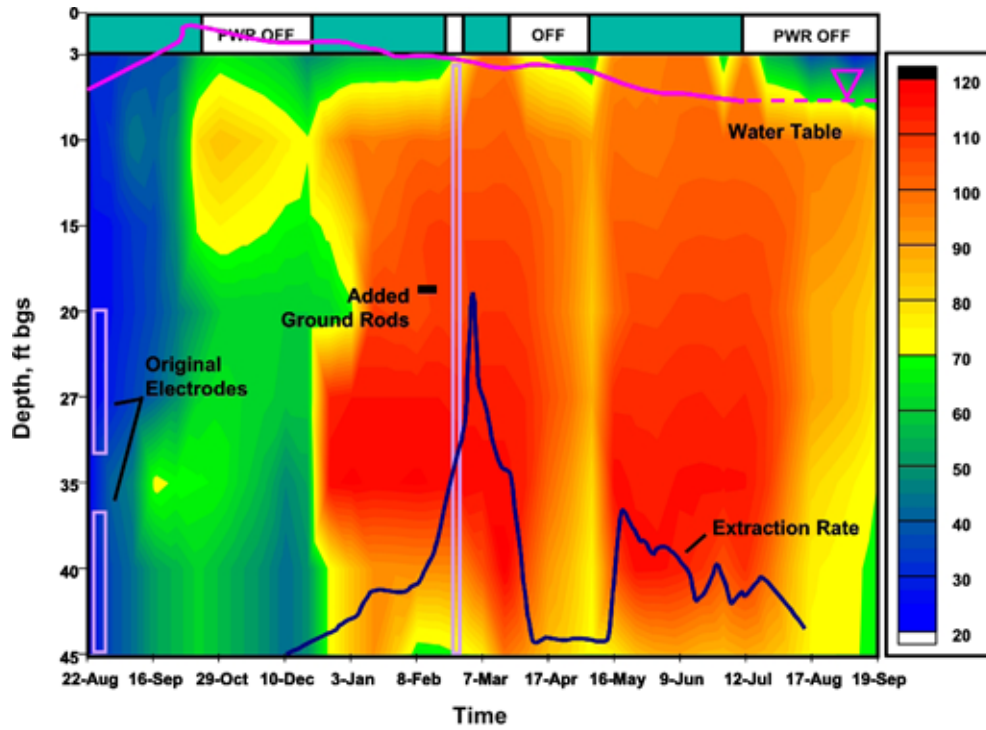
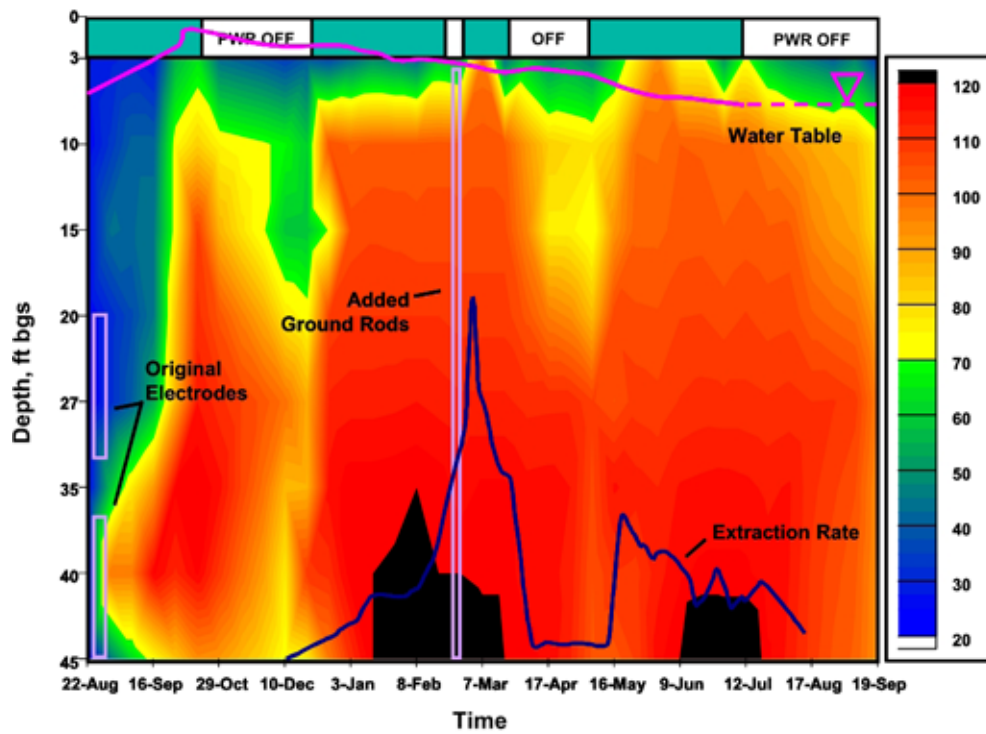

Figure 3-4. System Layout



Plot of Subsurface Temperature Profiles at TMP 1



Plot of Subsurface Temperature Profiles at TMP 2

Figure 3-5. Temperature Profile at TMP-1 and TMP-2

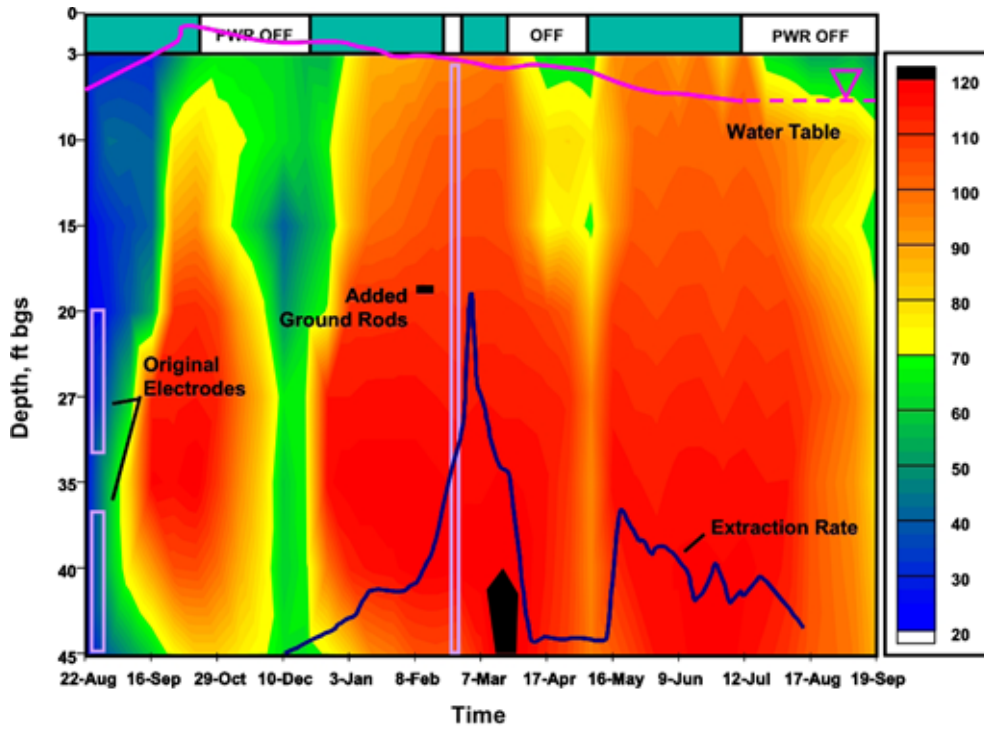

Plot of Subsurface Temperature Profiles at TMP 3

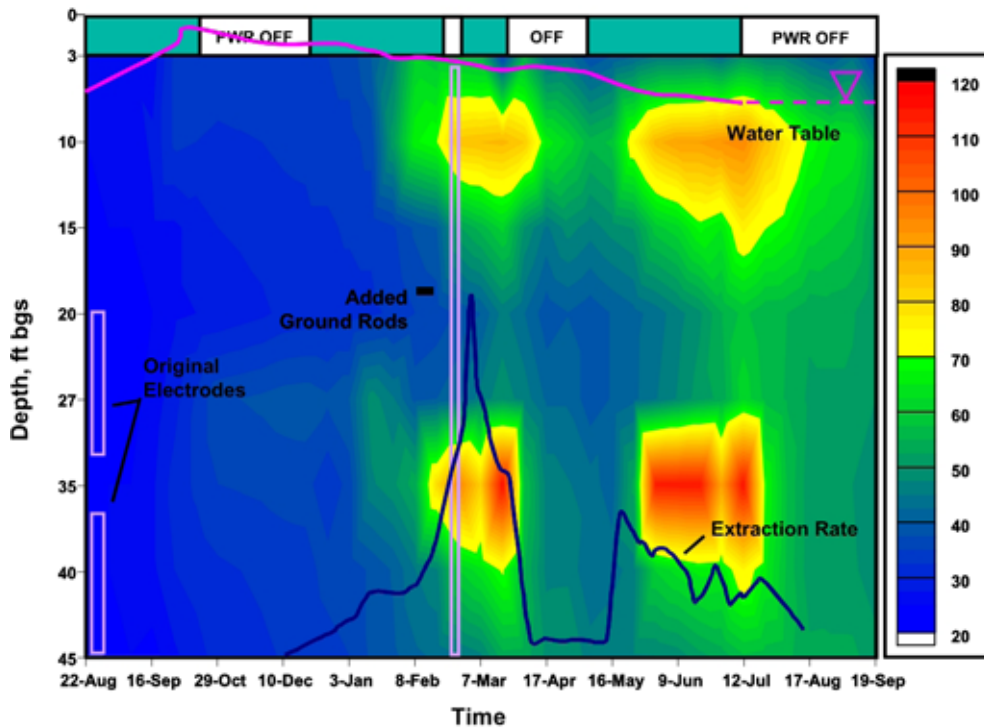

Plot of Subsurface Temperature profiles at TMP 4

Figure 3-6. Temperature Profile at TMP-3 and TMP-4

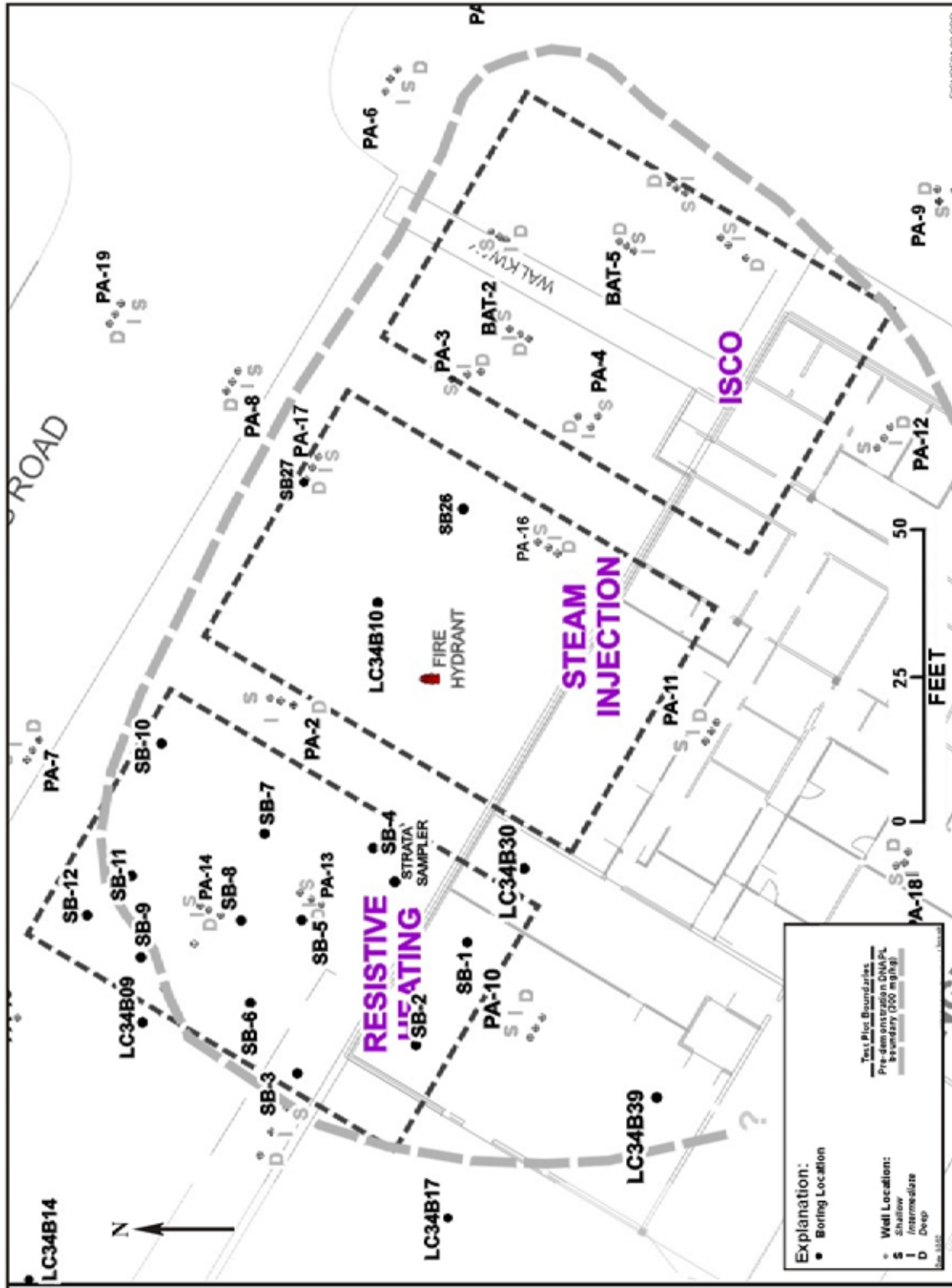

Figure 3-7. Soil Boring and Monitoring Well Locations

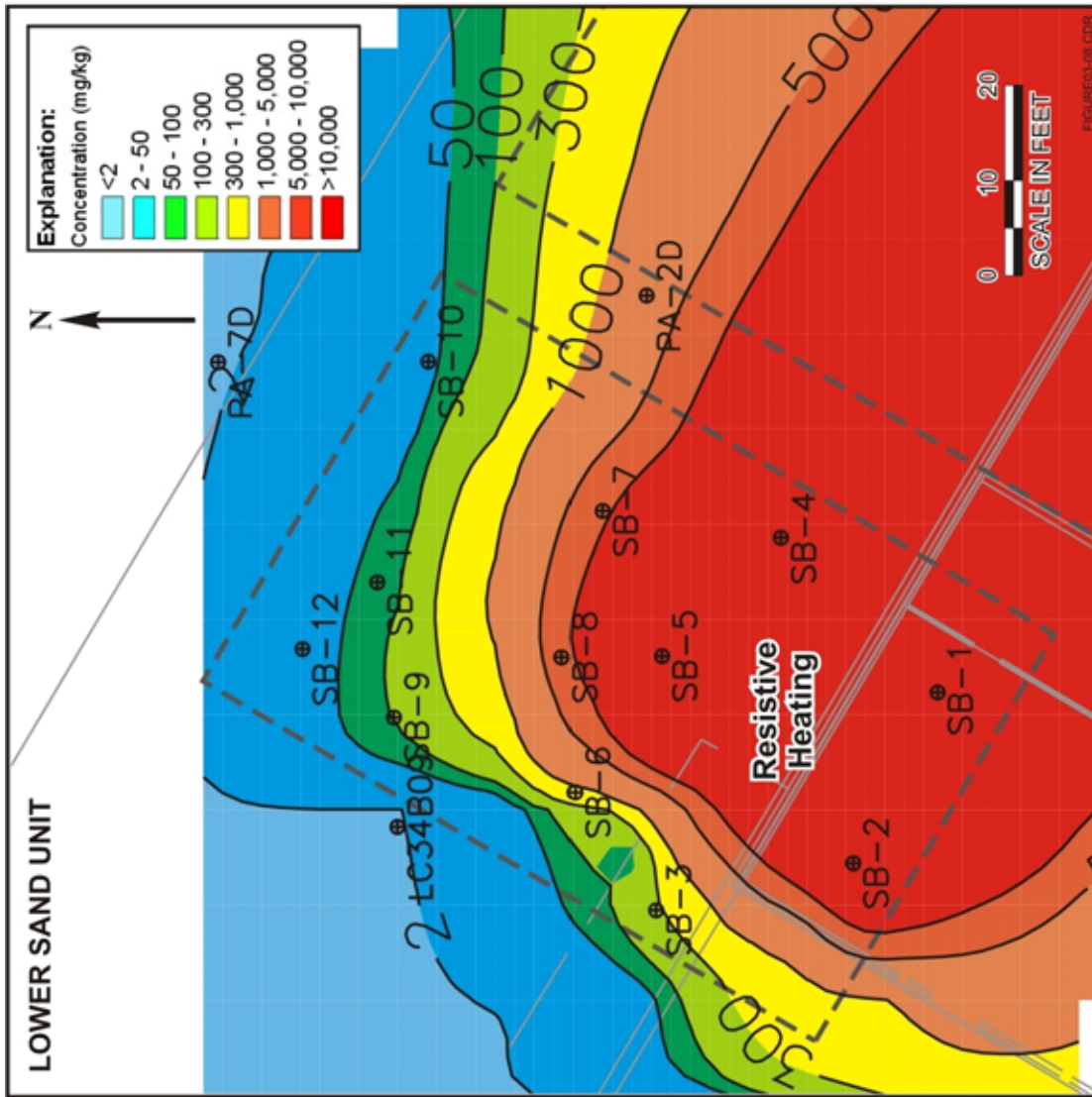

Figure 3-8. TCE Concentrations in Soil (mg/kg) Before ERH Application

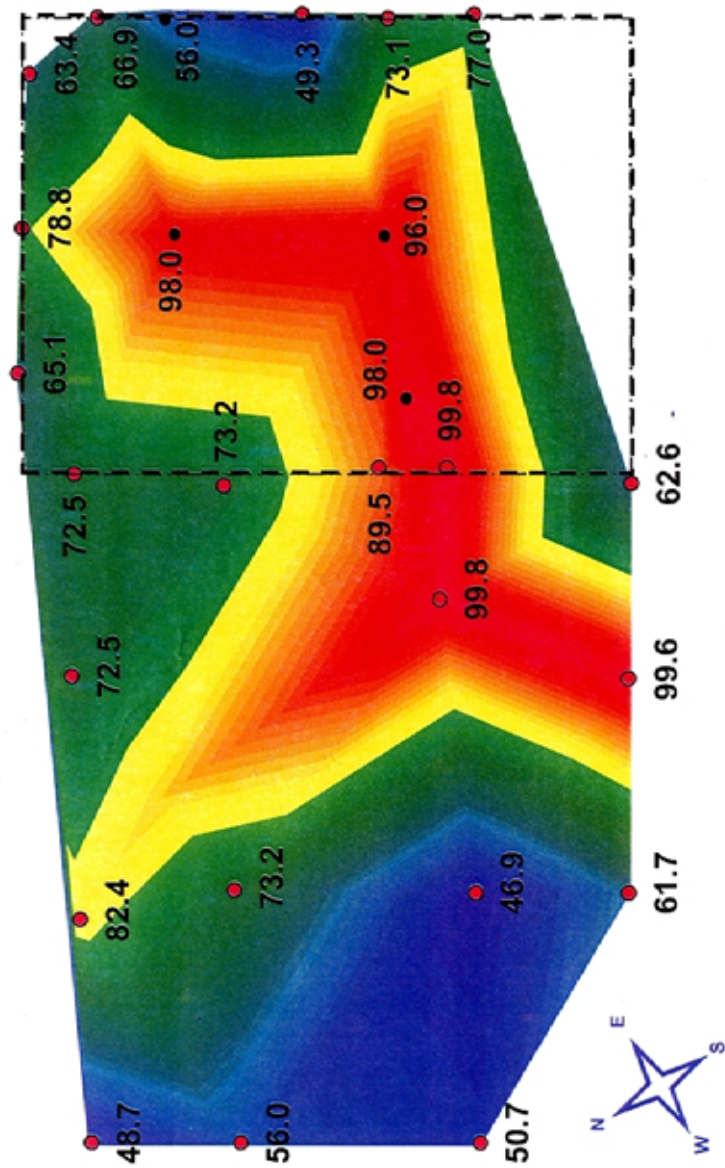

Figure 3-9. Temperature Mapping at 5 ft bgs in ERH Plot and Surrounding Aquifer

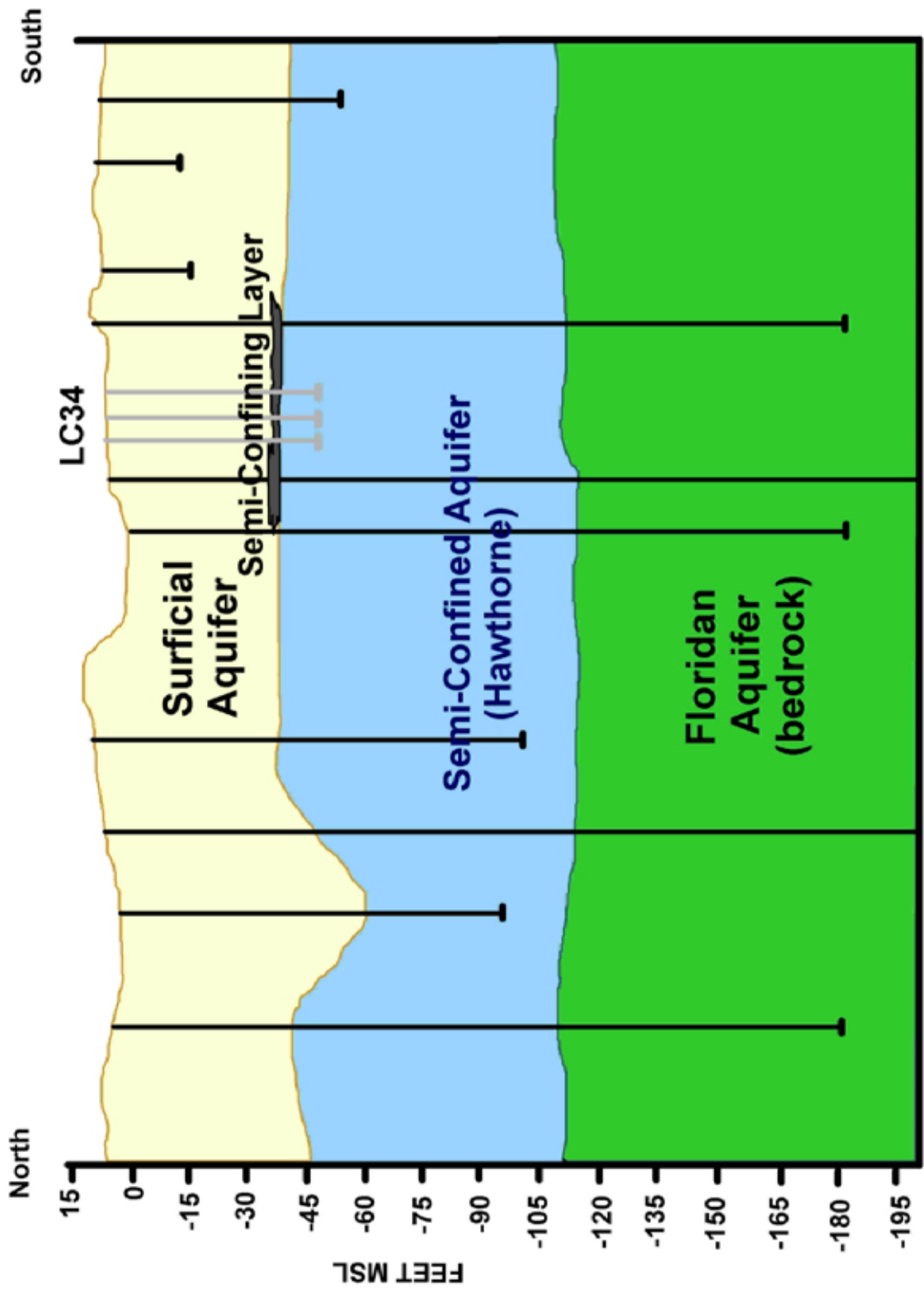

FIGURE 08 CDJR

Figure 3-10. Unconfined (Surficial) and Semi-Confined Aquifers at Cape Canaveral

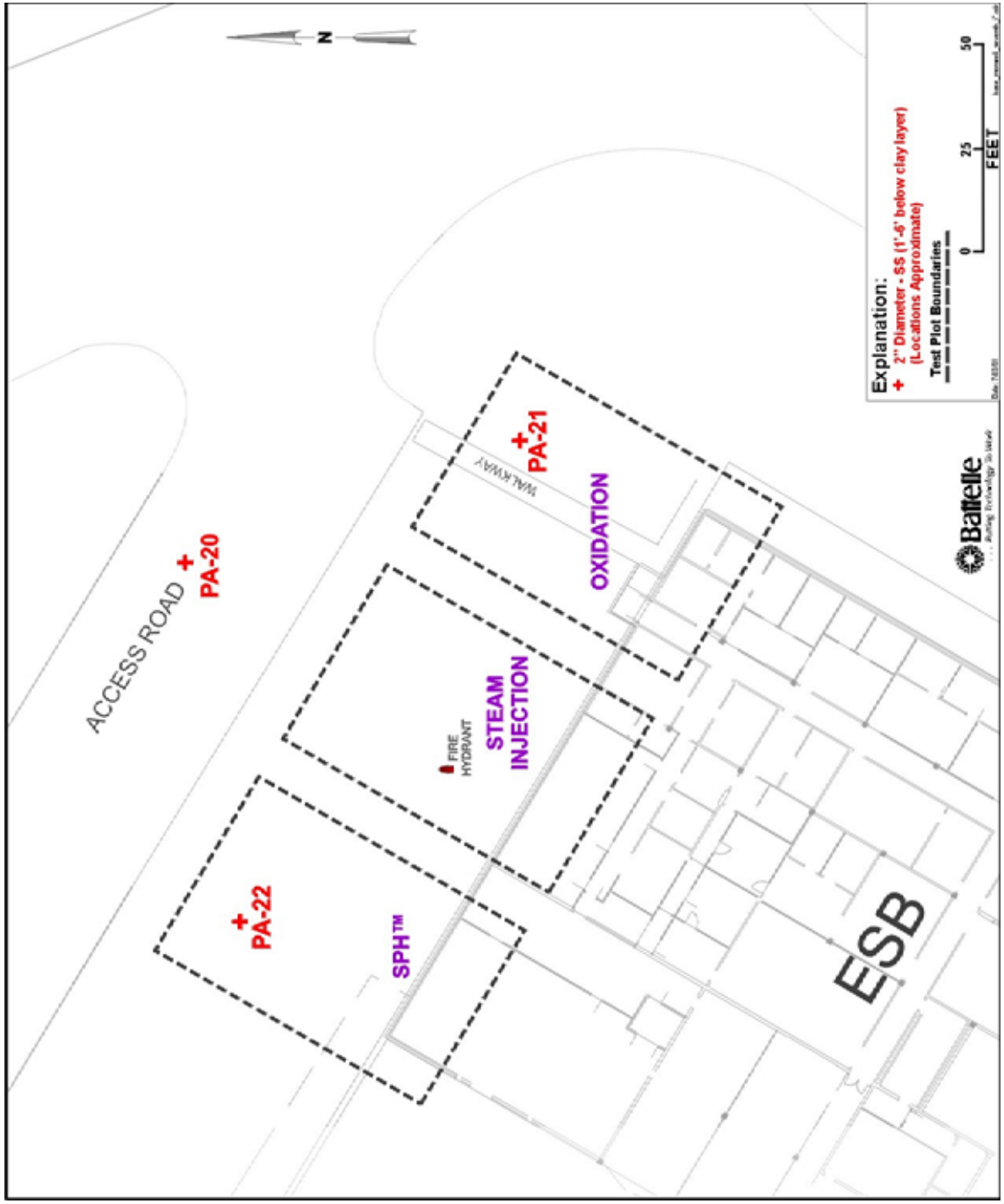

Figure 3-11. Deep (Semi-Confined Aquifer) Monitoring Well Locations

Section 4.0: ERH APPLICATION AT CHARLESTON NAVAL COMPLEX

4.1 Introduction

Charleston Naval Complex was developed in 1996 after the disestablishment of the existing Naval Shipyard and base at Charleston, South Carolina, under the Base Realignment and Closure Act. The site in Charleston where ERH was applied was the Area of Concern (AOC) 67. AOC 67 (Figure 4-1) consisted of a former dry cleaning facility. Building 1189, in AOC 67, served as the dry cleaning facility from 1942 to 1986. Toward the end of its operation, the dry cleaning facility was used as a general purpose laundry facility and had two industrial washers and dryers. These activities led to the introduction of PCE at this site. PCE, a typical dry cleaning agent, was one of the primary materials used, stored, disposed of, and accidentally released at this site. A Resource Conservation and Recovery Act (RCRA) facility investigation conducted in 1996 and 1997 reported the presence of a dissolved phase CVOC plume in the saturated zone. The CVOCs found in the plume were PCE, TCE, *cis*-1,2-DCE, 1,1-DCE, and vinyl chloride (VC).

4.2 Geology and Hydrogeology

The subsurface mainly consists of undifferentiated Quaternary age sands, silts and clays of the Wando formation to approximately 20-25 ft bgs. These deposits are comprised of many discontinuous clay layers with lenses of sands in many locations. The quaternary aged formations are underlain by undifferentiated Tertiary age marine fossiliferous silt with a variable thickness of 10-20 ft this formation is underlain by clayey calcareous silt. This formation, called the Ashley formation, overlays the Eocene-age Santee Limestone formation (Figure 4-2).

The hydrogeology at this site consists of an unconfined aquifer system within the Quaternary deposits (hydraulic conductivity 0.44 ft/day or $\sim 10^{-4}$ cm/s; average groundwater velocity 0.01 ft/day), with the underlying Tertiary Age Ashley formation acting as a lower bounding unit (vertical permeability 0.03 ft/day) and upper bound to the Santee Limestone, which is under artesian conditions and is used for potable water. The unconfined aquifer varies in total thickness from approximately 21 to 35 ft; the depth to the groundwater in this area is about 4-5 ft bgs.

4.3 Contamination Distribution

PCE appears to have migrated downward as DNAPL through fill and shallow subsurface soil until it encountered a clay unit at approximately 10 to 11 ft bgs. The PCE DNAPL appears to have accumulated on top of and within the clay layer, which provides a continuing source for the dissolved-phase chlorinated solvents detected in the shallow groundwater (Figure 4-3).

4.4 Technology Implementation

The ERH system was assembled at the site in August and September 2001. The electrodes were activated on October 3, 2001 and shut down on July 8, 2002. The original design envisioned 97 electrodes installed to a depth of 10 to 10.5 ft bgs, at which depth most of the DNAPL is suspected of being perched on a clay unit underlying the sandy fill material (see Figure 4-2). The objective was to treat a region of the shallow aquifer that incorporated total VOC concentrations greater than 2,000 $\mu\text{g/L}$ in groundwater. This target area was 16,525 ft^2 . However, the discovery of additional areas of contamination on the southwest side and other operational difficulties led to an expansion of the ERH system between October 2001 and April 2002. From April 15 to May 15, 2002, the ERH system was operating with 101 electrodes, twelve sheet piles, six Geoprobe electrodes, and 310 $\frac{3}{4}$ -inch diameter ground rods (see Figure 4-4). The operating period of the ERH system had to be extended from a design duration of 124 days to an actual duration of 279 days.

The SVE system was constructed in the vadose zone to collect steam and volatilized contaminants generated by ERH in the underlying saturated zone. Extracted vapor was processed in aboveground vapor treatment systems that included a condenser (to remove water vapor), a cooling tower (to cool condensate), and GAC adsorption units (to treat dry vapor prior to its atmospheric release). Liquid-phase treatment was not used because concentrations of contaminants in the effluent from the cooling tower were below permissible levels.

4.5 Performance Evaluation Approach

Monitoring of the SVE-treated effluent, ambient air, and soil vapor from outside the ERH footprint was conducted during the ERH operation by CH2M-Jones. SVE and ambient air samples were collected using the 6-liter Summa canisters and analyzed for VOCs using U.S. EPA Method TO-14A. Five ambient air samples at the 3 to 5 ft aboveground surface were collected to position and analyze air at the breathing zone elevation. Groundwater sampling was conducted through the operations and pre- and post-ERH application to analyze CVOC concentrations. Groundwater was collected from shallow and deep monitoring wells.

4.6 Technology Performance

The major cause of the system expansion and extended duration was that drying of soils in the immediate vicinity of the electrodes kept making the saturated zone less conductive. Approximately 244 of the 310 ground rods were installed to decrease electrode spacing from approximately 14 ft to 7 ft. Approximately 66 ground rods were installed to a greater depth of 12 ft bgs to ensure that the top of the clay unit that starts at 10 or 11 ft bgs was adequately heated. To optimize performance, the two 400-kW power control units were cycled with 50 min of operation, followed by 10 minutes of shut down, to allow “re-wetting” of the electrodes with drip lines. This prevented drying of the immediate region around the electrodes, but led to increased operating time to reach the target temperature of 92°C. The adjusted boiling point of PCE, the primary contaminant, increases from 88°C at atmospheric pressure to 89 and 92°C at 7 and 11 ft bgs, due to the increased pressure with increased depth under the water table. As shown in Figures 4-5 and 4-6, these temperatures were reached at all locations in the target treatment zone on the 204th day of operation.

Figure 4-7 shows the recovery in lb/day of PCE and total CVOCs in the vapor recovery system. Figures 4-5 and 4-6 showed that temperatures reached their targets of 89°C at 7 ft bgs and 92°C at 11 ft bgs only around February 1 and March 1 respectively. Given that most of the contamination was tied up with the clay layer at 10 to 11 ft bgs, it was only after March 1 that the PCE recovery rate (lb/day) started rising significantly, finally peaking at 2.75 lb/day around May 1, 2002 (Figure 4-7). It took eight weeks of heating of the deepest target interval at temperatures above the boiling point of PCE to maximize the recovery rate. Before the target temperatures were reached at 11 ft bgs, the PCE recovery rate fluctuated and rose only by a maximum of two times the pre-treatment rate of 0.5 lb/day at the natural groundwater temperature. This indicates that although increased volatilization of VOCs occurs at moderately elevated temperatures, reaching the adjusted boiling point of the target contaminant and staying at or above that temperature for several weeks is important for significant DNAPL mass recovery to occur. Interestingly, the normal water boiling temperature of around 100°C was reached and sustained at 7 ft bgs in some of the locations (Figure 4-5) and at 11 ft bgs at none of the locations (Figure 4-6). As experienced at other sites, it is possible that VOC recovery would have increased further at temperatures closer to the boiling point of water.

Approximately 3,500 gal of water condensate were recovered during the ERH application. Most of this condensate was probably generated from steam generated near the water table at shallower intervals. It is possible that the PCE recovery rates in Figure 4-7 would have shown another sharp increase, if the temperatures had reached 100°C, which would have led to increased steam generation and steam stripping

of PCE at 10 or 11 ft bgs where most of the DNAPL was suspected to occur. Although 234 lb of PCE (247 lb of total CVOCs) were recovered in extracted vapor during the ERH application, groundwater PCE concentrations rebounded in several wells in the months after the end of ERH treatment, thus indicating that there still may be considerable DNAPL mass left in the target treatment zone.

Groundwater samples were collected from 12 shallow monitoring wells, screened in the sandy fill above the clay layer within the ERH treatment zone before, during, and after the ERH application. The locations of these wells are shown in Figure 4-1. In addition, one intermediate (F607GW061) and one deep (F607GW06D) well located in the treatment area were sampled to determine potential for downward migration of DNAPL due to the ERH treatment. The shallow wells are screened approximately between 8.5 to 13.5 ft bgs. The intermediate well is screened from 17.5 to 19 ft bgs and the deep well is screened 29.5 to 31 ft bgs in the Quaternary age sands, silts, and clays below the fill and the clay lens. All of these water bearing zones (shallow, intermediate and deep) are considered parts of the same unconfined surficial aquifer. Seven shallow monitoring wells outside the ERH treatment area were also sampled to evaluate potential for lateral migration of DNAPL due to the ERH application. These 21 wells were sampled before (September 2001), during (monthly from February to June 2002), immediately after (July 2002), and six months after (January 2003) ERH treatment.

Tables 4-1 and 4-2 summarize some of the analytical results for selected constituents in selected monitoring wells inside and outside the treatment zone, respectively. The average overall reduction in PCE concentrations between the before (September 2001) and six months after treatment (January 2003) sampling events in the shallow treatment zone wells was 64.8%. The total CVOC concentration declined only 21% on average, but this is due to a substantial increase in *cis*-1,2-DCE levels in many treatment zone wells (e.g., from 5,200 to 29,000 µg/L in F607GW028). The portion of the total CVOCs that was PCE declined from 76% before ERH to 33.9% after ERH (January 2003), indicating that degradation products made up a larger portion of the total CVOC residuals after treatment.

In several treatment zone wells, such as F607GW006 and F607GW27, PCE levels showed a more dramatic decline when the pre-treatment (September 2001) and immediate post-treatment (July 2002) results are compared. In F607GW006, for example, PCE concentration declined from 6,800 to 360 µg/L. However, by January 2003, six months later, the PCE concentration had rebounded to 5,400 µg/L. This indicates that there may be substantial DNAPL mass left in the target treatment zone that was not obvious from the immediate post-treatment sampling. In F607GW27, PCE concentration declined from 930 to 320 µg/L in July 2002, but rose to 3,800 µg/L in January 2003, a level higher than before treatment. This may indicate that there may have been some redistribution of either the DNAPL or dissolved phase PCE during the ERH application, or alternatively, some change in the exposure pattern of trapped DNAPL to the bulk groundwater flow.

As shown in Figure 4-3, the suspected DNAPL PCE zone (concentrations greater than 2,000 µg/L) has shrunk primarily in the northern and eastern portion of the treatment zone following ERH. Although concentrations have declined in many parts of the PCE “plume”, considerable volume of suspected DNAPL remained after treatment. This is unexpected because the designed temperature objectives were achieved in all parts of the treatment zone, despite some challenges with drying of the electrodes because of the slow groundwater recharge in the aquifer.

4.7 Cost

The total project cost at this site was approximately \$1,274,000, including the ERH treatment cost (primarily the vendor’s application cost) of \$1,009,000. Cost details are presented in Table 4-3 (U.S. EPA, 2005). Approximately 135,000 ft³ of aquifer volume was targeted for treatment, which took place over 279 days, leading to 247 lb of recovered VOCs.

4.8 Discussion

The original ERH design for this site called for 97 electrodes to treat 16,525 ft² of area. Because of the low hydraulic conductivity ($\sim 10^{-4}$ cm/s) of the formation and the slow recharge of the groundwater, the soil around the electrodes kept drying and becoming less conductive. Between October 3 and December 15, 2001, temperatures at the shallow depth (7 ft bgs) were mostly below 89°C, the PCE boiling temperature at this depth, and temperatures at the deeper interval (11 ft bgs) were well below 92°C, the PCE boiling temperature at this depth. PCE mass recovery in the vapor capture system rose to about 1 lb/day (from approximately 0.5 lb/day before heating started). Therefore, the ERH system had to be expanded to increase the electrode density and also to cover a small new area of contamination discovered on the southwest side. The expanded ERH system consisted of 101 electrodes, 12 sheet piles, six Geoprobe electrodes, and 310 ground rods. Approximately 66 of the 310 ground rods were installed to a greater depth of 12 ft bgs to ensure that the top of the clay unit that starts at 10 or 11 ft bgs was adequately heated. The operating period of the ERH system had to be extended from a designed duration of 124 days to an actual duration of 279 days. Drip lines were used to keep the electrodes wet.

It was only in January and March 2002 that temperatures in most locations at 7 and 11 ft bgs finally rose above the 89 and 92°C, the adjusted boiling points of PCE at the two target depths. The PCE mass recovery rate started rising concurrently in March 2002 and peaked towards the end of April 2002. This indicates that reaching the boiling temperatures of the individual CVOCs and sustaining these temperatures for several days are necessary for bringing about substantial CVOC mass removal. In a low-permeability aquifer, greater electrode density and longer operating times at controlled energy application rates are necessary to prevent the aquifer from drying, to keep the heating efficiency high, and to trigger substantial CVOC and DNAPL mass removal.

Approximately 234 lb of PCE were recovered in the captured vapor phase during the ERH application. However, even with the extensive expansions of the ERH system described above and the long period of operation, it is possible that considerable CVOC and DNAPL mass still remains in the target aquifer zone. In several treatment zone monitoring wells, CVOC levels declined dramatically when concentrations before treatment and immediately after ERH treatment are compared. However, by January 2003, six months after disconnecting the electrodes, PCE concentrations had rebounded considerably in several wells. When pre-treatment PCE concentrations are compared to the concentrations during the six month post-treatment monitoring event, the average reduction in PCE concentration was 64.8%. Total CVOC removal percentages were even lower, but that is mainly because of substantial *cis*-1,2-DCE production, indicating that biodegradation rates had been considerably enhanced at elevated temperatures.

Table 4-1. CVOC Concentrations in Groundwater Inside the Treatment Zone

Well	Date	<i>cis</i>-1,2-DCE (mg/L)	TCE (mg/L)	PCE (mg/L)	Vinyl Chloride (mg/L)
F607GW006	09/20/01	370	380	6800	500U
	01/07/02	28	15	150	10U
	02/06/02	17	8.1J	110	20U
	03/13/02	14J	11J	160	40U
	04/09/02	12J	7J	120	50U
	05/02/02	11	9.7	120	10U
	06/05/02	6.9	7.1	160	10U
	07/12/02	26	36	360	20U
01/09/03	450	400	5400	20U	
F607GW011	09/20/01	440	430	5600	500U
	01/07/02	490	520	5000	27J
	02/06/02	190	180	2800	200U
	03/13/02	94	81	1400	100U
	04/09/02	34	22J	570	50U
	05/03/02	140	95	1700	5.6J
	06/04/02	110	150	2200	100U
	07/12/02	86	74	1400	50U
01/09/03	210J	330	3800	500U	
F607GW015	09/20/01	190	250	2100	200U
	02/06/02	140	120	1700	100U
	03/13/02	72	51	930	100U
	04/08/02	52J	27J	490	200U
	05/03/02	86J	66J	910	250U
	06/04/02	280	270	7600	200U
	07/10/02	48	18	290	10U
	01/09/03	7.4	7.2	28	10U
F607GW016	09/20/01	310	59	260	1.7J
	02/06/02	420	81	200	8.7J
	03/13/02	180	40J	42	250U
	04/09/02	110	24	38	3.2J
	05/03/02	92	18	18	2.2J
	06/04/02	78	28	28	2.3J
	07/10/02	82	24	34	2.2J
	01/10/03	37	1.2J	5.0U	.65J
F607GW017	09/20/01	30	12	83	10U
	02/06/02	6.8J	2.6J	4.5J	20U
	03/13/02	26J	10J	23J	100U
	04/09/02	4.8J	1.8J	5.8	10U
	05/03/02	14	4.8J	12	20U
	06/04/02	25	12	130	20U
	07/10/02	7.5	2.8J	12	10U
	01/10/03	2.7J	2.1J	2.4J	10U

Table 4-1. CVOC Concentrations in Groundwater Inside the Treatment Zone (Continued)

Well	Date	<i>cis</i> -1,2-DCE (mg/L)	TCE (mg/L)	PCE (mg/L)	Vinyl Chloride (mg/L)
F607GW027	09/21/01	190	170	930	100U
	01/07/02	6	9.4	130	10U
	02/05/02	26	23J	490	50U
	03/13/02	5.0U	5.0U	5.0U	10U
	04/08/02	50J	63J	2100	200U
	05/02/02	28	88	1200	50U
	06/05/02	1.6J	3.4JB	81	10U
	07/09/02	8.2J	11	320	20U
01/09/03	180J	260	3800	500U	
F607GW028	09/20/01	5200	6500	26000	2000U
	01/07/02	4600	5800	13000	1000U
	02/05/02	3200	3300	13000	1000U
	03/13/02	1900	2100	10000	1000U
	04/08/02	1200	1000	4000	250U
	05/03/02	340	400	2300	200U
	06/05/02	230	380	1800	200U
	07/10/02	560	580	3600	250U
01/09/03	29000	4400	1900	87J	
F607GW029	09/21/01	870	870	3100	200U
	02/06/02	330	290	1700	17J
	03/13/02	230	170	760	9J
	04/09/02	190	130	600	7.6J
	05/03/02	120	94	460	8.8J
	06/04/02	100	93	340	5.4J
	07/09/02	230	200	940	11J
	01/09/02	37	34	140	1.1J
F607GW06I	09/21/01	35J	150	2400	200U
	02/05/02	330	150	1600	100U
	03/13/02	180	240	1900	5.8J
	04/09/02	110	190	1300	6.3J
	05/02/02	95	300	2200	15J
	06/05/02	68	330	1000	5.3J
	07/12/02	88	310	2400	11J
	01/09/02	63	170	660	6.1J
F607GW06D	09/20/01	35J	150	2400	200U
	02/05/02	5.0U	5.0U	5.0U	10U
	03/13/02	5.0U	5.0U	5.0U	10U
	04/09/02	5.0U	1.5J	15	10U
	05/02/02	5.0U	.97J	42	10U
	06/05/02	5.0U	.35J	27	10U
	07/10/02	.81J	2.5J	21	10U
	01/09/03	5.0U	5.0U	5.0U	10U

Table 4-2. CVOC Concentrations in Groundwater Outside the Treatment Zone

Well	Date	<i>cis</i> -1,2-DCE (mg/L)	TCE (mg/L)	PCE (mg/L)	Vinyl Chloride (mg/L)
F607GW002	09/26/01	5.0U	5.0U	5.0U	10U
	11/08/01	5.0U	5.0U	5.0U	10U
	12/03/01	5.0U	5.0U	5.0U	10U
	01/08/02	5.0U	5.0U	5.0U	10U
	02/11/02	5.0U	5.0U	5.0U	10U
	03/06/02	5.0U	5.0U	5.0U	10U
	04/04/02	5.0U	5.0U	5.0U	10U
	05/06/02	5.0U	5.0U	14	10U
	06/06/02	5.0U	5.0U	3.6J	10U
	07/09/02	5.0U	5.0U	5.0U	10U
	01/10/03	5.0U	5.0U	5.0U	10U
F607GW003	09/26/01	5.0U	5.0U	5.0U	10U
	11/08/01	5.0U	5.0U	5.0U	10U
	12/03/01	5.0U	5.0U	5.0U	10U
	01/08/02	5.0U	5.0U	5.0U	10U
	02/11/02	5.0U	5.0U	5.0U	10U
	03/06/02	5.0U	5.0U	5.0U	10U
	04/05/02	1.6J	5.0U	5.0U	10U
	05/06/02	5.0U	5.0U	5.0U	10U
	06/06/02	5.0U	5.0U	5.0U	10U
	07/09/02	5.0U	5.0U	5.0U	10U
	01/10/03	5.0U	5.0U	5.0U	10U
F607GW004	09/26/01	130	15	5.0U	1.5J
	12/03/01	110	14	5.0U	2.3J
	01/08/02	110	13	5.0U	2.6J
	02/11/02	78	6.8	5.0U	.95J
	03/06/02	54	4.5J	5.0U	10U
	04/22/02	51	4.2J	1.7J	10U
	05/06/02	54	4.0J	5.0U	.52J
	06/06/02	62	15	2.7J	10U
	07/09/02	55	11	5.0U	.73J
	01/14/03	1.8J	5.0U	5.0U	5.0U
F607GW007	09/26/01	5.0U	5.0U	5.0U	10U
	11/08/01	5.0U	5.0U	5.0U	10U
	12/03/01	5.0U	5.0U	5.0U	10U
	01/08/02	5.0U	5.0U	5.0U	10U
	02/11/02	5.0U	5.0U	5.0U	10U
	03/06/02	5.0U	5.0U	5.0U	10U
	04/22/02	5.0U	5.0U	.34J	10U
	05/06/02	5.0U	5.0U	5.0U	10U
	06/06/02	5.0U	5.0U	5.0U	10U
	07/09/02	5.0U	5.0U	5.0U	10U
	01/10/03	5.0U	5.0U	5.0U	10U

Table 4-3. Summary of Costs of ERH Application at Charleston

Item	Cost
<i>Vendor Cost</i>	
Pilot-scale test	\$32,000
Full-scale mobilization/demobilization and reporting	\$71,000
Capital costs	\$373,000
Operation costs	\$473,000
Retrofitting (electrode installation and well replacement)	\$60,000
Vendor Total Cost	\$1,009,000
<i>Site Incurred Cost</i>	
Monitoring (laboratory analytical services)	\$50,000
Project oversight	\$215,000
Site Incurred Cost	\$265,000
TOTAL	\$1,274,000

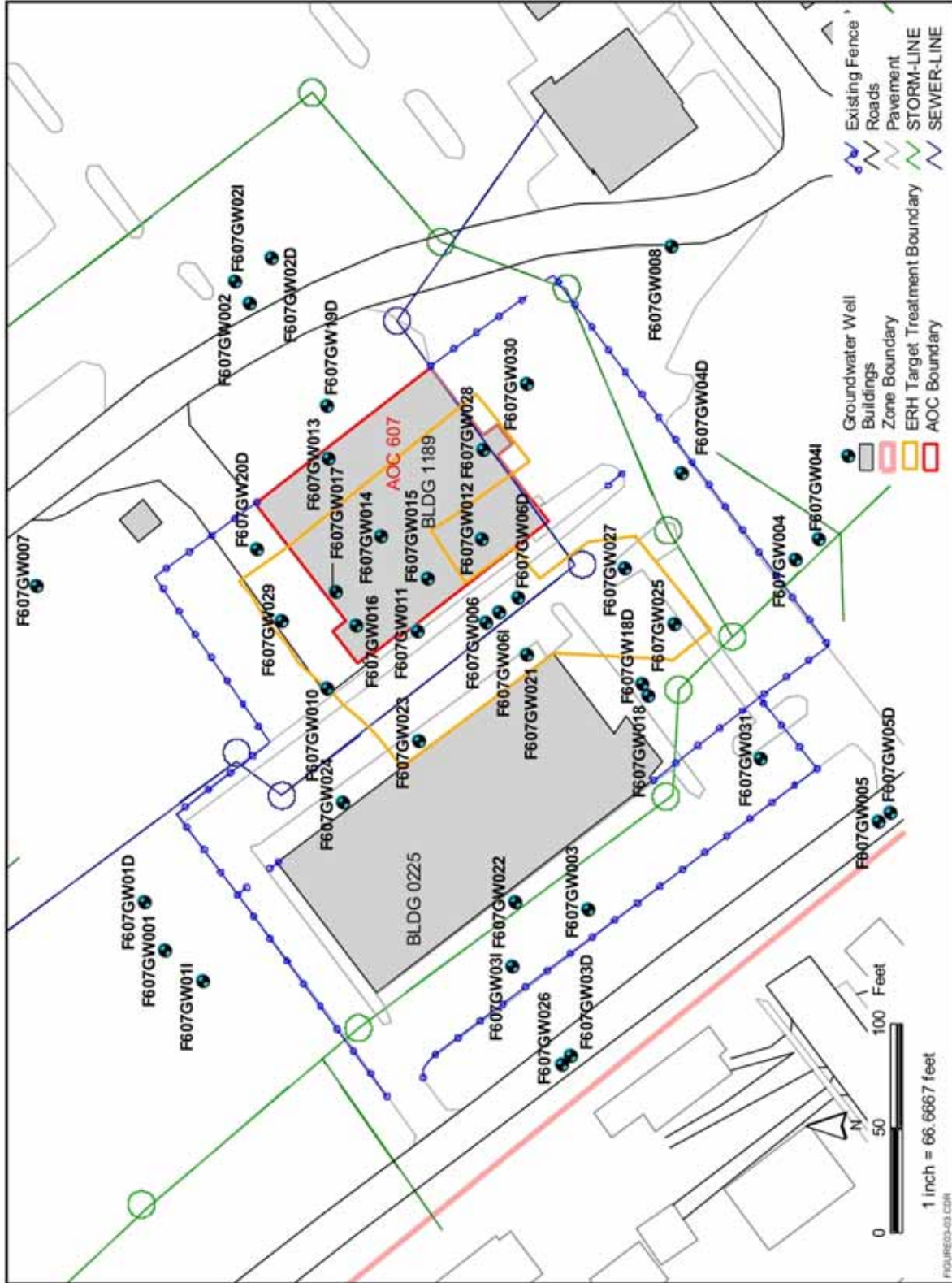

Figure 4-1. ERH Site Layout and Monitoring Wells Location Map

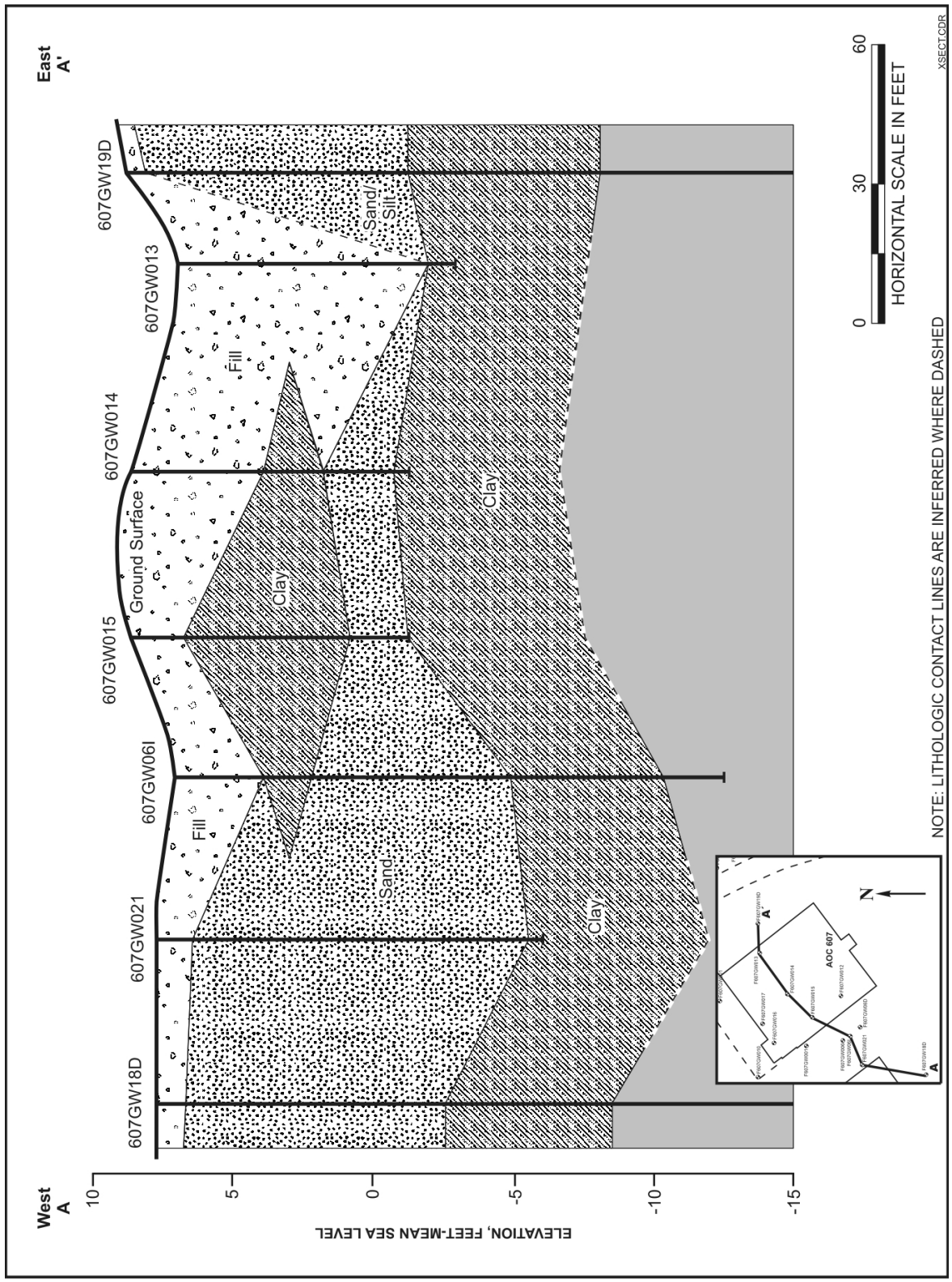

Figure 4-2. Geological Cross-Section at Charleston Site

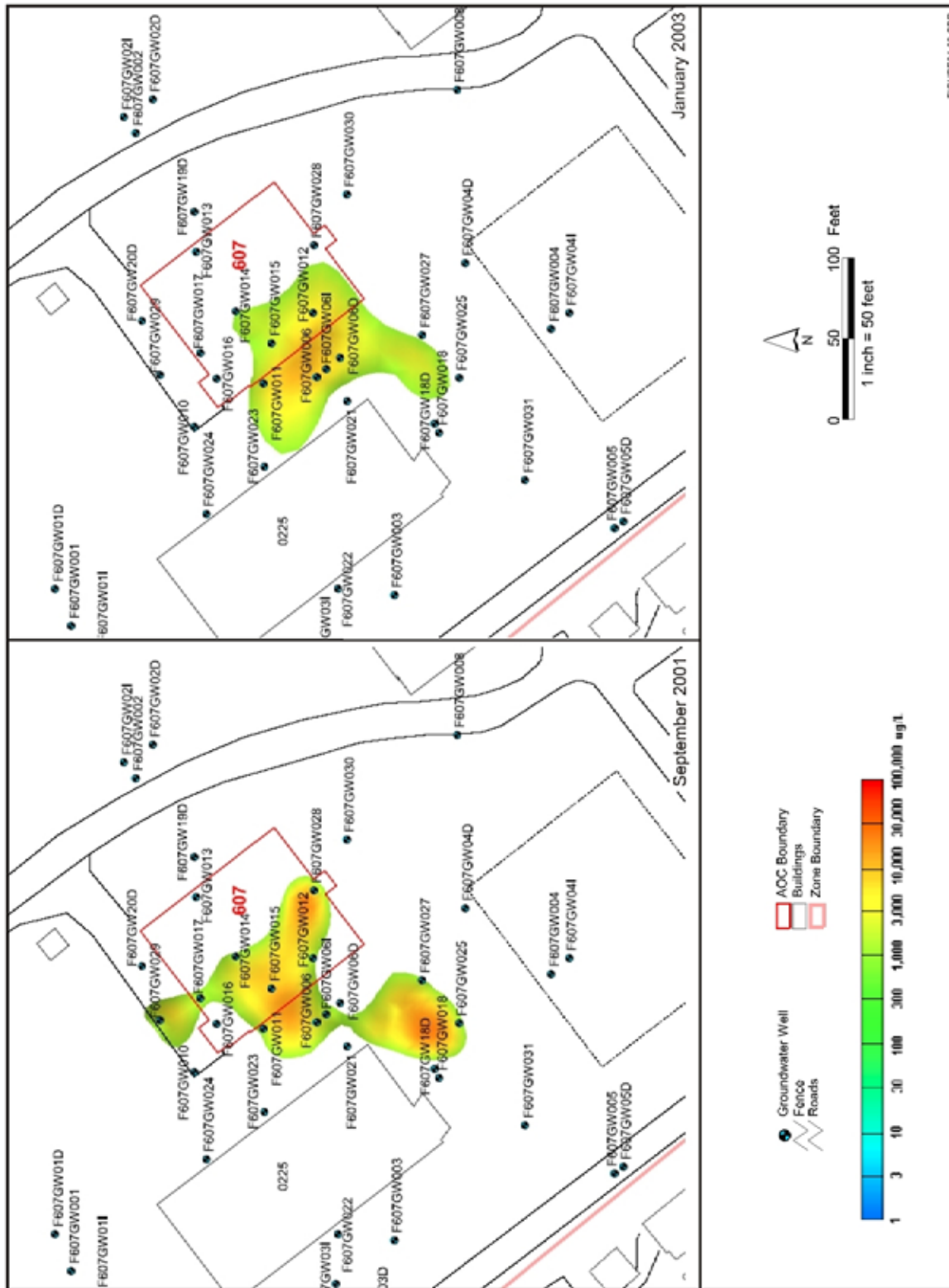

Figure 4-3. PCE Distribution Before and After ERH Treatment

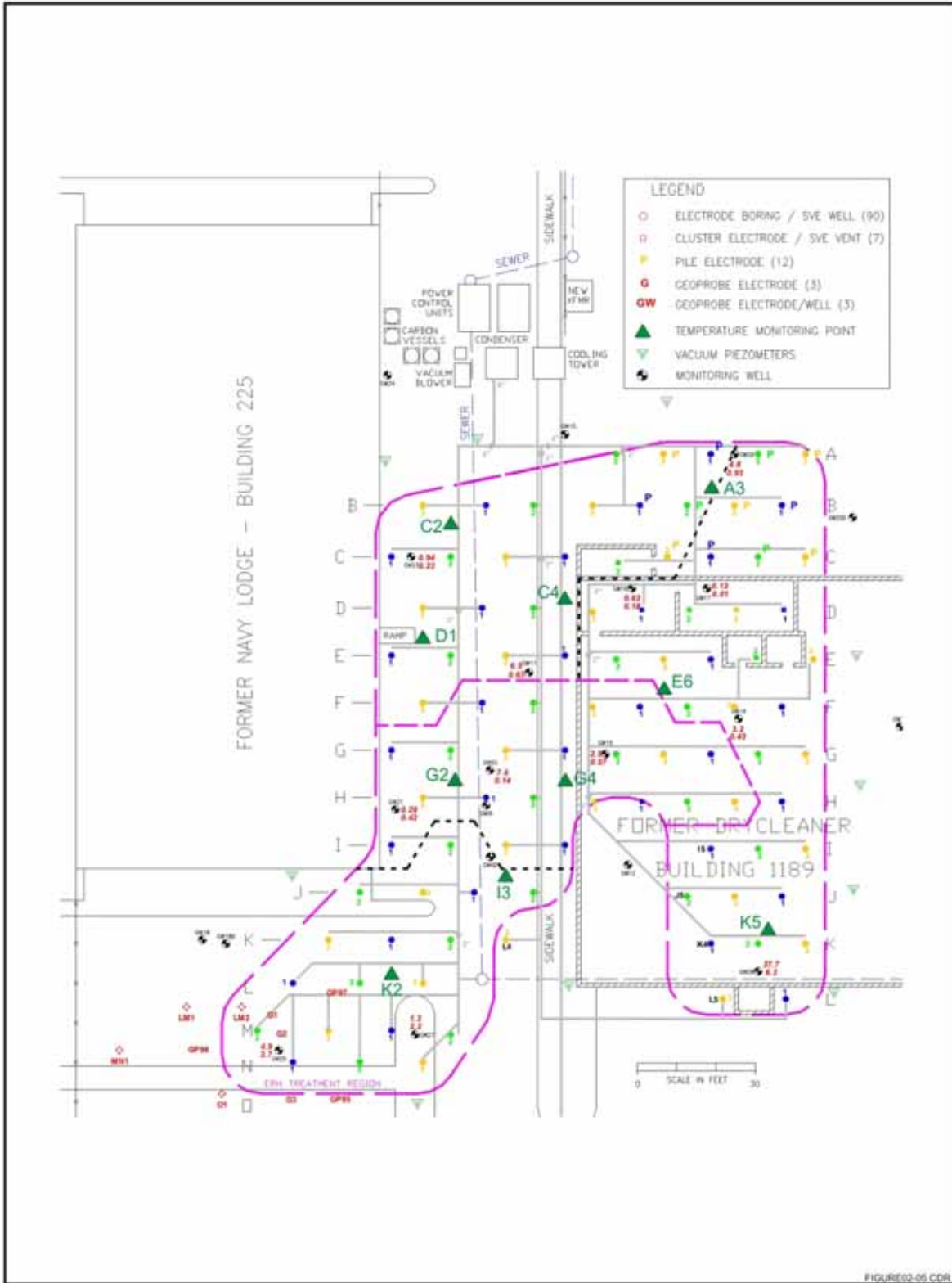

Figure 4-4. ERH System Layout at Charleston Site

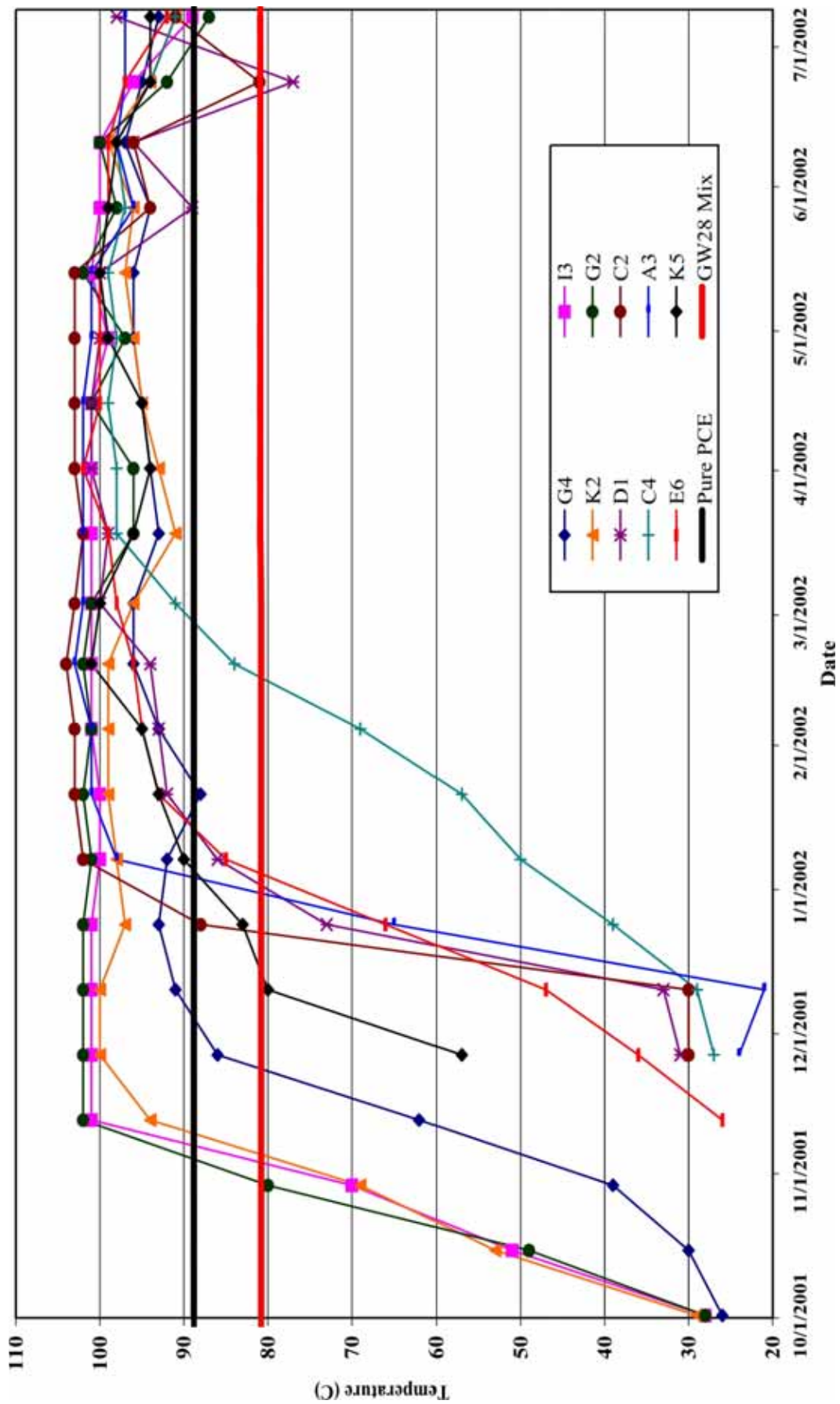

Figure 4-5. Subsurface Thermocouple Temperature at 7 ft bgs

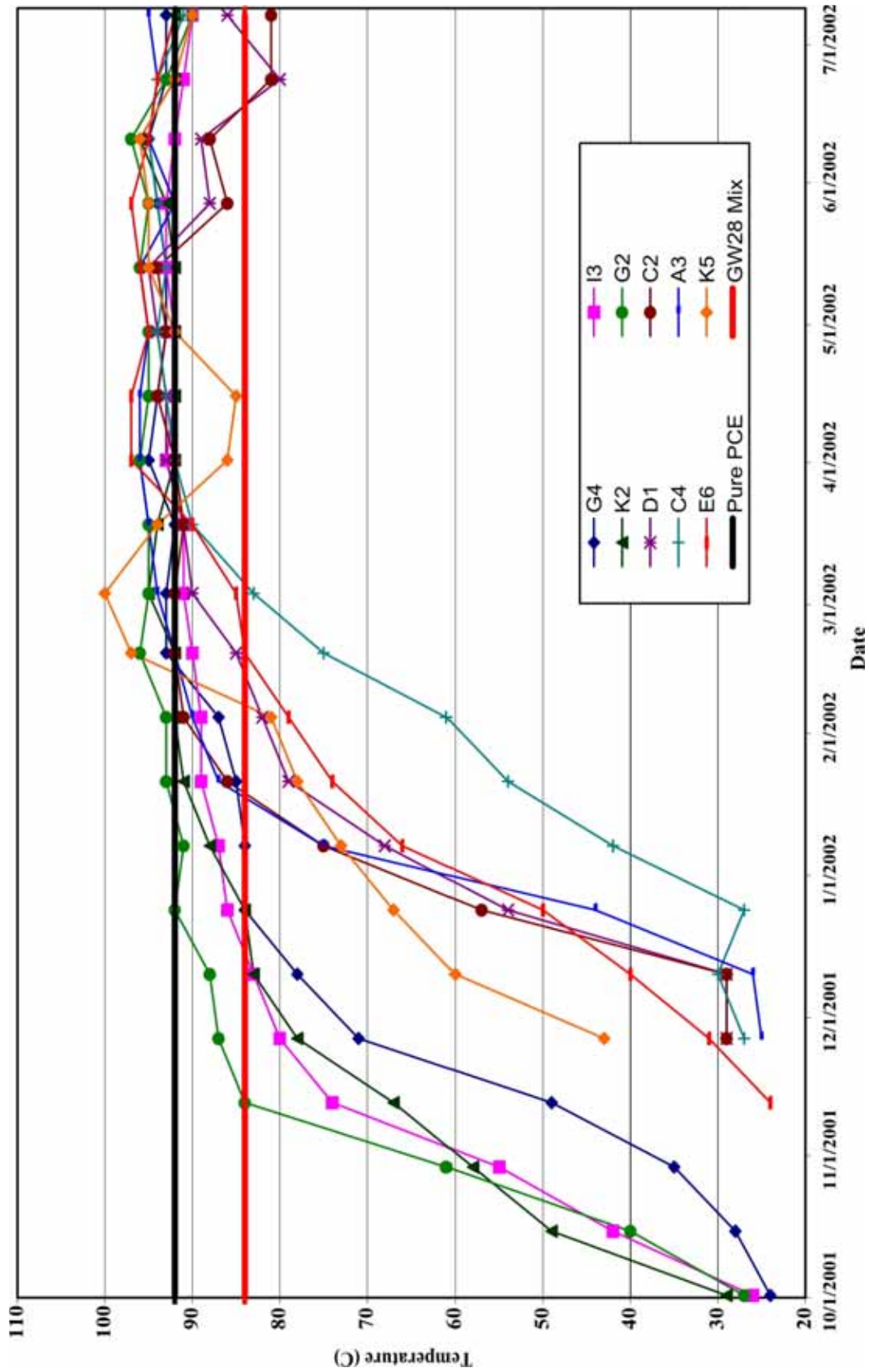
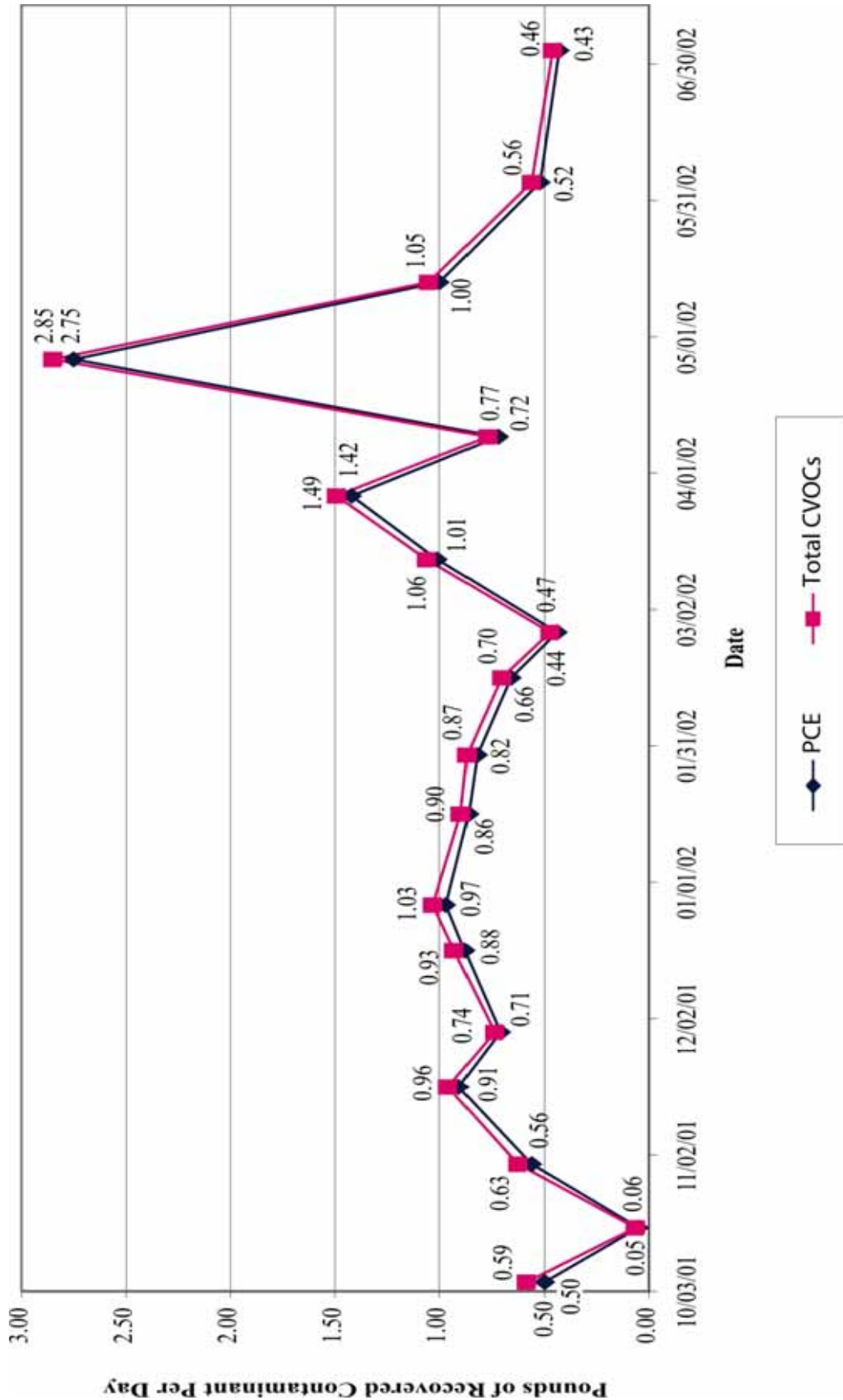

Figure 4-6. Subsurface Thermocouple Temperature at 11 ft bgs



Total CVOCs are a concentration summation of 1,1-DCE, trans-1,2-DCE, cis-1,2-DCE, TCE, PCE, and vinyl chloride

Figure 4-7. Daily Recovered Mass of PCE and Total CVOCs

Section 5.0: ERH APPLICATION AT FORMER NAS ALAMEDA

5.1 Introduction

Alameda Point is located on Alameda Island, in Alameda County, California. The island is located along the eastern side of San Francisco Bay. Alameda Point occupies 2,634 acres, partially on land and partially submerged, and is approximately 2 miles long and 1 mile wide (Figure 5-1). U.S. Army acquired the area in 1930 and transferred the base to the Navy in 1941. The base was listed under the Base Realignment and Closure (BRAC) Act in 1993.

Building 5 housed the plating shop, which is responsible for the VOC contamination in the subsurface in this area. Processes in the shop included degreasing, caustic and acid etching, metal stripping and cleaning, and chrome, nickel, silver, cadmium, and copper plating. A groundwater sample collected in 1992 from a boring located inside Building 5 at the plating shop showed concentrations of 790 ppm of TCA, indicating that the site was contaminated with significant levels of DNAPL. TCE also has been detected in the groundwater and soil samples in this area (ESTCP, 2000).

5.2 Geology and Hydrogeology

Plume 5-1 is located northeast of Building 5. The 10,000 µg/L contour is bean-shaped, oriented north-south, with a maximum width of 100 ft and length of 150 ft. The pilot test cell was sited in the southern portion of the plume, within the 10,000 µg/L contour. The targeted region of contamination is the saturated zone down to 20 ft bgs. The subsurface in this area consists of two geologic zones: the Bay Sediment Unit (BSU) and artificial fill (Figure 5-2). The BSU extends from 17 to 20 ft bgs and is composed of three sediment types: stiff, moist, dark olive clay; sand and clay with shell fragments; and silty sand with interbedded layers of fine-grained sand. These sediments have moderate to low hydraulic conductivity ranging from 3.22×10^{-8} cm/s to 3.90×10^{-5} cm/s. The artificial fill, which lies on top of the BSU, is composed of olive brown, unconsolidated fine to medium-grained sand with high permeability silty sand, gravelly sand or sandy gravel. The surface of IR Site 5, both inside and outside the building is covered by a concrete pad roughly 6-8 inches thick. This concrete surface proved to be a competent seal for the contaminant of vapors during the pilot test.

Groundwater at Plume 5-1 is between 4 and 7 ft bgs in the artificial fill. In the location of the pilot test cell, the first and second water-bearing zones, FWBZ and SWBZ, respectively, are separated by the low-permeability sediments in the BSU which act as a confining layer. The groundwater flow direction in the FWBZ is to the northeast, and that of the SWBZ is to the south. The tidal influence on the SWBZ is approximately 2 inches in the pilot test cell area. The tidal influence on the FWBZ is not known.

5.3 Contamination Distribution

There are two distinct DNAPL plumes at IR Site 5: Plume 5-1 and Plume 5-3 (Figure 5-3). ERH was applied at Plume 5-1. This plume was investigated to be approximately 1/3 acre in size. The list of COCs at this site include vinyl chloride; 1,1-dichloroethane (DCA); 1,2-DCA; 1,1-DCE; *trans*-1,2-DCE; *cis*-1,2-DCE; 1,1,1-trichloroethane (TCA); 1,1,2-TCA; TCE; and tetrachloroethene. The target treatment area has been delineated to a vertical extent of only 20-ft bgs due to the presence of sensitive layer (low-permeability sediments) below this area. ERH has been applied between 13-20-ft bgs based on the presence of the sensitive layer in the treatment area.

5.4 Technology Implementation

The ERH full-scale application began on July 8, 2004, when the electrodes were turned on. The heat application was stopped on November 5, 2004, after 15 weeks of operation. Four of the five electrode arrays (see Heating Cells 1 to 4 in Figure 5-4) were completed down to 14 ft bgs, as there was a suspected

sensitive layer at this depth, below which the groundwater appeared to be unaffected by the contamination above. The fifth array (Heating Cell 5 in Figure 5-4) was completed down to 19 ft bgs, as the groundwater in this area had already been impacted by contamination at these depths. The shallow groundwater targeted for the remediation at Site 5 flows to the west or southwest through artificial fill material, consisting primarily of sand or silty sand. The water table occurs at approximately 5 ft bgs and the bay mud at approximately 20 ft bgs.

The aboveground treatment system consisted of large air-cooled condenser, an after cooler, a blower, and a condensate transfer station. Forty-nine vapor extraction wells were installed at the site driven to a depth of 5 ft bgs. Each vapor extraction well was connected to a large fiberglass collection header that was connected to the air-cooled condenser in the aboveground treatment system. The extracted vapor passed through the condenser and the blower to the after cooler. After the extracted vapor passed through the after cooler it was condensed thoroughly into liquid and collected in the knock-out (KO) tank. The liquid vapors collected in the KO tank were passed through a pair of 6,000-lb liquid GAC units connected in series. The treated condensate was discharged in 400-gallon batches from the KO tank. The condensate was then discharged to the local publicly owned treatment works (POTW).

5.5 Performance Evaluation Approach

The objective of the ERH application was to permanently reduce the total VOC concentrations to below 10,000 ppb, down to a maximum depth of 20 ft bgs. The target treatment area was demarcated by the region containing 10,000 µg/L or more of total VOCs.

After the first two weeks of operation, the system was on nearly 100% of the time. Groundwater samples were collected from 12 monitoring wells on December 18, 2003, and May 10, 2004, before the full-scale treatment (see Figure 5-5). During the heat application period, groundwater samples were collected on October 14. Post-treatment groundwater samples were collected on November 11, 2004, a week after turning off the electrodes. Long-term groundwater monitoring was conducted on March 15, 2005. Except for the two new monitoring wells (1MW6S and 1MW7S near electrode arrays 5 and 4, respectively) that were installed just before the full-scale ERH application, all monitoring wells were installed before the pilot-scale test that was done in 2003 and are clustered near electrode arrays 1 and 3. Therefore, monitoring well density in most parts of the full-scale treatment zone is low and coverage of some parts of the treatment zone is sparse.

In addition, temperatures were monitored on a weekly basis through 47 thermal monitoring wells (see Figure 5-4). Thermocouple strings were periodically lowered into each thermal well to measure temperatures at 4, 8, 12, and 16 ft bgs. The vapor extracted from 59 vapor extraction wells (each well installed to 5 ft bgs) was analyzed after the condensables were removed. The condensate was analyzed too, before discharge to a sewer and local POTW.

The four key indicators that were tracked for the performance evaluation approach at this site were subsurface temperature readings, monitoring of total VOC concentrations in the non-condensable vapor stream prior to treatment, analysis of total VOC concentration in groundwater samples collected before, during, and after the removal action, and the analysis of total VOC concentrations in process condensate prior to treatment. Temperatures within the plume were monitored by an array of thermal wells distributed over the entire plume, and extending just past the plume limits. The non-condensable vapor stream was sampled continuously by an automated device that analyzed the samples for total VOCs with a flame ionization detector (FID). The streams were monitored daily and the monthly samples were taken in Summa canisters and analyzed using the TO-15 EPA method.

5.6 Technology Performance

The vapor and condensate data show that more than 3,000 lb of VOCs were recovered during the treatment during 105 days of operation. Less than 1 lb of the VOC mass was in the condensate; the bulk was recovered in the vapor. Mass removal rates peaked at 75 lb/day on September 21, 2004 (Day 76 of heating), when the average temperature in the treatment zone was 85°C (see Figure 5-6).

Average groundwater concentrations in the treatment zone fell from 49,000 µg/L of total VOCs before treatment to 120 µg/L of total VOCs after treatment, a reduction in concentration of 99.7%. Tables 5-1 and 5-2 show the groundwater analysis for select wells in the treatment zone in pre-existing wells (installed at the time of the pilot test) and in new wells (installed for the full-scale application). Although ten COCs were identified at this site, Tables 5-1 and 5-2 focus on the two main parent compounds (TCA and TCE) and their daughter products (1,1-DCA, *cis*-1,2-DCE, and VC). In many of the wells near heating cells 1 and 3, CVOC levels had already been considerably reduced during the pilot test. In these wells (P-5-1-MWS1, P-5-1-MWS3, P-5-1-MWS4, and P-5-1-MWS5), the CVOC levels were further reduced after ERH treatment, in some cases to non-detect levels. Rebound of contaminants was muted during the long-term monitoring in March 2005, indicating that most of the DNAPL had been removed from these regions.

Among the two new wells (1MW6S and 1MW7S) that are not in the former pilot-test area, 1MW6S had much higher initial CVOC levels (6,420 µg/L of TCA, 1,100 µg/L of TCE, and 25,676 µg/L of total CVOCs). In the first post-treatment sampling event on November 11, 2004, CVOC levels were considerably reduced, in some cases to below the detection limits. However, there was a relatively strong rebound in TCE and DCE levels (to 1,200 and 110 µg/L, respectively) by the time of the long-term monitoring event in March 2005. At this location in Array 5, there is the possibility of some post-treatment residual DNAPL. Monitoring well 1MW7S, located just outside heating cell 5, had relatively low levels of CVOCs (342 µg/L total CVOCs), mainly daughter products. These compounds persisted after the treatment (338 µg/L total CVOCs in November 11, 2004, sample), but had mostly disappeared by the March 2005 sampling round. This may indicate that enhanced biodegradation of CVOCs continued to occur at the still elevated temperatures after treatment.

Within heating cells 2 and 4, there are no monitoring wells and the CVOC treatment in these parts of the treatment zone could not be evaluated.

One of the monitoring wells (P-5-1-MWS4), located right outside array 2, became dry during the ERH application and could not be sampled during or after treatment (see Table 5-1). TWS-I-20 and TWS-I-21 are the two thermocouple points next to this location. In Figure 5-7, both these thermocouples show temperatures above 90°C. However, the time trends in Table 5-3 show that temperature increased at TWS-I-20 and TWS-I-21 (to 85 and 96°C, respectively) by October 11 and then decreased below the target 90°C level during the rest of the heat application. This may indicate that after drying occurred, heating efficiency decreased and temperatures dropped in this vicinity. Similar temperature drops (after initial sharp increases) are apparent at locations TWS-I-7 and TWS-I-8 too, both at 8 ft bgs and at 12 ft bgs (see Table 5-3). At other locations, such as TWS-I-9 and TWS-I-22, temperatures continued to increase throughout the heat application and were above 90°C when heating was stopped. At most locations, the temperature increased to levels above the boiling points of key compounds, such as TCA (65°C) and TCE (73°C), and stayed there for at least a few days. This would indicate that the heat treatment was relatively uniform throughout the target aquifer region.

Increasing chloride levels (see Table 5-1) is an indicator of anaerobic reductive dechlorination of CVOCs through enhanced biological activity at elevated temperatures, especially at the moderate temperatures prevalent during the initial heating and cooling phases. Sporadic increases in daughter products (e.g., *cis*-

1,2-DCE, VC, and 1,1-DCA) are evident in Tables 5-1 and 5-2, indicating sequential dechlorination of parent compounds (e.g., TCE and TCA). However, none of these daughter products appear to have accumulated in the groundwater, thus indicating that these daughter products were themselves dechlorinated by hydrolysis and microbial activity, or were volatilized and captured in the vapor recovery system.

5.7 Cost

Table 5-4 summarizes the total cost of the ERH application at Alameda as \$4,703,223. The “adjusted vendor cost” was \$2,690,723, which included mobilization, set-up, amortized equipment costs, operation, and power consumption. The amortized equipment cost was taken as \$833,333 assuming the total equipment cost of \$2,500,000 for re-usable equipment (such as power control units, refrigerated air dryer, electrical cable) would be shared across three sites.

5.8 Discussion

More than 3,000 lb of CVOCs were recovered during the ERH application at the Alameda site. Mass recovery rates in the captured vapor peaked at 75 lb/day on Day 76 (Week 11) of the 15 weeks of ERH application. At the peak mass recovery rate, the average temperature in the treatment zone was 85°C, with the temperature exceeding the 90°C target at several locations. At most locations where temperature was measured, temperatures increased to levels above the adjusted boiling points of TCE (73°C) and TCA (65°C) at some point in time and stayed there for at least a few days. At several locations, temperatures approached the normal boiling point of water (~100°C), thus indicating that steam stripping of CVOCs may have been a significant removal mechanism. One of the monitoring wells (P-5-1-MWS4) just outside Array 2 became dry during the ERH treatment and could not be sampled during or after treatment. The temperature at the nearest thermocouple locations (TWS-I-20 and TWS-I-21) initially rose to above 90°C. Subsequently, probably as drying occurred in this localized region, temperatures fell to below the target 90°C. At many other locations though, temperatures continued to increase beyond 90°C and had reached 100°C, when heating was stopped.

Average groundwater concentrations in the treatment zone fell from 49,000 µg/L of total VOCs before treatment to 120 µg/L after treatment, a reduction in concentration of 99.7%. In many of the wells near Arrays 1 and 3, CVOC levels had already considerably reduced after the pilot treatment. During the full-scale ERH application, these concentrations declined further, sometimes to below detection. Long-term monitoring four months after the end of ERH treatment did not show any substantial rebound of CVOC concentrations, thus indicating that DNAPL had mostly been removed from these regions.

In the single monitoring well (1MW6S) in Array 5, where ERH was applied for the first time during full-scale application, groundwater sampling immediately after ERH treatment showed considerable reduction of the main parent compounds (TCE and TCA) and their daughter products (*cis*-1,2-DCE, VC, and 1,1-DCA). However, four months later, there was considerable rebound in CVOC levels in this well, thus indicating that some DNAPL probably remains in the aquifer at this location. There are no monitoring wells in Arrays 2 and 4, so the CVOC removal efficiency in these locations could not be determined.

Increased chloride levels were observed in several wells, thus indicating that biological and abiotic reductive reactions were being enhanced at the higher temperatures. Sporadic increases in daughter products (*cis*-1,2-DCE, VC, and 1,1-DCA) are evident in some wells at some points in time, but none of these byproducts appear to have accumulated in the groundwater to any great degree. This seems to indicate that degradation of CVOCs was potentially going to completion.

Subsequent sampling events completed by Arizona State University (ASU) showed minimal rebound at the Alameda site as of June of 2006. The ASU data shows that even in the one monitoring well (1MW6S in Heating Cell 5) where there were some signs of a TCE and DCE rebound in March 2005 (4 months after heating was stopped in November 2004), there is evidence that concentrations of these CVOCs eventually subsided. The direct-push, multi-level sampling by ASU confirms that only very low levels of CVOCs remain in the treated zone. This continued treatment of CVOCs, after heating has stopped, is a useful feature of ERH application. As the post-ERH aquifer cools, continued volatilization, hydrolysis, and biodegradation results in further decline in CVOC concentrations. Continued biodegradation was also aided by the fact that at higher temperatures, dissolved oxygen is driven out of the groundwater making the system anaerobic (as indicated by the low ORP and DO in the ASU samples). This indicates that any DNAPL remaining in Heating Cells 1, 3, and 5 is most likely minimal. There are no monitoring wells in Heating Cells 2 and 4, so the ERH effectiveness in those cells is difficult to determine.

Table 5-1. Groundwater Parameters in Existing Wells at ERH Site (Page 1 of 2)

Sample ID	P-5-1-MWS1									
	9 to 14									
Screened Interval (ft bgs)	04/19/02	06/12/03	10/30/03	12/17/03	05/10/04	10/14/04	11/10/04	03/14/05		
Sample Date										
Chloride (mg/L)	2,100	NS	NS	NS	NS	NS	NS	NS	NS	NS
TDS (mg/L)	3,570	3,720	NS	NS	NS	NS	NS	NS	NS	NS
1,1,1-Trichloroethane	25,000	ND<83	90	190	4,120	0.68J	ND<1	ND<1	ND<1	ND<1
1,1-Dichloroethane	5,800	3,800	2,680	2,630	4,630	0.55J	0.24J	ND<1	ND<1	ND<1
cis-1,2-Dichloroethene	220	630	470	410	710	0.67J	3.6	ND<1	ND<1	ND<1
Trichloroethene	1,600	3,900	1,640	1,200	1,570	0.96J	1.3	ND<1	ND<1	ND<1
Vinyl Chloride	97	500	60	270	4,730	ND<1	0.48J	ND<0.5	ND<0.5	ND<0.5
Total COC Concentration	34,517	32,057	7,284	8,412	23,166	4.3	8.3	0	0	0
Sample ID	P-5-1-MWS3									
Screened Interval (ft bgs)	10 to 15									
Chloride (mg/L)	3,200	—	NS	NS	NS	NS	NS	NS	NS	NS
TDS (mg/L)	5,740	—	NS	NS	NS	NS	NS	NS	NS	NS
1,1,1-Trichloroethane	42,000	—	264,000	261,000	150,000	39	9.2	1.2	1.2	1.2
1,1-Dichloroethane	3,400	—	22,000	20	20,400	6.7	3.5	0.2J	0.2J	0.2J
cis-1,2-Dichloroethene	ND<170	—	ND<10,000	1,600	700	130	170	1.2	1.2	1.2
Trichloroethene	1500	—	10,000	9,300	7,500	57	33	3.6	3.6	3.6
Vinyl Chloride	ND<170	—	ND<10,000	900	410	6.1	8	ND<0.5	ND<0.5	ND<0.5
Total COC Concentration	47,900	—	316,000	286,320	189,510	285	277	10.6	10.6	10.6
Sample ID	P-5-1-MWS4									
Screened Interval (ft bgs)	10 to 15									
Chloride (mg/L)	2,600	—	NS	NS	NS	NS	NS	NS	NS	NS
TDS (mg/L)	4,470	—	NS	NS	NS	NS	NS	NS	NS	NS
1,1,1-Trichloroethane	4,000	—	47	10	24	NP	NP	NP	NP	NP
1,1-Dichloroethane	8,500	—	251	160	204	NP	NP	NP	NP	NP
cis-1,2-Dichloroethene	1,200	—	525	292	91	NP	NP	NP	NP	NP
Trichloroethene	880	—	225	63	4J	NP	NP	NP	NP	NP
Vinyl Chloride	470	—	238	291	980	NP	NP	NP	NP	NP
Total COC Concentration	15,974	—	1,735	1,112	1,384	NP	NP	NP	NP	NP

Table 5-1. Groundwater Parameters in Existing Wells at ERH Site (Page 2 of 2)

Sample ID	P-5-1-MWS5										
	Screened Interval (ft bgs)	9.5 to 14.5									
Sample Date	04/19/02	06/12/03	10/30/03	12/17/03	05/10/04	10/14/04	11/10/04	03/14/05			
Chloride (mg/L)	1,100	—	NS	NS	NS	NS	NS	NS	NS	NS	NS
TDS (mg/L)	2,380	—	NS	NS	NS	NS	NS	NS	NS	NS	NS
1,1,1-Trichloroethane	12	—	ND<10	ND<5	ND<5	ND<1	ND<1	ND<1	ND<1	ND<1	ND<1
1,1-Dichloroethane	160	—	62	100	77	3.6	ND<1	ND<1	ND<1	ND<1	ND<1
cis-1,2-Dichloroethene	3	—	110	170	73	70	0.63J	ND<1	ND<1	ND<1	ND<1
Trichloroethene	7.1	—	21	13	9	16	0.52J	ND<1	ND<1	ND<1	ND<1
Vinyl Chloride	17	—	6	15	298	17	0.37J	ND<0.5	ND<0.5	ND<0.5	ND<0.5
Total COC Concentration	203	—	324	902	600	137	2.2	0	0	0	0
Pre-Start-Up Pilot Test/Full-Scale Sampling Event											
Six Phase Heating (SPH) Operational Pilot Test/Full-Scale Sampling Event											
Post-Pilot Test/Full-Scale Operations Sampling Event											

Table 5-2. Groundwater Parameters in New Wells 6S and 7S

Sample ID		1MW6S				
Screened Interval (ft bgs)		9.5 to 14.5				
Sample Date	12/18/03	05/10/04	10/14/04	11/11/04	03/16/05	
1,1,1-Trichloroethane	6,420	5,220	16	ND<10	ND<10	
1,1-Dichloroethane	7,950	48,800	330	ND<10	ND<10	
<i>cis</i> -1,2-Dichloroethene	5,520	13,700	1,900	53	110	
Trichloroethene	1,100	990	860	7.8J	1,200	
Vinyl Chloride	1,400	8,140	180	4.6J	ND<5	
Total COC Concentration	25,676	92,250	3,424	82	1,414	
Sample ID		1MW7S				
Screened Interval (ft bgs)		9.0 to 14.0				
1,1,1-Trichloroethane	8	8	ND<1	ND<10	ND<1	
1,1-Dichloroethane	138	87	0.93J	9J	1.7	
<i>cis</i> -1,2-Dichloroethene	5	23	51	200	4	
Trichloroethene	33	52	12	17	4.7	
Vinyl Chloride	35	80	5.6	100	3.8	
Total COC Concentration	274	342	90	338	18	

Pre-Start-Up Pilot Test/Full-Scale Sampling Event

SPH Operational Pilot Test/Full-Scale Sampling Event

Post-Pilot Test/Full-Scale Operations Sampling Event

Table 5-3. Subsurface Temperatures (°C) at ERH Site

Thermal Well ID	Temperatures at 8 ft Depth																			
	9-Aug-04	16-Aug-04	23-Aug-04	30-Aug-04	7-Sep-04	13-Sep-04	20-Sep-04	27-Sep-04	4-Oct-04	11-Oct-04	18-Oct-04	25-Oct-04	1-Nov-04	8-Nov-04	15-Nov-04	22-Nov-04	6-Dec-04	20-Dec-04	4-Jan-05	17-Jan-05
TWS-I-3	25.9	33.6	49.0	70.5	87.4	82.2	83.4	77.4	77.2	81.5	92.9	99.3	99.8	91.3	83.4	75.1	69.3	62.2	55.2	48.9
TWS-I-4	37.7	50.6	56.9	57.9	92.3	89.2	88.4	87.9	83.1	85.2	91.3	95.2	100.1	91.4	81.9	74.1	65.6	57.0	48.3	44.1
TWS-I-6	30.8	48.5	61.9	94.8	92.8	92.8	92.5	94.3	90.9	88.7	86.7	85.4	80.2	71.7	64.0	62.0	53.4	45.7	31.5	27.6
TWS-I-7	41.3	49.5	55.5	75.4	80.3	90.4	86.9	79.2	66.4	64.9	57.7	58.6	54.1	52.2	49.3	43.1	37.8	31.8	25.5	23.8
TWS-I-8	92.5	99.5	99.6	99.5	89.2	62.2	45.0	36.1	35.1	35.2	31.1	24.3	21.4	21.5	20.0	20.2	16.7	16.5	13.7	13.0
TWS-I-9	34.9	34.0	48.5	91.4	87.4	88.2	89.4	81.2	91.5	92.2	89.2	99.8	98.9	97.8	89.7	85.7	70.7	60.5	42.3	32.3
TWD-I-14	24.5	26.6	31.7	28.3	34.0	33.1	39.2	60.7	70.4	82.4	91.0	89.7	97.4	99.5	95.4	90.0	87.2	78.7	74.8	68.4
TWS-I-20	43.6	35.5	49.1	63.0	77.4	82.3	80.3	71.6	81.3	84.9	84.2	66.2	62.6	65.3	65.2	65.1	55.0	50.7	39.1	21.3
TWS-I-21	39.5	42.5	61.5	84.3	88.9	86.3	83.3	92.7	87.1	96.4	63.4	70.4	68.0	72.7	50.9	59.7	59.5	43.5	31.1	18.8
TWS-I-22	35.9	46.1	68.8	86.6	96.1	87.6	91.3	88.4	86.1	82.7	93.4	100.0	100.4	94.8	83.9	73.6	61.6	50.9	40.5	23.9
TWS-N-3	35.0	54.2	55.7	93.9	93.2	91.2	87.7	79.2	66.9	65.8	57.1	43.2	38.6	33.7	29.6	29.1	26.2	22.8	16.0	18.6
Temperatures at 12 ft Depth																				
TWS-I-3	38.5	42.9	54.7	78.4	92.0	90.6	87.2	89.2	91.1	96.7	99.8	99.6	100.0	100.1	94.1	87.5	82.6	75.1	67.4	60.5
TWS-I-4	54.3	59.0	72.5	75.4	98.1	94.1	94.8	95.4	94.8	95.1	96.1	101.0	100.6	99.8	93.1	84.2	78.8	69.2	60.3	54.7
TWS-I-6	61.3	90.1	97.5	97.8	97.3	97.6	98.8	99.9	99.6	99.3	99.4	95.2	100.8	86.2	80.5	74.5	68.8	57.3	43.6	36.3
TWS-I-7	71.8	92.5	98.7	99.1	98.8	96.7	95.2	99.8	96.5	100.5	95.7	74.8	68.8	72.7	59.7	53.3	47.0	40.6	34.5	32.1
TWS-I-8	100.4	100.1	100.2	100.0	88.1	62.3	44.0	38.8	34.7	32.5	31.2	28.0	27.5	27.9	25.2	24.5	21.3	20.7	18.2	17.1
TWS-I-9	62.5	49.9	76.9	98.1	95.7	99.4	101.3	94.9	94.4	100.9	96.6	99.9	99.0	100.0	98.9	94.5	78.8	67.6	49.4	39.8
TWD-I-14	23.2	29.2	33.0	30.5	36.1	34.5	41.7	46.3	60.6	80.8	96.8	95.9	100.8	99.5	97.7	97.2	96.8	90.1	85.2	79.8
TWS-I-20	38.6	42.5	54.9	63.8	94.2	93.1	91.4	99.2	99.6	99.4	97.5	81.9	82.0	84.5	81.5	77.8	70.6	64.3	52.2	45.0
TWS-N-3	56.4	76.8	93.2	99.6	99.6	99.2	96.9	84.9	71.8	63.1	54.5	44.6	44.7	40.0	36.9	35.1	31.9	28.1	23.5	24.2

Table 5-4. Electrical Resistance Heating Costs at Alameda Point

Item	Basis	Cost (\$)
Design, planning	Work Plan, SAP, HASP, QC Plan, Procurement, Meetings, Data Investigation and Design, and Removal Design	\$1,262,500
Vendor Cost		
Mobilization, setup		\$410,800 ^(a)
Equipment		\$833,333 ^(a)
Operation	07/08/04 to 11/05/04 Costs included here include management of the entire project which in addition to system operation	\$1,169,445
Power consumption	1,500,000 kW-Hrs	\$277,145
Demobilization	Not available	NA
	Adjusted Vendor Cost	\$2,690,723^(b)
Site Incurred Cost		
Site preparation	Included in mobilization/setup	\$0
Waste disposal	Not available	\$0
Monitoring and performance assessment	Groundwater sampling and analysis and final reports	\$750,000
	Site Incurred Cost	\$750,000
	Total Cost	\$4,703,223

Note:

- (a) The total mobilization, setup, and equipment cost was reported as \$2,910,800. Out of this value, \$2,500,000 was for the procurement of equipment deemed to be re-usable by the vendor. This equipment cost was subtracted from the total mobilization and set-up cost for a remaining value of \$410,800. The \$2,500,000 equipment cost was then amortized across three sites (e.g. assuming the equipment would be used at three sites minimum) to arrive at \$833,333.
- (b) The Adjusted Vendor Cost includes mobilization/set-up, equipment costs amortized over three sites, operation, and power consumption. It does not include design/planning costs.

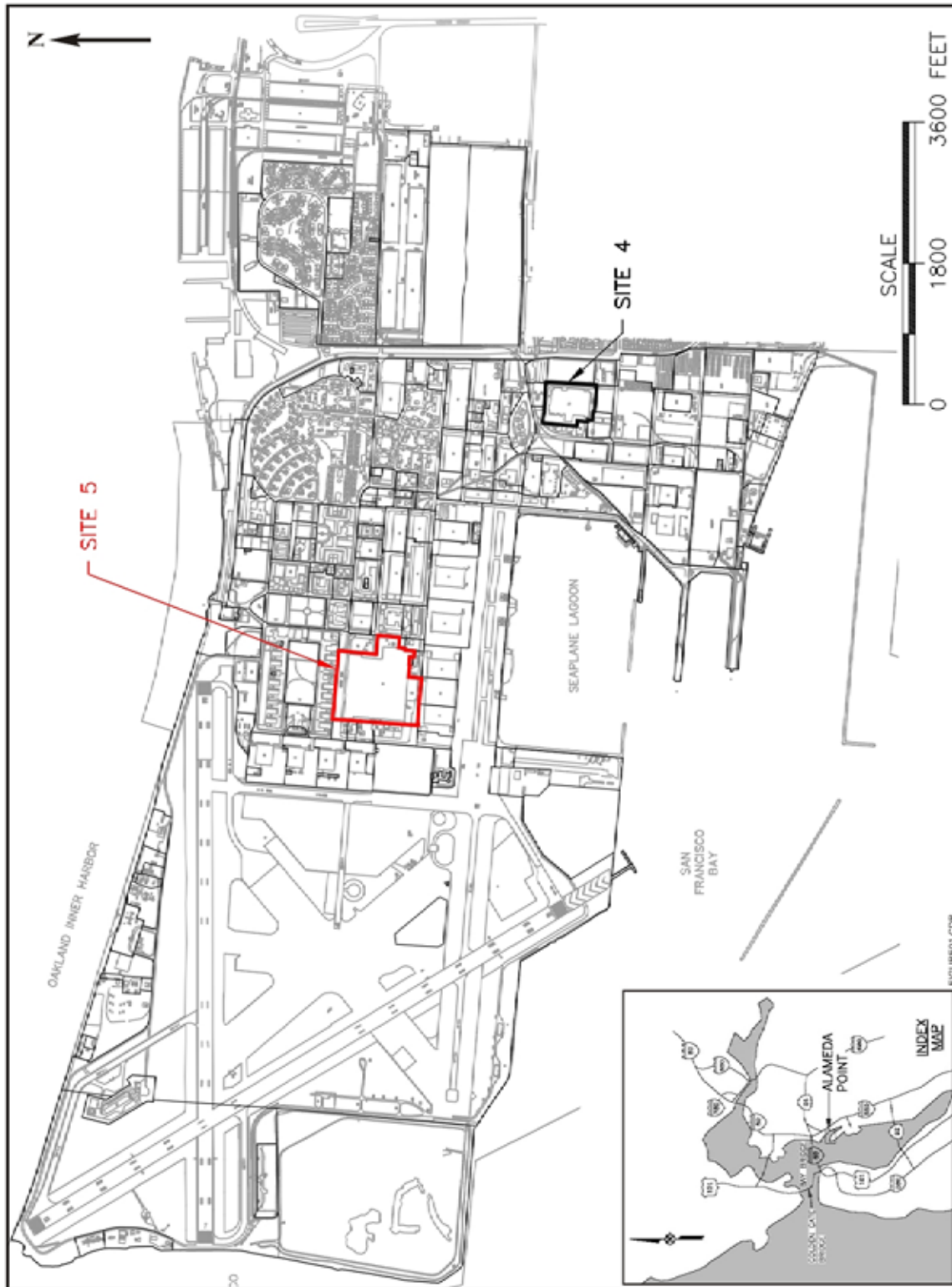
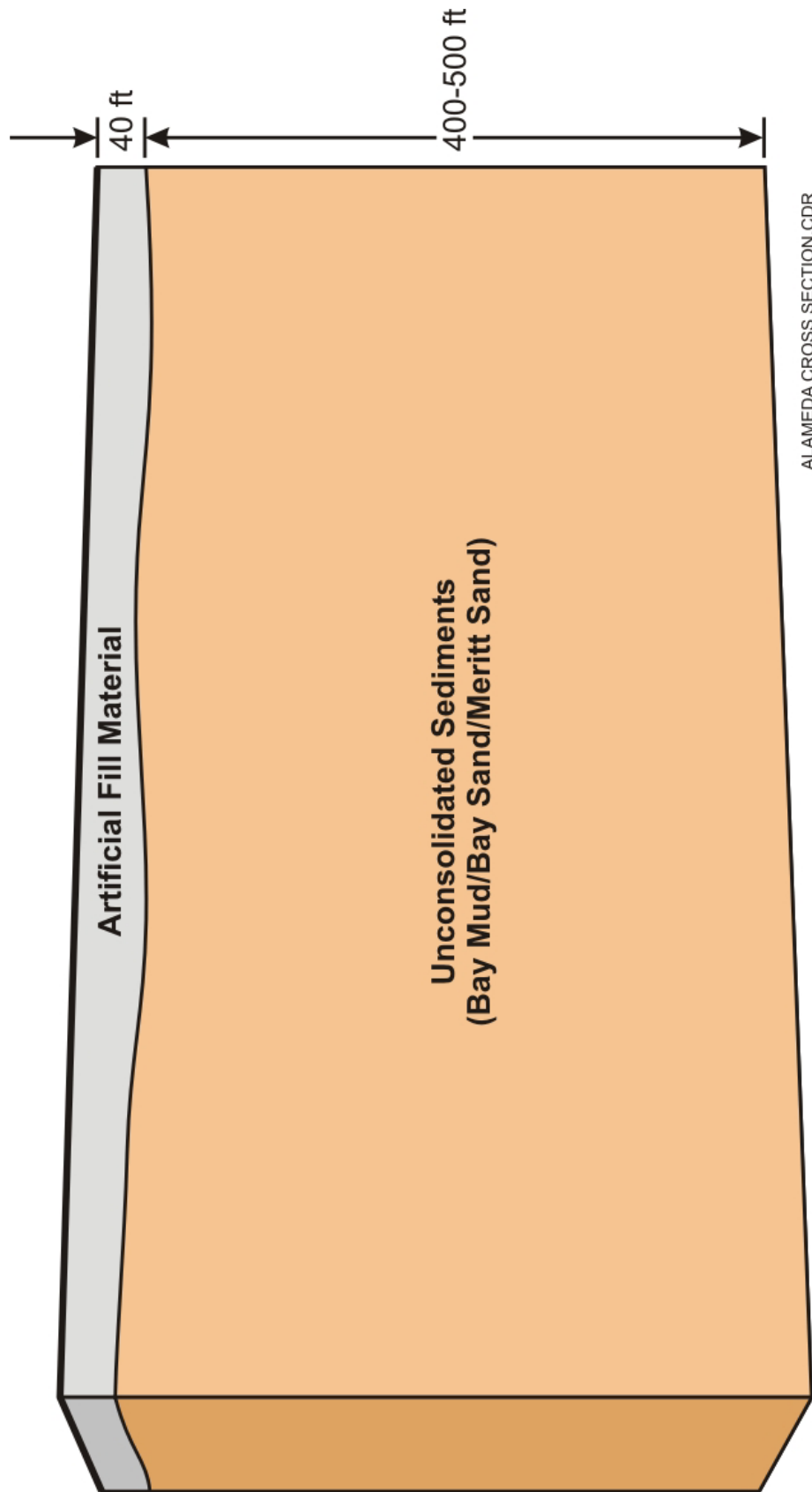

Figure 5-1. Site 5 Location at Former NAS Alameda



ALAMEDA CROSS SECTION.CDR

Figure 5-2. Geological Cross-Section at Site 5

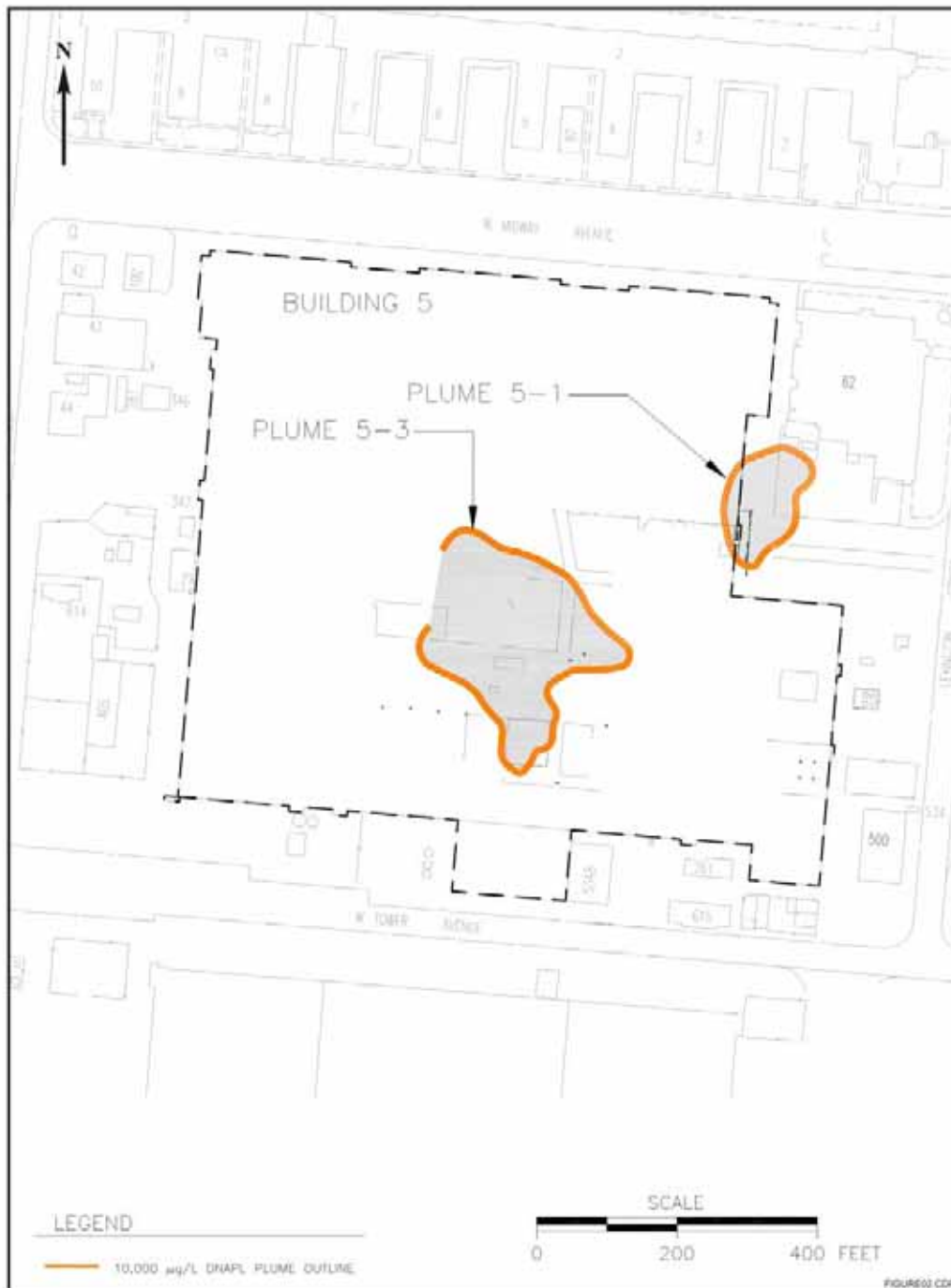

Figure 5-3. Site 5 CVOC Plumes Location

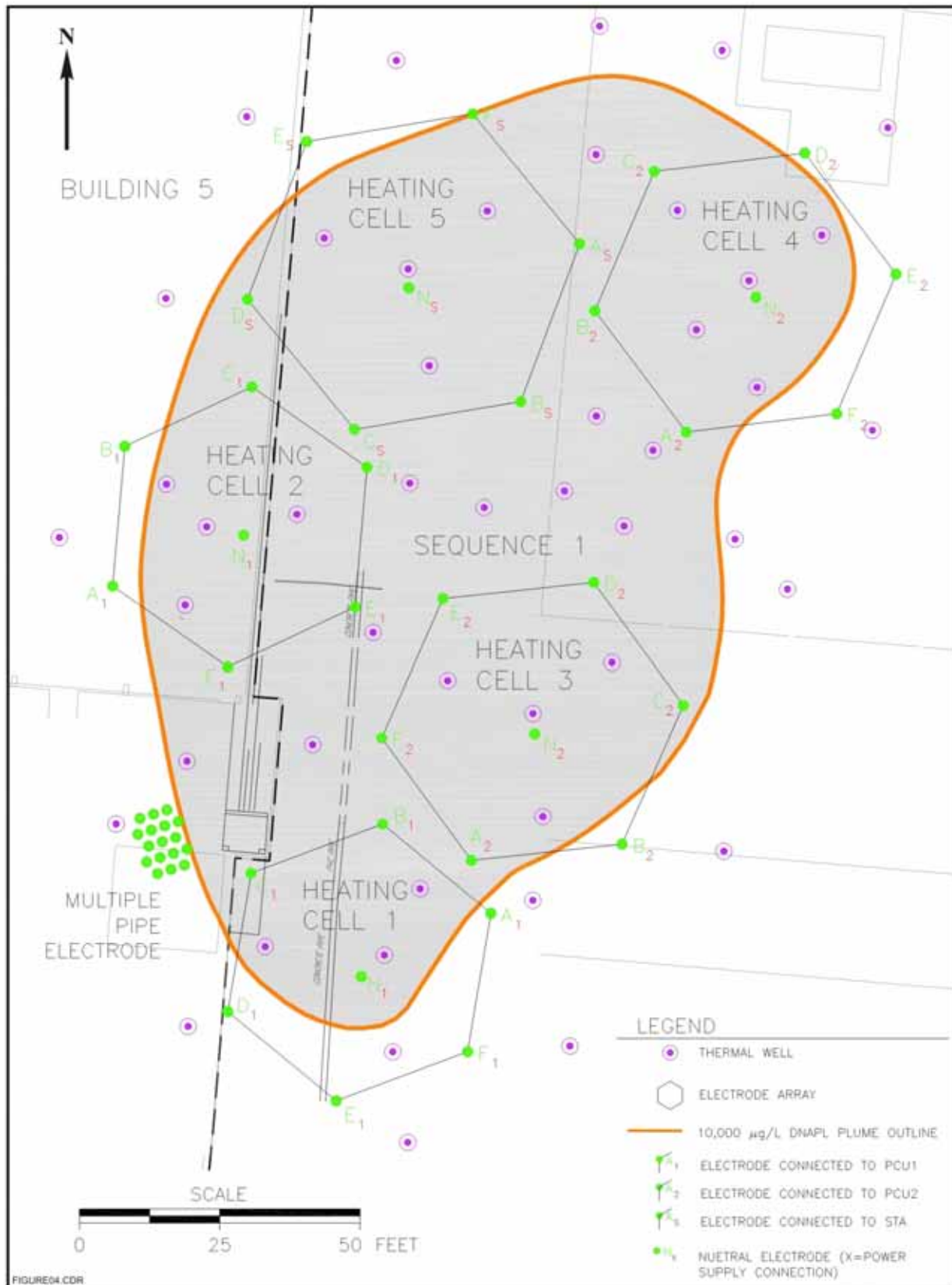

Figure 5-4. Layout of ERH Electrode and Thermocouple Arrays in CVOC Plume

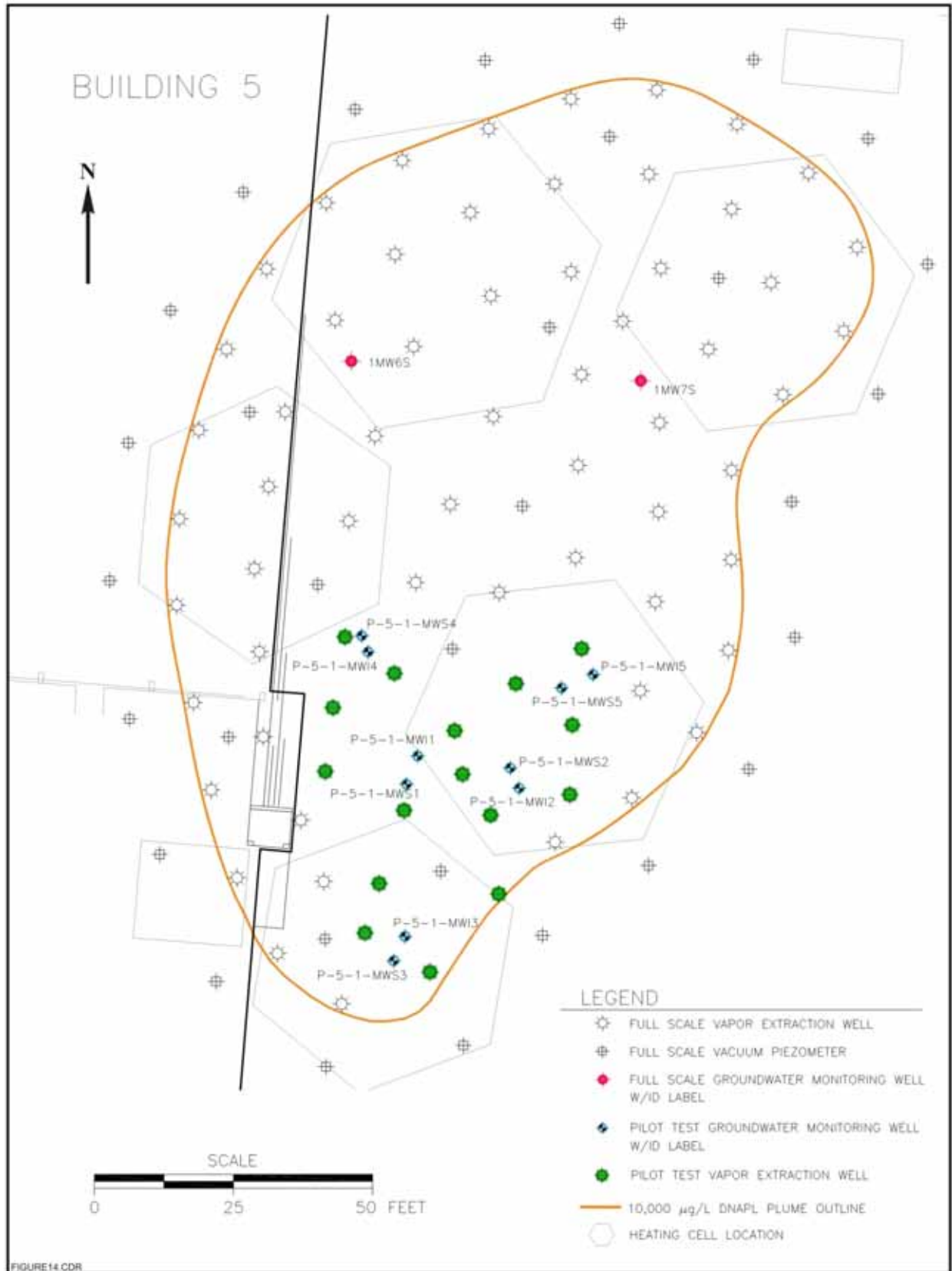

Figure 5-5. System Layout

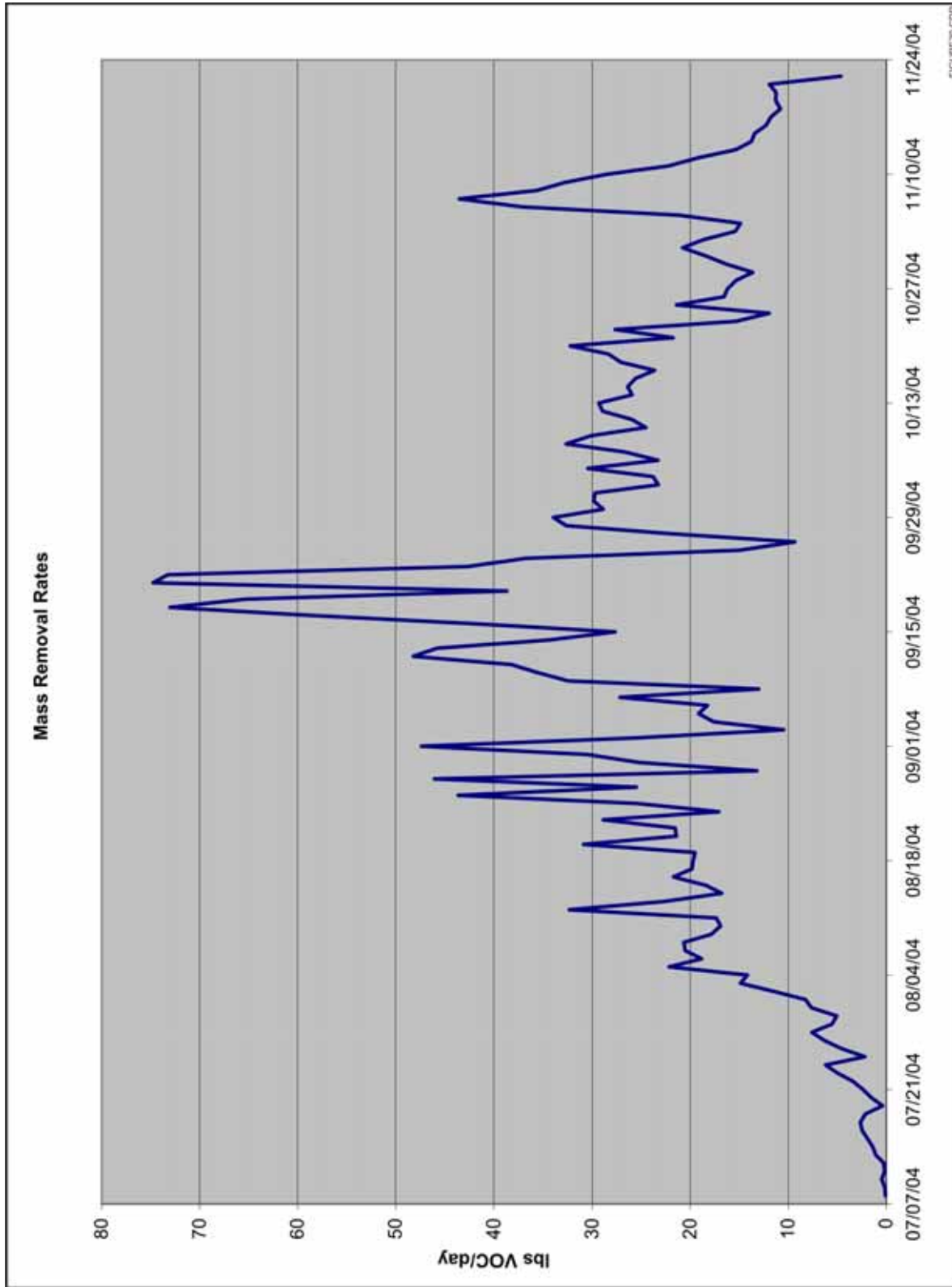
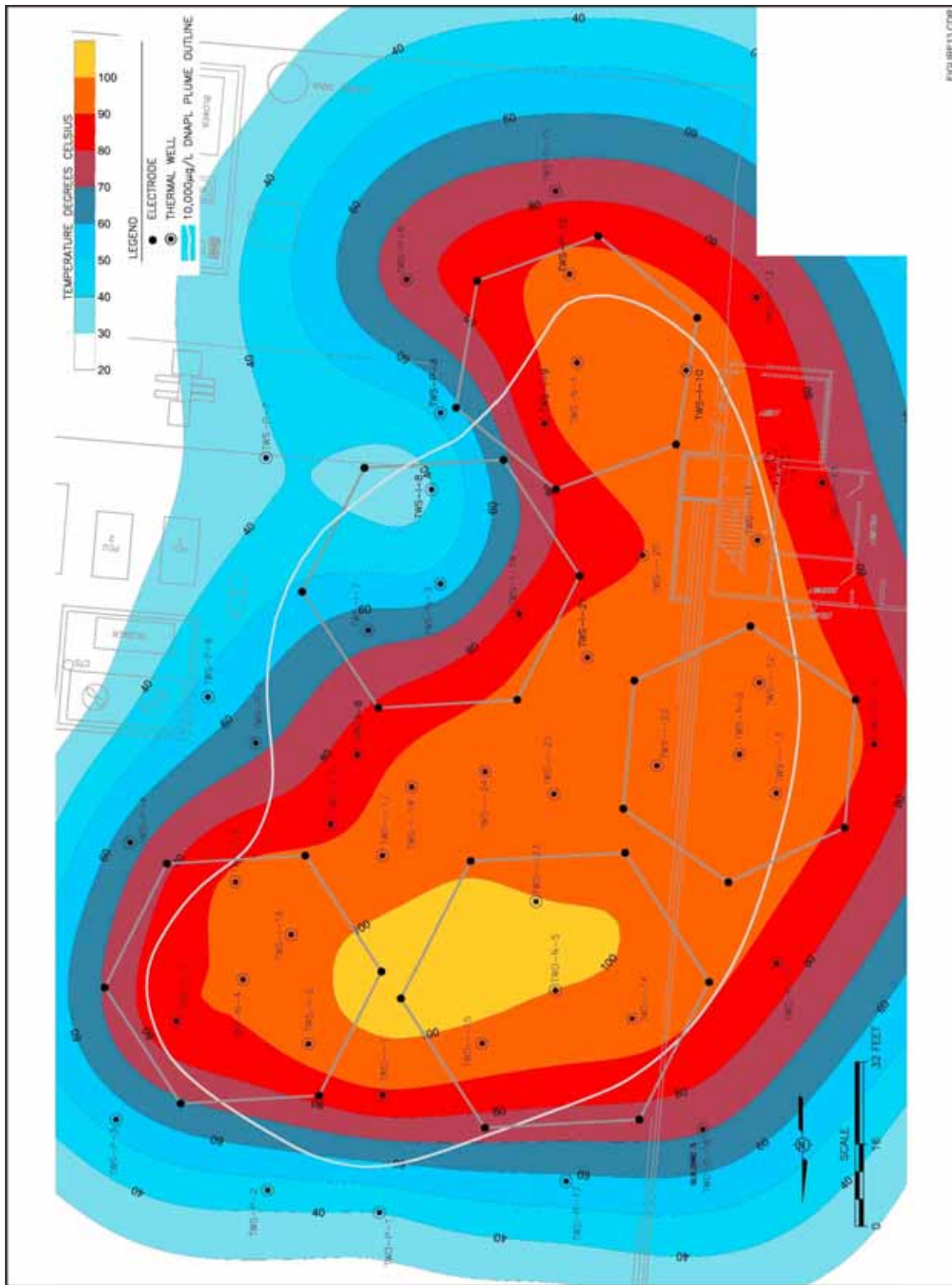

FIGURE 5-6

Figure 5-6. CVOC Mass Removal Rates



Section 6.0: ERH APPLICATION AT MCB, CAMP LEJEUNE

6.1 Introduction

Site 89, the former Defense Reutilization Marketing Office (DRMO), is located at the Camp Geiger portion of MCB Camp Lejeune (Figure 6-1). The site is surrounded by Edwards Creek to the west and south, while a railroad and a gravel road adjoins the site to the east. Prior to DRMO operations, the area had multiple uses as a vehicle maintenance yard, vehicle storage lot, and a staging/storage area for fuel bladders. Very high levels of 1,1,2,2-tetrachloroethane (PCA), and TCE were detected in the groundwater and soil. Subsequent investigations also indicated the presence of DNAPL below the water table in the southern portion of the site.

6.2 Geology and Hydrogeology

Three hydro-stratigraphic units have been identified at Site 89: the undifferentiated formation (surficial aquifer), Belgrade formation (Castle Hayne confining unit), and River Bend formation (Castle Hayne aquifer) (Figure 6-2).

- The undifferentiated formation occurs at a depth of approximately 5 feet bgs. It consists of fine sand and fine to medium sand layers interbedded with silt and clay layers. The general direction of shallow groundwater flow in the surficial water bearing zone within the undifferentiated formation is south-southeast.
- The Belgrade formation (Castle Hayne confining unit) begins at a depth of approximately 8 to 15 feet bgs. The unit is distinguished by its olive green/gray color, presence of shell fragments, and a decrease in moisture content. Cross-sections illustrate that the Belgrade formation is predominantly a clay formation in the western and central portions of the site, and is a fine silty sand or silt elsewhere. There are also several portions of the site where the Belgrade formation appears to be absent altogether.
- The River Bend formation (upper portion of the Castle Hayne aquifer) begins at a depth of approximately 14 to 20 feet bgs. This unit is distinguished by the presence of calcareous sands, shell fragments, and fossil fragments. The upper portion of the Castle Hayne aquifer is comprised of interbedded fine to medium sand, shell and fossil fragment layers and calcareous silt and clay layers. Another confining layer within the Castle Hayne aquifer is present beginning at a depth of approximately 38 feet bgs.

The geologic formation indicates a definite hydraulic connection between the surficial aquifer and the underlying Castle Hayne aquifer. This connection is likely attributable to the discontinuous nature of the Castle Hayne confining unit rather than hydraulic conductivity through the unit.

The water table occurs at a depth of 3 to 5 ft bgs. The general groundwater flow direction is south-southwest with an approximate hydraulic gradient of 0.01 ft/ft. Near artesian conditions were present in some parts of the ERH treatment.

6.3 Contamination Distribution

Of all the VOCs detected at Site 89, TCE and PCA were the most prevalent. Transformation (reduction) byproducts of PCA, such as 1,1,2-TCA, TCE, *cis*-1,2 DCE, and *trans*-1,2 DCE, were identified in noticeable amounts. Byproducts of TCE degradation, such as *cis*-1,2 DCE and VC, also were detected. Other contaminants, such as benzene and toluene, were identified at this site but in very low concentrations. DNAPL-level concentrations in the groundwater were detected in two separate DNAPL

source zones: one located in the central portion of the study area (eastern plume) and the other located in the western portion of the study area (western plume) (Figure 6-1). Contaminant concentrations were higher in the eastern plume; therefore, the ERH technology was applied in the eastern plume only. Within the eastern plume, PCA concentrations ranged from 650 ppm in some soil samples to 21,250 ppm. Significant concentrations of TCE ranging from 33 ppm to 11,100 ppm were also detected in the soil samples collected from the central portion of the site (eastern plume). Site investigations concluded that a separate-phase DNAPL was encountered between 5 and 19 ft bgs, and was assumed to be perched on discontinuous, lower permeability layers within the Belgrade unit. The heaviest contamination appeared to exist at approximately 10 ft bgs. Figure 6-2 depicts the vertical extent of the DNAPL contamination. No DNAPL was identified in the Castle Hayne aquifer although relatively high dissolved phase concentrations extended to approximately 26 ft bgs (Figure 6-2).

6.4 Technology Implementation

ERH technology was implemented in the eastern plume using three-phase electricity delivered to an array of 91 electrodes (48 shallow and 43 deep) and vapor recovery vents (Figure 6-3). The target treatment area was 15,900 sq ft and the approximate treatment volume (assuming 22 ft of heated aquifer thickness) was 349,800 ft³. Steel electrodes were installed in a triangular grid pattern using hollow stem auger drilling techniques. Instead of using sand to backfill around the electrode (as used in conventional well installation), an electrically conductive material (such as graphite or steel pellets) was used as backfill. Electrical power was applied to the subsurface through the electrodes. As the soil was heated, the contaminants in the treatment zone were driven to the vapor phase and recovered by the SVE wells.

A deep electrode interval (at 21 to 26 ft bgs) was operated to form a hot floor along with upper shallow electrodes (at 4 to 19 ft bgs) along the perimeter of the plume to create a hot wall prior to heating the contaminated interior. Isolation of the upper portion of the electrodes prevented foil heating in the upper reaches of the subsurface. The deep electrodes went as deep as 6 ft into the Castle Hayne aquifer to produce a hot floor. Rising hot water and steam from the heated floor also created a net upward flow, minimizing dissolved-phase contamination from penetrating the Castle Hayne aquifer as the source zone in the Belgrade was heated.

Completing the subsurface installation were 17 horizontal vapor extraction wells installed under an impermeable and thermally insulated site cap. In addition to these, 10-foot long horizontal wells were installed below a site cap to prevent vapors or steam escaping from the treatment area. The horizontal wells were placed between 20 and 30 feet apart. At site 89, the pilot test used three different vacuum recovery devices to recover steam and organic vapors: horizontal wells, shallow electrode vents, and the deep electrode vents. Selected shallow and deep electrodes were slotted so that steam and vapors can be recovered.

To manage subsurface pressures, some electrodes were incorporated with a well screen to intercept and capture steam and contaminant vapors as they were generated. Also, 25 deep vents were made operative to collect steam and hot water along the periphery of the heated volume. Selected shallow electrodes also incorporated a metal well screen to capture steam and vapors throughout the Belgrade unit. Each shallow electrode was also equipped with a drop tube to enable groundwater extraction for hydraulic control. The drop tube was operated below the groundwater surface to assist in contaminant removal and containment.

The recovered contaminated steam was condensed in a heat exchanger and the condensate was stored in a temporary 21,000-gallon tank for sampling and appropriate treatment or disposal. The non-condensed vapor, containing most of the contaminant mass, was treated by a CATOX unit. An average of 10,000 gal of water was recovered daily during ERH operation, either as steam condensate or as groundwater

recovered in entrainment tubes in the shallow electrodes. Approximately 500 gal/day of this recovered water was returned to the electrodes to prevent drying and maintain conductivity around the electrodes.

ERH application started when power was turned on to the system on September 11, 2003, and was finally shut down on May 11, 2004, a total period of approximately 8 months. The system was shut down from September 15 to September 22, 2003, due to Hurricane Isabelle. A few other minor shutdowns were experienced due to equipment maintenance and replacement, but for the most part during this period (75% of the time), the system was operational (total of 173 days ERH application over 225 total days of operation). Heating was first focused on the “hot floor” (deeper zones) to prevent downward migration of DNAPL and create an upward buoyancy to the vapors generated. Initial heating also focused on the “hot wall” or the perimeter of the treatment zone at shallow and intermediate depths. Subsequently, the inside of the treatment zone was heated. Therefore, heating progressed in a “bottom-to-top” and “outside-to-in” mode.

6.5 Performance Evaluation Approach

6.5.1 Subsurface Temperature And Vapor Monitoring

Fourteen thermocouple wells co-located with vapor monitoring piezometers containing TMPs located at 5, 10, 15, 20, and 25 ft bgs for a total of 75 TMPs were used to monitor the subsurface temperature. Four of the thermocouple wells (TMWs) were located in the center of each array (TMW-2, -6, -10, and -14), four were located in the “hot wall” area near the deep electrodes (TMW-1, -3, -11, and -12), and four were located outside of the treatment area (sentry TMW-4, -5, -9, and -13). Two additional TMWs (TMW-7 and -8) were centrally located in the treatment region. These locations were chosen to ensure that the ERH system was heating the site properly and to identify areas where steam/hot water migration may occur.

6.5.2 Groundwater Monitoring

Prior to system start-up, baseline groundwater samples were collected from each of the 27 monitoring wells at the site. During pilot test operations, groundwater samples were collected from the 27 monitoring wells when the subsurface temperature in the treatment zone reached 30°C, 60°C, and 100°C to monitor contaminant concentrations in and around the treatment zone. Shallow wells screened at 5-15 ft bgs (MW-16, -17, -21, -24, and -25) and intermediate wells screened at 20-25 ft bgs (MW-16IW, -17IW, -21IW, -24IW, and -25IW) were installed inside the treatment area. Wells were also installed outside the treatment zone along the perimeter (MW-18, -19, -20, -22, -23, -26, -27, -28, -29, and -31).

6.5.3 Air Monitoring

Ambient air monitoring using an Infrared Spectrophotometer (MIRAN) was used to provide continuous downwind monitoring for PCA, TCE and vinyl chloride. In addition, a Flame Ionization Detector was used to monitor for VOCs at working locations and on occasion at the perimeter of the project site. At start-up and once a month thereafter, eight-hour composite samples were collected upwind, downwind, and adjacent to the system using Summa canisters with a time flow gauge.

6.5.4 System Monitoring

All field data, including subsurface temperatures, pressures, blower, condenser, and system interlock status, electrode currents and voltages, and all input power load and energy parameters were monitored remotely via high-speed modem communication. All power system parameters were also controlled remotely. The electrodes were equipped with a control valve, pressure monitoring port, and sample port.

Once the initial voltage was set and power was being applied to the ground, a local or remote operator collected subsurface temperature data and power input at a minimum of three times per week. A local operator also collected operation information from the SVE system at a minimum of three times per week.

6.6 Technology Performance

The ambient water temperature was approximately 20°C when the ERH application began on September 11, 2003. As the heating progressed, the **average water temperature** in the treatment zone increased gradually to:

- 30°C on November 20, 2003, after 10 weeks of heating
- 60°C on December 9, 2003, after 12 weeks of heating
- 100°C on April 6, 2004, after 29 weeks of heating.

Figures 6-4 to 6-8 show the temperatures during key stages of heating (Current Environmental Solutions, 2004). The light blue line in these figures tracks the average temperature in the treatment zone. The dark blue or purple line is the temperature in the thermocouple TMW-7, located centrally in the treatment zone. The red line shows the hot floor (deep electrode) thermocouple temperatures. Figure 6-4 is an early temperature profile taken six weeks after heating was initiated. Figure 6-5 shows the temperature profile when the adjusted boiling point of TCE (73°C in water at 1 atm) was **first** reached in the treatment zone on December 19. Figure 6-6 shows the temperature profile when the adjusted boiling point of PCA (94°C in water at 1 atm) was **first** exceeded on January 19. Figure 6-7 shows the temperature profile when the normal boiling point of water was **first** exceeded on January 30. Finally, Figure 6-8 shows the temperature profile 10 days before the ERH application was stopped. The lines showing the changes in boiling points at various depths are based on the increased pressures (above 1 atm) exerted by the column of water above. The boiling points of TCE and PCA have been adjusted downward from their normal boiling points (boiling points of the pure compounds at 1 atm) because TCE and PCA form an azeotropic minimum with water. In effect, this means that a mixture of water and TCE (for example) will boil at temperatures below the boiling point of either water or TCE. In an azeotropic mixture, each component of the mixture exerts a partial pressure greater than that of the pure component, as the attraction among molecules of the mixture is weaker than the attraction of the molecules in the pure components.

Because of this effect, the ERH vendors project that at 1 atm (the pressure typically occurring at the water table) TCE in aqueous solution will boil at a minimum temperature of 73°C instead of at its normal boiling point of 87 °C. The projected minimum boiling point of PCA in aqueous solution at 1 atm is 94°C (versus its normal boiling temperature of 147°C. Formation of an azeotrope is particularly important for thermal recovery of PCA, which has a higher normal boiling point than water. Azeotropic distillation probably occurs in the miscible portion of the solvent-water system, as most chlorinated solvents are only sparingly soluble in water. In the non-miscible portion of the system, where the parent solvents (PCA and TCE) may be present as separate phases from water, these solvents can still be made to boil or vaporize at temperatures below the boiling point of either water or the solvent by steam distillation (co-distillation with water). Therefore, it is important to increase solvent removal efficiency from the subsurface so steam generation temperatures be reached.

These adjusted boiling points (of the azeotropes) increase progressively at increasing depth under the water table, as the water column above exerts its own pressure causing the total pressure to exceed 1 atm and this effect is evident in the boiling point lines in Figures 6-4 to 6-8.

As with the ERH application at the other four sites, the temperature profiles show a hump at an intermediate depth, indicating that heating progressed most rapidly at these depths. Figure 6-8 shows that

water boiling temperature was reached mostly at depths of 5 to 20 ft bgs. Below 20 ft bgs, the temperature profiles curve inward, indicating that boiling temperatures were not reached at some of the deeper locations. At a depth of 19 ft bgs, where site characterization had shown much of the DNAPL to be located, water boiling temperatures were reached in the centrally located wells (light and dark blue lines), but not in the hot wall area near the deep electrodes (red line). One possible explanation for the lower recorded temperatures nearer the electrodes could be that cooler water added at the electrodes to prevent drying was mixing with heated water. Similarly, a possible explanation for the relatively cooler temperatures at the bottom of the target treatment zone in all profiles could be due to influx of cooler water from the sides, from outside the treatment zone, that moves in to replace the hot water rising to the top due to buoyancy.

After reaching an average temperature of 100°C on April 6 in the treatment zone, heating continued for another five weeks, as additional VOCs were recovered aboveground. When the ERH system was finally shut down on May 11, 2004, an estimated 48,000 lb of VOC contamination had been recovered through the vapor phase (see Figure 6-9). Another estimated 428 lb of VOC were recovered in the extracted groundwater. In Figure 6-9, one feature of interest is the points in time when certain critical temperatures were first reached in the treatment zone. The first times that the adjusted boiling points of TCE and PCA are reached correspond approximately to times when another uptrend in VOC recovery occurred. Whereas the numbers in Figure 6-9 are cumulative, spot measurements of VOCs in the recovered vapors better illustrate this trend, as shown in Table 6-1. On December 19, when the temperature first reached the boiling point of TCE, there was a spike in TCE level to 1,100 ppm. On January 14 (close to January 19 in the temperature profiles) there is a sharp spike in both PCA and TCE levels as the boiling point of PCA is reached (TCE is one of the byproducts of PCA degradation). On February 11 (close to January 30 in the temperature profiles), when the boiling point of water was first reached, there was a sharp spike in both PCA and TCE levels. Because PCA has a lower vapor pressure (12 mm of mercury at 25°C) compared to TCE (73 mm of mercury), the yield of TCE in the vapor phase typically was more than that of PCA. Therefore, the TCE levels in the recovered vapor (see Table 6-1) are always higher than PCA levels. Another reason why TCE levels could be higher in the vapor phase is that TCE itself can be formed from degradation of PCA by dehydrochlorination, the rate of which is enhanced at higher temperatures. An estimated total of 48,000 lb of chlorinated solvents were recovered from the subsurface due to the ERH application at this site.

Reaching the boiling point of water is particularly important because the steam generated strips out additional contamination from the soil and supplements contaminant removal through evaporation. In fact, Figure 6-9 shows that more VOC mass was recovered after the boiling point of water was first reached in the aquifer (January 30) than before that point. It should be noted that the average temperature in the aquifer reached the boiling point of water several weeks after January 30 (on April 6) and ERH application continued for five weeks afterwards. The boiling point of water was first reached at central thermocouple location TMW-7 at depths of approximately 15 to 22 ft bgs. The heaviest DNAPL contamination was at 10 ft bgs. The buoyancy of steam could have caused the steam to migrate upwards through this region of high contamination (at 10 ft bgs). Therefore, there was a spike in VOC recovery even before the boiling point of water was reached in other parts of the aquifer. This also highlights the fact that VOC recovery was maximized at this site, even though the boiling points of PCA and water were not reached at the lowest depths in the “hot floor” region (note how the temperature profiles curve inwards below 20 ft bgs) because most of the contamination was well above the deepest points where ERH was applied.

Tables 6-2 and 6-3 show the groundwater analysis for samples collected from shallow and intermediate wells, respectively, before ERH application (baseline), at average aquifer temperatures of 30, 60, and 100°C, and at one week, one, two, four, and six months after ERH application ended. In each well, levels of PCA and TCE (the two primary DNAPL components) declined substantially, in many cases to below

detection. In some wells, the decline was not progressive, in the sense that PCA or TCE concentrations fluctuated a bit, indicating that some redistribution of DNAPL was taking place in the treatment zone. For example, PCA levels in shallow well MW-17 increased sharply in February 2004, when the aquifer temperature was 100°C. Similarly, the TCE level in shallow well MW-24 increased substantially in December 2003, when the aquifer temperature was 60°C. In the deeper wells, PCA levels did not fluctuate much and showed a steady decline. However, TCE levels in the deeper wells did fluctuate much more in various wells, such as MW-17IW, MW-21IW, and MW-25IW. This is because TCE, in addition to being potentially a primary DNAPL compound, is also a byproduct of PCA degradation.

PCA degrades by reduction through a variety of pathways and byproducts. By hydrogenolysis, PCA forms 1, 1, 2-TCA. By reductive beta-elimination, PCA degrades to *cis*-DCE and *trans*-DCE, and by dehydrochlorination it degrades to TCE. At this site, under elevated temperatures, there are signs that PCA degradation could have been enhanced. There is a gradual buildup of byproducts, especially TCE and *cis*-1,2 DCE, indicating that beta-elimination and dehydrochlorination pathways may be predominant. Of course, *cis*-DCE is also produced by anaerobic reduction of TCE, a suspected primarily DNAPL compound at this site. Byproduct generation is evident long after ERH application was stopped, for example, in well, such as MW-16 and MW-24. This indicates that PCA and TCE residuals continue to degrade at elevated rates, while the aquifer is still at elevated temperatures (although well below the boiling point of water). This enhanced biodegradation or abiotic degradation is an important feature of in situ DNAPL treatment and is advantageous for enhancing remedy effectiveness through continued degradation of residuals after active treatment has stopped.

The byproducts (e.g., *cis*-DCE) themselves degraded over time and were much reduced in most monitoring wells at the end of the sampling period (six months after the end of ERH application). Monitoring wells MW-17 (shallow) and MW-17IW (intermediate) indicated relatively high levels of PCA and/or TCE persisting six months after ERH application. There are no thermocouples close to this location, so it is difficult to say how efficiently this particular region was heated. The levels of *cis*-1,2 DCE also remained relatively high in these wells toward the end of the sampling period. MW-16 is another well where TCE and *cis*-1, 2 DCE levels remained particularly high six months after ERH ended. Both are byproducts of PCA degradation, and although PCA levels ended low in this well, there is possibility of persisting pockets of PCA-DNAPL in the vicinity of this well.

The monitoring wells outside the treatment zone showed some transient increases in PCA, TCE, and *cis*-1,2 DCE. For example, in shallow well MW-22, PCA levels showed a transient increase around the time the temperature reached 100°C, whereas TCE levels fluctuated and remained high. The level of *cis*-1,2 DCE in this well increased steadily. In the deeper well MW-22IW, there was a sharp increase in PCA, TCE, and *cis*-1,2 DCE levels early during heating, when the temperature reached 30°C. It is possible that some DNAPL or dissolved phase contamination migrated outside the treatment plot during heating. Any such migration appears to be limited, relative to the mass of VOCs recovered aboveground. Also, the moderately elevated temperatures in the aquifer adjacent to the treatment plot probably caused enhanced degradation of these VOCs, as indicated by the generation of *cis*-1,2 DCE.

There was no noticeable elevation of VOC levels in ambient air samples collected in the atmosphere above and outside the target treatment area, indicating that the vapor recovery system was effective in preventing the migration of vapors to the atmosphere.

6.7 Cost

Table 6-5 summarizes the costs incurred for the ERH application. The total cost for the project was \$2,247,641, which includes \$1,722,641 incurred by the vendor and \$525,000 incurred by the site. The large area treated (15,900 sq ft), the large number of electrodes (91 electrodes) required to be installed,

the operation and maintenance (O&M) requirements for 225 days of operation (173 days of ERH application), and the associated power consumption were the driving factors in the total cost.

On the other hand, more than at any other site reviewed in this document, the ERH application at this site appeared to have achieved its goal of heating the aquifer as uniformly as possible to the boiling temperature of water (100°C and higher, depending on depth) and maintaining this temperature for a certain period of time. This was achieved despite the complexities at the site, including the fine sand or silty-clay content of the soil.

6.8 Discussion

As mentioned in Sections 1 through 5 above for the other ERH sites, it appears that at Camp Lejeune too, certain critical temperatures had to be reached for contaminant removal in specific regions to be complete and efficient. When the adjusted boiling point of TCE (73°C at 1 atm) was reached, the concentration of TCE in the recovered vapor phase increased sharply. When the adjusted boiling point of PCA (94°C at 1 atm) was reached, there was a sharp increase in PCA concentrations in the recovered vapor. The adjusted boiling points of these components are higher at greater depths in the aquifer because of higher pressures; therefore, higher temperatures have to be reached at greater depths. The adjusted boiling points of TCE or PCA in solution with water are lower than the normal boiling points of TCE (87°C) and PCA (147°C) at 1 atm because TCE and PCA form a minimum boiling azeotrope with water (mixture of TCE and water and PCA and water boil at temperatures below the boiling temperatures of either TCE/PCA or water). In the immiscible phases (where TCE or PCA exist as DNAPL), co-distillation of TCE or PCA with steam enhances boiling or vaporization at temperatures below the boiling points of either water or TCE/PCA.

In summary, the target aquifer system should be heated to temperatures corresponding to the minimum azeotropic boiling points of the target compounds (e.g., TCE or PCA) and preferably higher. Despite the complexities of the geology and the fine-grained (low-permeability) nature of the aquifer soils, chlorinated solvent levels in the recovered vapor were high and the residual solvent concentrations in the groundwater monitoring wells were low, even after several months following ERH application.

Also, despite all the factors (formation of azeotropes in the miscible phase and co-distillation of solvent and water in the non-miscible phases) that caused the target solvent components to boil at temperatures below their normal boiling points, more than half of the VOC mass recovery in the vapor phase occurred after the aquifer temperature reached the normal boiling point of water (equivalent to 100°C at 1 atm). The success of this pilot project seems to be derived from two factors. First, the normal boiling temperature of water was reached and maintained for several days, unlike at other sites where this temperature was never reached or was reached only in some pockets of the target aquifer zone. Secondly, heat application at this site appeared to be more uniform with desired temperatures being reached at many more locations in the target zone. This was achieved through installation of a large number of electrodes, more controlled ramping up and down of electrodes at different depths, installation of electrodes to depths below the depths at which most of the DNAPL was present (as they did at the other four sites, the temperature profiles curve inwards in the last few feet of the target heating zone, but at this site, these lower temperatures occurred at depths below the depth where most of the DNAPL was present), and continued operation for a long period of time (173 days of actual heat application over 34 weeks). Therefore, the cost of the application was relatively high in terms of installation and operating labor, as well as power consumption.

There were signs that enhanced biotic and abiotic degradation of PCA and TCE occurred at the elevated temperatures caused by heating. This is evidenced by the buildup of byproducts, such as TCE (a byproduct of PCA degradation) and *cis*-1,2 DCE (a byproduct of PCA and TCE degradation). Over time, in the six months following the end of ERH application, these byproducts had degraded in most

monitoring wells. This is probably due to the fact that temperatures remain elevated in the heated aquifer for several months after power application is stopped.

There were some signs that dissolved-phase and/or DNAPL TCE and PCA may have redistributed within the target treatment zone, as well as in some monitoring wells outside the treatment zone. However, these effects were transient and elevated levels of these compounds subsided over time. It helps that the effects of the heating are experienced a few feet outside the electrode arrays and some of the surrounding aquifer experiences elevated temperatures. There was no sign of elevated VOC levels in the atmosphere above the treatment area, indicating that the ERH operation was well contained.

Table 6-1. VOC Concentrations in the Recovered Vapor Phase

Date	9/12/2003	10/30/2003	11/10/2003	11/19/2003	11/24/2003	12/2/2003	12/12/2003
Time	18:00	17:00	16:30	8:00	16:30	14:30	10:00
Vinyl Chloride		0	0	0	1	1	1
<i>cis</i> - and <i>trans</i> -DCE		4	2	4	24	41	35
TCE		17	7	2	99	150	150
1,1,2,2-tetrachloroethane		1	0	1	8	25	28
other CVOCs		1	0	1	0	2	0
Total Influent Summa Data VOCs		23	9	17	131	219	214

Date	12/19/2003	12/22/2003	1/6/2004	1/14/2004	1/29/2004	2/11/2004	2/19/2004
Time	16:30	18:00	10:30	13:00	14:15	14:15	15:40
Vinyl Chloride	6	2	2	0	0	0	0
<i>cis</i> - and <i>trans</i> -DCE	330	48	148	1,540	143	560	287
TCE	1,100	210	630	6,000	520	2,100	1,200
1,1,2,2-tetrachloroethane	560	26	110	2,400	11	1,200	830
other CVOCs	0	0	7	0	10	49	28
Total Influent Summa Data VOCs	1,996	286	897	9,940	684	3,909	2,345

Adjusted boiling point of TCE exceeded (73°C at 1 atm; 12/19/03)

Adjusted boiling point of PCA exceeded (94°C at 1 atm, 1/14/04)

Adjusted boiling point of water exceeded (100°C at 1 atm; 2/11/04)

Table 6-2. Monitoring Wells, Inside Treatment Zone at Shallow Depth (5 to 10 ft bgs) (Page 1 of 2)

MW-16 Date	Baseline 8/03	30°C 11/03	60°C 12/03	100°C		One week	One month	Two Months	Four Months	Six Months
				2/04	3/04					
<i>cis</i> -1,2-DCE	25.7	61.3	39.7	53.8	43.5	0.279	0.44	1.29	14.8	35.2
<i>trans</i> -1,2-DCE	9.85	19.8	9.47	8.79	3.3	0.04	0.054	0.17	0.84	0.669
1,1,2,2-PCA	126	27.4	5.8	<10	<1	<0.1	<0.1	<0.4	<0.4	<0.4
1,1,,2-TCA	<20	<10	<10	<10	<1	<0.1	<0.1	<0.4	<0.4	<0.4
PCE	<20	<10	<10	<10	<1	0.057	0.096	<0.4	<0.4	<0.4
TCE	424	467	224	184	70.2	2.07	3.22	13.6	19.1	9.11
VC	<10	<5	<5	<5	<5	<0.05	<0.05	<0.20	0.12	<0.2

MW-17 Date	Baseline 8/03	30°C 11/03	60°C 12/03	100°C		One week	One month	Two Months	Four Months	Six Months
				2/04	3/04					
<i>cis</i> -1,2-DCE	99.3	105	121	30.5	0.13	2.37	2.1	2.06	1.46	1.82
<i>trans</i> -1,2-DCE	23.2	26.4	<50	<50	0.024	0.64	0.48	0.46	0.33	0.23
1,1,2,2-PCA	1670	1940	1500	18900	2.84	4.31	2.77	1.3	0.6	0.344
1,1,,2-TCA	18.6	21.9	16.6	166	0.018	0.088	0.063	<0.1	<0.2	0.455
PCE	1.43	<40	<50	33.2	0.007	<0.1	<0.1	<0.1	<0.2	0.571
TCE	118	355	299	1880	0.31	4.63	4.84	5.76	4.02	2.83
VC	0.72	<20	<2.5	<2.5	<0.002	<0.05	<0.05	<0.05	<0.1	<0.1

MW-21 Date	Baseline 8/03	30°C 11/03	60°C 12/03	100°C		One week	One month	Two Months	Four Months	Six Months
				2/04	3/04					
<i>cis</i> -1,2-DCE	224	189	142	<40	0.11	0.72	0.84	0.62	1.13	0.748
<i>trans</i> -1,2-DCE	55.2	56.6	37.1	<40	0.005	0.16	0.15	0.09	0.08	0.087
1,1,2,2-PCA	2240	1120	789	1970	0.22	0.11	0.072	0.01	<0.02	0.012
1,1,,2-TCA	23.5	18.6	17.8	18.6	0.006	0.09	0.006	<20	<0.02	<0.02
PCE	<10	<40	<40	<40	0.003	<0.02	<0.02	<0.02	<0.02	<0.02
TCE	<768	518	959	92.9	0.38	0.72	0.97	0.73	0.46	0.33
VC	<5	<20	<20	<20	<0.003	<0.01	0.007	0.005	0.016	0.016

Table 6-2. Monitoring Wells, Inside Treatment Zone at Shallow Depth (5 to 10 ft bgs) (Page 2 of 2)

MW-24 Date	Baseline 8/03	30°C		60°C		100°C		One week	One month	Two Months	Four Months	Six Months
		11/03	11/03	12/03	12/03	2/04	3/04					
<i>cis</i> -1,2-DCE	35	89.7	46	9.86	0.27	0.33	0.002	0.47	3.69	2.16		
<i>trans</i> -1,2-DCE	12.7	40.5	<20	3.47	0.02	0.03	0.0006	0.04	0.099	<0.1		
1,1,2,2-PCA	411	143	166	14.3	0.715	0.03	0.007	0.005	<0.04	<0.1		
1,1,,2-TCA	<20	<20	17.5	<1.0	0.003	<0.02	<0.002	<2	<0.04	<1.0		
PCE	<20	<20	5.17	0.44	0.01	0.022	0.013	0.002	<0.04	<0.1		
TCE	359	539	1910	37	0.272	0.99	0.65	1.52	0.5	0.475		
VC	<10	<10	<10	<0.5	<0.002	<0.01	0.004	0.005	0.036	<0.05		

MW-25 Date	Baseline 8/03	30°C		60°C		100°C		One week	One month	Two Months	Four Months	Six Months
		11/03	11/03	12/03	12/03	2/04	3/04					
<i>cis</i> -1,2-DCE	104	132	56.8	1.19	0.041	0.21	0.53	0.47	0.79	0.665		
<i>trans</i> -1,2-DCE	31.1	40.5	12.9	0.29	0.006	0.01	0.023	0.021	0.04	0.013		
1,1,2,2-PCA	515	505	62.4	0.67	0.016	0.006	<0.04	<0.02	<0.02	<0.02		
1,1,,2-TCA	9.97	12	6.82	<0.2	<0.001	<0.02	<0.04	<0.02	<0.02	<0.02		
PCE	<20	<20	<20	0.14	0.014	0.023	0.023	0.009	<0.02	<0.02		
TCE	527	617	693	7.47	0.57	0.87	1.3	0.64	0.76	0.03		
VC	<10	<10	<10	<0.1	<0.005	<0.01	<0.02	<0.01	<0.01	<0.01		

Table 6-3. Monitoring Wells Inside Treatment Zone at Intermediate Depth (20 to 25 ft bgs)

MW-17IW Date	Baseline 8/03	30°C		60°C		100°C		One week	One month	Two Months	Four Months	Six Months
		11/03	3/04	12/03	2/04	100°C	3/04					
<i>cis</i> -1,2-DCE	1.39	3.32	2.1	3.43	4.26	2.1	1.52	1.77	1.41	1.37	0.89	
<i>trans</i> -1,2-DCE	0.15	0.53	0.11	0.38	0.37	0.11	0.07	0.047	<0.1	0.056	<0.1	
1,1,2,2-PCA	<0.1	<0.4	<0.05	<0.4	<0.2	<0.05	<0.1	<0.1	<0.1	<0.1	<0.1	
1,1,2-TCA	<0.1	<0.4	<0.05	<0.4	<0.2	<0.05	<0.1	<0.1	<0.1	<0.1	<0.1	
PCE	0.078	0.11	0.08	<0.4	0.13	0.08	0.073	0.053	0.056	0.052	0.049	
TCE	3.32	7.32	4.6	7.29	11.7	4.6	3.4	3.01	2.3	2.32	1.87	
VC	0.037	0.16	0.043	<0.2	0.111	0.043	0.07	0.095	0.057	0.138	0.027	

MW-21IW Date	Baseline 8/03	30°C		60°C		100°C		One week	One month	Two Months	Four Months	Six Months
		11/03	3/04	12/03	2/04	100°C	3/04					
<i>cis</i> -1,2-DCE	7.57	54	0.026	23.9	2.77	0.026	0.02	0.02	0.02	0.014	0.011	
<i>trans</i> -1,2-DCE	2.51	19.7	<0.05	7.93	<0.5	<0.05	<0.04	<0.04	<0.04	<0.04	0.002	
1,1,2,2-PCA	52.5	83.2	<0.05	11	<0.5	<0.05	<0.04	<0.04	<0.04	<0.04	<0.004	
1,1,2-TCA	0.79	3.65	<0.05	1.39	<0.5	<0.05	<0.04	<0.04	<0.04	<0.04	<0.004	
PCE	1.26	<10	0.31	1.59	1.08	0.31	0.21	0.16	3.8	2.72	0.181	
TCE	85.9	226	2.89	145	19.6	2.89	1	0.5	0.79	0.33	0.17	
VC	<1	<5	<0.025	<2.5	<0.25	<0.025	<0.02	<0.02	<0.02	<0.02	<0.002	

MW-24IW Date	Baseline 8/03	30°C		60°C		100°C		One week	One month	Two Months	Four Months	Six Months
		11/03	3/04	12/03	2/04	100°C	3/04					
<i>cis</i> -1,2-DCE	0.46	24.9	0.002	3.41	0.036	0.002	0.004	0.003	0.005	0.004	0.002	
<i>trans</i> -1,2-DCE	0.29	9.86	<0.001	1.28	0.011	<0.001	0.001	<0.001	<0.001	<0.001	<0.002	
1,1,2,2-PCA	27.7	10.5	<0.002	<2	0.014	<0.002	<0.004	<0.002	<0.002	<0.002	<0.002	
1,1,2-TCA	0.09	<10	<0.002	<2	<0.04	<0.002	<0.004	<0.002	<0.002	<0.002	<0.002	
PCE	0.69	4.12	0.073	1.24	0.55	0.073	0.042	0.02	0.027	0.017	0.006	
TCE	45.3	411	0.116	69.1	3.09	0.116	0.08	0.033	0.035	0.009	0.002	
VC	<0.1	<5	<0.001	<1	<0.02	<0.001	<0.002	<0.001	<0.001	<0.001	<0.001	

MW-25IW Date	Baseline 8/03	30°C		60°C		100°C		One week	One month	Two Months	Four Months	Six Months
		11/03	3/04	12/03	2/04	100°C	3/04					
<i>cis</i> -1,2-DCE	1.35	42.7	0.008	3.02	0.074	0.008	0.06	0.067	0.073	0.061	0.032	
<i>trans</i> -1,2-DCE	0.52	15	<0.02	1	<0.2	<0.02	0.004	<0.04	<0.04	<0.04	<0.01	
1,1,2,2-PCA	13.6	<10	0.005	<1	<0.2	0.005	<0.01	<0.04	<0.04	<0.04	<0.01	
1,1,2-TCA	<1	<10	<0.02	<1	<0.2	<0.02	<0.01	<0.04	<0.04	<0.04	<0.01	
PCE	0.811	<10	0.037	0.408	0.168	0.037	0.011	0.032	0.137	0.301	0.162	
TCE	23.3	269	1.62	45	6.81	1.62	0.2	0.99	2.53	1.25	0.35	
VC	<0.5	<5	<0.01	<0.5	<0.1	<0.01	0.004	<0.02	<0.02	<0.02	<0.005	

Table 6-4. Monitoring Wells Outside the Treatment Zone

MW-22 Date	Baseline 8/03	30°C 11/03	60°C 12/03	100°C		One week	One month	Two Months	Four Months	Six Months
				3/04	3/04					
<i>cis</i> -1,2-DCE	42	62.3	46.3	40.2	40.2	54.3	55.8	50.8	82.7	156
<i>trans</i> -1,2-DCE	15.8	28.8	18.6	13.4	13.4	29	31	20	28.3	32.3
1,1,2,2-PCA	35.8	20.9	22.7	58	58	43	28.3	13.9	3.62	0.71
1,1,,2-TCA	1.95	1.62	1.54	2.1	2.1	2.01	<10	1.91	1.78	1
PCE	1.33	1.28	1.13	1.03	1.03	1.27	<10	1.15	1.49	1.07
TCE	169	150	153	151	151	217	202	201	167	178
VC	1.2	5.01	5.06	2.41	2.41	2.51	6.35	2.45	3.33	4.06

MW-221W Date	Baseline 8/03	30°C 11/03	60°C 12/03	100°C		One week	One month	Two Months	Four Months	Six Months
				2/04	2/04					
<i>cis</i> -1,2-DCE	0.004	4.51	2.45	0.09	0.09	0.006	0.252	0.51	0.064	0.648
<i>trans</i> -1,2-DCE	<0.002	1.79	0.68	0.02	0.02	<0.001	0.034	0.05	0.003	0.01
1,1,2,2-PCA	<0.002	4.37	0.94	0.03	0.03	<0.002	<0.002	<0.1	<0.002	<0.04
1,1,,2-TCA	<0.002	0.11	<0.4	<0.01	<0.01	<0.002	<0.002	<0.1	<0.002	<0.04
PCE	0.001	0.505	0.19	0.011	0.011	<0.001	0.04	0.135	0.009	<0.04
TCE	0.01	20.2	7.35	0.32	0.32	0.007	0.904	2.19	0.068	0.019
VC	<0.001	0.11	<0.2	0.005	0.005	<0.001	0.042	0.046	0.004	0.02

Table 6-5. Electrical Resistive Heating Costs at Camp Lejeune

Vendor Costs	
System Installation	\$672,550
System O&M (225 days)	\$907,400
Power Cost	\$142,691 ^(a)
Vendor's Total Cost	\$1,722,641
Site Incurred Costs	
Monitoring/Analysis	\$324,410
Site Preparation and Costs	\$31,275
Total Site Incurred Cost	\$355,685
Administration/Plans/Reports	\$169,580
Total Cost	\$2,247,906

Note:

(a) Power cost estimated based on 1,748,660 kW-hr usage reported by the vendor and an average commercial unit electrical cost of \$0.0816/kW-hr in 2004. See US DOE link at http://www.eia.doe.gov/emeu/aer/pdf/pages/sec8_39.pdf.

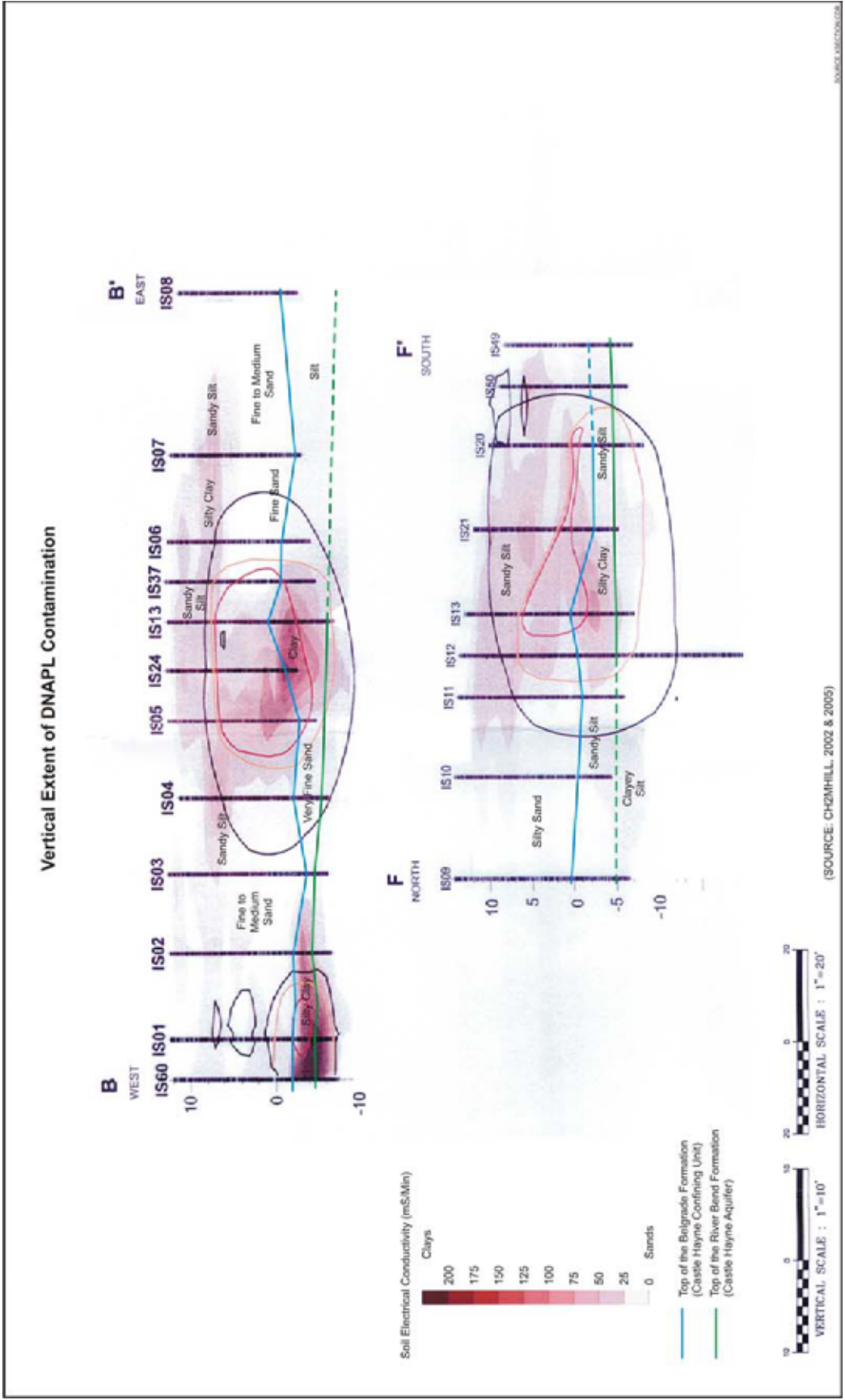

Figure 6-2. Vertical Geologic Cross-Section and Distribution of DNAPL

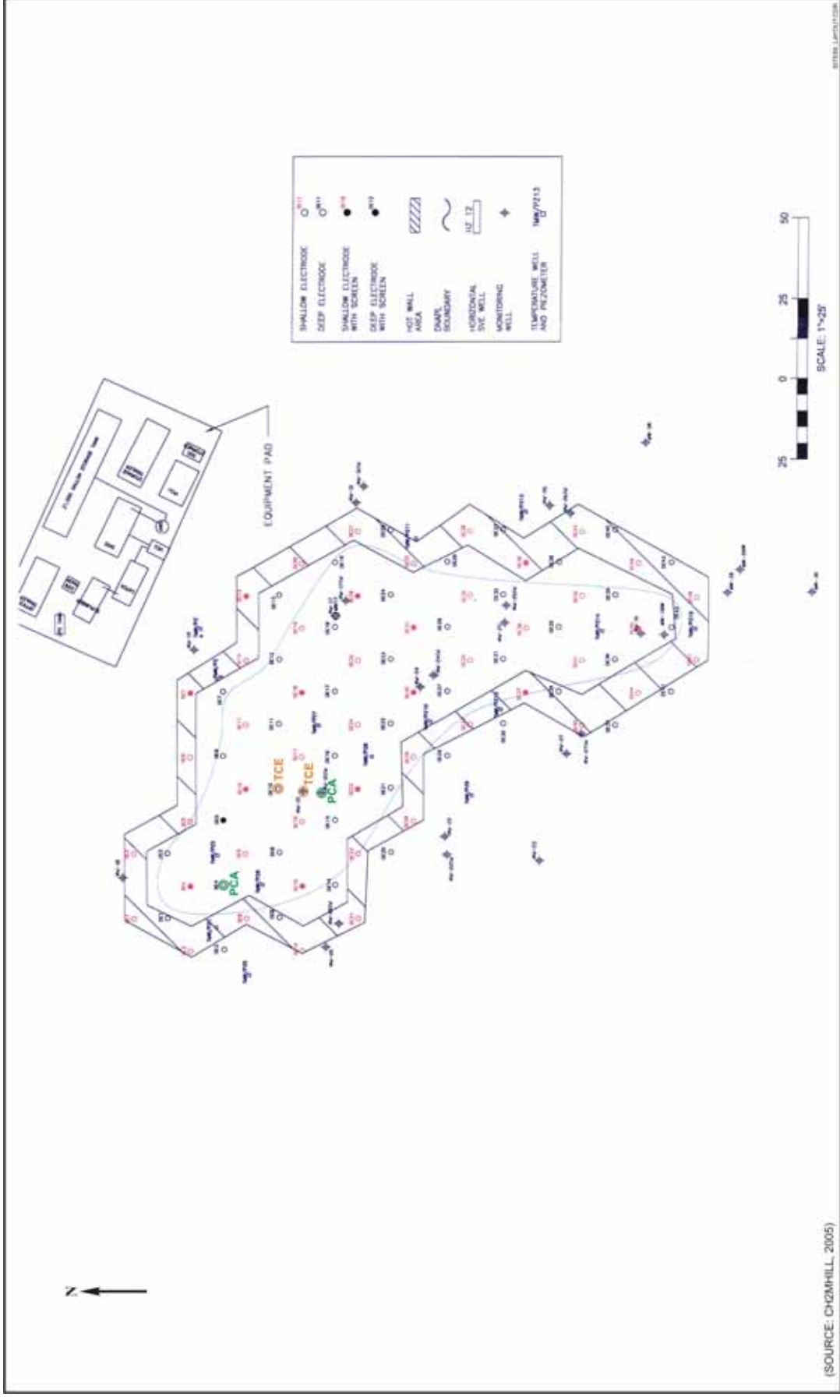

Figure 6-3. ERH Layout at Site 89

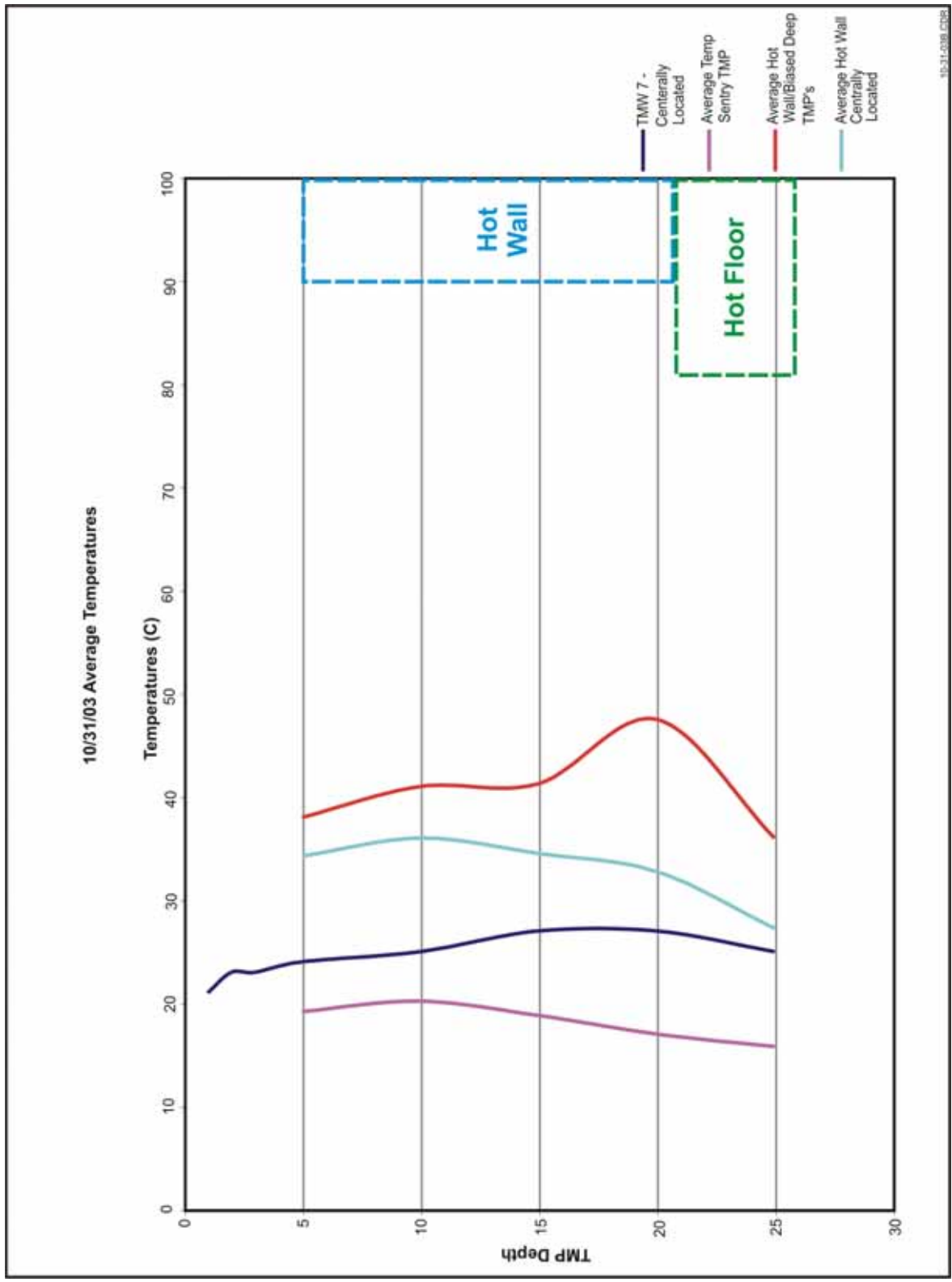

Figure 6-4. Temperature Versus Depth Profile After Few Weeks of ERH Application at the Site

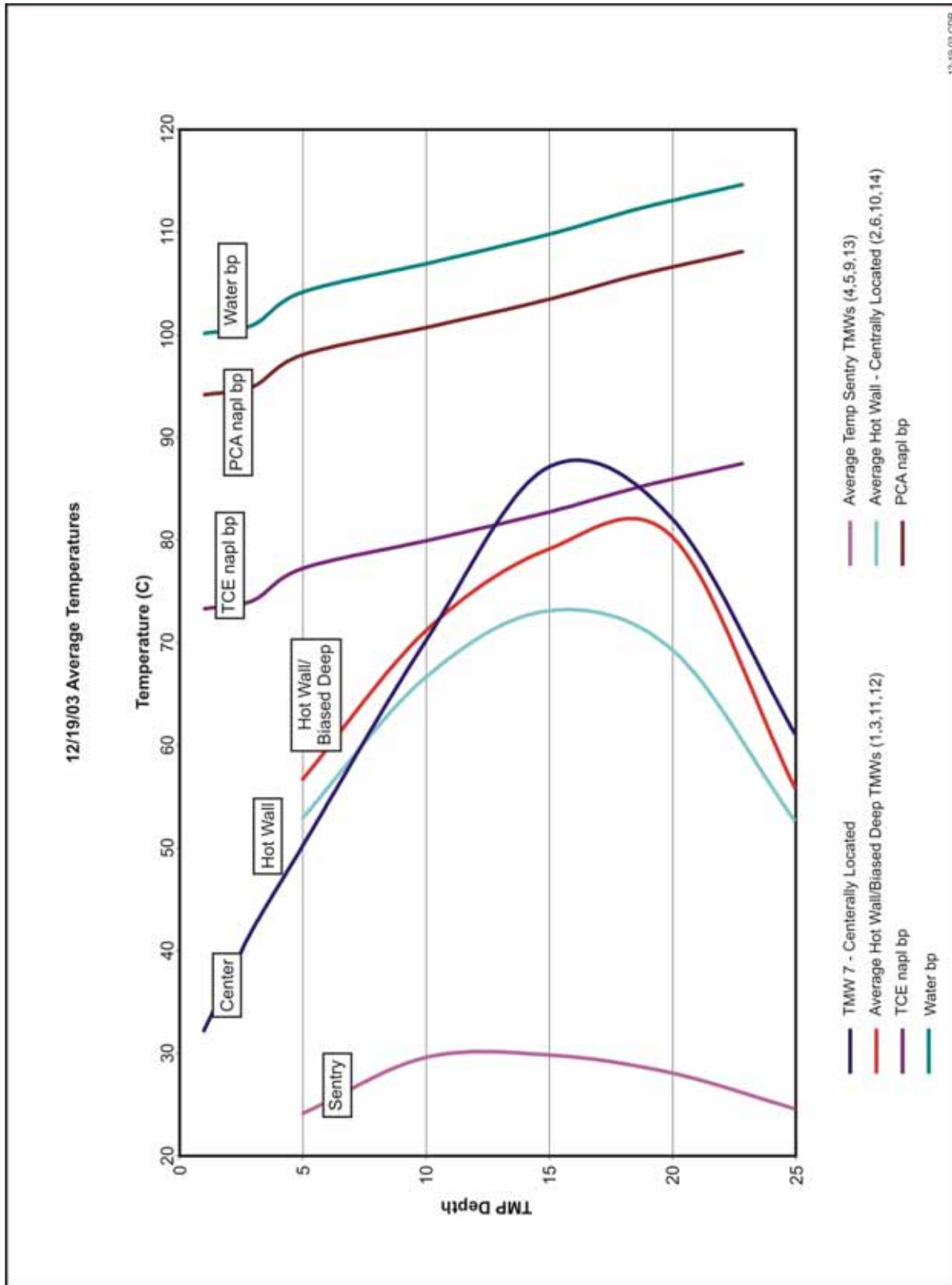

Figure 6-5. Temperature Versus Depth Profile

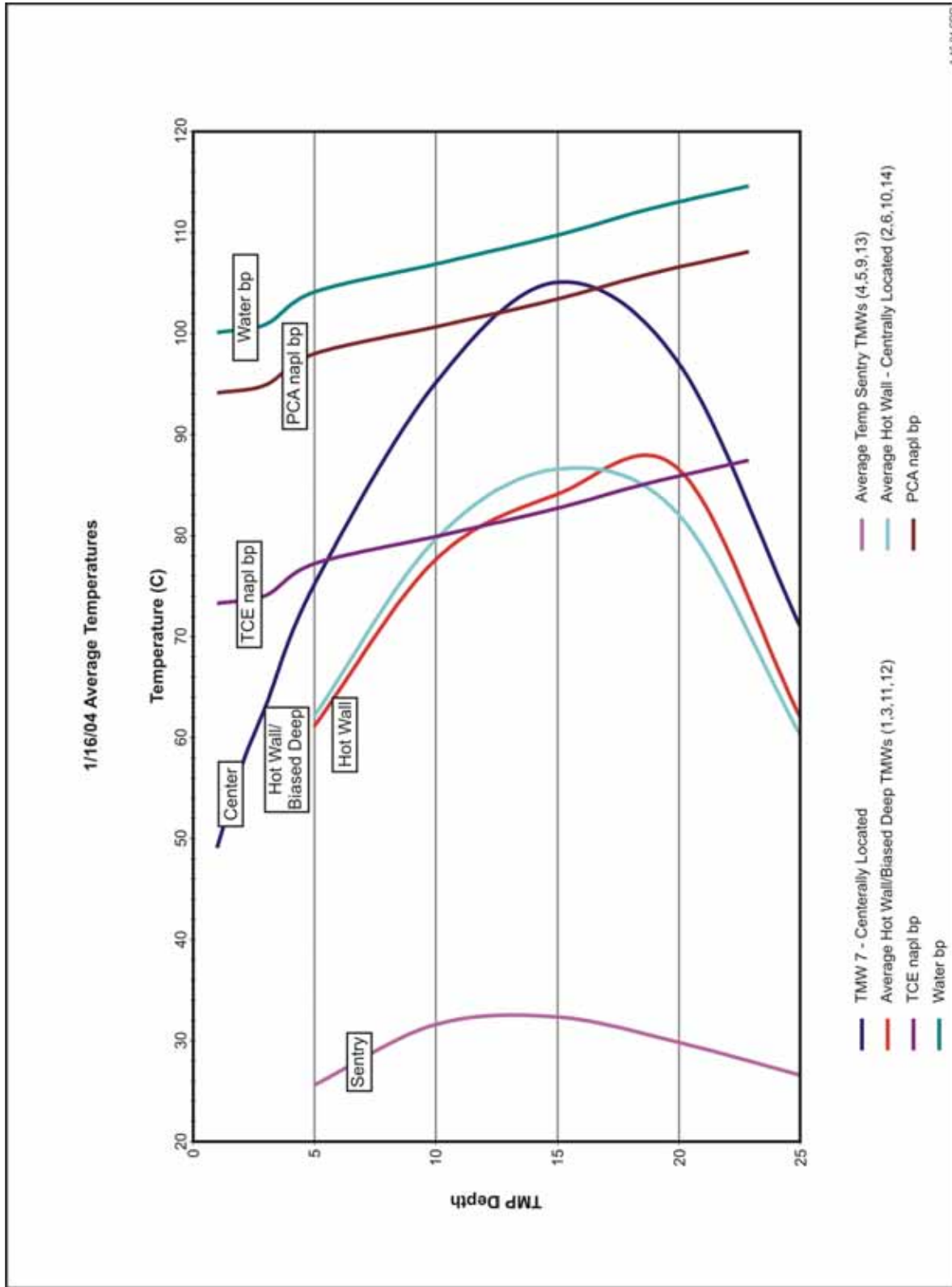

Figure 6-6. Temperature Versus Depth Profile

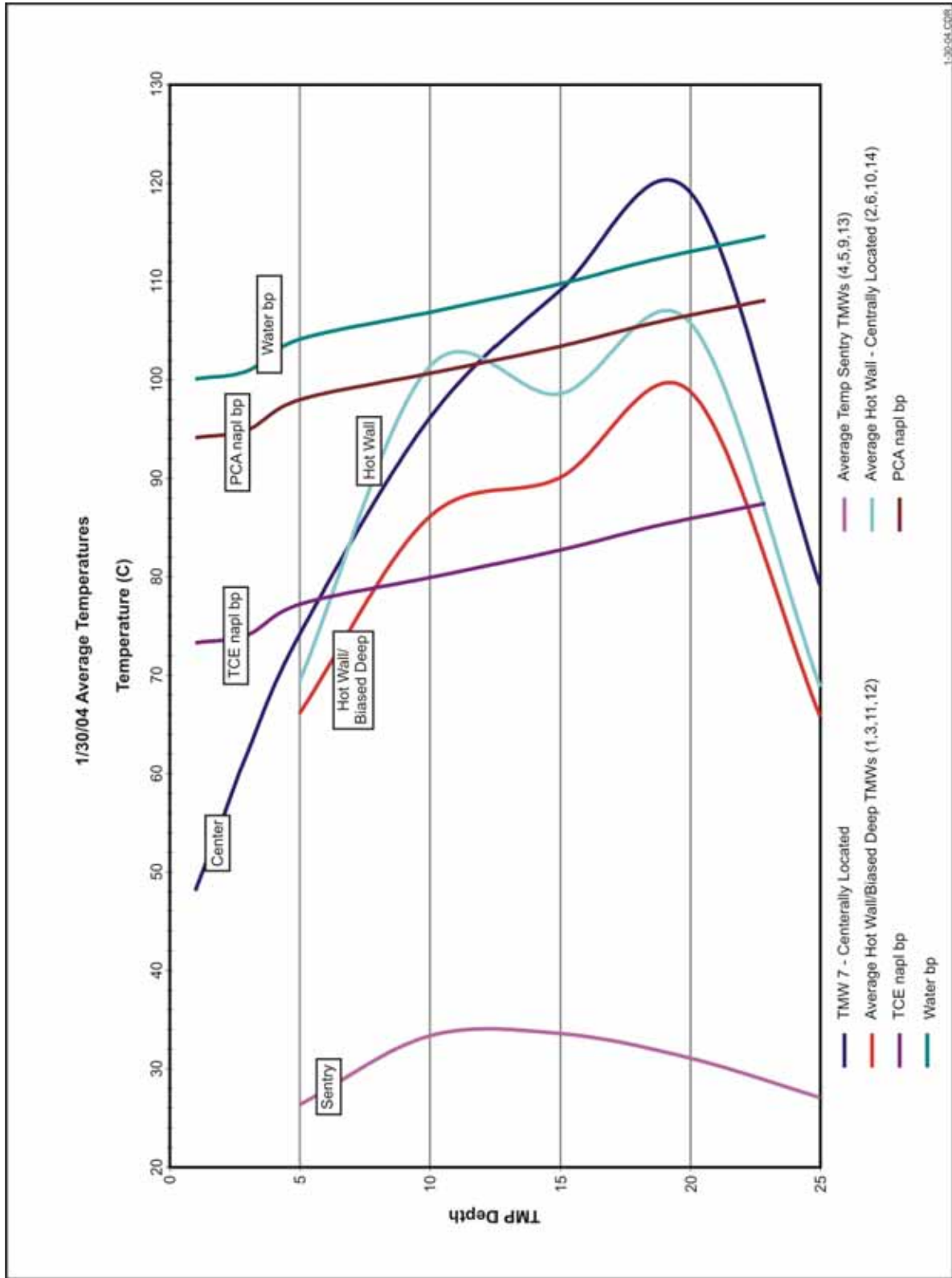

Figure 6-7. Temperature Versus Depth Profile

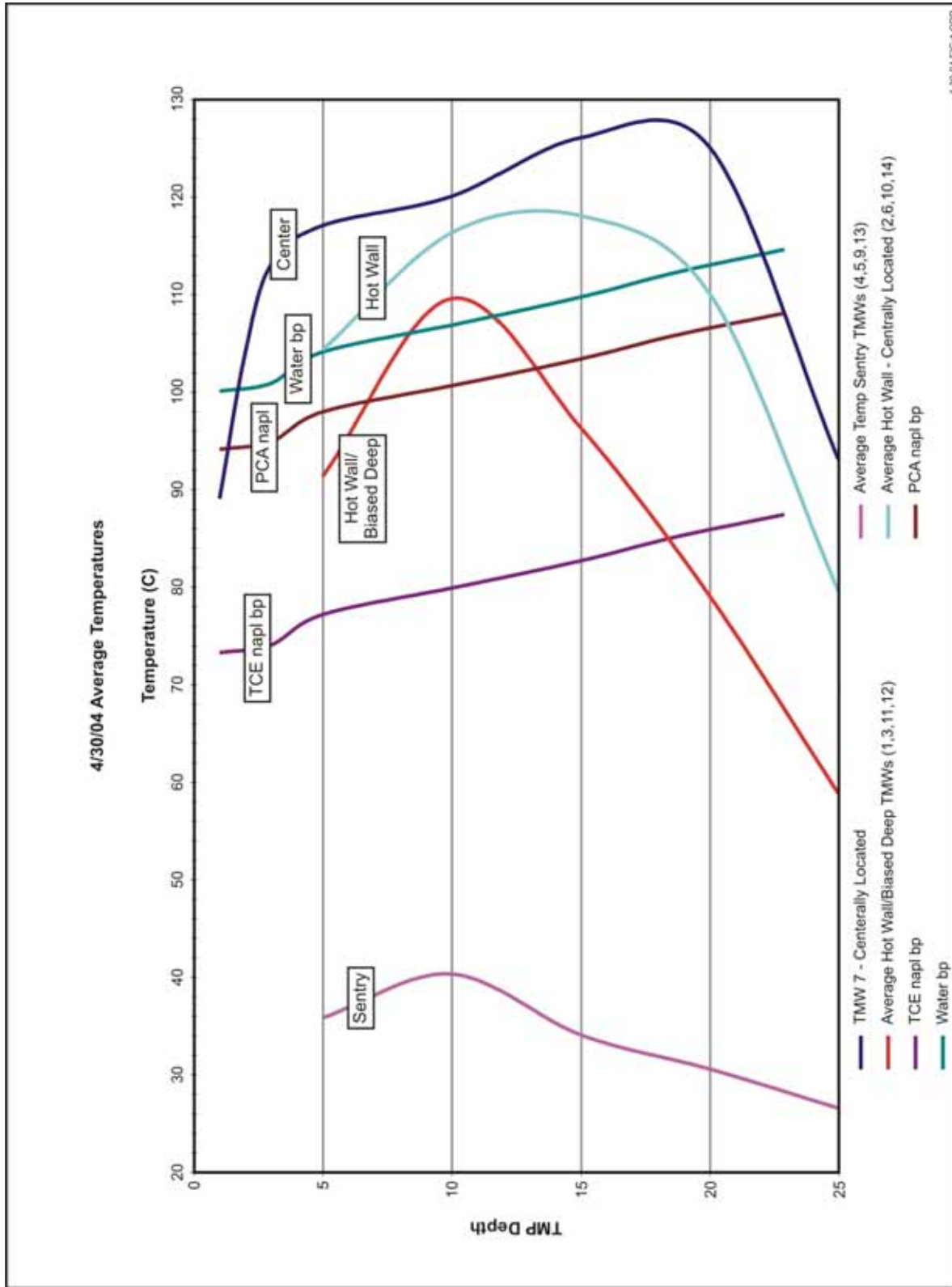

Figure 6-8. Temperature Versus Depth Profile Around System Shutdown

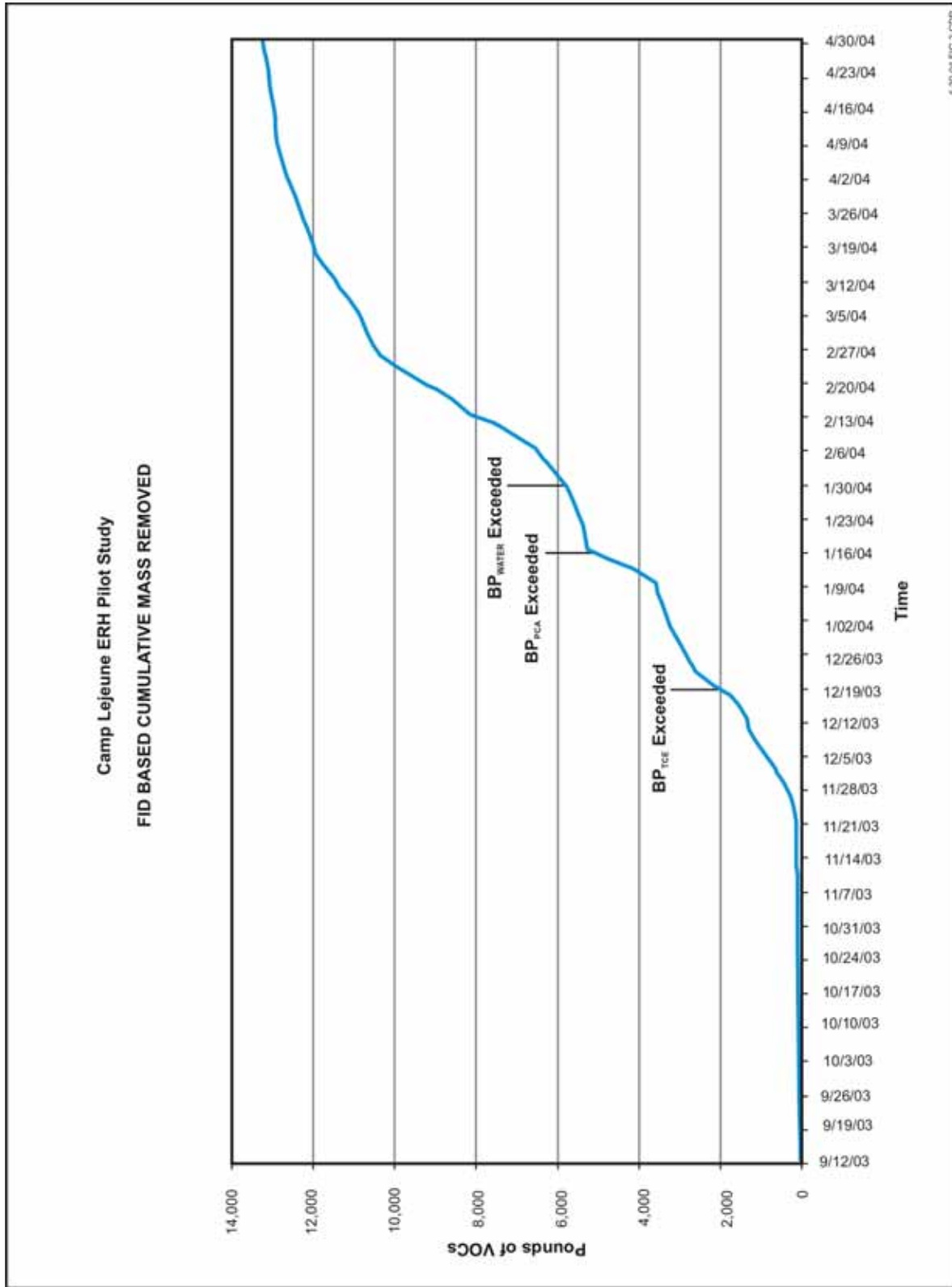

Figure 6-9. Cumulative VOC Mass Removed During ERH Application

Section 7.0: SUMMARY OF CONCLUSIONS AND DISCUSSION

The five ERH projects at the Navy and NASA sites provide a wealth of information on the performance of this remediation technology under different site conditions and the lessons learned from these early applications serve as a good guide for future users.

Performance data from these sites indicate that ERH treats DNAPL source zones through a variety of mechanisms. The primary mechanism in most source zone applications is the volatilization and recovery of CVOC contaminants by the application of electrical energy, which gets converted to heat in the aquifer. The following masses of target CVOCs were recovered from the treated aquifer at these sites by this mechanism:

- Approximately 90 lb of total VOC mass was recovered aboveground from the captured vapors at the NWIRP Bedford site.
- An estimated 4,283 lb (1,947 kg) of TCE was recovered from the subsurface at Cape Canaveral Air Station.
- An estimated 234 lb of PCE (and 247 lb of total CVOCs) was recovered aboveground at Naval Complex Charleston.
- More than 3,000 lb of VOCs was recovered from the subsurface at former NAS Alameda.
- An estimated 48,000 lb of chlorinated solvent was recovered from the subsurface at MCB Camp Lejeune.

In the short-term, mass removal by volatilization and capture from the subsurface is often the primary mechanism of treatment. CVOC volatilization and capture are facilitated by heating, which favorably modifies CVOC properties, such as solubility (increases), viscosity (decreases), Henry's Law constant (increases), octanol-water co-efficient (decreases), and aqueous diffusion rate (increases). In the short- and long-term, other potential treatment mechanisms that often come into play are enhanced biodegradation and abiotic reactions, such as hydrolysis. Indicators of some of these reactions occurring were present at all five sites reviewed.

7.1 Heating Efficiency and Temperatures

The efficiency of CVOC mass removal from the subsurface by volatilization is dependent upon the ability of the technology to (a) reach design temperatures in the target treatment regions, and (b) capture and treat the resulting vapors. The target treatment regions often include regions that are difficult to reach, such as immediately above a clay aquitard at the bottom of the aquifer or in a silty-clay lens inside a predominantly sandy aquifer. However, DNAPL is often trapped in these regions of the aquifer and has to be treated.

It is obvious from the data from these five sites that certain critical temperatures have to be reached for contaminant removal in specific regions of the aquifer to be complete and efficient (see Table 7-1). For example at Camp Lejeune, when the adjusted boiling point of TCE (73°C at 1 atm) was reached, the concentration of TCE in the recovered vapor phase increased sharply. When the adjusted boiling point of PCA (94°C at 1 atm) was reached, there was a sharp increase in PCA concentrations in the recovered vapor. The adjusted boiling points of these components are higher at greater depths in the aquifer because of higher pressures; therefore, higher temperatures have to be reached at greater depths. The adjusted boiling points of TCE or PCA in solution with water are lower than the normal boiling points of TCE (87°C) and PCA (147°C) at 1 atm because TCE and PCA form a minimum boiling azeotrope with water (mixture of TCE and water and PCA and water boil at temperatures below the boiling temperatures of

either TCE/PCA or water). In the immiscible phases (where TCE or PCA exist as DNAPL), co-distillation of TCE or PCA with steam enhances boiling or vaporization at temperatures below the boiling points of either water or TCE/PCA. The same is true for other CVOCs, such as PCE and TCA, which form minimum boiling azeotropes with water.

It should be noted that these predicted azeotropic boiling points are based on previous studies conducted with binary systems (two components, such as TCE and water). However, groundwater often contains many organic and inorganic components, making it a much more complex system, whose behavior to predict. Also, just as there are factors, such as formation of azeotropes and Dalton's Law of Partial Pressures, that would cause boiling points to be lower, there are other factors, such as the presence of non-volatile solutes (e.g., chloride, sulfate, sodium, etc.) in natural groundwater that would cause vapor pressures to be lower (and boiling points to be higher). That said, however, the azeotropic minimum boiling points do seem to indicate critical turning points in the field at some of the reviewed ERH sites, where reaching these critical temperatures has often coincided with increased recovery of VOCs in the vapor phase. Also, the imposition of a vacuum in the vadose zone to facilitate vapor recovery may serve to reduce the total vapor pressure required for boiling and, therefore, lower the boiling temperatures below those predicted under 1 atm. Given these uncertainties, reaching the boiling point of water at all targeted depths in the aquifer is often a good design goal at most sites, as enhanced steam generation helps to strip out less-volatile contamination.

In general, the target aquifer system should be heated to temperatures corresponding to the minimum azeotropic boiling points of the target compounds (e.g., TCE or PCA) and preferably higher. Despite the complexities of the geology and the fine-grained (low-permeability) nature of the aquifer soils at Camp Lejeune, chlorinated solvent levels in the recovered vapor were high and the residual solvent concentrations in the groundwater monitoring wells were low, and remained low after several months following ERH application. Also, despite all the factors (formation of azeotropes in the miscible phase and co-distillation of solvent and water in the non-miscible phases) that can be said to cause the target solvent components to boil at temperatures below their normal boiling points, more than half of the VOC mass recovery in the vapor phase at Camp Lejeune occurred after the aquifer temperature reached the normal boiling point of water (equivalent to 100°C at 1 atm). Although many CVOC contaminants boil at temperatures below that the normal boiling point of water, reaching temperatures of 100 °C or higher, when water starts boiling more rapidly is often a goal at many ERH sites because the resulting steam stripping stimulates additional recovery of CVOCs trapped in the soil or dissolved in the water. Therefore, for maximum possible recovery of CVOCs, it is important to reach both the adjusted boiling points of the individual CVOCs and the normal boiling point of water. These temperatures were not necessarily reached in all regions of the target treatment zone at some of the ERH sites reviewed.

At NWIRP Bedford, CVOCs were recovered in the order of their adjusted boiling points. Lower-boiling components, such as *cis*-1,2 DCE (54°C), are more volatile (have a higher vapor pressure) and were recovered first. Higher boiling components, such as TCE (73°C) and PCE (88°C) were recovered later, as continued heating caused temperatures to rise to these levels. It should be noted that the adjusted boiling points of these components may be higher at greater depths, where the pressure in the aquifer is greater (elevation of boiling point at higher pressures). Therefore, all these CVOCs and water itself will boil at temperatures higher than the adjusted boiling points at atmospheric pressure and the temperature requirements increase with depth below the water table.

At sites, such as NWIRP Bedford, where higher residual CVOC concentrations or rebound in certain monitoring wells indicated that CVOC removal from the subsurface was incomplete, data show that the degree to which the desired temperatures were attained in certain parts of the treatment zone corresponds relatively well to the amount of CVOC mass removed or left behind in that region. At NWIRP Bedford, there was greater post-treatment residual CVOC mass at locations where the temperatures did not reach

the adjusted boiling points of the components during the ERH application. For example, at MW-50I, the highest temperature reached was 77°C at 55 ft bgs; at this depth, the adjusted boiling points are expected to be 84°C for TCA, 92°C for TCE, and 107°C for PCE. At MW-58IR, on the other hand, where temperatures reached 105°C at 30 ft bgs and 109°C at 55 ft bgs, CVOC removal was much better and contaminant rebound in the long-term monitoring event was muted, indicating that there was very little residual contaminant mass at this location. Although the boiling points of the individual CVOCs were exceeded in some parts of this site, the normal water-boiling temperature was not reached at any of the deeper locations at the bottom of the aquifer, where much of the DNAPL may be expected to reside. At 55 ft bgs at the four thermocouple locations, the maximum temperatures reached were 77, 86, 85, and 109°C, all of which are below the expected boiling point of water (120°C), and some of which are below the adjusted boiling points of PCE, TCE, and TCA. This does not imply that no CVOC mass was recovered from these locations, as some volatilization of these components will occur at lower temperatures. Rather, these results indicate that not all the recoverable CVOC mass may have been recovered during the limited period of the ERH application, and that residual CVOC/DNAPL may still remain in locations that were difficult to heat. At Bedford, heating seems to have progressed fairly efficiently in the shallower portions of the aquifer (at least until drying occurred) and both CVOC and water boiling temperatures were reached. However, at depths near the bottom of the aquifer (near the clay layer at 55 to 60 ft bgs), heating was insufficient to reach the designed temperatures. Much of the steaming and condensate generation appear to have occurred in the shallower portions of the aquifer.

At Cape Canaveral, the highest CVOC daily mass recovery rates were experienced when temperatures reached the normal boiling point of water; this meant reaching 100 °C at the water table and approximately 120°C at 45 ft bgs, immediately above the aquitard where most of the DNAPL resided. Achieving water boiling temperatures near the aquitard can be a challenge when the aquitard is relatively deep, because the temperature differential between boiling temperatures near the water table and near the aquitard can be relatively high (almost 20°C at both Cape Canaveral and NWIRP Bedford). At NWIRP Bedford, where the aquitard was 55-60 ft bgs, water boiling temperatures were reached in the shallower portions of the aquifer, but not near the aquitard. One feature that is common at all five of the EH sites reviewed is that the temperature-versus-depth profiles tend to curve inwards in the last 5 ft or so of the target heated zone of the aquifer. In other words, the maximum temperature achieved in the aquifer occurs approximately 5 ft above the lowest depth targeted for treatment (or the lowest depth where electrodes penetrate). One explanation could be that cooler water enters the treatment zone from the surrounding aquifer at this lowest depth to replace the heated water and vapors that rise upwards due to buoyancy. This is a challenge for the ERH application because DNAPL often occurs in the lower parts of the aquifer, near the aquitard.

At former NAS Alameda, achieving an average aquifer temperature of 92°C was planned because a previous pilot study at this site had shown that temperatures plateaued at an average of 92°C in this aquifer, despite additional power input. This is a difficult challenge to overcome. An average temperature of 92°C could mean that temperatures were above and below this average at various locations in the target treatment zone, leading to uneven recovery of CVOCs. In Heating Cell 5 at former NAS Alameda, there was a considerable rebound in CVOC concentrations in monitoring well MW6S, four months after ERH application ended. The rebound occurred even though the closest thermocouple (TWD-I-14) showed that the boiling temperatures of the two primary components, TCA (65°C) and TCE (73°C), were exceeded at this location. Temperatures approached water boiling point (100°C) only on November 1, 2004, just five days before electrical power application ended. A second sharp increase in CVOC mass removal rate is visible around this time (the first sharp increase occurred as temperatures reached the boiling points of the CVOCs). CVOC mass recovery rates were still relatively high when power application was stopped. It is possible that additional heating would have enabled greater recovery of CVOCs. However, by June of 2006, the rebound at MW6S had subsided as discussed in Section 7.2 below. There were no monitoring wells in Heating Cells 2 and 4 at Alameda, so other locations could not

be similarly evaluated. In Heating Cells 1 and 3, much of the CVOC mass had been removed during a previous pilot test.

At Charleston Naval Complex, daily PCE recovery rates in the vapor phase rose moderately from 0.5 lb/day at ambient temperatures to approximately 1.0 lb/day, approximately two months after the ERH start date. This corresponds approximately to the time when the expected boiling point of PCE (89°C at 7 ft bgs) was reached in the shallow portion of the aquifer. The mass recovery rates remained at this level until six months after the ERH start date, when recovery rates rose to 1.5 and then peaked at 2.75 lb/day. This corresponded approximately to the time when the PCE boiling temperature (92°C) was reached at the bottom of the target treatment zone (11 ft bgs). Toward the end of the treatment period, water boiling temperatures were reached only in the shallower portions of the target treatment zone, but not in the deeper portions, where much of the DNAPL was suspected to reside. Because of this, the average reduction in PCE concentrations in the targeted groundwater was a relatively modest 65%, when pre-treatment concentrations were compared to long-term measurements conducted six months after the end of ERH application. The reductions in concentration were more dramatic when pre-treatment and immediate post-treatment levels of PCE were compared, but were more modest when the PCE rebound in several wells was taken into account. These results indicate that, although some PCE mass was removed and recovered aboveground, considerable residual DNAPL mass probably remained in the aquifer.

The data from the reviewed sites indicate that ideally ERH application should achieve normal water boiling temperatures at all target depths and maintain these temperatures until CVOC recovery rates drop sharply. However, this is difficult to achieve in practice as seen in Table 7-2. Water boiling temperatures were reached in the shallower portions of the aquifer at all five sites, as indicated by the volumes of condensate collected aboveground. However, water boiling temperatures near the bottom of the target treatment zone were reached only at three of the sites. At Cape Canaveral, temperatures reached close to 120°C at all locations near 45 ft bgs monitored in the treatment plot. At Alameda, temperatures reached 100-101°C at about half the locations monitored at 11 ft bgs. At both these sites, the target aquifer is predominantly sandy, with relatively good groundwater recharge. At Cape Canaveral, uneven heating near the shallow water table was addressed by adding ground rods. At Camp Lejeune, water boiling temperatures were achieved at the lowest depth (20 ft bgs) where much of the DNAPL was present, but only because electrodes were installed to much greater depths (26 ft bgs) than the bulk of the contamination. The curving inward of temperature profiles at the lowest depths where electrodes (and heating) are applied was apparent at all five sites and may be a feature of cooler water entering the treatment zone to replace warmer water (and steam) that rises due to buoyancy.

At the Bedford and Charleston sites, the target aquifers had finer-grained (lower-permeability) soils and groundwater recharge was extremely slow, leading to both operational and performance challenges. At Bedford, the sandy till layers turned out to be much less permeable than originally thought and large portions of the target aquifer became unsaturated, leading to a considerable depression of the water table in the treatment zone and causing monitoring wells to dry. Although the heating efficiency in the newly unsaturated portions of the aquifer did diminish (temperatures started dropping as the saturated zones became unsaturated and, therefore, less conductive), this is presumably not a problem because it would imply that water boiling temperatures have been reached and most of the local CVOC mass has been either volatilized or steam stripped from these dried locations. Also, these newly dried regions are now subject to the vacuum applied by the vapor recovery system and, therefore, the boiling points of all the components of the system may be expected to be lower.

Drying in the immediate vicinity of the electrodes was addressed at Bedford and Charleston by introducing drip lines, whereby water is added from the ground surface to the electrodes. Typically, the water condensate recovered from the ERH operation is used to wet the electrodes. At Bedford, 42,000 gal of the 68,000 gal of condensate recovered was used in the drip lines. At Charleston, drip lines were not

sufficient. The electrode spacing had to be reduced from 14 ft to 7 ft to improve heating efficiency. Eventually, the 16,525 ft² area (11 ft deep) at this site was heated with 101 conventional electrodes, 12 sheet pile electrodes, six Geoprobe electrodes, and 310 ground rods. To optimize performance, the power supply was cycled (50 min ON and 10 min OFF per cycle), presumably to prevent drying around the electrodes. The ERH operation increased from the design duration of 124 days to an actual duration of 279 days.

At Camp Lejeune, the target aquifer contained lower-permeability soils. However, the hydraulic gradient was moderate (0.01 ft/ft), groundwater recharge occurred at a more moderate rate, heat application was controlled at a relatively slow rate, and no drying of the aquifer was evident through the monitoring wells. Also, the electrode density, ramp up and down of power to various electrodes, and the period of operation were managed in a way that overcame the challenges of the geology, although with considerable power consumption and capital and O&M cost.

In general, the issue of design temperatures needs to be addressed empirically in the field. The adjusted boiling points (azeotropic minimums) of the CVOCs in water are a good starting point for the design, but actual boiling temperatures may be higher for a variety of reasons. However, the goal of the ERH application needs to be to reach water-boiling temperatures throughout the target treatment zone for more complete DNAPL removal to occur. Temperatures can be verified in the field by installing thermocouple bundles. The temperature data, in conjunction with VOC analysis of the recovered vapors, can provide important real time information on when critical transitions in temperature occur.

7.2 Enhanced Biodegradation and Abiotic Destruction Mechanisms

One of the findings of these projects is that some microbial communities survive the heat treatment to varying degrees and may actually thrive after treatment, as the aquifer goes through an extended period of moderate temperatures during the cooling phase. This cooling phase, during which aquifer temperatures remain moderately elevated, can last several months. At Cape Canaveral, microbial counts were diminished in some regions of the treated aquifer, but had actually increased in other regions following the treatment. An increase in the concentrations of *cis*-1,2-DCE and 1,1-DCA (byproducts of TCE and TCA biodegradation) between monitoring events immediately after ERH operation and several months afterward was noted at both the Bedford and Alameda sites, indicating that anaerobic reductive dechlorination was stimulated at moderately higher temperatures. Similarly, *cis*-1,2 DCE levels rose in some wells between the post-treatment and long-term monitoring events at Charleston. Increases in chloride levels measured at Cape Canaveral and Alameda sites also are indicative of biodegradation of CVOCs, although at Cape Canaveral some of the chloride increase may have resulted from saltwater intrusion. Increase in BOD levels in the groundwater following ERH treatment at Cape Canaveral indicates that some portion of the natural organic matter in the soil may have degraded at elevated temperatures into more water-soluble, bioavailable fractions. This added source of organic carbon for microbial growth is beneficial for the bioremediation component of the ERH technology.

At Alameda, subsequent sampling events completed by Arizona State University (ASU) showed minimal rebound at the Alameda site as of June of 2006. The ASU data shows that even in the one monitoring well (MW-6S in Heating Cell 5) where there were some signs of a TCE and DCE rebound in March 2005 (4 months after heating was stopped in November 2004), there is evidence that concentrations of these CVOCs eventually subsided. The direct-push, multi-level sampling by ASU confirms that only very low levels of CVOCs remain in the treated zone. This continued treatment of CVOCs, after heating has stopped, is a useful feature of ERH application. As the post-ERH aquifer cools, continued volatilization, hydrolysis, and biodegradation results in further decline in CVOC concentrations. Continued biodegradation was also aided by the fact that at higher temperatures, dissolved oxygen is driven out of

the groundwater making the system anaerobic (as indicated by the low ORP and DO in the ASU samples).

At Camp Lejeune, enhanced degradation of PCA occurred through multiple pathways, as evidenced by formation of byproducts, such as TCE (by dehydrochlorination reactions) and *cis*-1,2 DCE (by reductive beta-elimination). PCA degradation by hydrogenolysis (to 1,1,2-TCA), an often-quoted mechanism for PCA reduction, was not much in evidence at this site.

The enhanced biodegradation phenomenon is advantageous for two reasons. One is that the biodegradation of any post-ERH treatment residual CVOCs has the potential to continue at a higher rate than the natural rate before treatment. Secondly, given the fact that uneven heating may occur in tighter formations or in heterogeneous aquifers, enhanced biodegradation may play a predominant role in regions of the aquifer that are heated to temperatures below boiling.

Other CVOC treatment pathways that have been claimed during or after ERH application include enhanced rate of reactions, such as hydrolysis (whereby hydrogen ions in the water displace chlorine atoms on the CVOCs) and beta-elimination (reduction). Both these processes theoretically are enhanced at higher temperatures, in accordance with the Arrhenius equation. However, a concerted effort to determine the nature and extent of these reactions has not yet been conducted.

7.3 Operational Issues

As with any remediation technology, there were operational challenges at the ERH application sites. In most cases, the ERH vendors have proved resourceful at addressing these challenges through engineering modifications as experience with ERH has grown, and it may be possible to anticipate and address these issues during the design phase at future sites. Some of the operational issues that were encountered at the five sites reviewed are:

- Drying of the soil around the electrodes in tighter formations at the Bedford and Charleston sites. This problem was addressed by recycling the recovered water condensate to the electrodes through drip lines. At Charleston, power application was cycled (50 min ON and 10 min OFF) to prevent overheating around the electrodes.
- Entry of fine silts in the vapor recovery system and condenser in sites that have fine-grained soils. This led to several maintenance-related shutdowns at the Bedford site. Steel shots were added to the co-located vapor recovery and electrode wells and power application was reduced. This seemed to address the problem.
- Containment of contamination within the target treatment zone. This is an issue that has not been adequately investigated at ERH sites. At Bedford, Charleston, and Alameda sites, when ambient air samples were collected at shoulder level in or at the perimeter of the treatment zone, there were no elevated CVOC levels. At Cape Canaveral also, there were no elevated CVOCs in the ambient air at shoulder level, but when air samples were collected close to the ground, CVOC levels were considerably higher. At Cape Canaveral, there were some unique circumstances, such as the shallow water table that rose still further during two hurricanes and the consequent loss of vadose zone. Also, Cape Canaveral was an early application and experience with ERH has grown since then. Although data are sporadic because of the difficulties in conducting measurements in the heated zone, it does appear that in the more permeable (predominantly sandy) aquifers at

Cape Canaveral and Alameda, heating may have led to expansion of the water and mounding in the treatment zone and a consequent migration of hotter groundwater to surrounding areas, as indicated by the temperature maps. Presumably, this would indicate an influx of cooler water into the treatment zone from the bottom of the aquifer. However, only at Cape Canaveral was there an increase in CVOC levels in perimeter wells in the direction of hot water transport. At Alameda, perimeter wells did not show elevated CVOC levels. In less permeable formations, such as at Bedford and Charleston, there was lowering of the water table in the treatment zone because of the slow recharge from surrounding areas. Controlling the migration of DNAPL and CVOC dissolved phase and vapors during ERH application is a challenge that may have to be addressed differently at different sites.

7.4 Performance Monitoring

The experience at these ERH sites indicates that there are two challenges in monitoring the performance of the treatment action. One is the challenge of accessing and sampling the monitoring wells in the treatment zone during or immediately after ERH application. Safety issues associated with sampling the hot zone include pressure buildup in the wells due to accumulation of steam. Also, care has to be taken to cool the hot water sample as it is withdrawn from the ground, so that VOC losses to the atmosphere are minimized. Drying of wells due to a depression of the water table during ERH treatment was encountered at Bedford, a site with low-permeability soils. At Charleston, which has a low-permeability aquifer too, much slower heating appears to have avoided this problem to some degree. At Alameda, where the aquifer is much more permeable, drying was encountered locally in only one of the wells. If monitoring wells become dry during heating and cannot be sampled for several days after the ERH operation due to slow recharge of groundwater, influx of water from surrounding untreated areas can impact the groundwater monitoring results.

The other monitoring challenge is inherent in the nature of DNAPL contamination. For one, estimates of pre-treatment or post-treatment DNAPL or total CVOC mass in the target zone are notoriously inaccurate, whether they are obtained through an extrapolation of concentrations of CVOCs in soil or in groundwater. The amount of CVOC mass recovered aboveground in the extracted vapor is a somewhat better parameter that provides information on the degree of success of the operation, although it is dependent on the accuracy of the vapor flow measurements and the periodic vapor sampling and analysis conducted during the ERH operation. In addition, even if these estimates were accurate, the difference between the pre- and post-demonstration DNAPL mass estimates and the amount of CVOC mass recovered aboveground are unlikely to match because of other pathways (e.g., biodegradation or hydrolysis) that the CVOCs may take.

Therefore, it is difficult to obtain a direct measurement of the primary performance measure, which is the DNAPL/CVOC mass still left in the aquifer after ERH. Long-term post-treatment monitoring several months after the end of ERH operation provides some indication of the extent of residual DNAPL in the aquifer. If CVOC rebound in the monitoring wells is muted in the longer term, then most of the DNAPL has been removed. If the concentrations of CVOC parent compounds or byproducts start increasing in the long term, there probably are DNAPL residuals in the vicinity. All five sites that were reviewed followed this methodology. The problem with this approach is that the degree of completeness (or incompleteness) of the treatment is discovered several months after the ERH system has been demobilized. A shorter-term performance measure is needed to determine an appropriate endpoint or exit strategy for the ERH application.

An indirect measure that appears to have been a relatively good short-term indicator of the degree of DNAPL removal at the four sites reviewed is aquifer temperature. At all four sites, wherever the design temperatures were reached, subsequent sampling showed that DNAPL has mostly been removed from those locations. Monitoring wells in the vicinity where design temperatures were achieved showed muted rebound of CVOCs in the long term. Monitoring wells in the vicinity where design temperatures were not met and maintained for a suitable amount of time showed rebound in CVOC concentrations in the long term. There is some disagreement as to what these design temperatures should be. Based on Dalton's Law of Partial Pressures, it is claimed that a mixture of CVOCs in water will boil at a temperature lower than the boiling point of water and, perhaps, lower than the boiling points of some of the individual CVOC components (if the component forms a minimum boiling azeotrope with water). However, the experience at the five reviewed sites shows that the best results were achieved when the adjusted boiling points of the CVOCs were met or exceeded and the boiling point of water (adjusted for depth) had been reached, as evidenced by the sharp increase in CVOC levels in the aboveground recovered vapors. Just as there are factors (e.g., partial pressures) that depress the boiling points of the mixture, there may be factors that elevate the boiling point of the mixture (e.g., presence of dissolved salts, such as chloride and/or sulfate, in the groundwater).

Steam generation generally has been achieved at all five sites, as evidenced by the volume of water condensate collected. However, it is possible that most of the steam generation occurred in the shallower portions of the aquifer at some sites, as the required temperatures at depths near the aquitard were not reached. Steam generation aids in CVOC removal by adding steam stripping to volatilization as a removal mechanism. A combination of temperature monitoring at various depths at various locations in the treatment zone and an analysis of the daily CVOC recoveries in the vapor phase is a good determinant of ERH performance and a guide of any system adjustments (such as addition of ground rods) that may be required to improve temperatures at certain locations. Temperature is a relatively inexpensive measurement and can be made at several depths at several locations in the target treatment zone.

7.5 Costs

Table 7-3 summarizes and compares the costs of the ERH applications at the five sites reviewed. The total costs are presented, as well as an "adjusted vendor cost" value. The "adjusted vendor cost" includes the costs incurred by the vendor for the treatment only; other project costs, such as site characterization and site preparation, that were incurred by the site owners or their prime contractors are not included, as they are subject to many other factors not related to the ERH technology itself. The last column in this table that calculates cost per unit volume of aquifer treated is included because it is a common way of representing the unit cost of an in-situ treatment technology. Caution should be exercised in interpreting the unit cost number though because factors other than scale of operation are built into these costs –such as the varying degree of geologic complexities at a site and/or how long the treatment was applied.

The total treatment cost was relatively high at Camp Lejeune because the aquifer volume treated was large and heating was implemented slowly to prevent drying of the electrodes at this relatively-low permeability site. An extra effort also was made at this site to reach water boiling temperatures and maintain the aquifer at those temperatures for a substantial amount of time, until VOC recovery rates in the vapor phase dropped. Several orders of magnitude higher VOC mass was recovered from Camp Lejeune, in conjunction with the high volume treated. Camp Lejeune was the site where the CVOC rebound was the most muted in the monitoring wells several months after ERH treatment ended, indicating that DNAPL removal probably was more complete at this site and the higher cost incurred was fruitful. Former NAS Alameda was the other site where treatment costs were relatively high, primarily due to the amortized equipment cost because equipment was purchased rather than leased for this site. At the other three sites, the treatment costs were \$1M or less and the treatment volumes were commensurately low.

At these five sites, because the treatment volumes were very different, the desired temperatures were reached with varying degrees of success, and varying degrees of rebound were experienced post-ERH treatment (indicating varying degrees of residual contamination), it is difficult to correlate the costs at the various sites to their geology. However, the difficulty in reaching desired temperatures at lower-permeability sites (e.g., Bedford), the possibility of non-uniform heating and drying in complex geologies (e.g., Bedford and Charleston), and the need for slower heating and longer times to reach desired temperatures and maintain the aquifer at those temperatures (e.g., Charleston and Camp Lejeune) all point to the probability that all other things being equal, ERH application is likely to be more time consuming, more difficult, and more costly in lower-permeability aquifers.

7.6 Summary of Lessons Learned

The review of ERH application at the five sites provided considerable information on the performance and challenges at different types of sites. The lessons learned from the review are summarized as follows:

- In addition to contaminant removal and recovery goals, one design goal of the ERH treatment should be to reach the desired temperatures in all portions of the target treatment zone.
- Thermocouple bundles at several depths at several locations in the treatment zone are a cost-effective way of obtaining important temperature information.
- The design temperatures should be based on the adjusted boiling points of the individual CVOCs and of water (after accounting for depth). The adjusted boiling points of CVOCs in the aquifer are lower than their normal boiling points as pure phase in air because many CVOCs form minimum boiling azeotropes with water (the boiling point of the CVOC in an aquifer is expected to be below the normal boiling points of both the CVOC and water).
- Daily recovery rates of CVOCs in the vapor phase increase sharply when the adjusted boiling points of the individual major components are reached, and increase sharply again when the boiling point of water has been reached.
- The actual boiling points of the CVOCs and water in an aquifer could be different from the theoretical predictions of normal boiling points (of pure phase) and adjusted boiling points (minimum boiling azeotropes of CVOC in water) due to several reasons. Firstly, these predictions of adjusted boiling points are based on our understanding of binary systems, whereas a typical aquifer is a mixture of more than two components. Secondly, the presence of non-volatile solutes (e.g., chloride, sulfate, etc.) in the groundwater can drive the boiling points upwards. That said however, the experience at the five sites reviewed does seem to show increased recovery of CVOCs at certain critical temperatures predicted by these adjusted boiling points.
- In general, the best results are achieved when the actual boiling point of water (the normal boiling point of water of 100 °C, adjusted for depth) is reached in the aquifer. When this temperature is reached and maintained for several days, CVOC and DNAPL removal is likely to be more complete. If the site characteristics make this difficult, at least the adjusted boiling points of the major parent CVOCs should be reached.
- Achieving the desired temperatures is more difficult in low-permeability formations than in higher-permeability aquifers. Drying around the electrodes, depression of the water table, and the inefficiencies of heating newly unsaturated

regions of the aquifer can reduce heating efficiency. Considerably slower heating and longer durations may be required at low-permeability sites.

- In the short-term, aquifer temperature is the best parameter that indicates successful DNAPL removal. Therefore, achievement of design temperatures in all parts of the target aquifer is a good performance goal.
- Temperatures and daily CVOC mass recovery rates can be used together to determine a suitable exit point for the ERH application.
- In the longer-term, continued groundwater monitoring is a good indicator of DNAPL removal performance. A rebound in CVOC levels in a monitoring well would indicate that there still is residual DNAPL mass in the vicinity.
- In addition to volatilization and steam stripping, enhanced biodegradation and other abiotic reactions at elevated temperatures were an active mechanism at all five sites. Degradation of some components of organic matter at elevated temperatures and the consequent increase in the availability of a carbon source is advantageous for bioremediation.
- Accumulation of *cis*-1,2-DCE after ERH treatment at sites, such as Bedford and Cape Canaveral, may indicate that suitable microbial populations to take the treatment to completion may not be present at some sites or may be small enough that they would require additional stimulation to treat byproducts, such as *cis*-1,2-DCE and 1,1-DCA. At other sites, such as Camp Lejeune, byproducts, such as *cis*-1,2-DCE, themselves degraded substantially in the 6 months following the end of ERH application. Because the aquifer temperature remains elevated for several months following ERH application (cooling is slow at many sites), enhanced biological and abiotic reactions can alleviate residuals, as long as suitable microbial populations are present.
- Experience in engineering the ERH application has grown over the years. Many of the operational challenges at these sites were addressed by the vendor in innovative ways. The ERH application, including the vapor recovery system, has to be engineered differently for different sites, taking into account factors such as the permeability of the formation, groundwater recharge rates, depth of water table below ground surface (initial thickness of vadose zone), properties of the target CVOCs, and locations of DNAPL.

In general, the experience with ERH in the unconsolidated soil environment at these five sites indicates that there currently are no identifiable limitations to the type of site that can be remediated with this technology (none of the sites reviewed were bedrock aquifers). Difficulties were encountered in certain geologies, such as the low-permeability low-gradient aquifers at Bedford, Charleston, and to a certain extent Camp Lejeune. At Charleston, it took much longer than site representatives expected to bring the site close to the desired temperatures, but after some system adjustment, they did succeed in heating the aquifer close to the desired temperatures, although ERH application was stopped soon afterwards (possibly for budgetary reasons). With continued heating, more DNAPL mass could possibly have been recovered. At Camp Lejeune, site representatives were able to control the heating well enough to prevent drying of the low-permeability aquifer, reach the desired temperatures, and maintain the aquifer at those temperatures until VOC levels in the recovered vapors dropped. Although relatively higher costs were incurred in achieving a high level of treatment in difficult geology, this project did show that it was technically feasible to achieve and

maintain the temperatures required to remove DNAPL to levels where subsequent rebound of CVOCs in monitoring wells is muted.

In sandy aquifers, such as at Cape Canaveral and Alameda, ERH was more successful than at Charleston and Bedford, although final TCE levels and rebound in some monitoring wells indicated that heating was not as uniform as it could have been. One could also conceive of a situation in which higher power consumption, longer heating times, and higher costs are incurred in a high-permeability, high-gradient aquifer, in which the groundwater recharges at a rate that makes it difficult for ERH to reach and maintain temperatures. At Cape Canaveral, there was a building overlying a portion of the ERH treatment area, so that is not a major obstacle. Depth too has not been a significant limitation for the technology with relatively successful applications at shallow sites (e.g., Alameda) and relatively deeper sites (e.g., Bedford).

Therefore, rather than identifying site characteristics that would make ERH feasible or not feasible, future sites would have to be viewed as a continuum of sites from relatively easy to relatively difficult, based on the experience at these five sites. The relatively easy sites would be ones with higher permeability, moderate hydraulic gradient, contaminants that boil at azeotropic minimum temperatures below the boiling point of water, and with most of the contamination occurring in a relatively small volume of the aquifer. The relatively difficult sites would be ones with lower permeability and lower hydraulic gradient, higher permeability and higher hydraulic gradient, contaminants that do not form minimum boiling azeotropes with water, and contamination dispersed over a large volume of the aquifer.

Table 7-1. Contaminants Boiling Temperatures *

Compound	Normal Boiling Points of Compounds	Adjusted Boiling Points (Azeotropic Minimums) for CVOCs in Water	
		At Water Table (1 atm)	20-22 ft Below Water Table
Pure water	100	100	120
1,1-Dichloroethane (DCA)	57	53	71
1,1-Dichloroethene (DCE)	32	32	48
<i>cis</i> -1,2-Dichloroethene (<i>cis</i> -DCE)	59	54	72
Tetrachloroethene (PCE)	121	88	107
1,1,1-Trichloroethane (TCA)	74	65	84
Trichloroethene (TCE)	87	73	92
1,1,2,2-Tetrachloroethane	147	94	108

* Adapted from information provided by the ERH vendors (Thermal Remediation Services and Current Environmental Solutions)

Table 7-2. Characteristics of ERH Application Sites

Site	Primary Constituent of Concern (Not Including Daughter Products)	Hydraulic Conductivity (Order of Magnitude)	Predominant Soil Type	Maximum Temperature Reached at Lowest Depth
NWIRP Bedford	TCE	10^{-5} to 10^{-7} cm/s	sandy till	109°C at one location at 55 ft bgs, <90°C at other locations at 55 ft bgs
Cape Canaveral, Air Station	TCE	10^{-3} cm/s	predominantly sandy with one silt lens	120°C at all measured locations at 45 ft bgs
Naval Complex Charleston	PCE	10^{-4} cm/s	sands, silts, clays	100°C measured one time only at one location at 11 ft bgs, 95°C at other locations at 11 ft bgs
Former NAS Alameda	TCA, TCE	10^{-5} to 10^{-8} cm/s	fine to medium-grained sand	100-101°C at 12 of the 25 locations at 12 ft bgs
MCB Camp Lejeune	PCA, TCE	Variable (interbedded low- to moderate-permeability soil)	fine to medium sand, with interbedded silt and clay layers	128°C at 20 ft bgs in central thermocouple, 110°C average aquifer temperature at 20 ft bgs. At the lowest targeted depth of 25 ft bgs, the average aquifer temperature was 80°C. (92°C in the centrally located thermocouple)

Table 7-3 Summary of Costs and Operating Features of the ERH Applications

Site	Approximate Volume of Aquifer (ft ³)	Aquifer Type	Approximate number of Days of ERH Application	Estimated Mass of VOCs Recovered from Subsurface (lbs)	Total Project Cost	Adjusted Vendor Cost ^(a)	Cost per Unit Aquifer Treated
NWIRP Bedford	112,000	Low-permeability, Low gradient	53	90	\$1.2M	\$658K	\$5/ft ³
Cape Canaveral, Air Station	169,000	High-permeability, High gradient	270	4,283 (TCE)	\$868k	\$569K	\$4/ft ³
Naval Complex, Charleston	135,000	Low-permeability	279	247	\$1.3M	\$1M	\$7/ft ³
Former NAS Alameda	133,470	High-permeability	105	3,000	\$4.7M	\$2.7 ^(b)	\$20/ft ³
MCB Camp Lejeune	349,000	Low-permeability, Moderate gradient	173	48,000	\$2.2M	\$1.7M	\$5/ft ³

Note:

(a) Does not include site preparation, site investigation, project oversight and management, and other costs incurred by the site owners and site contractors

(b) Adjusted vendor cost for Alameda includes the amortized equipment cost over three sites and other costs as described in Section 5.7. It does not include the design/planning costs.

Section 8.0: REFERENCES

- Battelle. 2003. *Demonstration of Resistive Heating Treatment of DNAPL Source Zone at Launch Complex 34 in Cape Canaveral Air Force Station, Florida. Final Innovative Technology Evaluation Report, Prepared for the Interagency DNAPL Consortium.* Prepared by Battelle, Columbus, Ohio. February 19.
- CH2M-Jones. 2003. *Interim Measure Completion Report/ CMS Work Plan/ Investigation Work Plan-AOC 607, Zone-F, Charleston Naval Complex, Charleston, South Carolina.* November.
- CH2M-Hill. 2002. *Electrical Resistive Heating, Pilot Study Workplan, Operable Unit 16 (Site 89), Marine Corps Base, Camp Lejeune, North Carolina.* July.
- Current Environmental Solutions. 2004. *Operational Reports #1 to #26. Electrical Resistance Heating Pilot Study at Site 89, Camp Lejeune, NC.* Prepared for Shaw Environmental, Inc. May 3.
- Current Environmental Solutions. 2001. *Demonstration of Six-Phase Heating™ Technology for DNAPL Remediation at Launch Complex 34 in Cape Canaveral, Florida.* Prepared for MSE Technology Applications, Inc., Butte, Montana, by Arrent Environmental Solutions, Richland, Washington.
- ESTCP. 2000. *Cost and Performance Report, Electromagnetic Surveys for 3-D Imaging of Subsurface Contaminants.* November.
- GWRTAC. 2003. *In-Situ Thermal-Enhanced Remedial Technologies.* September.
- Shaw. 2005a. *Field Activities Report, DNAPL Source Removal Action, Installation Restoration Site 5, Plume 5-1, Alameda Point, Alameda, California.* November.
- Shaw. 2005b. *Final OU-16 (Site 89) Electrical Resistive Heating Pilot Test Implementation Report MCB Camp Lejeune, North Carolina.* July
- Tetra Tech. 2005a. *Draft Closeout Report for Thermal Treatment Pilot Test, Naval Weapons Industrial Reserve Plant, Bedford, Massachusetts.* April.
- Tetra Tech. 2005b. *Feasibility Study Site 3 Naval Weapons Industrial Reserve Plant, Bedford, Massachusetts.* Comprehensive Long-Term Environmental Action Navy (CLEAN) Contract.
- U.S. EPA. 2005. *Cost and Performance Report, Electrical Resistive Heating at the Charleston Naval Complex, Charleston, South Carolina.* June.