

# A PROTOTYPE CESIUM CLOCK ENSEMBLE FOR THE LORAN-C RADIONAVIGATION SYSTEM

**LTjg. Aaron P. Dahlen**  
**United States Coast Guard**  
**Loran Support Unit**  
**12001 Pacific Ave**  
**Wildwood, NJ 08260-3232, USA**  
**Tel: 609-523-7204; Fax: 609-523-7320**  
**E-mail: *Aaron.P.Dahlen@uscg.mil***

## Abstract

*This paper presents a prototype real time clock ensemble designed for semi-autonomous operation at unmanned Loran-C radionavigation transmitting stations. This clock is designed to mitigate a doomsday scenario where all space-based timing assets are lost. It is implemented using three free-running commercial cesium oscillators, a traditional measurement system, and an Auxiliary Output Generator (AOG) phase-locked to the weighted mean of the cesium ensemble. A relatively inexpensive rubidium oscillator is used as the AOG with Proportional Integral (PI) compensator steering. A robust design ensures continuous clock operation when several components have failed or are otherwise unavailable. Measurements are made to multiple external timing sources, any one of which may be used to discipline the clock. The clock maintains a  $\pm 15$  ns phase difference relative to UTC via GPS without user interaction. Additionally, it has been shown to maintain  $\pm 50$  ns for 70 days upon loss of all external timing reference. The clock is currently disciplined using one-way GPS broadcasts. Future implementation may include the ability to discipline using all-in-view GNSS and Two-Way Satellite Time and Frequency Transfer (TWSTFT).*

## I. INTRODUCTION

In the mid-1990s, the Coast Guard Loran Support Unit (LSU) Wildwood undertook an initiative to modernize the Loran-C system. One aspect of this modernization was the upgrade of the 1970s-era timing system to include modern cesium oscillators and FPGA-based timing generators. Each upgraded station is equipped with three Hewlett-Packard (now Symmetricom) 5071A cesium oscillators, which are disciplined to one-way GPS signals utilizing the linear phase microstepper integrated into each cesium oscillator. While this modernized Loran-C system performs admirably, it is desirable to further harden the system to maximizing holdover performance in the event of a total loss or localized jamming of the GPS system. An additional impetus was the 7 February 2008 announcement by the Department of Homeland Security that eLoran would complement the “Global Positioning System (GPS) in the event of an outage or disruption in service” [1].

## Report Documentation Page

*Form Approved*  
*OMB No. 0704-0188*

Public reporting burden for the collection of information is estimated to average 1 hour per response, including the time for reviewing instructions, searching existing data sources, gathering and maintaining the data needed, and completing and reviewing the collection of information. Send comments regarding this burden estimate or any other aspect of this collection of information, including suggestions for reducing this burden, to Washington Headquarters Services, Directorate for Information Operations and Reports, 1215 Jefferson Davis Highway, Suite 1204, Arlington VA 22202-4302. Respondents should be aware that notwithstanding any other provision of law, no person shall be subject to a penalty for failing to comply with a collection of information if it does not display a currently valid OMB control number.

1. REPORT DATE <b>01 DEC 2008</b>	2. REPORT TYPE <b>N/A</b>	3. DATES COVERED <b>-</b>	
4. TITLE AND SUBTITLE <b>A Prototype Cesium Clock Ensemble For The Loran-C Radionavigation System</b>		5a. CONTRACT NUMBER	
		5b. GRANT NUMBER	
		5c. PROGRAM ELEMENT NUMBER	
6. AUTHOR(S)		5d. PROJECT NUMBER	
		5e. TASK NUMBER	
		5f. WORK UNIT NUMBER	
7. PERFORMING ORGANIZATION NAME(S) AND ADDRESS(ES) <b>United States Coast Guard Wildwood, NJ 08260-3232, USA</b>		8. PERFORMING ORGANIZATION REPORT NUMBER	
9. SPONSORING/MONITORING AGENCY NAME(S) AND ADDRESS(ES)		10. SPONSOR/MONITOR'S ACRONYM(S)	
		11. SPONSOR/MONITOR'S REPORT NUMBER(S)	
12. DISTRIBUTION/AVAILABILITY STATEMENT <b>Approved for public release, distribution unlimited</b>			
13. SUPPLEMENTARY NOTES <b>See also ADM002186. Annual Precise Time and Time Interval Systems and Applications Meeting (40th) Held in Reston, Virginia on 1-4 December 2008, The original document contains color images.</b>			
14. ABSTRACT			
15. SUBJECT TERMS			
16. SECURITY CLASSIFICATION OF:			17. LIMITATION OF ABSTRACT
a. REPORT <b>unclassified</b>	b. ABSTRACT <b>unclassified</b>	c. THIS PAGE <b>unclassified</b>	<b>UU</b>
			18. NUMBER OF PAGES <b>14</b>
			19a. NAME OF RESPONSIBLE PERSON

With these considerations in mind, LSU conducted a series of experiments to determine the performance limitation of a clock composed of an ensemble of three cesium oscillators, hereafter referred to as “the clock.” One of the most important design attributes of the clock is a robust disciplining method. The independence and flexibility gained with the ability to switch on the fly between the various sources of external timing is essential to Loran’s new role as an independent national Positioning Navigation and Timing (PNT) service [1]. While the need to disciplining the clock to UTC cannot be eliminated, the chain of unbroken calibration may be derived from multiple paths, thus providing the greatest independence from any one source of time transfer.

Leveraging the performance capabilities of the cesium oscillator trio maintained at each Loran Station is another design requirement. The clock must have the ability to freewheel (holdover) during times when external timing sources are unavailable in order to provide independent PNT capabilities. A clock with long holdover times gives the Loran system operator time to research and implement options to restore the unbroken chain of calibrations to UTC.

## II. HARDWARE DESCRIPTION

The prototype Loran clock maintains precise local time using three Symmetricom 5071A cesium oscillators (standard performance tubes). The internal phase microstepper of each cesium oscillator is disabled by setting the steering command to zero. For the duration of the LSU experiments, the cesium oscillators are characterized using the 1 PPS signal from GPS disciplined oscillators. A cesium-stabilized Timing Solutions Corporation TSC4400 GPS receiver and several TrueTime XL-DC GPS receivers were used. A block diagram of the clock’s hardware is included as Figure 1.

The data collection system consists of an Agilent 53132A Time-Interval Counter (TIC) providing 150-ps resolution. The TIC is configured to operate using an external 5 MHz obtained from a cesium oscillator. A custom-built microprocessor-controlled relay matrix is used to route the appropriate start and stop signals to the TIC. Both the TIC and relay matrix communicate serially with a Personal Computer (PC) running MATLAB<sup>™</sup> on a GNU/Linux operating system (openSUSE 10.3 distribution).

A Symmetricom 8040C rubidium oscillator is used as an Auxiliary Output Generator (AOG) to provide a physical realization of UTC. Unlike a conventional AOG, the rubidium-oscillator-based AOG is not directly connected to an external reference oscillator. Instead, the rubidium atomic oscillator itself is steered via commands received over an RS-232 port. Adjustments as small as  $2 \times 10^{-12}$  may be made to the frequency of the internal rubidium oscillator. The integral 12-channel distribution amplifier built into the 8040C greatly simplifies the signal distribution path.

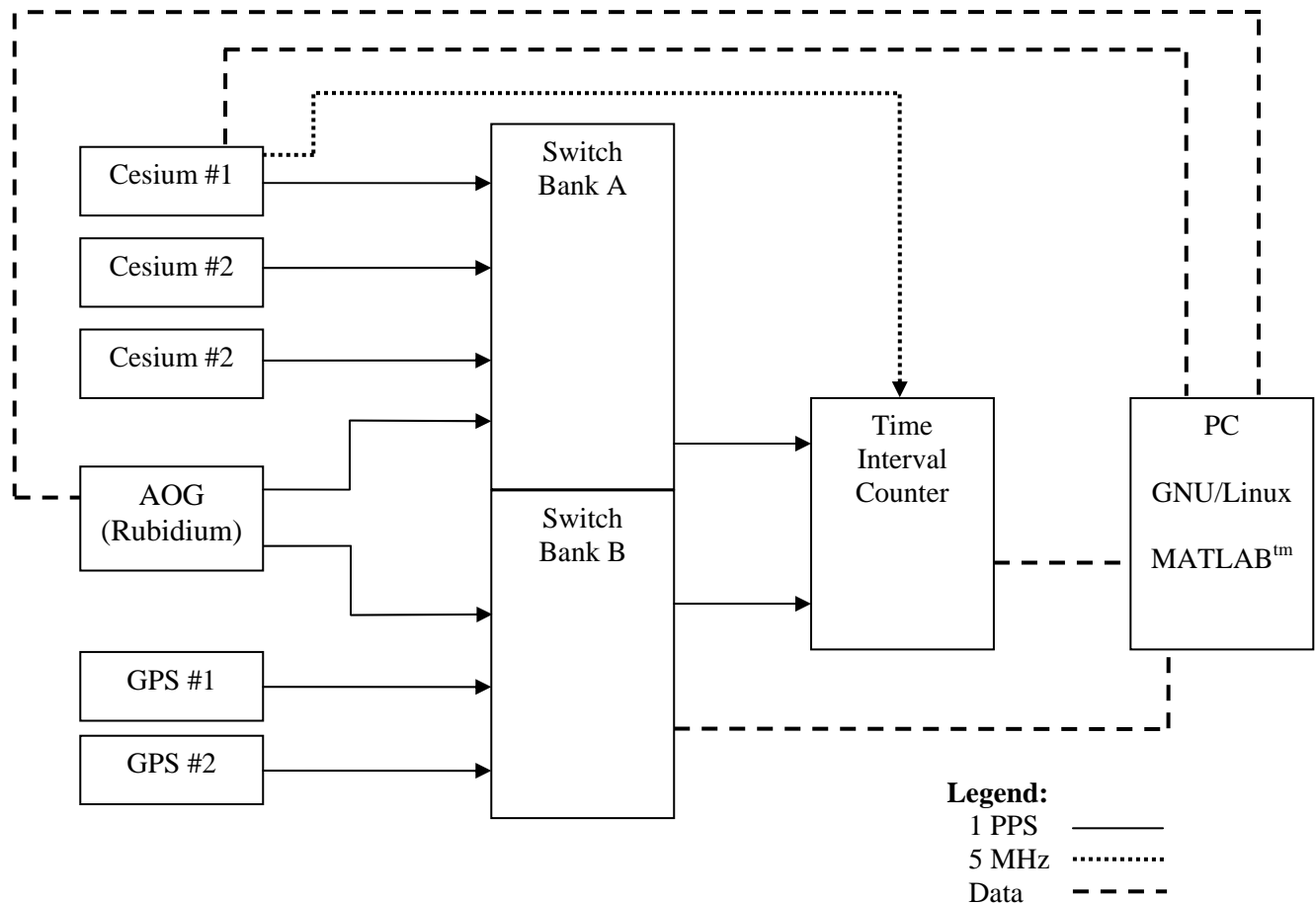

Figure 1. Interconnection block diagram of the prototype Loran clock.

### III. SOFTWARE DESCRIPTION

The software consists of five functional divisions including data collection, cesium characterization, AOG Phase-Locked Loop (PLL), GUI display, and control.

**Data Collection:** The clock Time Difference (TD) data are collected continuously using a round-robin scheduler. For the LSU experiments, the following nine TD measurements are recorded:

- CS1 minus GPS1, GPS2, and AOG
- CS2 minus GPS1, GPS2, and AOG
- CS3 minus GPS1, GPS2, and AOG

Where the selected cesium oscillator 1PPS is routed to TIC channel A and the desired GPS or AOG 1PPS signal is routed to TIC channel B.

TD measurements of the AOG minus GPS1 and GPS2 are also taken to provide direct comparison of the clock 1PPS to GPS. Additional data are collected for temperature and relative humidity.

The TD measurement system is configured to capture a data point once every 5 s. Consequently it takes approximately 1 minute to perform a complete measurement cycle. Note that at this rate the relays used in the matrix switch are rated to operate reliably for approximately 5 years.

Each data point is time stamped and stored in a flat (.txt) file. This time stamp is derived from the software clock maintained on the PC. Initial tests were conducted using the Network Time Protocol (NTP) to keep this clock synchronized. While NTP operates reliably, it is not hardened against the loss of a network connection and its use presents a potential network security risk. To mitigate the problem, software was written to synchronize the PC's clock to that of the cesium oscillator's real-time clock as communicated over the cesium oscillator's serial port (RS-232). This allows the PC clock to maintain  $\pm 2$  seconds using a highly accurate local timing source using a method similar to NTP.

**Cesium Characterization:** Three independent "paper clocks" are maintained by characterizing each free-running cesium oscillator relative to an external source of UTC. For the LSU experiments, the characterization was performed using the previous 30 days of cesium oscillator minus GPS data. A linear characterization is performed using the MATLAB<sup>™</sup> Statistics Toolbox's "robustfit" least-squares function, which has the advantage of insensitivity to outliers. The 30-day sliding window was chosen, since it is approximately equal to the noise floor of the Allan deviation plot of the cesium oscillators when compared to UTC via GPS.

Recall that a linear least-squares function represents a data set as two coefficients describing the slope and Y intercept of a line. Armed with this information, the date and a close approximation of time of day, the PC can accurately calculate the present and future phase of the cesium oscillator relative to UTC. Observe that the PC's time clock and the derived time stamps it places on each data point are part of this equation. Consequently, the previously mentioned method of setting of the PC real time clock is important to the stability of the Loran clock. Fortunately, the PC clock does not require absolute accuracy. As a worse case example, consider a cesium oscillator with frequency drift of  $5 \times 10^{-12}$  (~400 ns/day) and a PC's clock that has jumped 15 minutes. In this situation, the Loran clock would have a 4.2 ns error.

This simple method of characterizing the performance of the cesium oscillator is obviously dependent on the stability of the oscillator themselves. This is a conservative approach as demonstrated by the 11-month phase plot of LSU's cesium oscillators compared to UTC via GPS as shown in Figure 2. Observe that the cesium oscillators demonstrate a respectable degree of independence from one another. Also note that the cesium oscillators are relatively stable ( $\pm 20$  ns) for any 30-day period.

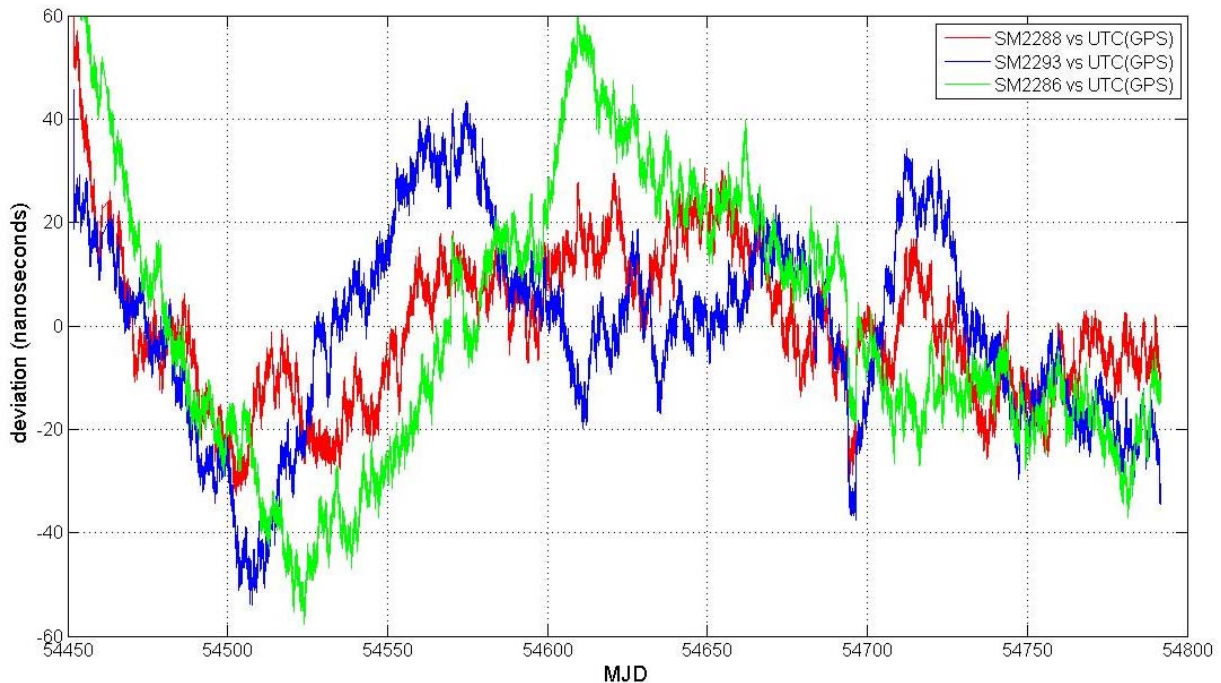

Figure 2. Phase residuals for LSU's cesium oscillator 1 PPS relative to UTC via GPS.

**AOG PLL:** The Loran timing equipment requires real physical signals (1 PPS and 5 MHz) to operate. In its normal operating mode, the clock develops these signals by phase-locking an AOG to the weighted mean of the three cesium oscillators. There are five steps to complete this operation, with each step performed sequentially on a 6-minute cycle. A functional block diagram of the AOG PLL is included in Figure 3.

**Step 1:** The phase (1 PPS) of the AOG is measured with respect to each cesium oscillator. The 6 minutes of TD data for each cesium minus AOG measurement is averaged and passed to the next function.

**Step 2:** Each cesium minus AOG TD is passed to the Cesium characterization function. This function adds the appropriate offset to compensate for the natural frequency drift of the cesium oscillator. The resulting numbers represent the error of the AOG relative to the locally maintained approximation of UTC maintained in each cesium oscillator.

**Step 3:** An ensemble weight is calculated for each cesium oscillator based on its phase relative to the other cesium oscillators (data previously conditioned by the cesium characterization function). The phase differences between each cesium oscillator pair are derived from the cesium minus AOG measurement by subtracting out the AOG, which is common to all measurements. The weighting function assigns a greater weight to oscillators that are in phase with each other. For example, if all three characterized cesium oscillators are in phase with each other, then each is assigned a weight of 33%. If a single oscillator exceeds 100 ns relative to its neighbors, then it is rejected from the ensemble and the remaining oscillators are assigned a weight of 50%. The weighting function generates a “confidence” term to guard against the possibility of all three cesium oscillators being removed from the ensemble, i.e. a failure has occurred in which all three

oscillator diverge by over 100 ns relative to each other. Should the clock ever suffer this dual cesium failure, the operator must intervene by manually configuring the clock weighting to favor the “best” oscillator(s) or switch the AOG discipline source to use an external source of timing such as GPS or TWSTFT.

**Step 4:** The individual TD errors for each cesium minus AOG TD measurement, as conditioned by the cesium characterization function, are assigned the weights generated in the previous step. The mean of all three measurements is then calculated. This single number represents the AOG’s error relative to the weighted average of all three characterized cesium oscillators.

**Step 5:** The weighted AOG error is passed to a conventional Proportional Integral (PI) compensator. This PI function is identical to that described in [2] with the slight changes to the gain parameters. The resulting PI sum is then used to steer the AOG.

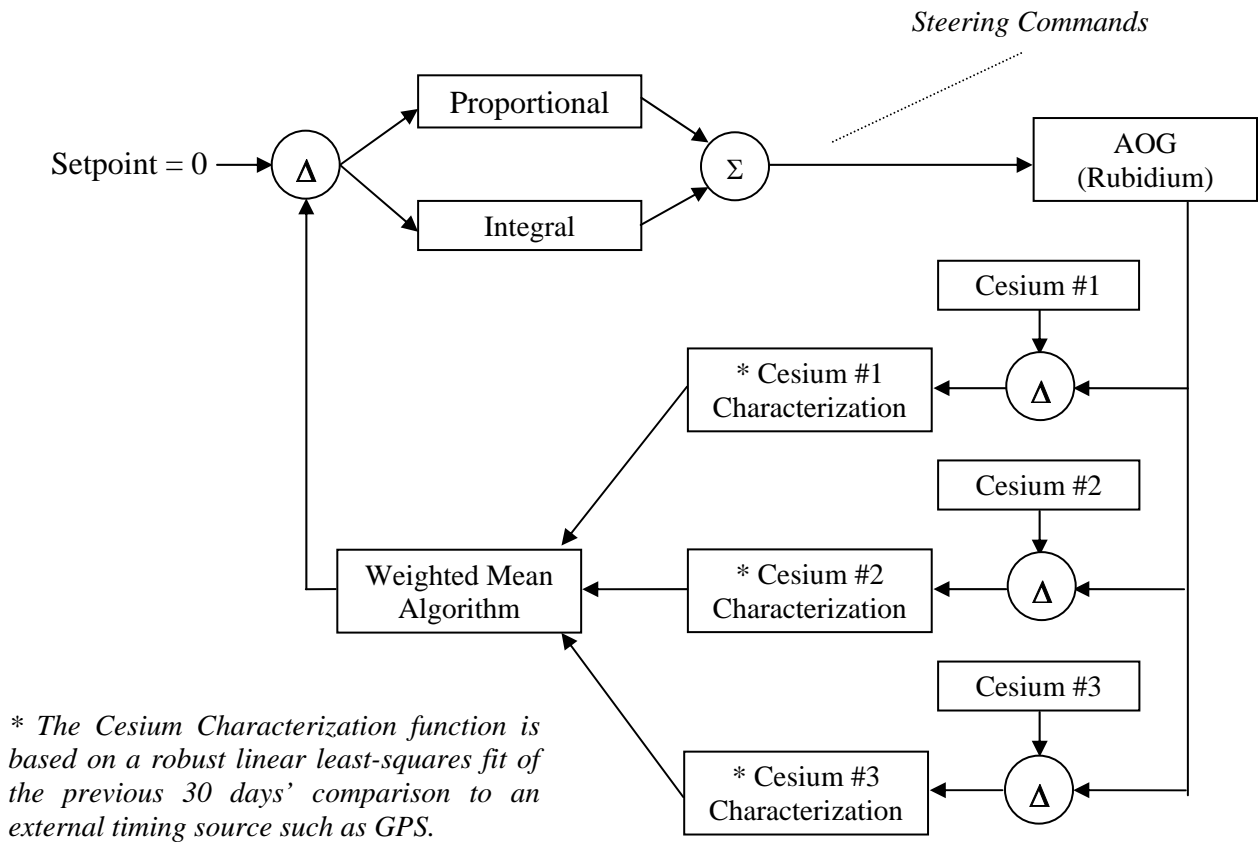

Figure 3. Functional block diagram of the Loran clock AOG Phase-Lock Loop.

**GUI Display:** Figure 4 shows the main user display for the clock. This GUI is executed separate from the previously described data collection system to minimize software interactions, thereby increasing system robustness. Communication between the programs occurs through the stored .txt archives and a single configuration file.

The “Cesium Oscillator Status” field on the left side of the GUI displays the TD of each cesium oscillator relative to the various external timing sources. Since the cesium oscillators are free-running, the displayed number is actually the current (last) reading minus the predicted value based on the 30-day characterization of the cesium oscillator. The operator may view a graph of each TD by clicking on the individual buttons. The “Disciplined to” field indicated which external timing reference is actively being used to discipline the ensemble. Note that the grayed out buttons are expected to be implemented in the future.

The center section labeled “Ensemble” contains the status of the weighting function. The confidence term alerts the operator to potentially destabilizing conditions where all cesium oscillators are rejected from the ensemble. The weights of the individual cesium oscillators are presented. There is also an indicator asserting if the weights are calculated automatically or fixed by the operator.

The field in the upper right of the GUI contains the TD measurements of the AOG relative to the ensemble’s “paper clock” and various external timing sources. It also contains the synchronization source for the ensemble. Normally, the AOG is disciplined to the cesium trio ensemble; however, it may also use external sources such as GPS or TWSTFT.

**Control:** The field in the lower right corner of the GUI contains a button to allow the operator to view the status of the clock components such as cesium telemetry, GPS health, etc. LSU is currently developing the GUI to control the configuration of the clock which will be accessed via the telecommand button. The actual controls for the Loran clock are limited to the following actions:

- select the external timing source to be used to actively characterize the cesium oscillators
- adjust the length and start date of the nominal 30-day cesium oscillator characterization window
- lock the cesium oscillator characterizing coefficients to their present value
- manually set the cesium characterization coefficients
- select automatic or manual weighting of the cesium oscillators
- set the AOG to be steered via the ensemble or the external timing reference.

## IV. PERFORMANCE

As established by a 1987 amendment to Public law 100-223, the *1982 Airport and Airway Improvement Act*, Loran is to maintain  $\pm 100$  ns from UTC [3]. For the purposes of this paper, a  $\pm 50$  ns measurement uncertainty is assumed, allowing the clock to deviate  $\pm 50$  ns.

The LSU experiments were conducted in a general purpose laboratory with moderate temperature and humidity stability. The laboratory access is generally uncontrolled and it is a main thoroughfare to a woodshop and central supply room. During the summer months, the laboratory experiences a  $\pm 5^\circ\text{F}$



diurnal temperature fluctuation and a relative humidity level that varies from 20 to 70%. Despite these less than ideal conditions, the clock performance is encouraging.

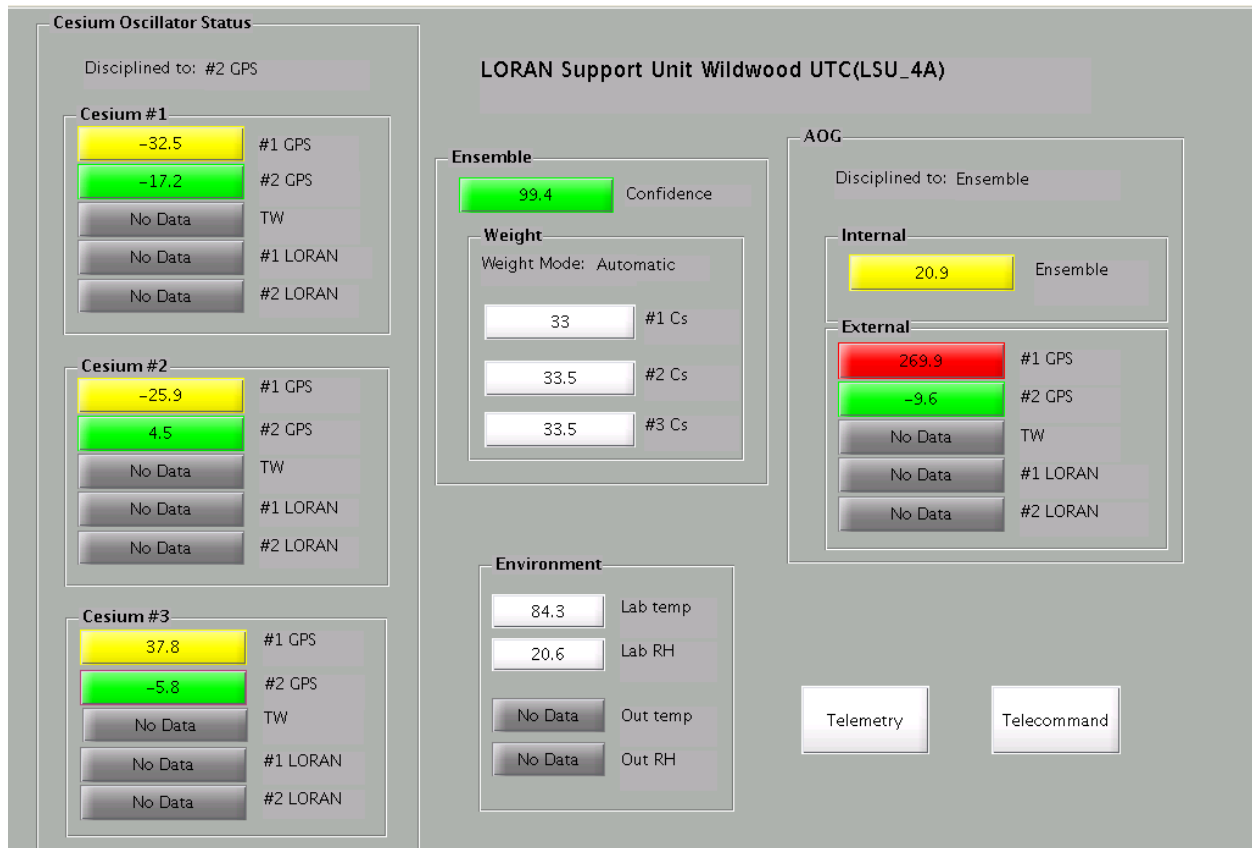

Figure 4. GUI for the Loran clock.

Figure 5 presents typical phase response for the clock under normal operating condition. Here, the 1 PPS of the AOG for UTC (LSU#2) is compared to a TrueTime XL-DC GPS receiver. The clock is seen to maintain a phase error better  $\pm 15$  ns for this 4-month period. This is well within the allotted  $\pm 50$  ns tolerance. The outliers on MJDs 54749 and 54763 are the result of operator induced computer crashes. The outlier on MJD 54753 is the result of a simulated cesium oscillator failure to be described later in this paper.

The ability to freewheel upon loss of external timing references is of paramount importance to the Loran application of the clock. Three tests were conducted to determine the ability of the clock to operate in this doomsday scenario. For each test, a failure of the external timing reference was simulated by locking the cesium characterization coefficients. These static coefficients were then used for all AOG corrections. The test obviously depends on the cesium oscillator's ability to continue past performance into the future.

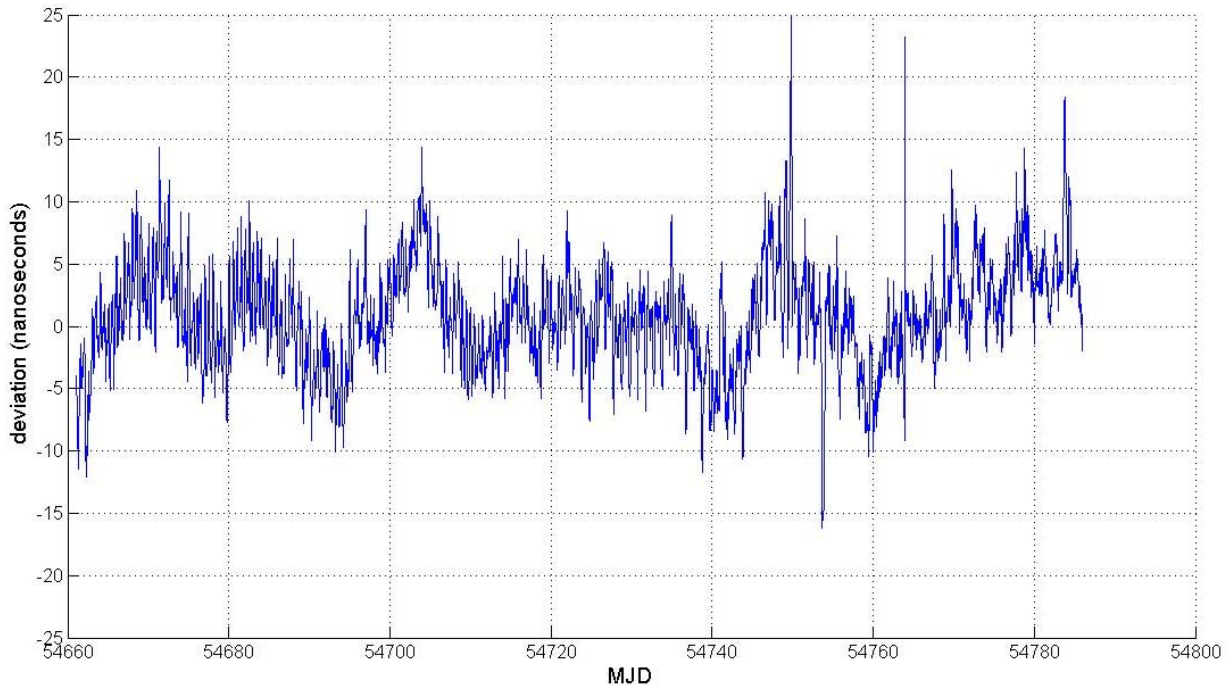

Figure 5. Typical performance of the prototype Loran clock relative to UTC via GPS (1-hour average).

The first holdover test as performed on UTC (LSU#1) lasted a discouraging 38 days before reaching the  $\pm 50$  ns phase error limit (Figure 6). Analysis of the data suggests that each cesium oscillator suffered a common disturbance during the test. This is seen in Figure 2, where the sign of the frequency drift is seen to change for all three cesium oscillators near MJD 54500. This was most likely due to an increased laboratory temperature caused by activation of the building's furnace. Holdover test #2, performed on the same equipment, displayed a significant performance improvement. The clock maintained the  $\pm 50$  ns tolerance for approximately 75 days. Holdover tests #1 and #2 were conducted on an early engineering model of the clock that did not include a weighting function. The third holdover experiment shows the clear advantage of including a weighting function. This test conducted on UTC (LSU#3) started on MJD 54728 and is still running as of MJD 54800. During this time, the ensemble phase error has deviated less than  $\pm 30$  ns relative to UTC via GPS. Of particular interest is the fact that the #2 cesium oscillator in this ensemble was gradually deweighted and removed from the ensemble.

Additional tests were conducted to determine the clock's ability to operate undisturbed after the failure of a cesium oscillator. Figure 7 presents the results of a test where the integral phase microstepper of cesium oscillator #1 was set to  $-2318 \times 10^{-15}$  ( $\sim 200$  ns/day). The ensemble is seen to follow the "failing" cesium oscillator until the weighting function gradually removes the oscillator from the ensemble. The AOG demonstrates a 15-ns phase error before returning to original tracks. Tests have also been conducted to simulate a cesium oscillator with a fast drift / jump. These types of failures are unremarkable, with little disturbance to the rubidium AOG. For all jumps greater than 100 ns, the weighting function simply rejects the cesium oscillator from the ensemble. The AOG then settles to the average of the remaining two cesium oscillators. Recall that the rubidium-based AOG is not directly connected to any cesium oscillator; therefore, the AOG's response is the same for any individual cesium oscillator failure.

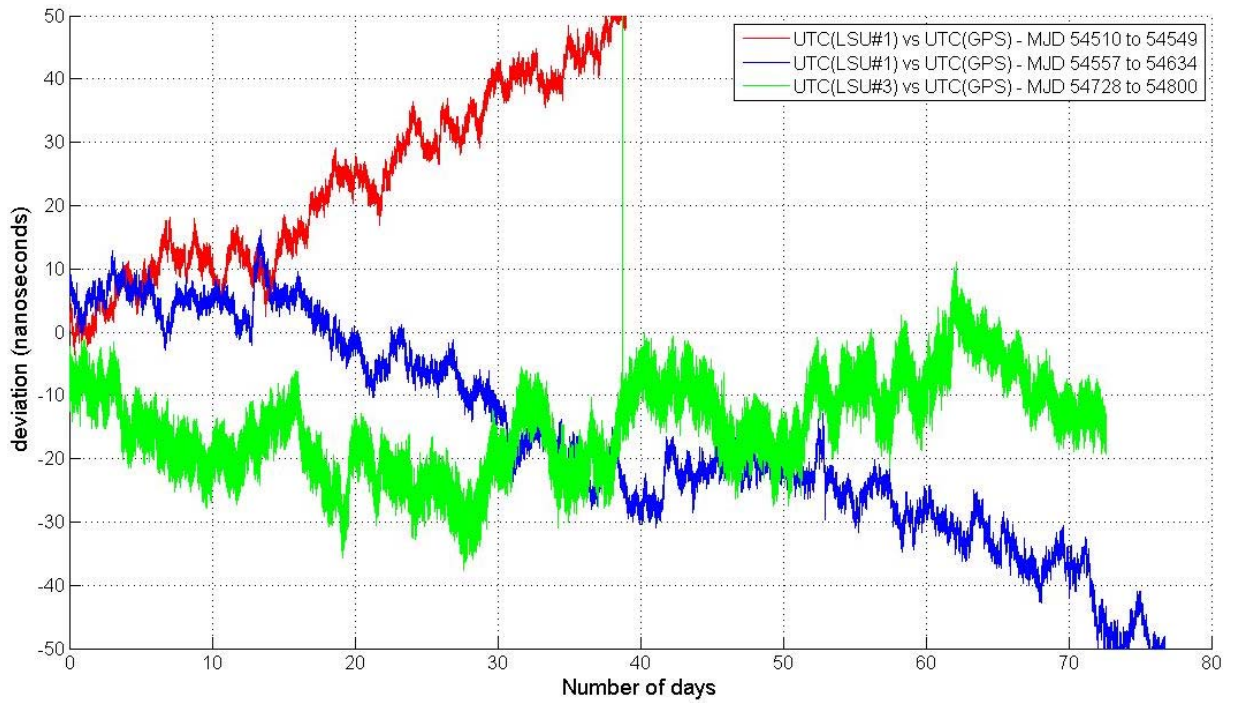

Figure 6. Result of holdover test simulating loss of external timing references relative to UTC (GPS).

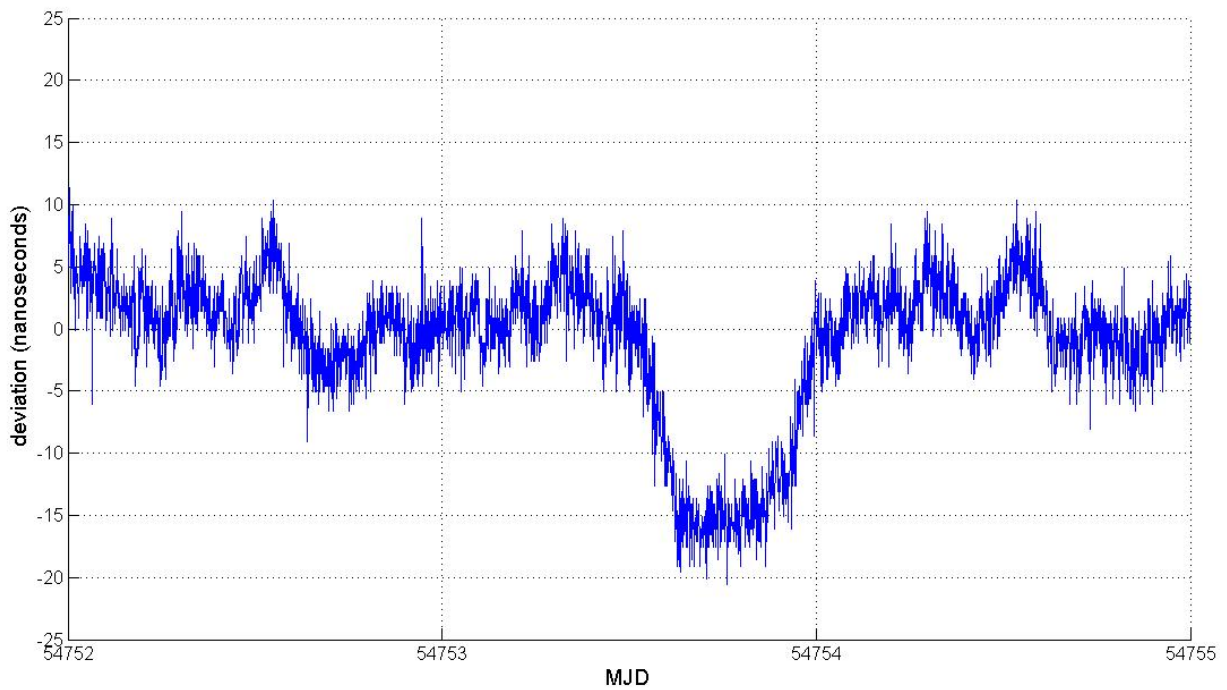

Figure 7. Ensemble response to failed cesium oscillator relative to UTC via GPS. To simulate the failure, the #1 cesium oscillator's internal phase microstepper was set to  $-2318 \times 10^{-15}$  (~200 ns/day).

A test was conducted to determine the clock's ability to shift the disciplining source between the various external timing references. On MJD 54783, Ensemble UTC (LSU#2) was switched from GPS#1 to GPS#2. On MJD 54784, the system was restored to original operation. The switch resulted in a 5-ns offset, as seen in Figure 8.

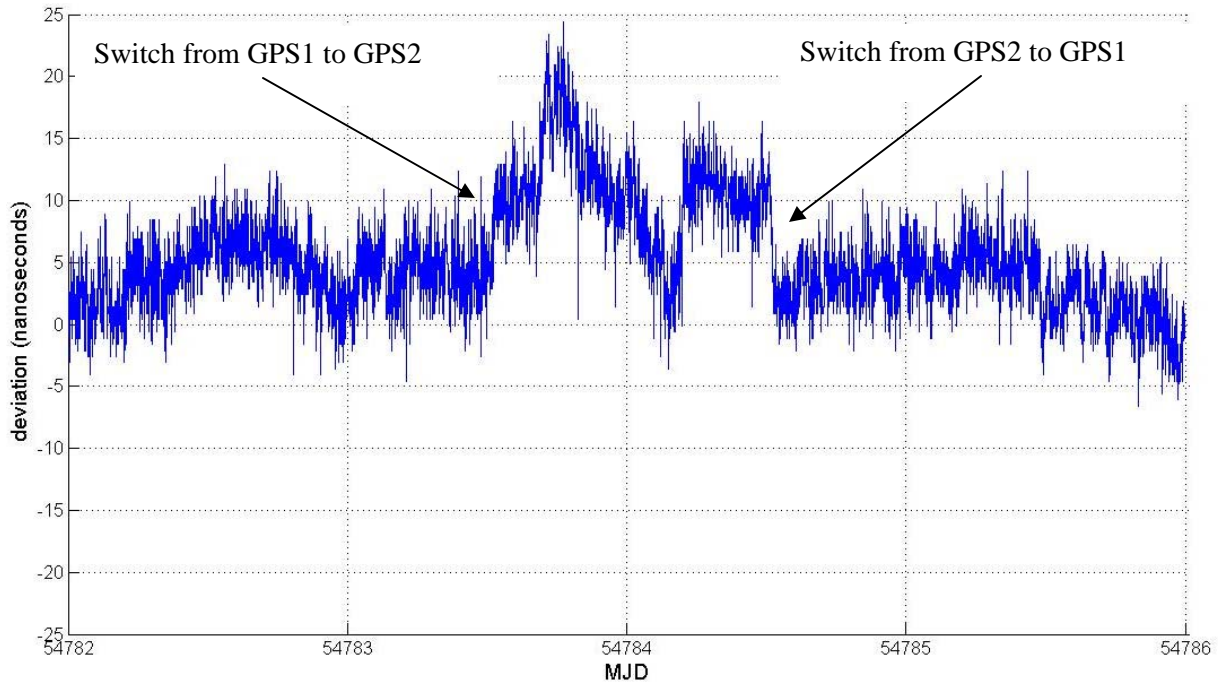

Figure 8. Shift of cesium characterization source from GPS1 to GPS2 occurred on MJD 54783. The cesium characterization source was returned to GPS1 on MJD 54784. The AOG is shown relative to UTC via GPS.

The performance of the rubidium AOG PLL is encouraging. The typical performance is shown in Figures 9 and 10, where the phase of the AOG is compared to the ensemble (weighted mean of the three characterized cesium clocks). The noise in the phase plot is largely due to temperature affects and the limited resolution of the rubidium oscillator ( $2 \times 10^{-12}$ ).

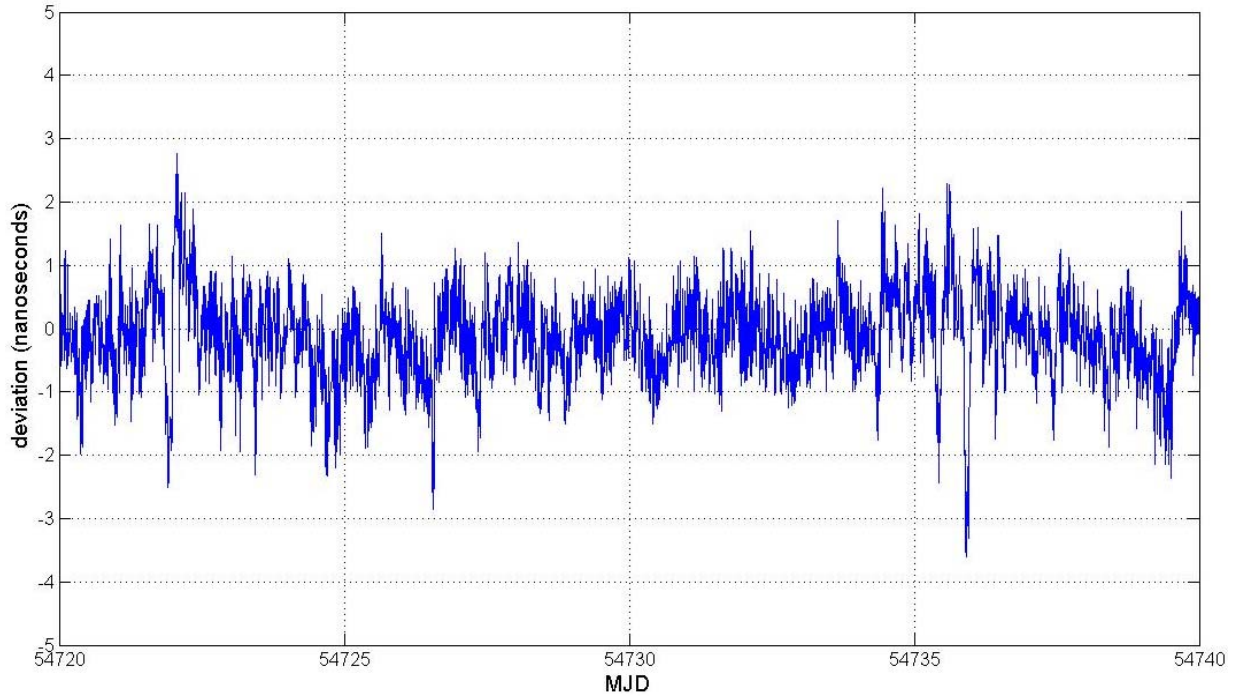

Figure 9. Phase plot of the AOG relative to the ensemble (6-minute average).

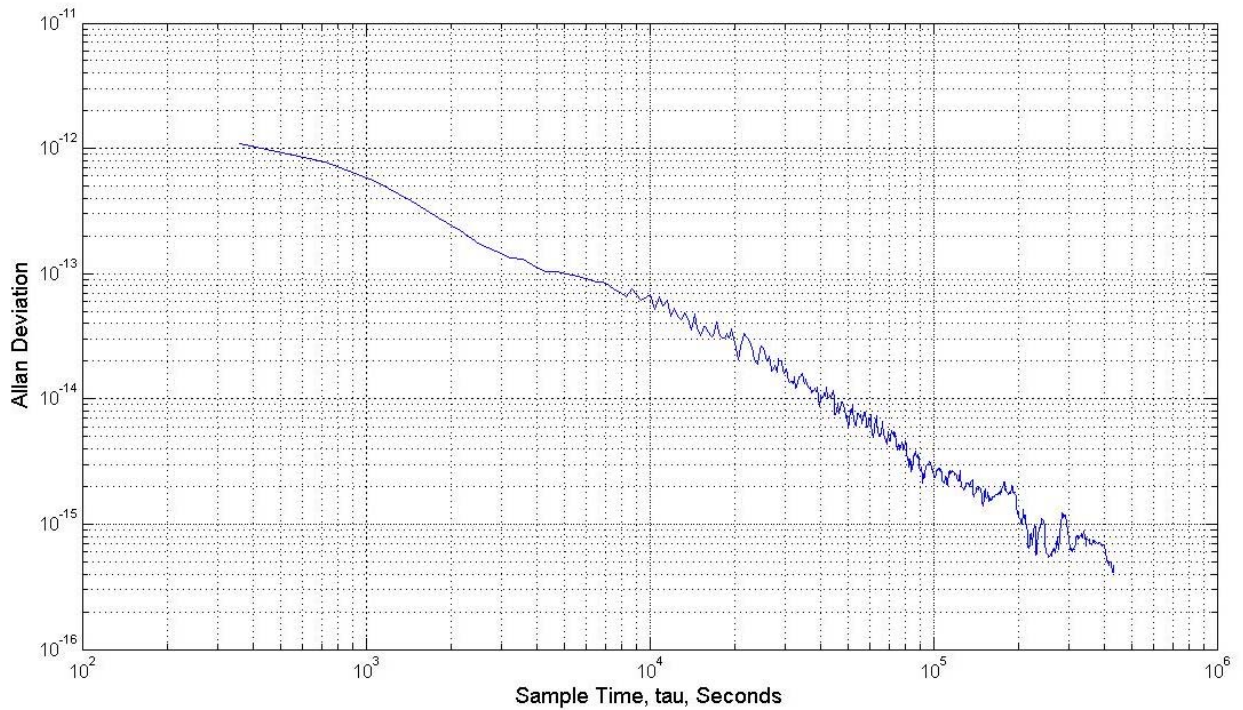

Figure 10. Allan deviation of the AOG relative to the ensemble (based on data presented in Figure 8).

## **V. FUTURE DEVELOPMENTS**

LSU is working to integrate additional external timing references into the clock including all-in-view GNSS and TWSTFT. These advanced timing methods are expected to fortify the clock's estimate of UTC and lower the measurement uncertainty.

Integration of the clock into the existing Loran-C timing equipment suite is being examined, as well as the requirements for the next generation of eLoran timing equipment. A prototype model of the clock complete with three data collection systems and three independent AOGs is under construction. On the surface, this design appears to be doubly redundant. However, on closer inspection, the new design is found to contain the minimal equipment required for fast error detection in a self-contained system, i.e. a system that can quickly detect timing jumps via majority vote in the absence of external timing references. Recall that each Loran station acts as its own monitoring system, whereby each transmitting station operates equipment to automatically detect and alert the user if a signal anomaly occurs. This automatic user notification circuitry operates independently of any intervention from the Loran system operator.

## **VI. CONCLUSION**

A prototype Loran clock has been developed at the Loran Support Unit in Wildwood, NJ. The clock maintains synchronization to UTC well within the mandated  $\pm 100$  ns phase error using a robust routine that allows the operator to switch synchronization between various external timing sources. The clock demonstrates excellent holdover performance upon the loss of all external timing references, maintaining a  $\pm 50$  ns phase error for up to 70 days. Commonly available commercial off-the-shelf hardware is utilized. The controlling software is written in MATLAB<sup>™</sup> and runs on a GNU/Linux operating system. The software routines in their present simplistic form have demonstrated reliable operation, requiring minimal input from the operator. Future plans include development of a GUI for operator control of the clock parameters, fortification of the clock with advanced time transfer methods, and integration of the prototype clock into the Loran-C system.

## **VII. ACKNOWLEDGMENTS**

The author would like to thank Mr. Michael Lombardi and Dr. Judah Levine of NIST for their mentoring and assistance in designing the Loran clock.

## **VIII. DISCLAIMER**

The views expressed herein are those of the author and are not to be construed as official or as reflecting the views of the U.S. Coast Guard or the U.S. Department of Homeland Security.

The identification of commercial products is done for technical completeness only, and implies no endorsement by the U.S. Coast Guard or the U.S. Department of Homeland Security.

## REFERENCES

- [1] “*Statement from DHS Press Secretary Laura Keehner on the Adoption of National Backup to GPS,*” Press Office, U.S. Department of Homeland Security, 7 February 2008.
- [2] M. A. Lombardi and A. P. Dahlen, 2009, “*Locking a Rubidium Oscillator to a Remote Time Scale Using Real-Time Common-View GPS Measurements,*” in Proceedings of the 40<sup>th</sup> Annual Precise Time and Time Interval (PTTI) Systems and Applications Meeting, 1-4 December 2008, Reston, Virginia, USA (U.S. Naval Observatory, Washington, D.C.), pp. 527-542.
- [3] “*Specifications of the Transmitted LORAN-C Signal,*” COMDTINST M16562.4A, United States Coast Guard, 1994.