

# HISTORY AND PERFORMANCE OF FEI SPACE-CLASS OSCILLATORS

**M. Bloch, O. Mancini, and T. McClelland**  
**Frequency Electronics, Inc.**

**55 Charles Lindbergh Boulevard, Mitchel Field, NY 11553, USA**  
**516-794-4500 x3015(voice), 516-794-4500 (fax)**  
***martinb@freqelec.com, oliem@freqelec.com, tomm@freqelec.com***

## Abstract

*An indispensable component of any space vehicle is the onboard master oscillator. The proper operation of the entire payload is dependent on the performance of the master oscillator or the onboard clock. Frequency Electronics, Inc. (FEI) has been a key supplier of high-reliability oscillators for space applications since 1963, and in this paper we will present a short history of oscillators for space applications that include quartz-based oscillators, rubidium-based oscillators, and integrated timing/frequency generating systems. We will also present achieved performance of key parameters such as aging, short-term stability, and low power consumption. Design considerations to mitigate the effects of natural radiation in the space environment will be discussed as well as strategies to minimize frequency drift to assure mission lifetimes of 20 years or more. Furthermore, to predict long-term frequency accuracy we will present data of unpowered oscillators that were manufactured between 1968 and 1985 for long-term space missions that have been recently powered-on and tested.*

*The presented data will provide empirical evidence that may be used to estimate the performance of quartz-based and rubidium-based oscillators in space.*

## I. BACKGROUND

An essential component of any space vehicle is the onboard master oscillator and the proper operation of the entire payload is dependent on the performance of the oscillator. Furthermore, space programs require precision timekeeping and stable frequency generation, and this requirement has been achieved with super-stable quartz oscillators and/or atomic frequency standards. Frequency Electronics, Inc. (FEI) has been providing highly reliable oscillators to the space industry for over 45 years. Over this period, FEI has delivered Oven-Controlled Crystal Oscillators (OCXO), Temperature-Controlled Crystal Oscillators (TCXO), Voltage-Controlled Crystal Oscillators (VCXO), Rubidium Atomic Frequency Sources (RAFS), and integrated systems incorporating Frequency Generators with Fixed/Tunable Synthesizers. A total of over 5000 space assemblies have been delivered in the past 45 years. The initial oscillators were constructed with AT-cut crystals and were launched in 1963 on the NIMBUS meteorological research satellite program. Since that time, FEI has been consistently improving key oscillator parameters, namely:

# Report Documentation Page

*Form Approved  
OMB No. 0704-0188*

Public reporting burden for the collection of information is estimated to average 1 hour per response, including the time for reviewing instructions, searching existing data sources, gathering and maintaining the data needed, and completing and reviewing the collection of information. Send comments regarding this burden estimate or any other aspect of this collection of information, including suggestions for reducing this burden, to Washington Headquarters Services, Directorate for Information Operations and Reports, 1215 Jefferson Davis Highway, Suite 1204, Arlington VA 22202-4302. Respondents should be aware that notwithstanding any other provision of law, no person shall be subject to a penalty for failing to comply with a collection of information if it does not display a currently valid OMB control number.

1. REPORT DATE <b>01 DEC 2008</b>	2. REPORT TYPE <b>N/A</b>	3. DATES COVERED <b>-</b>	
4. TITLE AND SUBTITLE <b>History And Performance Of FEI Space-Class Oscillators</b>		5a. CONTRACT NUMBER	
		5b. GRANT NUMBER	
		5c. PROGRAM ELEMENT NUMBER	
6. AUTHOR(S)		5d. PROJECT NUMBER	
		5e. TASK NUMBER	
		5f. WORK UNIT NUMBER	
7. PERFORMING ORGANIZATION NAME(S) AND ADDRESS(ES) <b>Frequency Electronics, Inc. 55 Charles Lindbergh Boulevard, Mitchel Field, NY 11553, USA</b>		8. PERFORMING ORGANIZATION REPORT NUMBER	
9. SPONSORING/MONITORING AGENCY NAME(S) AND ADDRESS(ES)		10. SPONSOR/MONITOR'S ACRONYM(S)	
		11. SPONSOR/MONITOR'S REPORT NUMBER(S)	
12. DISTRIBUTION/AVAILABILITY STATEMENT <b>Approved for public release, distribution unlimited</b>			
13. SUPPLEMENTARY NOTES <b>See also ADM002186. Annual Precise Time and Time Interval Systems and Applications Meeting (40th) Held in Reston, Virginia on 1-4 December 2008, The original document contains color images.</b>			
14. ABSTRACT			
15. SUBJECT TERMS			
16. SECURITY CLASSIFICATION OF:			17. LIMITATION OF ABSTRACT
a. REPORT <b>unclassified</b>	b. ABSTRACT <b>unclassified</b>	c. THIS PAGE <b>unclassified</b>	<b>UU</b>
			18. NUMBER OF PAGES <b>22</b>
			19a. NAME OF RESPONSIBLE PERSON

- short-term stability
- aging
- temperature coefficient
- frequency tuning range
- radiation immunity
- crystal cuts
- rubidium lamps and cells
- power consumption
- volume.

The results from 45 years of experience indicate that, to achieve optimal performance in space, the quartz-based clocks must be robustly designed and embody the following characteristics:

- 1) Usage of “Premium Q Swept Quartz” or radiation-hardened quartz material.
- 2) SC-cut crystals (SC-cut crystals stabilize faster than AT-cut crystals; the retrace of SC-cut crystals is orders of magnitude better than AT-cut crystals).
- 3) 5<sup>th</sup> overtone resonators (aging is significantly affected by the thickness of the resonator; hence, the thickest quartz blank should be used at the highest practical overtone for best aging performance).
- 4) Crystals exhibiting monotonically positive aging slope terrestrially (radiation in space offsets the positive aging trend of quartz, as further explained below).

However, for certain applications, quartz performance is less desired, for the following reasons:

- 1) In long periods where ground updates are not available
- 2) Where radiation performance autonomy is required.

Rubidium atomic frequency sources are ideal for missions requiring low-update rates and radiation autonomy, and, to achieve optimal performance in space, rubidium clocks must also be robustly designed and embody the following characteristics:

- low power
- small size and weight
- adequate rubidium isotopes in lamp to guarantee performance for 15 to 20 years
- reduced light shift
- microwave power stability.

## II. EXAMPLES OF FEI SPACE-BORNE QUARTZ OSCILLATORS

FEI has been providing space born quartz-based oscillators for both commercial and military applications; a partial listing of some of the space programs are presented below:

### 1963 NIMBUS METEOROLOGICAL RESEARCH SATELLITE PROGRAM

- FEI's 1<sup>st</sup> space-borne OCXO
- Short-term stability:  $1 \times 10^{-10}/1$  sec
- Long-term stability  $< 2 \times 10^{-6}/10$  years.

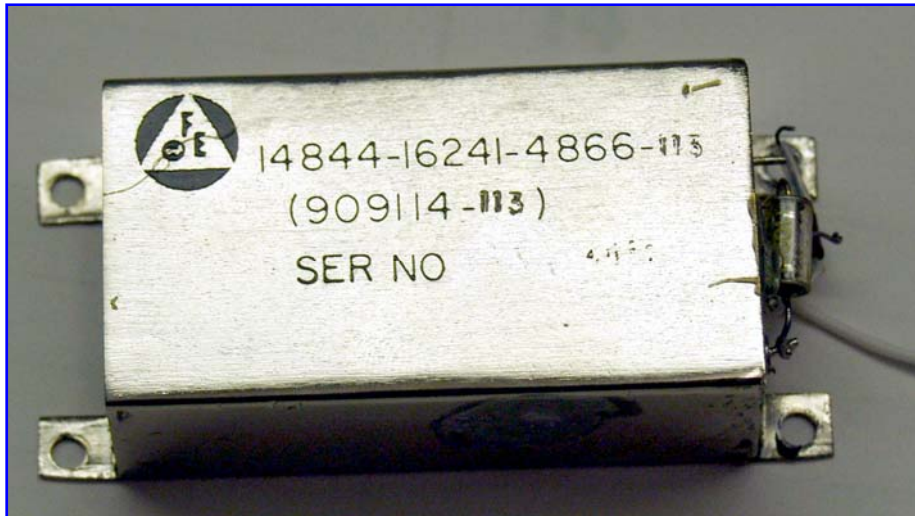

Figure 1. NIMBUS meteorological research satellite program.

#### **1994 TRIPLY REDUNDANT HIGHLY STABLE OCXO**

- Provided for a major constellation
- Triply redundant OCXO
- Triply redundant DC-DC converters
- Short-term stability:  $1 \times 10^{-12}/1$  sec
- Long-term stability  $< 2 \times 10^{-7}/10$  years.



Figure 2. Triply redundant highly stable OCXO.

### **2008 DUAL REDUNDANT EXTREMELY STABLE OCXO**

- Dual redundant OCXO
- Dual redundant DC-DC converters
- Short-term stability:  $1 \times 10^{-13}/1$  sec
- Long-term stability  $< 2 \times 10^{-8}/10$  years.

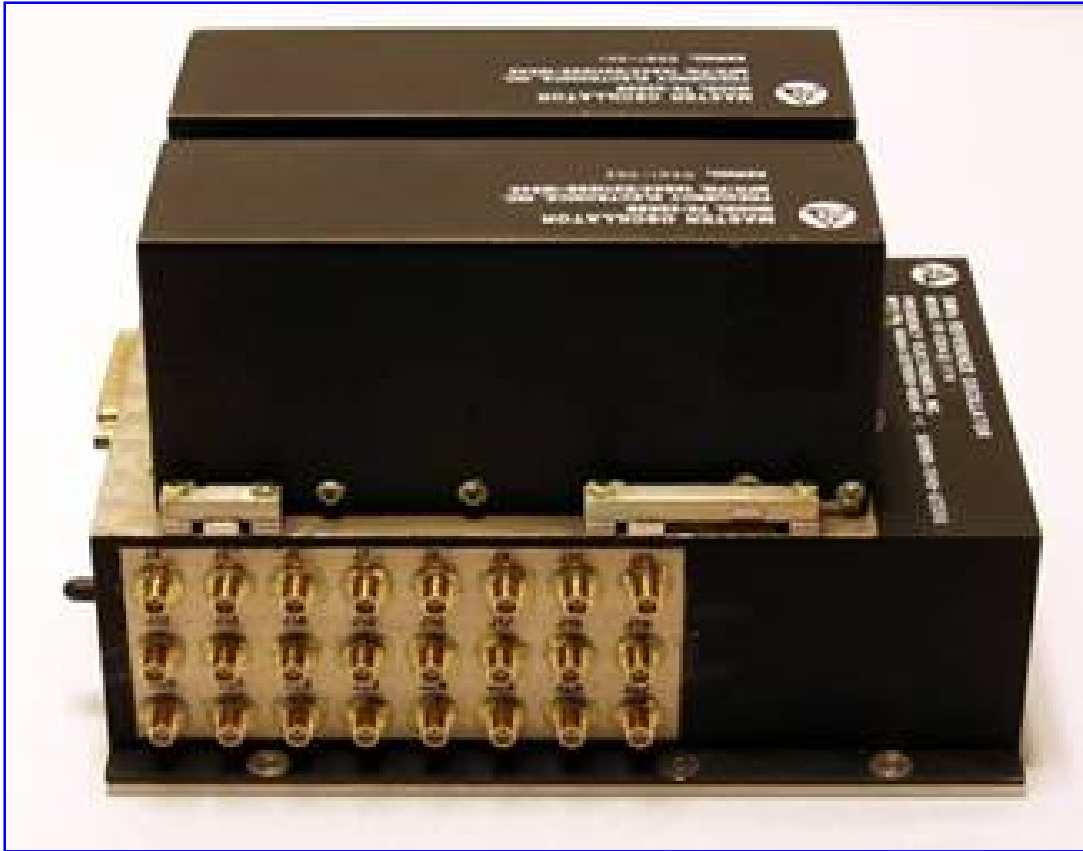

Figure 3. Dual redundant extremely stable OCXO.

### III. EXAMPLES OF FEI SPACE-BORNE RUBIDIUM ATOMIC FREQUENCY STANDARDS

FEI has supplied various Rubidium Atomic Frequency Standards for space programs, some of which are described below.

#### 1996 RUBIDIUM ATOMIC FREQUENCY STANDARD

- Provided for a major constellation
- Internal DC-DC converter
- Internal high-precision VCXO
- $\sigma_y(\tau) = 8 \times 10^{-12} / \sqrt{\tau}$
- Long-term stability  $< 3 \times 10^{-13} / \text{day}$ .

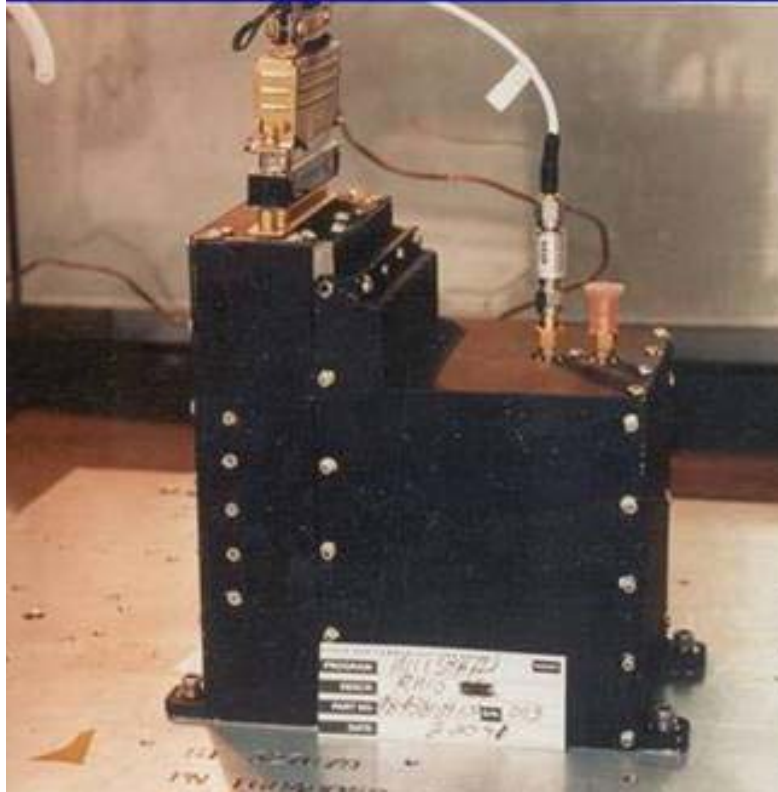

Figure 4. Rubidium Atomic Frequency Standard.

**2001 – 2006 RUBIDIUM ATOMIC FREQUENCY STANDARD AND FREQUENCY SYNTHESIZER WITH MULTIPLE FREQUENCIES**

- Provided for a major constellation
- Triply redundant rubidium atomic standards
- Triply redundant precision quartz oscillators
- Double redundant multiple frequency RF synthesizers
- Triply redundant DC/DC converters
- Triply redundant Mil-Std-1553B serial interface
- $\sigma_y(\tau) = 5 \times 10^{-12} / \sqrt{\tau}$
- Long-term stability  $< 5 \times 10^{-14}$ /day.

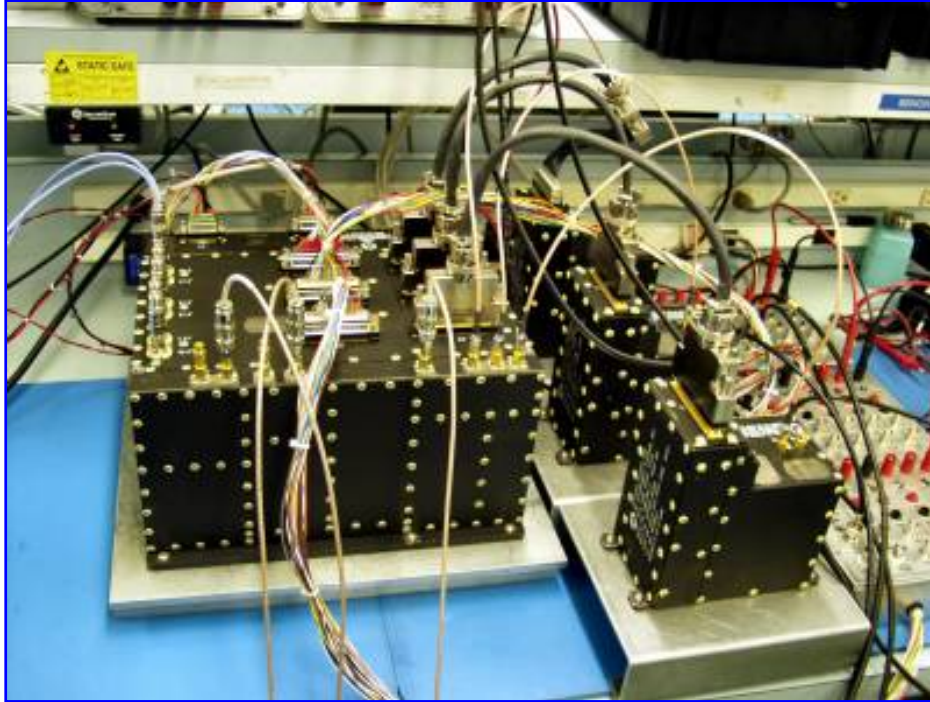

Figure 5. Rubidium Atomic Frequency Standard and frequency synthesizer with multiple frequencies.

### **2009 FEI'S HIGHEST PRECISION RUBIDIUM ATOMIC FREQUENCY STANDARD**

- Internal DC-DC converter
- Internal high-precision VCXO
- $\sigma_y(\tau) = 2 \times 10^{-12} / \sqrt{\tau}$
- Long-term stability  $< 2 \times 10^{-14} / \text{day}$ .



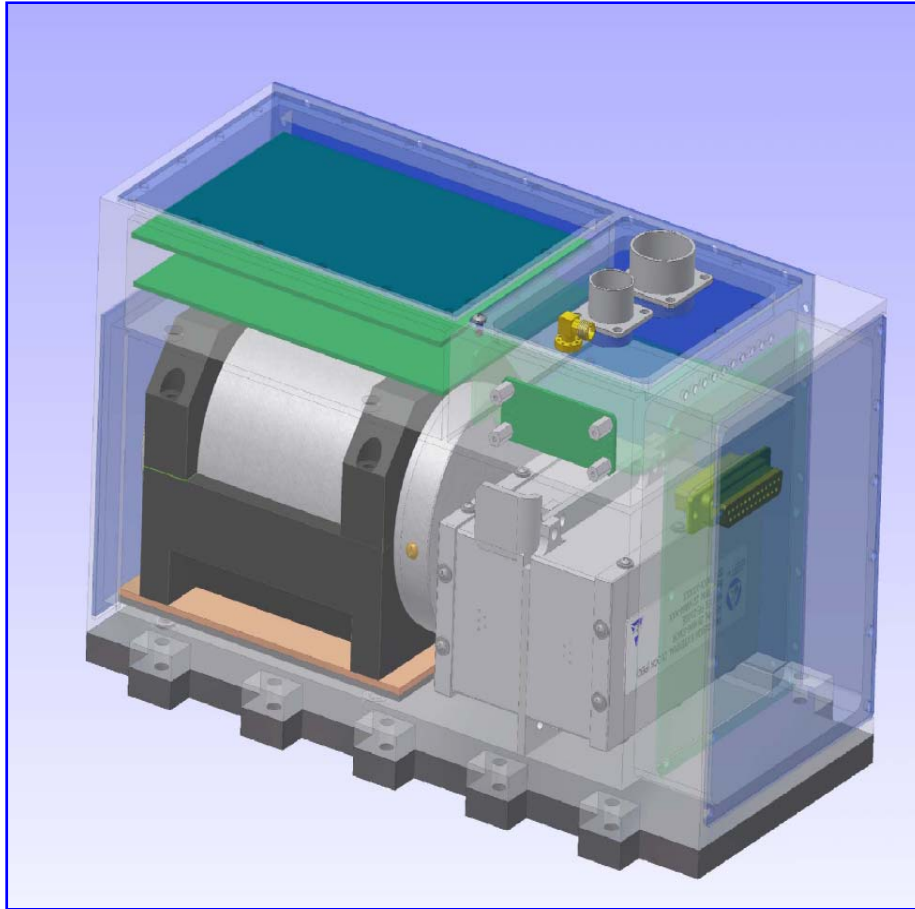

Figure 6. FEI's highest precision Rubidium Atomic Frequency Standard.

#### **IV. EXAMPLES OF FEI SPACE-BORNE MULTIPLE FREQUENCY LOCAL OSCILLATORS, INTEGRATED RECEIVER SYSTEMS, TUNABLE FREQUENCY SOURCES**

FEI provides space-borne oscillators in various configurations to meet the requirement of the mission. Many have frequency stepping capabilities with non-volatile frequency storage memory. These oscillators are often incorporated with receivers and with microwave frequency generators, resulting in highly efficient integrated assemblies; examples are shown below.

##### **1985 DUAL REDUNDANT FIXED FREQUENCY GENERATOR**

- Dual redundant DC/DC converters
- Output frequencies  
3.24 GHz, 4.13 GHz  
5.4 GHz, 6.48 GHz.

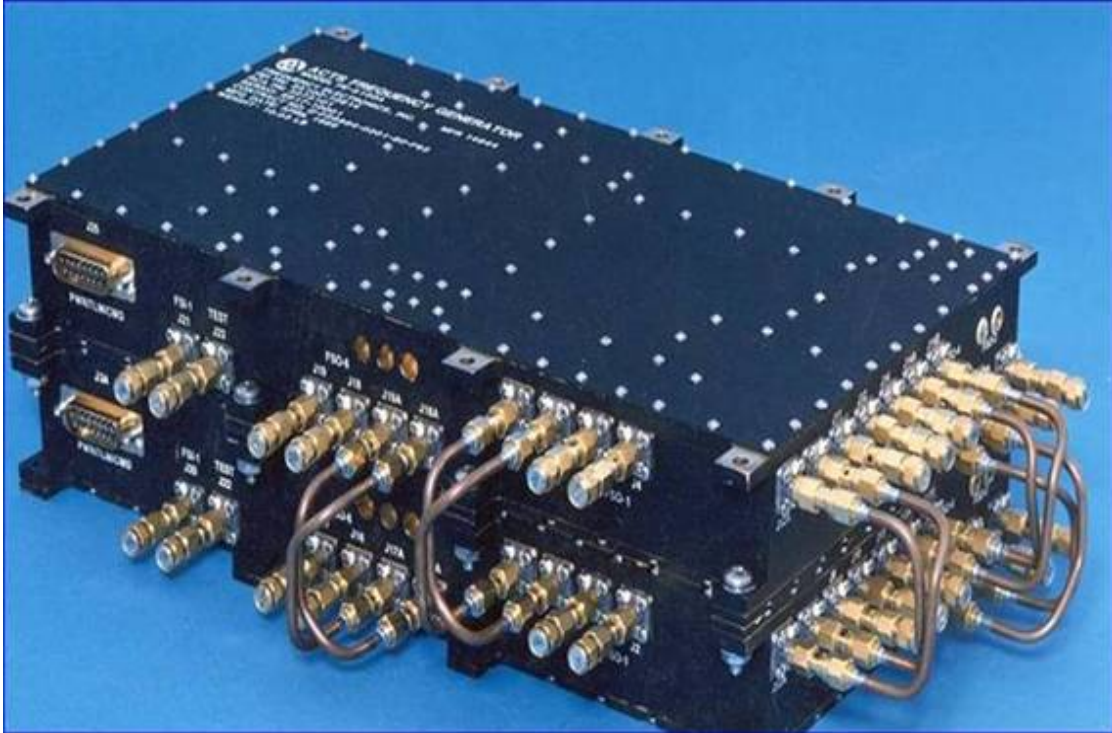

Figure 7. Dual redundant fixed frequency generator.

## 2007 MULTIPLE FREQUENCY LOCAL OSCILLATORS

- Fully redundant with internal cross-strapping
- Dual redundant DC-DC converters
- Output frequencies
  - 2 @ 7084 MHz, 2 @ 6950 MHz
  - 2 @ 2457 MHz, 2 @ 1000 MHz
  - 8 @ 750 MHz, 6 @ 150 MHz
  - 2 @ 20 MHz, 2 @ 3.88 MHz
- All outputs coherent with internal 50 MHz OCXO except for 3.88 MHz.

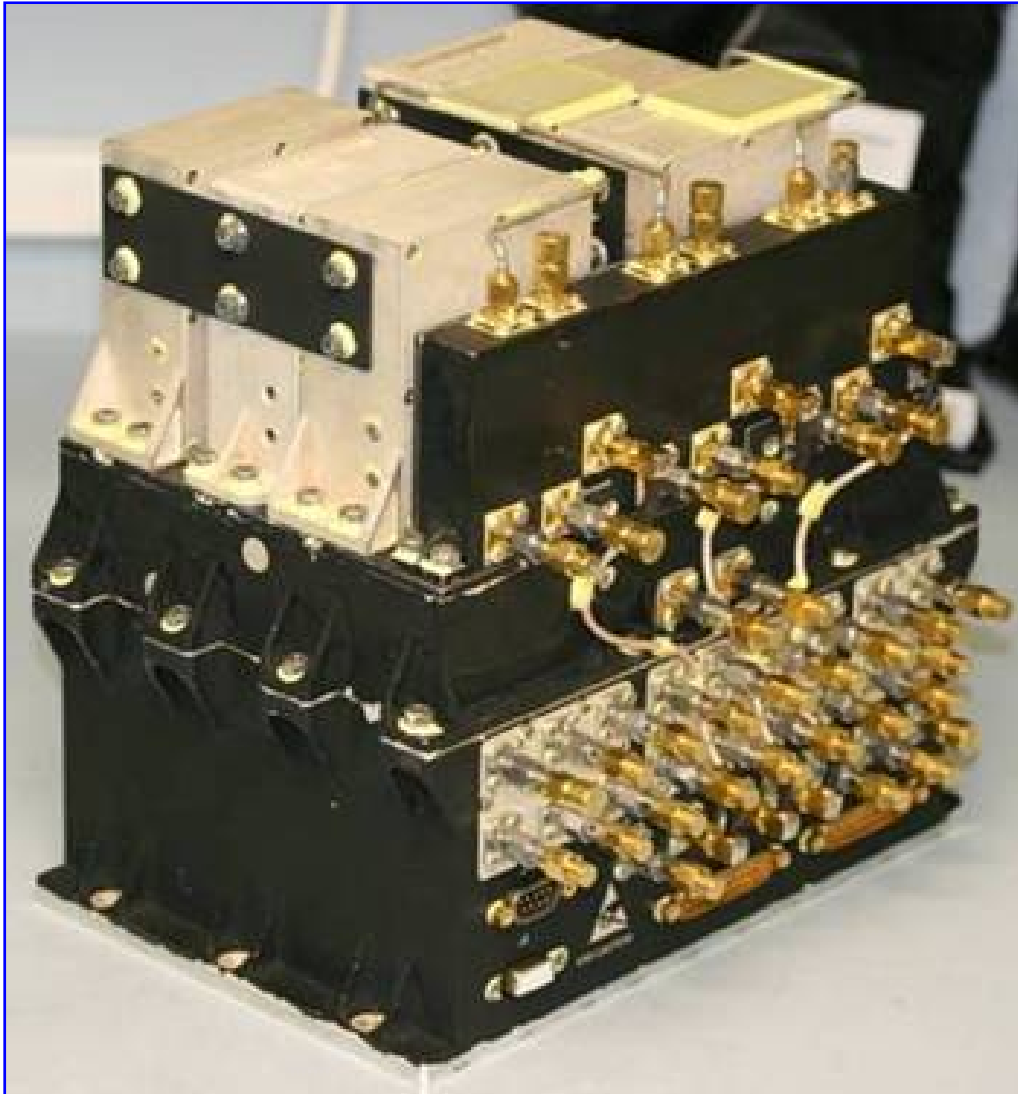

Figure 8. Multiple frequency local oscillators.

### 2003 INTEGRATED OSCILLATORS AND RECEIVERS

- Triply redundant precision oscillators
- C-Band down-converted to L-band
- Input frequency 6.6 GHz
  - Noise figure 1.2 dB
  - Group delay 0.40 ns
- Input frequency 8.8 GHz
  - Output frequency 2.2 GHz
  - Bandwidth 150 MHz
- DC power 11 watts
- Weight 3.2 kg.



Figure 9. 2003 integrated oscillators and receivers.

## 2007 INTEGRATED OSCILLATORS AND RECEIVERS

- Triply redundant OCXO
- Triply redundant 30 GHz pilot receivers
- Triply redundant DC-DC converters
- Short-term stability:  $1 \times 10^{-12}/1$  sec
- Clock phase-locked to ground base or pilot signal
- Noise reduction and Doppler tracking.

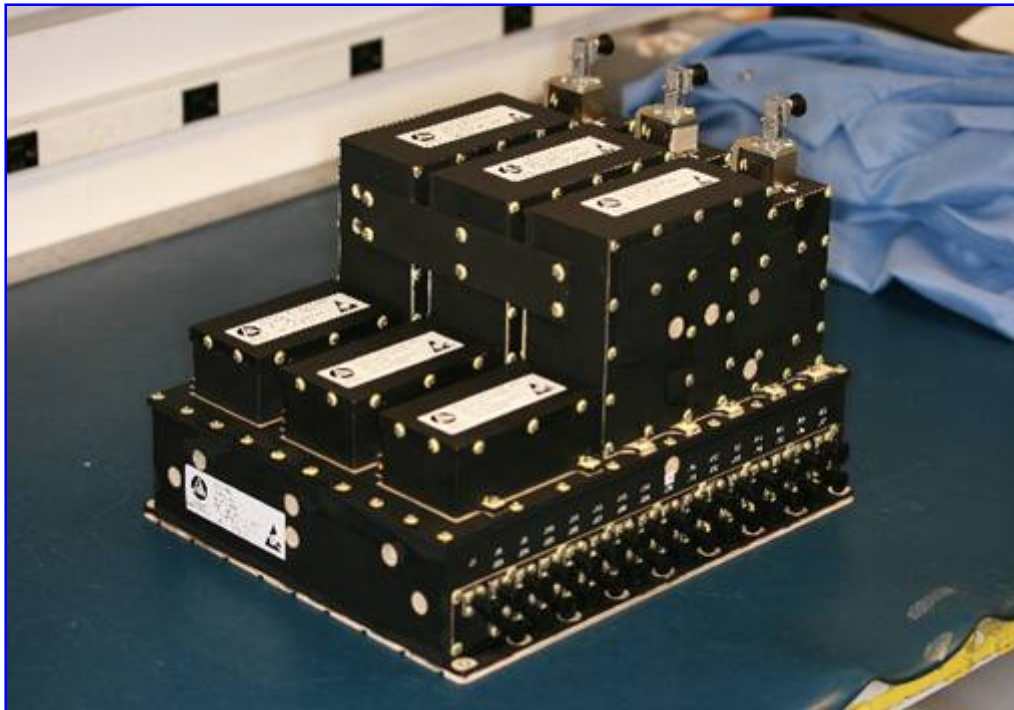

Figure 10. 2007 integrated oscillators and receivers.

### **2007 DUAL REDUNDANT TUNABLE FREQUENCY GENERATORS**

- Dual redundant DC-DC converters
- 100 KHz steps for 1487 MHz to 1491 MHz
- 10 KHz steps for 170 MHz to 260 MHz
- 5 KHz steps for 4.25 GHz to 5.25 GHz
  - Synthesizer tunable in steps of 1 KHz to 1 MHz
- Excellent phase noise.



Figure 11. Dual redundant tunable frequency generators.

## V. KEY OSCILLATOR PARAMETERS

Table 1 below demonstrates quantitatively the key oscillator parameters that have been achieved by FEI.

Table 1. Summary of key parameters.

Type	OCXO	TCXO	VCXO	Rubidium
<b>Frequency Range</b>	4 MHz to 20 MHz	4 MHz to 120 MHz	4 MHz to 120 MHz	5 MHz to 15 MHz
<b>Short-Term Stability</b>	$1 \times 10^{-12}/1$ sec to $1 \times 10^{-13}/1$ sec	$1 \times 10^{-9}/1$ sec to $2 \times 10^{-11}/1$ sec	$2 \times 10^{-9}/1$ sec to $2 \times 10^{-10}/1$ sec	$\sigma_y(\tau) = 8 \times 10^{-12}/\sqrt{\tau}$ to $\sigma_y(\tau) = 2 \times 10^{-12}/\sqrt{\tau}$
<b>Aging</b>	$3 \times 10^{-7}/15$ years to $3 \times 10^{-8}/15$ years	$5 \times 10^{-6}/15$ years to $2 \times 10^{-6}/15$ years	$10 \times 10^{-6}/15$ years	$2 \times 10^{-14}/\text{day}$
<b>Temperature Coefficient</b>	$1 \times 10^{-11}/10^\circ\text{C}$	$2 \times 10^{-7}/10^\circ\text{C}$ to $2 \times 10^{-8}/10^\circ\text{C}$	$2 \times 10^{-6}/10^\circ\text{C}$ to $1 \times 10^{-6}/10^\circ\text{C}$	$2 \times 10^{-12}/10^\circ\text{C}$ to $1 \times 10^{-13}/10^\circ\text{C}$
<b>Frequency Tuning Range</b>	$\pm 5 \times 10^{-7}$	$\pm 2 \times 10^{-6}$ to $\pm 7 \times 10^{-6}$	$\pm 10 \times 10^{-6}$ to $\pm 500 \times 10^{-6}$	$5 \times 10^{-8}$ (tunable version)
<b>Crystal Cut</b>	AT, FC, SC	AT	AT	SC for internal quartz oscillator
<b>Radiation Immunity</b>	100 K rads	100 K rads	100 K rads	100 K rads
<b>Power Consumption</b>	2 W	60 mW to 100 mW	60 mW to 100 mW	8 W
<b>Volume</b>	20 cubic inches	1.5 cubic inches	1.5 cubic inches	20 cubic inches

## VI. SPACE RADIATION CONSIDERATIONS

One of the major concerns for quartz clocks in space is the effect of radiation. Quartz is sensitive to space radiation, and the performance of extensive tests on Earth have revealed some very interesting results that cannot only be used to predict performance in space, but can also be utilized to compensate the aging of the device. Figs. 12 and 13 demonstrate the radiation effects on aging of two quartz oscillators in a controlled test environment [1].

- Radiation is applied to the OCXO Proto/Qual Unit on day 0, and initially a short positive-transient aging response is observed, but over time (days 1 - 10) radiation is observed to be causing a negative trend in the aging process. The same phenomenon was also observed on the OCXO Engineering Model, as shown in Figure 13.
- The average rate of space radiation has been calculated to be  $\approx 6$  rads/day, and the effect of 1 rad on a quartz crystal results in  $\Delta f/f \approx -1 \times 10^{-12}$ , with a total daily result of  $\Delta f/f \approx -6 \times 10^{-12}$ .

The plots in Figs. 12 and 13 and the above equations demonstrate that radiation affects the aging process in a negative direction, and, therefore, it can be stated that radiation is “beneficial” and can be advantageously utilized to actually compensate the aging trend of a monotonically positive aging clock. In other words, the radiation effect offsets the positive aging of the crystal and acts as a compensatory mechanism.

A quality quartz clock that is robustly designed and incorporates the characteristics described above in Section I, Background, typically exhibits aging rates in the range of  $10^{-11}/\text{day}$  after being tested and aged on Earth for a period of 90 to 180 days. This type of a clock can be expected to display on-orbit performance in the range of  $10^{-12}/\text{day}$ .

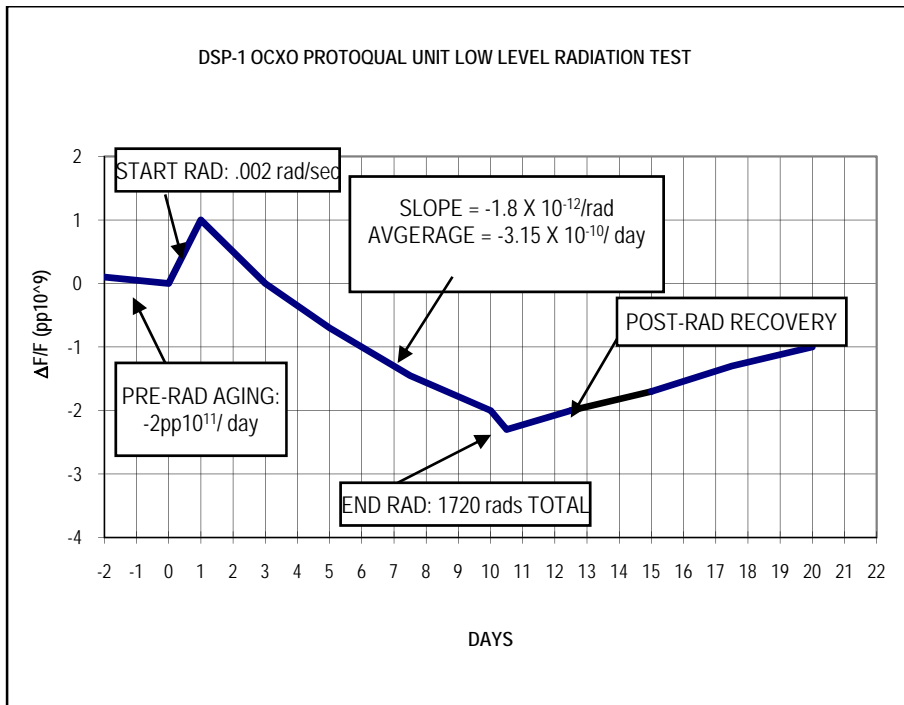

Figure 12. Radiation effect on DSP-1 OCXO Proto/Qual Unit.

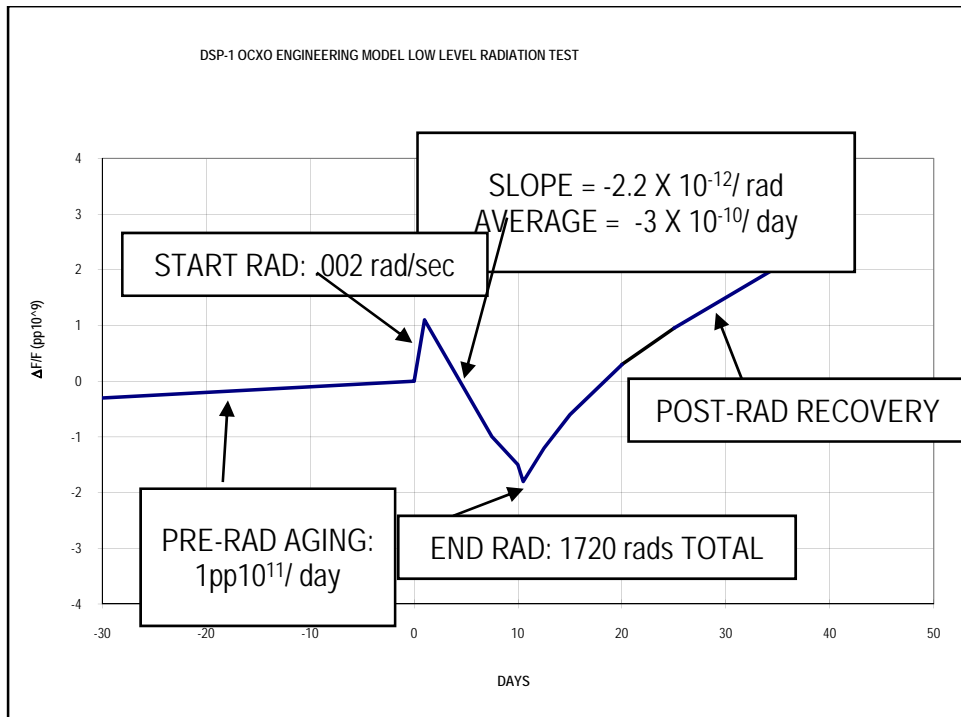

Figure 13. Radiation effect on DSP-1 OCXO Engineering Model.

These expectations are supported with test results conducted on Earth, and with on-orbit-derived data from numerous space programs including Argos, Voyager, Fleet Sat Com, MILSTAR, IntelSat, etc.



**A. Argos clocks:**

The following data was derived from six clocks:

Aging on Earth  $\approx +2 \times 10^{-11}$ /day for typical unit  
 $\approx +9 \times 10^{-11}$ /day for worst clock  
Aging on-orbit  $\approx 6 \times 10^{-12}$ /day after 5 years for typical unit  
 $\approx 9 \times 10^{-12}$ /day after 5 years for worst unit.

**B. Voyager clocks:**

The following data was derived from clocks on two satellites, and an average aging rate was calculated as follows:

Aging on Earth  $\approx +3 \times 10^{-11}$ /day  
Aging on-orbit  $\approx 3.4 \times 10^{-12}$ /day after 10 years  
Note: This clock is not in Earth's orbit.

**C. Fleet Sat Com clocks:**

Data derived from a fleet of 13 satellites:

Aging on Earth  $\approx +2 \times 10^{-11}$ /day to  $+4 \times 10^{-11}$ /day  
Aging on-orbit  $\approx 2 \times 10^{-12}$ /day to  $4.4 \times 10^{-12}$ /day after 15 years  
The on-orbit data was reported in the range of  
 $+1.1$  to  $+2.4 \times 10^{-8}$ /15 years

Assuming a worst case linear function, the aging rate per day is calculated as follows:

$$(1.1 \times 10^{-8}) / (365 \text{ days} \times 15 \text{ years}) \approx 2 \times 10^{-12} / \text{day}$$
$$(2.4 \times 10^{-8}) / (365 \text{ days} \times 15 \text{ years}) \approx 4.4 \times 10^{-12} / \text{day}.$$

**D. MILSTAR clocks (See Figure 14.):**

Aging on Earth  $\approx 3 \times 10^{-11}$ /day  
Aging on-orbit  $\approx 1.4 \times 10^{-12}$ /day after 2 years  
 $\approx 2 \times 10^{-13}$ /day (8-year average).

Figure 14 shows frequency aging for an 8-year period for oscillators on the MILSTAR program. The pronounced downward excursion in about month 72 in Fig. 14 was due to solar flares, as reported in Presser and Camparo [4].

In contrast to quartz clocks, the effect of radiation on rubidium-based clocks is not a major concern. Aging data shown in Fig.15 suggest that radiation effects on rubidium clocks is at least down to the  $\sim 10^{-14}$  level. This is further supported from data presented by Camparo, *et al.* on the effects of solar flares on clocks in space [2,3].

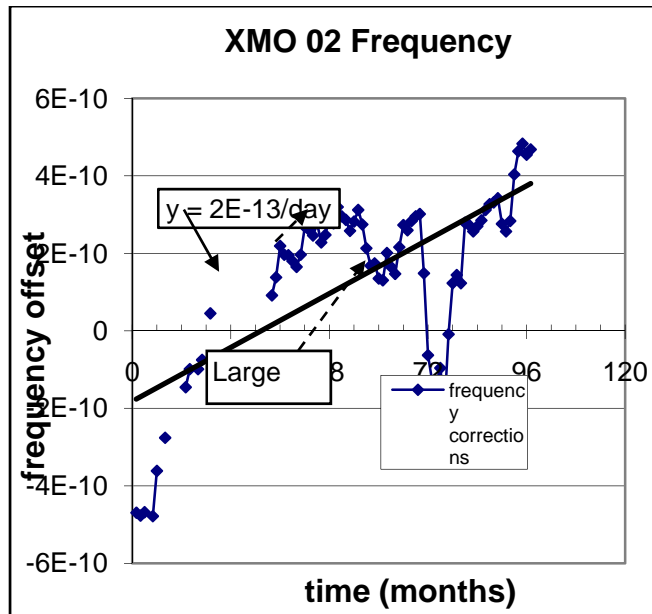

Figure 14. Long-term aging of a quartz oscillator on a MILSTAR satellite.

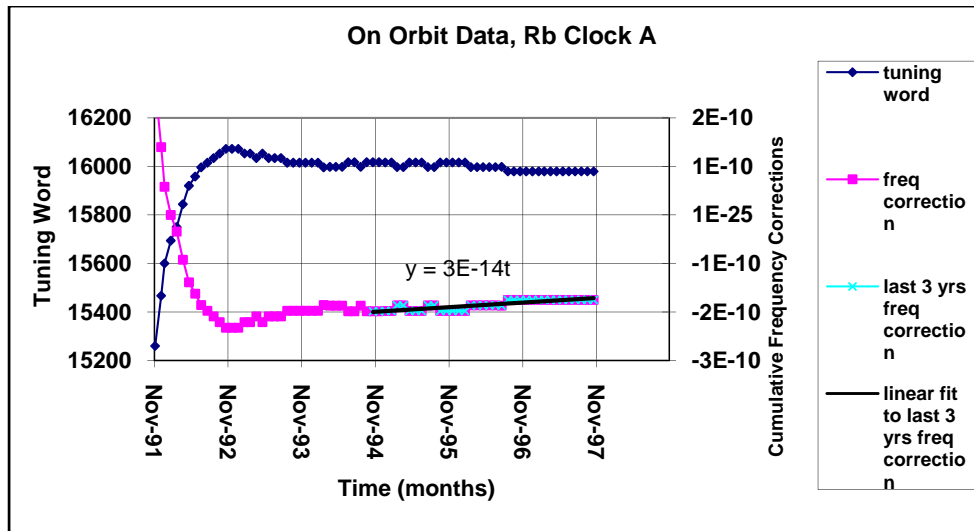

Figure 15. Clock A on-orbit data.

## VII. AGING RATE OF DORMANT OSCILLATORS

For maximum reliability, the onboard clock is often provided as a dual or triply redundant ensemble, with one active oscillator. The backup oscillators are usually powered off. The mission life of most space vehicles is typically 10 to 15 years, and the primary clock may at times experience a failure or an anomaly resulting in the activation of one of the backup oscillators. The backup oscillator may have been off for a significant period of time, but it would have to perform as well as the replaced primary clock. A significant parameter of importance for oscillator performance is the aging rate. Various papers have been presented on the aging performance of active oscillators in space, but very little data exist regarding the long-term aging performance of oscillators in the non-

operating mode. The aging rate data is extremely important for predicting the expected performance of these backup oscillators after 10 or 15 years in space. The below data will demonstrate the performance of unpowered oscillators that were manufactured for long-term space missions. All oscillators were built by FEI and before and after measurements were taken at FEI. Examples #1, #2, and #3 show the aging rate of five unpowered TCXOs (Temperature Controlled Crystal Oscillators) for a period of 29 years to 36 years. Example #4 illustrates the aging rate of an unpowered OCVCXO (Oven-Controlled Voltage-Controlled Crystal Oscillator). For comparison to example 4, Fig. 14 above shows data for a OCVCXO that has been operating for 14 years on a MILSTAR satellite.

#### A. Example #1

- Space program: GOES (Hughes Aircraft)
- Oscillator type: TCXO
- Oscillator S/N: 4450
- Frequency:  $F_0 = 46,125,000.00$  Hz (as measured in 1974)
- Aging requirement:  $\pm 1 \times 10^{-6}$ /year
- Quartz crystal type: AT-cut, 3<sup>rd</sup> overtone
- Date built: 1974
- Measurements were taken in 2008 after 34 years of being in the off-state. Note that this oscillator was operational in a GOES unit in the late 1970s and was subsequently removed and stored. Operation at the unit level is estimated to be less than 200 hours.
- Frequency:  $F_0 = 46,125,091.80$  Hz
- Change in frequency from 1974 to 2008:  $\Delta F = +91.8$  Hz or  $\approx +2 \times 10^{-6}$ /34 year
- Average daily aging rate:  $(+2 \times 10^{-6})/(34 \text{ years} \times 365 \text{ days/year}) \approx +1.6 \times 10^{-10}$ /day.

#### B. Example #2

- Space program: VIKING (RCA)
- Oscillator type: TCXO
- Oscillator S/N: 113 and 119
- Frequency:
  - S/N 113  $F_0 = 35,834,903.00$  Hz (as measured in 1972)
  - S/N 119  $F_0 = 35,834,903.00$  Hz (as measured in 1972)
- Aging requirement:  $\pm 20 \times 10^{-6}$ /7 years
- Quartz crystal type: AT-cut, 3<sup>rd</sup> overtone
- Date built: 1972
- Measurements were taken in 2008 after 36 years of being in the off-state
- Frequency:
  - S/N 113  $F_0 = 35,835,393.00$  Hz
  - S/N 119  $F_0 = 35,834,729.30$  Hz
- Change in frequency from 1972 to 2008:
  - S/N 113  $\Delta F = +490$  Hz or  $\approx +13.6 \times 10^{-6}$ /36 years
  - S/N 119  $\Delta F = -173.7$  Hz or  $\approx -4.8 \times 10^{-6}$ /36 years
- Average daily aging rate:
  - S/N 113  $(+13.6 \times 10^{-6})/(36 \text{ years} \times 365 \text{ days/year}) \approx +1 \times 10^{-9}$ /day
  - S/N 119  $(-4.8 \times 10^{-6})/(36 \text{ years} \times 365 \text{ days/year}) \approx -0.36 \times 10^{-9}$ /day.

#### C. Example #3

Note: The oscillator tested in this example contains an FC-cut, 3<sup>rd</sup>-overtone quartz crystal resonator. The Frequency Electronics cut (FC) was invented in the early 70s [5]. It is a double rotated cut with the

first angle of rotation in the 12° to 15° range (unlike the AT, which is not double-rotated). One could say FC is a cut between AT and SC, since the angle of the second rotation is 0° for AT and 22° for SC. FC-cut temperature curves have an inflection point around 45°C (25°C for AT cut and 93°C for SC cut); therefore, the curve is flat in 20 to 70°C temperature range ( $\pm 2$  ppm or less can be achieved without ovenizing the crystal). FEI has been supplying FC-cut crystals for space applications for over 30 years.

- Space program: COMSAT
- Oscillator type: TCXO
- Oscillator S/N: 29 and 32
- Frequency:
  - S/N 29  $F_0 = 18,754,250.00$  Hz (as measured in 1979)
  - S/N 32  $F_0 = 18,754,250.00$  Hz (as measured in 1979)
- Aging requirement:  $\pm 1 \times 10^{-6}$ / year
- Quartz crystal type: FC-cut, 3<sup>rd</sup> overtone
- Date built: 1979
- Measurements were taken in 2008 after 29 years of being in the off-state
- Frequency:
  - S/N 29  $F_0 = 18,754,257.42$  Hz
  - S/N 32  $F_0 = 18,754,245.68$  Hz
- Change in frequency from 1979 to 2008:
  - S/N 29  $\Delta F = +7.42$  Hz or  $\approx +0.5 \times 10^{-6}$ / 29 years
  - S/N 32  $\Delta F = -4.32$  Hz or  $\approx -0.234 \times 10^{-6}$ / 29 years
- Average daily aging rate:
  - S/N 29  $(+0.5 \times 10^{-6})/(29 \text{ years} \times 365 \text{ days/year}) \approx +4.7 \times 10^{-11}$ /day
  - S/N 32  $(-0.234 \times 10^{-6})/(29 \text{ years} \times 365 \text{ days/year}) \approx -2.2 \times 10^{-11}$ /day.

#### D. Example #4

- Space program: MILSTAR (Lockheed-Martin)
- Oscillator type: OCVCXO (Oven-Controlled Voltage-Controlled Crystal Oscillator)
- Oscillator S/N: 003 and 005
- Frequency:
  - S/N 003  $F_0 = 5,000,000.00$  Hz (as measured in 11/05/1987)
  - S/N 005  $F_0 = 5,000,000.00$  Hz (as measured in 11/05/1987)
- Aging requirement:  $\pm 1 \times 10^{-7}$ / 10 years
- Quartz crystal type: 5 MHz, SC-cut, 5<sup>th</sup> overtone
- Date built: 1987
- Measurements were taken in 2008 after 20.25 years of being in the off-state. Note that these oscillators were operational in a MILSTAR master oscillator group in the late 1980s and early 1990s and were subsequently removed and stored.
- Frequency:
  - S/N 003  $F_0 = 4,999,999.65$  Hz
  - S/N 005  $F_0 = 5,999,999.95$  Hz
- Change in frequency from 1987 to 2008:
  - S/N 003  $\Delta F = -0.35$  Hz or  $\approx -7 \times 10^{-8}$ / 20.25 years
  - S/N 005  $\Delta F = -0.05$  Hz or  $\approx -1 \times 10^{-8}$ / 20.25 years
- Average daily aging rate:
  - S/N 003  $(-7 \times 10^{-8})/(20.25 \text{ years} \times 365 \text{ days/year}) \approx -9 \times 10^{-12}$ /day
  - S/N 005  $(-1 \times 10^{-8})/(20.25 \text{ years} \times 365 \text{ days/year}) \approx -1.3 \times 10^{-12}$ /day.

The data from these measurements are summarized in Table 2.

Table 2. Summary of the aging rate of several oscillators that have been off for decades.

Description	Units	#1	#2A	#2B	#3A	#3B	#4A	#4B
Oscillator Type		TCXO	TCXO	TCXO	TCXO	TCXO	VCDOXO	VCDOXO
Serial Number		4450	113	119	29	32	003	005
Cut	Type/ Overtone	AT/3	AT/3	AT/3	FC/3	FC/3	SC/5	SC/5
Operating Frequency	MHz	46.1	35.8	35.8	18.7	18.7	5.0	5.0
Built	Year	1974	1972	1972	1979	1979	1987	1987
Aging	$\times 10^{-11}$ /day	+16	+100	-36	+4.7	-2.2	-0.9	-0.13

The empirical data demonstrate that some non-operating oscillators will age positively and others will age negatively—even those built for the same program. Operating and non-operating oscillators may also age in opposite directions. For this reason, it is important that this variation be contained in the worst-case aging analysis for all oscillators. However, certain studies conducted by FEI on quartz crystals suggest that the majority of oscillators in the off-state will age negative rather than positive because of the following:

- Mass transfer promotes positive aging
- Stress anneal promotes negative aging
- Getter property of quartz in off-state promotes negative aging.

It can be inferred that, for the majority of cases, the stress anneal and the getter property seem to overcompensate for the positive effects of mass transfer.

The aging rate data presented is extremely important for predicting the expected performance of these backup oscillators after 10 or 15 years in space. Total frequency variation due to aging and environmental effects must be performed on each oscillator (Table 3) to verify that there is adequate tuning range in the oscillator for the ground receiver to acquire and lock to the satellite's signal at the end-of-life.

Table 3. Typical frequency change calculation for a 10 MHz crystal oscillator with an SC-cut 5<sup>th</sup>-overtone crystal (3 years on the ground and 15 years in-orbit).

B	Ground integration and test	9.00E-10	-9.00E-10	3 months at 1E-11/day
C	Storage (3 years off)	2.19E-09	-2.19E-09	3 years at 2E-12/day
D	Aging (operational, on-orbit)	5.48E-08	-5.48E-08	15 years at 1E-11/day
A to D	EOL aging (ppm)	6.29E-02	-5.29E-02	ppm
	Environmental Factors			
E	Launch vibration	2.00E-09	-2.00E-09	
F	Temperature effect	2.50E-09	-2.50E-09	Expected operating range
G	Power on/off repeatability/retrace	5.00E-09	-5.00E-09	
H	Air-to-vacuum frequency error	2.00E-09	-2.00E-09	
I	Radiation	-7.20E-08	-7.20E-08	Always negative
J	Earth gravity	2.00E-09	-2.00E-09	
D to I	Environmental drift range (ppm)	-5.85E-02	-8.55E-02	ppm
A to I	Aging & drift (ppm)	<b>4.39E-03</b>	<b>-1.38E-01</b>	<b>ppm</b>
A to I	Aging & drift (hertz)	<b>0.0439</b>	<b>-1.38</b>	<b>hertz</b>

Notes: (a) Frequency change from all causes is specified as  $\pm 3.5$  ppm  
 (b) The assumption is made that the aging is linear. This is a fair assumption after the oscillator has been on and temperature stable for a long time (months).

## VIII. CONCLUSION

FEI has been providing space-borne oscillators and timing/frequency systems since 1963. FEI has conducted extensive laboratory tests and, combined with on-orbit-derived data from numerous space programs, the performance of critical parameters such as aging can be fairly predicted. For optimum performance, positive aging quartz-crystal resonators are selected to take advantage of the compensatory mechanism contributed by radiation. In contrast to quartz clocks, the effect of radiation on rubidium-based clocks is not a major concern.

FEI's multi-decade study found that unpowered quartz oscillators could age either positively or negatively, even those manufactured in the same production lot.

## IX. REFERENCES

- [1] J. Ho, "Crystal Radiation Test Final Report for DSP-1 OCXO," Frequency Electronics, Inc. Report A36026-9573.
- [2] J. C. Camparo and S. C. Moss, 2008, "Satellite Timekeeping in the Presence of Solar Flares: Atomic Clocks and Crystal Oscillators," submitted to **Proceedings of the IEEE**.
- [3] J. G. Coffey and J. C. Camparo, 2000, "Long-Term Stability of a Rubidium Atomic Clock in Geosynchronous Orbit," in Proceedings of the 31<sup>st</sup> Annual Precise Time and Time Interval (PTTI) Systems and Applications

*40<sup>th</sup> Annual Precise Time and Time Interval (PTTI) Meeting*

Meeting, 7-9 December 1999, Dana Point, California, USA (U.S. Naval Observatory, Washington, D.C.), pp. 65-73.

- [4] A. Presser and J. Camparo, 2002, “*Examination of a crystal oscillator’s frequency fluctuations during the enhanced space-radiation environment of a solar flare,*” **IEEE Transactions on Nuclear Science**, **49**, 2605-2609.
- [5] G. Lagasse, J. Ho, and M. Bloch, 1972, “*Research and Development of a New Type of Crystal Cut– The FC Cut,*” in Proceedings of the 26<sup>th</sup> Annual Frequency Control Symposium (FCS), 6-8 June 1972, Atlantic City, New Jersey, USA (IEEE Publication), pp. 148-151.