

# Reset Behavior of High Duty Cycle Pulse Transformers

J. P. O'Loughlin

Air Force Research Laboratory, Directed Energy Directorate,  
3550 Aberdeen Av SE, Kirtland AFB,  
NM, 87117, USA

**Abstract**—Magnetic core pulse transformers operating in a repetitive mode must maintain the core flux density within the saturation bounds of the magnetic material to provide satisfactory performance. The instantaneous flux is established by the time integration of the induced winding voltage. Alternatively, the flux is also determined by the net instantaneous magneto-motive force acting on the core in relation to the core dimensions and material hysteresis characteristics. Core material is typically non-linear and is awkward to model, so the preferred method of flux determination is via the induced voltage integration method. During the output pulse duration, this induced voltage is forced on the core via the winding by the pulsed power source and establishes the instantaneous flux and flux time derivative during the pulse. In the steady state, the integration of the induced voltage that occurs between load pulses, commonly called the back-swing period, must equal the value established by the output or load portion of the pulse to avoid saturation. This back-swing period can be driven by an external forced re-set source or by the stored energy in the transformer acting through the equivalent circuit impedance. In this paper only the stored energy re-set process is analyzed.

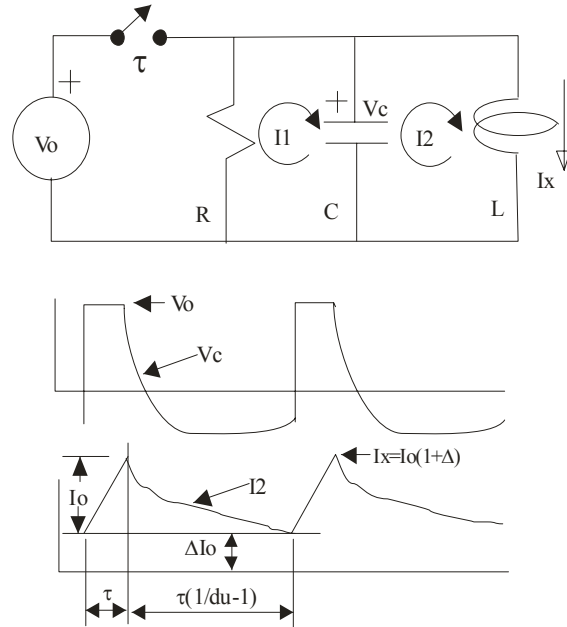

Fig.1: Circuit Model for Reset Analysis

## I. INTRODUCTION

A traditional reference on the effect of pulse-transformer parameters on circuit behavior is Chapter 14, Volume 5, of the M. I. T. Radiation Laboratory Series [1]. The treatment of the pulse back-swing, in this reference, assumes a very long back-swing time in relation to the load portion of the pulse. This assumption simplifies the analysis by eliminating any memory by the circuit from pulse to pulse, and limits the validity of the results to very low duty cycles. When pulse transformers are operated at duty cycles greater than a few percent, it is necessary to account for the pulse to pulse interaction memory in order to characterize the performance.

## II. METHOD OF ANALYSIS

The method of analysis is similar to that used in the M.I.T. Radiation Laboratory Series, Op. Cit. [1], except pulse to pulse circuit memory is introduced by the initial capacitor voltage and inductor current, see Fig.1.

The circuit model includes the effective resistive loading  $R$ , equivalent capacitance  $C$  and a linear inductor  $L$ ; all referred to the primary of the transformer during the reset period. A linear inductor is used in that it is necessary to calculate the wave-form, voltage, current, and flux in convenient closed mathematical form. Even though the saturation flux density of the core material is not included, it is known, and can be related to the calculated value of flux and provides the requirements for the necessary design parameters such that saturation can be avoided. Evaluating the inductor current is equivalent to evaluating the flux as determined by:

$$I = N \frac{\Phi}{L} \quad (1)$$

The circuit model in Fig.1 is a parallel R-L-C circuit which has the three well-know solutions; under damped, critically damped and over damped. These three cases will be analyzed later.

In order to demonstrate the effect of duty cycle, we shall first analyze a simpler L-R circuit model, as shown in Fig.2.

### A. Analysis of L-R circuit Model

# Report Documentation Page

*Form Approved  
OMB No. 0704-0188*

Public reporting burden for the collection of information is estimated to average 1 hour per response, including the time for reviewing instructions, searching existing data sources, gathering and maintaining the data needed, and completing and reviewing the collection of information. Send comments regarding this burden estimate or any other aspect of this collection of information, including suggestions for reducing this burden, to Washington Headquarters Services, Directorate for Information Operations and Reports, 1215 Jefferson Davis Highway, Suite 1204, Arlington VA 22202-4302. Respondents should be aware that notwithstanding any other provision of law, no person shall be subject to a penalty for failing to comply with a collection of information if it does not display a currently valid OMB control number.

1. REPORT DATE <b>01 MAY 2006</b>	2. REPORT TYPE <b>N/A</b>	3. DATES COVERED <b>-</b>	
4. TITLE AND SUBTITLE <b>Reset Behavior of High Duty Cycle Pulse Transformers</b>		5a. CONTRACT NUMBER	
		5b. GRANT NUMBER	
		5c. PROGRAM ELEMENT NUMBER	
6. AUTHOR(S)		5d. PROJECT NUMBER	
		5e. TASK NUMBER	
		5f. WORK UNIT NUMBER	
7. PERFORMING ORGANIZATION NAME(S) AND ADDRESS(ES) <b>Air Force Research Laboratory, Directed Energy Directorate, 3550 Aberdeen Av SE, Kirtland AFB, NM, 87117, USA</b>		8. PERFORMING ORGANIZATION REPORT NUMBER	
9. SPONSORING/MONITORING AGENCY NAME(S) AND ADDRESS(ES)		10. SPONSOR/MONITOR'S ACRONYM(S)	
		11. SPONSOR/MONITOR'S REPORT NUMBER(S)	
12. DISTRIBUTION/AVAILABILITY STATEMENT <b>Approved for public release, distribution unlimited</b>			
13. SUPPLEMENTARY NOTES <b>See also ADM001963. IEEE International Power Modulator Symposium (27th) and High-Voltage Workshop Held in Washington, DC on May 14-18, 2006, The original document contains color images.</b>			
14. ABSTRACT			
15. SUBJECT TERMS			
16. SECURITY CLASSIFICATION OF:			17. LIMITATION OF ABSTRACT
a. REPORT <b>unclassified</b>	b. ABSTRACT <b>unclassified</b>	c. THIS PAGE <b>unclassified</b>	<b>UU</b>
			18. NUMBER OF PAGES <b>4</b>
			19a. NAME OF RESPONSIBLE PERSON

The simple L-R circuit model for reset analysis is shown in Fig.2.

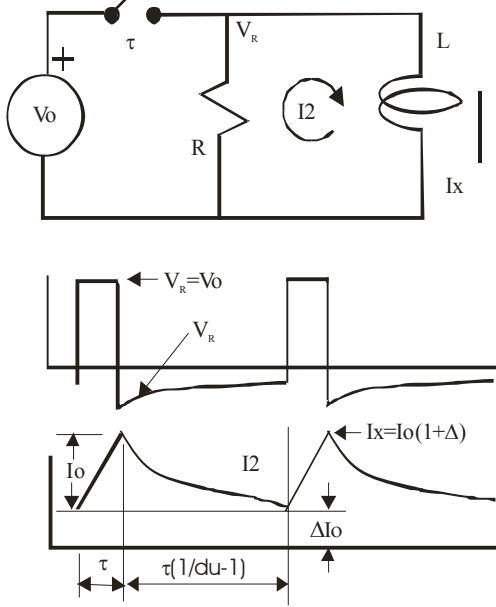

Fig.2: Simple L-R Reset Circuit Model

The inductor current is given by:

$$I2(t) = Ix \cdot e^{-\frac{t-R}{L}}, \quad (2)$$

where the time is measured from the end of the applied pulse. If the circuit is operating in steady state the current at the end of the reset period is given by setting  $t = \tau((1/du) - 1)$ . The increase in inductor current during the pulse is given by:

$$I_0 = V_0 \frac{\tau}{L} \cdot \quad (3)$$

In steady state the current at any two corresponding time points in the wave form separated by the period, T is the same. So we can write the following equation to determine the effect of the duty cycle du.

$$I2(0) = I2\left(\tau\left(\frac{1}{du} - 1\right)\right) + I_0 \quad (4)$$

Ix is expressed as:

$$Ix = I_0(1 + \Delta) \quad (5)$$

If this representation of Ix is used in equation (4) which is then normalized by I0 and solved for Delta, the result is:

$$\Delta(du) = \frac{1}{e^{\frac{(du-1)\tau R}{Ldu}} - 1} \quad (6)$$

where du = the duty cycle ( $\tau/T$ ).

The value of I0 is the increase in inductor current, or flux per equation (1), due to the driving pulse source. Then,  $1 + \Delta$  is the maximum current or flux density normalized to the driving pulse source. A plot of  $1 + \Delta$  is shown in Fig.3 for a range of du from 0.0001 to 0.25, and values of  $\tau R/L$  from 0.1 to 1. Notice that the peak normalized current or flux can reach values that are several times the low duty level when the duty cycle is above ~10% or higher.

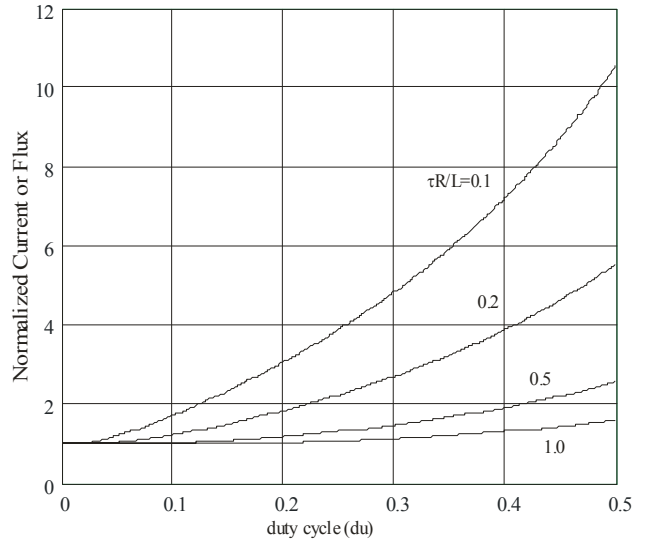

Fig.3: Normalized Maximum Current or Flux vs Duty Cycle for Values of  $\tau R/L$

### B. Analysis of R-L-C Circuit Model

The analysis of the circuit in Fig.1 has the three familiar cases of under damped, critically damped and over damped. We define the corresponding normalized currents at the end of the reset period, as in Fig.2, as  $\Delta_{ud}$ ,  $\Delta_{cd}$  and  $\Delta_{od}$ . The circuit equations are solved using Laplace transforms and the parameters:

$$k = \frac{-\tau}{2RC} \quad (7); \quad m = \frac{\tau}{\sqrt{LC}} \quad (8); \quad \xi = \sqrt{|k^2 - m^2|} \quad (9)$$

The results are equations (13) through (21) for  $\Delta$ ,  $I2N$  and  $V2N$  for the three cases of over, critical and under damping. The criteria for damping are:

$$\text{Over damping} \quad R > \frac{1}{2} \sqrt{L/C} \quad (10)$$

$$\text{Critical damping} \quad R = \frac{1}{2} \sqrt{L/C} \quad (11)$$

$$\text{Under damping} \quad R < \frac{1}{2} \sqrt{L/C} \quad (12)$$

## III. RESULTS

To illustrate the analysis, we assign the following values for the circuit in Fig.1:  $V_0 = 1000$ ,  $\tau$  (pulse width) =  $10 \mu\text{Sec}$ ,  $du = 0.10$  (duty cycle),  $L = 8 \text{mH}$  (transformer primary inductance), and  $C = 10 \text{nF}$  (equivalent circuit total capacitance referred to the primary). Three values of R, for the three damping conditions, are taken as:  $R_{od} = 25$ ,  $R_{cd} = 894$  and  $R_{ud} = 5000$ . The parameter m is determined as  $m = 1.118$ . The values of k and  $\xi$  depend on the corresponding values of R.

The results are normalized for current, flux and voltage. Since the pulse width as defined does not include the fall time, the current and flux continue to increase and reach the maximum value as the fall time voltage reaches zero. Notice that the over damped case experiences a large flux off-set relative to the single pulse of low duty cycle case. The equation notation uses N for normalized, OD, CD and UD for over, critical, and under damping, respectively.

$$\Delta OD(du, k, m) := \frac{(\xi - k + 1) \cdot e^{-2 \cdot \xi \cdot \frac{du-1}{du}} + (\xi - 1 + k)}{e^{-2 \cdot \xi \cdot \frac{-1+du}{du}} \cdot (-\xi + k) + 2 \cdot \xi \cdot e^{(k-\xi) \cdot \frac{du-1}{du}} - \xi - k} \quad (13)$$

$$I2NOD(t) := \frac{-1}{2} \cdot \frac{e^{(k+\xi) \cdot \frac{t}{\tau}} \cdot (-1 + k - \xi + k \cdot \Delta OD - \Delta OD \cdot \xi) + e^{(k-\xi) \cdot \frac{t}{\tau}} \cdot (1 - k - \xi - k \cdot \Delta OD - \Delta OD \cdot \xi)}{\xi} \quad (14)$$

$$V2NOD(t) := \left[ \frac{-1}{2} \cdot \frac{e^{(k+\xi) \cdot \frac{t}{\tau}} \cdot [-1 + (1 + \Delta OD) \cdot (k - \xi)] + (k - \xi) \cdot e^{(k-\xi) \cdot \frac{t}{\tau}} \cdot [1 - (1 + \Delta OD) \cdot (k + \xi)]}{\xi} \right] \quad (15)$$

$$\Delta CD(du, k) := \frac{k \cdot (1 - du) - 1}{k \cdot \frac{du-1}{du} \cdot [k \cdot (du - 1) + du] - du \cdot e} \quad (16)$$

$$I2NCD(t) := e^{\frac{k}{\tau} \cdot t} \cdot \left[ \frac{t}{\tau} \cdot [1 - k \cdot (1 + \Delta I)] + 1 + \Delta CD \right] \quad (17)$$

$$V2NCD(t) := e^{\frac{k}{\tau} \cdot t} \cdot \left[ k \cdot \frac{t}{\tau} \cdot [1 - k \cdot (1 + \Delta CD)] + 1 \right] \quad (18)$$

$$\Delta ud(du, k, m) := \frac{(1 - k) \cdot \sin\left(\frac{du-1}{du} \cdot \xi\right) - \xi \cdot \cos\left(\frac{du-1}{du} \cdot \xi\right)}{k \cdot \sin\left(\frac{du-1}{du} \cdot \xi\right) + \xi \cdot \cos\left(\frac{du-1}{du} \cdot \sqrt{m^2 - k^2}\right) - \xi \cdot e^{\frac{du-1}{du} \cdot k}} \quad (19)$$

$$I2NUD(t, k, m) := -e^{-\frac{t}{\tau} \cdot k} \cdot \frac{\sin\left(\frac{t}{\tau} \cdot \xi\right) \cdot [k \cdot (1 + \Delta ud) - 1] - \cos\left(\frac{t}{\tau} \cdot \xi\right) \cdot \xi \cdot (1 + \Delta ud)}{\xi} \quad (20)$$

$$V2NUD(t) := e^{-\frac{t}{\tau} \cdot k} \cdot \frac{\sin\left(\frac{t}{\tau} \cdot \xi\right) \cdot [k - m^2 \cdot (1 + \Delta ud)] + \cos\left(\frac{t}{\tau} \cdot \xi\right) \cdot \xi}{\xi} \quad (21)$$

It is convenient to display the results in phase-plane diagrams with normalized voltage as the abscissa, and normalized current or flux as the ordinate. The trajectory of the plot circulates counterclockwise with time and represents a full cycle of the waveform in the steady state. From these plots the maximum normalized values are easily identified. The phase plane displays are shown in Figs.,5 and 6 for the three damping cases.

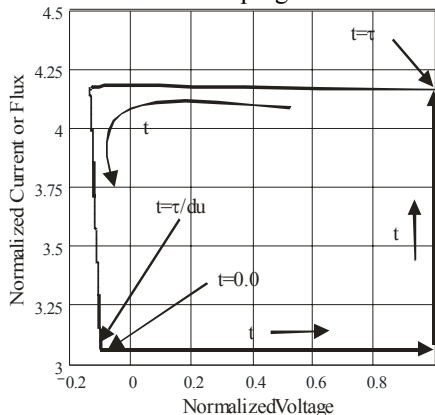

Fig.4: Phase Plane Plot for Over Damped Case

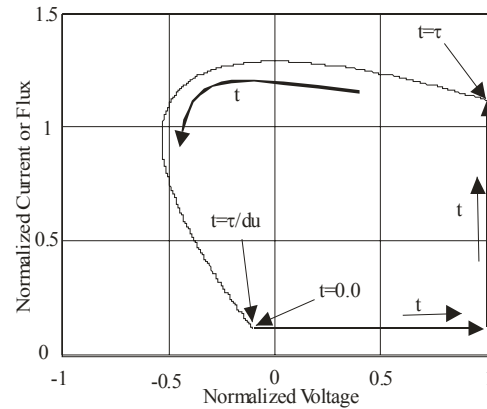

Fig.5: Phase Plane Plot for Critical Damping

The actual calculations are limited to the back-swing or reset portion of the waveform. The pulse excitation is assumed to be rectangular with zero rise and fall times. This is an acceptable approach because the objective is to develop a given total flux during the excitation pulse. To this end, the fine details of the pulse shape are not important. The phase plane plots do not relate accurate time scaling data; to obtain this it is necessary to use the current and voltage time plots.

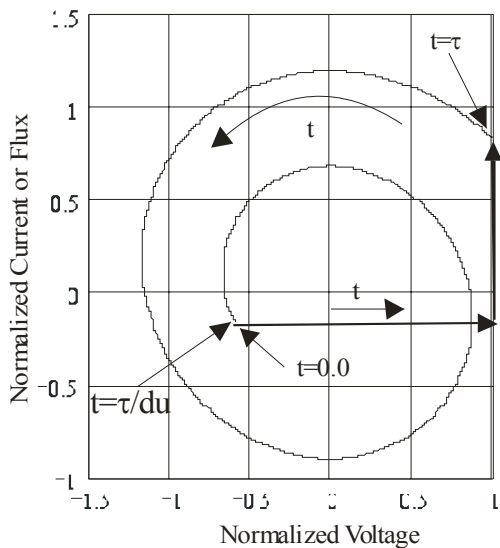

Fig.6: Phase Plane Plot for the Under Damped Case.

Equations (13) through (20) can be used to provide the waveform time characteristics. Space is not sufficient to show all six time plots of the current and voltage data in this paper. The time plots for the under damped case are shown in Figs.7, 8.

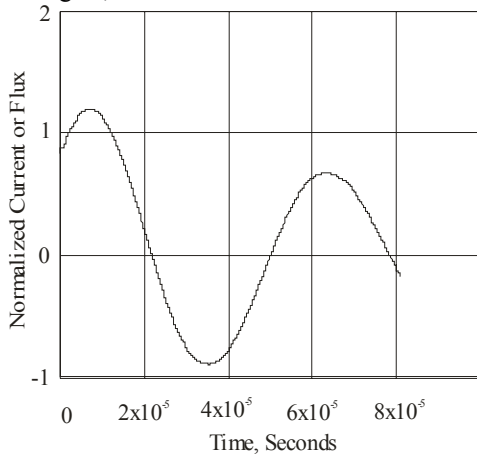

Fig.7: Normalized Flux/Current, Under Damped Case.

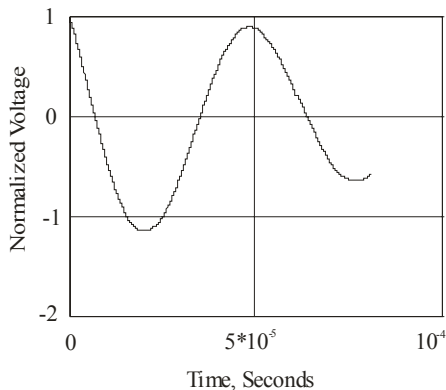

Fig.8: Normalized Voltage, Under Damped Case.

#### IV. DISCUSSION

The waveforms calculated using equations in this paper were checked using circuit analysis programs and

were found to be in precise agreement both, for the few examples in this paper and for numerous other variations.

It is obvious that the circuit parameters,  $k$  and  $m$ , as well as the duty cycle, can strongly affect the maximum flux that the core must accommodate. In extreme cases, this peak flux is several times the peak flux determined by a single pulse or at very low duty cycle, although the peak to peak flux swing is the same. When the transformer is designed to accommodate this high peak flux, it is equivalent to designing a low duty cycle transformer that has a much higher volt-second rating. This situation can be overcome by using a bias reset current such that the full flux swing capability can be utilized. This is usually not feasible at high duty cycle operation, the reason being that high duty cycle implies high PRF. For example, a  $2\mu\text{Second}$  pulse at 10% duty has a PRF of 50,000PPS. At such a high PRF, the flux density must be worked considerably lower than at low duty/PRF. Thus, the high available working flux obtained by using external bias reset is not usable. In other words, transformers at high duty cycle do not generally benefit from the use of external bias reset. One possible exception could apply to burst mode operation where the very high core loss could be tolerated for burst lengths that do not exceed the thermal time constant of the unit.

It is suggested that the practical use of the equations in this paper is best implemented by installing the equations and format into mathematical computational programs or spread sheets. Generating a set of plots for a wide range of parameters and duty cycles would require an enormous number of pages and computation time.

The use of a linear inductance is justified for the core model in that the analysis will show what the actual flux excursions are. If they exceed the material saturation bounds, it is obvious that the design must be modified until the saturation level is not exceeded.

#### REFERENCES

- [1] G. N. Glasoe and J. V. Lebacqz, *Pulse Generators, M.I.T. Radiation Laboratory Series, Volume 5, Chapter 14*. Boston Technical Publishers, 1964.