

# DoD Logistics Roadmap



## Overview

# Report Documentation Page

Form Approved  
OMB No. 0704-0188

Public reporting burden for the collection of information is estimated to average 1 hour per response, including the time for reviewing instructions, searching existing data sources, gathering and maintaining the data needed, and completing and reviewing the collection of information. Send comments regarding this burden estimate or any other aspect of this collection of information, including suggestions for reducing this burden, to Washington Headquarters Services, Directorate for Information Operations and Reports, 1215 Jefferson Davis Highway, Suite 1204, Arlington VA 22202-4302. Respondents should be aware that notwithstanding any other provision of law, no person shall be subject to a penalty for failing to comply with a collection of information if it does not display a currently valid OMB control number.

|  |                                    |                                     |                            |   |                                 |
|--|------------------------------------|-------------------------------------|----------------------------|---|---------------------------------|
| 1. REPORT DATE<br><b>10 SEP 2008</b>   |                                    | 2. REPORT TYPE                      |                            | 3. DATES COVERED<br><b>00-00-2008 to 00-00-2008</b> |                                 |
| 4. TITLE AND SUBTITLE<br><b>DoD Logistics Roadmap Overview</b>   |                                    |                                     |                            | 5a. CONTRACT NUMBER                                 |                                 |
|  |                                    |                                     |                            | 5b. GRANT NUMBER                                    |                                 |
|  |                                    |                                     |                            | 5c. PROGRAM ELEMENT NUMBER                          |                                 |
| 6. AUTHOR(S)   |                                    |                                     |                            | 5d. PROJECT NUMBER                                  |                                 |
|  |                                    |                                     |                            | 5e. TASK NUMBER                                     |                                 |
|  |                                    |                                     |                            | 5f. WORK UNIT NUMBER                                |                                 |
| 7. PERFORMING ORGANIZATION NAME(S) AND ADDRESS(ES)<br><b>Department of Defense.,Office of the Assistant Deputy Under Secretary of Defense for Supply Chain,Washington,DC</b> |                                    |                                     |                            | 8. PERFORMING ORGANIZATION REPORT NUMBER            |                                 |
| 9. SPONSORING/MONITORING AGENCY NAME(S) AND ADDRESS(ES)  |                                    |                                     |                            | 10. SPONSOR/MONITOR'S ACRONYM(S)                    |                                 |
|  |                                    |                                     |                            | 11. SPONSOR/MONITOR'S REPORT NUMBER(S)              |                                 |
| 12. DISTRIBUTION/AVAILABILITY STATEMENT<br><b>Approved for public release; distribution unlimited</b>  |                                    |                                     |                            |   |                                 |
| 13. SUPPLEMENTARY NOTES  |                                    |                                     |                            |   |                                 |
| 14. ABSTRACT   |                                    |                                     |                            |   |                                 |
| 15. SUBJECT TERMS  |                                    |                                     |                            |   |                                 |
| 16. SECURITY CLASSIFICATION OF:  |                                    |                                     | 17. LIMITATION OF ABSTRACT | 18. NUMBER OF PAGES                                 | 19a. NAME OF RESPONSIBLE PERSON |
| a. REPORT<br><b>unclassified</b>   | b. ABSTRACT<br><b>unclassified</b> | c. THIS PAGE<br><b>unclassified</b> |                            |   |                                 |



# The DoD Logistics Roadmap...

- 1 ...establishes a DoD-wide framework for improving logistics capabilities and business processes
- 2 ...documents specific actions underway to achieve goals and objectives
- 3 ...documents performance targets for tracking and reporting progress
- 4 ...provides a basis for current and future capabilities assessment
- 5 ...facilitates communication with Congress, the GAO, and other outside agencies





# The Roadmap is a living document...

... that establishes objectives adding fidelity and detail to logistics goals specified in the Guidance for the Development of the Force

## Strategic Direction

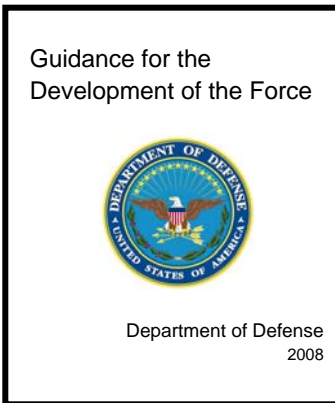

**Provides a unified statement of what we want to do**

## DoD Logistics Roadmap

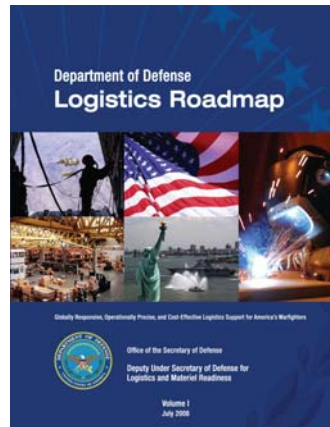

**Defines a coherent framework for providing globally responsive, operationally precise, and cost-effective logistics capabilities to support America's warfighters**

- **OSD senior logistics leaders establish objectives linked to logistics goals in GDF**
- **Joint team maps DoD Component initiatives and programs to objectives**

## Assessment Process

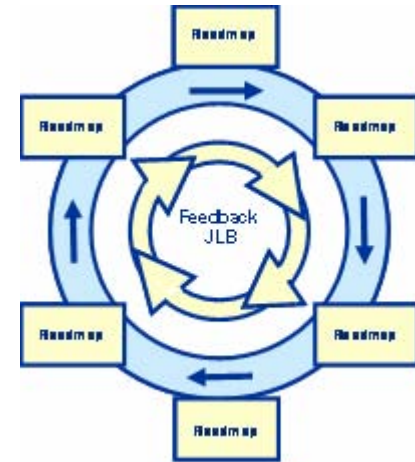

**Institutionalized continuous assessment and feedback**



# The Guidance for the Development of the Force specified three logistics goals...

Strategic Direction

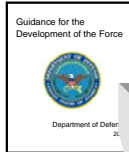

Provides a unified statement of what we want to do

DoD Logistics Roadmap



- OSD senior logistics leaders establish objectives linked to logistics goals in GDF
- Joint team maps component

Assessment Process



Guidance for the Development of the Force



Department of Defense  
2008

- **Unity of Effort**
- **Visibility**
- **Rapid and Precise Response**

*Provides a unified statement of what we want to do*



# The Roadmap established objectives linked to goals, then identified initiatives and programs linked to objectives...

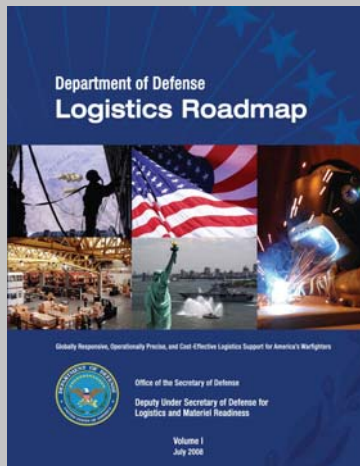

*Defines a coherent framework for providing globally responsive, operationally precise, and cost-effective logistics capabilities to support America's warfighters*

- OSD senior logistics leaders established objectives linked to logistics goals in GDF
- Focused on the Logistics Joint Capability Areas of
  - Supply
  - Maintain
  - Deployment & Distribution
- A collaborative and joint effort identified Component initiatives and programs supporting Roadmap objectives
- Joint team mapped DoD Component initiatives and programs to objectives



# Assessments of Roadmap objectives...

## Strategic Direction

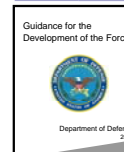

## DoD Logistics Roadmap



- OSD senior logistics leaders establish objectives linked to logistics goals in GDF
- Joint team maps

## Assessment Process

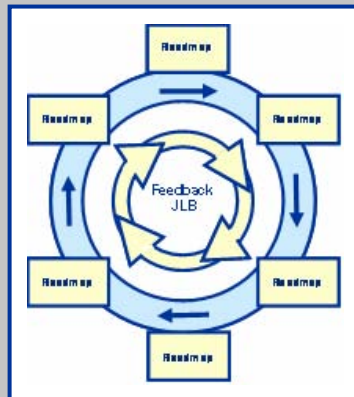
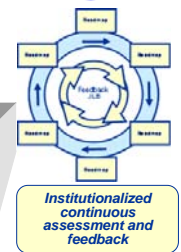

*Institutionalized  
continuous  
assessment and  
feedback*

- Take a strategic look at progress toward achieving goals and objectives
- Identify capability and capacity
  - Gaps, shortfalls, and overlaps
  - Timing issues
  - Challenges
  - Resource issues
- Inform key DoD processes



# The Roadmap process will inform...

... PPBE, FY10 QDR, and other DoD processes

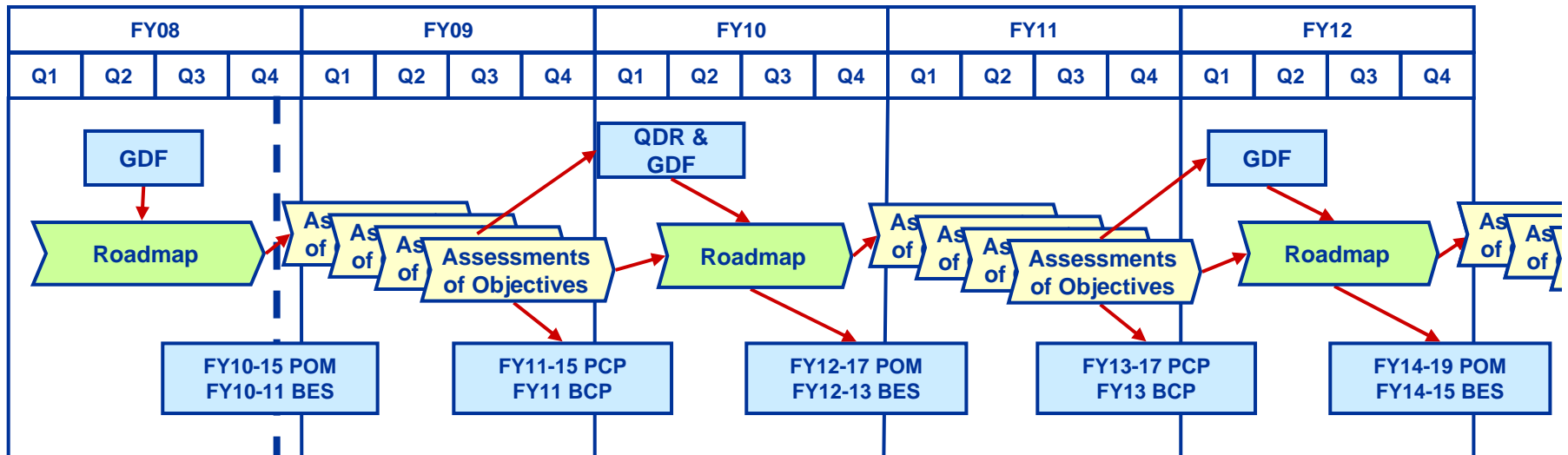

*POM* Program Objective Memorandum

*PCP* Program Change Proposal

*BES* Budget Estimate Submission

*BCP* Budget Change Proposal

**Notional timeline**





# The DoD Logistics Roadmap has two volumes...

- Volume I has
  - An executive summary
  - A chapter that states the GDF logistics goals, establishes objectives to achieve the goals, and links the objectives to specific logistics capability areas
  - Four chapters that document specific actions underway or planned to achieve the objectives
  - A chapter that lays out the next steps in Roadmap application and development
  - Six appendices that provide background and details
- Volume II has two appendices that provide expanded information on each initiative and program of record identified in Volume I

Available at: [http://www.acq.osd.mil/log/sci/executive\\_info.htm#Roadmap](http://www.acq.osd.mil/log/sci/executive_info.htm#Roadmap)



**For additional information contact...**

Ms. Debra Bennett

Office of the Assistant Deputy Under  
Secretary of Defense for Supply Chain  
Integration

(703) 604-1080 Extension 201

Debra.Bennett@osd.mil