



**AFRL-RX-TY-TR-2008-4607**

## **DEPLOYABLE FUEL CELL POWER GENERATOR – MULTI-FUEL PROCESSOR**

**Aly H. Shaaban, Christian D. Rasmussen and Ragab M. Moheisen**

**Applied Research Associates  
P.O. Box 40128  
Tyndall Air Force Base, FL 32403**

**FEBRUARY 2009**

**Final Report for 1 October 2002 – 02 October 2008**

**DISTRIBUTION STATEMENT A: Approved for public release; distribution unlimited.**

**AIRBASE TECHNOLOGIES DIVISION  
MATERIALS AND MANUFACTURING DIRECTORATE  
AIR FORCE RESEARCH LABORATORY  
AIR FORCE MATERIEL COMMAND  
139 BARNES DRIVE, SUITE 2  
TYNDALL AIR FORCE BASE, FL 32403-5323**

## NOTICE AND SIGNATURE PAGE

Using Government drawings, specifications, or other data included in this document for any purpose other than Government procurement does not in any way obligate the U.S. Government. The fact that the Government formulated or supplied the drawings, specifications, or other data does not license the holder or any other person or corporation; or convey any rights or permission to manufacture, use, or sell any patented invention that may relate to them.

This report was cleared for public release by the Air Force Research Laboratory, Materials and Manufacturing Directorate, Airbase Technologies Division, Public Affairs and is available to the general public, including foreign nationals. Copies may be obtained from the Defense Technical Information Center (DTIC) (<http://www.dtic.mil>).

REPORT NUMBER AFRL-RX-TY-TR-2008-4607 HAS BEEN REVIEWED AND IS APPROVED FOR PUBLICATION IN ACCORDANCE WITH ASSIGNED DISTRIBUTION STATEMENT.

\_\_\_\_\_  
*//signature//*  
REZA SALAVANI  
Work Unit Manager

\_\_\_\_\_  
*//signature//*  
SANDRA R. MEEKER, DR-IV  
Chief, Deployed Base Systems Branch

\_\_\_\_\_  
*//signature//*  
MICHAEL R. UPDIKE, Lt Col, USAF  
Deputy Chief, Airbase Technologies Division

This report is published in the interest of scientific and technical information exchange, and its publication does not constitute the Government's approval or disapproval of its ideas or findings.

**REPORT DOCUMENTATION PAGE***Form Approved  
OMB No. 0704-0188*

The public reporting burden for this collection of information is estimated to average 1 hour per response, including the time for reviewing instructions, searching existing data sources, gathering and maintaining the data needed, and completing and reviewing the collection of information. Send comments regarding this burden estimate or any other aspect of this collection of information, including suggestions for reducing the burden, to Department of Defense, Washington Headquarters Services, Directorate for Information Operations and Reports (0704-0188), 1215 Jefferson Davis Highway, Suite 1204, Arlington, VA 22202-4302. Respondents should be aware that notwithstanding any other provision of law, no person shall be subject to any penalty for failing to comply with a collection of information if it does not display a currently valid OMB control number.

**PLEASE DO NOT RETURN YOUR FORM TO THE ABOVE ADDRESS.**

<b>1. REPORT DATE (DD-MM-YYYY)</b>		<b>2. REPORT TYPE</b>		<b>3. DATES COVERED (From - To)</b>	
<b>4. TITLE AND SUBTITLE</b>				<b>5a. CONTRACT NUMBER</b>	
				<b>5b. GRANT NUMBER</b>	
				<b>5c. PROGRAM ELEMENT NUMBER</b>	
<b>6. AUTHOR(S)</b>				<b>5d. PROJECT NUMBER</b>	
				<b>5e. TASK NUMBER</b>	
				<b>5f. WORK UNIT NUMBER</b>	
<b>7. PERFORMING ORGANIZATION NAME(S) AND ADDRESS(ES)</b>				<b>8. PERFORMING ORGANIZATION REPORT NUMBER</b>	
<b>9. SPONSORING/MONITORING AGENCY NAME(S) AND ADDRESS(ES)</b>				<b>10. SPONSOR/MONITOR'S ACRONYM(S)</b>	
				<b>11. SPONSOR/MONITOR'S REPORT NUMBER(S)</b>	
<b>12. DISTRIBUTION/AVAILABILITY STATEMENT</b>					
<b>13. SUPPLEMENTARY NOTES</b>					
<b>14. ABSTRACT</b>					
<b>15. SUBJECT TERMS</b>					
<b>16. SECURITY CLASSIFICATION OF:</b>			<b>17. LIMITATION OF ABSTRACT</b>	<b>18. NUMBER OF PAGES</b>	<b>19a. NAME OF RESPONSIBLE PERSON</b>
<b>a. REPORT</b>	<b>b. ABSTRACT</b>	<b>c. THIS PAGE</b>			<b>19b. TELEPHONE NUMBER (Include area code)</b>

## TABLE OF CONTENTS

List of Figures.....	iv
List of Tables.....	v
Summary.....	1
1. INTRODUCTION .....	2
2. OBJECTIVES .....	2
3. RESEARCH PROGRAM.....	2
3.1 Sulfur Removal Group:.....	4
3.2 Steam Reforming Group:.....	6
3.3 Balance of Plant Group:.....	8
3.4 Plant Control System: .....	9
4. APPROACH AND DISCUSSION .....	11
4.1 Test Procedure .....	12
4.2 Test Results and Discussion .....	12
5. CONCLUSION.....	21
REFERENCES .....	23
APPENDIX A: Definition Of The Fuel Processor Components And Flow Streams.....	24
APPENDIX B: Transestrification Biodiesel Process .....	26
APPENDIX C: Multi-Fuel Processor Performance Calculation Procedure.....	29
APPENDIX D: Startup and Test Procedures .....	31
APPENDIX E: Test Results .....	33

## LIST OF FIGURES

<b>1:</b> General Fuel Processor Schematic .....	3
<b>2:</b> The Multi-Fuel Processor for a 1.5kW SOFC Stack .....	4
<b>3:</b> The Fractionator Unit .....	5
<b>4:</b> Steam Generator and the Radiant Burner .....	6
<b>5:</b> Steam Reforming Reactor and the Radiant Burner .....	7
<b>6:</b> Combustion Fuel Vaporizer.....	8
<b>7:</b> Balance of Plant – Reformer Burner Fuel Pump, Steam Generator Burner Fuel Pump, Process JP-8 Pump, and Process Water Pump .....	9
<b>8:</b> Control System Input / Output Modules.....	10
<b>9:</b> LabView Virtual Instrument Interface .....	10
<b>10:</b> Thermodynamics of Carbon Formation in JP8 Reforming at 1 atm .....	13
<b>11:</b> H <sub>2</sub> Selectivity as a Function of JP8 Reformate Temperature and S/C. ....	14
<b>12:</b> CO Selectivity as a Function of JP8 Reformate Temperature and S/C. ....	14
<b>13:</b> CH <sub>4</sub> Selectivity as a Function of JP8 Reformate Temperature and S/C.....	14
<b>14:</b> H <sub>2</sub> Selectivity as a Function of Diesel Reformate Temperature and S/C.....	14
<b>15:</b> CO Selectivity as a Function of Diesel Reformate Temperature and S/C.....	14
<b>16:</b> CH <sub>4</sub> Selectivity as a Function of Diesel Reformate Temperature and S/C. ....	14
<b>17:</b> H <sub>2</sub> Selectivity as a Function of S8 Reformate Temperature and S/C.....	15
<b>18:</b> CO Selectivity as a Function of S8 Reformate Temperature and S/C.....	15
<b>19:</b> CH <sub>4</sub> Selectivity as a Function of S8 Reformate Temperature and S/C. ....	15
<b>20:</b> H <sub>2</sub> Selectivity as a Function of 50/50 mix Reformate Temperature and S/C.....	15
<b>21:</b> CO Selectivity as a Function of 50/50 mix Reformate Temperature and S/C. ....	15
<b>22:</b> CH <sub>4</sub> Selectivity as a Function of 50/50 mix Reformate Temperature and S/C. ....	15
<b>23:</b> H <sub>2</sub> Selectivity as a Function of Propane Reformate Temperature and S/C. ....	16
<b>24:</b> CO Selectivity as a Function of Propane Reformate Temperature and S/C.....	16
<b>25:</b> CH <sub>4</sub> Selectivity as a Function of Propane Reformate Temperature and S/C. ....	16
<b>26:</b> H <sub>2</sub> Selectivity as a Function of Biodiesel Reformate Temperature and S/C. ....	16
<b>27:</b> CO Selectivity as a Function of Biodiesel Reformate Temperature and S/C.....	16
<b>28:</b> CH <sub>4</sub> Selectivity as a Function of Biodiesel Reformate Temperature and S/C. ....	16
<b>29:</b> Hydrogen Generation Rate In Reformate Streams .....	18
<b>30:</b> Hydrogen Available from Fuel for 2 and 4.3 g/min Fuel Flow Rates.....	18

<b>31:</b> System Pressure and Reformate Flow for JP8 and 50/50 Mix.....	19
<b>32:</b> H <sub>2</sub> Selectivity Comparison for JP8 and 50/50 Mix. ....	20
<b>33:</b> Performance Comparison Between JP8 and 50/50 Mix.....	21

### **LIST OF TABLES**

<b>1:</b> Multi-Fuel Test Matrix – 2 and 4.3g/min Fuel Flow Rates.....	11
<b>2:</b> JP8 Reforming Data Comparison.....	17

## **ACKNOWLEDGEMENT**

THE AUTHORS ACKNOWLEDGE AND THANK **MR. TIMOTHY J CAMPBELL** FOR HIS EFFORTS IN THE DEVELOPMENT OF FUEL REFORMING PROCESS AND DATA ANALYSIS PROCEDURES AND **MR. JOSHUA MORMILE** FOR HIS EFFORTS IN THE TRANSESTRIFICATION OF VEGETABLE OIL TO BIODIESEL.

## SUMMARY

With the high probability of introduction of renewable fuel sources such as synthetic fuels, biodiesel, and syngas into Air Force bases, the stakes are high to find an electric generator technology that can adequately and efficiently utilize these fuels in meeting the Executive Order (EO) 13423 and the Energy Policy Act of 2005 to improve energy efficiency and reduce greenhouse gas emissions 3 percent annually or 30 percent by 2015 at military bases.

The logistic fuel processing technology developed by AFRL/RXQ converts hydrocarbon fuels to hydrogen rich syngas to power fuel cell electric generators; the intended use has been to replace Mobile Electric Power (MEP) generators. There are many applications for fuel cell electric generators, for example, Auxiliary Power Units (APU) provide secondary power for start up of the larger aircraft main engines. In addition, APUs provide power to large trucks' cabins during stops to run air conditioning and refrigeration equipment to minimize CO<sub>2</sub> emissions. Distributed power generation, where quiet generators are distributed to strategic locations to provide power to residential subdivisions and industrial compounds to cut down on transmission cost, power losses, and emissions, are applications that are well suited for fuel cells technology. For practical reasons, these power generators would use the fuel available in the applications. APUs will use the same fuel of the main engine which is jet fuel (kerosene) in the case of aircraft and diesel or biodiesel in the case of large trucks. While distributed power fuel cells will use available fuel such as natural gas (methane) or propane. The ability to reform multitude of fuels can accelerate the introduction of more efficient and quiet fuel cell electric generators into power applications.

The fuel processor used in this effort is a laboratory demo unit to demonstrate the direct steam reforming concept. Packed-bed steam reforming reactor and coiled tube steam generator with radiant burners were used. The developed fuel processor successfully reformed JP8, synthetic jet fuel (S8), diesel, biodiesel, and propane. It also showed that reforming S8 and a 50/50 mixture of JP8 and S8 is more efficient than reforming JP8. The fuel processor performance reforming biodiesel surpassed its performance in reforming the other five fuels.



## **1. INTRODUCTION**

With the high probability of introduction of renewable fuel sources such as synthetic fuels, biodiesel, and syngas into Air Force bases, the stakes are high to find an electric generator technology that can adequately and efficiently utilize these fuels in meeting the Executive Order (EO) 13423 and the Energy Policy Act of 2005 to improve energy efficiency and reduce greenhouse gas emissions 3 percent annually or 30 percent by 2015 at military bases.

The logistic fuel processing technology developed by AFRL/RXQ converts hydrocarbon fuels to hydrogen rich syngas to power fuel cell electric generators; the intended use has been to replace Mobile Electric Power (MEP) generators. There are many applications for fuel cell electric generators, for example, Auxiliary Power Unit (APU) to provide secondary power for start up of the larger aircraft main engines. In addition, APU to provide power to large trucks' cabins during stops to run air conditioning and refrigeration equipment to minimize CO<sub>2</sub> emissions. Distributed power generation, where quiet electric generators are distributed to strategic locations to provide power to residential subdivisions and industrial compounds to cut down on transmission cost, power losses, and emissions are applications well suited for fuel cells technology. For practical reasons, these power generators would use the fuel available in the applications. APUs will use the same fuel of the main engine which is jet fuel (kerosene) in the case of aircrafts and diesel or biodiesel in the case of large trucks; distributed power fuel cells will use available fuel such as natural gas (methane) or propane. The ability to reform multitude of fuels can accelerate the introduction of more efficient and quiet fuel cell electric generators into power applications.

This report describes the demonstration of the direct steam reforming technology and its results in reforming of JP-8, Synthetic jet fuel (S-8), diesel, biodiesel, and propane.

## **2. OBJECTIVES**

The major objective of this effort was to demonstrate the capabilities of the developed 1.5kW logistic fuel processor in processing multiple fuels to hydrogen rich gas.

## **3. RESEARCH PROGRAM**

The fuel processor used in this effort was a laboratory demo unit to demonstrate the direct steam reforming concept. Packed-bed steam reforming reactor and coiled tube steam generator with radiant burners were used. No effort was spent to optimize the thermal performance of the unit since it was a lab demo and the optimization effort was left to be accomplished in the engineering phase. Future optimization will consider the use of burners' flue gases, thermal integration of fuel cell stack, efficient steam generator, and efficient combustion process. Therefore, thermal performance of the process was not used except for comparison.

The fuel processor was developed, built, and demonstrated with JP-8 and a Versa Power SOFC stack, [1]. The fuel processor, Figure 1, consists of a sulfur removal group, direct steam reforming group, balance of plant (BOP) to maintain process temperatures and utilize waste heat,

and a process control. The design point is a 4.3g/min JP8 flow to the steam reformer to produce reformat stream to power a 1.5kW SOFC stack. The definition of the fuel processor components and flow streams are given in Appendix A.

The steam reforming group and the fractionator are housed in a thermally insulated high temperature component housing to maximize the use of waste heat. The unit measures 30”W x 24”D x 24”H and was designed with modification needs in mind; therefore, the unit has excess space to allow for maintenance and easy change of components during laboratory testing.

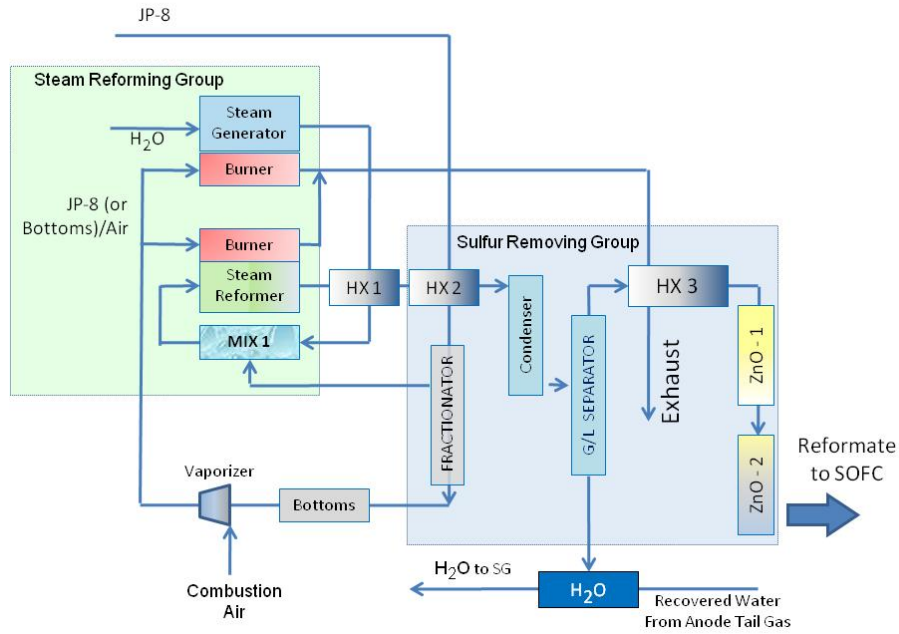

**Figure 1:** General Fuel Processor Schematic

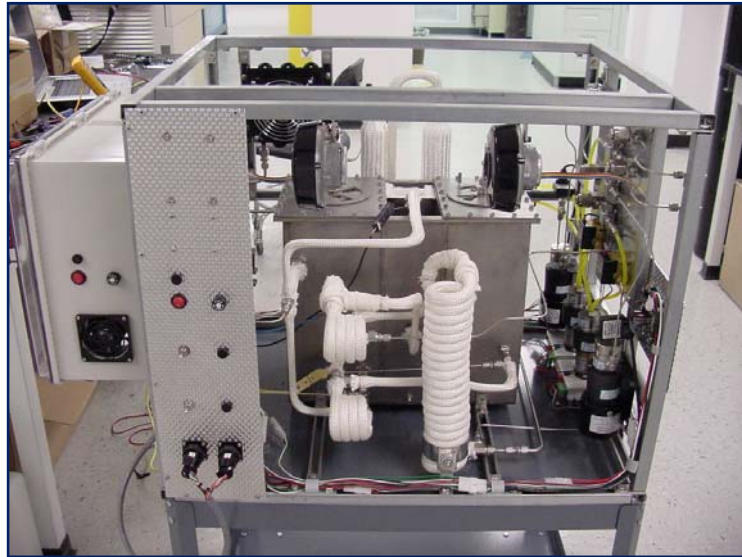
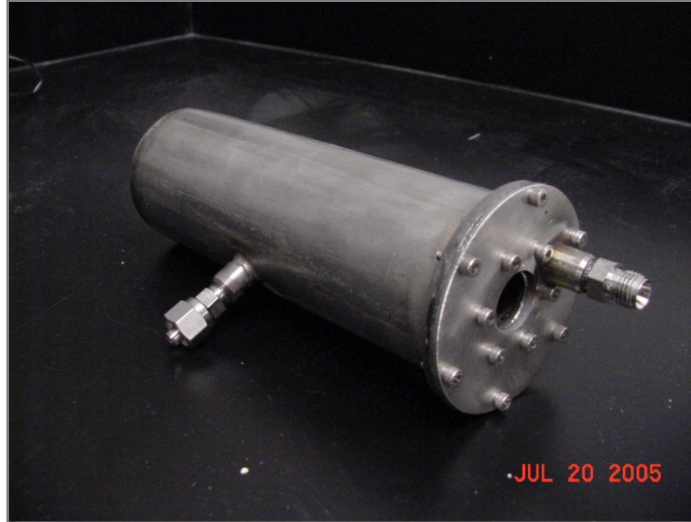

**Figure 2:** The Multi-Fuel Processor for a 1.5kW SOFC Stack

### **3.1 Sulfur Removal Group:**

The sulfur removal group includes the fractionator, condenser, heat exchanger, gas-liquid separator, and two sulfur absorption beds.

The fractionator is an annular design, Figure 3, to allow the exhaust gas to pass through the center of the component, as well as, around the outside to facilitate even heating. The inside of the fractionator contains distillation column packing to aide in the separation of the light and heavy streams. JP-8 enters the fractionator after being preheated in a heat exchanger. The temperature of the fractionator can be adjusted by controlling the flow of hot exhaust gas around it. The temperature required for the correct fractionation of the JP-8 is dependent on the system pressure. Due to variations in the system pressure during startup and steady state operation, it is important to be able to adjust the fractionator temperature through the use of the exhaust control valve. At the design temperature, the lightest fractions which are as much as 2/3 of the JP-8 feed, leaves the top of the fractionator, mixes with the steam from the steam generator, and then proceeds to the reforming reactor. The heaviest fractions, which account for 1/3 of the JP-8 feed, drains from the bottom of the component removing with it up to 80% of the total sulfur in the process fuel feed.

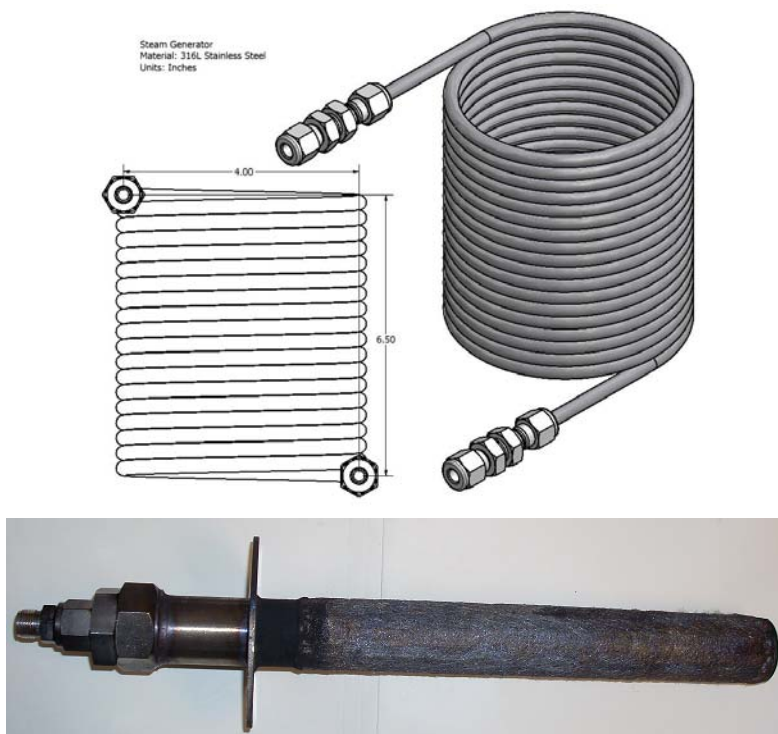

**Figure 3:** The Fractionator Unit

The sulfur removal beds are located directly behind the high temperature component housing. This location puts the beds in close proximity to the heat exchanger recovering burner exhaust heat to adjust the sulfur removal beds to the ideal temperature.

The sulfur removal bed heat exchanger is simply another coiled stainless steel tube with a static mixer insert used to heat the product gas stream before it enters the sulfur removal beds. Proper temperature at this stage is critical in maximizing the life of the sulfur absorbent beds. The product gas flowing in this section of the process is also transient during startup making the adjustable hot exhaust flow over the coil a necessity.

### 3.2. Steam Reforming Group:



**Figure 4:** Steam Generator and the Radiant Burner

The steam reforming group consists of the two high temperature components: a steam generator and a steam reformer. The steam generator evaporates and superheats water to provide superheated steam for the reforming process. The steam reformer extracts hydrogen from the light hydrocarbons feed using steam and a catalyst. The catalyst is used to enhance the kinetics of the reaction between hydrocarbons and steam, yielding  $H_2$ ,  $CO$ , and  $CO_2$ .

The reforming reactor and steam generator are heated by radiant burners, Figures 4 and 5. The steam generator, Figure 4, is a 0.25in OD stainless steel coiled tube with a 0.035in wall thickness. To increase the turbidity of the flow and improve heat transfer, a static mixer was inserted into the tube. The steam generator was designed to produce 33.5g/min steam in excess of 600°C. A design restriction was placed on the pressure drop across the steam generator of 50psi. To produce superheated steam at the necessary flow rate of 33.5g/min, and not exceed the 50psi maximum pressure drop, a 20ft long channel is required. This dictated the fabrication of a 4in diameter coil approximately 6.5in high to provide the proper surface area for heat transfer. This design has held up well over its 500 plus hours of operation. The reforming reactor, Figure 5, is also a coiled tube. The reaction kinetics dictates that the product gas leaving the reformer needs to be above 800°C for complete conversion of all the compounds found in JP-8. At this high temperature, stainless steel does not provide enough corrosion resistance or resistance from creep and spalling. Haynes 230 super alloy was selected as an appropriate material for the reactor construction. It has the high temperature oxidation resistance needed for this application, and it is also workable enough to be turned into a coil. This coil is packed with a commercially

available sulfur tolerant Sud-Chemie steam reforming catalyst. To ensure enough surface area, a 20ft piece of 0.5in OD Haynes 230 tubing was turned into a 5-inch diameter coil.

The reforming reactor and steam generator are enclosed in a central housing along with their respective radiant burners. The coiled reactors surround cylindrical radiant burners. The radiant energy transferred to the reformer and steam generator is adjusted by changing the fuel and air delivered to the burners. The fractionator and sulfur removal bed preheat heat exchangers are also located inside this housing.

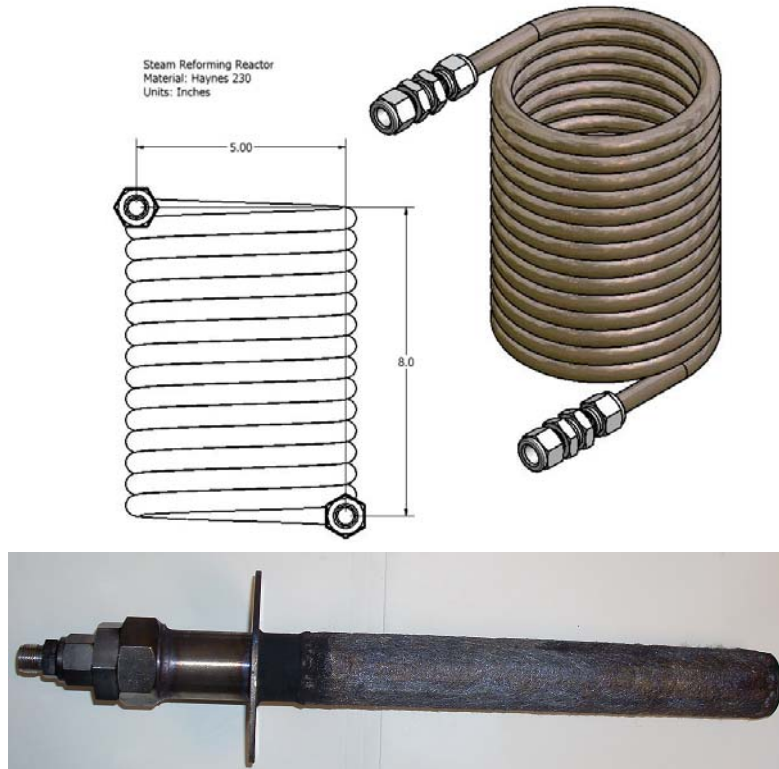

**Figure 5:** Steam Reforming Reactor and the Radiant Burner

The housing is thoroughly insulated on the inside wall with a refractory ceramic fiber insulation. The housing is designed to channel the exhaust from the steam generator and the reformer to the heat exchanger and the fractionator, respectively. There is an adjustable vent above each of the burners to control the flow of exhaust gases.

Fuel is vaporized before entering both burners and steam reformer. A Fuel vaporizer, Figure 6, consists of a FeCrAlM alloy mesh-pad, Micron Fiber-Tech Corp – D-mat, housed in a cavity of a stainless steel frame heated with two electric heaters, Chromalox CTR-2061 – 39W/in<sup>2</sup>. The vaporizer temperature is controlled and maintained to provide steady evaporation rate for the fuel in use and fuel processor demands.

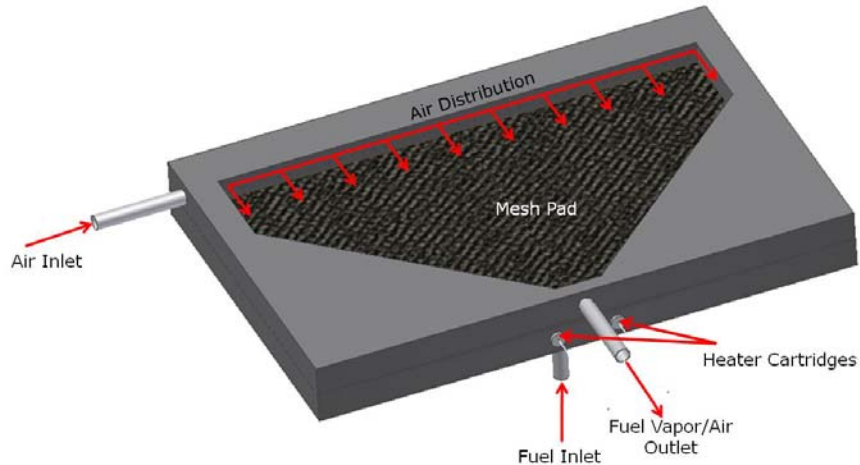

**Figure 6:** Combustion Fuel Vaporizer

### 3.3. Balance of Plant Group:

The system uses grid power for the control system and for the balance of plant. The electrical system is 24VDC to facilitate easy component specification and allow for the possibility of using battery power during startup. The electrical system is located on and behind the onboard control panel mounted to the frame on the left front of the unit. The 24VDC power supply, SolaHD Power Supply SD10-24-100P, is fused to prevent electronic component damage. The 24VDC circuit has its own power switch for safety and to prevent accidental activation of components when making change to the control system.

The balance of plant components are mounted to the frame at various locations on the unit. The pumps are secured to the right of the high temperature component housing, Figure 7. These pumps include the reformer burner fuel pump, the steam generator burner fuel pump, the process JP-8 pump, and the process water pump.

The process pumps were specified with a factor of safety to allow for possible expansion and to ensure long life. The process JP-8 and process water pump, Tuthill D-Series DGS.19PPPV1NN15000 – 0-38 LPH, are magnetically coupled external gear pumps integrated with a Premotec 24VDC brushless motor, Premotec BL58EB – 35W. They can maintain more than the necessary flow rate with a 150psi system pressure, more than twice anticipated system pressure. The burner fuel pumps are Tuthill U-Series magnetically coupled external gear pumps, Tuthill UBS.02CCNT4SN77000 – 0-5 LPH, and were also specified with a factor of safety involved. The burner fuel pumps are integrated with and driven by a 12 VDC brushless motor, Pittman GM9413-1. They can pump more than five times the required flow rate at 40psi and still have good resolution at the calculated steady state flow rate. High pressure is used to help atomize the burner fuel to improve combustion efficiency. If for some reason the maximum pressure rating of the pumps is exceeded, the pump head decouples from the motor preventing damage to the pump. When the pressure drops below the maximum threshold, the motor and pump head are reengaged and pumping continues normally. The pumps are manufactured by Tuthill and have a manufacturer claimed service life of more than 20,000 hours.



**Figure 7:** Balance of Plant – Reformer Burner Fuel Pump, Steam Generator Burner Fuel Pump, Process JP-8 Pump, and Process Water Pump

The rest of the system's heat exchangers are located directly in front of the high temperature component housing to minimize heat loss in the transfer tubing. The primary heat source is the 800°C reformer product stream. This stream contains the product and the remainder of the steam not converted in the reaction. The steam must be condensed, and the water must be removed from the reformat stream before it passes into the sulfur removal beds. This stream is used to further superheat the steam after it leaves the steam generator before entering the reformer. The reformer product stream is then used to preheat the JP-8 before entering the fractionator. Lastly, the remaining heat is used to preheat the water before it enters the steam generator. By utilizing all of the heat generated, the unit maintains a good overall thermal efficiency.

### **3.4. Plant Control System:**

Control of the system is accomplished through the use of National Instruments Field Point hardware and LabView software. The data acquisition and control hardware consist of a FieldPoint Ethernet communication module, National Instruments NI FP-1601, an 8 Channel analog voltage output module, National Instruments NI FP-AO-210, a 16 Bit analog voltage input module, National Instruments NI FP-AI-112, and an 8 Channel/16 Bit thermocouple input module, National Instruments FP-TC-210. These modules along with the system power supply are mounted in a convective air cooled enclosure, Figure 8.





**Figure 8:** Control System Input / Output Modules

The control box has surface mounted receptacles for the thermocouple connectors, the power cable, the Ethernet communication cable, and the system control cable. The box is mounted to the left side of the unit, but it can easily be removed for maintenance or troubleshooting after disconnecting the system control cable and the thermocouple connectors. The multi-pair system control cable transfers all the control signals from the FieldPoint modules to the blowers and pumps. This cable also transfers the signal from the flow meters and pressure transducers to the analog input module. The final purpose of the control cable is to carry the 24VDC excitation voltage to all the balance of plant and control system components.

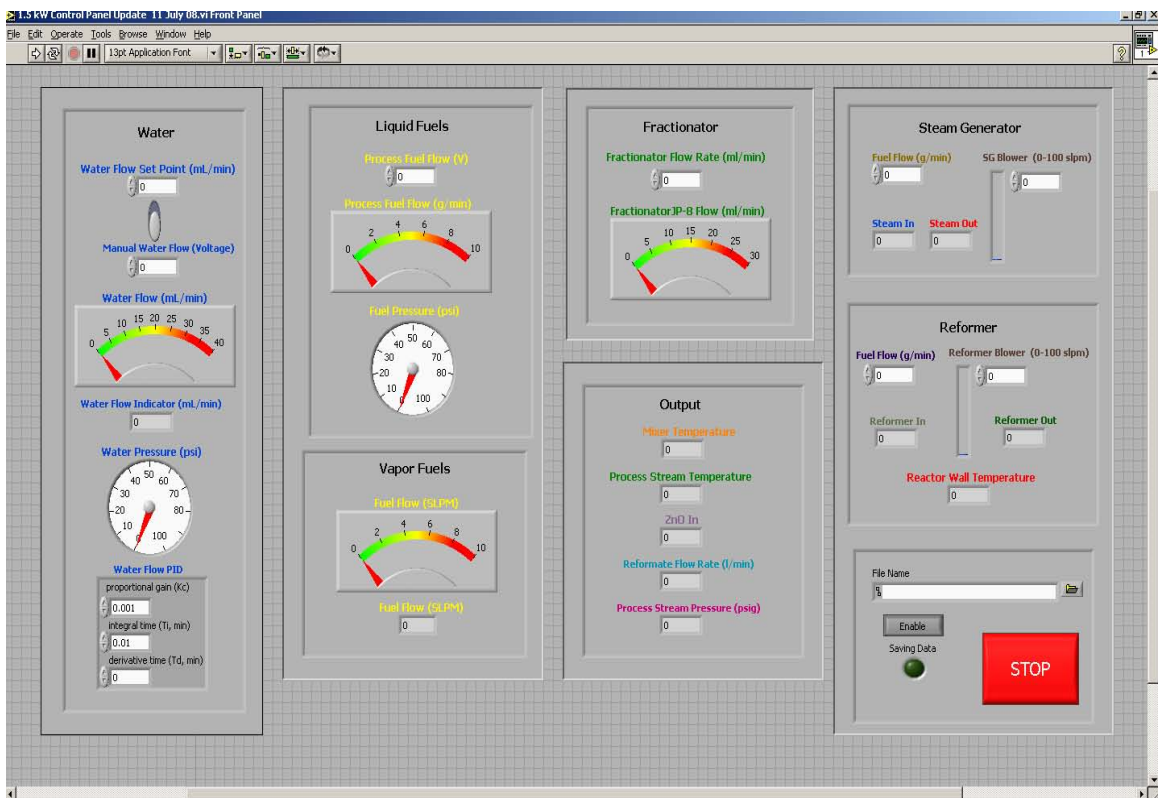

**Figure 9:** LabView Virtual Instrument Interface

The FieldPoint hardware sends and receives signals to and from the various pumps and sensors. It is assisted by additional control hardware on the unit. The blowers are controlled by individual speed controllers. These speed controllers adjust the blowers speed proportional to a 0-5VDC control signal from the FieldPoint module. The process fuel pumps have internal speed controllers which handle the pumps' response to the control voltage. The burner fuel pumps require servo amplifiers to amplify, condition, and calibrate the control signal. These amplifiers and speed controllers provide precise control over the pumps and blowers. The user interface, Figure 9, to send commands to the fuel processor through the FieldPoint hardware was created using LabView 7.1.

#### 4. APPROACH AND DISCUSSION

The Multi-Fuel Processor was tested for six different fuels: JP8; diesel; propane; synthetic jet fuel (S8); 50/50 mixture of S8 and JP8 (50/50 mix); and Biodiesel. Synthetic jet fuel and its 50/50 mixture with JP8 was provided by the Air Force Fuel Certification Office, 77AESW/LF. The biodiesel was produced in-house from frying oil using a transesterification procedure, Appendix B. The test matrix is given in TABLE 1. Twelve (12) tests for each fuel were conducted covering three (3) steam-to-carbon ratios (S/C), 4, 5, and 6. Fuel flow to the steam reformer was kept at 2g/min, which represents half of the full load design. Each S/C had four (4) test runs covering a reforming reactor exit temperature range of 400-800°C. For the JP8, twelve (12) tests were conducted at the full load design of 4.3g/min and eleven (11) tests were conducted for the 50/50 mix at the same fuel flow rate covering the same temperature range. TABLE 1 shows the test matrix for the 2g/min fuel flow rate for all six fuels tested and 4.3g/min for JP8 and 50/50 mix fuels.

**TABLE 1: Multi-Fuel Test Matrix – 2 and 4.3g/min Fuel Flow Rates**

JP8			Diesel			Propane			50/50 S8/JP8			Synthetic: S8			Biodiesel B-100		
S/C	Process Fuel Flow Rate [g/min]	Water Flow Rate [g/min]	S/C	Process Fuel Flow Rate [g/min]	Water Flow Rate [g/min]	S/C	Process Fuel Flow Rate [g/min]	Water Flow Rate [g/min]	S/C	Process Fuel Flow Rate [g/min]	Water Flow Rate [g/min]	S/C	Process Fuel Flow Rate [g/min]	Water Flow Rate [g/min]	S/C	Process Fuel Flow Rate [g/min]	Water Flow Rate [g/min]
4	2.00	10.37	4	2.00	10.51	4	2.00	9.90	4	2.00	10.37	4	2.00	10.37	4	2.00	9.31
4	2.00	10.37	4	2.00	10.51	4	2.00	9.90	4	2.00	10.37	4	2.00	10.37	4	2.00	9.31
4	2.00	10.37	4	2.00	10.51	4	2.00	9.90	4	2.00	10.37	4	2.00	10.37	4	2.00	9.31
4	2.00	10.37	4	2.00	10.51	4	2.00	9.90	4	2.00	10.37	4	2.00	10.37	4	2.00	9.31
5	2.00	12.98	5	2.00	13.16	5	2.00	12.40	5	2.00	12.98	5	2.00	12.98	5	2.00	11.63
5	2.00	12.98	5	2.00	13.16	5	2.00	12.40	5	2.00	12.98	5	2.00	12.98	5	2.00	11.63
5	2.00	12.98	5	2.00	13.16	5	2.00	12.40	5	2.00	12.98	5	2.00	12.98	5	2.00	11.63
5	2.00	12.98	5	2.00	13.16	5	2.00	12.40	5	2.00	12.98	5	2.00	12.98	5	2.00	11.63
6	2.00	15.58	6	2.00	15.81	6	2.00	14.90	6	2.00	15.58	6	2.00	15.58	6	2.00	13.92
6	2.00	15.58	6	2.00	15.81	6	2.00	14.90	6	2.00	15.58	6	2.00	15.58	6	2.00	13.92
6	2.00	15.58	6	2.00	15.81	6	2.00	14.90	6	2.00	15.58	6	2.00	15.58	6	2.00	13.92
6	2.00	15.58	6	2.00	15.81	6	2.00	14.90	6	2.00	15.58	6	2.00	15.58	6	2.00	13.92
JP8			50/50 S8/JP8														
S/C	Process Fuel Flow Rate [g/min]	Water Flow Rate [g/min]	S/C	Process Fuel Flow Rate [g/min]	Water Flow Rate [g/min]												
4	4.30	22.30	4	4.30	22.30												
4	4.30	22.30	4	4.30	22.30												
4	4.30	22.30	4	4.30	22.30												
4	4.30	22.30	4	4.30	22.30												
5	4.30	27.90	5	4.30	27.90												
5	4.30	27.90	5	4.30	27.90												
5	4.30	27.90	5	4.30	27.90												
5	4.30	27.90	5	4.30	27.90												
6	4.30	33.50	6	4.30	33.50												
6	4.30	33.50	6	4.30	33.50												
6	4.30	33.50	6	4.30	33.50												
6	4.30	33.50	6	4.30	33.50												

Measuring the flow from the process pumps McMillan Flow 100 sensors with a 0-100mL/min range and maximum full scale error of  $\pm 3.0\%$  were used. These flow meters can tolerate a maximum line pressure of 500psi. Inline 15-micron size sintered metal T-Type filters, Swagelok SS-2TF-15, were installed in all fluid lines to protect the pumps and flow meters. The pressure of the process JP-8 and water line is monitored by 0-200psi Omega Model PX181-200GSV pressure transducers with  $\pm 0.3\%$  full scale accuracy. The air needed for the JP-8 combustion in the burners is provided by Ametek Rotron Mini Jammer BLDC low-voltage blowers, Ametek 150016-02 – 24VDC, 2.5A, 34CFM, with an absolute error of  $< 0.1\%$ . These blowers can deliver 300 lpm of air at approximately 10.5in-H<sub>2</sub>O. This is enough air to burn over 20 g/min of JP-8 providing room for system expansion and the possibility of increasing the system output. The temperature of the different streams were measured using type K Quick Disconnect Thermocouple Probes, Omega Model #: KMQXL-062G-12, with an accuracy of  $\pm 2.2^\circ\text{C}$  for temperatures up to  $293^\circ\text{C}$  and  $\pm 0.75\%$  of the measured temperature for temperatures exceeding  $293^\circ\text{C}$ .

#### 4.1. Test Procedure

Fractionation was not used during test runs. Reforming of the entire fuel fractions was more essential for comparison purposes than reducing sulfur content, since S8 and biodiesel have no sulfur. To measure the performance of the fuel processor, fuel and water flow rates, pressures and temperatures of different streams, and test duration were acquired using LabView data acquisition. Gas samples of the reformat stream were analyzed using a gas chromatograph (GC), Agilent Technologies 6890N. The Gas Chromatograph was calibrated to measure molar percent of H<sub>2</sub>, CO, CO<sub>2</sub>, C<sub>2</sub>H<sub>2</sub>, C<sub>2</sub>H<sub>4</sub>, C<sub>2</sub>H<sub>6</sub>, C<sub>3</sub>H<sub>6</sub>, and C<sub>3</sub>H<sub>8</sub> in the reformat stream. Measured properties are listed in Appendix E.

The procedures for start up and test runs are listed in Appendix D. Although the burners were designed to use any fuel, propane was used in the burners for all tests.

#### 4.2. Test Results and Discussion

Carbon deposition takes place where polymerization, thermal decomposition and other reactions occur, leading to blockage of catalyst pores and in extreme cases complete failure of the reactor. This occurs when favorable combination of low S/C and temperature exist at reaction sites. To study the range of temperatures and S/C ratios that impact carbon deposition, the steam reforming system was studied graphically using the Carbon-Hydrogen-Oxygen (CHO) equilibrium phase diagram, Figure 10.

The CHO phase diagram was generated by calculating equilibrium mass fractions resulted from the equilibrium conversion of JP8 to graphite, C(gr), using NASA CEA Code [2]. Figure 10 shows the coke formation boundaries (solid colored lines) for the JP8 steam reforming system at 1 atmosphere pressure and temperatures from 300 to  $900^\circ\text{C}$ . The region above each temperature line is where coke formation is thermodynamically favored; below the line, coke will not form and carbon is only present as CO, CO<sub>2</sub>, and CH<sub>4</sub>. JP8/H<sub>2</sub>O mixtures occur along the JP8 steam reforming line, the dotted line connecting JP8 presentation on C-H axis to H<sub>2</sub>O presentation on the H-O axis. Green solid circles on this line indicate S/C ratios from 1 to 5. For S/C=1 coking is favored at all temperatures. For S/C = 5 coking is not possible at any

temperature. For  $S/C > 3$  and  $T > 300^\circ\text{C}$ , coke will not form. However, the actual  $S/C$  at the reactor inlet is not necessarily the same as the targeted feed  $S/C$ . Pump fluctuations, incomplete mixing, etc., can expose the catalyst to a transiently low  $S/C$ . Since coke formation is rapid, and coke decomposition is slow, each transient low  $S/C$  event will cause coke accumulation. To completely prevent coking, it is essential to stay out of the coke-forming regions at all times, not just on average over time. To achieve this, the target feed  $S/C$  ratio should be higher than 3. In this effort, the fuel processor was operated with 4, 5, and 6 steam to carbon ratio for steam reformer outlet temperature range of  $450\text{--}800^\circ\text{C}$ .

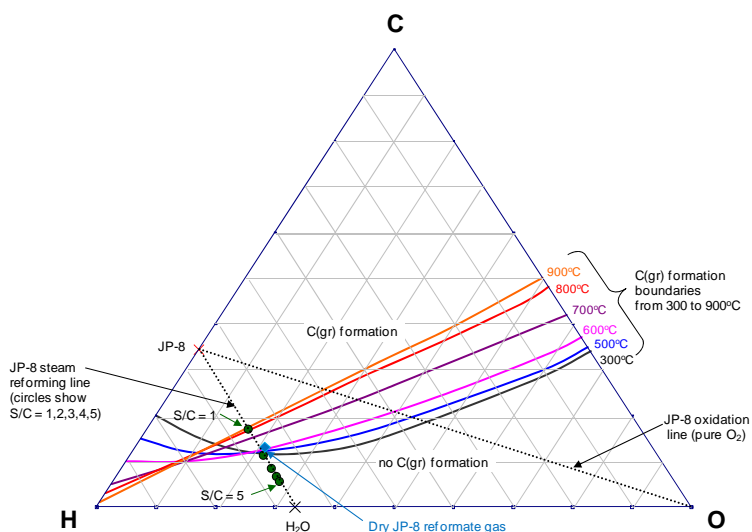

**Figure 10:** Thermodynamics of Carbon Formation in JP8 Reforming at 1 atm

A summary of the test results are listed in Appendix E while the calculation procedure is detailed in Appendix C.

**4.2.1 Reaction Selectivity:** Hydrogen, carbon monoxide, and methane selectivities are shown in Figures 11–28. Figures 11–13 for JP8, Figures 14–16 for diesel, Figures 17–19 for S8, Figures 20–22 for 50/50 mix of JP8 and S8, Figures 23–25 for propane, and Figures 26–28 for biodiesel. In all of these test runs, the steam reformer’s operating temperature and steam to carbon ratio impact the  $\text{H}_2$ ,  $\text{CO}$ , and methane content in the reformate stream. As the temperature of the reformate stream at the exit of the steam reformer increase,  $\text{H}_2$  selectivity increases while the selectivity for both  $\text{CO}$  and methane decreases. The  $S/C$  has the same effect. The lower selectivity for  $\text{CO}$  and  $\text{CH}_4$  is due to excess water in the last section of the reactor. Water-gas-shift reaction occurs and water,  $\text{CO}$  and  $\text{CH}_4$  are converted to hydrogen and  $\text{CO}_2$ . No hydrocarbons higher than methane were detected. One shall keep in mind that at the  $2\text{g}/\text{min}$  flow rate, the steam-fuel mixtures have about twice the residence reaction time as the  $4.3\text{g}/\text{min}$  flow.

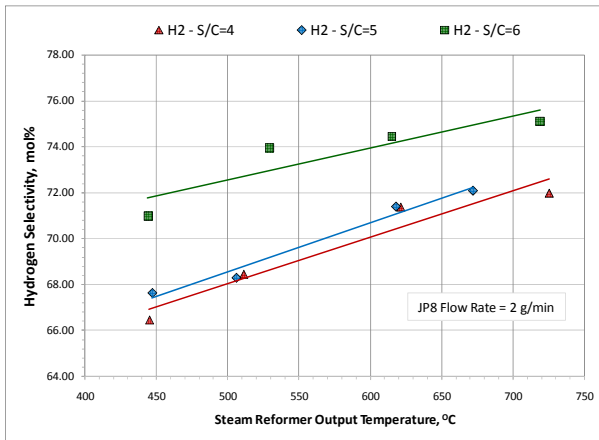

**Figure 11:** H<sub>2</sub> Selectivity as a Function of JP8 Reformate Temperature and S/C.

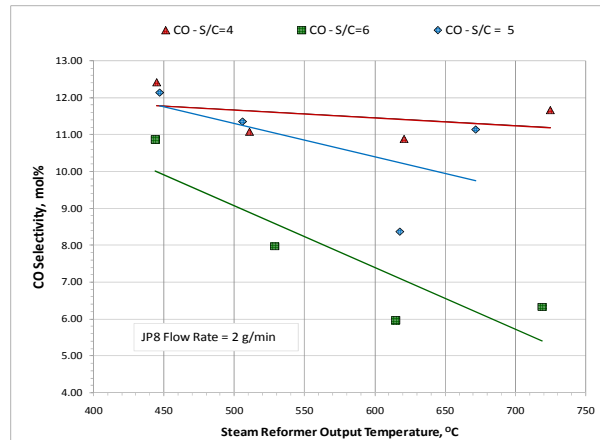

**Figure 12:** CO Selectivity as a Function of JP8 Reformate Temperature and S/C.

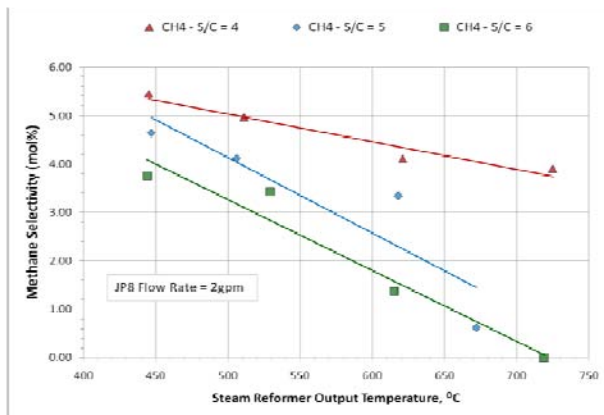

**Figure 13:** CH<sub>4</sub> Selectivity as a Function of JP8 Reformate Temperature and S/C.

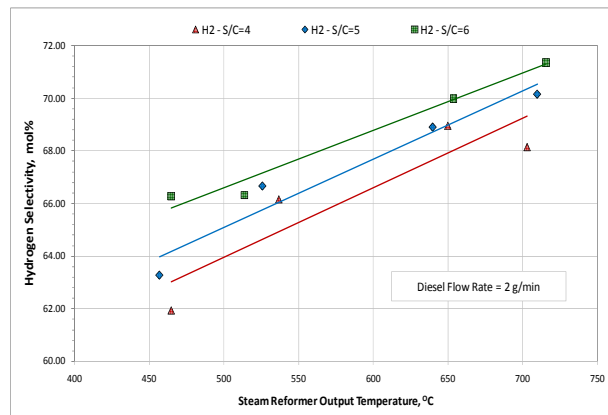

**Figure 14:** H<sub>2</sub> Selectivity as a Function of Diesel Reformate Temperature and S/C.

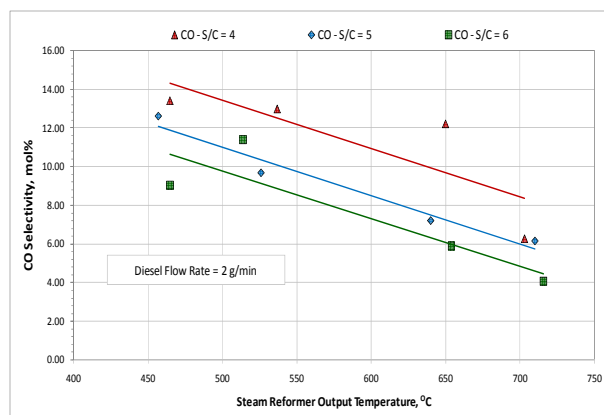

**Figure 15:** CO Selectivity as a Function of Diesel Reformate Temperature and S/C.

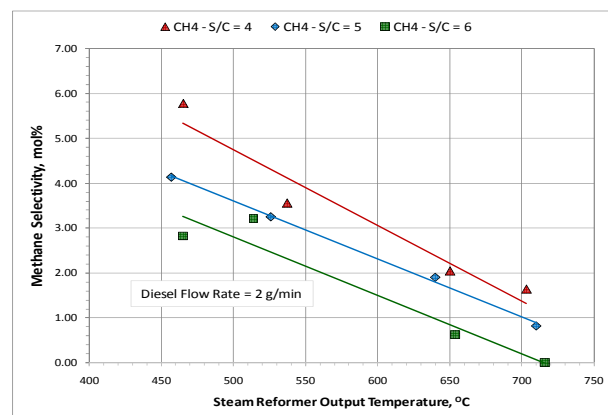

**Figure 16:** CH<sub>4</sub> Selectivity as a Function of Diesel Reformate Temperature and S/C.

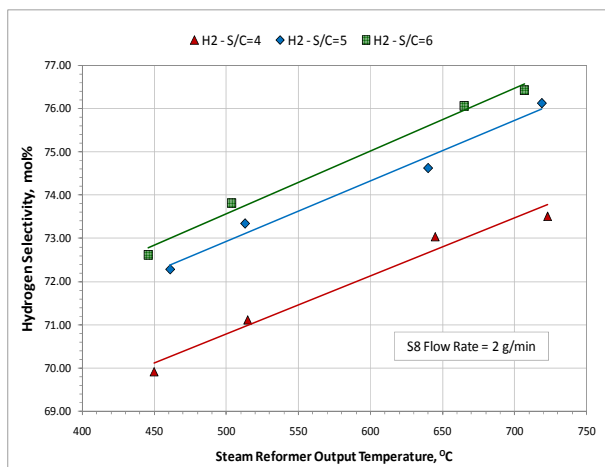

**Figure 17:** H<sub>2</sub> Selectivity as a Function of S8 Reformate Temperature and S/C.

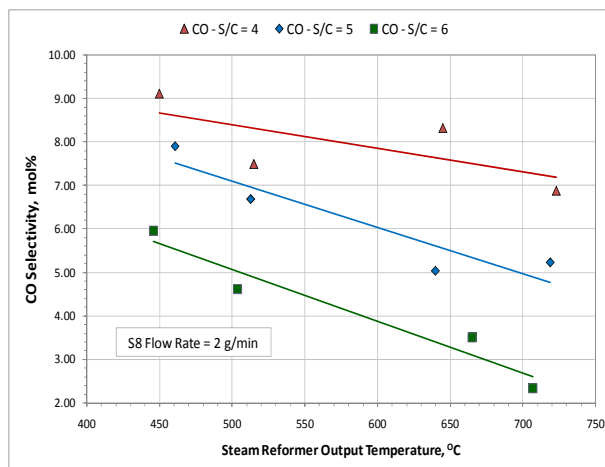

**Figure 18:** CO Selectivity as a Function of S8 Reformate Temperature and S/C.

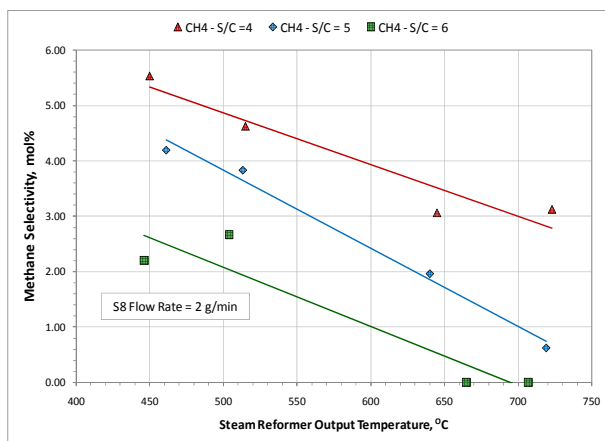

**Figure 19:** CH<sub>4</sub> Selectivity as a Function of S8 Reformate Temperature and S/C.

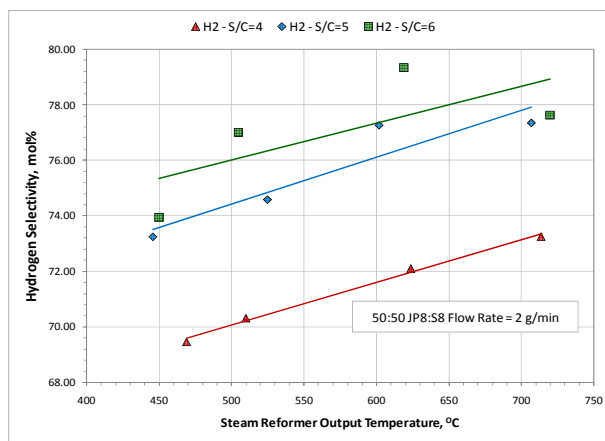

**Figure 20:** H<sub>2</sub> Selectivity as a Function of 50/50 mix Reformate Temperature and S/C.

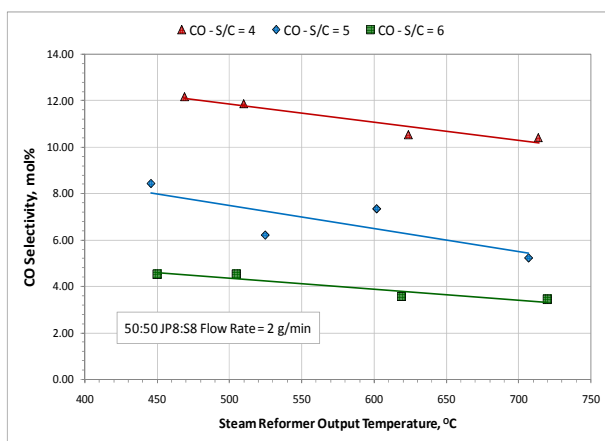

**Figure 21:** CO Selectivity as a Function of 50/50 mix Reformate Temperature and S/C.

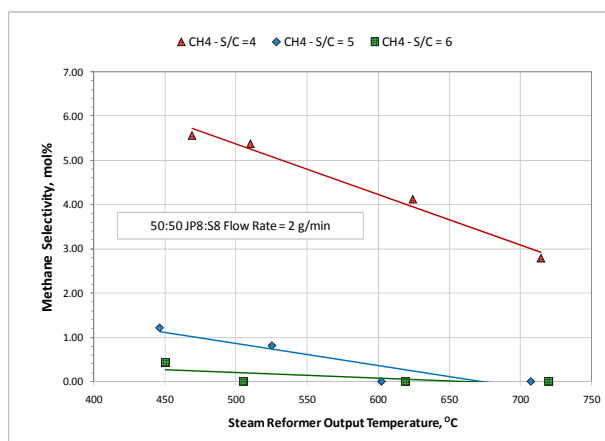

**Figure 22:** CH<sub>4</sub> Selectivity as a Function of 50/50 mix Reformate Temperature and S/C.

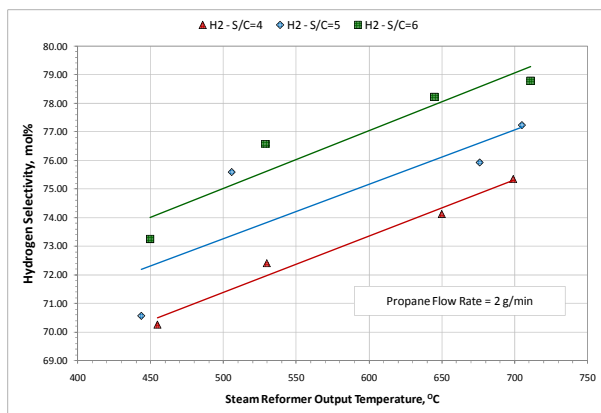

**Figure 23:** H<sub>2</sub> Selectivity as a Function of Propane Reformate Temperature and S/C.

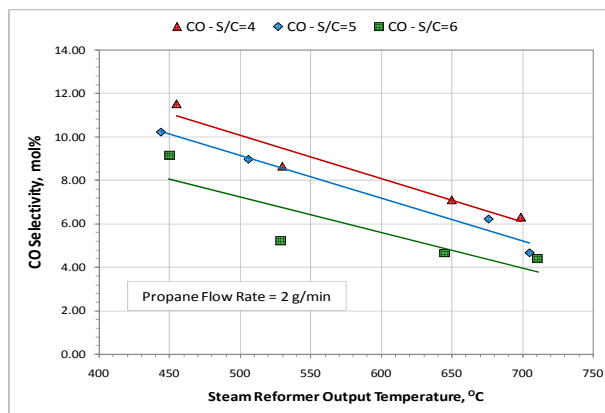

**Figure 24:** CO Selectivity as a Function of Propane Reformate Temperature and S/C.

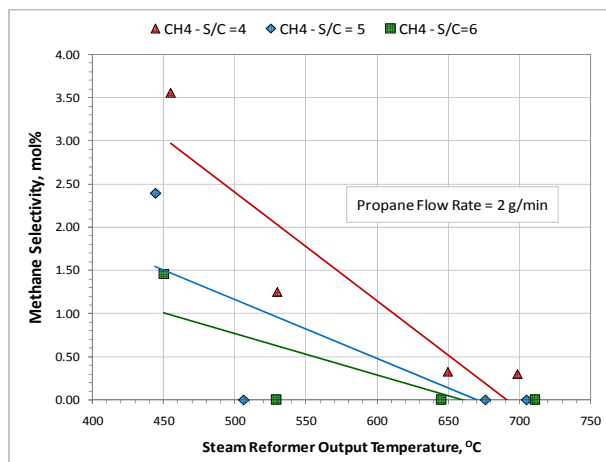

**Figure 25:** CH<sub>4</sub> Selectivity as a Function of Propane Reformate Temperature and S/C.

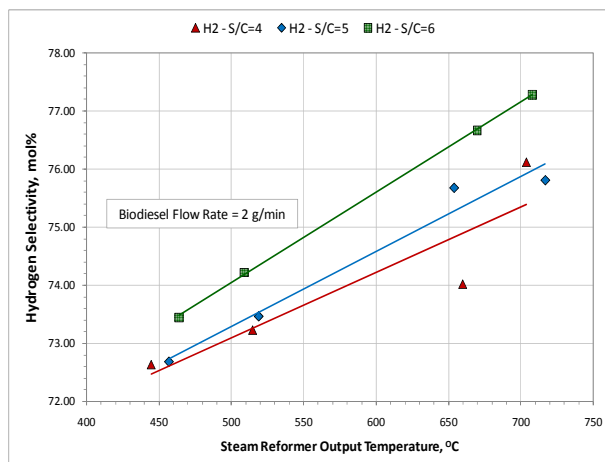

**Figure 26:** H<sub>2</sub> Selectivity as a Function of Biodiesel Reformate Temperature and S/C.

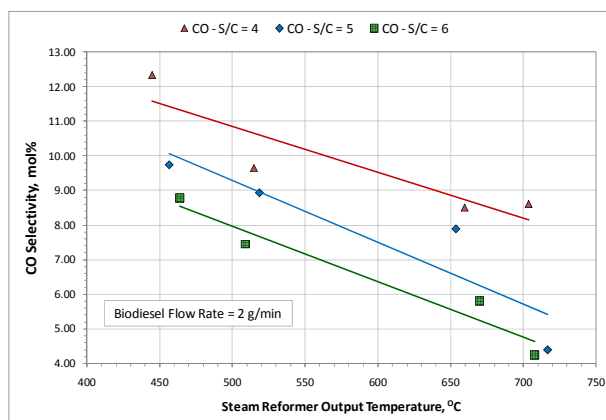

**Figure 27:** CO Selectivity as a Function of Biodiesel Reformate Temperature and S/C.

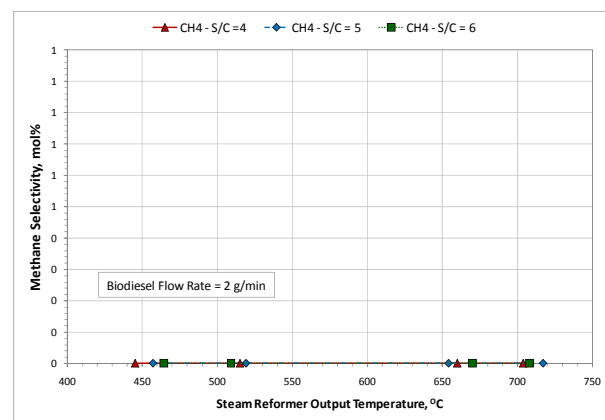

**Figure 28:** CH<sub>4</sub> Selectivity as a Function of Biodiesel Reformate Temperature and S/C.

For JP8 and diesel, methane selectivity reached zero at temperatures higher than 700°C and S/C of 6; for propane above 650°C for S/C of 5 and above 520°C for S/C of 6, for S8 no methane was detected above 650°C for S/C of 6; for the 50/50 mix no methane above 600°C for S/C of 5 and above 500°C for S/C of 6, while for biodiesel no methane was detected at all temperatures and S/C ratios tested. CO selectivities are low reaching below 10 mol% and some cases below 5 mol%. These results are important for applications using the direct steam reforming to produce hydrogen for high temperature PEM fuel cells.

Zhenq *et al* [3] used a supported Rhodium (Rh) catalyst (Rh/CeO<sub>2</sub>-Al<sub>2</sub>O<sub>3</sub>) in steam reforming of a simulated jet fuel at S/C=3 and temperature of 514°C. The simulated jet fuel consists of a blend of 80 wt% dodecane (n-C<sub>12</sub>H<sub>26</sub>) and 20 wt% aromatic compounds. Strohm *et al* [4], using 2% Rh–10% Ni supported on CeO<sub>2</sub>-modified Al<sub>2</sub>O<sub>3</sub> catalyst to reform desulfurized JP8 at S/C=3 and temperature of 515°C. Current study at S/C of 4 and 511°C show higher H<sub>2</sub> and lower CO and CH<sub>4</sub> content than the both Zhenq *et al* and Strohm *et al*, Table 2. The higher S/C in current study and higher reactor capacity for the 2 g/min fuel flow rate resulted in the higher hydrogen and lower CO and methane contents.

**TABLE 2: JP8 Reforming Data Comparison**

	H <sub>2</sub>	CO	CO <sub>2</sub>	CH <sub>4</sub>
	[mol%]	[mol%]	[mol%]	[mol%]
Zhenq, <i>et al</i> , 2008, [3]	60.5	5.5	20.0	14.0
Strohm <i>et al</i> 2006, [4]	61.0	3.0	23.0	13.0
Current Study	68.5	11.0	15.5	5.0

Laosiripojana *et al* [5], studied catalytic steam reforming of propane over CeO<sub>2</sub>-doped Ni/Al<sub>2</sub>O<sub>3</sub> at high temperatures, 700-900°C. Their results show maximum hydrogen content of 80 mol% at 900°C using 14% Ce-Ni at C<sub>2</sub>H<sub>6</sub>/C<sub>3</sub>H<sub>8</sub>/H<sub>2</sub>O molar ratio of 0.65/0.35/3.0. The extrapolation of current data in Figure 23, show 80 mol% hydrogen content can be achieved at 900°C and S/C ration of 4-5. In their investigation, hydrogen content dropped drastically with reduction in operating temperatures. The hydrogen content for 800°C dropped to 60 mol%, and for 700°C dropped to 40 mol%.

Limited efforts were reported on the reforming of biodiesel. Irving *et al* [6] studied steam reforming of biodiesel using their proprietary catalyst. Their results show complete conversion of biodiesel was achieved at temperatures above 740°C with selectivities: 65 mol% hydrogen, 15 mol% CO<sub>2</sub>, and 20 mol% CO with no CH<sub>4</sub> at S/C of 3 to 4. Current effort show complete conversion above 450°C and S/C of 4 with selectivities: minimum 72.6 mol% hydrogen, minimum 15.02 mol% CO<sub>2</sub>, maximum 12.35 mol% CO, and 0 mol% CH<sub>4</sub>. The apparent difference between the two investigations is the catalyst; however, the larger capacity of the packed-bed over that of microchannel reactor might have contributed to the difference in the two results.

The hydrogen generation mass flow rate, in g/min, was calculated for all test runs to facilitate quantitative comparison of the performance of the developed fuel processor. Figure 29 shows hydrogen generation rate as a function of steam reformer exit temperature and fuel type for the 2g/min fuel input to the steam reformer and S/C of 4.



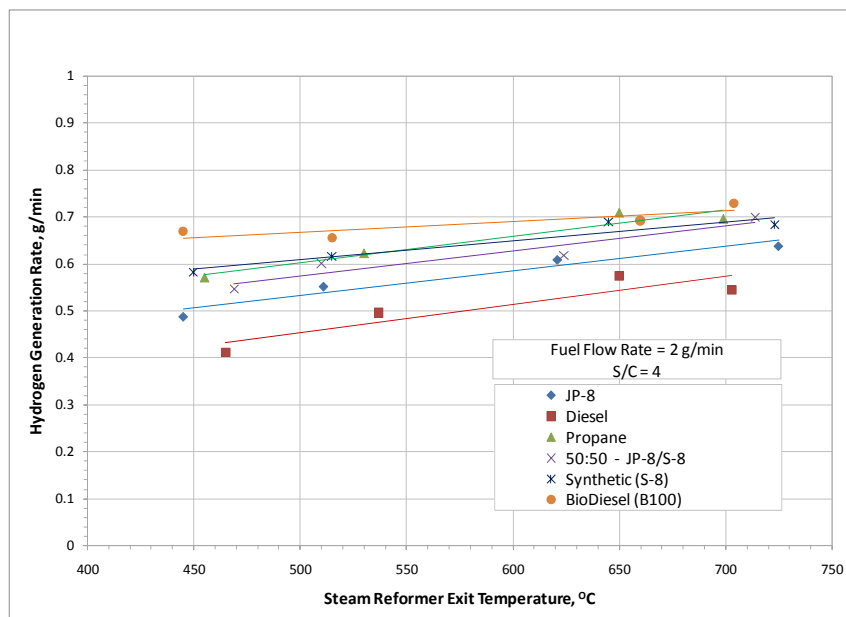

**Figure 29:** Hydrogen Generation Rate In Reformate Streams

Figure 30 displays the amount of hydrogen available in the tested fuels. Biodiesel contains the least amount of hydrogen per gram followed by diesel, then by the jet fuels group, while propane possesses the highest amount of hydrogen per gram. However, steam reforming of diesel seems to generate the least amount of hydrogen and biodiesel the highest, Figure 29. Biodiesel is the only oxygenated fuel ( $C_{20}H_{40}O_2$ ) among the six tested fuels. The high performance of biodiesel requires further investigation to determine whether the increase of oxygen concentration at reaction sites during fuel reforming impacts catalyst performance or whether it is due to other factors such as the C-Chain cluster structure.

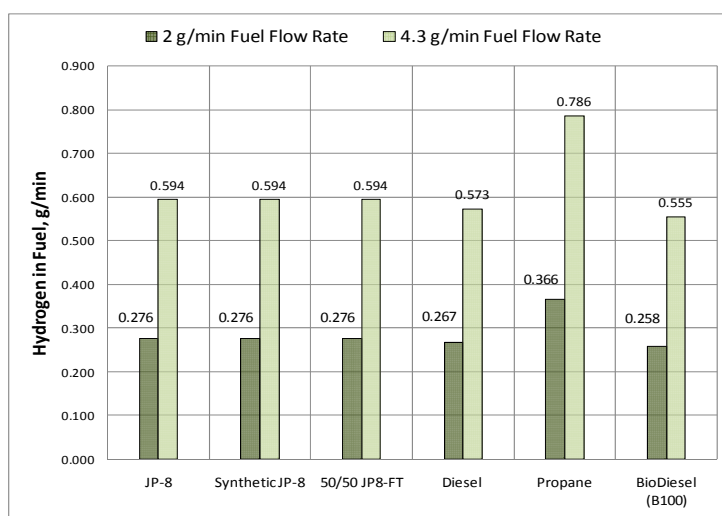

**Figure 30:** Hydrogen Available from Fuel for 2 and 4.3 g/min Fuel Flow Rates

**4.2.2 JP8 and Synthetic Fuel Mix:** Because of the importance of JP8 and the steps the Air Force is taking to replace it with a mixture of JP8 and S8, a comparison of the reforming of the two fuels was carried out. Figure 31 shows the system pressure, represented by water stream pressure, and reformates flow rates for both fuels are comparable. Figure 32 compares hydrogen selectivity for both fuels at fuel flow rate of 4.3 g/min and S/C of 4, 5, and 6. For the same operating temperature, hydrogen selectivity in the steam reforming of the 50/50 mix is higher than that of JP8. Also, Figure 29 shows the same behavior for the 2 g/min fuel input to the steam reformer. At the same operating temperature, JP8 steam reforming results in less hydrogen yield than the 50/50 mix and both yield less hydrogen than S8.

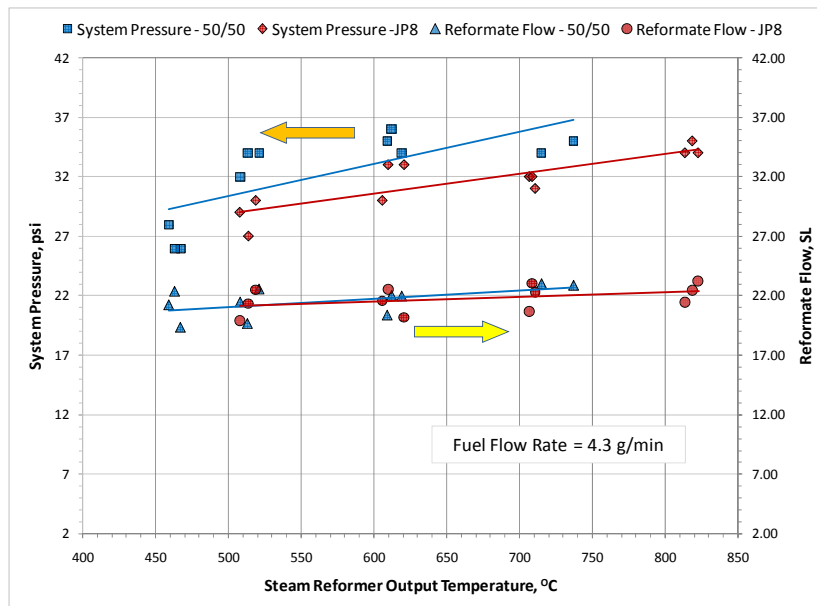

**Figure 31:** System Pressure and Reformate Flow for JP8 and 50/50 Mix.

There are differences between JP8 and S8. S8, also called Synthetic Paraffinic Kerosene (SPK), is comprised of molecules with carbon distribution between C8 and C19 and contains about 22 vol% paraffins, zero aromatics and zero sulfur, Moses [7, 8]. JP8 comprised of molecules with carbon distribution between C3 and C18 and contains about 71.4 vol% paraffins, up to 25 vol% aromatics, and up to 0.3 wt% sulfur, ASM MIL Specs [9, 10]. Since S8 is classified as a high-purity hydrocarbon in the kerosene boiling range, S8 will have the bulk physical properties with the same values and temperature sensitivities as the petroleum-derived fuels of the similar hydrocarbon composition; therefore, S8 would be more typical of a jet fuel but not exactly the same. Synthetic jet fuel has been certified for use in concentrations up to 50 vol% in blends with JP8 providing there are at least 8 vol% aromatics in the final blend, all of which must come from the petroleum-derived blending streams, Moses, [7].

Steam reforming of JP8 at lower temperatures resulted in aerosol that was difficult to condensate and contained high sulfur content. The aerosol formation was due to the aromatics content in the fuel. Higher temperatures or longer residence time were required to eliminate aerosol formation. Therefore, reducing aromatics is certain to improve steam reforming of the fuel.

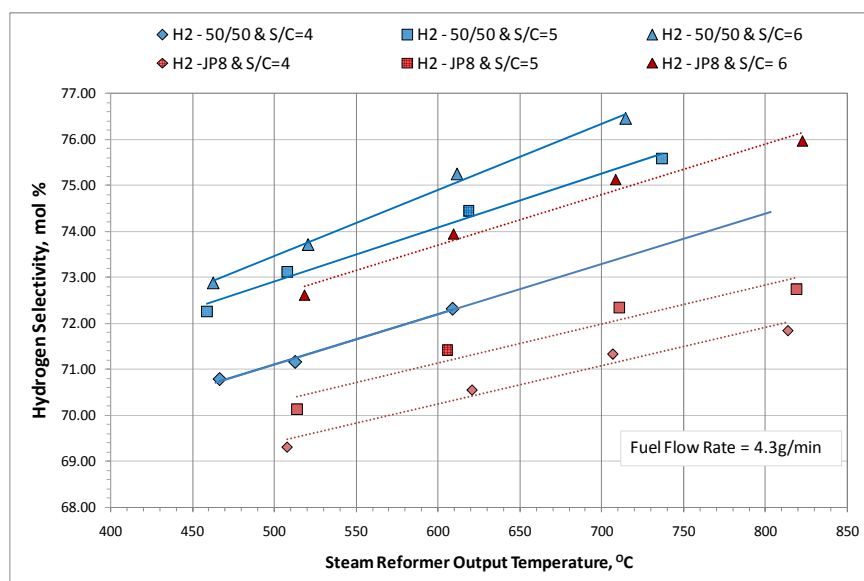

**Figure 32:** H<sub>2</sub> Selectivity Comparison for JP8 and 50/50 Mix.

Sulfur is a major detriment for catalyst performance even for those catalysts categorized as sulfur tolerant. The loss in performance is a function of sulfur concentration. For a sulfur tolerant catalyst, similar to the one used in this study, the loss in performance is minimal and reversible. The use of a fuel such as the 50/50 mix will certainly improve the performance of steam reforming catalyst and process.

To quantify performance penalty in the steam reforming of JP8 over the 50/50 mix, both the steam reformer and steam generator burners were operated on propane. The propane flow rate to each burner was measured, Appendix E, to provide the bases for the comparison. Figure 33 shows the relation between the thermal energy needed for reforming, represented by the burners' fuel flow rate; process product, represented by the reformat flow rate; and penalty in reforming JP8 represented by:

$$\text{Penalty (\%)} = 100[m_{\text{Burner}}^{\text{JP8}} - m_{\text{Burner}}^{50/50}] / m_{\text{Burner}}^{50/50}$$

Where  $m_{\text{Burners}}^{\text{JP8}}$  is the mass flow rate of fuel to both burners for reforming JP8 and  $m_{\text{Burner}}^{50/50}$  is for reforming the 50/50 mix. The results show reforming JP8 requires 10-15% higher energy input than reforming the 50/50 mix, Figure 33.

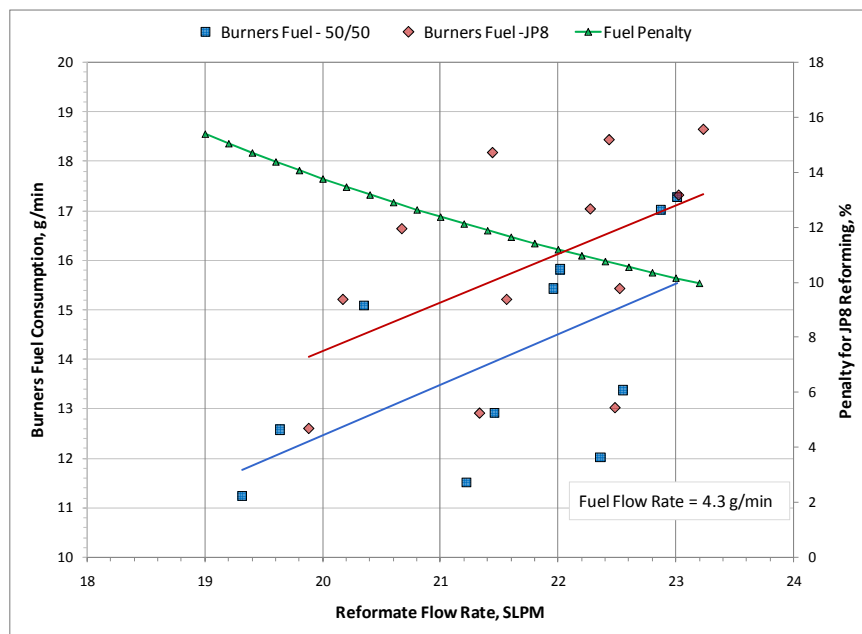

**Figure 33:** Performance Comparison Between JP8 and 50/50 Mix.

## 5. CONCLUSION

Processing hydrocarbons to produce hydrogen rich stream suitable for fuel cell use has been made possible with the use of a fractionation and direct steam reforming followed by zinc oxide beds to remove hydrogen sulfide. The direct steam reforming concept is capable of reforming multiple fuels. It has been successfully used to process JP8, S8, 50/50 mix of S8 and JP8, diesel, biodiesel, and propane. Different fuels can be used intermittently without system degradation or loss of capability. The fuel processor showed superior performance over other technologies that were developed for a specific fuel. Therefore, one can conclude that catalyst selection is a major factor in the success of the reforming process.

Synthetic fuels have no sulfur and zero aromatics making them more suitable for the fuel reforming process than their petroleum-based counterparts. Because of the absence of sulfur, fractionation, steam condensation, gas/liquid separation, and sulfur removal components can be eliminated. This results in a reduction in size, weight, and maintenance needs of deployed power generators. Using S8 or the 50/50 mix fuels will allow:

1. Fuel processor to operate at lower temperatures increasing process thermal efficiency and reducing life cycle cost.
2. Running the fuel processor without the use of fractionation. This has the potential to eliminate the fractionation component and reduce the size of the sulfur removal component by at least 50%.
3. Conversion with higher  $H_2$ , less  $CO$  and  $CO_2$ , and no higher hydrocarbons than methane. Methane and  $CO$  along with  $H_2$  are fuels for the Solid Oxide Fuel Cell (SOFC).

4. Saving on fuel input into burners for up to 15% for the 50/50 mix fuel and even higher for S8 over JP8 reforming.

Reforming biodiesel showed interesting results. Although biodiesel contains the least hydrogen per gram of fuel, it produced the highest hydrogen mass flow rate among the six fuels tested. Biodiesel is the only oxygenated fuel ( $C_{20}H_{40}O_2$ ) among the six tested fuels. The high performance of biodiesel requires further investigation to determine whether the increase of oxygen concentration at reaction sites during fuel reforming impacts catalyst performance or whether it is due to other factors such as the C-chain cluster structure.

Further testing is warranted to investigate the impact of long term operations using the current six and other fuels on catalyst performance and coking deposition.

## REFERENCES

- [1] Salavani, R., Shaaban, A.H., Campbell, T.J., Trotta, R. “*Logistic Fuel Processor Development For 1.5kw Fuel Cell Power Output,*” AFRL-ML-TY-TR-2006-4572.
- [2] NASA CEA (*Chemical Equilibrium with Applications*) <http://www.grc.nasa.gov/WWW/CEAWeb/>.
- [3] Zheng, J., Strohm, J.J., Song, C., “*Steam Reforming Of Liquid Hydrocarbon Fuels For Micro-Fuel Cells,*” *Fuel Processing Technology* 89, 2008, 440– 448.
- [4] Strohm, J.J., Zheng, J., Song, C., “*Low-Temperature Steam Reforming Of Jet Fuel In The Absence And Presence Of Sulfur Over Rh And Rh–Ni Catalysts For Fuel Cells,*” *Journal of Catalysis* 238, 2006, 309–320.
- [5] Laosiripojana, N., Sangtongkitcharoen, W., Assabumrungrat, S., “*Catalytic Steam Reforming Of Ethane And Propane Over CeO<sub>2</sub>-Doped Ni/Al<sub>2</sub>O<sub>3</sub> At SOFC Temperature: Improvement Of Resistance Toward Carbon Formation By The Redox Property Of Doping CeO<sub>2</sub>,*” *Fuel* 85, 2006, 323–332.
- [6] Irving, P.M. and Pickles, J.S., “*Hydrogen Production From Bio-Diesel Fuel In a Microchannel Steam Reformer,*” *Proceedings of the National Hydrogen Association, AHC, March 12-16, 2006, Long Beach, CA.*
- [7] Moses, C. A. “*Development Of The Protocol For Acceptance Of Synthetic Fuels Under Commercial Specification,*” CRC Report AV-2-04, September 2007. Available at <http://www.crcao.com/publications/aviation/index.html>.
- [8] Moses, C. A. “*Comparative Evaluation Of Semi-Synthetic Jet Fuels,*” CRC Report AV-2-04a, September 2008. <http://www.crcao.com/publications/aviation/index.html>.
- [9] MIL-DTL-83133A, *Turbine Fuel, Aviation, Kerosene Type, JP-8 (NATO F-34), NATO F-35, and JP-8+100 (NATO F-37).* 4 April, 1980.
- [10] MIL-DTL-83133F, *Turbine Fuel, Aviation, Kerosene Type, JP-8 (NATO F-34), NATO F-35, and JP-8+100 (NATO F-37),* 11 April, 2008.

## APPENDIX A: Definition of the Fuel Processor Components and Flow Streams

The process flow and components diagram is shown in Figure A-1. The components description is as follow:

**Partial Evaporator (Fractionator)** – A continuous fractionation column that separates the fuel feed into vapor and bottom liquid fractions. Sulfur, in the middle distillate fuels such as diesel, Jet-A, JP-8, and kerosene, is distributed predominantly in the higher end of the fuel's boiling range. These fuels can also contain nonvolatile hydrocarbons such as asphaltenes, and organo-metal compounds. The bottoms' stream from the partial evaporator is riched in sulfur, organic nonvolatiles, and metals relative to the feed, while the vapor stream is enriched in lower-boiling hydrocarbons and is depleted of contaminants that could poison or deactivate downstream components. The ratio of vapor to bottom liquid depends on the temperature and the system operating pressure, while the separation efficiency depends on the evaporator design.

**Desulfurizer** – A flow-through gas-solid or gas-liquid process which removes H<sub>2</sub>S from the reformat stream which may use adsorbents such as ZnO or the commercial preparations thereof, other commercially available H<sub>2</sub>S adsorbents, a continuously regenerative solid, liquid-phase H<sub>2</sub>S adsorbent or an absorbent.

**Steam Generator** – A heat exchanger (boiler) designed for efficient vaporization and superheating of feed H<sub>2</sub>O.

**Steam Reformer** – A catalytic reactor designed to produce H<sub>2</sub>, CO, and CO<sub>2</sub> from light hydrocarbons and steam at a high conversion rate, while selectively separating the H<sub>2</sub> product from the byproducts. Rejected stream from the reformer can contain H<sub>2</sub>, CO, CO<sub>2</sub>, and noncreative H<sub>2</sub>O and hydrocarbons. All or a portion of the reject stream can be combusted in the burner.

**Burner** – A system in which fuel partial evaporator bottoms and reject gas from reformer are mixed with air and combusted to provide heat for evaporator, pre-reactor, steam generator, and reformer operations. The system may include one or more combustors designed for efficient heat transfer to components. The overall efficiency of the fuel processor system is maximized when the temperatures of the system are controlled so that the quantities of evaporator bottoms and reject gas from reformer are exactly sufficient to supply the heat requirements for all of the endothermic operations and heat losses.

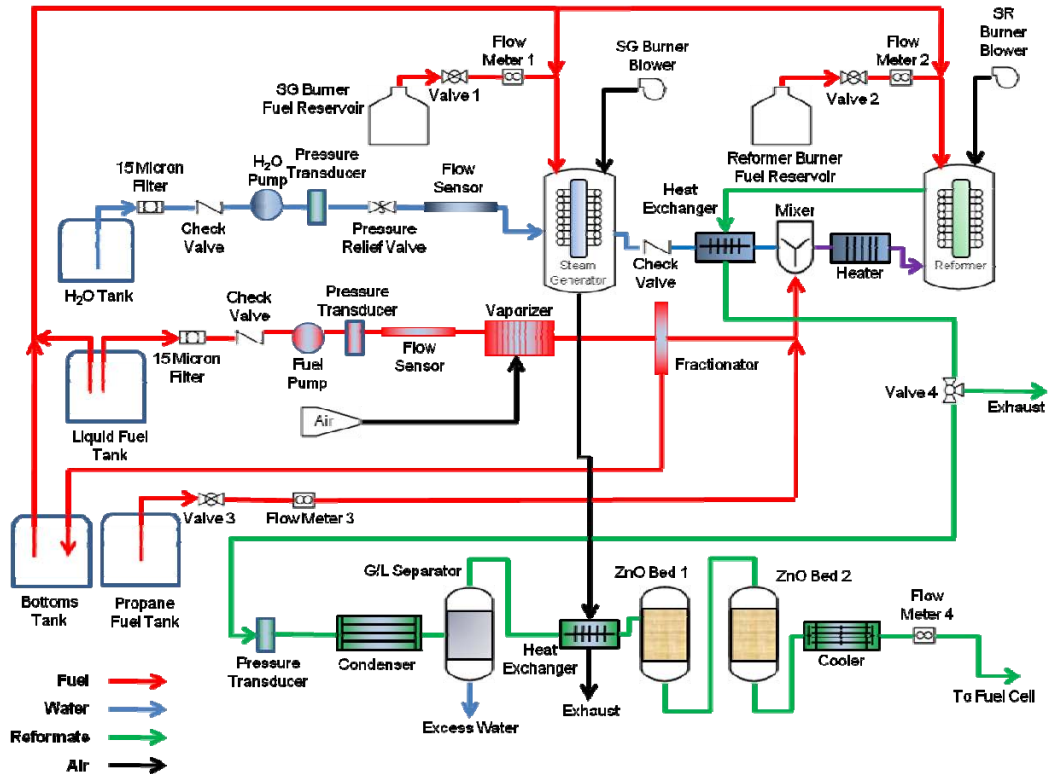

Figure A-1: Process's Flow Diagram



## APPENDIX B: Transestrification Biodiesel Process

### Reaction Raw Materials:

1. Waste Vegetable Oil (WVO)
2. Methanol (CH<sub>3</sub>OH) 99%+ pure
3. Potassium hydroxide (must be dry)

### Materials for Titration:

1. Isopropyl alcohol 99%+ pure
2. Distilled water
3. Phenolphthalein solution

### Materials for Washing:

1. Vinegar
2. Water

### Manufacturing Process

1. **Filtering:** Maintain oil temperature at 35-40°C and filter the oil to remove solid particles.
2. **Water Removal:** Drain bottom water, heat and maintain oil temperature at 100°C until the rest of the water boils off.
3. **Basic titration:** Dissolve 1 gram of KOH in 1 liter of distilled or de-ionized water (0.1% KOH solution). In a smaller beaker, dissolve 1 ml of dewatered oil in 10 ml of pure isopropyl alcohol. Warm the beaker on a hot plate, stir until all of the oil dissolves in the alcohol and the mixture turns clear. Add 2 drops of phenolphthalein solution. Using a burette, add 0.1% KOH solution drop by drop to the oil alcohol phenolphthalein solution while stirring, until the solution stays pink (magenta) for 10 seconds. Take the number of mls of 0.1% KOH solution used and add 5.0. This is the number of grams of KOH needed per liter of oil.
4. **Test batches:** Try the calculated KOH amounts on a 1 liter batch. Heat the oil just enough so it will spin well. Start by mixing up the exact quantity of KOH and 200 ml of methanol. Vessels used must be dry. Keep mixing until all the KOH has been dissolved. Once the potassium methoxide is prepared, add to 1 liter of oil while agitating. Ensure weights and volumes are precise. If unsure of the titration result then use 5.0 grams of KOH per liter of oil. Smaller batches need only 15 to 20 minutes of mixing to complete separation. The settling takes some time to complete. The solution can be poured from the vessel into a separatory funnel right after switching off the agitator. A few batches should be made with varying amounts of KOH recorded. Too much KOH will create an unwanted gel. When not enough KOH is used the reaction does not go far enough and some unreacted oil will be mixed with the biodiesel and glycerine. This will form three levels with biodiesel on top above unreacted oil with glycerine on the bottom. If there is too much water in the oil it will form soaps and settle right above the glycerine forming a fourth level in the container. This layer is not too easy to separate from the unreacted oil and glycerine layers.

5. **Preparing the potassium methoxide:** Generally the amount of methanol needed is 20% of the WVO by volume. When transesterifying 100 liters of WVO oil, use 20 liters of methanol. The methanol is mixed into a solution with the KOH, creating potassium methoxide in an exothermic reaction (it gets warm from bonds forming). Keep all utensils as dry as possible.

*CAUTION:* Treat potassium methoxide with extreme caution! Do not inhale any vapors! Potassium methoxide will burn the skin without feeling it (killing the nerves). Wash immediately with lots of water. Always have a hose running when working with potassium methoxide. Potassium methoxide is also very corrosive to paints. KOH reacts with aluminum, tin and zinc.

6. **Heating and mixing:** Pre-heat WVO 60–70°C. A full speed propeller coupled to an electric motor works fine as a mixer, there should be a vortex just appearing on the surface. Adjust the speed, or the pitch or size of the stirrer to get the right effect. Alternately an electric pump plumbed to form a mixing loop for stirring the oil will be sufficient. Add the potassium methoxide to the oil while stirring. Stir the mixture for 50 minutes to one hour. The reaction is often complete in 30 minutes, but longer is better. The transesterification process separates the methyl esters from the glycerin.
7. **Settling and separation:** Allow the solution to settle and cool for at least eight hours, preferably longer. The methyl esters (biodiesel) will be floating on top while the denser glycerin will be on the bottom of the container. Then carefully decant the biodiesel. This can be done by draining the reactants out of the bottom of the container through a transparent hose. The semi-liquid glycerine has a dark brown color and the biodiesel is honey-colored. Keep a watch on what flows through the sight tube. When the lighter-colored biodiesel appears divert it to a separate container. If any biodiesel stays with the glycerine it is easy to retrieve it later once the glycerine has solidified.
8. **Glycerin:** The glycerin side stream typically contains a mixture of glycerin, methanol, water, inorganic salts (catalyst residue), free fatty acids, unreacted mono-, di-, and triglycerides, methyl esters, and a variety of other matter organic non-glycerol (MONG) in varying quantities. The glycerine from oil is brown and usually turns to a solid below about 38°C. Glycerine from fresh oil often stays a liquid at lower temperatures. Reclaimed glycerine is composted after being vented for three weeks to allow residual methanol to evaporate off or after heating it to 66°C to boil off any methanol content (the boiling point of methanol is 64.7°C). The excess methanol can be recovered for re-use when boiled off through a condenser. Another way of disposing of the glycerine, though a great bit more complicated, would be to separate its components, mostly methanol, pure glycerine (a valuable product for medicines, tinctures, hand lotions, dried plant arrangements and many other uses) and wax. This is often accomplished by distilling it, but glycerine has a high boiling point even under high vacuum so this method is difficult. Other idea for disposing of the glycerine is breaking it down to usable methane gas, with a Bio Gas methane digester.

9. **Soap residue:** Suspended in the biodiesel will also be some soapy residues. These are the result of  $K^+$  ions from the KOH reacting with water created when the methanol bonds with the ester chains along with any other water that was suspended in the oil. If the reaction produces more than the usual amount of soap, this happens when KOH comes into contact with water before it has a chance to react with the oil. In this case the excess water should have been boiled off first. The part of the process where it is vital to keep all water out of the reaction is when making the potassium methoxide. Keep the vessels that the KOH comes in contact with as dry as possible.
10. **Washing and drying:** The biodiesel from this stage can be used in the fuel tanks of vehicles. It is better to let it settle for a while (about 2 days), allowing the majority of the soap residues to settle before running the biodiesel through a filtration system then into the vehicle fuel tank. Another method is to wash the soaps out of the fuel with water, one or more times. When washing biodiesel the first time it is best to add a small amount of vinegar before adding the water. The acetic acid or vinegar brings the pH of the solution closer to neutral, which will help drop out any KOH suspended in the biodiesel. A simple way of washing is using a plastic coned bottom tank. Add water so that the result is 1/3 water and 2/3 biodiesel, the water will be at the bottom. Gently dribble the water, don't spray it hard from a hose under high pressure. Place an aquarium bubble stone into the tank making sure that it is submerged to the bottom of the water. A small aquarium air pump mounted to the outside of the tank can be used to supply air to the bubble stone. The air will bubble through the water taking tiny amounts of water to the surface. When the bubble bursts at the surface it drops the water back through the biodiesel picking up soaps and contaminants on the way down. The first wash should last about 6 hours. This process might have to be repeated two or three times to remove close to 100% of soaps. The second and third washings can be done with water alone and for a longer period of time. The finished product should have a pH of 7, checked with litmus paper or with a digital pH tester. The water from the third wash can be used for the first or second washes for the next batch. The impurities can be left in the re-heater for the next batch and removed when it accumulates. Transesterified and washed biodiesel will become clearer over time as any remaining soaps drop out of the solution. To dry the biodiesel, repeat step 2.

## APPENDIX C: Multi-Fuel Processor Performance Calculation Procedure

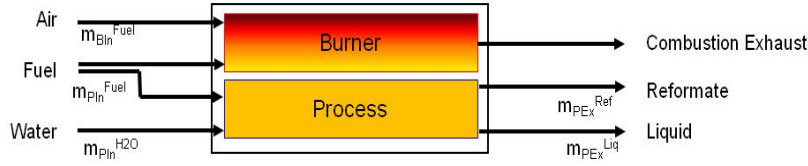

### Measured Quantities:

- $\Delta t$  = Duration (minutes) of steady-state test.
- $m_{BIn\ SG}^{Fuel}$  = Mass (grams) of fuel fed to Steam Generator burner during test duration  $\Delta t$ .
- $m_{BIn\ SR}^{Fuel}$  = Mass (grams) of fuel fed to Steam Reformer burner during test duration  $\Delta t$ .
- $m_{PIn}^{Fuel}$  = Mass (grams) of fuel fed to reformer process during test duration  $\Delta t$ .
- $V_{PEX}^{Ref}$  = Volume (standard liters) of reformat gas from reformer process during test duration  $\Delta t$ .
- $m_{PEX}^{Liq}$  = Mass (grams) of total liquids exiting from reformer process during test duration  $\Delta t$ .
- $y^i$  = Mole fractions of species ( $H_2$ ,  $CO$ ,  $CO_2$ ,  $CH_4$ , etc) in reformat gas, determined by GC-TCD.
- $T_{In}^{SGen}$  = Steam generator inlet temperature ( $^{\circ}C$ ).
- $T_{Ex}^{SGen}$  = Steam generator exit temperature ( $^{\circ}C$ ).
- $P_{PIn}^{H_2O}$  = Pressure of water fed to reformer process during test

### Constants:

- $V_{Std}$  = 24.45 L/mol =  $RT_{Std} / P_{Std}$  for  $T_{Std} = 25C = 298K$ ,  $P_{Std} = 1\ atm$ , and  $R = 0.08206\ (L\cdot atm)/(mol\cdot K)$ .
- $FW^i$  = Formula weight (gram/mole) of species  $i$ . For example,  $FW^{H_2} = 2.02\ gram/mole$ .
- $H_{comb}^i$  = Standard combustion enthalpy (kJ/mole) of species  $i$ . For example,  $H_c^{H_2} = 241.8\ kJ/mole$ .
- $N^{C,Fuel}$  = Carbon number of fuel. For example,  $N^{C,EtOH} = 2$ , and  $N^{C,JP-8} = 11$ .
- $LHV^{Fuel}$  = Lower heating value (kJ/gram) of fuel. For example,  $LHV^{JP8} = 43.2\ kJ/gram$  (typical).
- $h^{H_2O}(T,P)$  = Specific enthalpy (J/g) of steam at specified  $T$  and  $P$ , from steam tables.
- $\epsilon^{SOFC}$  = SOFC thermal-to-electric conversion factor (estimated at 40%).

### Calculated Quantities:

1. Reformate formula weight:

$$FW^{Ref} = \sum y^i FW^i$$

2. Reformate mass:

$$m_{PEX}^{Ref} = V_{PEX}^{Ref} FW^{Ref} / V_{Std}$$

3. Process mass balance:

$$m_{PIn}^{Fuel} + m_{PIn}^{H_2O} = m_{PEX}^{Ref} + m_{PEX}^{Liq}$$

The process mass balance can be used to verify the steady-state assumption by calculating mass recovery ( $m_{Rec}$ ):

$$m_{Rec} = [m_{PEX}^{Ref} + m_{PEX}^{Liq}] / [m_{PIn}^{Fuel} + m_{PIn}^{H_2O}]$$

$m_{Rec}$  should ideally equal 1; if it deviates too far from 1, the run was not at steady-state and the test should be repeated.

4. Fuel Conversion ( $X^{Fuel}$ ):

If the fuel is completely converted, all moles of carbon in the fuel feed ( $n_{PIn}^{C,Fuel}$ ) will be recovered as moles of one-carbon species in the reformat ( $n_{PEX}^{C,Ref}$ ):

$$\begin{aligned} n_{PEX}^{C,Ref} &= X^{Fuel} n_{Pin}^{C,Fuel} \\ n_{Pin}^{C,Ref} &= m_{Pin}^{Fuel} N^{C,Fuel} / FW^{Fuel} \\ n_{PEX}^{C,Ref} &= V_{PEX}^{Ref} (y^{CO} + y^{CO_2} + y^{CH_4}) / V_{Std} \\ \text{Therefore: } X^{Fuel} &= [V_{PEX}^{Ref} (y^{CO} + y^{CO_2} + y^{CH_4}) FW^{Fuel}] / [V_{Std} m_{Pin}^{Fuel} N^{C,Fuel}] \end{aligned}$$

5. Reformate LHV ( $LHV^{Ref}$ ):

$$LHV^{Ref} = \sum y^i H_c^i$$

6. Thermal power ( $W^{Ref}$ ,  $kW_{th}$ ):

$$W^{Ref} = [V_{PEX}^{Ref} LHV^{Ref}] / [60 - V_{Std} \Delta t]$$

7. Steam Generator efficiency ( $e^{SGen}$ ):

$$\epsilon^{SGen} = m_{Pin}^{H_2O} [H^{H_2O}(T_{Ex}^{SGen}, P_{Pin}^{H_2O}) - H^{H_2O}(T_{In}^{SGen}, P_{Pin}^{H_2O})] / [1000 m_{Bin}^{Fuel} LHV^{Fuel}]$$

8. Reformer process efficiency ( $\epsilon^{Ref}$ ):

$$\epsilon^{Ref} = W^{Ref} / [(m_{Bin}^{SG}^{Fuel} + m_{Bin}^{SG}^{Fuel}) LHV_{propane}^{Fuel} + m_{Pin}^{Fuel} LHV^{Fuel}] / (60 \Delta t)$$

The  $LHV_{propane}^{Fuel}$  was used in here since the burners for the steam generator and steam reformer were run on propane.

9. Reformer Hydrogen Efficiency ( $\epsilon^{H_2}$ ):

It is the thermal energy of hydrogen in the reformate stream divided by the thermal energy of fuel feed into steam reformer reactor.

$$\epsilon^{H_2} = y^{H_2} H_c^{H_2} V_{PEX}^{Ref} / [V_{Std} m_{Pin}^{Fuel} LHV^{Fuel}]$$

10. Steam to Carbon Ratio (S/C):

$$S/C = m_{Pin}^{H_2O} / (FW^{H_2O} X^{Fuel} n_{Pin}^{C,Fuel})$$

11. H<sub>2</sub> Generation Rate (g/min)

$$m_{H_2}^{Ref} = y^{H_2} FW^{H_2} V_{PEX}^{Ref} / (V_{Std} \Delta t)$$

12. CO Generation Rate (g/min)

$$m_{CO}^{Ref} = y^{CO} FW^{CO} V_{PEX}^{Ref} / (V_{Std} \Delta t)$$

13. CH<sub>4</sub> Generation Rate (g/min)

$$m_{CH_4}^{Ref} = y^{CH_4} FW^{CH_4} V_{PEX}^{Ref} / (V_{Std} \Delta t)$$

**TABLE C-1: Fuels and Reactions Properties**

Fuel Properties					General Steam Reforming Reaction $C_nH_mO_p + \gamma H_2O = aC_xH_yO_z$									
Fuel	LHV		Density		Reactants				Reformate*					
	(BTU/lb)	(kJ/g)	(lb/gal)	(g/cm <sup>3</sup> )	n	m	p	$\gamma$	a	x	y	z	FW (g/mol)	LHV (kJ/mol)
JP-8	18,400	42.80	6.59	0.79	11	21	0	17.89	39.10	0.28	1.45	0.46	12.17	204.55
Synthetic (SPK)	18,400	42.80	6.59	0.79	11	21	0	17.89	39.10	0.28	1.45	0.46	12.17	204.55
50/50 JP8-FT	18,400	42.80	6.59	0.79	11	21	0	17.89	39.10	0.28	1.45	0.46	12.17	204.55
Diesel (no. 2)	18,500	42.99	7.10	0.85	12	22	0	19.92	42.65	0.28	1.45	0.47	12.31	201.61
Propane	19,900	46.25	4.20	0.50	3	8	0	4.87	11.78	0.25	1.51	0.41	11.20	208.26
BioDiesel (B100)	16,500	38.35	7.30	0.87	20	40	2	31.35	70.94	0.28	1.45	0.47	12.37	200.83

\* Reformate composition (dry) and H<sub>2</sub>O Stoichiometry (g) based on equilibrium at 700C, 2 atm, with feed S/C = 5, as computed using NASA/CEA.

[http://www.engineeringtoolbox.com/alternative-fuels-d\\_1221.html](http://www.engineeringtoolbox.com/alternative-fuels-d_1221.html)

## APPENDIX D: Startup and Test Procedures

The process pre-startup, startup, operation and experiment, sampling, and shutdown procedures are given in Table D-1.

**TABLE D-1: Operational Procedures**

1	Propane	Liquid	Liquid	Pre-Startup Preparation/ Checks Procedures
	Process Fuel	Process Fuel	Process Fuel	
	Propane Burner	Propane Burner	Liquid Burner	
1.1				Check the following valve settings:
	X	X		Valve 1 (SG Burner Fuel Reservoir to SG burner) fully closed to SG burner.
	X	X		Valve 2 (Reformer Burner Fuel Reservoir to Reformer burner) fully closed to Reformer burner.
	X			Valve 3 (Propane Fuel Tank to Mixer) fully closed to Mixer
	X	X	X	Valve 4 (reformate gas flow to Condenser) Fully Closed to Condenser
2	Propane	Liquid	Liquid	Startup Procedures
	Process Fuel	Process Fuel	Process Fuel	
	Propane Burner	Propane Burner	Liquid Burner	
2.1	X	X	X	Switch on Main Power
2.2	X	X	X	Switch on Input / Output Module Power
2.3	X	X	X	Turn G/L Separator Switch to Auto
2.4	X	X	X	Begin LabView Virtual Instrument Interface

3	Propane	Liquid	Liquid	Steam Generator Procedures
	Process Fuel	Process Fuel	Process Fuel	
	Propane Burner	Propane Burner	Liquid Burner	
3.1	X	X	X	Increase SG Burner Blower speed to 30 slpm.
3.2			X	Increase SG burner fuel flow to a flow rate of 1 g/min.
3.3	X	X		Open SG Burner Fuel Reservoir [100% Open].
3.4	X	X	X	Place lit Propane torch near SG burner.
3.5	X	X		Gradually Open Valve 1 manually (SG Burner Fuel Reservoir to SG burner) to introduce burner fuel to SG burner.
3.6	X	X	X	Increase burner fuel flow until SG burner lights and a stabilized blue flame is achieved.
3.7	X	X	X	Observe Steam-Out (SO) temperature.
3.8	X	X	X	When Steam-Out (SO) temperature reaches 100 deg C, increase water flow to 2 mL/min.
3.9	X	X	X	Gradually step water flow rate as Steam-Out (SO) temperature increases and achieves steady state.
3.10	X	X	X	When Steam-Out (SO) temperature reaches 550 deg C, bring water flow rate to maximum desired flow rate.
4	Propane	Liquid	Liquid	Steam Reformer Procedures
	Process Fuel	Process Fuel	Process Fuel	
	Propane Burner	Propane Burner	Liquid Burner	
4.1	X	X	X	Increase Reformer Burner Blower speed to 30 slpm.
4.2			X	Increase Reformer burner fuel flow to a flow rate of 1 g/min.
4.3	X	X		Open Reformer Burner Fuel Reservoir [100% Open].
4.4	X	X	X	Place lit Propane torch near Reformer burner.
4.5	X	X		Gradually open Valve 2 manually (Reformer Burner Fuel Reservoir to Reformer burner) to introduce burner fuel to Reformer burner.
4.6	X	X	X	Increase burner fuel flow until Reformer burner lights and a stabilized blue flame is achieved.
4.7	X	X	X	Monitor Reformer-In (RI), Reformer-Out (RO), and Reformer Wall (RW) temperatures.

5	Propane	Liquid	Liquid	Process
	Process Fuel	Process Fuel	Process Fuel	Procedures
	Propane Burner	Propane Burner	Liquid Burner	
5.1		X	X	Turn on compressed Air to fuel Vaporizer.
5.2		X	X	Increase compressed Air to 70 psi.
5.3		X	X	Set fuel Vaporizer heater cartridge power supply to 70% output.
5.4		X	X	Bring fuel Vaporizer temperature to 400 deg C.
5.5		X	X	Increase process fuel flow rate to fuel Vaporizer to a flow rate of 0.1 g/min.
5.6	X			Open Propane Fuel Tank [100% Open]
5.7	X			Gradually open Valve 3 (Propane Fuel Tank to Mixer) to increase process fuel flow rate to Mixer to a flow rate of 0.1 g/min.
5.8	X	X	X	Monitor Steam-In (SI), Steam-Out (SO), Reformer-In (RI), and Reformer-Out (RO) temperatures. Allow temperatures to achieve steady state.
5.9	X	X	X	Gradually step process fuel flow rate to maximum desired flow. Allow all temperatures to achieve steady state between steps.
5.10	X	X	X	Monitor Steam-In (SI), Steam-Out (SO), Reformer-In (RI), and Reformer-Out (RO) temperatures.
5.11	X	X	X	Observe Valve 4 exhaust (reformate gas flow to Condenser) for visual reformate.
5.12	X	X	X	Fully Open Valve 4 (reformate gas flow to Condenser). Allow reformate to enter downstream process.
5.13	X	X	X	Monitor Steam-In (SI), Steam-Out (SO), Reformer-In (RI), and Reformer-Out (RO) temperatures. Allow temperatures to achieve steady state.
5.14	X	X	X	Monitor process flow.
5.15	X	X	X	Take GC sample from GC injection port.
6	Propane	Liquid	Liquid	Cooldown
	Process Fuel	Process Fuel	Process Fuel	Procedures
	Propane Burner	Propane Burner	Liquid Burner	
6.1	X	X	X	Close Valve 4 (reformate gas flow to Condenser) [100% Closed].
6.2		X	X	Decrease process fuel flow rate to 0 g/min.
6.3	X			Close Valve 3 (Propane Fuel Tank to Mixer) [100% Closed]
6.4		X	X	Decrease fuel Vaporizer heater cartridge power supply to 0% output.
6.5		X	X	Decrease compressed Air to 0 psi.
6.6	X	X	X	Decrease water flow rate to 2 mL/min.
6.7	X	X		Close Valve 1 (SG Burner Fuel Reservoir to SG burner) [100% Closed].
6.8	X	X		Close Valve 2 (Reformer Burner Fuel Reservoir to Reformer burner) [100% Closed].
6.9	X	X		Close Reformer Burner Fuel Reservoir [100% Closed].
6.10	X	X		Close SG Burner Fuel Reservoir [100% Closed].
6.11			X	Decrease SG burner fuel flow rate to 0 g/min.
6.12			X	Decrease Reformer fuel flow rate to 0 g/min
6.13	X	X		Close Propane Fuel Tank [100% Closed]
6.14	X	X	X	Decrease water flow rate to 0 mL/min when Steam-Out (SO) temperature cools to 150°C.
6.15	X	X	X	Decrease SG Blower speed to 0 slpm.
6.16	X	X	X	Decrease Reformer Blower speed to 0 slpm.
6.17	X	X	X	Allow all temperatures to cool to ambient temperature.
6.18	X	X	X	End LabView Virtual Instrument Interface.
6.19	X	X	X	Turn G/L Separator Switch to "Off".
6.20	X	X	X	Switch off Input / Output Module Power.
6.21	X	X	X	Switch off Main Power.

## APPENDIX E: Test Results

### Data for 2 g/min fuel flow rate to Steam Reformer

Logistic Jet Fuel – JP-8:

S/C	SR Fuel Flow Rate [g/min]	Water Flow Rate [g/min]	Steam In [°C]	Steam Out [°C]	Reformer In [°C]	Reformer Out [°C]	Reactor Wall [°C]	Water Pressure [psig]	Reformat Flow Rate [SLPM]	Test Duration [min]
4	2.00	10.37	103	606	421	445	736	26	8.90	25
4	2.00	10.37	107	635	467	511	799	31	9.78	26
4	2.00	10.37	115	702	544	621	858	34	10.35	31
4	2.00	10.37	113	793	638	725	949	34	10.75	28
5	2.00	12.98	104	599	411	447	722	25	9.43	34
5	2.00	12.98	111	626	472	506	802	33	9.57	32
5	2.00	12.98	109	698	524	618	877	36	10.99	22
5	2.00	12.98	135	679	470	672	774	37	10.81	30
6	2.00	15.58	107	607	414	444	720	27	10.77	24
6	2.00	15.58	112	640	457	529	792	34	11.24	24
6	2.00	15.58	112	722	558	615	805	34	11.31	26
6	2.00	15.58	116	813	623	719	916	36	11.31	25

S/C	SR Fuel Flow Rate [g/min]	Water Flow Rate [g/min]	H <sub>2</sub> [mol%]	CO [mol%]	CH <sub>4</sub> [mol%]	CO <sub>2</sub> [mol%]	C <sub>2</sub> H <sub>2</sub> [mol%]	C <sub>2</sub> H <sub>4</sub> [mol%]	C <sub>2</sub> H <sub>6</sub> [mol%]	C <sub>3</sub> H <sub>6</sub> [mol%]	C <sub>3</sub> H <sub>8</sub> [mol%]
4	2.00	10.37	66.46	12.41	5.45	15.69	0	0	0	0	0
4	2.00	10.37	68.45	11.07	4.97	15.51	0	0	0	0	0
4	2.00	10.37	71.38	10.88	4.11	13.64	0	0	0	0	0
4	2.00	10.37	71.98	11.66	3.90	12.46	0	0	0	0	0
5	2.00	12.98	67.64	12.14	4.64	15.57	0	0	0	0	0
5	2.00	12.98	68.30	11.36	4.12	16.22	0	0	0	0	0
5	2.00	12.98	71.39	8.38	3.34	16.89	0	0	0	0	0
5	2.00	12.98	72.08	11.14	0.62	16.16	0	0	0	0	0
6	2.00	15.58	70.98	10.88	3.76	14.39	0	0	0	0	0
6	2.00	15.58	73.94	7.98	3.42	14.66	0	0	0	0	0
6	2.00	15.58	74.44	5.97	1.37	18.22	0	0	0	0	0
6	2.00	15.58	75.11	6.34	0	18.55	0	0	0	0	0

Diesel:

S/C	SR Fuel Flow Rate [g/min]	Water Flow Rate [g/min]	Steam In [°C]	Steam Out [°C]	Reformer In [°C]	Reformer Out [°C]	Reactor Wall [°C]	Water Pressure [psig]	Reformat Flow Rate [SLPM]	Test Duration [min]
4	2.00	10.37	102	625	425	465	650	21	8.08	34
4	2.00	10.37	115	750	505	537	740	30	9.10	30
4	2.00	10.37	103	821	590	650	880	30	10.10	22
4	2.00	10.37	105	767	645	703	912	35	9.70	35
5	2.00	12.98	105	610	421	457	660	22	8.40	20
5	2.00	12.98	112	703	515	526	710	29	9.50	41
5	2.00	12.98	110	769	567	640	840	34	10.23	34
5	2.00	12.98	103	801	660	710	945	36	10.10	23
6	2.00	15.58	100	606	415	465	700	22	8.12	22
6	2.00	15.58	115	688	499	514	720	37	9.73	25
6	2.00	15.58	112	856	596	654	835	31	10.44	23
6	2.00	15.58	105	860	670	716	890	35	10.10	20

S/C	SR Fuel Flow Rate [g/min]	Water Flow Rate [g/min]	H <sub>2</sub> [mol%]	CO [mol%]	CH <sub>4</sub> [mol%]	CO <sub>2</sub> [mol%]	C <sub>2</sub> H <sub>2</sub> [mol%]	C <sub>2</sub> H <sub>4</sub> [mol%]	C <sub>2</sub> H <sub>6</sub> [mol%]	C <sub>3</sub> H <sub>6</sub> [mol%]	C <sub>3</sub> H <sub>8</sub> [mol%]
4	2.00	10.37	61.93	13.41	5.78	18.87	0	0	0	0	0
4	2.00	10.37	66.16	12.98	3.56	17.30	0	0	0	0	0
4	2.00	10.37	68.96	12.21	2.04	16.79	0	0	0	0	0
4	2.00	10.37	68.15	6.25	1.63	23.97	0	0	0	0	0
5	2.00	12.98	63.26	12.63	4.14	19.97	0	0	0	0	0
5	2.00	12.98	66.66	9.68	3.25	20.41	0	0	0	0	0
5	2.00	12.98	68.90	7.20	1.90	22.00	0	0	0	0	0
5	2.00	12.98	70.15	6.14	0.81	22.90	0	0	0	0	0
6	2.00	15.58	66.27	9.04	2.82	21.86	0	0	0	0	0
6	2.00	15.58	66.31	11.41	3.21	19.06	0	0	0	0	0
6	2.00	15.58	69.99	5.91	0.63	23.47	0	0	0	0	0
6	2.00	15.58	71.37	4.08	0	24.56	0	0	0	0	0



Synthetic Jet Fuel – S8:

S/C	Process Fuel Flow Rate [g/min]	Water Flow Rate [g/min]	Steam In [°C]	Steam Out [°C]	Reformer In [°C]	Reformer Out [°C]	Reactor Wall [°C]	Water Pressure [psig]	Reformate Flowrate [SLPM]	Test Duration [min]
4	2.00	10.37	102	626	416	450	777	26	10.11	25
4	2.00	10.37	105	713	457	515	837	35	10.50	26
4	2.00	10.37	115	817	590	645	905	35	11.44	42
4	2.00	10.37	115	854	635	723	948	32	11.28	32
5	2.00	12.98	104	623	415	461	743	31	11.17	28
5	2.00	12.98	110	721	463	513	803	34	11.06	35
5	2.00	12.98	121	810	589	640	890	38	12.30	57
5	2.00	12.98	117	837	624	719	935	36	11.85	36
6	2.00	15.58	103	616	411	446	756	29	11.01	28
6	2.00	15.58	113	697	456	504	812	32	11.38	27
6	2.00	15.58	117	897	601	665	915	38	11.95	35
6	2.00	15.58	118	845	633	707	953	32	11.69	27

S/C	Process Fuel Flow Rate [g/min]	Water Flow Rate [g/min]	H <sub>2</sub> [mol%]	CO [mol%]	CH <sub>4</sub> [mol%]	CO <sub>2</sub> [mol%]	C <sub>2</sub> H <sub>2</sub> [mol%]	C <sub>2</sub> H <sub>4</sub> [mol%]	C <sub>2</sub> H <sub>6</sub> [mol%]	C <sub>3</sub> H <sub>6</sub> [mol%]	C <sub>3</sub> H <sub>8</sub> [mol%]
4	2.00	10.37	69.91	9.11	5.54	15.43	0	0	0	0	0
4	2.00	10.37	71.11	7.49	4.63	16.76	0	0	0	0	0
4	2.00	10.37	73.04	8.32	3.07	15.57	0	0	0	0	0
4	2.00	10.37	73.51	6.88	3.13	16.48	0	0	0	0	0
5	2.00	12.98	72.28	7.91	3.46	16.36	0	0	0	0	0
5	2.00	12.98	73.34	6.69	3.15	16.82	0	0	0	0	0
5	2.00	12.98	74.62	5.04	1.55	18.79	0	0	0	0	0
5	2.00	12.98	76.12	5.23	0.43	18.22	0	0	0	0	0
6	2.00	15.58	72.61	5.96	2.21	19.22	0	0	0	0	0
6	2.00	15.58	73.81	4.61	2.68	18.90	0	0	0	0	0
6	2.00	15.58	76.07	3.51	0	20.42	0	0	0	0	0
6	2.00	15.58	76.43	2.34	0	21.23	0	0	0	0	0

50/50 JP-8/S-8:

S/C	Process Fuel Flow Rate [g/min]	Water Flow Rate [g/min]	Steam In [°C]	Steam Out [°C]	Reformer In [°C]	Reformer Out [°C]	Reactor Wall [°C]	Water Pressure [psig]	Reformate Flow Rate [SLPM]	Test Duration [min]
4	2.00	10.37	103	621	409	469	711	28	9.54	26
4	1.86	10.37	115	689	463	510	793	32	9.63	28
4	1.86	10.37	122	797	575	624	843	33	9.65	28
4	1.53	10.37	125	878	667	714	913	32	8.86	34
5	2.00	12.98	105	621	404	446	713	28	10.95	28
5	2.00	12.98	107	675	471	525	755	36	11.50	22
5	2.00	12.98	113	760	560	602	829	38	12.78	60
5	2.00	12.98	118	825	639	707	908	37	11.34	31
6	2.00	15.58	102	607	413	450	703	27	10.86	27
6	2.00	15.58	103	668	453	505	766	32	11.22	28
6	2.00	15.58	110	776	578	619	815	34	10.50	30
6	2.00	15.58	110	835	629	720	937	37	11.67	30

S/C	Process Fuel Flow Rate [g/min]	Water Flow Rate [g/min]	H <sub>2</sub> [mol%]	CO [mol%]	CH <sub>4</sub> [mol%]	CO <sub>2</sub> [mol%]	C <sub>2</sub> H <sub>2</sub> [mol%]	C <sub>2</sub> H <sub>4</sub> [mol%]	C <sub>2</sub> H <sub>6</sub> [mol%]	C <sub>3</sub> H <sub>6</sub> [mol%]	C <sub>3</sub> H <sub>8</sub> [mol%]
4	2.00	10.37	69.45	12.19	5.57	12.79	0	0	0	0	0
4	1.86	10.37	70.30	11.89	5.38	12.43	0	0	0	0	0
4	1.86	10.37	72.10	10.55	4.13	13.22	0	0	0	0	0
4	1.53	10.37	73.26	10.42	2.79	13.53	0	0	0	0	0
5	2.00	12.98	73.23	8.43	1.21	17.12	0	0	0	0	0
5	2.00	12.98	74.58	6.21	0.81	18.40	0	0	0	0	0
5	2.00	12.98	77.26	7.34	0	15.4	0	0	0	0	0
5	2.00	12.98	77.35	5.23	0	17.41	0	0	0	0	0
6	2.00	15.58	73.94	4.53	0.43	21.10	0	0	0	0	0
6	2.00	15.58	77.01	4.54	0	18.45	0	0	0	0	0
6	2.00	15.58	79.36	3.56	0	17.08	0	0	0	0	0
6	2.00	15.58	77.64	3.44	0	18.92	0	0	0	0	0

Propane:

S/C	Process Fuel Flow Rate [g/min]	Water Flow Rate [g/min]	Steam In [°C]	Steam Out [°C]	Reformer In [°C]	Reformer Out [°C]	Reactor Wall [°C]	Water Pressure [psig]	Reformate Flowrate [SLPM]	Test Duration [min]
4	2.00	9.90	105	630	425	455	690	24	9.84	30
4	2.00	9.90	105	737	490	530	736	35	10.42	25
4	2.00	9.90	106	805	589	650	885	37	11.60	35
4	2.00	9.90	110	820	637	699	910	36	11.20	21
5	2.00	12.40	103	625	426	444	705	28	9.76	28
5	2.00	12.40	110	690	485	506	770	34	11.53	44
5	2.00	12.40	113	843	596	676	910	38	12.41	27
5	2.00	12.40	107	850	656	705	935	36	11.86	37
6	2.00	14.90	102	902	425	450	725	30	10.32	23
6	2.00	14.90	105	715	496	529	800	38	10.88	26
6	2.00	14.90	104	776	575	645	870	36	11.98	23
6	2.00	14.90	102	840	649	711	955	35	11.47	35

S/C	Process Fuel Flow Rate [g/min]	Water Flow Rate [g/min]	H <sub>2</sub> [mol%]	CO [mol%]	CH <sub>4</sub> [mol%]	CO <sub>2</sub> [mol%]	C <sub>2</sub> H <sub>2</sub> [mol%]	C <sub>2</sub> H <sub>4</sub> [mol%]	C <sub>2</sub> H <sub>6</sub> [mol%]	C <sub>3</sub> H <sub>6</sub> [mol%]	C <sub>3</sub> H <sub>8</sub> [mol%]
4	2.00	9.90	70.25	11.55	3.56	14.65	0	0	0	0	0
4	2.00	9.90	72.40	8.67	1.25	17.68	0	0	0	0	0
4	2.00	9.90	74.13	7.12	0.32	18.43	0	0	0	0	0
4	2.00	9.90	75.36	6.33	0.29	18.02	0	0	0	0	0
5	2.00	12.40	70.56	10.23	2.39	16.81	0	0	0	0	0
5	2.00	12.40	75.59	8.97	0	15.44	0	0	0	0	0
5	2.00	12.40	75.90	6.10	0	18.00	0	0	0	0	0
5	2.00	12.40	77.24	4.66	0	18.10	0	0	0	0	0
6	2.00	14.90	73.26	9.18	1.46	16.10	0	0	0	0	0
6	2.00	14.90	76.59	5.23	0	18.18	0	0	0	0	0
6	2.00	14.90	78.23	4.67	0	17.10	0	0	0	0	0
6	2.00	14.90	78.80	4.41	0	16.80	0	0	0	0	0

Biodiesel – B-100:

S/C	Process Fuel Flow Rate [g/min]	Water Flow Rate [g/min]	Steam In [°C]	Steam Out [°C]	Reformer In [°C]	Reformer Out [°C]	Reactor Wall [°C]	Water Pressure [psig]	Reformate Flowrate [SLPM]	Test Duration [min]
4	2.00	9.31	102	599	425	445	707	26	11.17	21
4	2.00	9.31	103	737	480	515	766	32	10.86	22
4	2.00	9.31	115	905	605	660	925	41	11.35	25
4	2.00	9.31	110	915	641	704	964	36	11.62	25
5	2.00	11.63	103	595	419	457	709	26	10.99	23
5	2.00	11.63	107	634	473	519	803	30	11.23	27
5	2.00	11.63	115	884	599	654	917	37	11.94	32
5	2.00	11.63	110	923	635	717	967	35	11.96	31
6	2.00	13.92	103	617	422	464	705	27	10.73	23
6	2.00	13.92	106	707	452	509	780	36	10.89	27
6	2.00	13.92	124	800	580	670	886	39	11.76	28
6	2.00	13.92	113	913	630	708	947	35	11.45	23

S/C	Process Fuel Flow Rate [g/min]	Water Flow Rate [g/min]	H <sub>2</sub> [mol%]	CO [mol%]	CH <sub>4</sub> [mol%]	CO <sub>2</sub> [mol%]	C <sub>2</sub> H <sub>2</sub> [mol%]	C <sub>2</sub> H <sub>4</sub> [mol%]	C <sub>2</sub> H <sub>6</sub> [mol%]	C <sub>3</sub> H <sub>6</sub> [mol%]	C <sub>3</sub> H <sub>8</sub> [mol%]
4	2.00	9.31	72.63	12.35	0	15.02	0	0	0	0	0
4	2.00	9.31	73.23	9.66	0	17.12	0	0	0	0	0
4	2.00	9.31	74.02	8.51	0	17.47	0	0	0	0	0
4	2.00	9.31	76.12	8.62	0	15.26	0	0	0	0	0
5	2.00	11.63	72.68	9.74	0	17.58	0	0	0	0	0
5	2.00	11.63	73.46	8.93	0	17.61	0	0	0	0	0
5	2.00	11.63	75.68	7.89	0	16.43	0	0	0	0	0
5	2.00	11.63	75.81	4.40	0	19.79	0	0	0	0	0
6	2.00	13.92	73.45	8.78	0	17.77	0	0	0	0	0
6	2.00	13.92	74.22	7.44	0	18.34	0	0	0	0	0
6	2.00	13.92	76.67	5.80	0	17.53	0	0	0	0	0
6	2.00	13.92	77.29	4.23	0	18.48	0	0	0	0	0

## Data for 4.3 g/min fuel flow rate to Steam Reformer

### Logistic Jet Fuel – JP-8:

S/C	SR Fuel Flow Rate	Water Flow Rate	Steam In	Steam Out	Reformer In	Reformer Out	Reactor Wall	Water Pressure	Reformate Flow Rate	Test Duration	SG Burner Fuel Flow Rate	Reformer Burner Fuel Flow Rate
	[g/min]	[g/min]									[g/min]	
			[°C]	[°C]	[°C]	[°C]	[°C]	[psig]	[SLPM]	[min]	[g/min]	[g/min]
4	4.30	22.30	108	695	462	508	792	29	19.88	25	7.33	5.27
4	4.30	22.30	114	759	561	621	861	33	20.17	20	8.54	6.67
4	4.30	22.30	121	837	641	707	903	32	20.67	24	9.23	7.41
4	4.30	22.30	125	902	733	814	964	34	21.44	22	9.92	8.26
5	4.30	27.90	111	677	472	514	787	27	21.33	28	7.59	5.32
5	4.30	27.90	115	747	555	606	852	30	21.56	30	8.68	6.53
5	4.30	27.90	120	826	649	711	899	31	22.27	30	9.62	7.42
5	4.30	27.90	123	895	729	819	951	35	22.43	26	10.16	8.28
6	4.30	33.50	107	692	474	519	773	30	22.48	25	7.68	5.34
6	4.30	33.50	112	766	567	610	849	33	22.52	27	8.85	6.58
6	4.30	33.50	116	852	658	709	901	32	23.02	24	9.91	7.41
6	4.30	33.50	119	916	750	823	968	34	23.23	28	10.33	8.32
S/C	SR Fuel Flow Rate	Water Flow Rate	H <sub>2</sub>	CO	CH <sub>4</sub>	CO <sub>2</sub>	C <sub>2</sub> H <sub>2</sub>	C <sub>2</sub> H <sub>4</sub>	C <sub>2</sub> H <sub>6</sub>	C <sub>3</sub> H <sub>6</sub>	C <sub>3</sub> H <sub>8</sub>	
	[g/min]	[g/min]	[mol%]	[mol%]	[mol%]	[mol%]	[mol%]	[mol%]	[mol%]	[mol%]	[mol%]	
4	4.30	22.30	69.31	12.46	4.84	13.39	0	0	0	0	0	
4	4.30	22.30	70.55	11.64	4.12	13.69	0	0	0	0	0	
4	4.30	22.30	71.33	10.67	3.63	14.36	0	0	0	0	0	
4	4.30	22.30	71.84	11.10	2.84	14.21	0	0	0	0	0	
5	4.30	27.90	70.13	9.11	4.44	16.32	0	0	0	0	0	
5	4.30	27.90	71.42	8.74	3.61	16.23	0	0	0	0	0	
5	4.30	27.90	72.34	9.28	1.88	16.49	0	0	0	0	0	
5	4.30	27.90	72.74	10.13	0	17.13	0	0	0	0	0	
6	4.30	33.50	72.61	7.16	2.34	17.89	0	0	0	0	0	
6	4.30	33.50	73.94	6.45	1.77	17.84	0	0	0	0	0	
6	4.30	33.50	75.12	5.79	0.66	18.43	0	0	0	0	0	
6	4.30	33.50	75.96	5.42	0	18.62	0	0	0	0	0	

### 50/50 JP-8/S-8:

S/C	Process Fuel Flow Rate	Water Flow Rate	Steam In	Steam Out	Reformer In	Reformer Out	Reactor Wall	Water Pressure	Process Flow Rate	Test Duration	SG Burner Fuel Flow Rate	Reformer Burner Fuel Flow Rate
	[g/min]	[g/min]									[g/min]	[g/min]
			[°C]	[°C]	[°C]	[°C]	[°C]	[psig]	[SLPM]	[min]	[g/min]	[g/min]
4	4.30	22.30	103	616	412	467	706	26	19.32	24	6.51	4.72
4	4.30	22.30	107	678	474	513	785	34	19.64	28	7.25	5.32
4	4.30	22.30	113	785	565	609	824	35	20.35	32	8.47	6.62
5	4.30	27.90	105	623	408	459	715	28	21.22	27	6.83	4.67
5	4.30	27.90	109	683	463	508	793	32	21.46	28	7.62	5.29
5	4.30	27.90	115	776	567	619	847	34	21.96	25	8.75	6.68
5	4.30	27.90	117	836	643	737	917	35	22.87	26	9.69	7.34
6	4.30	33.50	110	621	413	463	721	26	22.36	31	7.26	4.75
6	4.30	33.50	112	695	486	521	801	34	22.55	30	7.98	5.39
6	4.30	33.50	118	797	559	612	851	36	22.02	26	9.17	6.65
6	4.30	33.50	115	814	635	715	905	34	23.01	24	9.84	7.44
S/C	Process Fuel Flow Rate	Water Flow Rate	H <sub>2</sub>	CO	CH <sub>4</sub>	CO <sub>2</sub>	C <sub>2</sub> H <sub>2</sub>	C <sub>2</sub> H <sub>4</sub>	C <sub>2</sub> H <sub>6</sub>	C <sub>3</sub> H <sub>6</sub>	C <sub>3</sub> H <sub>8</sub>	
	[g/min]	[g/min]	[mol%]	[mol%]	[mol%]	[mol%]	[mol%]	[mol%]	[mol%]	[mol%]	[mol%]	
4	4.30	22.30	70.79	11.40	5.37	12.43	0	0	0	0	0	
4	4.30	22.30	71.17	11.74	5.15	11.94	0	0	0	0	0	
4	4.30	22.30	72.32	9.15	4.90	13.63	0	0	0	0	0	
5	4.30	27.90	72.25	10.32	4.19	13.23	0	0	0	0	0	
5	4.30	27.90	73.12	8.37	3.83	14.68	0	0	0	0	0	
5	4.30	27.90	74.43	7.47	1.97	16.13	0	0	0	0	0	
5	4.30	27.90	75.57	7.25	0.63	16.54	0	0	0	0	0	
6	4.30	33.50	72.38	7.82	3.38	16.42	0	0	0	0	0	
6	4.30	33.50	73.71	6.76	1.96	17.57	0	0	0	0	0	
6	4.30	33.50	75.24	6.12	0.43	18.21	0	0	0	0	0	
6	4.30	33.50	76.44	4.30	0	19.26	0	0	0	0	0	