



# 75th MORSS CD Cover Page

UNCLASSIFIED DISCLOSURE FORM CD Presentation

712CD

For office use only 41205

12-14 June 2007, at US Naval Academy, Annapolis, MD

Please complete this form 712CD as your cover page to your electronic briefing submission to the MORSS CD. Do not fax to the MORS office.

**Author Request** (To be completed by applicant) - The following author(s) request authority to disclose the following presentation in the MORSS Final Report, for inclusion on the MORSS CD and/or posting on the MORS web site.

Name of Principal Author and all other author(s):

Mr. Randolph A. Jones

Mr. Burney McKinley

Ms. Lora Johnson

Principal Author's Organization and address:

US Army Engineer Research and Development Center

ATTN: R. Jones GMM Bld 3286

3090 Halls Ferry Road

Vicksburg, MS 39180

Phone:601-634-4145

Fax:601-634-3068

Email:randy.jones1@us.army.mil

Original title on 712 A/B: Vehicle Gap Analysis Program

Revised title: Vehicle Gap Analysis Program

Presented in (input and Bold one): (WG 10, CG \_\_\_\_, Special Session \_\_\_\_, Poster, Demo, or Tutorial):

**This presentation is believed to be:  
UNCLASSIFIED AND APPROVED FOR PUBLIC RELEASE**

# Report Documentation Page

*Form Approved  
OMB No. 0704-0188*

Public reporting burden for the collection of information is estimated to average 1 hour per response, including the time for reviewing instructions, searching existing data sources, gathering and maintaining the data needed, and completing and reviewing the collection of information. Send comments regarding this burden estimate or any other aspect of this collection of information, including suggestions for reducing this burden, to Washington Headquarters Services, Directorate for Information Operations and Reports, 1215 Jefferson Davis Highway, Suite 1204, Arlington VA 22202-4302. Respondents should be aware that notwithstanding any other provision of law, no person shall be subject to a penalty for failing to comply with a collection of information if it does not display a currently valid OMB control number.

1. REPORT DATE <b>01 JUN 2007</b>	2. REPORT TYPE <b>N/A</b>	3. DATES COVERED <b>-</b>	
4. TITLE AND SUBTITLE <b>Vehicle Gap Analysis Program</b>		5a. CONTRACT NUMBER	
		5b. GRANT NUMBER	
		5c. PROGRAM ELEMENT NUMBER	
6. AUTHOR(S)		5d. PROJECT NUMBER	
		5e. TASK NUMBER	
		5f. WORK UNIT NUMBER	
7. PERFORMING ORGANIZATION NAME(S) AND ADDRESS(ES) <b>US Army Engineer Research and Development Center ATTN: R. Jones GMM Bld 3286 3090 Halls Ferry Road Vicksburg, MS 39180</b>		8. PERFORMING ORGANIZATION REPORT NUMBER	
9. SPONSORING/MONITORING AGENCY NAME(S) AND ADDRESS(ES)		10. SPONSOR/MONITOR'S ACRONYM(S)	
		11. SPONSOR/MONITOR'S REPORT NUMBER(S)	
12. DISTRIBUTION/AVAILABILITY STATEMENT <b>Approved for public release, distribution unlimited</b>			
13. SUPPLEMENTARY NOTES <b>See also ADM202526. Military Operations Research Society Symposium (75th) Held in Annapolis, Maryland on June 12-14, 2007, The original document contains color images.</b>			
14. ABSTRACT			
15. SUBJECT TERMS			
16. SECURITY CLASSIFICATION OF:			17. LIMITATION OF ABSTRACT
a. REPORT <b>unclassified</b>	b. ABSTRACT <b>unclassified</b>	c. THIS PAGE <b>unclassified</b>	<b>UU</b>
			18. NUMBER OF PAGES <b>30</b>
			19a. NAME OF RESPONSIBLE PERSON



# ***Vehicle Gap Analysis Program***

---

US Army Engineer Research & Development Center

**Military Operations Research Society  
75th Symposium  
*June 12 – 14, 2007***

**Presented By:**

**Mr. Randy Jones**

**U.S. Army**

**Engineer Research and Development Center  
Geotechnical and Structures Laboratory  
Vicksburg, Mississippi**



---

**601.634.4145 [randy.jones1@us.army.mil](mailto:randy.jones1@us.army.mil)**

***One Corps, One Regiment, One Team . . . Serving Soldiers, the Army, the Nation***



# ***Presentation Outline***

---

US Army Engineer Research & Development Center

- Introduction to ERDC mobility research
- Statement of research problem, objective and approach
- Simulation of terrain mechanics
- Terrain representation
- Terrain mechanics verification
- Where we're at now
- VAGP Interface
- Conclusions



---

*One Corps, One Regiment, One Team . . . Serving Soldiers, the Army, the Nation*

# ERDC's Mobility R&D Mission

The ERDC mobility research mission is focused on developing high resolution, component-level mobility representations that produce consistent single- and unit-level vehicle mobility in live, virtual, and constructive M&S environments.



Component-Level Testing



Real-Time Simulations



Acquisition Testing



High-Fidelity Modeling



Tactical Mobility Modeling

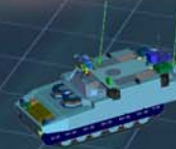

System-Level Testing



Validation Testing



Serving Joint Customers



US Army Corps of Engineers  
Research, Research, and Development Center





# Research Problem

US Army Engineer Research & Development Center

- The Future Combat System Operational Requirements Document requires that manned and unmanned ground vehicles be capable of negotiating gaps 1.5- to 4.0-meters wide
- Current vehicle performance models lack the fidelity and accuracy to predict a vehicle's capability to negotiate deformable gaps



One Corps, One Regiment, One Team . . . Serving Soldiers, the Army, the Nation



# Research Objective

- The objective of this research is to develop physics based simulation and analysis capabilities to accurately predict vehicles crossing deformable terrains
- Develop terrain mechanics models for use with on-board robotic vehicles for decision logic
- Develop tactical decision aides for maneuver support

US Army Engineer Research & Development Center



*One Corps, One Regiment, One Team . . . Serving Soldiers, the Army, the Nation*



# Research Approach

US Army Engineer Research & Development Center

- Use an existing vehicle dynamics software package to demonstrate research and develop new analysis tool
  - The 2-D Vehicle Dynamics (VehDyn II) software package distributed with the NATO Reference Mobility Model (NRMM) was selected as the demonstration platform
- Integrate existing terrain mechanics models
  - Use soils models developed for “whole” traction element representation
  - Use soils models dependent on standard military trafficability kits (hand-held cone penetrometer)
- Develop vehicle chassis and terrain contact interactions
- Develop a vehicle driver model based on the vehicle’s propulsion system



*One Corps, One Regiment, One Team . . . Serving Soldiers, the Army, the Nation*





# VehDyn II

US Army Engineer Research & Development Center

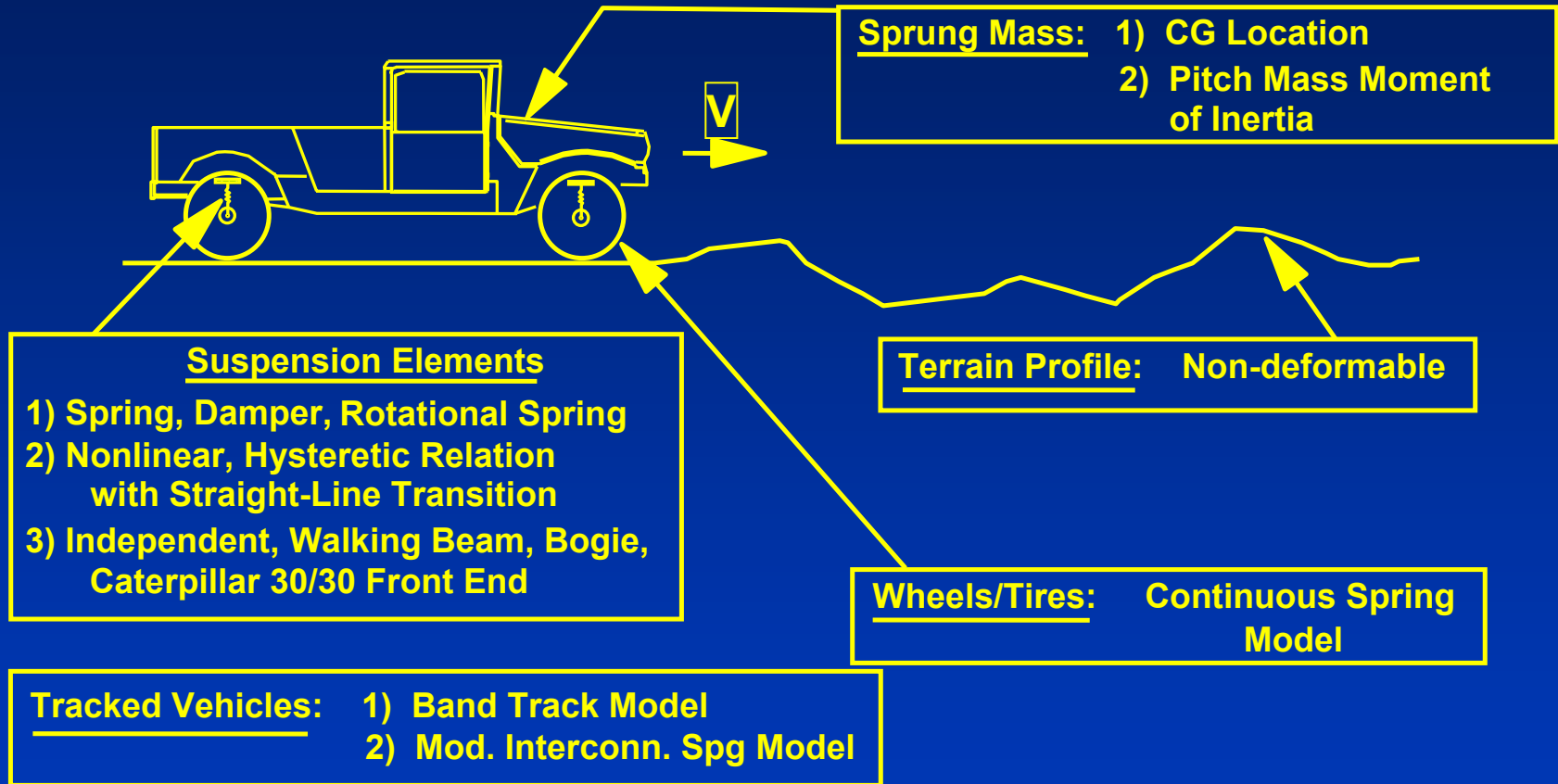

One Corps, One Regiment, One Team . . . Serving Soldiers, the Army, the Nation



# Terrain Mechanics Model (Wheels)

US Army Engineer Research & Development Center

- The fundamental traction element forces for fine-grained and coarse-grained soils are estimated from specifically derived numerics
- The clay numeric ( $\Pi_C$ ) is a function of the RCI, traction element nominal contact length and width; tire section width, diameter, and deflection
- The sand numeric ( $\Pi_S$ ) is a function of the CI and a similar set of measurable traction element items

$$\Pi_C = \frac{RCI(bd)}{w(1 - \delta/h)^{3/2} (1 + b/d)^{3/4}}$$

Fine-grained model

$$\Pi_S = \frac{CI(bd)^{3/2}}{w(1 - \delta/h)^3}$$

Coarse-grained model

Where:  $RCI, CI$  = Soil strength  
 $b$  = Tire section width  
 $d$  = Nominal wheel diameter  
 $h$  = Tire section height  
 $\delta$  = Tire deflection  
 $w$  = Weight beneath tire



One Corps, One Regiment, One Team . . . Serving Soldiers, the Army, the Nation



# Terrain Mechanics Model (Wheels)

- The numeric ( $\Pi$ ) is combined with vehicle performance results to predict drawbar and motion resistance for fine- and course-grained soils
- The equations show the performance parameter as a coefficient based on the weight of the traction element

$$\frac{D}{w} = 0.5 \text{Log}_{10} (i/i_{SP}), \quad i_{SP} = \frac{21}{\Pi_C^{5/2}}$$

Fine-grained

$$\frac{R}{w} = \frac{12}{\Pi_C^2} + .007$$

$$\frac{D}{w} = 0.52 - \frac{396}{\Pi_{DP} + 557}, \quad \Pi_{DP} = \Pi_S \frac{1}{j^{1/2}}$$

$$\frac{R}{w} = X_j + \sqrt{X_j^2 + .0000457 \Pi_{Rj} + .008}$$

$$X_j = 0.44 - .002287 \Pi_{Rj}$$

$$\Pi_{Rj} = \Pi_S \cdot \frac{j^{1/2}}{1 + b/d}$$

Course-grained





# Terrain Mechanics Model (Wheels)

US Army Engineer Research & Development Center

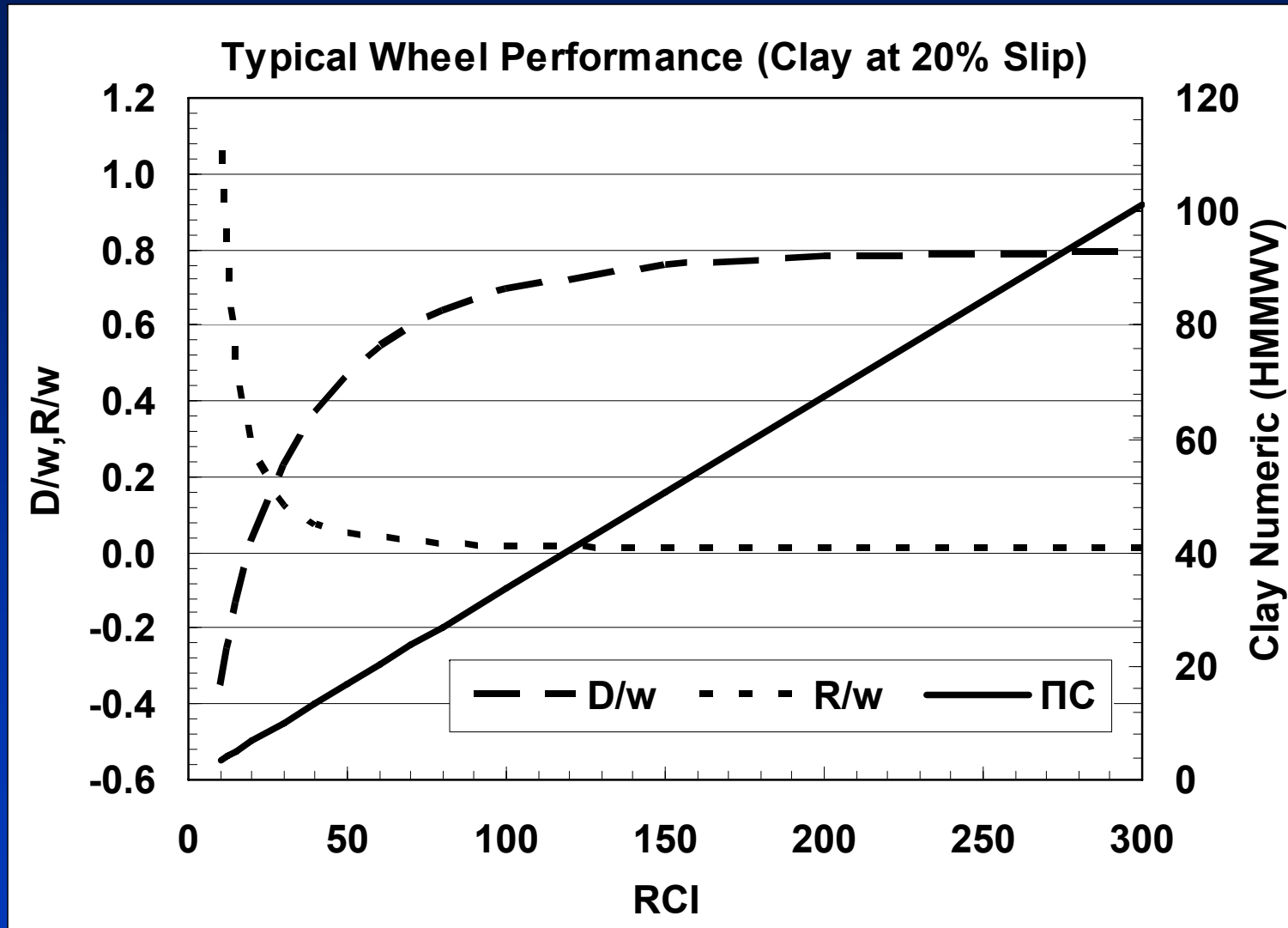

One Corps, One Regiment, One Team . . . Serving Soldiers, the Army, the Nation



# Terrain Mechanics Model (Wheels)

- A variant of the clay numeric ( $\Pi_{CZ}$ ) and the sand numeric ( $\Pi_{SZ}$ ) is used to estimate wheel sinkage

$$\Pi_{Cz} = \frac{RCI(bd)}{w(1-\delta/h)^{3/2}}$$

Fine-grained sinkage

$$\frac{z_p}{d} = \frac{5}{\left(\frac{\Pi_{Cz}}{\text{slip}_{SP}^{1/5}}\right)^{5/3}}$$

$$Z_n = Z_1 \sqrt{n}$$

Sinkage for n vehicle passes

$$Z_1 = \sqrt{Z_{U_1}^2 + Z_{P_1}^2 + Z_{U_2}^2 + \dots + Z_{P_m}^2}$$

Sinkage for m traction elements

$$\Pi_{Sz} = \Pi_s \cdot \frac{1}{1+b/d}$$

Coarse-grained sinkage

$$\frac{z_p}{d} = \frac{14}{\Pi_{SZ}}$$







# Terrain Mechanics Model (Wheels)

US Army Engineer Research & Development Center

## Typical Wheel Sinkage (Clay)

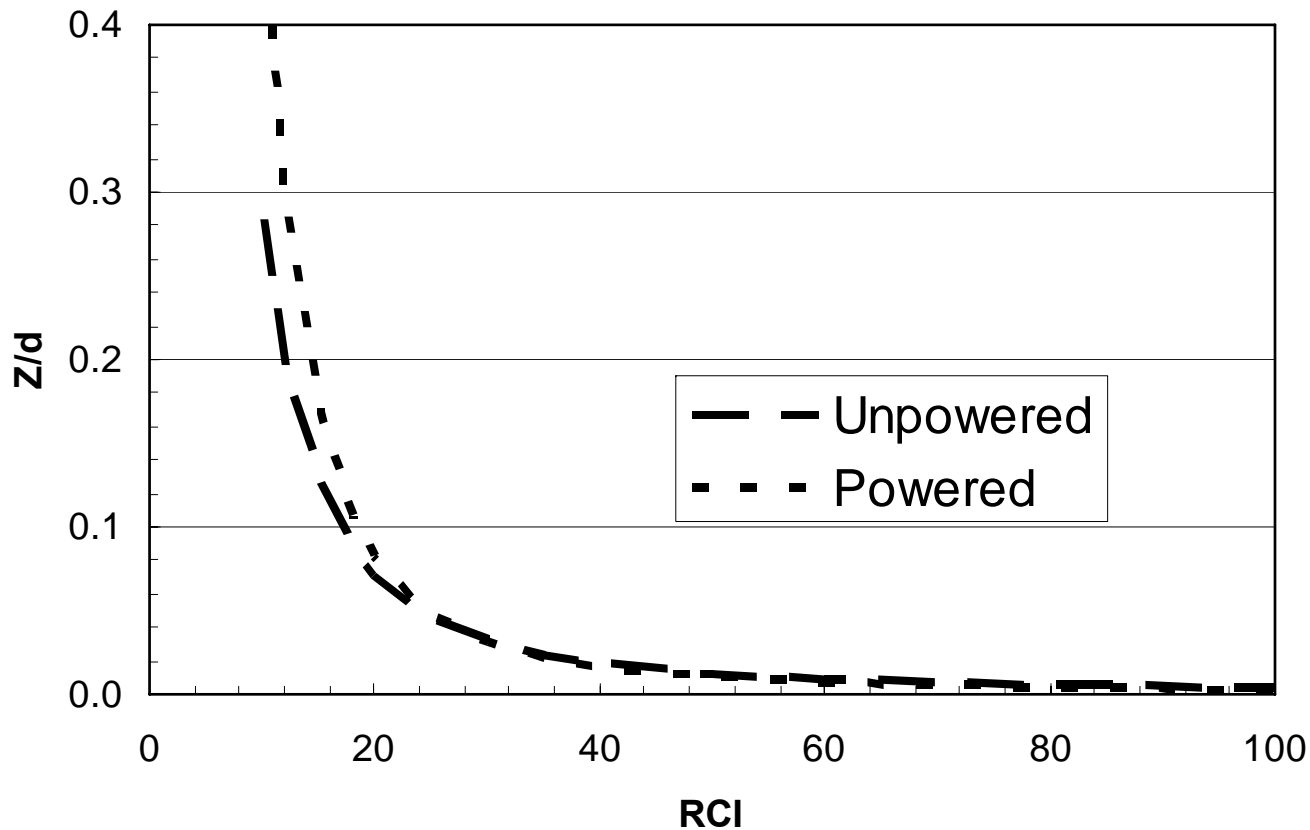

One Corps, One Regiment, One Team . . . Serving Soldiers, the Army, the Nation



# Terrain Mechanics Model (Wheels)

US Army Engineer Research & Development Center

- The terrain is represented by a series of terrain nodes
- The traction element sinkage is determined and used to calculate the sinkage at the current time step that applies to each terrain node in contact with the traction element

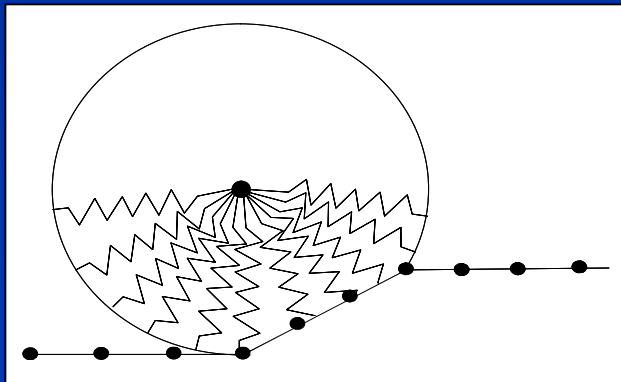

Continuous spring tire model and terrain nodes

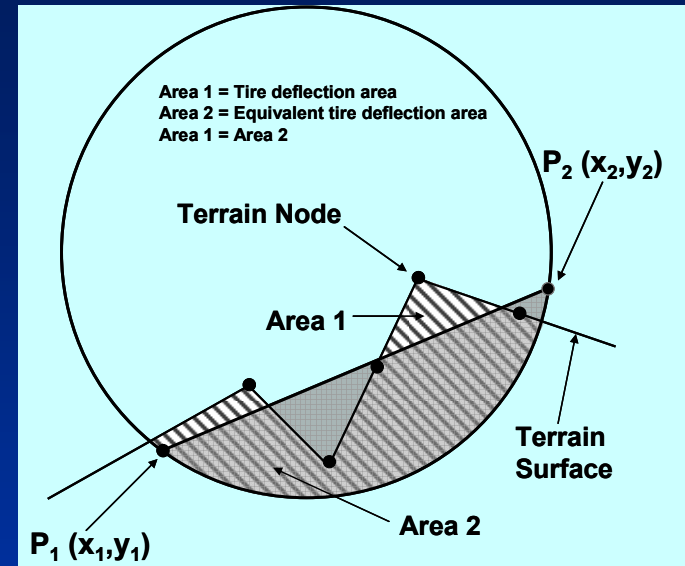

$$S_c = (V \times T) / C \times S$$

S = Predicted total sinkage (in) for entire wheel

C = Chord Length (in) from P1 to P2

T = Time step (sec)

V = Vehicle's instantaneous velocity (in/sec)

$S_c$  = Sinkage (in) this time step



One Corps, One Regiment, One Team . . . Serving Soldiers, the Army, the Nation



# Terrain Mechanics Model (Tracks)

US Army Engineer Research & Development Center

- The fundamental traction element forces for fine-grained and coarse-grained soils are estimated from specifically derived numerics and empirical relationships
- The clay numeric ( $\Pi_C$ ) is a function of the RCI, traction element nominal contact length and track width
- The sand numeric ( $\Pi_S$ ) is a function of the CI and the same set of measurable traction element items

$$\Pi_C = \frac{RCI(bl)}{w}$$

Fine-grained model

$$\Pi_S = \frac{G(bl)^{3/2}}{w}; \quad G = CI * 0.8645 / 3$$

Coarse-grained model

Where:

RCI, CI = Soil strength

G = Soil strength gradient

b = Track width

l = Nominal contact length (ground contact length)

w = Weight beneath track





# Terrain Mechanics Model (Tracks)

- A variant of the clay numeric ( $\Pi_C$ ) and the sand numeric ( $\Pi_S$ ) is used to estimate wheel sinkage

$$\frac{Z}{l} = 0.00443e^{\frac{5.887}{\Pi_C}}$$

Fine-grained sinkage

$$\frac{Z}{l} = 0.030292 + \frac{0.85437}{\Pi_S} - \frac{0.48443}{\Pi_S^2}$$

Coarse-grained sinkage

$$Z_n = Z_1 \sqrt{n}$$

Sinkage for n vehicle passes

$$Z_1 = \sqrt{Z_{U_1}^2 + Z_{P_1}^2 + Z_{U_2}^2 + \dots + Z_{P_m}^2}$$

Sinkage for m traction elements





# Terrain Mechanics Model (Tracks)

US Army Engineer Research & Development Center

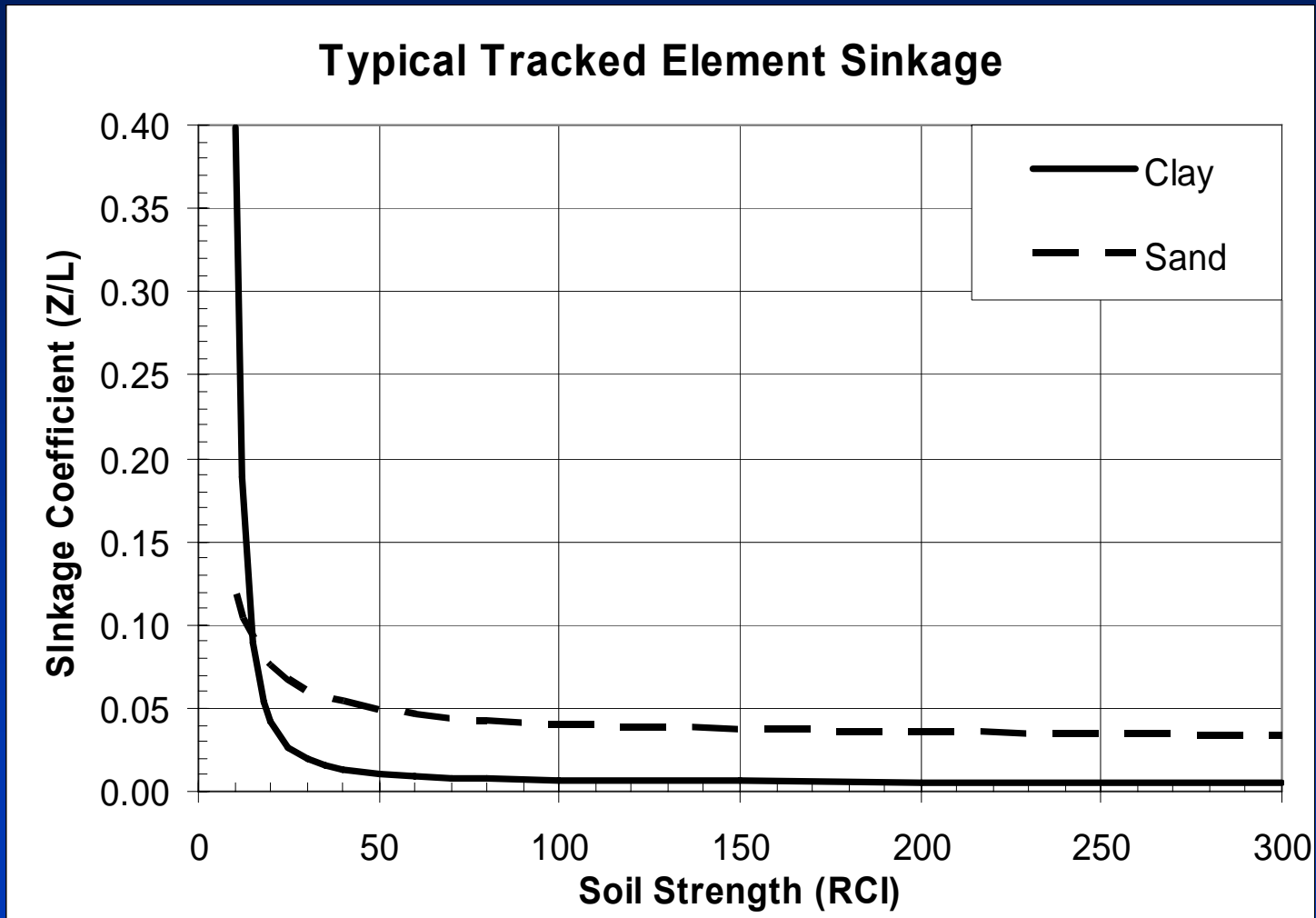

One Corps, One Regiment, One Team . . . Serving Soldiers, the Army, the Nation





# Terrain Mechanics Model (Tracks)

US Army Engineer Research & Development Center

- Drawbar pull for fine-grained soils are calculated using tracked vehicle empirical relationships
- The sand numeric ( $\Pi$ ) is combined with vehicle performance results to predict drawbar for course-grained soils
- The equations show the performance parameter as a coefficient based on the weight of the traction element

$$\frac{D}{w} = A + \frac{B}{RCIx + C}$$

	A	B	C
FGa	0.7814494	-6.709946	7.854210
FGb	0.8117813	-5.737010	6.507696
CPF<4	0.8476903	-4.974673	5.724387

FGa = CPF ≥ 4, USCS: ML, CL, MLCL, OL, SM, SMSC, GM  
 FGb = CPF ≥ 4, USCS: SC, GC, CH, MH, OH

Fine-grained

$$\frac{D}{w} = k1 + k2 \log_{10}(\Pi_s)$$

k1	k2	Condition
0	0	$\Pi_s \leq 0$
0.121	0.258	$0 < \Pi_s \leq 25$
0.339	0.109	$25 < \Pi_s \leq 100$
0.481	0.038	$100 < \Pi_s \leq 1000$
0.595	0	$\Pi_s > 1000$
	Track Type	Max
	Flexible	0.3926
	Girderized	0.5365

Course-grained





# Terrain Mechanics Model (Tracks)

US Army Engineer Research & Development Center

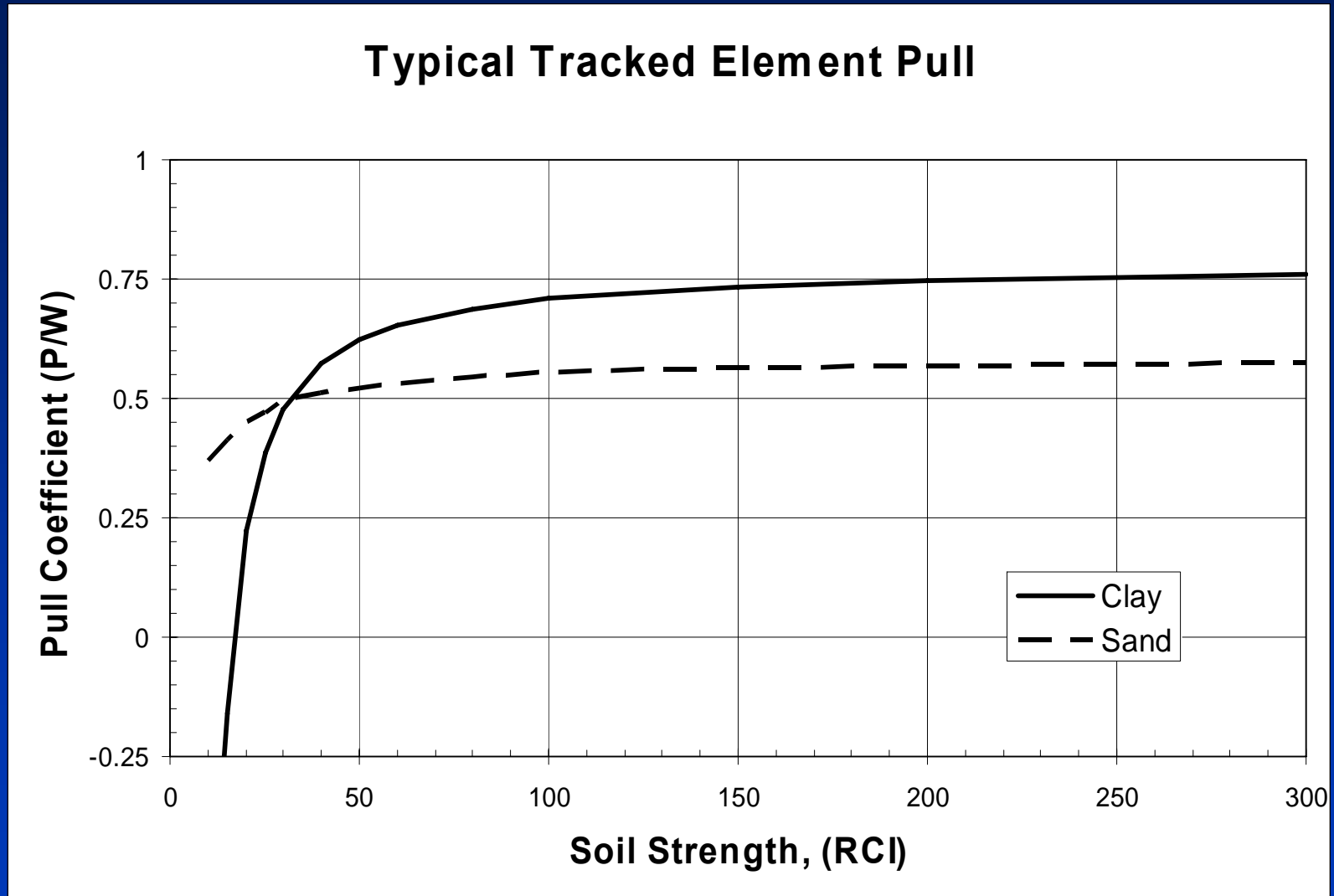

One Corps, One Regiment, One Team . . . Serving Soldiers, the Army, the Nation



# Terrain Mechanics Model (Tracks)

- The terrain is represented by a series of terrain nodes
- The traction element sinkage is determined and used to calculate the sinkage at the current time step that applies to each terrain node in contact with the traction element

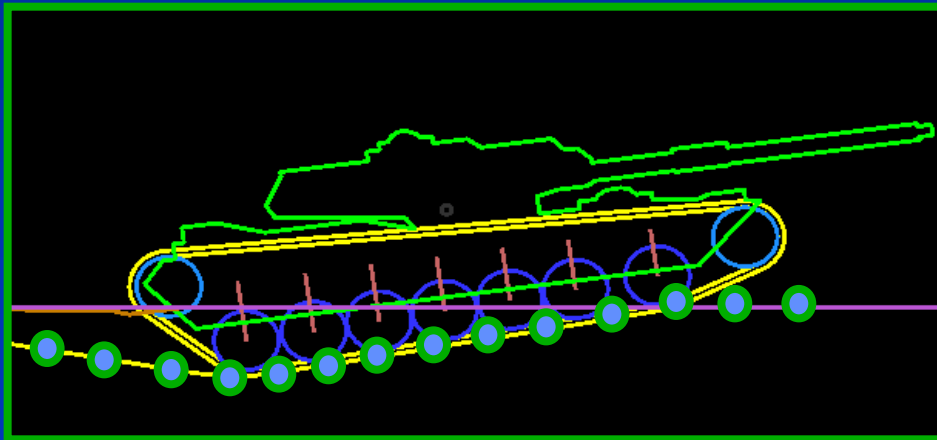
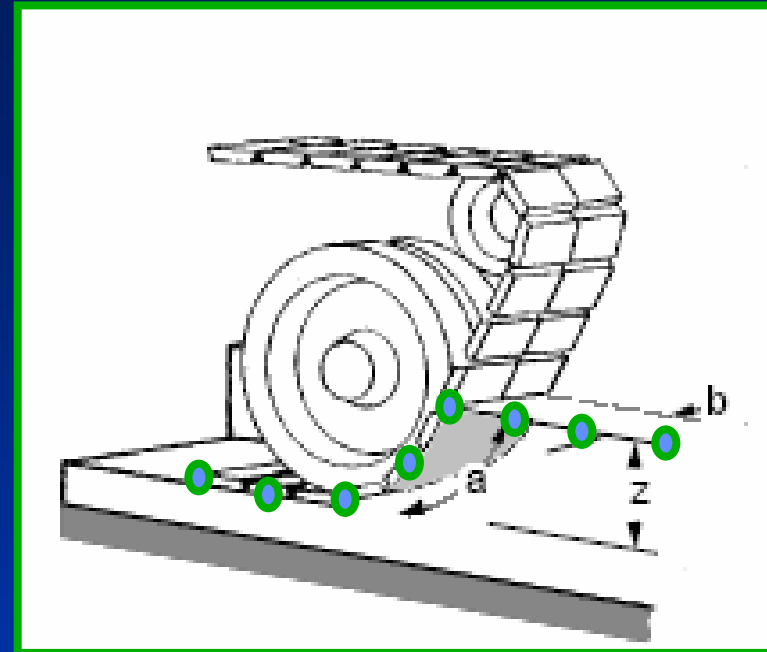



# Vehicle Traction

- The vehicle traction is determined by using the theoretical tractive force and speed relationship developed from the vehicle's propulsion system
- It is adjusted based on the soil properties and numeric relationships

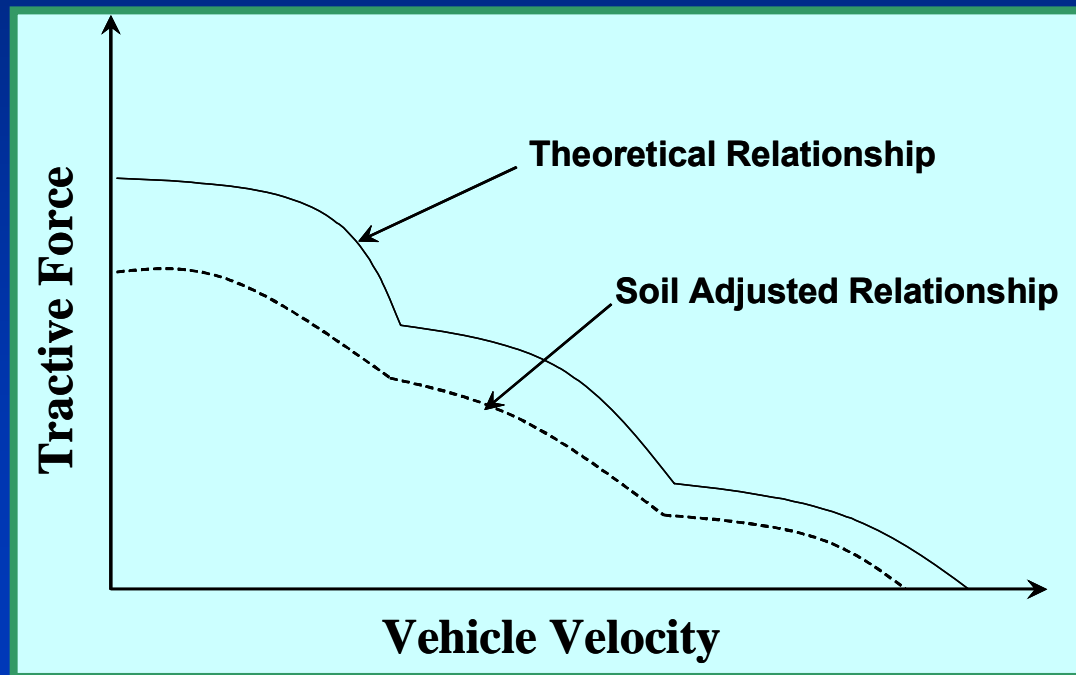



# Chassis/Terrain Interaction

- Underside Impact Detection (UID) “drag” wheels placed all along vehicle underside
- Await impact with the ground
- Produce normal and tangential (drag) forces applied to chassis
- Applied laterally across half the vehicle width like long “tubes”

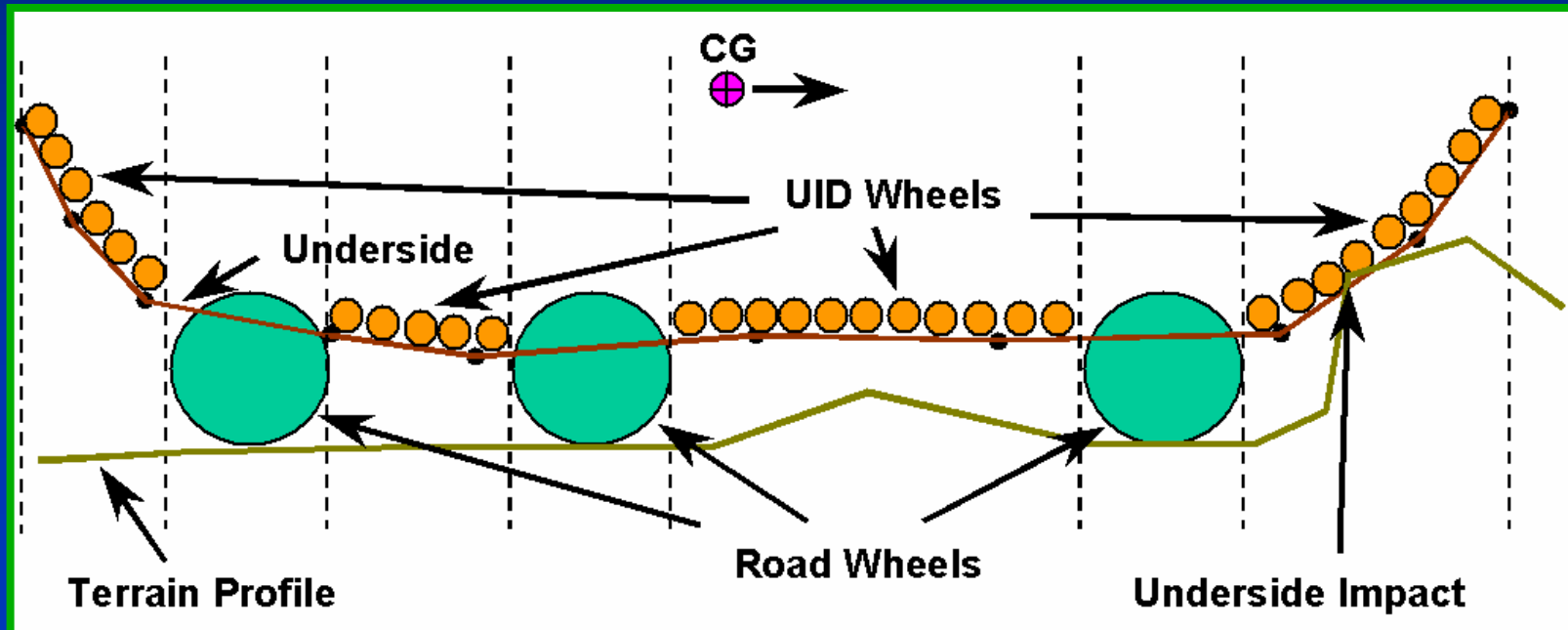
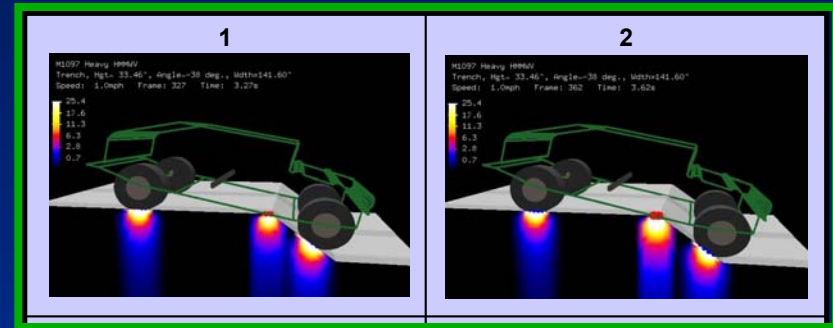

US Army Engineer Research & Development Center



One Corps, One Regiment, One Team . . . Serving Soldiers, the Army, the Nation





# Gap Crossing Verification

- Vehicle accelerates to 2 mph
- Chassis changes color based on tractive force relationship
- Terrain deformation indicated by different colored lines



US Army Engineer Research & Development Center



One Corps, One Regiment, One Team . . . Serving Soldiers, the Army, the Nation



# VCI Verification

- Vehicle accelerates to 10 mph
- Chassis changes color based on tractive force relationship
- Terrain deformation indicated by different colored lines



US Army Engineer Research & Development Center



One Corps, One Regiment, One Team . . . Serving Soldiers, the Army, the Nation



# Hard Surface Slope Verification

US Army Engineer Research & Development Center

- **DB = Drawbar**
  - Drawbar pull relationship is used to calculate the “theoretical” maximum slope

<i>Slope Climbing (Percent)</i>		
<i>Vehicle</i>	<i>VGAP</i>	<i>DB Slope</i>
M1097 (HMMWV)	81.6	75.5
M1078 (LMTV)	81.3	75.5
LAV	75.8	75.4
M923	68.0	73.5
M977 (HEMTT)	63.7	74.9
M113	81.6	104.2
M2A2 (BFV)	73.4	104.3
M1A1	78.5	104.1



One Corps, One Regiment, One Team . . . Serving Soldiers, the Army, the Nation



# Fine Grain VCI1 Verification

US Army Engineer Research & Development Center

- Vehicle Cone Index  $x$  (VCI $x$ ) is the minimum soil strength required to support the vehicle for  $x$  number of passes
- Soil strength is measured in terms of Remolded Cone Index (RCI)
- Typical field test variation is +/- 3 RCI points
- NRMM is a validated vehicle model for calculating VCI $x$

Computed Fine Grain VCI1		
	VGAP	NRMMII
M1097 (HMMWV)	20	22.2
M1078 (LMTV)	26	27.1
LAV	32	30.2
M923	17	29.7
M977 (HEMTT)	33	32.1
M113	16	15.2
M2A2 (BFV)	20	18.5
M1A1	26	25.3



One Corps, One Regiment, One Team . . . Serving Soldiers, the Army, the Nation



# Coarse Grain VCI1 Verification

US Army Engineer Research & Development Center

- Vehicle Cone Index  $x$  (VCI $x$ ) is the minimum soil strength required to support the vehicle for  $x$  number of passes
- Soil strength is measured in terms of Cone Index (CI)
- Typical field test variation is +/- 3 RCI points
- NRMM is a validated vehicle model for calculating VCI $x$

Computed Coarse Grain (SP) VCI1		
	VGAP	NRMMII
M1097 (HMMWV)	47	33.6
M1078 (LMTV)	58	46.1
LAV	70	66.2
M923	47	51.4
M977 (HEMTT)	32	40.5
M113	1	0.4
M2A2 (BFV)	1	0.3
M1A1	1	0.4



One Corps, One Regiment, One Team . . . Serving Soldiers, the Army, the Nation





# Where We're At Now

US Army Engineer Research & Development Center

M1 ABRAMS MAINBATTLE TANK  
Demo Terrain  
Speed: 1.6mph Frame: 1 Time: 0.01s

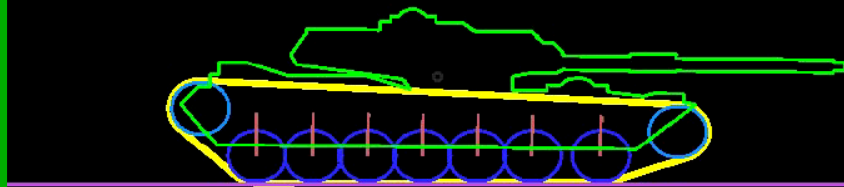

M1097 Heavy HMMWV  
Demo Terrain  
Speed: 0.6mph Frame: 1 Time: 0.03s

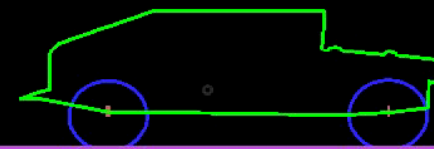

- Tire/Track interaction with deformable soil relationships based on soil type and strength
  - Soil strengths changes along the simulated profile
- Vehicles are driven by soil adjusted tractive-force relationship
- Variable forward acceleration
- Vehicle Underside Impact Detection



*One Corps, One Regiment, One Team . . . Serving Soldiers, the Army, the Nation*



# VGAP Interface

US Army Engineer Research & Development Center

**Recon Data Gap**

File Help

Gap: Gaps Already Defined: [Ditch] Add New Gap

Inputs

Upload Soil File: C:\Vgap\_New\_dfR Browse View Soil Plot

Upload Geometry LADAR: C:\Vgap\_New\_dfG Browse View Geometry

Upload Water Sensor Data: Browse

Save Advanced Options Generate Gap Data File Perform Gap Analysis

**Initial Gap Input**

File Help

[Wet] Is the Gap wet or dry?

[Recon Data] Do you have recon data or do you want to perform analysis with a standard gap?

[Multiple Vehicles] Do you want to analyze a single vehicle crossing or multiple vehicles?

Name of Vehicles	Number of Vehicles	Convoy Order
M2A2 BFV	5	1
M977 HEMTT	6	1
M1A1	7	1
M113A1 APC	2	1
T2V	3	1

Add Vehicle Delete Vehicle

Continue

**Introduction**

# VGap

# GAP

**BATTLESPACE GAP DEFINITION AND DEFEAT**

## Vehicle Gap Analysis Program

View Gap Analysis Results Perform New Gap Analysis

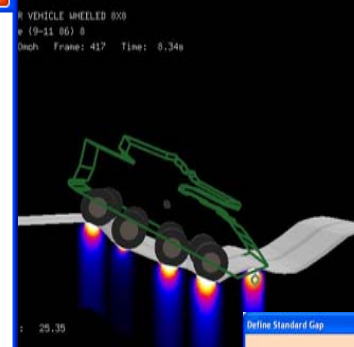

**Soil Strength Wizard**

For the typical soldier walking in the soil:

- No A footprint greater than 2-inches deep is observed.
- No A 2-inch deep footprint is observed.
- No A 1-inch deep footprint is observed.
- No A well defined footprint is observed.
- No A trace footprint is observed.

If the soldier does not leave a footprint he should try to penetrate the ground surface using the thumb:

- No The thumb easily penetrates the ground surface.

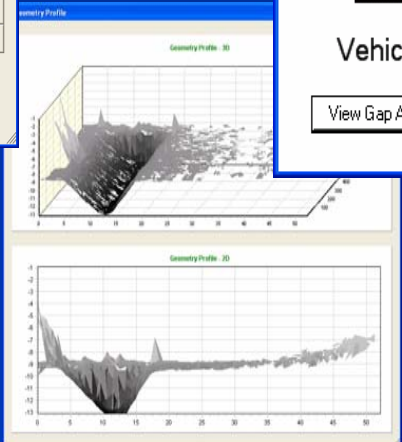

**Define Standard Gap**

Standard Gaps: [Standard]

Input Gap Properties

[SP - Coarse Gra] Soil Type Help Value Depth (ft)

[3] Soil Strength Help Value Velocity Help

Generate Data File Save Edit Cancel Perform Analysis

**Analysis**

Output

Mission Status:

Status	Name of Vehicle	Limiting Condition
●	M2A2 BFV	Vehicle completed profile
●	M2A2 BFV	Insufficient traction to overcome soil/slope resistance

View Animation Save Results Assess Defeat Options



One Corps, One Regiment, One Team . . . Serving Soldiers, the Army, the Nation



# Conclusions

US Army Engineer Research & Development Center

- A set of equations and methodologies have been presented that were used to create a new vehicle mobility analysis tool
- This terrain mechanics modeling approach is based on algorithms for whole wheel tests (soil bin) and full vehicle field tests
- This approach is expected to yield representative performance (longitudinal traction, resistance and sinkage) for vehicles in a dynamic simulated environment
- The terrain mechanics model is applicable to a variety of simulation environments and on-board robotic decision logic



*One Corps, One Regiment, One Team . . . Serving Soldiers, the Army, the Nation*