

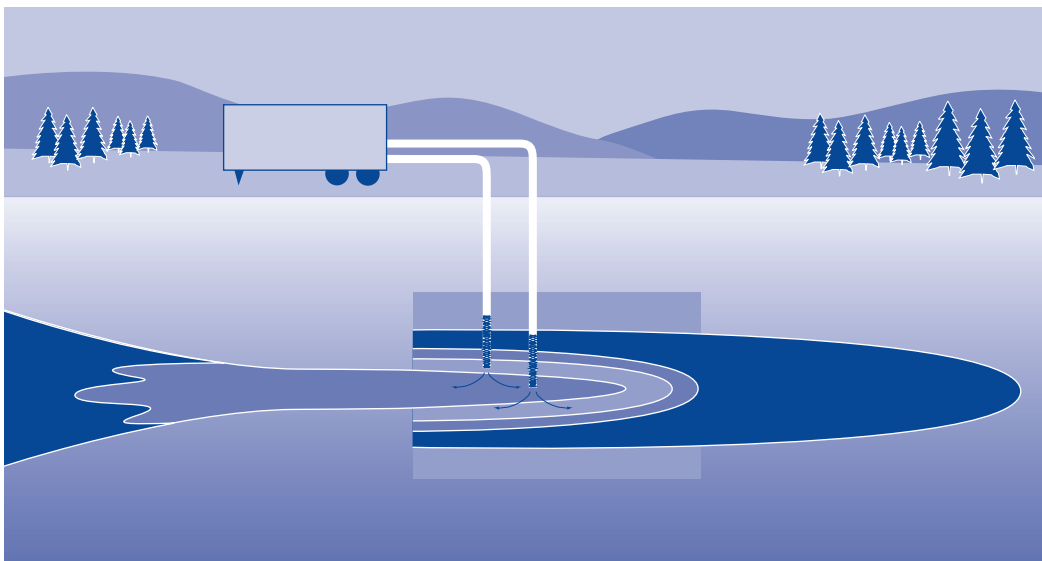

# Technical/Regulatory Guidelines

## A Systematic Approach to In Situ Bioremediation in Groundwater

### Including Decision Trees on In Situ Bioremediation for Nitrates, Carbon Tetrachloride, and Perchlorate



August 2002

Prepared by  
Interstate Technology and Regulatory Council  
In Situ Bioremediation Team

Copyright 2002 Interstate Technology and Regulatory Council

# Report Documentation Page

Form Approved  
OMB No. 0704-0188

Public reporting burden for the collection of information is estimated to average 1 hour per response, including the time for reviewing instructions, searching existing data sources, gathering and maintaining the data needed, and completing and reviewing the collection of information. Send comments regarding this burden estimate or any other aspect of this collection of information, including suggestions for reducing this burden, to Washington Headquarters Services, Directorate for Information Operations and Reports, 1215 Jefferson Davis Highway, Suite 1204, Arlington VA 22202-4302. Respondents should be aware that notwithstanding any other provision of law, no person shall be subject to a penalty for failing to comply with a collection of information if it does not display a currently valid OMB control number.

1. REPORT DATE <b>01 AUG 2002</b>		2. REPORT TYPE <b>N/A</b>		3. DATES COVERED <b>-</b>	
4. TITLE AND SUBTITLE <b>A Systematic Approach to In Situ Bioremediation in Groundwater Including Decision Trees on In Situ Bioremediation for Nitrates, Carbon Tetrachloride, and Perchlorate</b>				5a. CONTRACT NUMBER	
				5b. GRANT NUMBER	
				5c. PROGRAM ELEMENT NUMBER	
6. AUTHOR(S)				5d. PROJECT NUMBER	
				5e. TASK NUMBER	
				5f. WORK UNIT NUMBER	
7. PERFORMING ORGANIZATION NAME(S) AND ADDRESS(ES) <b>Interstate Technology and Regulatory Council In Situ Bioremediation Team</b>				8. PERFORMING ORGANIZATION REPORT NUMBER	
9. SPONSORING/MONITORING AGENCY NAME(S) AND ADDRESS(ES)				10. SPONSOR/MONITOR'S ACRONYM(S)	
				11. SPONSOR/MONITOR'S REPORT NUMBER(S)	
12. DISTRIBUTION/AVAILABILITY STATEMENT <b>Approved for public release, distribution unlimited</b>					
13. SUPPLEMENTARY NOTES <b>The original document contains color images.</b>					
14. ABSTRACT					
15. SUBJECT TERMS					
16. SECURITY CLASSIFICATION OF:			17. LIMITATION OF ABSTRACT <b>UU</b>	18. NUMBER OF PAGES <b>158</b>	19a. NAME OF RESPONSIBLE PERSON
a. REPORT <b>unclassified</b>	b. ABSTRACT <b>unclassified</b>	c. THIS PAGE <b>unclassified</b>			

## **ABOUT ITRC**

Established in 1995, the Interstate Technology and Regulatory Council (ITRC) is a state-led, national coalition of personnel from the regulatory and technology programs of some 40 states and the District of Columbia; three federal agencies; and tribal, public, and industry stakeholders. The organization is devoted to reducing barriers and speeding interstate deployment of better, more cost-effective, innovative environmental technologies.

Various tools have been developed and services provided by ITRC to accomplish this goal. ITRC **Technical/Regulatory Guidelines**, each of which deals with a specific type of technology, enable faster, more thorough reviews by state agencies of permit applications and site investigation and remediation plans for full-scale deployment of such technologies. Use of these documents by states in their regulatory reviews also fosters greater consistency in technical requirements among states and results in reduced fragmentation of markets for technologies caused by differing state requirements.

Those who conduct and oversee demonstrations and verifications of technologies covered by ITRC Technical/Regulatory Guidelines will also benefit from use of the documents. By looking ahead to the typical technical requirements for permitting/approving full-scale deployment of such technologies, they can collect and evaluate information to facilitate and smooth the permitting/regulatory approval process for deployment.

ITRC also has developed products in the categories of **Case Studies** and **Technology Overviews** (including regulatory information reports, state surveys, closure criteria documents, and formats for collection of cost and performance data); provided state input into other complementary efforts; and worked on approaches to enable state regulatory agencies to accept performance data gathered in another state as if the testing had been done in their own state.

More information about ITRC and its available products and services can be found on the Internet at [www.itrcweb.org](http://www.itrcweb.org).

## **DISCLAIMER**

ITRC does not endorse the use of, nor does it attempt to determine the merits of, any specific technology or technology provider through publication of any ITRC documents; nor does it assume any liabilities with respect to the use of, or for damages resulting from the use of, any information, apparatus, method, or process discussed in this document. Mention of trade names or commercial products does not constitute endorsement or recommendation of use. These documents are designed to help regulators and others develop a consistent approach to their evaluation, regulatory approval, and deployment of specific technologies at specific sites. The Internet Web sites referenced in this document may become outdated or be changed over time.

**A Systematic Approach to *In Situ* Bioremediation in  
Groundwater**

**Including  
Decision Trees for *In Situ* Bioremediation of  
Nitrates, Carbon Tetrachloride, and Perchlorate**

**August 2002**

**Prepared by  
Interstate Technology and Regulatory Council  
In Situ Bioremediation Team**

**Copyright 2002 Interstate Technology and Regulatory Council**

This page intentionally left blank.

## ACKNOWLEDGMENTS

The members of the Interstate Technology and Regulatory Council (ITRC) In Situ Bioremediation Team wish to acknowledge the individuals, organizations, and agencies that contributed to this guidance document.

The In Situ Bioremediation Team effort, as part of the broader ITRC effort, is funded primarily by the U.S. Department of Energy (DOE). Additional funding and support has been provided by the U.S. Department of Defense (DoD) and the U.S. Environmental Protection Agency (EPA). Administrative support for grants is provided by the Environmental Research Institute of the States (ERIS), a nonprofit educational subsidiary of the Environmental Council of the States (ECOS). The Western Governors' Association (WGA) and the Southern States Energy Board (SSEB), who previously held secretariat duties for ITRC, remain involved.

The team recognizes the following states' support of team leadership and guidance preparation:

- New Mexico Environment Department, Bart Faris – Team leader
- North Dakota Department of Health, Kris Roberts – Subteam leader
- Missouri Department of Natural Resources – Candice McGhee
- Oklahoma Department of Agriculture – Jim Shirazi
- Colorado Department of Public Health and Environment – Clay Trumpolt
- Kansas Department of Health and Environment – Donna Porter
- Virginia Department of Environmental Quality – Hassan Vakili
- New Hampshire Department of Environmental Services – Fred McGarry

The team also recognizes the exemplary efforts of Dr. Eric Nuttall from the University of New Mexico and Dr. Roy Spalding from the University of Nebraska. We also wish to thank industry representatives, who bring the necessary pragmatism and guidance to the team, including Dupont, MSE, Envirogen, Burns and McDonnell, Geotec, Profind, EnviroMetal, Papadopoulos and Associates, Concurrent Technologies Corporation, Research Triangle Institute, and Aerojet and Bioprocess. Other unnamed members also contributed valuable perspectives with their advice throughout the project. The U.S. Department of Defense added several perspectives, including those of Goeff Cullison from the Navy, and few ITRC guidance documents have been without the tireless support of Linda Fiedler from the Technology Innovation Office of EPA. Los Alamos National Laboratory and Sandia National Laboratories contributed research and case study information. Thanks also to Steve Hill, ITRC program advisor and president of RegTech, Inc., for urging constant progress during development of the guidance and assisting wherever necessary. As she did with the Enhanced In Situ Bionitrification Technology Overview, Anne Williams Callison added the perspective of the community stakeholder to the guidance.

Lastly, without the leadership, common sense, and enthusiastic drive of Bart Faris (New Mexico) and his Perchlorate Subteam Leader Kris Roberts (North Dakota), this guidance would not have been prepared. They spent many hours of their own time researching the literature, writing sections of the report, reviewing drafts, and planning conference calls and meetings. They are the cohesive force of the team, and the substance of the guidance is much better due to their efforts.

This page intentionally left blank.

## EXECUTIVE SUMMARY

Applications submitted to regulatory authorities containing *in situ* bioremediation have not been prepared nor evaluated using a consistent and accepted suite of parameters. The ITRC In Situ Bioremediation (ISB) Team prepared this document to provide guidance for the systematic characterization, evaluation, and appropriate design and testing of ISB for any biotreatable contaminant. It serves as guidance for regulators, consultants, responsible parties, and stakeholders when an ISB technology is considered.

The ISB Team is composed of eight state environmental agencies (New Mexico, North Dakota, Missouri, Oklahoma, Colorado, New Hampshire, Kansas, and Virginia), three federal agencies (DOE, DoD, and EPA), 12 companies, two universities, and public stakeholders. ITRC has produced a number of products related to ISB, which are available at ITRC's Web site ([www.itrcweb.org](http://www.itrcweb.org)).

Bioremediation is the application of biological treatment to the cleanup of contaminants in groundwater. Bioremediation melds an understanding of microbiology, chemistry, hydrogeology, and engineering into a cohesive strategy for planned and controlled microbial degradation of specific classes of organic compounds and in certain instances, inorganic compounds. This assemblage of science and engineering requires a rigorous degree of data evaluation to determine the effect and efficiency of bioremediation.

*In situ* bioremediation creates subsurface environmental conditions, typically through oxidation-reduction manipulation, which induce the degradation of chemicals (i.e., the target chemical) via microbial catalyzed biochemical reactions. In turn, the microbes produce enzymes that are utilized to derive energy and that are instrumental in the degradation of target chemicals. To accomplish this chain of events, the following aspects must be considered:

- type of microorganisms,
- type of contaminant, and
- geological conditions at the site.

Since *in situ* conditions are manipulated by engineered means, the most important consideration is the ability to transmit and mix liquids in the subsurface.

In response to ITRC's and California's requests for clarification of RCRA, EPA's director of the Office of Solid Waste clarified EPA's policy on the injection of contaminated groundwater by explaining that reinjection of treated groundwater to promote *in situ* treatment is allowed under 3020(b) as long as...the groundwater is treated prior to reinjection; the treatment is intended to substantially reduce the hazardous constituents in the groundwater before or after reinjection; the cleanup must be protective; and the injection must be part of a response action under CERCLA or RCRA. In addition, if the injected fluid contains a hazardous waste, and the fluid is being injected into an aquifer, an exception to the usual prohibition of Class IV Underground Injection Control wells is available for CERCLA and RCRA cleanups. The ISB Team of ITRC concludes from the reviews conducted as part of this project, there are no regulatory barriers preventing the full use of *in situ* bioremediation to remediate nitrate, carbon tetrachloride, and perchlorate.



All indications point to enhanced *in situ* biodenitrification as a reasonable remediation alternative for nitrate- ( $\text{NO}_3$ ) contaminated groundwater. The decision tree in Section 8.0 of this guidance provides the user a process of evaluating the applicability of enhanced *in situ* biodenitrification. The first step is to define site oxidation-reduction potential (ORP) (see Section 3.1.1 and Figure 3-1). ORP measurements are taken to determine which constituent will be the electron acceptor. Nitrate may serve as an electron acceptor at an ORP value of approximately 750 mv, after oxygen has been depleted. If ORP is less than 750 mv, it is likely that  $\text{NO}_3$  will not be present in groundwater since it has already denitrified to nitrogen ( $\text{N}_2$ ) gas. If the dissolved oxygen concentration is above 2.0 mg/L, it needs to be reduced, which can be achieved by adding additional carbon to the treatment area.

Dechlorination and cometabolism are two major reductive pathways for ISB of carbon tetrachloride (CT). The cometabolic pathway occurs either through reductive dechlorination or denitrification. The first decision tree in Section 9.0 of this guide describes reductive dechlorination through direct or cometabolic reduction, while the second decision tree describes a reductive denitrification-cometabolic pathway. The key to the dechlorination pathway is the recognition of degradation products and the ability to carry this reduction to completion so neither contaminants nor degradation products are above site closure criteria. Treatability tests can determine if the necessary halorespirers are present to affect degradation.

The reductive cometabolic dechlorination pathway yields degradation products through cometabolic processes and not by serving as electron acceptors. They are produced fortuitously when biologically produced enzymes or cofactors degrade carbon tetrachloride during the microbial consumption of an alternate carbon source. The reductive cometabolic denitrification pathway yields little to no degradation products.

Section 10.0 provides a decision pathway assessing the reductive pathway for *in situ* bioremediation of perchlorate ( $\text{ClO}_4$ ) in groundwater. More than 30 different strains of perchlorate-reducing microbes have been isolated from diverse environments. In this reductive process, bacteria utilize the perchlorate ion as a terminal electron acceptor. Perchlorate is ultimately completely converted into chloride and oxygen through the anaerobic reduction process. The perchlorate-to-chlorate step is thought to be the rate-limiting step, being considerably slower than the other steps. Buildup of toxic intermediates, specifically chlorite, does not occur as the chlorite-to-chloride step proceeds at a rate on the order of 1000 times that of the accepted rate-limiting step.

Contaminants and breakdown products differ; however, many characteristics of a site used to determine the efficacy of ISB are similar. Once a site has been characterized and the contaminants of concern and daughter products have been defined, engineered approaches can be designed, pilot tested, and deployed. Flow diagrams define the primary decision points and characteristics evaluating ISB either through monitored natural attenuation (MNA) or enhanced ISB.

# TABLE OF CONTENTS

ACKNOWLEDGMENTS .....	i
EXECUTIVE SUMMARY .....	iii
1.0 PROBLEM STATEMENT.....	1
1.1 Introduction.....	1
1.2 Purpose of This Product.....	2
1.3 What is ISB? .....	3
2.0 SITE BACKGROUND.....	7
2.1 Site Operational History .....	9
2.2 Contaminant Sources/Pervasiveness.....	9
2.3 Contaminant Properties.....	9
2.4 Contaminant Relationships .....	10
2.5 Standards.....	10
3.0 SITE DESCRIPTION / CHARACTERIZATION.....	10
3.1 Hydrogeology .....	11
3.2 Geochemistry .....	14
3.3 Contaminant Transformations/Microorganisms .....	21
3.4 Receptors.....	24
4.0 FATE AND TRANSPORT.....	25
4.1 Stoichiometry .....	25
4.2 Kinetics .....	26
4.3 Modeling.....	27
4.4 Feasibility.....	31
5.0 <i>IN SITU</i> BIOREMEDIATION FULL-SCALE IMPLEMENTATION.....	37
5.1 Economics.....	38
5.2 Site Specificity .....	38
5.3 Risks/Liability.....	39
5.4 Performance Monitoring.....	39
6.0 LIMITATIONS.....	39
7.0 ISSUES AND SOLUTIONS .....	40
7.1 Federal Regulations and Policies .....	40
7.2 State Regulations and Policies .....	43
7.3 <i>In Situ</i> Bioremediation Successes .....	44
7.4 Public Comments/Concerns.....	44
7.5 Contingency Plans for ISB.....	45
7.6 Health and Safety Issues .....	46
7.7 Site Closure Criteria.....	46

8.0	A SYSTEMATIC APPROACH TO <i>IN SITU</i> BIOREMEDIATION OF NITRATE	47
8.1	Pervasiveness of Nitrate Contamination	49
8.2	Contaminant Background	49
8.3	Site Description/Characterization	52
8.4	Fate and Transport	57
8.5	EISB Alternatives	66
8.6	Applicability of EISBD	66
9.0	A SYSTEMATIC APPROACH TO <i>IN SITU</i> BIOREMEDIATION OF CARBON TETRACHLORIDE	66
9.1	Decision Tree	66
9.2	Contaminant Background	72
9.3	Site Description/Characterization	78
9.4	Fate and Transport	87
9.5	Limitations	92
9.6	Issues and Solutions	92
10.0	A SYSTEMATIC APPROACH TO <i>IN SITU</i> BIOREMEDIATION OF PERCHLORATE	92
10.1	Purpose	92
10.2	Pervasiveness of Perchlorate Contamination	94
10.3	Contaminant Background	95
10.4	Regulatory Standards/Guidance	101
10.5	Site Description/Characterization	102
10.6	Fate and Transport	105
10.7	Biofouling	107
10.8	Alternatives to <i>In Situ</i> Perchlorate Treatment	107
11.0	REFERENCES	113
12.0	ADDITIONAL READING REFERENCES	128

### LIST OF TABLES

Table 3-1.	Suggested Analytes for Bioremediation	18
Table 6-1.	Advantages and Limitations of ISB	40
Table 7-1.	State Regulatory Requirements for ISB	43
Table 8-1.	Properties of Nitrate Compounds	51
Table 8-2.	Analytes Important in Evaluating <i>In Situ</i> Bioremediation of Nitrate	53
Table 8-3.	Carbon Amendments Necessary to Completely Denitrify an Aqueous Concentration of 1 Mg/L Nitrate	58
Table 8-4.	Aboveground Denitrification Scale-up Tests Using Indigenous Groundwater Bacteria	60
Table 8-5.	Comparison of Average Denitrification Rates Using Acetate and TMP as Amendments	62

Table 9-1.	Properties of Carbon Tetrachloride.....	74
Table 9-2.	Selected State Groundwater Standards .....	77
Table 9-3.	Analytes Important in Evaluating <i>In Situ</i> Bioremediation of Carbon Tetrachloride .....	81
Table 9-4	Field Parameters Important in Evaluating <i>In Situ</i> Bioremediation of Carbon Tetrachloride .....	81
Table 10-1	Properties of Perchlorate Compounds .....	98
Table 10-2	Partial List of Characterized Perchlorate Contaminated Sites with Listed Co-contaminants .....	100
Table 10-3	Standards and Guidance Concentration Levels Currently Set for Perchlorate in the Environment .....	101
Table 10-4	Analytes Important for Evaluating <i>In Situ</i> Bioremediation of Perchlorate....	103
Table 10-5	Pilot-scale Studies, Thiokol Demonstration Site at Brigham City, Utah.....	109
Table 10-6	Pilot-scale Studies, Big Dalton, California.....	111

## LIST OF FIGURES

Figure 1-1	<i>In Situ</i> Bioremediation in Groundwater Decision Tree .....	4
Figure 2-1	Site Characterization Block Diagram .....	8
Figure 3-1	Estimated ORP of Commonly Monitored Chemical Species.....	16
Figure 3-2	Idealized Terminal Electron Acceptor Process.....	17
Figure 4-1	Field Demonstration System Schematic Example.....	35
Figure 8-1	Bioremediation of Nitrates in Groundwater .....	48
Figure 8-2	Partial Eh-pH Diagram of the N-O-S-H System.....	55
Figure 8-3	Design of an <i>In Situ</i> Denitrification Test at Tri-Tech Site, Albuquerque’s South Valley.....	60
Figure 8-4	Reaction Concentration Curves Resulting from Short-term Monitoring during and after an <i>In Situ</i> Denitrification Test .....	61
Figure 8-5	Reaction Concentration Curves Measured during an <i>In Situ</i> Bioremediation Test.....	62
Figure 8-6	Modified Schematic Diagram of a Continuous Denitrification Field Test.....	63
Figure 8-7	Continuous Larger-scale Pilot Demonstration.....	63
Figure 8-8	Analytical Results of Nitrate and Nitrite Concentrations in a Shallow Monitor Well following Continuous Injection at a Pilot-scale Demonstration.....	64
Figure 9-1	Bioremediation of Carbon Tetrachloride in Groundwater (Reductive Dehalogenation Decision Tree) .....	68
Figure 9-2	Bioremediation of Carbon Tetrachloride in Groundwater (Denitrification/Cometabolic Mineralization) .....	71
Figure 9-3	Half-reactions for Redox of Halogenated Aliphatic Compounds.....	80
Figure 9-4	Carbon tetrachloride/CF/DCM Degradation Pathways .....	83
Figure 9-5	Hypothetical Reduction of Carbon Tetrachloride with Degradation Products.....	84
Figure 10-1	Bioremediation of Perchlorate in Groundwater .....	93
Figure 10-2	Perchlorate Manufacturers and Users .....	94

Figure 10-3 States with Reported Releases of Perchlorate.....96  
Figure 10-4 Relative ORP for Associated Degradation Processes.....103

## **APPENDICES**

APPENDIX A Acronyms  
APPENDIX B Soil Screening Guidelines for Carbon Tetrachloride  
APPENDIX C ITRC Contacts, ITRC Fact Sheet, ITRC Product List, and User Survey

# A SYSTEMATIC APPROACH TO *IN SITU* BIOREMEDIATION IN GROUNDWATER

## 1.0 PROBLEM STATEMENT

*In situ* bioremediation (ISB) technologies are gaining wide acceptance as viable and economic remediation technologies for contaminated groundwater. The ITRC ISB Team has developed this systematic approach to evaluate the feasibility and effectiveness of ISB technologies with the expectation that it can be applied to any specific contaminant or site. However, applications involving ISB submitted to regulatory authorities have not been prepared or evaluated using a consistent and accepted suite of parameters and their acceptable values, leading to inefficient and inconsistent methods of decision making. The ISB Team has prepared this document to provide guidance for the systematic characterization, evaluation, and appropriate design and testing of ISB for any biotreatable contaminant. This document is intended to serve as guidance for regulators, consultants, responsible parties, and stakeholders when an ISB technology is considered.

### 1.1 Introduction

In 2001, an ISB Team was reformed by consolidation of the Enhanced In Situ Biotreatment (EISBD) Team, the 2002 Carbon Tetrachloride (CT) Team, and the 2002 Perchlorate ( $\text{ClO}_4$ ) Team to evaluate and develop a *Systematic Approach to In Situ Bioremediation in Groundwater*. This document presents a flow path that defines parameters and criteria leading to decision points for deployment of ISB in general. Separate modules are included for nitrate ( $\text{NO}_3$ ), carbon tetrachloride, and perchlorate contamination. The ISB Team decided to evaluate three proposed contaminants with this systematic approach for the following reasons:

Nitrate-contaminated groundwater is the most pervasive groundwater contaminant in the United States. Because nitrate-contaminated groundwater's only proven health effect, methemoglobinemia (blue baby syndrome), is not perceived as a grave health threat, nitrate-contaminated groundwater is not treated as a contaminant of high concern. Also, nitrate is not regulated pursuant to the Resource Conservation and Recovery Act (RCRA) or the Comprehensive Environmental Response, Compensation, and Liability Act (CERCLA). Nitrate is, however, regulated in public water supplies as a primary contaminant of concern under the federal Safe Drinking Water Act. Nitrate contamination is usually treated at the wellhead, if at all, and little is done to treat the contributing groundwater contamination. These plumes are typically associated with agricultural fertilization, human and animal wastes, explosives, mining and mineral processing, and industrial use of nitrogen chemicals (i.e., nitric acid). Many nitrate plumes are considered nonpoint sources, and responsible parties cannot be identified. Furthermore, runoff of nitrate-rich water and contribution of nitrate-contaminated groundwater to surface waters has had a significant impact on the waterways of the United States, causing eutrophication and hypoxia.

Carbon tetrachloride has historically been used as a fumigant in grain storage silos and has been identified in agricultural areas as a pervasive contaminant in

groundwater. Carbon tetrachloride and some of its degradation products are considered carcinogens or suspected carcinogens and are regulated releases. Many carbon tetrachloride plumes are found commingled with nitrate plumes, and the relationship of these two contaminants is important to ISB systems.

Perchlorate has been documented in groundwater in many states and is commonly associated with use of propellants and oxidants. The health consequences of perchlorate contamination have yet to be determined since national health-based standards do not exist. After standards are established, application of ISB remediation technologies for perchlorate is expected to increase.

The ISB Team of ITRC is comprised of representatives from state environmental agencies (New Mexico, North Dakota, Missouri, Oklahoma, Colorado, New Hampshire, Kansas, and Virginia), federal agencies (DOE, DoD, and EPA), environmental companies, two universities, and public stakeholders. This team effort represents a continuation of earlier efforts by the previous ITRC ISB Team and the EISBD Team. Furthermore, the current ISB Team includes ITRC members interested in carbon tetrachloride and perchlorate. ITRC has produced numerous products related to ISB, including *Natural Attenuation of Chlorinated Solvents in Groundwater: Principles and Practices*, along with associated classroom and Internet training; *Technical and Regulatory Requirements for Enhanced In Situ Bioremediation of Chlorinated Solvents in Groundwater*, with classroom and Internet training on accelerated *in situ* bioremediation of chlorinated solvents; and *Technology Overview of Enhanced In Situ Biotenitrification*. Descriptions and downloadable copies of all ISB documents published to date plus notices of future classroom and Internet training dates are available at ITRC's Web site ([www.itrcweb.org](http://www.itrcweb.org)).

## 1.2 Purpose of This Product

This document presents a decision tree for reviewing, planning, evaluating, and approving ISB systems in the saturated subsurface. It defines site parameters and appropriate ranges of criteria necessary for characterization, testing, design, and monitoring of ISB technologies. Contaminants and breakdown products differ; however, many characteristics of a site used to determine the efficacy of ISB are similar. Once a site has been characterized for ISB efficacy and the contaminants of concern and degradation products have been defined, engineered approaches can be designed, pilot tested, and possibly deployed. Similarly, several aspects of ISB are characteristic of all sites, regardless of the contaminant that is being scrutinized. This document describes the information needed for any ISB evaluation. Natural attenuation (NA) is the process of characterizing a site to understand the effectiveness of the natural processes. If these processes will achieve remediation goals in a reasonable time frame, then monitored natural attenuation (MNA) can be chosen, and no further engineered actions are taken other than designing an adequate monitoring system. If NA does not remediate a site adequately, then enhancements are made to that system to accelerate it. If the natural capacity of the subsurface is not understood, it is impossible to effectively enhance that same environment to accelerate ISB. A flow diagram (Figure 1-1) defines the primary decision points and provides characteristics used to evaluate MNA and enhanced ISB application as remediation options. The flow diagram, which follows, references the sections where each element is more thoroughly discussed in the body of the document. When viewing the flow diagram electronically, simply click on the box in the flow diagram to proceed directly to the section of interest in the document for further review.

This project precedes other ITRC documents by providing a template for making decisions on proposed ISB projects. It further provides decision modules evaluating the efficacy of ISB for nitrate, carbon tetrachloride, and perchlorate. After following the flow diagram in Figure 1-1, click on the Go To boxes for the specific contaminant. You will immediately be transferred to that decision tree and accompanying text.

### 1.3 What Is *In Situ* Bioremediation?

Bioremediation is the application of biological treatment to the cleanup of contaminants of concern. It requires the control and manipulation of microbial processes in surface reactors or in the subsurface for *in situ* treatment.

Basically, bioremediation melds an understanding of microbiology, chemistry, hydrogeology, and engineering into a cohesive strategy for controlled microbial degradation of specific classes of organic compounds and, in certain instances, inorganic compounds as well. This assemblage of science and engineering requires a rigorous degree of data evaluation to determine the effect and efficiency of bioremediation.

ISB entails the creation of subsurface environmental conditions conducive to the degradation of chemicals (i.e., the target chemical) via microbial catalyzed biochemical reactions. This is a technical way of saying that certain microbes can degrade specific chemicals in the subsurface by optimizing their environmental conditions (which causes them to grow and reproduce) (Cookson, 1995). In turn, the microbes produce enzymes that are utilized to derive energy and that are instrumental in the degradation of target chemicals. In order to accomplish this chain of events, several crucial aspects must converge, according to the National Research Council (NRC, 1993):

- the type of microorganisms,
- the type of contaminant, and
- the geological conditions at the site.

Once converged, such conditions accelerate microbial activity that, in turn, cause target chemical “biological” destruction. This bioremediation solution yields an elegant and cost-effective way to attack chemicals in the environment using naturally occurring microbes.



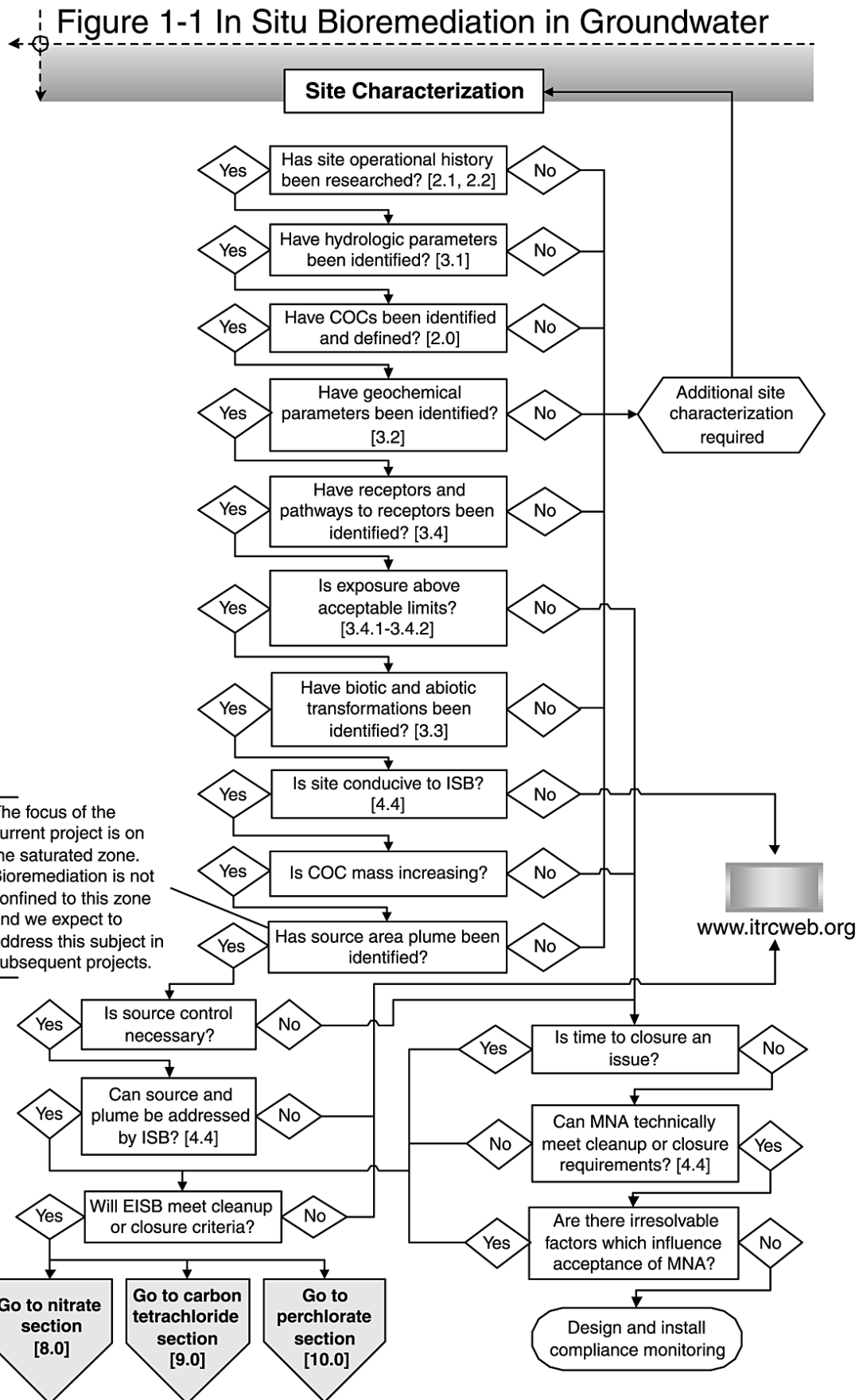

### 1.3.1 Microorganisms (or microbes)

The basic premise of bioremediation is to accelerate microbial activity using nutrients (i.e., phosphorus, nitrogen) and substrate (i.e., food) to create conditions conducive to biodegradation of a target chemical or contaminant. This is not new. Sanitary engineers understood the implications of bioremediation as early as the turn of the 20<sup>th</sup> century when the first vestiges of the common sewage treatment plant were first recognized, applied, and utilized for treatment of raw human excrement (i.e., sewage). These engineers recognized that controlled aeration of sewage would cause a decrease in odor and offensiveness. They also observed that the effluent from such treatment could be easily settled (i.e., clarified) and then discharged to a watercourse without the detrimental effects of the original raw sewage. This was one of the first applications of engineered bioremediation systems to enhance environmental conditions.

What these engineers discovered was that microbial conditions could be optimized through an engineered approach that resulted in biodegradation of the obnoxious organic matter and also produced positive impacts on the over all environment. But to accomplish such an effect, a more precise understanding of microbes and microbial processes needed to be developed.

Microorganisms (or microbes) are microscopic organisms that have a natural capability to degrade or destroy a wide range of organic and inorganic chemicals. Such microbes and the processes by which such degradation occurs are important to understand (see Section 3).

Microbes can use a variety of organic chemicals for their own growth and propagation. These organic chemicals may serve various functions but primarily may be used as either a carbon source for growth or as a source of electrons for energy.

Microbes extract energy via catalyzing energy-yielding biochemical reactions, thus enzymes produced by the microbe can cleave chemical bonds and assist in a transfer of electrons from a chemical compound. These types of reactions are termed oxidation-reduction reactions, where the organic chemical (contaminant) is oxidized (i.e., electrons are lost) and another chemical (or acceptor) gains electrons (or is reduced). For instance, many organic compounds can serve as an electron donor, such as benzene; while oxygen can serve as an electron acceptor. This is the classic aerobic respiration process. Here microbes “eat” benzene and “breathe” oxygen.



In this instance within the subsurface saturated zone, one would expect to observe a decrease in oxygen and the organic contaminant with a simultaneous increase in carbon dioxide. Such resultant biochemical signatures can be monitored.

On the other end of the spectrum are the anaerobic processes, those processes that function without oxygen. In such processes, nitrate, sulfate, iron, manganese, hydrogen, or carbon dioxide can function as an electron acceptor during the anaerobic degradation of organic contaminants. Such anaerobic respiration processes utilize inorganic chemicals as an electron acceptor. For example, anaerobic hydrogen-oxidizing bacteria can degrade (or dechlorinate) PCE to TCE with the release of a proton ( $\text{H}^+$ ) and chloride ion:



In the subsurface saturated zone, one would expect to observe a decrease in parent PCE compound with a concomitant increase in daughter product (TCE) and chloride ion. Depending on the specific subsurface environment, a decrease in pH may not be observed, particularly in the case of carbonate-rich formations that tend to rapidly neutralize the released hydronium ion ( $H^+$ ). Under extremely reducing conditions, one would expect to observe the complete reductive dechlorination of PCE to ethene.

### 1.3.2 Contaminant of Concern

The second important aspect to consider is whether, and to what extent, a contaminant of concern (COC) is amenable to biodegradation (see Sections 3 and 8 through 10). Some chemicals are easier to biodegrade than others by the variety of microorganisms found in the subsurface. In general, petroleum hydrocarbon compounds are relatively easy to biodegrade and have well-developed bioremediation processes. Other COCs, such as chlorinated compounds, were once thought to be recalcitrant but have received much more attention in the past five to 10 years. These chemicals are now viewed as amenable to bioremediation under appropriate engineered (or natural) conditions. Chlorinated compounds are degraded under a wide variety of conditions, which must be rigorously monitored to define effectiveness and efficiency.

### 1.3.3 Geological Environment

In the subsurface, numerous factors affect contaminant distribution. Here, the effects of the saturated zone are considered further (see Section 4).

Once a contaminant reaches the saturated zone and dissolves, advection and dispersion play major roles in the subsequent distribution in the subsurface. Advection is the movement of contaminants carried by groundwater in the direction of flow and is controlled by the linear velocity of the groundwater. That is, dissolved contaminants generally move in proportion to the groundwater velocity. Thus, an increase in groundwater velocity will result in farther travel of the contaminant. Dispersion is the “spreading out” of a contaminant plume and is composed of both molecular diffusion and mechanical mixing. Many factors affect dispersion, including pore size, path length, friction in the pores due to soil particles, and organic carbon content, which will affect the retardation of the COC, thus limiting dispersion of the subsurface matrix. As will be explained later in this document (see Section 4), important parameters for ascertaining subsurface effects include

- groundwater flow directions and velocities,
- transport parameters (dispersion coefficients),
- contaminant distribution and concentrations,
- degradation rates (kinetics),
- contaminant retardation, and
- biological process involved.

Moreover, since *in situ* conditions are manipulated by engineered means, one of the most important considerations is the ability to transmit liquids in the subsurface, because this is usually the targeted zone for engineered bioremediation system applications. For systems that circulate liquids in the subsurface, hydraulic conductivity is an important parameter. Generally, target zone hydraulic conductivity values on the order of  $10^{-4}$  cm/sec or greater are important

considerations, because one must be able to transmit liquids (i.e., bioremediation amendments) to the contaminant location.

As can be seen from the above synopsis, application of diverse scientific and engineering disciplines forms the underpinnings of ISB. It requires simultaneous evaluation of subsurface hydrogeology, contaminant interactions, and biology/biochemistry. It necessitates the ability to scientifically understand, predict, and monitor the collocation of contaminants, substrates, nutrients, and microbial processes *in situ* to achieve bioremediation. It is a system designed to establish optimized subsurface conditions, utilizing injected substrates and nutrients to enhance natural biodegradation, the ultimate result of which is accelerated destruction of the target contaminant and, hence, achievement of ISB.

## **2.0 SITE BACKGROUND**

Understanding the site background, contaminant history, and contaminant characteristics is required at any contaminated site prior to remediation. Figure 2-1, the site conceptual model block diagram, displays the elements discussed in following sections. This information is used to develop the site conceptual model (Section 4.3.1). A conceptual model is a representation of the physical, chemical, biochemical, and hydraulic characteristics of the subsurface as visualized from the site investigation. It represents the subsurface system in terms of hydrostratigraphic units, hydrologic boundary conditions, matrix type, water flow, contaminant concentration and distribution, and processes that affect the fate and transport of contaminants. Information and data specific to the site, contaminant, and geochemical and biochemical reactions must be understood and estimated in order to evaluate whether the contaminated site is amenable to ISB. Even if a contaminant is biodegradable, site conditions will govern overall biodegradation effectiveness in meeting remediation goals.

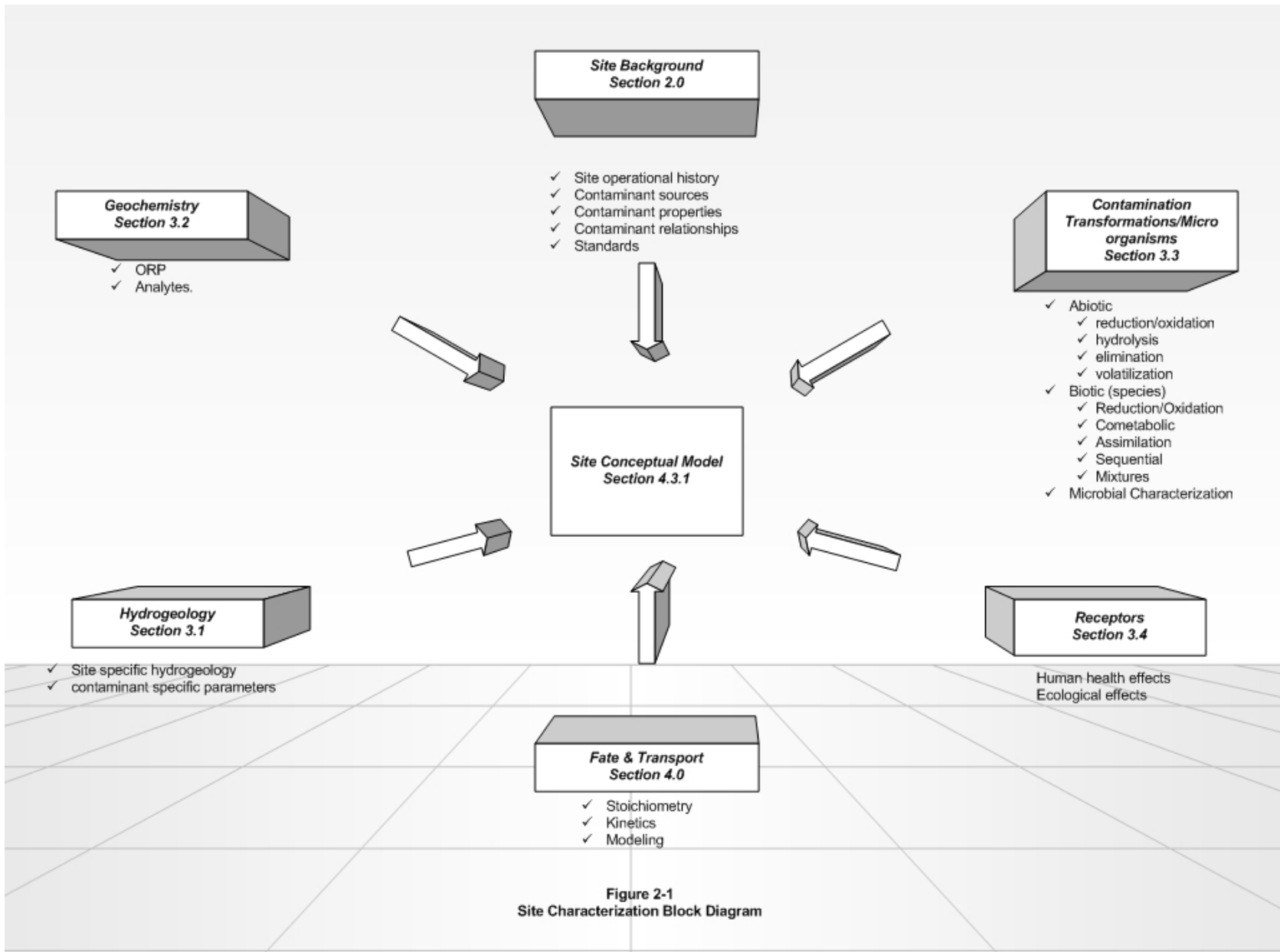

**Figure 2-1**  
**Site Characterization Block Diagram**

## 2.1 Site Operational History

The operational history of a site may reveal important information on the duration and intensity of operations at the site and historical use and management of chemicals and wastes leading to contamination of soils, subsurface sediments, or groundwater. Operational dates may provide information on the age of the contaminant plume. Records and anecdotal evidence lead investigators to source areas previously unknown, which if left unnoticed may result in unexpected design flaws during remediation. The type of industry, manufacturing, or business may reveal chemical relationships from its feedstock or products that mirror commingled contaminants in the subsurface. Information on historic production, raw materials, chemical products, use, handling, and disposal practices help determine the pervasiveness and problem scope.

## 2.2 Contaminant Sources/Pervasiveness

The operational dates of each potential contaminant source (release location/disposal location) must be documented to the best of the responsible party's (RP) ability. The concentration and volume plus any changes in the waste or effluent release stream over time is important when selecting and designing remediation options. Characteristics of the source are important when interpreting analytical results. Change in chemical characteristics contributing to the contaminant source may influence design decisions and operational parameters, as well as the conceptual model of the site. Site capping, source removal, or other physical or chemical changes in the source material or surrounding media can cause dramatic changes in the dimensions or chemical character of a contaminant plume.

## 2.3 Contaminant Properties

Contaminant physical and chemical properties, as they relate to ISB feasibility evaluation, should be understood. Contaminants can be classified as follows:

Organic	Inorganic
Volatile	Ions (i.e., nitrate, sulfate, perchlorate, ammonium)
Semivolatile	Metals
Nonvolatile	Radionuclides
Light or Dense Nonaqueous-Phase Liquids	

The contaminant's properties should be defined in terms of

- conditions at normal temperature and
- pressure,
- boiling point,
- specific gravity,
- water solubility,
- partition coefficients ( $\log K_{OW}$ ,  $\log K_{OC}$ ,  $K_d$ ),
- retardation,
- sorption,
- vapor pressure, and
- Henry's Law Constant.

Most of this information is readily available from material safety data sheet (MSDS) data and can easily be found on the Internet. The following links may be of assistance: [Syracuse Research Center](#), [Centers for Disease Control](#), [Speclab](#), [University of Minnesota](#), [United Nations](#)

[Environment Programme](#), [ChemFinder](#), [NTP Health and Safety Reports](#), [NIOSH](#), [TOXNET](#), and [MSDS](#).

## 2.4 Contaminant Relationships

If other compounds are present and commingled with the contaminant of concern, then the following questions should be asked:

- Will these commingled compounds enhance or inhibit ISB?
- Will the associated contaminant actively take part in the bioremediation equations?
- Are there cosolvency effects?
- Will the contaminant be toxic to the microorganisms through either direct or synergistic effects?
- Will transformation products be contaminants of concern?
- Will there be any other effects that may impact a decision to design an ISB remediation system?

## 2.5 Standards

Federal or state water quality standards, such as the federal Maximum Contaminant Levels (MCLs), or monitoring results indicating a waste or product has been released to groundwater is typically the underlying basis for a cleanup action. Cleanup targets may be these same water quality standards translated into a remedial action level, removal action level, or preliminary action level. Or the cleanup target may be based on a risk assessment (see Section 3.4).

The federal Safe Drinking Water Act, Clean Water Act, or state equivalents may contain regulatory standards for amendments whether they are wastes, conventional products, or products designed specifically as an ISB amendment, thus preventing their introduction or requiring careful characterization and monitoring to assure complete utilization during the ISB process.

## 3.0 SITE DESCRIPTION/CHARACTERIZATION

When considering the application of ISB, it is important to understand the overall site and its characterization. This is because several interrelated factors determine whether or not this technology is applicable to, and will function appropriately in, a site-specific circumstance. These factors include

- hydrogeology,
- geochemistry,
- contaminant transformations, and
- receptors.

Each of these factors, their meaning, interrelationship, and importance, is considered as explained below.

### 3.1 Hydrogeology

Characterization of the hydrogeology of a site provides a basis for predicting how fluids and solutes move through the subsurface. The intent is to delineate the factors relevant to ISB. These factors control the transport and distribution of contaminant mass in the subsurface, as well as any amendments added to enhance biodegradation.

#### 3.1.1 Hydrogeologic Characterization Parameters

Vadose Zone: Also termed the unsaturated zone, this is the subsurface region that contains water at a pressure less than that of the atmosphere, and air or gases generally at atmospheric pressure. This zone is limited from above by the land surface, and from below by the surface of the zone of saturation, that is, by the water table in unconfined conditions or by the confining layer in confining conditions (Driscoll, 1986). The unsaturated zone often contains the contaminant source that contributes contamination to the saturated zone. This document does not presently address remediation of the vadose zone, even though some ISB technologies may be applicable to vadose zone contamination (i.e., bioventing).

Lithology: The physical character of rocks and geologic units as based on physical properties such as color, mineralogic composition, grain size, shape, and sorting (Bates and Jackson, 1987).

Hydraulic Conductivity (K): Hydraulic conductivity is the capacity of an aquifer matrix to transmit water. It is expressed as the volume of water at the existing kinematic viscosity that will move in unit time under a unit hydraulic gradient through a unit area measured at right angles to the direction of flow (Heath, 1983).

$$K = \frac{Q}{iA}$$

where K = hydraulic conductivity  
Q = volume of water per unit time  
A = cross-sectional area  
i = hydraulic gradient

Hydraulic conductivity is typically expressed in units of distance per unit time, i.e., ft/day or cm/sec. A water-bearing unit in which the hydraulic conductivity is nearly uniform is described as homogeneous. Conversely, when the hydraulic conductivity varies within the unit, it is described as heterogeneous. If the hydraulic conductivity is uniform in all directions, the unit is described as isotropic. When the hydraulic conductivity varies with direction, the water-bearing unit is said to be anisotropic. In practice, K is usually defined in terms of two vector components: horizontal and vertical. Horizontal hydraulic conductivities are typically greater than vertical hydraulic conductivities.

Effective Porosity ( $n_e$ ): The fraction of the total volume of a given mass of aquifer material that consists of interconnected open spaces. Effective porosity directly relates to the capacity of a geologic unit to store and transmit water or other fluids. In this respect, it provides a more realistic estimate of the hydrogeologic characteristics than the larger porosity volume, which



includes isolated, nonconnected open spaces. Porosity is defined as the volume of void space per unit volume of aquifer material or sediment and is dimensionless.

Hydraulic Gradient (*i*): This is the slope of the water table or potentiometric surface. It is the change in the water table elevation (head) per unit of distance along the direction of maximum head decrease (Heath, 1983). The hydraulic gradient is determined by measuring and comparing the water levels in several wells.

$$i = \frac{\Delta h}{\Delta l}$$

where  $\Delta h$  = change in head between two points in the aquifer  
 $\Delta l$  = horizontal distance between the two points

Flow Velocity (*v*): Flow velocity is defined as the product of the hydraulic gradient (*i*) and the hydraulic conductivity (*K*) divided by the effective porosity (*n<sub>e</sub>*) (USGS, 1982):

$$v = \frac{K \times i}{n_e}$$

Depth to Water (*dtw*): The distance from the ground surface to the static water level or water table (Driscoll, 1986). This level may vary with seasonal fluctuations. This information is important in site assessment to determine the groundwater elevation and the groundwater flow direction when measured at three or more locations.

Static Water Level: The elevation at which water stands in a well, which is unaffected by pumping or injection (Bates and Jackson, 1987). This information is necessary to help determine transport of the COC and amendments for enhanced ISB.

Dispersion: Dispersion is the spreading of solute mass outward from its expected advective path, primarily due to mechanical mixing (ITRC, Natural Attenuation of Chlorinated Solvents in Groundwater Training Course). This term traditionally relates to contaminant dispersal. However, for deployment of enhanced ISB systems, dispersion needs to be considered since fluid transport and mixing of the amendment solute with contaminated groundwater are critical to stimulating ISB reactions.

Dilution: Dilution is defined as the decrease in solute concentration in a fluid due to mixing with a fluid that is either solute-free or contains a lower concentration of the solute (ITRC, Natural Attenuation of Chlorinated Solvents in Groundwater Training Course). During verification of ISB effectiveness, dilution must be quantified and evaluated to determine if it is the sole factor causing a decrease in contaminant concentrations. The following equation can be used to predict the effect of dilution for the case of mixing with uncontaminated water:

$$C_{\text{final}} = C_{\text{initial}} \times \frac{V_{\text{initial}}}{V_{\text{final}}}$$

where  $C$  = concentration of contaminant  
 $V$  = volume of the plume

### 3.1.2 Contaminant-Specific Parameters

These parameters determine the dissolution, bioavailability, and rate of transport of the contaminant in groundwater relative to the rate of transport of water.

Sorption: Sorption is a general term to define the process of how dissolved or gaseous chemicals attach to (sorb) and detach from (desorb) solid material. Chemicals sorb because they dissolve into the organic matter on soil, diffuse into the soil matrix, or are attracted by electrical charge. Chemicals desorb because of diffusion along a concentration gradient or displacement by a molecule with a higher affinity for the sorption site (ITRC, Natural Attenuation of Chlorinated Solvents in Groundwater Training Course). Sorption is related to retardation (see  $R_f$  below) in the groundwater flow system. In terms of implications for ISB, sorption may slow down transport of chemicals and limit dissolved concentrations. In particular, sorption can be beneficial in helping to limit the dissolved concentrations of chemicals, such that the attainment of levels that are toxic to the degrading bacteria is prevented.

Octanol-Water Partitioning Coefficient ( $K_{ow}$ ): The equilibrium ratio of concentration of a compound dissolved in octanol to that dissolved in water in contact with the octanol. The solubility of an organic compound is related to  $K_{ow}$ . In general, ISB is more effective for contaminants with higher water solubility (i.e., compounds with low  $K_{ow}$ ) (Looney, 2000).

Organic Carbon Partitioning Coefficient ( $K_{oc}$ ): The equilibrium ratio of the concentration of a compound sorbed on organic carbon to the dissolved concentration in water in contact with the organic matter. The performance of bioremediation diminishes as  $K_{oc}$  increases due to the lower bioavailability of contaminants strongly sorbed to natural organic matter (Looney, 2000).

Distribution or Partition Coefficient ( $K_d$ ): This parameter describes the equilibrium distribution of a chemical between solids and groundwater. This is usually described as a sorption isotherm between the concentration of the chemical sorbed onto the soil and the concentration remaining in solution at equilibrium (ASTM, E1943). It is expressed as

$$K_d = \frac{C_s}{C_w}$$

where  $K_d$  = distribution coefficient ( $\text{cm}^3/\text{g}$ )  
 $C_s$  = sorbed concentration ( $\text{g/g}$  –soil)  
 $C_w$  = dissolved concentration ( $\text{g}/\text{cm}^3$  –solution)

$K_d$  is also related to the organic carbon partitioning coefficient of a specific compound and the organic carbon fraction of the subsurface matrix through

$$K_d = K_{oc} \times f_{oc}$$

where  $K_{oc}$  = organic carbon partitioning coefficient as defined above  
 $f_{oc}$  = fraction of organic carbon in the matrix

**Retardation:** This is the process by which the movement of a reactive chemical through an aquifer or geologic unit is slowed or impeded due to sorption. It is important to ISB systems because retardation is a numeric value used to describe the attenuation of a plume to sorption. If a contaminant is heavily retarded, it may not be available for ISB to occur. Retardation is expressed in terms of the retardation coefficient ( $R_f$ ):

$$R_f = 1 + \frac{\rho_b \times K_d}{n_e}$$

where  $\rho_b$  = bulk density of the matrix ( $\text{g}/\text{cm}^3$ )  
 $K_d$  = partition coefficient  
 $n_e$  = effective porosity ( $\text{cm}^3/\text{cm}^3$ )

The retardation factor represents the velocity of transport of the chemical relative to the velocity of groundwater flow. The transport velocity of the chemical in groundwater,  $v_c$ , can be derived from  $R_f$  by

$$v_c = \frac{v}{R_f}$$

where  $v$  = groundwater velocity, as defined above (ASTM, E1943-98).  
 $v_c$  = velocity of chemical in groundwater

These values are important to ISB to determine the degree of contamination. Determining dissolution, retardation, and velocity help evaluate the feasibility of ISB or enhanced ISB. Comparison of conservative tracers (bromide, chloride) with contaminant movement can assist in velocity determinations.

## 3.2 Geochemistry

### 3.2.1 Oxidation-Reduction Potential

The oxidation-reduction potential (ORP) indicates oxidizing or reducing conditions in the saturated zone. ORP is typically measured in millivolts (mv) and indicates the type of biotic chemical contaminant transformations that are likely to occur. In most aquifers, bacteria are present that can mediate many contaminant transformations requiring electron transfers. The most oxidizing electron acceptor in groundwater is dissolved oxygen. Aerobic bacteria can flourish, given sufficient electron donors. There is a wide range of studies that have shown that fuel hydrocarbons (electron donors) are readily degraded if sufficient dissolved oxygen is present or provided. Under the proper oxidizing conditions, other contaminants have been shown to transform and/or become immobilized.

Contaminants that are degraded by anaerobic bacteria require the absence of dissolved oxygen. These contaminants are generally ones that act as electron acceptors after dissolved oxygen has

been depleted. Figure 3-1 describes an electromotive force (reduction-oxidation, or ORP) scale with calculated ORP readings in mv for commonly monitored species that were thermodynamically estimated at equilibrium concentrations of oxidizing and reducing couples. Site-to-site variation in pH and differing reactants/products affect the calculated ORP couples. In some cases, reaction ranges may overlap with more oxidizing or more reducing reactions.

Care must be exercised when interpreting ORP measurements. ORP is highly sensitive to several different parameters, including the transient presence of oxygen as well as other reduction-oxidation ion couples. ORP is a field measurement that is hard to read. In brief (see ASTM, D1498-93), ORP is based on the Nernst equation as follows:

$$E = E_0 - \left( \frac{RT}{zF} \right) \ln \left( \frac{a_{red}}{a_{ox}} \right)$$

where R is the universal gas constant, T is the absolute temperature in degrees Kelvin, z is the charge number of the electrode reaction (which is the number of moles of electrons involved in the reaction as written), and F is the Faraday constant (96,500 C mole<sup>-1</sup>).

[http://www-biol.paisley.ac.uk/marco/Enzyme\\_Electrode/Chapter2/Nernst.htm](http://www-biol.paisley.ac.uk/marco/Enzyme_Electrode/Chapter2/Nernst.htm)

In most cases, ORP is expressed as Eh, oxidation potential in relation to the standard hydrogen electrode. Here, Eh is calculated as follows:

$$E_h = E_{obs} + E_{ref}$$

Where:

E<sub>h</sub> = reduction-oxidation potential in millivolts referred to hydrogen scale, mv

E<sub>obs</sub> = observed reduction-oxidation potential of noble metal reference electrode, mv

E<sub>ref</sub> = reduction-oxidation potential of the noble metal electrode related to hydrogen electrode, mv

Thus, it is important to understand the precise details of any measurement taken (as ORP, Eh, etc.) and the “unit” in which it is reported. Such measurements should be viewed as qualitative at best, particularly in a groundwater solute containing mixed ionic species with various activities or the influence of transient oxygen from sample collection or other sample manipulation. Such mixed conditions or the presence of transient oxygen can give highly skewed results.

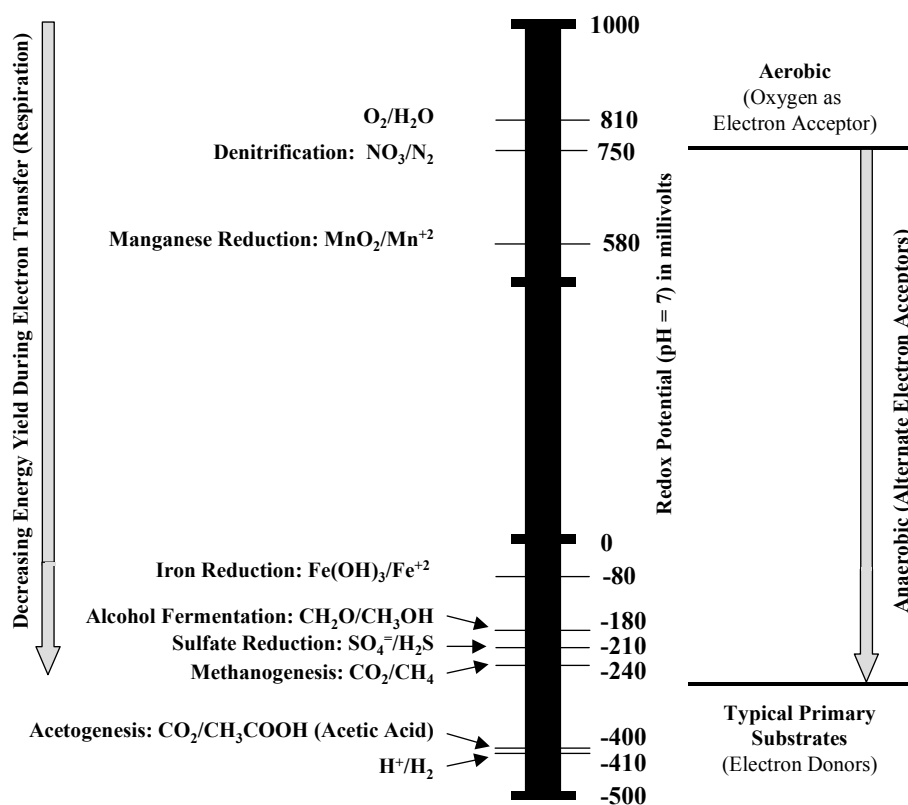
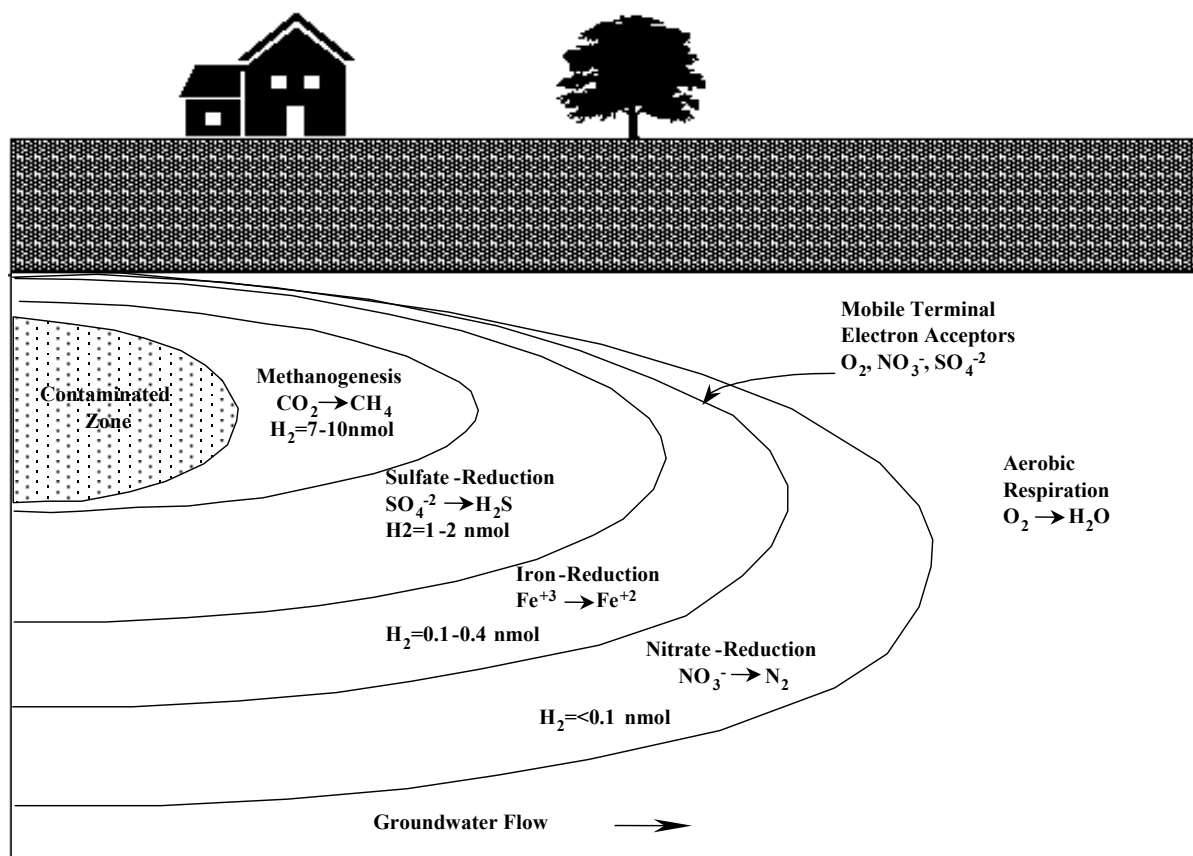

**Figure 3-1. Estimated Oxidation-Reduction Potentials of Commonly Monitored Chemical Specie**

Denitrification and manganese reduction can occur in both slightly aerobic and anaerobic groundwater. At slightly lower ORP than those shown for denitrification,  $Mn^{+4}$  is reduced to more soluble  $Mn^{+2}$ . At still lower ORP,  $Fe^{+3}$  is reduced to much more soluble  $Fe^{+2}$ . Thus, high groundwater concentrations of dissolved iron ( $Fe^{+2}$ ), in 0.45 micrometer ( $\mu m$ ) filtered samples, are suggestive of anaerobic conditions that can be further confirmed by field measured Eh and a lack of measurable dissolved oxygen. Further reducing conditions are characterized by sulfate reduction to hydrogen sulfide ( $H_2S$ ), which produces the pungent “rotten egg” odor. At very low Eh, methanogenesis occurs, in which carbon dioxide ( $CO_2$ ) is reduced to methane ( $CH_4$ ). Very low Eh is common in groundwater beneath landfills, where high amounts of organic carbon support fermentation of complex organic matter to hydrogen gas ( $H_2$ ), alcohols, and short chain acids. Fermentation products fuel methanogenic reactions and other anaerobic processes.

Many chlorinated solvents that are commonly associated with groundwater contamination have been observed to dechlorinate in one or more of the ORP environments associated with the reactions in Figure 3-1. Both direct halorespirers and bacteria involved in the various reducing processes described above can reduce chlorinated solvents. The stimulation of these bacteria under reducing conditions is essential to anaerobic dechlorination reactions. Starting with fully chlorinated compounds (i.e., carbon tetrachloride and perchloroethylene (PCE)), dechlorination occurs as a stepwise process with each step requiring a lower ORP. During each transformation, the parent compound (chlorinated organic or R-Cl) releases one chloride ion and gains one

hydrogen. The electrons released in the process are believed to be a source of energy for the bacteria. The reductive dechlorination of PCE and carbon tetrachloride occurs over a large ORP range, encompassing both denitrification and methanogenesis; however, vinyl chloride (VC) is anaerobically reduced in a more limited range at or below the ORPs that are needed to stimulate sulfate reduction. VC reductive dechlorination is reportedly dependent on the availability of  $H_2$ , which acts as an electron donor for respiration (Newell, et al., 1998). On the other hand, VC has been reported to undergo direct or cometabolic degradation in aerobic conditions. It is therefore not considered persistent.



**Figure 3-2. Idealized Terminal Electron Acceptor Process**

The above reductive sequence may be observed in groundwater in successive samples further down gradient from source areas (Figure 3-2). In this case, the sequential oxidation of the couples is terminated with higher nitrate and dissolved oxygen (DO) concentrations. Also of note is the disappearance of dissolved  $H_2$  in more oxidative ORP zones. Chapelle, et al. (1996) emphasized the importance of the role  $H_2$  plays as an electron transfer mediator at groundwater contamination sites.

**Table 3-1. Suggested Analytes for Bioremediation**

Primary Analytes for Groundwater	Analytical Method	Holding Time	Sample Volume	Reason for Analysis
Alkalinity	310.1 (field)	14 days	100 ml	CO <sub>2</sub> and CO <sub>3</sub> /HCO <sub>3</sub> are produced by microbial respiration, and an increase in alkalinity may indicate microbial growth from CO <sub>2</sub> or organic acid production that lowers the pH and solubilizes carbonate.
Chloride	325.3	28 days	100 ml	Used as a conservative tracer; for R-CL an increase in Cl may indicate reductive dechlorination.
Dissolved Oxygen	Field <sup>1</sup>	-	-	O <sub>2</sub> is a microbial electron acceptor and a redox indicator. High oxygen (>2 mg/L) shows aerobic conditions and O <sub>2</sub> will be the preferred electron acceptor until depleted.
Manganese (dissolved)	6010B/200.7 <sup>2</sup> (field)	180 days <sup>3</sup>	250 ml /1L	An increase in dissolved manganese, relative to background, (Mn[II]) may indicate that Mn(IV) is serving as an electron acceptor in anaerobic biodegradation.
Iron (dissolved)	6010B/200.7 <sup>2</sup> (field)	180 days <sup>3</sup>	250 ml /1L	An increase in dissolved Fe, relative to background, may indicate that Fe (III) is serving as an electron acceptor in anaerobic biodegradation.
Nitrate/nitrite (total)	353.2 (field)	28 days <sup>3</sup>	500 ml	A decrease in nitrate, relative to background, may indicate that nitrate is serving as an electron acceptor under slightly reducing conditions.
PH	Field	-	-	Optimum range 5 to 9 for ISB
Phosphate as P (soluble)	365.1	28 days <sup>2</sup>	100 ml	Nutrient needed for microbial growth. Phosphate may need to be added to promote biodegradation.
Oxidation Reduction Potential (ORP) (mv)	Field <sup>1</sup>	-	-	Measurement of reducing or oxidizing environment may be indicative of a real or potential biological activity
Sulfate	375.4 (field)	28 days	100 ml	A decrease in sulfate, relative to background, may indicate that sulfate is serving as an electron acceptor under anaerobic conditions. If this is the case, should be able to measure an increase in sulfides.
Methane	GC-0019	14 days	40 ml	An increase in methane, relative to background, may be an indicator of reducing conditions or microbial byproduct using carbon dioxide as an electron acceptor. It is generally not present at most sites.
Total organic carbon	415.1	28 days <sup>(1)</sup>	100 ml	TOC may serve as electron donors and help to determine the amount of electron donor amendment required for biodegradation, and TOC may increase retardation of the COC due to sorption.

<sup>1</sup> Difficult to measure in the field and may provide conflicting results<sup>2</sup> 6010B is used for RCRA projects. 200.7 is used for NPDES (CWA) projects.<sup>3</sup> Hold time is based on the proper preservative added to the sample.

### 3.2.2 Analytes Typically Associated with ISB

The following discussion details the typical analytes characterized to evaluate ISB. These analytes are listed in Table 3-1 and discussed below.

Alkalinity: During microbial respiration, carbon dioxide ( $\text{CO}_2$ ), carbonate ( $\text{CO}_3^{2-}$ ), and bicarbonate ( $\text{HCO}_3^-$ ) are produced. In the geological environment, these analytes react with geo-matrix material, creating an increase in alkalinity. Therefore, if the alkalinity concentration is greater in the contaminant plume than in background, this may be an indication of biological activity.

Dissolved Oxygen (DO): DO measurements in groundwater indicate whether the saturated zone conditions are chemically oxidizing (aerobic) or reducing (anaerobic). Since oxygen is the first electron acceptor available for biotic transformations (see Figure 3-1), it is quickly consumed. Following the depletion of oxygen, other ions become the electron acceptors depending on Eh values. Therefore, if DO values are suppressed ( $<2$  mg/L), anaerobic conditions are present and an evaluation of other electron acceptors must be made. These measurements should be made in the field with DO meters.

Chloride: Chloride is used as a conservative tracer as well as an indication of biological dechlorination reactions for chlorinated compounds in the subsurface. As a conservative tracer, the effect of dispersion can be estimated and accounted for, allowing for better estimation of biological degradation rates. As a biogenic degradation product, relative dechlorination reactions versus parent compound may be estimated and tracked.

Oxidation-Reduction Potential (ORP): The ORP indicates oxidizing or reducing conditions in the saturated zone. Refer to Figure 3-1 and Section 3.2.1 for relative values. These ORP measurements provide an indication of which ion is the predominant electron acceptor. Field equipment used to measure DO and ORP may provide conflicting data. For example, DO measurements may be less than 1 milligram per liter (mg/L) while ORP values may be greater than 810 mv. These results appear contradictory and are usually associated with inadvertent oxygenation of the sample or are indicative of the difficulty in measuring ORP.

Nitrate/Nitrite ( $\text{NO}_3/\text{NO}_2$  total): Under slightly reducing conditions, after oxygen is depleted, nitrate becomes the predominant electron acceptor. If nitrate values in the reductive area of the plume are less than background values, it indicates that nitrate may have served as an electron acceptor for biological activity. Since nitrite ( $\text{NO}_2$ ) will quickly revert back to nitrate in the presence of even low concentrations of oxygen, analytical results are typically presented as a combination of nitrate and nitrite.

Dissolved Manganese: Under further reducing conditions, manganese (Mn), typically from the soil matrix, is dissolved into solution. Manganese (IV) ( $\text{MnO}_2$ ) may be used as an electron acceptor, reducing to manganese (II) ( $\text{Mn}^{+2}$ ). If dissolved manganese concentrations within the plume are greater than background values, it is an indication that manganese from the geologic matrix has served as an electron acceptor and biological activity may be occurring.

Dissolved Iron: At ORPs close to  $-80$  mv, iron, typically from the geologic matrix, is dissolved into solution. Iron as  $\text{Fe}(\text{OH})_3$  may be used as an electron acceptor, reducing to ferrous ( $\text{Fe}^{+2}$ )



iron. If dissolved iron values are greater than background values, it is an indication that iron from the soil matrix has served as an electron acceptor and biological activity may be occurring. As with manganese, if conditions become oxidizing again, iron and manganese will precipitate; if the dissolved concentrations have been high, the precipitate may clog the soil pore space.

Sulfate: Under even lower ORPs, sulfate ( $\text{SO}_4^-$ ) may serve as an electron acceptor, producing hydrogen sulfide ( $\text{H}_2\text{S}$ ). Therefore, if sulfate values are less than background values, it is an indication that sulfate, in solution, has served as an electron acceptor and biological activity may be occurring. The production of  $\text{H}_2\text{S}$  may be noted in the field during sample collection by the strong “rotten egg” odor.

Total Organic Carbon (TOC): TOC concentrations indicate the electron donor availability for biological activity. This measurement is typically associated with naturally occurring organic matter found in solution (dissolved organic carbon), although very high concentrations may indicate the presence of contaminating hydrocarbon compounds. However, analyses for volatile organic compounds and semivolatile organic compounds from a plume sample should be performed to identify contaminants that may serve as electron donors. TOC measurements may be important for retardation estimates since many COCs may be retarded by the TOC.

pH: pH is a logarithmic notation used to measure hydrogen activity (i.e., whether a solution is acid or basic).

$$\text{pH} = -\log [\text{H}^+]$$

As a simplification, it is assumed that pH is a function of the hydrogen ion concentration  $\{[\text{H}^+]\}$  when in reality it is related to the hydrogen ion activity  $\text{H}^+$ . Since pure water is slightly ionized, it is expressed as an equilibrium equation termed the ion product constant of water. The concentration of these two ions is relatively small and is expressed as a simple logarithmic notation. pH is the negative log of the hydrogen ion (Bailar, 1978). pH is important to ISB for two reasons. Under certain pH ranges, particular ions or metals may be in solution, affecting the efficiency of bioremediation. Also, pH may affect the bacteria that are responsible for the breakdown of the contaminant of concern.

Phosphate (soluble): Phosphate is a trace nutrient needed by microorganisms for growth and metabolism. The soluble fraction provides an estimate of that phosphate that is bioavailable.

Methane ( $\text{CH}_4$ ): Under highly reducing conditions, methane production may occur. This is important to ISB because if methane is detected at a contaminant site, and the COC is decreasing in concentrations, methanogenesis may be the biological process occurring. Methanogenesis occurs when carbon dioxide serves as an electron donor and methane is an end product.

A further guide to understand chemical analyses for evaluation of ISB is presented in ASTM's *Standard Guide for Remediation of Groundwater by Natural Attenuation at Petroleum Release Sites* ([ASTM, 1998](#)) and EPA's *Technical Protocol for Evaluating Natural Attenuation of Chlorinated Solvents in Groundwater* ([EPA/600/R-98128](#)).

### 3.3 Contaminant Transformations/Microorganisms

Transformation of groundwater contaminants can be defined as a change in contaminant state, including physical changes, such as transformation from a liquid to a gas, or chemical changes. Transformation can occur by both abiotic and biologically mediated processes. During natural attenuation of most groundwater contaminants, transformation by abiotic mechanisms is negligible compared to biological transformation because abiotic reactions occur at extremely slow rates under typical groundwater conditions. Furthermore, the conditions required for abiotic transformations (i.e., reducing conditions) may be provided by microorganisms, complicating the differentiation between abiotic and biotic mechanisms. The following sections describe several abiotic and biotic transformations.

#### 3.3.1 Abiotic Transformations

These transformations occur without biological activity. That is, the transformations are either chemical or physical.

Reduction and oxidation reactions: Reduction refers to the gain of electrons by a chemical species, while oxidation refers to the loss of electrons. The reduction of one substance is always accompanied by oxidation of another. Redox reactions can occur by both biotic and abiotic mechanisms. An example of an abiotic ORP reaction is the reduction of carbon tetrachloride by zero-valent iron to produce ferrous iron and methylene chloride:

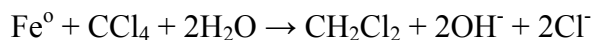

Hydrolysis: Hydrolysis results from a dissolution reaction where the contaminant reacts with water. An example is the hydrolysis of carbon tetrachloride:



This reaction occurs very slowly under natural conditions; the half-life of carbon tetrachloride for this reaction is approximately 41 years.

Elimination reactions: Eliminations are nucleophilic reactions that can result in transformation of alkanes to alkenes. An example of an elimination reaction is the dehydrohalogenation of chlorinated solvents, such as the transformation of 1,1,1-trichloroethane to 1,1-dichloroethene:

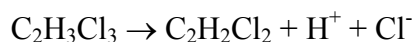

In this reaction, one chlorine is removed from one carbon atom, followed by the removal of a hydrogen from an adjacent carbon atom and alkene formation.

Volatilization: Contaminants can be removed from groundwater by volatilization into the soil gas phase. The volatilization of contaminants from groundwater is dependent on their physiochemical properties as well as properties of the specific soil and gas phases involved. Depending on the hydrogeological circumstances, volatilization of contaminants may be

negligible because there is limited contact area between the groundwater column and the soil vapor phase.

### 3.3.2 Biotic Transformations

Reduction and oxidation reactions: Microorganisms can gain energy for growth by coupling reduction-oxidation reactions via electron transport systems. Groundwater contaminants can serve as electron donors or electron acceptors in these biocatalyzed reactions. For example, ammonia can serve as an electron donor for the reduction of oxygen by nitrifying bacteria to produce nitrite and water:



In the above reaction, oxygen serves as the electron acceptor. Oxygen is an excellent electron acceptor for biologically mediated electron transfer because its reduction produces a relatively high-energy yield. Under anaerobic conditions, alternative electron acceptors, including nitrate, nitrite, Mn (IV), iron (III), sulfate, and  $\text{CO}_2$ , can be used by specific groups of microorganisms. The use of these alternative acceptors in electron transfer bioprocesses is termed anaerobic respiration. In the case of nitrate, denitrifying bacteria couples the oxidation of organic matter with the reduction of nitrate:

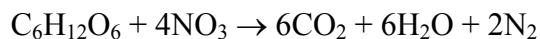

In anaerobic environments, hydrogen can serve as an electron donor for the reduction of contaminants. Halorespiration refers to biological reduction of organic solvents to produce energy for growth. In this process, hydrogen is oxidized while the chlorinated solvent is reduced:



Cometabolism: Cometabolism refers to processes where a compound is degraded by an enzyme or cofactor that is produced by organisms for other purposes and is considered to be a fortuitous reaction. For example, bacteria produce metallocoenzymes, such as cytochrome P450 and iron (II) porphorins that are capable of dechlorinating carbon tetrachloride. The cometabolic process does not benefit the microorganism producing the enzyme or cofactor. Another example, one of the most important inducible enzymes for cometabolism of chlorinated compounds, is the oxygenases, including various mono- and dioxygenase enzymes produced by bacteria. “Cometabolic transformation kinetics, however, are complex and not well understood. This has led to the development of many increasingly complex models to describe the reaction kinetics, models which many times make quite different assumptions about system behavior, growth kinetics, substrate utilization kinetics, and cometabolite oxidation kinetics.” ([Iowa State University](#))

Assimilation: Assimilation refers to the incorporation of substances into biomass. Microorganisms require sources of carbon, hydrogen, oxygen, and nitrogen, as well as minor and trace nutrients. In some cases, groundwater contaminants can be converted into biomass by microorganisms. For example, microorganisms can use ammonia ( $\text{NH}_4$ ), nitrate, or nitrite as sources of nitrogen for growth. Although assimilation processes may involve ORP reactions,

these processes are different than dissimilatory ORP reactions because the latter produce energy for the growth of microorganisms. In contrast, assimilatory reactions (anabolic reactions) often require energy. For example, the assimilation of ammonia via the glutamine synthesis reaction utilizes ATP (energy):

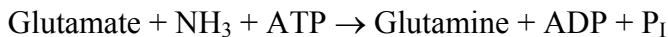

Sequential transformations: Transformation of contaminants in groundwater is often sequential with various intermediates (or degradation products) appearing before the contaminant is completely mineralized. For example, the generally accepted sequence for the mineralization of nitrate is:



The presences of intermediates from sequential transformations are often used as an indicator of contaminant degradation by natural or enhanced bioattenuation. In the case of groundwater contaminated with carbon tetrachloride, the presence of chloroform and methylene chloride may indicate that contaminant degradation has occurred. The reaction rates for the various steps in a sequential transformation may be considerably different. Thus, an intermediate in the sequence that is formed quickly but consumed slowly can accumulate during sequential degradation.

Contaminant Mixtures: Mixtures of multiple contaminants may display more complex transformations than single contaminants. For example, the mixture of an organic carbon source with other contaminants in groundwater could create anaerobic conditions, which may increase or decrease the transformation of contaminants. The generation of anaerobic conditions would decrease the oxidation of ammonia but would increase the reduction of nitrate.

### 3.3.3 Microbial Characterization

Characterization of the microbial community indigenous to a contaminated site can provide valuable information to aid bioremediation. Characterization of the microbial community can help indicate the microbial processes (e.g., sulfate reduction, nitrification) that are occurring at the site and can be used to determine if bacteria capable of degrading a particular contaminant are present at the site. Many bacteria present within a groundwater environment may be attached to surfaces and not readily present in samples of the groundwater. Thus, microbial characterization should include core samples of aquifer materials as well as groundwater samples, if possible. Care should be taken in the collection of both groundwater and core samples to ensure that representative samples are taken and aseptic practice in sample collection is being adhered to as much as possible. When collecting groundwater samples, the monitoring well should be purged of at least three bore volumes because microbial populations in the immediate vicinity of the well bore may not be representative of the surrounding aquifer.

Microbial communities can be characterized by a variety of general microbiological and molecular biological methods. General microbiological methods, such as plate counts and most probable number (MPN) assays, typically involve culturing microorganisms in a laboratory. These methods can be used to enumerate bacteria of a certain metabolic group such as sulfate-reducing bacteria, denitrifying bacteria, or methanogenic bacteria. The presence of bacteria with

specific metabolic capabilities, such as the ability to degrade a certain contaminant, can also be enumerated and isolated using these methods. However, many bacteria can be difficult to culture under laboratory conditions. The use of molecular techniques enables the characterization of microbial communities without the requirement of laboratory culture. DNA or RNA probes for specific bacterial groups can be used to directly analyze samples (i.e., fluorescent in-situ hybridization) or analyze DNA or RNA extracted from samples and amplified using the polymerase chain reaction (PCR). Bacteria with certain metabolic capability can also be identified by analyzing for genes encoding a specific degradative enzyme. Because molecular techniques can also produce artifacts, combinations of general and molecular microbiological techniques are usually the best approach for site characterization.

### 3.4 Receptors

A receptor is an object, population, or even a location in the pathway of a pollutant. Based on past and current site chemical handling, receptors likely to be adversely impacted need to be identified and the exposure evaluated. Obvious pathways providing an exposure to harmful contaminants are private or public drinking water supplies, surface water bodies, and groundwater monitoring systems; however, there are innumerable mechanisms that may transmit contaminated media from the source or contaminated area to a receptor. Exposure rate, in general, is the amount of time, at certain concentration, a receptor is in contact with the harmful characteristic of a chemical. Receptors could include on-site workers and transients, off-site transients, or residential populations. Whether there are measurable on-site and off-site exposures must be determined, measured, or projected to establish the level and time allowed for remediating the contamination. Helpful tools to perform these assessments may be found at the [National Health and Environmental Effects Research Laboratory](#) (NHEERL), the [National Exposure Research Laboratory](#) (NERL), the [National Center for Environmental Assessment](#) (NCEA), and the [Agency for Toxic Substances and Disease Registry](#) (ATSDR).

When conducting risk assessments, primary and secondary contaminants must be incorporated into the exposure estimate. Given this, the contaminant degradation products and other reaction products from biodegradation, along with their half-lives, must be determined and incorporated into the risk equation.

#### 3.4.1 Adverse Human Health Effects

Many contaminants have known or suspected adverse human health effects, which must be detailed and clearly understood. It should be determined whether the contaminant's toxic effect is based on chronic or acute exposure, or whether there are target organs that accumulate or have a sensitivity to the toxic effect.

#### 3.4.2 Adverse Ecology Effects

Known or suspected adverse environmental impacts of each contaminant need to be detailed, including bioaccumulation factors, food-chain impacts, aquatic toxicity, sensitive species, and impacts on sensitive environments.

## 4.0 FATE AND TRANSPORT

### 4.1 Stoichiometry

In designing an ISB system, both reaction stoichiometry and kinetics are needed to define the amount of amendment required to complete biopromoted reactions and overall rates of various subreactions. Most bioremediation processes are metabolic, suggesting that chemical reactions follow a well-defined stoichiometry. Knowing the reactions and their stoichiometry gives a clear scientific basis for system design and operation.

Knowing the reaction kinetics, which includes both rates and mechanisms, better assures that the system design will meet operating and economic constraints. For example, if reactions are extremely slow, it is necessary to know this at project initiation. To identify necessary amendments, it is necessary to know if the reactions are limited by availability of one or more chemical species. An example is the availability of oxygen during aerobic remediation.

Stoichiometry is the theory of proportions in which chemical species combine with one another (Felder, 2000). The stoichiometric equation of a chemical reaction is a statement of the relative number of molecules, or moles, of reactants and products that participate in the reaction, for example the stoichiometric equation

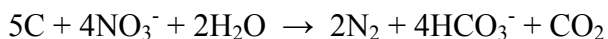

The numbers that precede the formulas for each species are the stoichiometric coefficients of the reaction components.

In this generic reaction, 5 moles of carbon react with 4 moles of nitrate and 2 moles of water to produce 2 moles of nitrogen gas plus other noted products. Thus, on a purely stoichiometric basis, 5/4 moles of carbon are required to biologically reduce every mole of nitrate to nitrogen gas. Of course in the ambient subsurface environment, numerous other “sinks” exist that react with (or compete for) the carbon. Such competing reactions increase the requirement for carbon addition in excess of theoretical in a field application.

As applied to ISB, stoichiometry defines the relative amounts of electron donor and electron acceptor that react under microbial-promoted reactions. Hence this relationship defines the minimum necessary amount of carbon amendment required to perform bioremediation.

Stoichiometric equations are used to design operation of an ISB system by defining minimum donor concentrations that will react with the target contaminant.

#### 4.1.1 Mass Balance (Chemical, Electron)

Measuring mass balance for a treatment process confirms reactions and stoichiometry knowledge. Since remediation reactions are stoichiometrically defined, it is possible to accurately estimate the amount of required amendment. As an example, a good mass balance may help identify a problem of getting adequate amendment distribution. Poor amendment mixing and distribution can cause problems as shown (Nuttall, et al., 2002) at a test site in New Mexico. Operational problems can be identified by monitoring amendment reduction and

degradation of COC. Furthermore, if there are previously unknown side reactions, these will be indicated, in part, by the mass balance.

## 4.2 Kinetics

Chemical kinetics is the study of rates and mechanisms by which one chemical species is converted to another. Rate is the mass, in moles, of a product produced or reactant consumed per unit time (Smith, 1970). This information will help to determine how long it will take to remediate a given concentration of contaminant.

The rate equation mathematical form is derived in part from an understanding of the reaction mechanism. Most often the rate equation needed for ISB design is obtained by applying a mathematical form to experimental data to determine equation parameters.

A kinetic rate equation is desirable for designing and operating an ISB system. Such kinetic rates are used as crucial “reactive” input terms to flow and transport models for system design and operation. Estimates of electron donor and acceptor degradation (temporal and spatial) are derived, which, in turn, affects the system design flow rates, donor/nutrient input rates, residence time in the subsurface flow field, and overall system layout (i.e., flow field size).

### 4.2.1 Biotic Half Lives

Reaction half-life,  $t^{1/2}$ , is defined as the time it takes for the reactant (contaminant) concentration to fall to half of its initial value. By experimentally measuring the reaction half-life as a function of initial concentration, reaction order and the specific reaction rate can be determined. This topic is discussed in more detail in Fogler, 1986. Half-lives can also be estimated by measuring the reduction in concentration along a single flow line over a known period of time. These methods are only approximations because of heterogeneities in the aquifer, dilution, dispersion, and abiotic reactions.

### 4.2.2 Reaction Order and Forms

Buscheck, et al. (1993) developed a simplified technique to quantify intrinsic bioremediation of solvent plumes in groundwater at several field sites. Their evaluation included a derivation of temporal (concentration versus time) and spatial (concentration versus distance) analyses that defined apparent first-order biodecay rates for steady state plumes. For this formulation, aquifer sorption sites were assumed to be saturated, and steady-state plume equilibria were assumed to exist. A first-order equation may be used as follows to derive the various estimates of biodegradation:

$$dC/dt = -K_1C$$

Where: t is time

$K_1$  is the first-order decay rate (per time)

C is the dissolved plume concentration

The solution for this differential equation was given for the two cases under study, namely for the temporal and then the spatial cases.

Temporal:

$$C_{(t)} = C_o e^{-Kt}$$

Where:  $C_{(t)}$  is concentration as a function of time(t)

$C_o$  is the concentration at  $t=0$

$K$  is the decay rate (per time)

Spatial:

$$C_{(x)} = C_o e^{-K(x/v)}$$

Where:  $C_{(x)}$  is concentration as a function of distance(x)

$C_o$  is the concentration at  $x=0$

$K_t$  is the decay rate (per time)

$x/v$  is the distance(x)/pore water velocity ( $v$ ) ( $e$  is the mathematical expression “e” and is the “base” in natural log functions (i.e.,  $\ln$  to the base  $e$ ))

Such simplified first-order kinetics may be applied to ISB systems. Furthermore, from this formulation one may derive a bioreaction half-life ( $t_{1/2}$ ) by noting:

$$t_{1/2} = -0.693/k$$

Where  $k$  is the first order kinetics

Here, the half-life term is made mathematically “positive” by inserting a negative sign (-) before the expression.

Often in bioremediation, the kinetics is first-order. A more detailed discussion of cell growth kinetics and rate equation forms is provided in Bailey, 1993.

### 4.3 Modeling

Fate and transport modeling is generally conducted to predict transport of a given contaminant under a set of environmental conditions. A model is a tool that represents an approximation of a field condition. Development of both a conceptual and groundwater computer model is a critical task in designing an enhanced ISB system.

Conceptual models and groundwater (computer) models are described below.

#### 4.3.1 Conceptual Model

Development of a representative site conceptual model (refer to Figure 2-1) is a critical step in helping to define achievable remedial objectives, select the proper groundwater flow (computer) model, and design cost-effective data collection activities. The refinement of a site conceptual model is a necessary step to design a remedial system for the site. A conceptual groundwater model is a simplified depiction of the groundwater flow system as visualized from the site investigation results. Fate and transport models interpret the movement of the contaminant plume



according to information describing the hydrostratigraphic units, boundary conditions, matrix composition, water movement, contaminant distribution, and biotic and abiotic processes that affect the fate and transport of contaminants. The first conceptual model will not be the last, rather preparation of a conceptual model is an evolutionary process. The conceptual model provides the basis on which to select the proper groundwater computer model to design an ISB system that will meet the remedial objectives.

A conceptual model helps reveal key mechanisms governing groundwater flow and the fate of chemical species being transported in the subsurface. It tests assumptions and simplifications required to reflect the real situation and validates the framework of the model itself. A conceptual model can be described with mass-balance summaries, geological cross-sections, and three-dimensional diagrams delineating site conditions. Note that during the development of any site conceptual model enough monitoring points must be in place to appropriately define the spatial (vertical and horizontal) extent of the contaminant plume. Furthermore, sampling frequency of these points should be established to determine temporal variations in contaminant concentration and, more specifically, natural attenuation mechanisms as they relate to ISB. For instance, the New Mexico Environment Department requires that, to adequately evaluate natural attenuation parameters, ISB geochemical parameters must be analyzed quarterly for the first year and at a minimum annually following that.

#### 4.3.2 Groundwater Computer Model

Ideally, groundwater modeling should begin early in the investigation process. Aquifer tests and other data collection activities can then be designed to maximize the collection of data that will reduce uncertainty in the most important parameters. Models are used to test conceptualizations and hypotheses regarding fate and transport. Computer models range from simple to complex, and the necessary detail in the groundwater computer model will depend on the complexity of the conceptual model and remedial objectives.

Just as the conceptual model evolves, so does the input to the computer model to increase the accuracy of the computer representation of the real system. These models are based on two transport mechanisms: advection, or flow, and dispersion, or transport. Advection models trace movement of contaminants using average groundwater flow; dispersion models describe the mixing and spreading of contaminants due to aquifer matrix.

##### Advection, or Flow, Models

Advection is defined as the movement of contaminants carried by water in the direction of flow. Advection is controlled by the average linear velocity of groundwater. Contaminant transport of dissolved-phase contamination is directly proportional to groundwater velocity, and an increase in velocity will result in greater travel distance. The flow model is used to estimate groundwater travel times and directions, which form the basis for fate and transport evaluations to ensure that substrate and nutrients will be delivered to the desired location at the desired concentrations. The groundwater flow model is used to specify the number and locations of recovery wells and flow rates to meet project objectives.

Groundwater flow models can range from simple analytical models (e.g., WinFlow, GFLOW2000) to complex multidimensional numerical models (e.g., MODFLOW). Many shareware models can be found at EPA's Office of Research and Development Subsurface

Protection and Remediation Division at <http://www.epa.gov/ada/csmos/models.html>. Analytical models are typically quick to run, taking just minutes to set up. However, these models have simplifying assumptions (e.g., uniform aquifer parameters and gradients) that must be appropriate for the specific site.

#### Dispersion, or Transport, Models

Dispersion is defined by the sum of molecular diffusion and mechanical mixing effects in the groundwater system. The remediation design must also take into account the fate and transport of injected substrate and nutrients. Fate and transport modeling can range from simple first-order decay calculations (e.g.,  $C=C_0e^{-Kt}$ ) using travel time along a groundwater flow path, to complex multidimensional multispecies transport models (e.g., MT3D). Degradation of the constituents of concern and substrate utilization is usually approximated by first-order decay functions. Most models can simulate this process.

Many factors affect the dispersion of contaminants in the subsurface environment. Pore size, path length, and friction in the pores due to soil particles all play an important role. Furthermore, if the aquifer matrix is high in clays or organic matter, adsorption can be significant. Several groundwater models are public domain, such as MODFLOW, AT123D, MT3D, BIOSCREEN, and BIOCHLOR. Please refer to the following EPA Web site for shareware models <http://www.epa.gov/ada/csmos/models.html>. These models simulate advection, dispersion, nonlinear sorption, first-order irreversible decay, and biodegradation in three dimensions. Even more complex transport models may be used to simulate more complex processes, such as the interaction of substrate and constituents, rate-limited degradation and/or substrate utilization, complex biological process, etc. (e.g., RT3D). However, the more complex the model, the more input parameters are needed, and usually the more uncertain are the results. The difficulties, cost, and uncertainties in using more complex models must be carefully weighed against the benefits of a more in-depth analysis.

Important parameters required for transport modeling include

- groundwater flow directions and velocities as determined by flow modeling,
- groundwater transport parameters ( i.e., dispersion coefficients, etc.),
- detailed data on the area to be remediated ( i.e., constituent distribution and concentrations),
- degradation rates of substrate,
- data to determine possible retardation of substrate relative to groundwater flow, and
- sufficient data to model biological process, if this is to be modeled.

#### Utilization of Groundwater Computer Models

Once a model is selected, the model is set up and calibrated. This is the key to the modeling effort and can take up as much as 50% to 70% of the modeling effort. Model setup includes selecting the model domain, dividing the data in space and time, defining boundary and initial conditions, and assembling and preparing input data. These choices affect physical and numerical resolution, level of effort, and the cost of the modeling effort. Model calibration is a process of varying uncertain model inputs within the acceptable range of values of various parameters until a satisfactory match between simulated and observed data is obtained. After several initial runs are made, the model is validated or verified. The process of validation is necessary to show that the chosen model can actually represent the physical system.

Once the model is calibrated, it is time to examine which input parameters play the most significant role by conducting a sensitivity analysis. The values of each input parameter is increased or decreased within the accepted range to identify the need for additional field data and to identify which parameters should be used for the model sensitivity analysis. After a reasonable calibration of the model and sensitivity analysis and it is concluded that model output reasonably matches the site situation, the model is run to predict the fate and transport of the contaminant of interest.

Since prediction is the main purpose of modeling, various assumptions are made to “predict” various scenarios. Assumptions such as continuous versus intermittent source, location, volume and concentration, phase(s), presence of other chemicals, possible depletion of the source, etc, all could be challenged by other parties. In cases involving ISB, model output may include the capture zone for different schemes, particle tracking, concentration as a function of distance and time, residence time for remediation, contaminant mass balances, and ranking of various alternate remedial options.

Since the ability to accurately model all the complexities of the subsurface is limited, uncertainties in model results will exist. Examples of uncertainties are the hydraulic conductivity of the aquifer and the hydraulic gradient and direction. These parameters can have a significant effect on the distribution of injected substrate and nutrients. For example, if a system of wells is installed and designed to inject at a given rate and the hydraulic conductivity was underestimated, the injected fluid will not spread out down gradient as much as originally predicted. Also, if the hydraulic gradient is in a different direction than originally thought, the injected fluid may move in a different direction than intended. The modeler clearly states where the model is weak and the relative degree of uncertainty in the prediction. In some cases, the modeler may suggest model auditing, which involves comparing the model predictions of the future to the actual outcome. Such practice adds substantially to model credibility.

The hydrogeologist must work closely with the design team to evaluate the effects of these uncertainties and develop appropriate data collection activities. The team must weigh the cost of additional data collection with the reduction of uncertainty and associated design impacts. Flexibility can be incorporated into the design (i.e., design for a range of flow rates) to address uncertainties. The modeling work can be used to demonstrate that the system can be operated in many different modes to address situations where the actual behavior of the aquifer is different than that assumed in the modeling.

This is an ongoing process throughout the design and implementation of the remedial system and should not stop when enhanced ISB or MNA is selected. Data collected during the operation or monitoring of the remedial system can be used to refine the understanding of the subsurface and develop system upgrades to more cost effectively operate the remedial system.

Flow and transport models are necessary tools to aid in the design of ISB systems. Assessing the level of complexity of modeling needed is subjective and must be based on the combined professional judgment of a multidisciplinary team of geologists, hydrogeologists, biologists, and engineers.

## 4.4 Feasibility

An ISB feasibility evaluation determines whether ISB is a remediation technology that will be appropriate in meeting cleanup goals. ISB remediation systems are attractive because these systems are

- a common sense approach to protect human health and the environment,
- a cost-effective alternative that can be used as a stand-alone technology or in association with other remediation technologies to reduce remediation costs, and
- minimally intrusive and usually less disruptive of facility operations and infrastructure compared to other remediation technologies (ITRC's [Natural Attenuation of Chlorinated Solvents in Groundwater: Principles and Practices](#) [ISB-3], 1999).

Good site characterization and field data alone are not sufficient to establish the suitability for implementation of ISB remediation technologies (ITRC's [Technical and Regulatory Requirements for Enhanced In Situ Bioremediation of Chlorinated Solvents in Groundwater](#), [ISB-6], 1998). There are certain general limitations of ISB that are important. If MNA is a stand-alone remediation, then the time to achieve remedial goals may be a limiting factor. Furthermore, if enhanced ISB is the chosen remediation technology, then the mixing and distribution of amendments is critical. However, MNA is not a “do nothing” remedy. For established ISB technologies (i.e., petroleum hydrocarbons), laboratory and field tests may not be necessary. For nonestablished ISB technologies, it is recommended that both laboratory treatability studies and a field pilot test be conducted.

### 4.4.1 Monitored Natural Attenuation

Natural attenuation is defined in ITRC's [Five-Course Evaluation Summary for the ITRC/RTDF Training Course in Natural Attenuation of Chlorinated Solvents in Groundwater](#) (ISB-7), 1999, as naturally occurring processes in soil and groundwater environments that act without human intervention to reduce the mass, toxicity, mobility, volume, or concentration of contaminants in those media. These *in situ* processes include biodegradation, dispersion, adsorption, volatilization, chemical or biological stabilization, and destruction of contaminants. Monitored natural attenuation (MNA) is an evaluation of the physical, chemical, and biological conditions and reaction products at a contaminated site to determine if the naturally occurring processes will achieve remediation goals. An excellent document that addresses this issue and provides additional information on ISB and MNA is EPA's [Technical Protocol for Evaluating Natural Attenuation of Chlorinated Solvents in Groundwater](#). There is no treatment system engineered or installed if MNA is chosen as the final remediation technology. Again, if MNA is to be the chosen remediation technique, the length of time to accomplish the monitoring needs to be considered and evaluated and the potential to impact other wells, aquifers, surface water bodies, or the vadose zone. The reader should note that MNA may be a final remediation step following an enhanced ISB project.

The evidence to prove MNA is not a cursory effort. Application of rigorous technical definition of MNA via a lines-of-evidence approach is requisite for any site at which MNA is being considered. See [OSWER Directive 9200.4-17P](#), 1999, which establishes EPA's expectations for application of MNA. MNA is typically approved for stable or shrinking plumes. Plumes

continuing to migrate typically require some application like ISB that will accelerate the degradation process.

As a follow-up to this guide, Sandia National Laboratories' (SNL) Geochemistry Department has developed a screening method for evaluating MNA as a remediation alternative. This screening method, called [MNAtoolbox](#), “identifies primary attenuation pathways and points out processes that might mitigate against MNA for particular contaminants. Each contaminant module leads to a scorecard that uses site-specific input parameters to gauge the probable effectiveness of attenuation.” Modules for various organic, metals, and radionuclide contaminants are presented. A complete report on the MNA toolbox is available from [SNL](#).

#### 4.4.2 Enhanced ISB Systems

Enhanced ISB systems are typically systems designed to introduce amendments into the contaminated media so that microbial populations can optimize the destruction of the contaminant of concern. Enhanced ISB systems can be deployed for source reduction, dissolve-phase contaminant reduction, or as a biological barrier to contain the contaminant plume. Depending on the contaminant, hydrogeologic conditions, and remediation goals, enhanced ISB systems can be reductive anaerobic, oxidative and direct degradation, cometabolic, or a combination. ITRC's [Technical and Regulatory Requirements for Enhanced In Situ Bioremediation of Chlorinated Solvents in Groundwater](#) (ISB-6) and EPA's [Engineered Approaches to In Situ Bioremediation of Chlorinated Solvents: Fundamentals and Field Applications](#) provide good descriptions of engineered systems with associated references. For more detail and definitions, please refer to these documents. If environmental site conditions are unsuitable for MNA or enhanced ISB, then evaluation of the environmental conditions that can be manipulated to favor ISB is necessary. The addition of amendments may not cause site conditions to be favorable to ISB-engineered systems. Please refer back to Sections 4.1 and 4.2 (Kinetics and Stoichiometry) to determine if any environmental conditions may be manipulated to increase the kinetics.

#### 4.4.3 Hybrid Treatment Systems

Many remediation systems do not rely exclusively on one remediation technology. The same may hold true for ISB. ISB, in particular MNA, has regularly been used as a “polishing” technology in the final stages of achieving remediation goals or standards. However, ISB technologies are maturing, and engineered ISB systems are becoming the primary remediation technology at many sites. MNA and ISB remediation systems have been used in conjunction with pump-and-treat systems, air sparging, soil vapor extraction, permeable reactive barriers, chemical oxidation, six-phase heating, and *in situ* thermal destruction. ISB remediation technologies should be considered and deployed, where appropriate, as part of a treatment train to reach remediation goals.

#### 4.4.4 Laboratory-scale Treatability Test

Laboratory treatability studies are necessary to determine if bioremediation can or will occur at the contaminant site. These studies are recommended to provide specific contaminant degradation information, provide information about the types of biodegradation that occur naturally at the site, and assist in determining the best amendments to be added. Also, these

studies can evaluate different amendments and different levels of amendments to determine which is most effective. A complete detailed discussion of laboratory treatability tests may be found in ITRC's [\*Technical and Regulatory Requirements for Enhanced In Situ Bioremediation of Chlorinated Solvents in Groundwater\*](#) (ISB-6), pp. 40–45. There are usually two types of treatability studies: microcosm bottle studies and soil column studies. Both studies use groundwater samples and/or aquifer material from the contaminated site to which amendments are added (electron donors, electron acceptors, and nutrients), and the rate and extent of biodegradation is evaluated. These studies may deploy different amendments to determine optimum bioremediation.

The Reductive Anaerobic Biological In Situ Treatment Technology Technical Protocol states in Section 5 ([Environmental Security Technology Certification Program](#), 2001):

The microcosm studies can provide valuable information concerning the fate of added reducing equivalents, including the pathways of fermentation operable at a site, and the potential competition for reducing equivalents among various microbial groups.... Such information can be used to design the injection formulation and enhancement strategy.... The microcosm results can be used to develop site-specific inputs to comprehensive contaminant transport/fate models, allowing quantitative model estimates of dynamic response to alternative enhancement strategies.

This document provides detailed information on developing laboratory treatability tests, including equations to develop the donor demand from amendment contributions in the groundwater. Furthermore, the RABITT protocol provides a phased approach to evaluate a site for reductive ISB, including information necessary for site characterization, pilot-scale field demonstrations, and full-scale deployment.

Laboratory treatability tests are important to determine the effectiveness of enhanced ISB at any given site. These tests may be time-consuming and costly, therefore, the Strategic Environmental Research and Development Program (SERDP) is pursuing “less costly and more rapid advanced test and evaluation techniques to assist in the evaluation and design of site-specific bioremediation strategies.” (SERDP, 2000). This new research may lead to improved methods to reduce or replace laboratory treatability tests. Laboratory treatability tests should be conducted to simulate field conditions, and care must be taken during the collection and transport of these samples. Overnight transport of these samples is recommended to maintain near to field conditions as possible.

#### 4.4.5 Applicability

Results from the laboratory treatability studies will determine whether ISB is a remediation alternative. If the laboratory treatability results show that ISB does not occur, or the process is incomplete or too slow under the various conditions tested, then ISB is most likely not a remediation alternative. Keep in mind that laboratory treatability studies are conducted on limited site contaminant samples, and other parts of the contaminant plume may be conducive to ISB remediation. If the laboratory results show that ISB does occur from the contaminant sample, then a pilot-scale field demonstration project is recommended prior to a full-scale ISB remediation deployment. Studies can evaluate different amendments and different rates of

amendment introduction to determine which amendment is most effective. A complete detailed discussion of laboratory treatability tests may be found in ITRC's [\*Technical and Regulatory Requirements for Enhanced In Situ Bioremediation of Chlorinated Solvents in Groundwater\*](#) (ISB-6), pp. 40–45.

#### 4.4.6 Pilot-scale Field Demonstration

A pilot-scale field demonstration for ISB is typically needed to test the design in a small and affordable field application and to adjust the design (e.g., injection rates, specific amendments, etc) to accommodate site-specific circumstances and conditions. Prior to implementation of the pilot-scale field demonstration, goals and objectives of the test should be clearly defined. That is, will predefined cleanup criteria be achieved, will time frames be achieved, will geochemical conditions be adversely impacted, will the cost be within projected budgets? For mature ISB technologies on specific contaminants (e.g., petroleum hydrocarbons), pilot-scale field demonstrations may not be as necessary. ITRC's [\*Technical and Regulatory Requirements for Enhanced In Situ Bioremediation of Chlorinated Solvents in Groundwater\*](#) (ISB-6), pp. 45–59, explains, in detail, a pilot-scale field demonstration. Issues associated with ISB are fully defined in this document and include

- permitting and regulatory acceptance,
- preliminary site selection,
- focused hydrogeologic study,
- engineering design,
- test phase, and
- evaluation.

ITRC's *Technical and Regulatory Requirements for Enhanced In Situ Bioremediation of Chlorinated Solvents in Groundwater* states in the conclusions concerning pilot-scale field demonstration, "It is also strongly recommended that the pilot be preceded by at least some laboratory treatability study similar to those presented in this document. The need for laboratory treatability studies at every enhanced ISB site may diminish as these technologies become more accepted and understood. However, for now, they provide an important portion of the evidence to judge the effectiveness of the proposed degradation mechanisms." Each ISB application is site-specific, and a pilot-scale field demonstration may proceed without a laboratory treatability study if site conditions demonstrate the applicability of ISB technologies. Figure 4-1 is a system schematic of a pilot-scale field demonstration. It was developed by the Remediation Technology Development Forum for the Dover Air Force Base ISB pilot test.

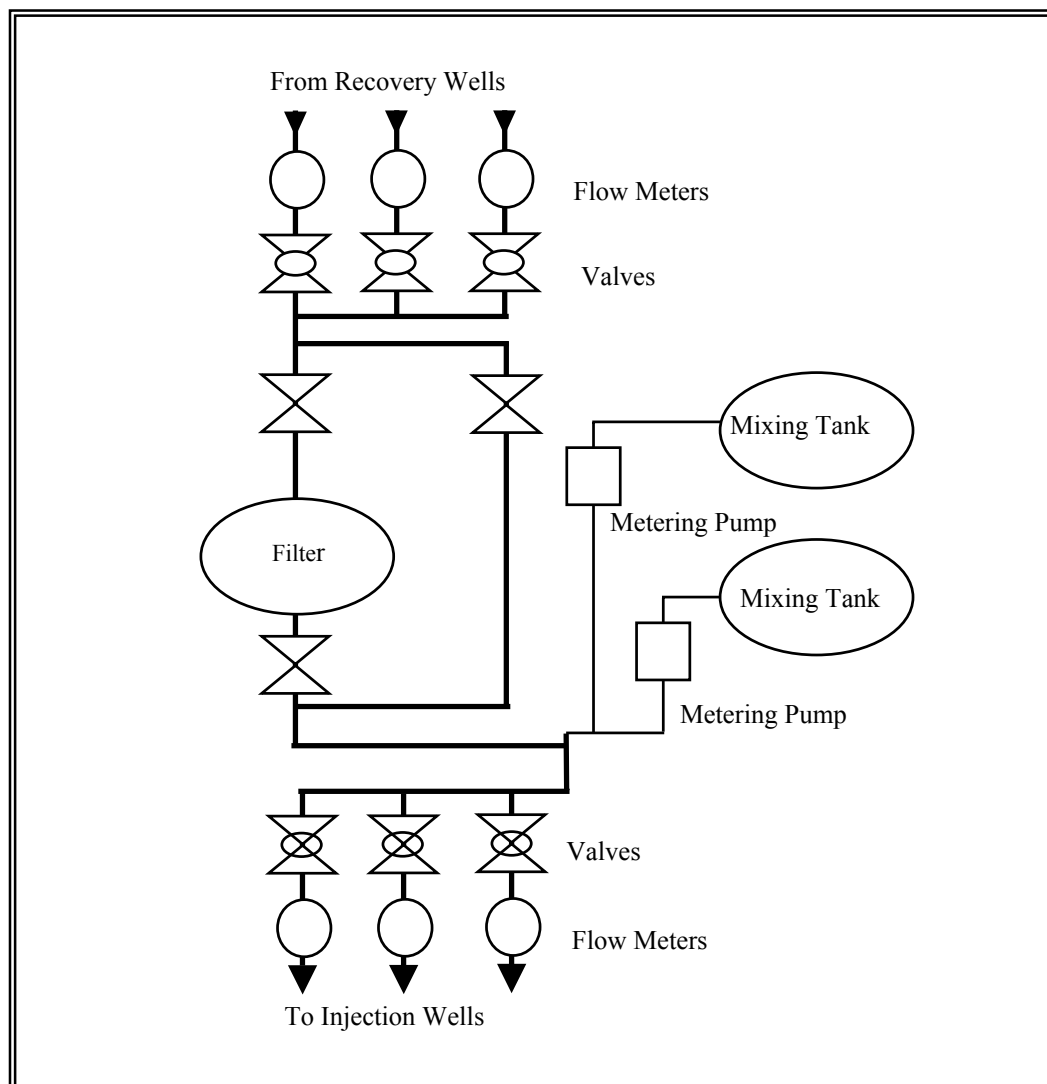

**Figure 4-1. Field Demonstration System Schematic Example**

#### 4.4.7 Biofouling

Biofouling is attributed to the increase in microbial populations and perhaps more importantly to the creation by cells of extracellular polysaccharides. These slimy polysaccharides are important for the accumulation of microorganisms on surfaces or within porous media and can contribute significantly to biofouling of a formation or injection well.

The increase of biomass during *in situ* remediation presents a challenge to system design and operation. A portion of amendment goes to the creation of new bacteria (biomass). Eventually, continued unchecked bacteria growth is likely to reduce circulation and injection of the amendment and may lead to a plugged formation or injection well (i.e., biofouling). Various operating strategies have been devised to minimize this potentially undesirable outcome. These methods are not formalized, but rather various engineering approaches have been used over the years. No one approach is a clear winner; however, it is an issue that must be considered in system design and operation.



Several options for reducing biofouling have been used in the past. These include pulsed amendment addition (pulsing alternately with amendment and amendment-free water), addition of oxidizers (e.g., hydrogen peroxide) and/or acids, use of CO<sub>2</sub> “freeze” injection, manual “scrubbing” of injection or extraction well screens, and injection of biocides.

In the pulsed amendment system, the addition of donor and nutrients such as nitrogen and phosphorus are staggered or offset in time to enhance movement of the donor in the subsurface prior to nutrient injection. This technique attempts to limit the collocation of donor and nutrients at the point of injection, thereby reducing (in theory) the necessary microbial amendments at the immediate point of injection. Between the pulse of donor and nutrient, “fresh” groundwater is added to flush the components through the system. The groundwater mixes these pulses of donor and nutrients eventually making them coincide in time and space to yield more optimal conditions for ISB. Careful flow and transport modeling is required to perfect this type of system.

The addition of small amounts of oxidizers, such as hydrogen peroxide or bleach, has been practiced. In this scenario, the oxidizer is added mid-screen at the injection well, circulated with a peristaltic pump or manual mixer around the screen, allowed to stand overnight, and then is pumped out. This is followed by injection of “fresh” groundwater to flush any remaining oxidizer from the injection well. This technique is used to destroy (oxidize) unwanted biomass buildup on, and in close proximity to, injection well screens. Such techniques may be used for either aerobic or anaerobic systems, with particular care exercised with anaerobic operating systems so as not to destroy the downgradient, established microbial colonies. Also, the tandem use of concentrated acids (sulfuric) subsequent to oxidizer removal to further destroy and slough-off biofouling microbes has also been practiced.

Another technique, manual scrapping of well screens, generally is simple to implement but is applicable only to relatively shallow-depth injection wells (i.e., less than 60 ft to 70 ft deep). This technique consists of use of a “squeegee” mounted onto a retractable, screw-type connection pole. The device is manually lowered into the injection well with additional pole sections added as needed to reach the well screen and agitated to scrape off biomass buildup on the injection screen. The removed biomass is then pumped out of the well. While simple to use, this technique is intended only for use on the interior of well screens and is, therefore, limited in application and effect.

A newer technique of injecting liquid CO<sub>2</sub> has appeared in recent years. With this technique, a packer (fitted with a CO<sub>2</sub> conveyance device) is inserted above the screened interval, and liquid CO<sub>2</sub> is injected under high pressure. The theory is to freeze the biofouling biomass on the screen and immediate vicinity of the well packing, destroy it, and then extract the biomaterial via a pump through well redevelopment. This technique has met with some limited success in specific applications.

Another new technique is the injection of biocides mixed with carbon and nutrient amendment. Adding a biocide may appear counterproductive when biotic stimulation is desired. However, biofouling occurs at the injection point, which in turn eliminates proper mixing and distribution of the amendment. The addition of a biocide prevents biomass accumulation at the injection point, thereby allowing the amendment to begin mixing within the saturated zone. These biocides typically degrade within a short period of time and are not a contaminant themselves.

An example of this utilization has recently been conducted at Aberdeen Proving Ground, Maryland (Millar, et al., 2001).

#### 4.4.8 Amendment Mixing

The addition of amendments to contaminated groundwater sites can increase the rate or extent of contaminant degradation. Amendments may include addition of electron donors, electron acceptors, or nutrients (e.g., nitrogen, phosphorus). The absence of any one of these amendments may have been the single factor that has been limiting biological activity. For example, available electron donors for biological denitrification often limit nitrate transformation in groundwater. The addition of organic carbon (i.e., acetate) can provide an electron donor, thereby enhancing nitrate degradation. Selection of appropriate amendments and treatability studies requires a thorough investigation of the biogeochemical factors at specific sites.

Delivery and Mixing of Bioremediation Amendments: Two main obstacles to enhancing ISB are delivery and mixing of bioremediation amendments. Biodegradation of contaminants requires the presence of contaminant-degrading bacteria, plus appropriate concentrations of electron acceptors, electron donors, and microbial nutrients such as nitrogen and phosphorus. In some situations, the contaminant itself may serve as the electron donor, in others as the electron acceptor. If a required component is absent, the biodegradation process slows and even stops. Consequently, the focus of a successful remediation system is to design an effective delivery process that will produce adequate amendment mixing in the subsurface treatment areas.

Ex Situ Mixing: One approach is to mix the amendments above ground and then inject the mixture into the subsurface. This approach assures good mixing of amendments but requires a distribution system to deliver mixed amendments to the subsurface. Conventional wells or infiltration trenches can serve as delivery systems into relatively permeable formations. Pneumatic or hydraulic fracturing under certain circumstances have been shown to be effective at increasing amendment delivery effectiveness into fine-grained silt and clay formations. Recirculation systems also can take advantage of *ex situ* mixing of amendments prior to reinjection.

In Situ Mixing: Subsurface mixing of amendments occurs primarily by the physical processes of fluid flow and diffusion of dissolved components from high to low concentration areas. These processes are increasingly restricted as the soil particles become smaller. Increasing the contact surfaces between high and low concentration zones can increase the rate of diffusion. Pneumatic and hydraulic fracturing under certain circumstances can be used to speed distribution and mixing of subsurface fluid components, especially in fine-grained formations since they produce more permeable areas where fluid flow rates and mixing are increased and increased surface areas where diffusion will take place. Pulsed injection of fluids into the subsurface can also enhance mixing.

## **5.0 ISB FULL-SCALE IMPLEMENTATION**

If a pilot-scale field demonstration shows that ISB is an effective remediation technology in an acceptable time frame, approval of a full-scale ISB project is greatly simplified. That is, permits are easily modified from the pilot-scale field demonstration, specific hydrogeologic information

is obtained, and the full-scale design does not typically require considerably more engineering than the pilot-scale field demonstration.

## 5.1 Economics

ITRC has completed a document entitled [\*Cost and Performance Reporting for In Situ Bioremediation Technologies\*](#) (ISB-5), 1997. This document describes a reporting methodology to obtain comparable information regarding costs and performance associated with different types of ISB technologies, including an easy-to-use reporting template. Please use this document to document the economics of ISB systems.

The Federal Remediation Technologies Roundtable (FRTR) has developed a document that is helpful in evaluating the cost and performance of remediation technologies. This document, entitled *Guide to Documenting Cost and Performance Information for Remediation Projects*, may be useful in determining the performance measures for any site-specific ISB system. It can be found at <http://www.frtr.gov/cost/pdf/guide.pdf>.

FRTR has compiled case studies from specific sites that have deployed enhanced ISB. These reports provide a cost and performance value for each site, along with site information and cleanup authority. For instance, at an abandoned manufacturing facility, molasses (an electron donor) was injected into the subsurface to bioremediate trichloroethylene (TCE). Concentrations of TCE in on-site wells decreased by 99% using bioremediation, for an overall project cost of approximately \$400,000 (FRTR, 1998). To view a list of numerous case studies, visit the FRTR Web site [under cost and performance](#).

Another excellent reference for cost and performance is a paper by Gary E. Quinton, et al. (1997), which describes a consistent manner for documenting cost and performance for a template site. This reference also shows the comparative costs of various remediation technologies for the noted template site given as present costs, cost per pound of contaminant removed, and cost per 1,000 gallons treated water using a discounted cash flow analysis.

## 5.2 Site Specificity

Site-specific data and information plays an important factor in the decision to deploy ISB systems. The purpose of defining and evaluating site-specific data is to determine whether a particular site may be suitable for implementation of ISB. The ISB system goals should be clearly defined prior to site characterization. Such goals include cleanup levels, time constraints, and cost. Prior site characterization data should be available and evaluated for the potential to design and apply ISB. In most cases, some additional specific site characterization data may be needed to locate the ISB implementation target area and to decide upon the appropriate type of delivery, degradation mechanisms, and amendments.

The major elements of an ISB site-specific characterization include review of existing site data, development of work plans, hydrogeological and geochemical characterization, source area characterization, and plume characterization. Once this information is obtained, a good site conceptual model is developed by incorporation of such data. Based on these data, a decision to go forward with ISB can be made. A more detailed discussion of site-specific data is found in the

ASTM Method D5730-96, *Standard Guide for Site Characterization for Environmental Purposes with Emphasis on Soil, Rock, the Vadose Zone, and Groundwater*.

### 5.3 Risks/Liabilities

Risks and liabilities are always a major issue for any remediation system. Perceived risk involved with implementing ISB systems relates to the lack of knowledge of these systems by some parties involved. Also, responsible parties may be concerned that contingency plans requiring traditional remediation systems may need to be implemented. The concern that ISB has not yet been universally accepted as a viable remediation technology is a perceived risk along with public concerns and the risk of plume migration onto other properties during the course of *in situ* treatment. All these concerns should be addressed if ISB systems are to be deployed. Risks and liabilities vary among sites and should be well identified and resolved prior to selecting an ISB remediation system.

### 5.4 Performance Monitoring

A good understanding of the specific contaminant's stoichiometry, kinetics, and transformations is essential to develop an appropriate monitoring plan. An ISB monitoring plan does not deal with contaminant concentration reduction alone. ISB byproducts (degradation products, CO<sub>2</sub> production, geochemical changes, etc.) must be understood, identified on site, and quantified to show that ISB systems are remediating the contaminant plume and to identify needs to modify the system. Monitoring should include amendment additions, flow rates, injection rates, and maintenance and operations. Each system and the associated monitoring program will be site-dependent, and the monitoring program should reflect that.

## 6.0 LIMITATIONS

Any remediation technology has certain limitations, and ISB is no different. If data collected during the site characterization and feasibility assessment (hydrology, geology, biology) does not support an ISB system, then other technologies must be assessed. Many times land use may be a limiting factor as to which remediation technology is chosen. Land use conditions may solely dictate the remediation technology used. For instance, if a plume is threatening a receptor, then a permeable reactive barrier or plume containment may be installed as a first response action. However, ISB systems may be deployed as part of a treatment train. If access to properties is restricted, ISB may not be the remediation technology of choice. An economic evaluation of all remediation technologies appropriate for the contaminated site is essential. Also, public understanding of ISB systems is critical prior to implementation. If stakeholders of a contaminated site do not accept or support ISB systems, then the success of regulatory approval and deployment decreases substantially.

The following table shows advantages versus limitations of ISB and is taken from EPA's *Engineered Approaches to ISB of Chlorinated Solvents* (EPA, 2000).

**Table 6-1. Advantages and Limitations of ISB**

ADVANTAGES	LIMITATIONS
Capability to degrade chlorinated aliphatic hydrocarbons to relatively less toxic products	A perceived lack of knowledge about biodegradation mechanisms
Generation of relatively small amounts of remediation wastes, compared to <i>ex situ</i> technologies	Specific contaminants at a site may not be amenable to ISB
Reduced potential for cross-media transfer of contaminants commonly associated with <i>ex situ</i> treatment	Enhanced technologies, when needed, may be costly or their implementation may be technologically challenging
Reduced risk of human exposure to contaminated media, compared to <i>ex situ</i> technologies	The toxicity of transformation products may exceed that of parent compounds
Relatively lower cost of treatment compared to excavation and disposal, <i>ex situ</i> treatment or conventional pump-and-treat systems	Could take longer to remediate site than a conventional technology
Potential to remediate a site faster than with conventional technologies	

## 7.0 ISSUES AND SOLUTIONS

The regulatory issues related to this document are broad simply because this document is intended to be flexible enough to be applied to the evaluation of ISB for any contaminant or any site. However, there are specific regulatory issues related to ISB. ISB is still considered by many as an emerging technology and, thus, current regulations have either not been amended to deal with these specific issues or the interpretation of the regulations are opposed to ISB. The following subsections describe these issues and provide solutions.

### 7.1 Federal Regulations and Policies

There are regulatory barriers that impede the implementation of ISB systems. One of the principle barriers is appropriate documentation of ISB systems for regulatory approval. The decision tree assists in solving this issue. A major regulatory issue is the reinjection of contaminated water or the injection of amended water into the subsurface. RCRA, CERCLA and the Safe Drinking Water Act, and any state authorizations of SDWA and RCRA provide the most burdensome of these regulatory issues.

#### 7.1.1 Resource Conservation and Recovery Act (RCRA) 3020

Reinjection under RCRA 3020(b) states “...contaminated groundwater must be treated to substantially reduce hazardous constituents prior to reinjection.” The ITRC document ISB-6

concluded that it was unclear whether this requires both treatment and a reduction of contaminant levels prior to injection, or just substantial treatment prior to injection, with the ultimate result being a reduction in contaminant levels within the aquifer.

Several states and EPA offices have interpreted RCRA 3020(b) to mean that ISB technologies could not be deployed and maintain full compliance with the literal language of RCRA 3020(a) and (b). ITRC escalated the issue among its membership and in fall 1999 achieved a consensus among 15 states to issue a letter from ITRC to EPA seeking clarification of the issue of reinjection of amended contaminated groundwater to encourage *in situ* remediation. California worked independently yet in parallel with ITRC to encourage this clarification from EPA.

In response to ITRC's and California's requests for clarification, Elizabeth Cotsworth, Director of EPA's Office of Solid Waste, issued on December 27, 2001, an EPA Guidance Memorandum, *Applicability of RCRA 3020 to In Situ Treatment of Ground Water*, clarifying EPA's policy on the injection of contaminated groundwater. This memorandum states that reinjection of treated groundwater to promote *in situ* treatment is allowed under 3020(b) [*emphasis added*] as long as certain conditions are met. Specifically, the groundwater must be treated prior to reinjection; the treatment be intended to substantially reduce hazardous constituents in the groundwater—either before or after reinjection; the cleanup must be protective of human health and environment; and the injection must be part of a response action under CERCLA Section 104 or 106 or a RCRA corrective action intended to clean up the contamination. The memorandum notes that the addition of treatment agents (such as nutrients) to extracted groundwater prior to reinjection constitutes “treatment” prior to reinjection. This memorandum can be viewed on the [Guidance Documents page](#) of the [ITRC Web site](#).

### 7.1.2 SDWA Underground Injection Control

Established through the Safe Drinking Water Act, the Underground Injection Control (UIC) program describes requirements intended to protect the nation's drinking water sources when fluids are injected into the subsurface. Five classifications of wells, I through V, are used to distinguish among UIC well function and design. Class V wells are wells that do not fit into the other classifications of UIC wells.

ITRC's ISB Team, during development of *Technical and Regulatory Guidance for In Situ Bioremediation of Chlorinated Solvents in Groundwater* (ISB-8), determined that under the UIC program, injection of any fluid into a well is prohibited except as authorized by a permit or rule.

Nonhazardous Constituents: If the injected fluid contains a nonhazardous “waste” contaminant, the injection wells used for remediation are generally designated as Class V according to 40 CFR 144.80(e) under the UIC program. For example, the use of the product toluene or phenol is not prohibited by federal or state regulations when they are being administered as a “product” rather than as a “waste”.

Normally Class V wells require no permit as they are authorized by rule according to 40 CFR 144.24). However, 40 CFR 144.12 and 144.82 state:

...your injection activity cannot allow the movement of fluid containing any contaminant into U.S. drinking waters if the presence of that contaminant may

cause a violation of the primary drinking water standards under 40 CFR Part 141, other health-based standards, or may otherwise adversely affect the health of persons. This prohibition applies to your well construction, operation and maintenance, conversion, plugging, closure, or other injection activity.

This may cause you to obtain a permit and exclude your well from the permit by rule provision. All states surveyed by ITRC during 1996–1997 (OR, KS, CA, TX, NJ, NM) indicated that injection well permits, or substantial compliance with Class V permit requirements, would have to be obtained/approved for an enhanced *in situ* bioremediation project involving injection for remediation purposes. Additional states surveyed in 1998 concurred with the findings of the previous survey.

Reinjecting Hazardous Contaminants: If the injected fluid contains a hazardous waste, and the fluid is being injected into an aquifer, the well is defined as a Class IV injection well (40 CFR Part 144.6). 40 CFR Part 144.13 specifically prohibits construction of Class IV wells, with some exceptions. One of these exceptions is injection of treated groundwater for CERCLA and RCRA cleanups. 40 CFR 144.13(c) states:

Wells used to inject contaminated groundwater that has been treated and is being reinjected into the same formation from which it is drawn are not prohibited by this section if such injection is approved by EPA pursuant to provisions for cleanup of releases under the Comprehensive Environmental Response, Compensation, and Liability Act of 1980 (CERCLA), 42 U.S.C. 9601 – 9657, or pursuant to requirements and provisions under the Resources Conservation and Recovery Act (RCRA), 42 U.S.C. 6901 through 6987.

Other exceptions from Class IV prohibition include

- injections into aquifers that underlie the lowermost formation containing a drinking water supply (40 CFR 144.13(d)(1)).
- wells used to inject hazardous waste into aquifers where no underground source of drinking water exists within one quarter mile of the injection point (40 CFR 144/13(d)(2))

In all instances, the injection wells must comply with Class I UIC criteria (40 CFR 146 Subpart B).

The effective prohibition of most underground reinjection of contaminated groundwater at non-CERCLA and non-RCRA sites continues to represent a significant regulatory obstacle. This obstacle may force the use of an alternative means of reinjection, such as horizontal drilling and trickle injection nests below the surface to distribute the amendment. This may be less effective than true vertical injection.

Certain technical requirements would likely be imposed as part of the injection well permit. These include the establishment of a “containment area” of extraction and/or monitoring wells near the site perimeter to monitor the effectiveness of the treatment technique. At least two states (KS and OR) indicated in the 1997 survey that they would require some demonstrated evidence of containment through approved hydrologic modeling. It is likely that the material added to the batch injection would have to be analyzed by a state-approved laboratory prior to mixing. It is

also likely the regular monitoring and reporting of results to the UIC approval authority would be required.

## 7.2 State Regulations and Policies

The following table describes the state statutes, regulations, and policies that govern ISB systems in the respective states of state regulators represented on the ISB Team.

**Table 7-1. State Regulatory Requirements for ISB**

State	Statute	Regulation	Policy	Comments
New Mexico	Water Quality Act, Chapter 74, Article 6 NMSA 1978	Water Quality Control Commission Regulations 20.6.2 NMAC	Draft MNA	Pollution Prevention Permits (Discharge Plans) are issued for injection of amendments
North Dakota	Underground Injection Control Program, Chapter 33-25-01, North Dakota Administrative Code	Sections 16, 17, 18		ISB wells are permitted by rule, if part of a remediation project with oversight by NDDoH.
Virginia				Regulates ISB under each program like hazardous waste, surface water, and other remediation programs. Allows injection only for the purpose of remediation.
Missouri	Clean Water Act, 10 CSR 20-6	Class III Mineral Resources Injection/Production Well Operating Permits		



State	Statute	Regulation	Policy	Comments
Kansas	K.S.A. 65-171D	Article 46		“The UIC Program issues a letter stating the proposed ISB wells meet UIC Program requirements for Class V wells. But the applicable Kansas Department of Health and Environment program retains authority for the overall approval and oversight of the remediation project. Some ISB wells may require a permit.”
Colorado	NA	NA	NA	Colorado defers to UIC under EPA although ISB is regarded as standard remediation tool
Oklahoma				Regulates ISB under each program like hazardous waste, CERCLA, solid waste, voluntary cleanup program, surface water, and other remediation programs. For each program, specific approval for UIC injection is needed.

### 7.3 *In Situ* Bioremediation Successes

“The 1996 and 1997 ITRC studies recognized the potential for regulators to resist selection of EISB (enhanced ISB) technologies because the biological mechanisms are complex and poorly understood by many in the regulatory community” (ITRC’s *Technical and Regulatory Requirements for Enhanced In Situ Bioremediation of Chlorinated Solvents in Groundwater* [ISB-6], p. 23). This poor understanding of ISB has changed substantially since 1996. Even though ISB is still considered by many as an innovative or emerging technology, regulators have taken great efforts to better understand the mechanism of ISB, regardless of the contaminant of concern. ITRC has been a strong leader in regulatory education concerning ISB. ITRC has delivered classroom training courses on monitored natural attenuation of chlorinated solvents and accelerated ISB of chlorinated solvents throughout the nation. Please refer to the ITRC Web site for training course schedules and times. Furthermore, ITRC offers two-hour, live Web-based training courses on ISB, natural attenuation, and this document. Go to [www.itrcweb.org](http://www.itrcweb.org) for future classroom and Internet-based training opportunities.

### 7.4 Public Comments/Concerns

The public stakeholders affected by contaminants in groundwater include property owners who have drinking wells affected by a plume, to property owners whose wells may be receptors if a plume’s spread is not contained, to those who live over the vadose zone of a plume of contaminants. Stakeholder concerns range generally from health effects to the physical and time attributes of the chosen remediation technology. For tribal stakeholders, there may be other concerns having to do with their cultural and spiritual beliefs regarding the land and water.

Stakeholder involvement throughout the process and the presentation of information in a manner easily understood by most lay persons are critical to adequate involvement. The parameters of data collection should be shared with stakeholders so that there is agreement that all relevant information necessary for site characterization modeling and performance monitoring is gathered on a timely basis.

The public must be informed from the beginning if there is to be a risk-based assessment or if the site is to be cleaned up to some other legally required level. In other words, the “rules of the game” must be decided upfront, and the public must have the opportunity to have input into the decision prior to data compilation for the purpose of risk-based cleanup versus that required for a legal standard required in state or federal law.

The public should understand the various advantages and disadvantages of ISB and the various alternative treatment methods, as well as

- understand the various assumptions that will be used in the groundwater model.
- be informed if the ISB technology is to stand alone or is to be part of a treatment train to reach the desired end.
- be presented with a visual idea of what the ISB technology will require logistically, such as drill rigs, power supply, and number of truck trips required to deliver materials to or from the site.
- be given noise implications of the technology selected.
- have discussions on the mass balance implications of each technology selected and will want information on the potential for the generation of daughter products. For instance, if hydrogen sulfide or methane might be generated by an ISB technology, will there be a gas collection system installed? How long will it operate?
- understand how each technology will affect water table levels, flow rates and directions of groundwater flow.
- know that a technology may have the potential of changing the hydrogeology of the area, hydraulic conductivity, or gradient.
- understand the risk of the technology pushing contaminants deeper into the aquifer or bedrock or volatilizing the contaminant and allowing its migration into the vadose zone.
- understand the length of time for remediation and the design and expected performance of the monitoring system.
- understand the monitoring requirements for post closure

## **7.5 Contingency Plans for ISB**

Many ITRC state regulator members have commented that ISB remediation systems are being approved. However, contingency statements in those approvals indicate that if ISB does not work, then the responsible party will have to revert to other applicable remediation technology(ies) for site remediation. These other technologies may include zero-valent iron permeable reactive barriers, slurry walls/containment systems, or older remediation technologies including such systems as pump and treat for containment or air sparging. When a responsible party views these contingency statements, he may prefer to propose a more conventional, known (and perhaps problematic) remediation technology instead of ISB, even though ISB remediation systems may be cheaper and achieve closure criteria sooner. Due to the relative emerging nature of ISB, the responsible party may not feel as comfortable with a newer remediation technology

and, therefore, be hesitant to propose ISB. This perspective is changing due to the fact that many ISB remediation systems have proven that the technology can achieve established closure criteria. ITRC and other training efforts are educating the environmental community and helping the technology to be better understood and become more widely accepted and deployed.

## 7.6 Health and Safety Issues

“Although safety issues are generally not the primary drivers for selecting a site cleanup technology, safety issues should be considered when evaluating cleanup alternatives.” (ITRC, *Phytotechnology Technical and Regulatory Guidance Document*, 2001) For ISB systems, health and safety issues should be evaluated for site assessment activities, such as well installation, management and handling of extracted groundwater when the COC is a health or safety issue, and the handling and management of any biocide that may be used to prevent or manage biofouling. Most MSDSs can provide the health and safety information necessary for the COC and biocides. If hydrogen peroxide is chosen as a biocide for biofouling treatment, please refer to ITRC's [\*Technical and Regulatory Guidance for In Situ Chemical Oxidation of Contaminated Soil and Groundwater\*](#) (ISCO-1), 2001, pp. 9–11.

## 7.7 Site Closure Criteria

Site closure criteria are always a significant issue. Understandably, a site may be closed when regulatory standards have been met for a specified period of time, and ISB may meet those standards in a shorter time frame than other technologies. However, since enhanced ISB remediation systems normally create change in the geochemistry, such as alkalinity, dissolved oxygen, perhaps dissolved metals, or specific ions, site closure may not be granted until those parameters are converted to either meet standards or conditions that will not be detrimental to human health or the environment.

An example of closure criteria is taken from the Pennsylvania Department of Environmental Protection's Act 2 Regulations for confirming site cleanup for groundwater. (Pa Code 25, Ch. 250):

Groundwater cleanup may be demonstrated by showing no statistically significant exceedance of the risk-based cleanup standard at the point of compliance via quarterly sampling/analysis for two years (a lesser period of time may be proposed if groundwater flow regime so warrants and relevant statistical tests are utilized and met). At this stage, a request for site closure (i.e., conformance with Act 2) will be made and confirmed.

Another example of closure criteria taken from the New Mexico Environment Department's Water Quality Control Regulation (NMAC 20.6.2.4103.D) addresses the completeness of subsurface and surface water abatement:

Abatement shall not be considered complete until a minimum of eight (8) consecutive quarterly samples from all compliance sampling stations approved by the secretary meet the abatement standards.

Furthermore, if ISB is deployed in conjunction with other technologies (treatment train), closure will occur when all remediation technologies have met the closure criteria.

The bottom line for closure is that the site meets regulatory standards. If a risk-based approach is approved, scheduled monitoring of the site may be required even if the ISB system has been shut down.

## 8.0 A SYSTEMATIC APPROACH TO *IN SITU* BIOMEDIATION OF NITRATE

Following is a flow diagram and supporting documentation for applying *in situ* bioremediation to groundwater contaminated with nitrate. It is a continuance from the site characterization flow diagram represented in Figure 1-1 of this document. The documentation describes nitrate pervasiveness, health and ecological effects, sources, and site parameters and criteria needed to evaluate the effectiveness of *in situ* biodegradation. Following the site characterization diagram, this section further defines fate and transport of nitrate and provides a decision path for evaluating *in situ* bioremediation of nitrate. This section does not deal with nitrate in the vadose zone. Regulatory concerns are presented, along with a site-specific example of a field test for enhanced *in situ* bionitrification (EISBD).

Barring site-specific data, all indications point to EISBD as a remediation alternative for nitrate-contaminated groundwater. The following decision tree flow chart and text will guide the reader to understand and evaluate aspects of decision making to deploy EISBD.

The overall objective of this decision tree is to identify potential limiting factors of EISBD, show when microcosm tests are warranted, show regulatory concerns, illustrate the implementation of a pilot field test, and ultimately determine if a full-scale EISBD system is practical and deployable. The first step in this decision tree is to define site ORP conditions. If the reader refers to the main document in Section 3.1.1 and reviews Figure 3-1, ORP measurements can be taken to determine which constituent will be the electron acceptor. From that figure, nitrate serves as an electron acceptor at an ORP rate of approximately 750 mv, after oxygen has been depleted. Therefore, if the ORP is less than 750 mv, it is likely that nitrate will not be present in groundwater since it has already denitrified to N<sub>2</sub> gas.

The next step is to determine the dissolved oxygen concentration. If the DO concentration is above 2 mg/L, it needs to be reduced. This can be achieved by adding a carbon source. Please refer to Section 8.4.1, “Carbon Amendment Stoichiometry,” to identify a potential carbon source. If a carbon cannot be selected from literature review, a laboratory treatability test should be performed to identify the best carbon source for that particular site. Please refer to Section 4.4.4 for discussion on laboratory treatability tests and Section 8.4.1 for an example. This test will also help determine any limiting nutrient requirements (specifically phosphorous) and other inhibitors that might limit or preclude deployment of EISBD. From site characterization data and data from the laboratory treatability test, a site conceptual model can be developed. Permitting requirements should be satisfied prior to deployment of an EISBD pilot field test. These requirements are described in ITRC’s technology overview of EISBD, [Emerging Technologies for Enhanced In Situ Bionitrification \(EISBD\) of Nitrate-Contaminated Ground Water](#), (EISBD-1), 2000, Sect. 8.0. If the pilot field test is successful, EISBD should be scaled up for full deployment.

Figure 8-1 In Situ Bioremediation of Nitrates

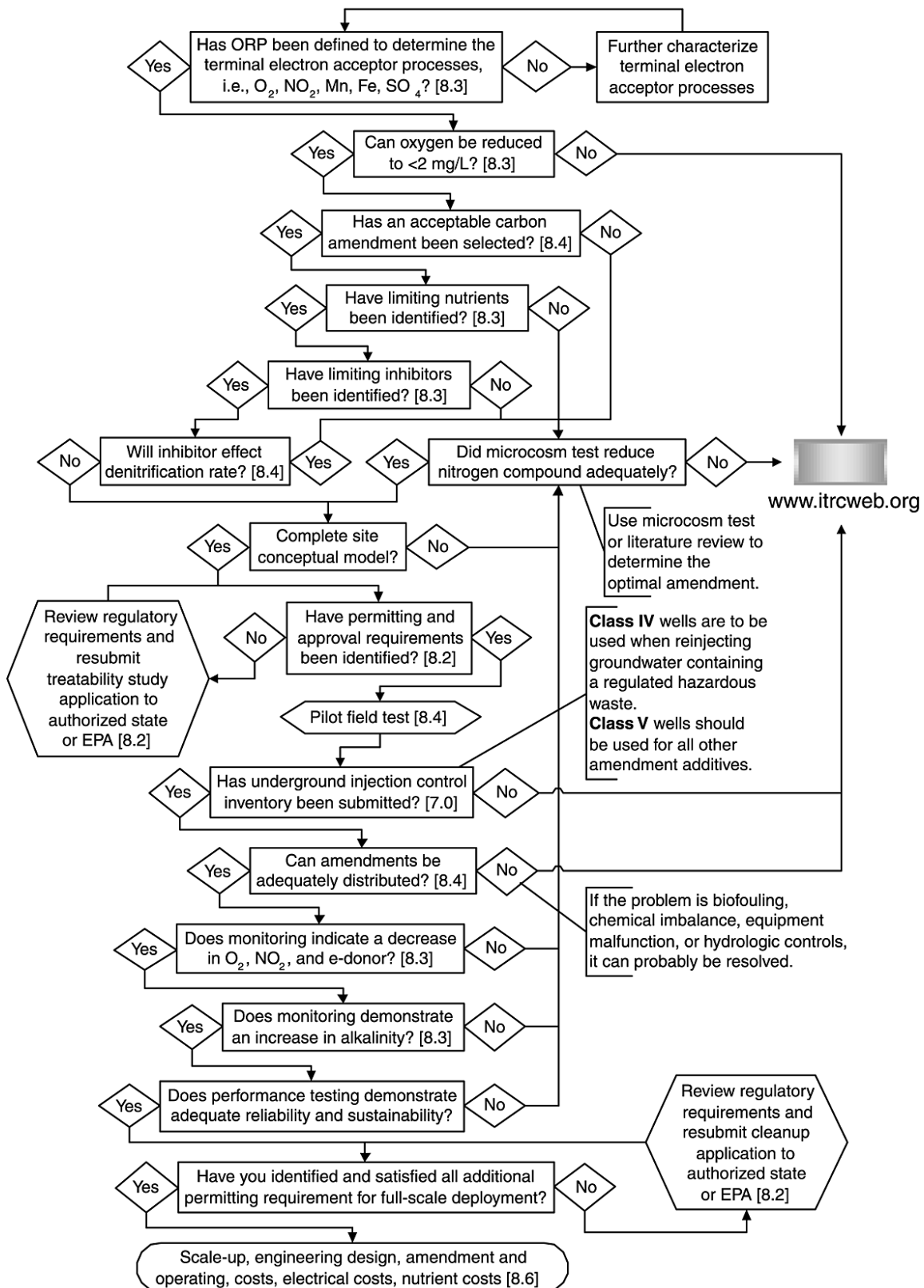

## 8.1 Pervasiveness of Nitrate Contamination

Nitrate is the most pervasive groundwater contaminant in the United States. EPA estimates that 2.4% of private wells exceed 10 mg/l nitrate concentration as a national average. A 1994 study of Midwestern states showed that 13.4% of domestic well samples exceed the nitrate standard. A study of 268 wells in southeast Nebraska showed 71% of wells exceeded the standard (Meyer, 1994). Monitoring data from 21 state drinking water regulatory agencies showed that over 1,000 water suppliers reported at least one well or tap water sample above the nitrate MCL. In New Mexico alone, 81 public water supply wells have exceeded the MCL (ITRC-EISBD, 2000).

## 8.2 Contaminant Background

### 8.2.1 Sources of Nitrate Contamination

Nitrogen may be added to the soil through fertilizer, animal and human waste, organic matter, or anthropogenic influences such as explosives and chemical wastes. Nitrate from human waste originates mostly from individual septic systems or municipal wastewater treatment facilities. Waste from dairies, open feedlots, confined feeding operations, stockyards, and other facilities for raising and holding animals is also a potential source of nitrate and other forms of nitrogen.

Nitrogen is the most common element used as a fertilizer supplement for commercial crops, turf, and gardens. Nitrogen fertilizer normally takes one of two forms: commercial fertilizer and or animal waste. Animal waste has been applied to cropland for generations, both as a means of fertilization and waste disposal. Commercial fertilizer usage in the United States has become commonplace in the last half of the 20<sup>th</sup> century with the advent of anhydrous ammonia, liquid nitrogen, and similar formulations that have greatly increased crop yields. In some cases, fertilizer has been over applied, either from a lack of understanding or good information about crop nutrient requirements, or as a relatively inexpensive “insurance policy” against unpredictable conditions that may leave crops short of nutrients. When over applied or over irrigated, nitrate’s high solubility and low sorption allow infiltration beyond the root zone in excess of plant requirements. Thus, infiltration resulting from excess precipitation or irrigation water easily transports nitrate to groundwater. Elevated groundwater nitrate levels have occurred in heavily farmed areas as a result of this process. Nitrification of ammonia from fertilizers and ammonia volatilization can contribute to surface contamination by nitrate.

Nitrogen is a major element in the manufacture of blasting agents, primarily utilizing ammonium nitrate and diesel fuel. Without proper management and treatment, waste streams that contain high concentrations of ammonium nitrate can cause groundwater quality degradation. In some instances, this waste stream, along with improper handling of the ammonium nitrate, has created nitrate contamination. Waste streams from explosive manufacture contain nitrogen concentrations ranging from 200 mg/l to over 1,000 mg/l. Ordnance testing grounds and weapons manufacturing, loading, packing, and transportation sites that were operated by or for DOE or DoD have historically used nitrogen compounds. The major nitrogen compounds that pose an environmental threat are 2,4,6 trinitrotoluene (TNT); 2,3,5-trinitro-1,3,5 triazine (RDX); and oxyhydro 1,3,5,7-tetranitro-1,3,5,7-tetrazocine (HMX) (Townsend and Meyers, 1996). These compounds may contribute to nitrate-contaminated groundwater. It is believed that since the manufacturing of these compounds utilize nitrogen compounds, nitrate may be present in high concentrations as an impurity. Furthermore, washout processes for the decommissioning of these

explosives has caused nitrate contamination, along with nitro-aromatics. Nitrate concentrations in groundwater at these sites may range from 20 mg/l to over 200 mg/l.

It is unusual for pristine groundwater systems to accumulate more than 3 mg/l nitrate (Madison and Brunnet, 1985). However, naturally occurring processes may cause nitrate contamination in groundwater. The breaking up of prairie grasslands caused a huge flush of nitrate out of the root zone into groundwater. One example occurred in Texas where the natural range soils consisted of buffalo grass that formed a symbiotic relationship with nitrogen-fixing bacteria. When these range lands were tilled for dry land row crops, the nitrogen in organic matter derived from buffalo grass turf was oxidized. This nitrate accumulated in underlying groundwater at concentrations of 100 to 1,000 mg/l (Chapelle, 1993). Plowing the prairie grasslands caused a flush of nitrate from the root zone to groundwater in some areas of the Great Plains. Equilibrium has usually been reached in five to 10 years, at which time nitrogen sources have been significantly depleted without additional nitrogen sources.

During lightning storms, atmospheric nitrogen is converted to nitrate, and very low concentrations (<1 mg/l) are deposited to the soil through rain. In arid conditions, high-nitrate concentrations may be caused by evaporation of infiltrating rainwater in the shallow subsurface. During storm events, this high-nitrate concentration may be transported to the shallow aquifer, where nitrate concentrations in groundwater have been observed up to 60 mg/l (McQuillan, 1995). Nitrate concentrations in groundwater  $\geq 10$  mg/l may also be attributed to geologic formations. Sedimentary deposits with high organic matter may release nitrogen. In New Mexico, two limestone formations have been identified with naturally occurring groundwater nitrate concentrations between 12–15 mg/l (Titus, 1980), although this observation is uncommon.

Nitrogen compounds are used extensively in industrial settings. Some of the predominant nitrogen compounds used in industry are anhydrous ammonia, aqua ammonia, nitric acid, ammonium nitrate, ammonium nitrate solution, and urea. Some of the industrial uses are manufacturing of plastic and intermediates; metal processing; raw material in the textile industry; acid production; textile bleaching; petroleum refining; refrigeration; production of pulp, paper, and rubber; as a catalytic agent in manufacturing processes; household cleaners; metal polishes; metal impurity extraction; emulsifiers; slurries; water gels; cold packs for the medical field; adhesives such as in the particle board industry; resins such as in the cosmetic and fiberglass industry; deicing; and nitric acid used in many industries for various purposes (ITRC-EISBD, 2000).

### 8.2.2 Properties of Nitrate

Nitrate is a major anion that is primarily in the aqueous phase in both the vadose and saturated zones of the subsurface. Nitrate is nonsorptive and for the most part does not exchange on sediment surfaces in the vadose zone or groundwater. It has a very low probability of retardation onto soil colloids. Nitrate solutions tend to move through soils at virtually the same speed as the wetting front in the vadose zone or with groundwater flow. Nitrate tends to move unhindered and unchanged through a soil profile or aquifer matrix (Bohn, et al., 1979).

There are three major forms of nitrogen in the soil and vadose zone that may cause nitrate-contaminated groundwater: organic nitrogen, ammonia nitrogen, or nitrate aqueous in pore

water. MSDS information is attributed to anthropogenic sources of nitrate, such as ammonium nitrate ( $\text{NH}_4\text{NO}_3$ ) and potassium nitrate ( $\text{KNO}_3$ ) and is represented in the following table. The MSDS CAS number for nitrate is 014797-55-8.

**Table 8-1. Properties of Nitrate Compounds**

Properties	Ammonium Nitrate ( $\text{NH}_4\text{NO}_3$ )	Potassium Nitrate ( $\text{KNO}_3$ )
Appearance	Colorless crystal	White crystal
Odor	odorless	odorless
Solubility	70g/100g water @21°C	36 g/100g @21°C
Specific Gravity	1.73 @ 23°C	2.1 @ 23°C
pH	5.4	~7.0
% Volatiles by volume @ 21°C	0	0
Boiling Point	210 °C	400 °C
Melting Point	170 °C	333 °C
Vapor Density (Air=1)	No information	3.00
Vapor Pressure (mmHg)	No information	Negligible
Evaporation Rate (BuAc=1)	No information	No information

(MSDS information taken from Mallinckrodt Baker Inc.)

### 8.2.3 Contaminant Relationships

Nitrate contamination has been found to be associated with many other contaminants, including volatile organic compounds. During the investigation of volatile organic compound (VOC) contamination, nitrate contamination is present in background concentrations. Since nitrate contamination is so pervasive, it is not surprising that its detection has occurred during the investigation of other COCs. For ISB systems, denitrification has been observed and documented at many sites where VOCs have served as electron donors and the nitrate has served as an electron receptor.

Of particular interest to this document is the contaminant relationship with carbon tetrachloride. In many rural and agricultural regions, nitrate contamination is commingled with carbon tetrachloride plumes due to past use at grain silos. The relationship of these two contaminants is important to ISB systems. Even though carbon tetrachloride is an organic compound, it rarely serves as an electron donor in reductive ISB systems. One reason is that carbon tetrachloride contamination is usually present in part per billion concentrations, thereby providing little available carbon for denitrification. However, if a suitable electron donor is introduced to the subsurface, both carbon tetrachloride and nitrate may serve as electron acceptors depending on the ORP conditions. It has been observed that once hydrogeologic conditions become reductive due to another suitable electron donor, carbon tetrachloride may serve as an electron donor if the initial electron donor becomes depleted and adequate concentrations of carbon tetrachloride remain present (McQuillan, et al., 1998). This reductive destruction of both contaminants is advantageous to the problem holder since both regulated compounds are destroyed.



Nitrate-contaminated groundwater has been found in the presence of pesticides (e.g., Atrazine) associated with agriculture. In animal feeding operations (e.g., dairies, hog farms), nitrate contamination may be found in association with chloride, total dissolved solids, sulfates, and ammonia. Various contaminants discharged to septic tank/leachfields have been observed along with nitrate, such as detergents, high sulfates and sodium, and even solvents. Nitroaromatics (i.e., TNT, DNT, RDX) plumes may contain high concentrations of nitrate. Explosives manufacturing processes that utilize the blasting agent ammonia nitrate and diesel/fuel oil have also contaminated groundwater with all three compounds. Perchlorate plumes have also been observed to be associated with nitrate contamination. For instance, at a southern California site, concentrations of nitrate and perchlorate were about 20 ppm and 310 ppb, respectively (Hatzinger, et al., March, 2002).

#### 8.2.4 Regulatory Standards for Nitrate

In most pristine or near pristine environments, nitrate concentrations in groundwater are < 3 mg/l. Through the federal Clean Water Act, EPA has established drinking water standards for nitrate at 10 mg/l nitrate-nitrogen (NO<sub>3</sub>-N). This standard applies to all public supply systems. Numerous states have established a groundwater standard for nitrate (ITRC's [EISBD-1](#), 2000, Appendix B). The European Union under the Nitrate Directive has established a drinking water standard for nitrate at 50 mg/l (11.3 mg/l NO<sub>3</sub>-N) (EC 4739/A.1).

### **8.3 Site Description/Characterization**

Adequate site characterization is required at any nitrate-contaminated site prior to remediation. The following section discusses site characterization as it relates to enhanced *in situ* biodenitrification (EISBD). This section discusses which geochemical parameters should be characterized and why for EISBD.

#### 8.3.1 Hydrogeologic Environment

All hydrogeologic conditions at the site should be defined (i.e., vadose zone source, lithology, K) and measured to estimate the movement of fluids and solutes through the subsurface. Since nitrate is an anion with practically no sorption qualities, there is no need to define the K<sub>OW</sub>, K<sub>OC</sub>, K<sub>D</sub>, or the R<sub>f</sub>.

#### 8.3.1 Geochemistry

Nitrate reduction occurs during anaerobic respiration. In the absence of oxygen and the presence of a carbon source, bacteria utilize the nitrate as an electron acceptor during respiration. The nitrate is converted to nitrite (NO<sub>2</sub>) during anaerobic respiration, with the subsequent formation of innocuous nitrogen gas. EISBD is a remediation technology whereby a carbon source is introduced to a nitrate-contaminated aquifer. Since most aquifers are aerobic, the introduced carbon is used by indigenous aerobic bacteria as a carbon source (electron donor), and oxygen is the electron acceptor. The dissolved oxygen in the aquifer becomes depleted, forming anaerobic conditions. When carbon remains in excess, indigenous denitrifying bacteria proliferate and reduce nitrate to nitrogen gas.

Since low dissolved-oxygen conditions are necessary for EISBD to occur, the following geochemical parameters should be identified: nitrate, alkalinity, DO, pH, ORP, phosphorous, and possibly dissolved iron and manganese, and total organic carbon. The following table describes the importance of geochemical parameter identification for EISBD.

**Table 8-2. Analytes Important in Evaluating *In Situ* Bioremediation of Nitrate**

PRIMARY ANALYTE	REASON FOR ANALYSIS
Nitrate/nitrite	The COC can expect a decrease in concentration if bioremediation is occurring.
Alkalinity	Due to microbial respiration production of CO <sub>2</sub> , can expect an increase in alkalinity from background.
Dissolved Oxygen	For EISBD to occur, DO concentrations must be suppressed (<2 mg/l).
pH	For EISBD to occur effectively, pH ranges can vary considerably (6.0-8.5).
Redox	Redox will indicate which parameter serves as an electron acceptor (nitrate will be e <sup>-</sup> acceptor near ORP of 750 mv).
Dissolved Manganese and Iron	If dissolved manganese is present, indicates Redox is too low and matrix Mn/Fe is serving as e <sup>-</sup> acceptor.
Phosphorous (P)	For EISBD to occur effectively, P needs to be available for microbial metabolism.
Total Organic Carbon	TOC analysis will indicate availability of naturally occurring carbon sources (e <sup>-</sup> donor).

### 8.3.3 Contaminant Degradations/Microorganisms

Nitrogen may undergo chemical degradations before it is transported into groundwater. The major divisions of the nitrogen cycle are mineralization, immobilization, nitrogen fixation, ammonification, nitrification, and denitrification. The soils conversion of mobile nitrogen species to organic forms is termed immobilization. Mineralization is the conversion of complex organic nitrogen to simple inorganic molecules. Nitrogen may be present in the soil moisture in the predominant form of ammonium (NH<sub>4</sub>). Ammonia may be metabolized by organisms, assimilated by plants, exchanged by clay minerals and/or organic matter, and oxidized to nitrate. Nitrification is the biochemical oxidation of NH<sub>4</sub><sup>+</sup> to nitrate. In the presence of specific bacteria and oxygen, ammonia is enzymatically oxidized in a stepwise process to NO<sub>2</sub> followed by nitrate:

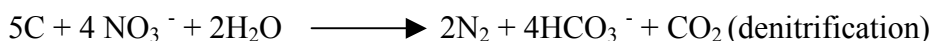

\*R signifies an organic compound.

In addition to the nitrogen degradations described above, ammonium can be reduced to dinitrogen gas at the expense of nitrate by certain anaerobic bacterial consortia. This process, termed the anammox reaction, can be described by the following equation:

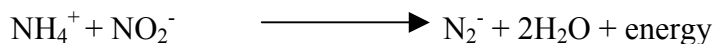

To date, anaerobic ammonium oxidizing bacterial consortia have only been found at wastewater treatment plants with anoxic treatment reactors and high ammonium loading. However, these bacteria may also exist in natural environments under appropriate conditions.

In addition to denitrification to produce dinitrogen gas, nitrate can be reduced to ammonium by certain anaerobic bacteria. This process, termed dissimilatory nitrate reduction to ammonia, occurs under very reduced conditions. Analysis of nitrogen fluxes in a variety of soils and sediments suggest this is not a major pathway for nitrate reduction under most environmental conditions.

Nitrification occurs in oxidizing environments. Denitrification is usually initiated when the dissolved oxygen levels are less or equal to 2 mg/l. Nitrate is enzymatically reduced in a stepwise reaction to nitrogen gas such that:



Five electrons are consumed in this process.

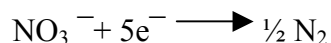

Nature has evolved indigenous denitrifying bacteria capable of converting nitrates in subsurface environments, i.e., soils and groundwater, into harmless nitrogen gas; however, the process can be very slow, requiring decades or centuries to complete due to the lack of a carbon energy source for bacterial growth. EISBD is accomplished by stimulating indigenous denitrifying bacteria through the addition of a suitable carbon energy source. Carbon substrates, such as methanol, ethanol, acetate, and sugar, can significantly enhance denitrification rates by serving as electron donor and energy supply for the indigenous bacteria while nitrate is the electron acceptor. In the metabolic denitrification process, nitrate is transformed into the final product of nitrogen gas. Usually, it is found that nitrite is the most significant intermediate, while NO and N<sub>2</sub>O are short-lived. In practice, the dissolved oxygen is also an electron acceptor and is microbially reduced prior to denitrification.

During denitrification, nitrite is about 10 times more toxic than nitrate, and if it is not completely reduced to nitrogen gas (N<sub>2</sub>), must be oxidized back to nitrate if the water is to be used for drinking. Therefore, it is critical in EISBD to monitor for nitrite so if necessary it can be treated *in situ*.

The following thermodynamic diagram (Eh/pH) shows the stability of the nitrogen species in groundwater systems. This diagram helps identify under what conditions nitrate and nitrite are thermodynamically stable. For instance, nitrite is stable in a very limited area of Eh and pH; therefore, it is unusual to find stable nitrite in a groundwater system. According to the diagram, nitrite can only be present within the Eh range of approximately 0.9 V to 0.00 and a pH range of

0 to 14. Note that each line in this range is decreasing, and the nitrite range is very limited. Note however it is possible in a kinetic-controlled dynamic situation to see nitrogen species outside of the stable zones. The inserted box identifies the Eh/pH range for most groundwaters. It is generally more difficult to change the pH than the Eh. Therefore, EISBD is a biological method to microbially catalyze the reductive degradation of nitrate into harmless nitrogen gas. According to Eh/pH principles, the most stable nitrogen species should be nitrogen gas.

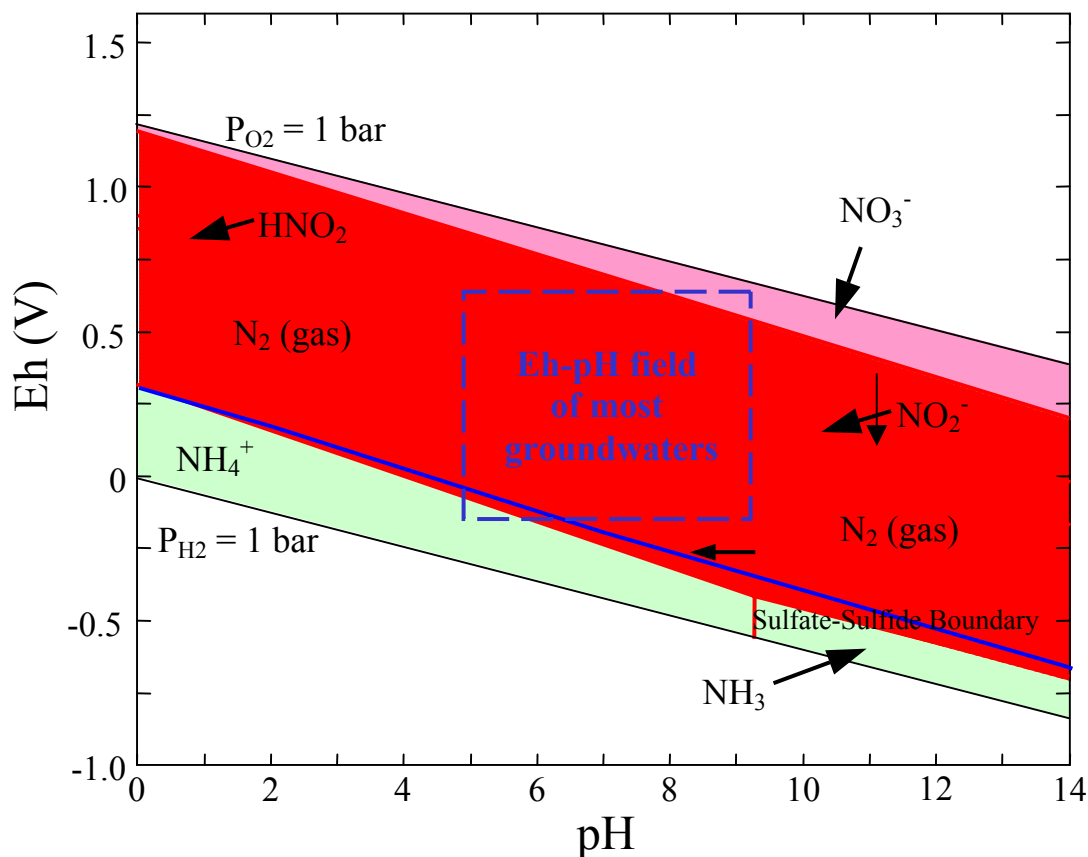

**Figure 8-2. Partial Eh-pH Diagram of the N-O-S-H System**  
(The assumed activity of dissolved nitrogen =  $10^{-2}$  and  $P_{N_2} = 0.8$  bar.)

### 8.3.4 Receptors

As stated above, the nitrogen cycle is a natural process whereby nitrogen compounds are converted in a sequential process to ammonia, nitrite, nitrate, and in the absence of oxygen, to nitrogen gas. During EISBD, it is essential and critical that this process be taken to completion. That is, the nitrate contamination must be denitrified to nitrogen gas with no residual nitrite remaining. If the process is not taken to completion, there is a risk that the nitrite formed will remain. Nitrite is much less desirable than nitrate contamination. If nitrite remains in groundwater, it may pose a threat to any receptors that have been identified due to increased toxicity. Nitrate- or nitrite-contaminated water should not be consumed either through drinking or used in cooking. The risk is only in ingestion of contaminated groundwater. There is no inhalation or dermal risks to consider with nitrate-contaminated water. Human receptors of nitrate or nitrite may experience health concerns defined above. The same holds true for

ecological receptors. Again, for EISBD to be considered successful, the denitrification process must be taken to completion.

#### 8.3.4.1 *Adverse Human Health Effects*

Nitrate-contaminated groundwater's only proven health effect, methemoglobinemia (blue baby syndrome), is regulated in public water supplies as a primary contaminant of concern under the federal Safe Drinking Water Act. Blue baby syndrome is a disease generally resulting from the ingestion of high concentrations of nitrate in its inorganic form. In the stomach and small intestine of individuals with very low stomach acidity, indigenous bacteria chemically reduce the nitrate to nitrite, a more reactive form of the compound. Nitrite is absorbed through the walls of the small intestine into the blood stream where it combines with hemoglobin to form methemoglobin, which blocks the oxygen-carrying capability of the blood. When the concentration of methemoglobin becomes too high, the victim becomes cyanotic and can die of asphyxiation. The body does not have the capability to naturally change the methemoglobin back to effective hemoglobin. This condition targets infants below the age of six months while on a pure milk (or infant formula) diet. The cause of blue baby syndrome is generally the mixing of infant formula with water containing high concentrations of nitrate (greater than 10 mg/l nitrate as nitrogen).

Although methemoglobinemia is the only disease that is currently directly attributable to elevated nitrate concentrations, there are other suspected negative health effects that have been potentially connected to this contaminant. Chief among them is the possibility of spontaneous abortions in women of childbearing age (Centers for Disease Control and Prevention, 1996).

A positive association with bladder cancer from drinking nitrate-contaminated water and an association with ovarian, uterine, and rectal cancer has recently been identified (Weyer, et al., 2000). Another health concern, which has been under study for many years, is a possible link between nitrate contamination of drinking water and non-Hodgkin's lymphoma and stomach cancer. Although this link is very tenuous and controversial, research and surveys are ongoing in an attempt to document the link (Blair, et al., 1997).

Nitrate is identified as a possible cancer risk due to its degradations to nitrite in the body. Approximately 5% of ingested nitrate is converted to nitrite that can then combine with organic compounds to form N-nitroso compounds, which have been shown to be potent animal and human carcinogens (Blair, et al., 1997). Nitrite reacts in digestive acids with amines to form nitrosamines and nitrosamides which are believed to cause stomach and esophageal cancer (Spalding, et al., 1993).

#### 8.3.4.2 *Adverse Ecological Effects*

The effects of nutrient loading on water quality and productivity are particularly important for impoundments and natural lakes, which are often sources for municipal water supplies and water-based recreation. Levels of nitrate much lower than the MCL for drinking water contribute to increased rates of eutrophication in surface waters (Rabalais, et al., in press; Burkholder, et al., 1997).

## 8.4 Fate and Transport

### 8.4.1 Carbon Amendment Stoichiometry

Many different carbon amendments are used to stimulate denitrification in groundwater. Amendments such as ethanol, acetate, and sugar are most commonly used, although some regulated compounds such as toluene have also been shown to be effective. Listed below are the stoichiometric formulations as completed from half-cell reactions in McCarty, et al. (1969) for commonly used carbon amendments in denitrification:

#### Methanol

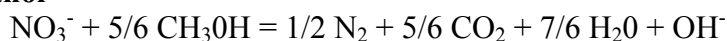

#### Acetate

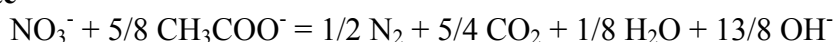

#### Ethanol



#### Acetone

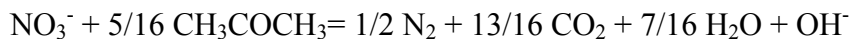

#### Sugar (sucrose)

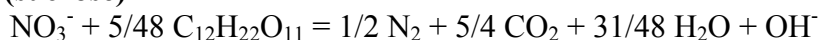

Each reaction shows the moles of amendment consumed in the stepwise reduction of one mole of nitrate to nitrite to 1/2 mole of nitrogen gas. When selecting carbon sources with proportionately lower carbon content, more moles of chemical amendment are consumed.

### 8.4.1 Kinetics (User Recipes)

For the regulator or consultant, these chemical formulations for denitrification have been converted into user-friendly recipes. Questions like what concentrations of these amendments are injected into groundwater to bring the water to compliance levels for potable water (10 ppm  $\text{NO}_3\text{-N}$ ) can be easily answered. Because nitrate concentrations are reported as N by EPA and the U.S. Department of Agriculture, Table 8-3 lists the amount of carbon amendment in milligrams necessary to completely denitrify an aqueous concentration of 1 mg  $\text{NO}_3\text{-N/L}$ . The amount of C-source consumed in denitrifying 1 mg  $\text{NO}_3\text{-N}$  can be multiplied by the nitrate-N concentration to estimate the required concentration of the carbon amendment.

**Table 8-3. Carbon Amendments Necessary to Completely Denitrify an Aqueous Concentration of 1 Mg/L Nitrate**

Chemical	Mol. Weight 1 m-mole (mg)	Mol. Weight 1 m-mole NO <sub>3</sub> <sup>-</sup> (mg)	Mol. Weight NO <sub>3</sub> <sup>-</sup> as N (mg)	Consumed C-amendment in denitrifying 1 mole NO <sub>3</sub> <sup>-</sup> (mg)	Consumed C-amendment in denitrifying 1 mg NO <sub>3</sub> -N (mg)
methanol	32.04	62.01	14	26.70	1.91
acetate	59.05	62.01	14	36.91	2.64
ethanol	46.07	62.01	14	19.20	1.37
acetone	58.08	62.01	14	18.15	1.30
sucrose	342.30	62.01	14	35.66	2.55

Factors consuming additional carbon include C-assimilation in cellular synthesis in the production of biomass and in the creation of an anaerobic aqueous environment capable of stimulating the heterotrophic bacteria to denitrify the nitrate. Estimates of the carbon consumed by biomass production average about 15% of the amended C-source. Deng (1998) has demonstrated that only small amounts of carbon substrate are assimilated into biomass after denitrification is initiated. Her data suggest that 30% of the carbon was assimilated during deoxygenation while only 10% of the C was assimilated during active denitrification. Dissolved oxygen consumed varies with its groundwater concentration, which in high nitrate zones usually ranges from 2 mg O<sub>2</sub> / L to saturation at about 10 mg O<sub>2</sub> / L. The methanol requirement for deoxygenation of 10 mg O<sub>2</sub> / L water is 8.7 mg CH<sub>3</sub>OH /L or 0.87 mg CH<sub>3</sub>OH /L per mg O<sub>2</sub> / L (McCarty, et al., 1969). Because of these additional consumptive processes, many investigators add an excess of from 20 to 40% of the C-amendment necessary to accomplish the desired denitrification. These estimates are close to the experimental results of Deng (1998), who described the following acetate and ethanol requirements for denitrification:

$$[\text{Acetate}] \text{ (mg/L)} = 3.00 [\text{NO}_3\text{-N}] + 1.59 [\text{DO}]$$

$$[\text{Ethanol}] \text{ (mg/L)} = 1.78 [\text{NO}_3\text{-N}] + 0.67 [\text{DO}].$$

Both Deng (1998) and Khan (2000) have demonstrated that acetate is superior to ethanol as a C-amendment because it is directly assimilated in cellular electron transport systems and thereby produces less clogging from biomass production. Increased observed biomass production during ethanol injections is related to the additional biomass formation in the degradation of ethanol to acetate.

These reactions typically produce bicarbonate and hydroxide. Most Midwestern and Western aquifers have enough buffer potential to counter significant increases in pH from the OH<sup>-</sup> and CO<sub>2</sub> production. Although it is debatable whether it is necessary to add phosphate in field situation, Deng (1998) has shown that it is advisable in laboratory experiments. In field experiments, phosphate additions have been unnecessary (Hamon and Fustec, 1994; Khan, 2000).

### 8.4.3 Modeling (Conceptual and Computer Model)

Fate and transport models are site-specific and must be developed accordingly. These models are representations of field conditions. As previously stated, the conceptual model is a simplified version of the particular site's groundwater system as inferred from the site characterization. Groundwater computer models are used to simulate and predict conditions regarding site-specific subsurface flow and transport, specifically to help determine amendment mixing, hydraulic control, biofouling control, first-order decay rates, travel times and directions, number and locations of recovery and injection wells, and flow rates to achieve EISBD. Since this decision criteria module for a systematic approach to ISB is site-specific, generic models are not applicable.

### 8.4.4 Feasibility

To establish the suitability of a site for EISBD, both a laboratory and a field pilot test may be implemented. The following two sections present a laboratory-scale treatability test for EISBD and an example of a field pilot test.

#### *8.4.4.1 Pilot-scale Field Demonstration*

The following discussion is taken, in part, from ITRC's EISBD Technology Overview document for a pilot-scale field demonstration in Albuquerque, New Mexico. The *in situ* denitrification site is a 40-year-old nitrate plume covering an area of about 220 hectares and a volume of 6.4 billion liters. Groundwater contamination was caused by over fertilization at a vegetable farm in the 1950s. The water table is at a depth of 22 meters, and the top of the aquifer contains a 10-meter nitrate contamination zone. The plume is moving very slowly in a sandy/loam soil aquifer with a hydraulic conductivity of about  $10^{-3}$  cm/sec. The average  $\text{NO}_3\text{-N}$  concentration in the groundwater is 90–110 mg/l. The groundwater pH is 7.4–7.7 with a temperature of 16–20 °C. At this site in 1980, a blue baby syndrome incident was reported.

The biotreatability of groundwater was first investigated in batch experiments in 160 mL closed serum bottles. The groundwater was collected from a single well located at a site within the plume. The required amount of NaAc was determined using equations (1) and (2). In practice, NaAc was added to provide a C/N ratio of 1.42–2.00. Sodium trimetaphosphate (TMP) was added to give a concentration of 15–20 mg/l. Further scale-up tests were performed in a 208-liter (55-gallon) drum and a 4542-liter (1200-gallon) tank using the same carbon substrate and phosphorus nutrient. Reaction times for complete nitrate removal ranged from 7–15 days as shown in Table 8.4.

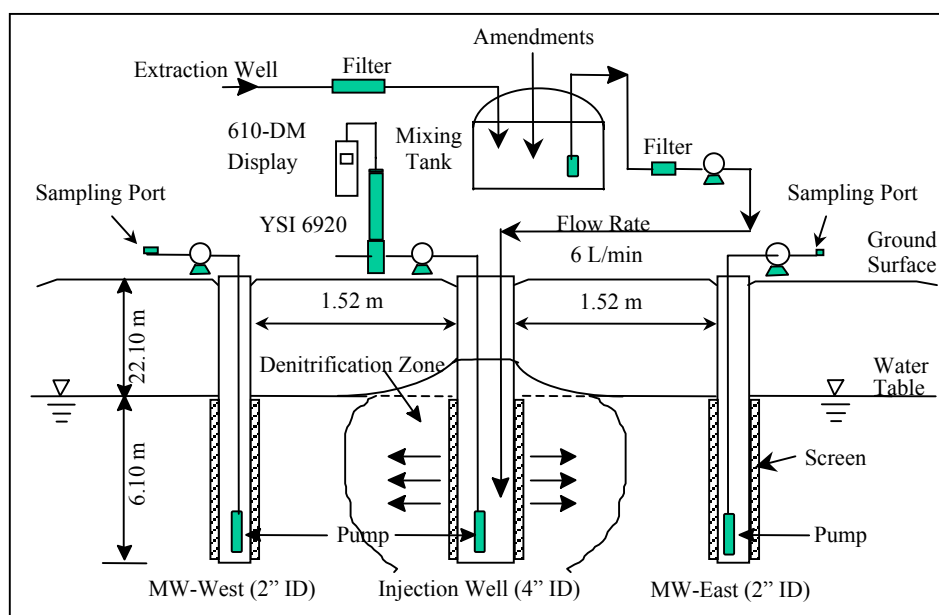

**Table 8-4. Aboveground Denitrification Scale-up Tests Using Indigenous Groundwater Bacteria**

(Acetate used as carbon substrate, TMP as phosphorus nutrient)

Reactor Type	Volume (L)	Scale Ratio	Total Nitrogen (mg/l) Initial // Final	Time (days) 20°C	Denitrification Efficiency(%)
Serum Bottle	0.12	1	99.4 // <0.1	7	100
Drum	200	1,667	101.6 // 1.1	7	99
Tank	4200	35,000	115.5 // <0.1	15	100

The schematic diagram for the push-pull *in situ* field test is illustrated in Figure 8-3. The test was designed to keep the reacting groundwater between the two monitoring wells. About 4200 L of contaminated groundwater was pumped out from an extraction well and mixed with NaAc and TMP in a mixing tank. A bromide tracer was used to follow dilution of the reacting groundwater. The amended groundwater with bromide as a tracer was recharged into the injection well at a flow rate of 6 L/min. The groundwater from injection and monitoring wells was sampled on a daily basis during denitrification. The postsampling was carried out every 15 days over a period of two months. The groundwater parameters of pH, conductivity, total dissolved solids (TDS), DO, and Eh were measured in the field by a YSI 6920 water quality monitor installed in the flow cell as shown in Figure 8-3.



**Figure 8-3. Design of an *In Situ* Denitrification Test at Tri-Tech Site, Albuquerque's South Valley (not drawn to scale)**

Figure 8-4 shows the concentrations of acetate, nitrate, and nitrite versus time for samples taken from the injection well during denitrification. All traces of nitrate and nitrite intermediate were removed in five days. The nitrate was metabolically transformed to  $N_2$  gas, and the final concentration in the four-inch monitoring well was near zero (less than 1 mg/l). During the experiment, some typical equipment deployment problems were encountered and solved. We also observed some biofouling. This topic is under investigation but is a common observation with ISB processes.

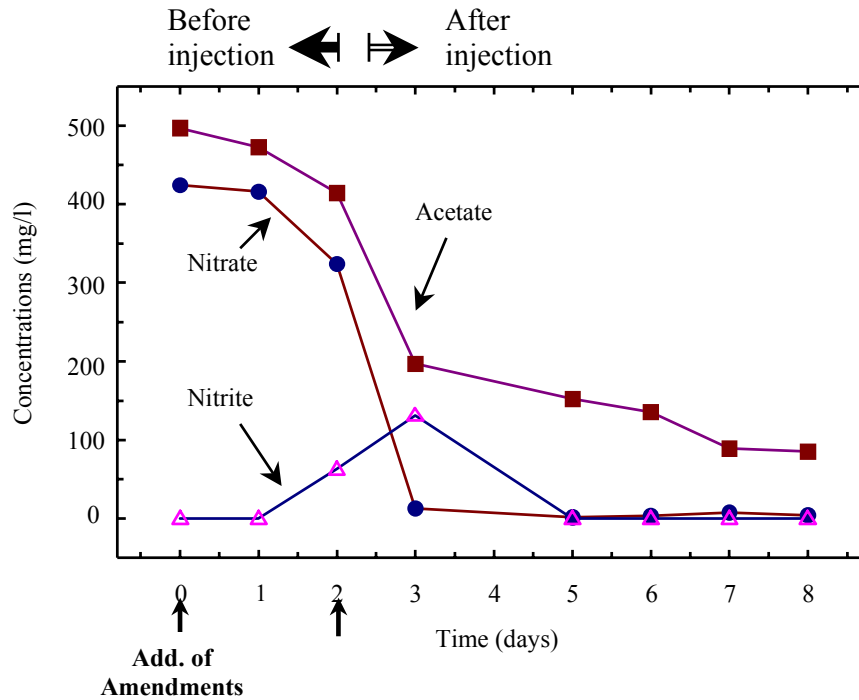

**Figure 8-4. Reaction Concentration Curves Resulting from Short-term Monitoring during and after an *In Situ* Denitrification Test**

Table 8-5 shows a comparison of average denitrification rates for three different process scales, indicating that *in situ* average denitrification is nearly three times the average rate of *ex situ* tests. The faster *in situ* denitrification is likely due to the significantly greater bacterial concentration in the aquifer matrix as compared to the bacteria concentrations in water samples.

**Table 8-5. Comparison of Average Denitrification Rates Using Acetate and TMP as Amendments**

Experiments	Temperature (°C)	Denitrification Time (days)	Average Denitrification Rate (mg N /L/day)
serum bottle test w/o sand	25	18	5.4
1200 gal tank test	20	15	6.9
<i>In situ</i> field test	20	5	19.0

Figure 8-5 shows the concentrations of acetate, nitrate, nitrite, and bromide versus time for water samples from the injection well over the two-month monitoring period. After the initial denitrification reaction was completed, the excess acetate was eventually consumed by further denitrification resulting from mixing of the surrounding contaminated groundwater. This was confirmed by the decrease in bromide tracer. During the second reaction period, the nitrate concentration remained low until all excess acetate was consumed.

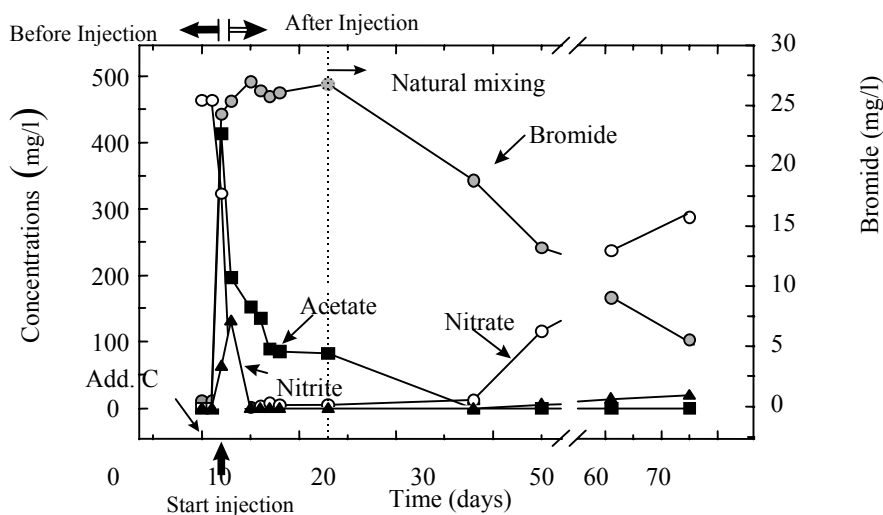

**Figure 8-5. Reaction Concentration Curves Measured during an *In Situ* Bionitrification Test**

The long-term monitoring of groundwater parameters of Eh, pH, conductivity, and DO were documented by Deng (1998). Results also indicated that the Eh, pH, and conductivity values returned to background levels following the push-pull field demonstration.

As a continuation of this successful batch field test, a small-scale continuous field test was completed in April and May 1999 (see Figure 8-6). The results were similar to those from the batch experiment.

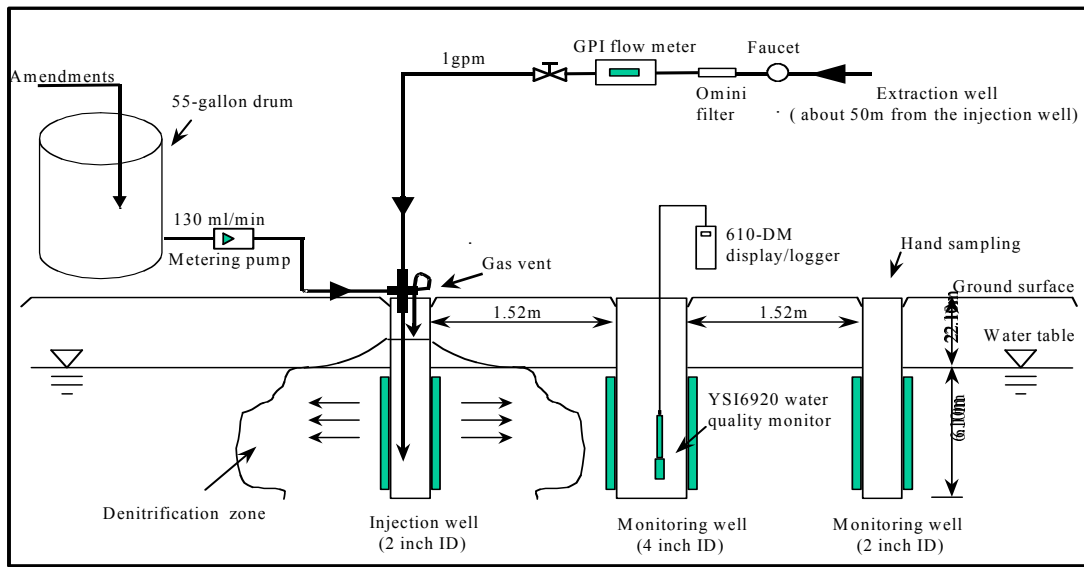

**Figure 8-6. Modified Schematic Diagram of a Continuous Denitrification Field Test**

The small-scale continuous test was successful and a larger-scale continuous field test closer to the heart of highest nitrate concentration (~250 mg/L NO<sub>3</sub>-N) was installed and initiated in March 2001. The schematic diagram for the continuous pilot-scale demonstration test is illustrated in Figure 8-7.

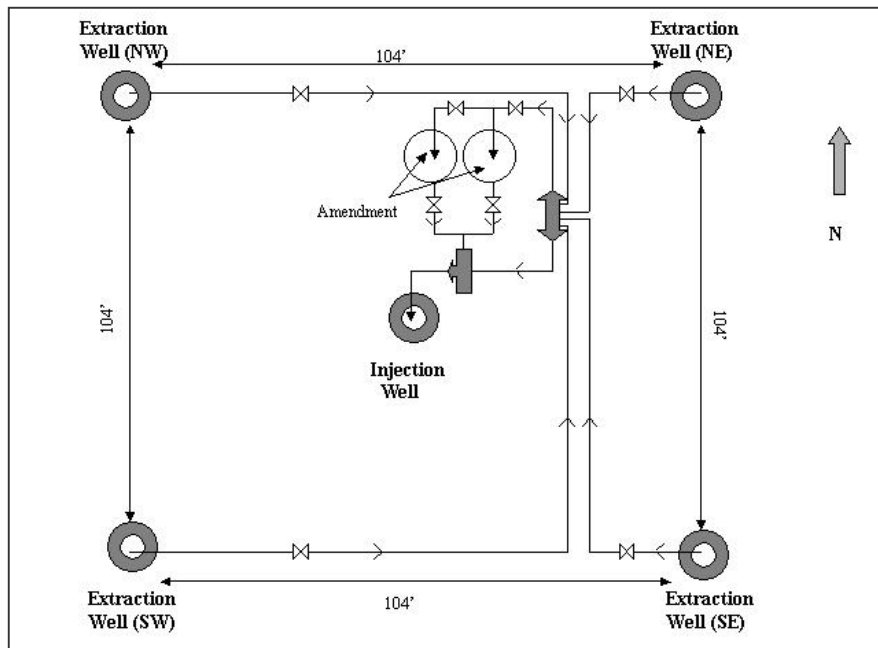
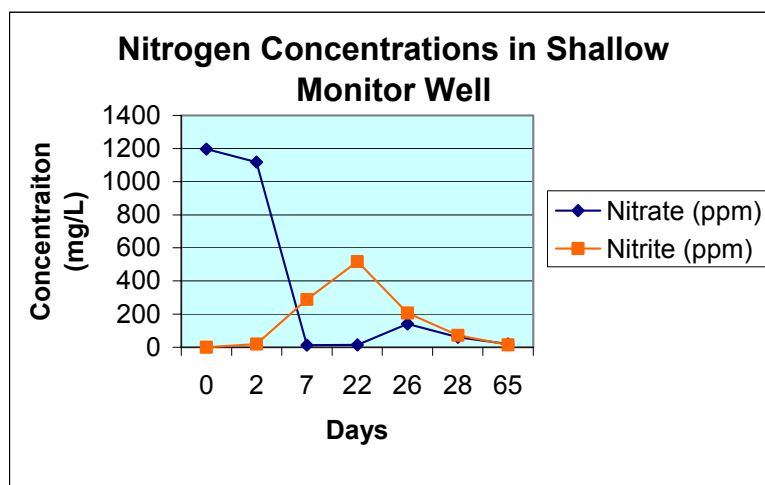

**Figure 8-7. Continuous Larger-scale Pilot Demonstration**

#### 8.4.4.2 Amendment Mixing of the Larger-scale Pilot Demonstration

This continuous pilot-scale demonstration extracts nitrate-contaminated water from the four extraction wells at a rate of 1.25 gallon per minute (gpm) per well, mixes the substrate into the stream flow, and injects the amended water into the center injection well. All wells were 4-inch-diameter PVC wells. Depth to water is approximately 47 feet below ground surface (bgs). Site lithology is composed of alluvial deposits ranging from clays to sands and gravels. Groundwater is first encountered in a poorly sorted sandy gravel formation. Clayey sand is at a depth of approximately 63 feet bgs. Nitrate contamination is below standards within the sandy clay aquitard and absent at adjacent monitor wells. Screens of all wells are from 43 to 63 feet bgs. Hydraulic conductivity at the site is approximately  $10^{-3}$  centimeters per second (cm/s).

The amount of substrate was calculated at the same C/N ratio as previously stated. Approximately 726 pounds of NaAc was injected between April 18 and June 27, 2001. Using a C/N ratio of 1.424, approximately 510 pounds of nitrate have been removed from the saturated zone. Analytical results from groundwater samples collected in a shallow monitor well near the injection well are represented in Figure 8-8. Note that within seven days the nitrate concentrations decreased to below compliance standards, and  $\text{NO}_2$  concentrations decreased to below standards in 28 days. Biofouling of the injection well occurred approximately 15 days following amendment injection, causing a decrease in the amount of amendment injected. This decrease in amendment addition did not provide adequate carbon source to the subsurface bacteria to reduce  $\text{NO}_2$  to  $\text{N}_2$  in the timely fashion that had been predicted. However, within 28 days enough carbon was available for denitrification to decrease  $\text{NO}_2$  concentrations to below standards.



**Figure 8-8. Analytical Results of Nitrate and Nitrite Concentrations in a Shallow Monitor Well following Continuous Injection at a Pilot-scale Demonstration**

#### 8.4.4.3 Biofouling

Amendment injection was sufficient to carry the reaction to completion with minor concentrations of  $\text{NO}_2$  remaining. However, biofouling of the injection well occurred following approximately 500 pounds of amendment injection. Even though only 10% of the NaAc was theoretically expected to form bacterial cell synthesis, the injection well became plugged. Following biofouling, the injection well could take approximately 2 gpm of amended water.

A series of hydrogen peroxide ( $\text{H}_2\text{O}_2$ ) injections were performed to rehabilitate the injection well. Initially,  $\text{H}_2\text{O}_2$  at 35% concentration was injected into the injection well and recirculated via a submersible pump. When the injection well failed to yield flow rates greater than 0.5 gpm,  $\text{H}_2\text{O}_2$  was injected in the adjacent (10 feet) shallow monitor well, and groundwater was extracted from the injection well to “pull”  $\text{H}_2\text{O}_2$  toward the biofouled injection well. Following this treatment method, the injection well yielded 1–1.5 gpm. Two additional monitor wells were installed equidistant (10 feet) from the injection well.  $\text{H}_2\text{O}_2$  was injected into the three monitor wells surrounding the injection well. After withdrawing approximately 2,000 gallons of water from the injection well, yield rates increased to 2–2.5 gpm. Further treatment with  $\text{H}_2\text{O}_2$  into the three monitor wells is planned to improve recovery rates to 4 gpm prior to reinjection of amendment. Following the injection well’s rehabilitation, a different amendment distribution strategy is being considered to prevent further plugging of the aquifer adjacent to the injection well.

#### 8.4.5 Amendment Mixing

As noted, a carbon source is required for denitrification to occur, and bioaugmentation is highly unlikely and unnecessary. To date both *ex situ* and *in situ* mixing of amendments for EISBD has been implemented. The above-mentioned pilot-scale field demonstration is an example of *ex situ* mixing. That is, the contaminated water is pumped to the surface, amendment is added to the stream flow, and the mixture is reinjected into the subsurface where *in situ* biodenitrification occurs.

*In situ* mixing has occurred on a limited basis, whereby amendment has been added to the subsurface. Dillution, dispersion, and natural groundwater flow are the main mechanisms to provide amendment mixing and distribution to the subsurface. Depending on site conditions, this may be a distribution process that demands longer periods of time for denitrification to decrease nitrate concentrations to below standards. *In situ* mixing may also require more than one treatment injection at different locations to achieve remedial goals. A recent pilot-scale field demonstration of EISBD used a passive amendment delivery system. A direct push drilling technique injected amended water under high pressure (250 psi) to a depth of approximately 60 feet. Approximately 8,000 gallons of NaAc and TMP amended water were injected into eight bore holes within three different zones of the saturated contaminated zone at a rate of 8 gpm. This method of injecting amended water under high pressure/high flow rate was ineffective at creating mixing, and there was amendment loss into the vadose zone. However, the amendment that reached the saturated zone resulted in rapid denitrification occurring fairly rapidly (<7 days), observed in an adjacent monitor well (Jones, 2001). Groundwater velocity was measured at 0.07 feet per day.

## 8.5 EISBD Alternatives

A narrative description of nitrate remediation alternatives is in ITRC's technology overview of EISBD ([EISBD-1](#), 2000, Sect. 4.0). These remediation options are no action, pump and beneficial use, pump and treat, pump and waste, phytoremediation, aboveground denitrification, and, of course, EISBD. Please refer to this document for more details.

## 8.6 Applicability of EISBD

The applicability of EISBD has been described in the technology overview document. It includes the following EISBD issues:

- ◆ Economics (Section 9.1)
- ◆ Regulatory (Section 8.0)
- ◆ Site Specificity
- ◆ Risks/Liabilities (Section 8.2)
- ◆ Performance Monitoring (Section 9.3)
- ◆ Public Concerns (Section 10.0)
- ◆ Closure Criteria (Sections 9.2, 9.3)

Please refer to this document for details.

## 9.0 A SYSTEMATIC APPROACH TO *IN SITU* BIOREMEDIATION OF CARBON TETRACHLORIDE

The purpose of the following sections is to apply the systematic approach to ISB to carbon tetrachloride. It defines the contaminant's pervasiveness, health and ecological risks, sources, and site parameters and criteria important to the evaluation of applying ISB for carbon tetrachloride. Following the general systematic approach to ISB, this section further defines fate and transport of carbon tetrachloride and provides decision flow diagrams to follow the most effective pathways for ISB of carbon tetrachloride. It is important to note that ISB technologies for the remediation of carbon tetrachloride are in the developmental stage. Few field applications have been completed. This document is intended to represent the current state of ISB for carbon tetrachloride. New information will be added as ISB applications are completed.

### 9.1 Decision Tree

The following decision tree and supporting documentation for applying ISB to remediate carbon tetrachloride is a continuance from the site characterization decision tree represented in Figure 1-1 of this document. Together, they provide a decision pathway to characterize the applicability of *in situ* bioremediation of carbon tetrachloride in groundwater. This document does not evaluate bioremediation in the unsaturated zone. The following two decision tree flow charts and text will guide the reader to understand and evaluate aspects of decision making for deployment of ISB for carbon tetrachloride. The overall objective of these decision trees is to identify potential limiting factors of ISB, define when laboratory treatability tests are warranted, describe regulatory concerns or barriers, encourage implementation of a pilot field test, and ultimately determine if a full-scale system containing *in situ* bioremediation is practical. This ITRC team

has identified major reductive pathways for ISB of carbon tetrachloride and presents the two most viable anaerobic pathways for biodegradation. One pathway is reductive dechlorination and the other is cometabolic. The cometabolic pathway may occur either through reductive dechlorination or denitrification. These pathways are described in Sections 9.1.1 and 9.1.2. The first decision tree describes reductive dechlorination through direct or cometabolic reduction, while the second decision tree describes a reductive denitrification/cometabolic pathway.



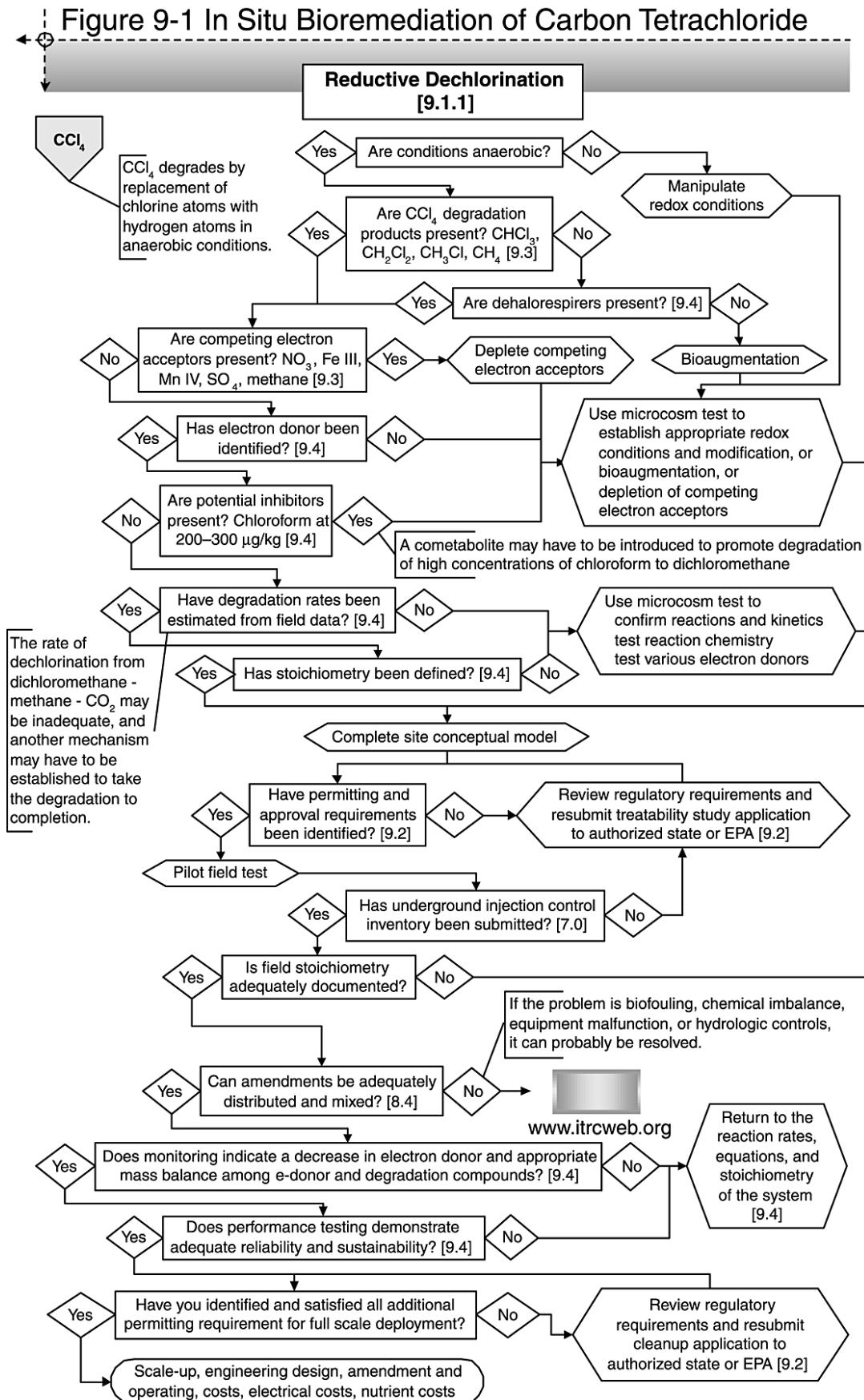

### 9.1.1 Reductive Dechlorination

The key to this pathway is the presence of degradation products and the need to carry this reduction to completion so that neither carbon tetrachloride nor its degradation products are above site closure criteria. Since this pathway can occur only under reducing conditions, the first question is, “Are current site conditions anaerobic?” If so, check for degradation products. If not, then a carbon source needs to be introduced to reduce ORP conditions. The presence of degradation products can be determined through laboratory treatability tests, which can also determine if halorespirers are present. If degradation products are present, then the next question becomes, “What are the ORP conditions; or better yet, what are the competing terminal electron acceptors?” These questions can be answered through monitoring during the site characterization process.

It is important to understand the effect ORP conditions have on the presence or absence of degradation products, and under what conditions one might expect these degradation products to degrade. Please refer to Figure 9-3 to review under what ORP conditions the practitioner may expect these products to appear or degrade. Competing electron acceptors need to be depleted for successful dechlorination of carbon tetrachloride. The laboratory treatability test will establish this, along with identifying the most suitable electron donor. Once these factors have been determined, the degradation rates should be established from site characterization data. Be aware that if no reductive dechlorination is evident from field data, the laboratory treatability test will provide expected degradation rates once the selected electron donor (carbon source) has been chosen.

From the field data or laboratory treatability test data, the site-specific stoichiometry can be defined. It is important to ascertain the concentration of electron donor and nutrients, if required, based on the laboratory treatability test for complete reductive dechlorination of carbon tetrachloride and its degradation products.

It should be pointed out that the first degradation product, chloroform (CF), may become an inhibitor to this process under certain methanogenic mixed cultures. Chloroform was shown to inhibit reductive dechlorination of cis-DCE and VC at concentrations as low as 77 µg/l (Maymo-Gatell, 2001). Chloroform has been observed to inhibit its own degradation and acetate consumption at approximately 330 µg/l under perhaps methanogenic conditions. The inhibition appears to be less under sulfate-reducing conditions at a concentration of approximately 2 mg/l (Gupta, et al., 1996). However, during another study, carbon tetrachloride degradation continued even when chloroform concentrations accumulated as high as 10 mg/L (Freedman, et al., 1995). Accumulated chloroform concentrations higher than 2 mg/l did not seem to inhibit carbon tetrachloride degradation in pure cultures of a methanogen, a sulfate reducer, and a clostridium species (Egli, et al. 1988). Bower and McCarty (1983) showed chloroform degradation occurred at 40 µg/l even though they observed carbon tetrachloride degradation around the same concentration. In a further study by Bower and McCarty (1983), it was shown that no chloroform degradation occurred at 60 µg/l, even though they saw carbon tetrachloride degradation at the same concentration under denitrifying conditions. Hansen showed that chloroform accumulation does not seem to inhibit degradation at carbon tetrachloride concentrations of 1mg/l if nitrate and acetate are not limiting (1993).

With a completed site conceptual model, a pilot field test should be conducted. Final permitting issues need to be completed prior to deployment of the pilot field test. The decision tree helps identify regulatory requirements of the application. During the field test, the practitioner should answer at least two issues related to enhanced ISB:

- Are the amendments properly distributed according to design?
- Did biofouling occur?

Corrections to the design are often made during this test. Please refer to Sections 4.4.7 and 4.4.8 for discussion on these issues. Results of the pilot field test should show whether reductive dechlorination of carbon tetrachloride occurred to completion, the electron donor was consumed, and if ISB of carbon tetrachloride will be sustainable. If so, the enhanced ISB system can be taken to full deployment.

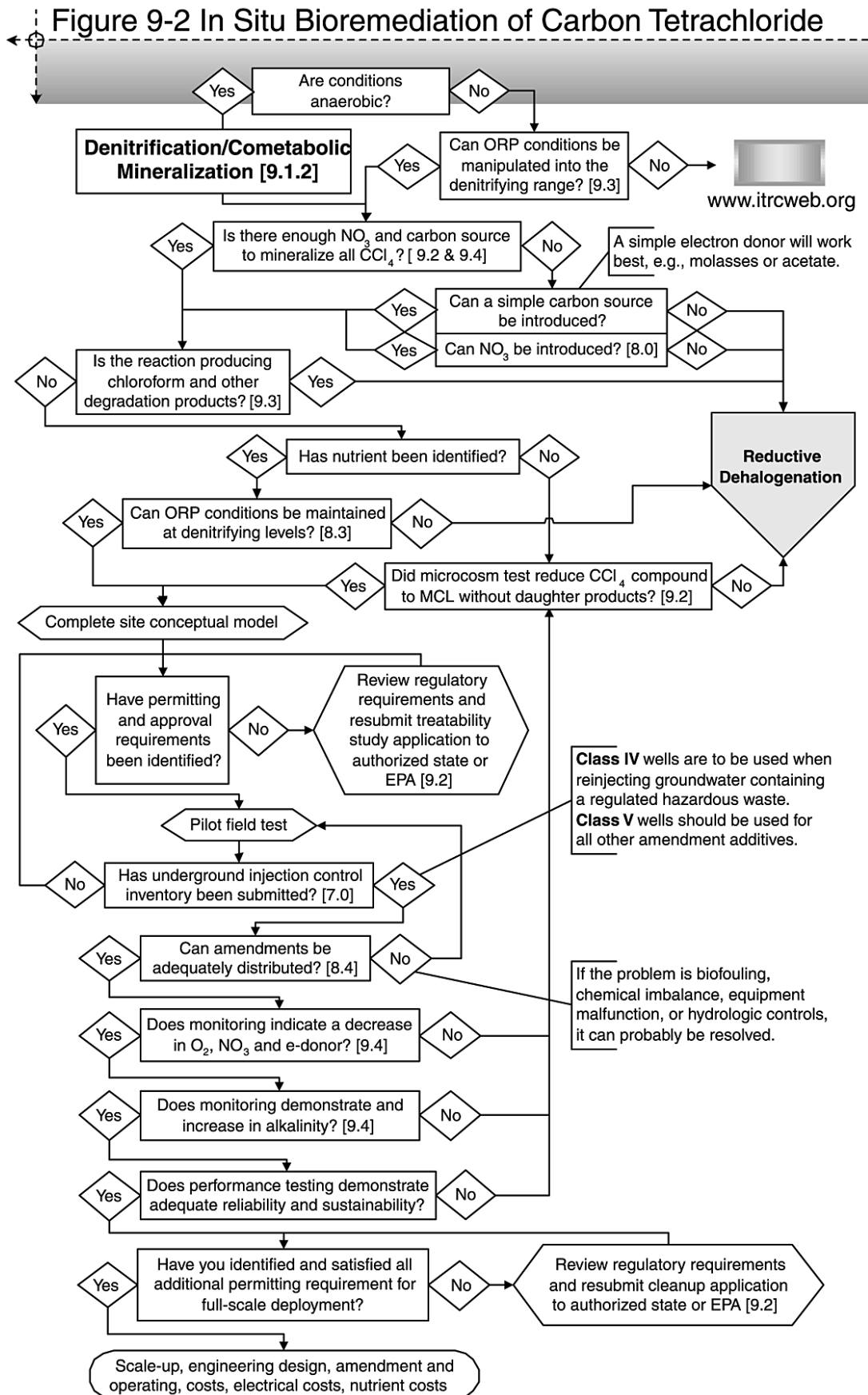

### 9.1.2 Reductive Denitrification/Cometabolic Pathway

There are two main reductive cometabolic pathways for carbon tetrachloride. The reductive dechlorination pathway yields degradation products through cometabolic processes, not by serving as electron acceptors. The degradation products are produced fortuitously when biologically produced enzymes or cofactors degrade carbon tetrachloride during the microbial consumption of an alternate carbon source. Please refer to Section 9.3.3.3 for more detail.

What makes the reductive denitrification pathway attractive is that no or few degradation products are produced, specifically chloroform, which is a regulated COC. Furthermore, at many carbon tetrachloride-contaminated grain silo sites, nitrate is present in groundwater above standards. Therefore, this reductive pathway provides for destruction of both COCs—carbon tetrachloride and nitrate. The difficulties of this pathway are to maintain the denitrifying conditions, and since there are few sites that have demonstrated this pathway, acceptance may be mixed. The practitioner should refer to Section 9.3.3.2. for a description of this degradation pathway.

If the denitrifying conditions are not maintained and ORP conditions are lowered, carbon tetrachloride reduction will follow the reductive dechlorination pathway. With that stated, this pathway begins by asking if enough nitrate is present to complete the mineralization of carbon tetrachloride. This can be determined by a laboratory treatability test. If site conditions show that substantial amounts of chloroform are present in the groundwater, then reductive dechlorination may be occurring and the previously discussed pathway should be further investigated.

However, if little to no chloroform is present, this reductive denitrification/cometabolic pathway may be preferred. An electron donor that maintains ORP conditions in the denitrification range should be evaluated and chosen. Typically, this electron donor has been acetate. Again, the laboratory treatability test will determine the electron donor, nutrient requirements, possible microbial augmentation, and whether conditions can be maintained at the denitrification rate. If these tests show that the site is conducive to the denitrification/cometabolic pathway, a site conceptual model can be developed. Following that, a pilot field test can be designed and implemented after regulatory concerns are addressed. This flow chart describes those concerns.

Once the pilot test is deployed, concerns on amendment mixing, biofouling, contaminant destruction, and maintaining denitrifying conditions are answered. Again, if results from this test show successful destruction of carbon tetrachloride through the denitrification/cometabolic pathway, a full-scale design can be prepared and deployed.

## **9.2 Contaminant Background**

### 9.2.1 Pervasiveness of Carbon Tetrachloride Contamination

Carbon tetrachloride has been found as a contaminant in soil and/or groundwater at approximately 22% of sites investigated under CERCLA ([ECO-USA](#), 2001). Carbon tetrachloride in the soil above the saturated zone may be at concentrations high enough to act as a source for groundwater contamination even though the use of carbon tetrachloride as a product had been discontinued. This residual carbon tetrachloride in the soil should be assessed and dealt with as a source of contamination.

### 9.2.2 Site Operational History

Determining and documenting the operational history of carbon tetrachloride contamination sites may be one of the most important steps in the bioremediation decision-making process. There are a wide variety of potential carbon tetrachloride contamination generators, and each may have additional and unique factors that will play an important role in the decision-making process. For instance, in an industry where the only contaminating substance is/was carbon tetrachloride, the issues are fairly straightforward. However, in an industry where a number of other substances with long persistence may also have been released, ISB of carbon tetrachloride may not be feasible. In some industries, carbon tetrachloride may be a small component of a waste stream and, therefore, may not behave as the pure product would in the subsurface.

As an example, consider carbon tetrachloride used as a fumigant in grain storage facilities in the Midwest. Carbon tetrachloride was typically applied to these grain storage facilities as a mixed product generically referred to as “80-20”, composed of 80% carbon tetrachloride and 20% carbon disulfide or “70-30”, composed of 70% ethylene dichloride (1,2-dichloroethane [DCA]) and 30% carbon tetrachloride. Trade names for carbon tetrachloride products include Carbona, Benzinoform, Flukoids, Necatorina, Tetrafinol, Tetraform, Tetrasol, Univerm, and Vermoestroid. The operational history of the facility will likely show that releases to the environment were cyclic, based on annual grain storage patterns. Investigators may also find that carbon tetrachloride was not the only fumigant (EDB and EDB/carbon tetrachloride mixtures, also known as Maxkill 10 have been documented) in use at the facility, or that the facility also had associated seed treatment operations that may have contributed mercury compounds to the subsurface. The time of the releases will also prove important in modeling the contaminant plume movement and remediation options. If the operational history is not carefully considered, very incorrect decisions may result.

### 9.2.3 Sources of Carbon Tetrachloride Contamination

Historically, carbon tetrachloride was produced in large quantities to make refrigerant fluids and propellants for aerosol cans. Carbon tetrachloride has been widely used as cleaning fluid in the home, dry cleaning fluid, in the production of semiconductors, as a degreaser, a gasoline additive in some formulations, and to recover tin from tin-plating waste. It was used as a catalyst in the manufacture of soap, perfumes, and insecticides. And because carbon tetrachloride is nonflammable, it was also used in fire extinguishers. The primary agricultural use for carbon tetrachloride was as a fumigant in grain silos.

Due to the toxicity of carbon tetrachloride, consumer and fumigant uses have been discontinued, and only industrial uses remain. Use of the compound was curtailed in the 1960s due to concerns over the effects of exposure. In 1986, carbon tetrachloride was banned for use as a pesticide. The major current use of carbon tetrachloride is in the production of chlorofluorocarbons, which are used primarily as refrigerants. Due to the effort to reduce ozone-depleting chemicals, carbon tetrachloride was phased out for nonfeedstock uses in 1996. It is now used only in those feedstock operations in which it is totally consumed.

### 9.2.4 Properties of Carbon Tetrachloride

Carbon tetrachloride is a dense nonaqueous-phase liquid (DNAPL) that does not occur naturally. The physical properties of carbon tetrachloride and its most common degradation products (chloroform, dichloromethane and chloromethane) can be found at the TOXNET Web site and are summarized in the following table. TOXNET was developed by the U.S. National Institute of Health and can be found at the following URL: <http://toxnet.nlm.nih.gov/>.

**Table 9-1. Physical Properties of Carbon Tetrachloride and Its Most Common Degradation Products**

Property	Carbon Tetrachloride (C-Cl <sub>4</sub> )	Chloroform (C-H-Cl <sub>3</sub> )	Dichloromethane (C-H <sub>2</sub> -Cl <sub>2</sub> )	Chloromethane (C-H <sub>3</sub> -Cl)
CAS #	56-23-5	67-66-3	75-09-2	74-87-03
Molecular weight	153.82	119.38	84.93	50.49
Color/form	Colorless, clear, heavy liquid	Clear, colorless liquid	Colorless liquid (a gas above 104 °F)	Clear, colorless liquid
Taste/Odor	Characteristic, ether-like odor	Pleasant, etheric, nonirritating odor	Odor similar to chloroform	Faint sweet odor (noticeable at toxic levels)
Density/Specific Gravity	1.5940 @ 20 °C	1.4835 @ 20 °C	1.3255 @ 20 °C	0.92 @ 20°C
Octanol/Water Partition Coefficient (log K <sub>ow</sub> )	2.83	1.97	1.25	0.91
Partition Coefficient (K <sub>oc</sub> ) <sup>4</sup>	110 (71 EPA Web site)	31	21	6
Water Solubility	793 mg/L @ 25 °C	7,710 mg/L @ 25 °C	13,000 mg/L @ 25 °C	6,500 mg/L @ 25 °C
Henry's Law Constant	2.76 x 10 <sup>-2</sup> atm-cu meter/mole @ 25 °C	3.67 x 10 <sup>-3</sup> atm-cu meter/mole @ 24 °C	3.25 x 10 <sup>-3</sup> atm-cu meter/mole @ 25 °C	1.27 x 10 <sup>-2</sup> atm-cu meter/mole @ 25 °C
Boiling Point	76.8 °C	61.2 °C	39.75 °C	-24.2 °C
Melting Point	-23 °C	-63.2 °C	-95 °C	-97.6 °C
Vapor Density (Air=1)	5.32	4.12	2.93	1.8
Vapor Pressure (mmHg)	115 mm Hg @ 25 °C	197 mm Hg @ 25 °C	435 mm Hg @ 25 °C	2,103 mm Hg @ 25 °C
Evaporation Rate <sup>5</sup> (BuAc=1)	12.8	11.6	71*	No available data

<sup>4</sup> K<sub>oc</sub> values of compounds in the family of chloromethane vary widely depending on the analytical methodology and site (see Truex et. al. May 2001)

<sup>5</sup> Relative Evaporation Rate listed as compared to Ether (100) rather than butyl acetate.

### 9.2.5 Contaminant Relationships

Carbon tetrachloride contamination has been found in association with other contaminants, specifically VOCs and nitrate. During the course of many fuel-related (gasoline, diesel) investigations, carbon tetrachloride has been identified as a COC when a complete VOC suite has been run on the groundwater sample. When ISB is being evaluated for benzene, toluene, ethylbenzene, and total xylenes (BTEX) and polyaromatic hydrocarbons (PAH) contamination at a site and carbon tetrachloride is present, BTEX and PAHs may serve as electron donors and the carbon tetrachloride may become the electron acceptor. When this occurs, a sequential dechlorination of carbon tetrachloride and the degradation products should be measured.

In many rural and agricultural regions, nitrate contamination is commingled with carbon tetrachloride plumes due to the past use of carbon tetrachloride at grain silos. The relationship of these two contaminants is important to ISB systems. Even though carbon tetrachloride is an organic compound, it rarely serves as an electron donor in reductive ISB systems. Furthermore, if an electron donor is present (e.g., acetate) along with nitrate contamination serving as an electron acceptor, carbon tetrachloride is cometabolically mineralized without the appearance of reductive byproducts such as chloroform. This process has been identified for the bacteria *Pseudomonas stutzeri* strain KC ([Michigan State Univ.](#), 2000).

As stated in Section 2.2 above, other fumigants may be present. A document from 1984 entitled [Preventing Insect Problems in Farm-Stored Corn](#) from Purdue Cooperative Extension Service shows that the following pesticides have been used in grain storage: malathion, dichlorvos, methyl bromide, chloropicrin, 70-30 (1,2-DCA/carbon tetrachloride), 80-20 (carbon tetrachloride/carbon disulfide), and aluminum phosphide. [Malathion](#) (O,O-dimethyl-S-1,2-di(carboethoxy) ethyl phosphorodithioate) is an aliphatic organophosphate that was heavily used as a pesticide, and its [degradation products](#) are of concern. [Dichlorvos](#) (O,O-dimethyl-O-2,2-dichloro-vinyl phosphate) is a volatile organophosphate, and its degradation products ([dimethyl phosphate and dichloroacetaldehyde](#)) are a health concern. Methyl bromide is lethal to all plant and animal life, is classified as a sterilant (Ware, 1983), and has been [phased out](#) of usage in the United States. [Chloropicrin](#) (Cl<sub>3</sub>CNO<sub>2</sub>) has been used as an olfactory warning agent in grain fumigants but also serves as a fumigant itself (Ware, 1983) and is susceptible to anaerobic ISB with the degradation products being carbon dioxide, chloride, and possibly nitromethane. [70-30](#) was a liquid fumigant used at grain silos composed of 70% ethylene dichloride (1,2-DCA) and 30% carbon tetrachloride. [Aluminum phosphide](#) is a solid, once used at grain silos. These compounds or their degradation products may be found as contaminants along with carbon tetrachloride and should be considered during site investigation activities to identify other contaminants of concern.

Technical-grade carbon tetrachloride product is typically reported as 99 to 100% carbon tetrachloride. Doherty (2000) reports that trace amounts of carbon disulfide, bromine, chloroform, and hydrochloric acid may be present. Additionally, Doherty (2000) reports that alkyl Cyanamid, diphenylamine, ethyl acetate, and ethyl cyanides may be present as corrosion inhibitors in some commercial formulations.

Sometimes chloroform is present in analytical results from groundwater samples when site investigation activities have clearly identified carbon tetrachloride as the only contaminant discharged. This information can be perplexing to the site manager if groundwater conditions are



not anaerobic and site characterization data does not indicate any reductive conditions. Just because chloroform is present does not necessarily indicate that the site is undergoing complete biological reduction of carbon tetrachloride. Possible solutions to this observation is that chloroform was a trace constituent in the carbon tetrachloride discharged, or the vadose or saturated zone directly beneath the discharge point has been or is conducive to anaerobic reduction of carbon tetrachloride, thus forming chloroform as a degradation product. This anaerobic reduction zone directly beneath the discharge point may not be substantial enough for complete reduction of the carbon tetrachloride, allowing for the remaining carbon tetrachloride and the degradation product, chloroform, to persist.

Carbon tetrachloride as a solvent appears to predate some of the other ubiquitous solvents found at remediation sites on defense facilities, especially those that were in place by the 1940s. Newer facilities tend to have TCE, PCE, and TCA solvents present as soil and/or groundwater contaminants. However, carbon tetrachloride contamination can be found on many relatively new military installations. The common thread on these military sites is carbon tetrachloride's use as a degreasing agent in association with vehicle maintenance and communications/electronic gear cleaning. Where these types of operations were conducted is where the contaminants are commonly detected. Landfills on these sites also can contain carbon tetrachloride contamination. Fire extinguishers that contained carbon tetrachloride may also be present. Examples of U.S. Department of Defense (DoD) sites that have carbon tetrachloride contamination include ammunition plants, BRAC sites including air bases, naval yards, depots, military reservations, and active defense installations.

Historically, Hanford Department of Energy Reservation disposed of carbon tetrachloride to the soil at several sites adjacent to a plutonium refinishing plant during operation of the plant from 1955 to 1973. The carbon tetrachloride was used with mixtures of other organics to recover plutonium from aqueous streams and the plant. The resultant organic liquids discharged to the disposal site consisted primarily of carbon tetrachloride, mixed with tributyl phosphate, dibutyl butyl phosphate, and lard oil. (Truex, et al., 2001). DOE's Y-12 Plant in Oak Ridge, Tennessee has an historical carbon tetrachloride plume with suspected DNAPL in fractured bedrock (see <http://web.ead.anl.gov/techcon/projects/dnapl/http://web.ead.anl.gov/techcon/projects/dnapl/>). A pump-and-treat system is planned for plume containment. Oak Ridge is following a systematic approach to evaluate the effectiveness of ISB for carbon tetrachloride at Y-12, including site characterization for ISB, lab-scale treatability tests, and limited pilot-scale field demonstrations (see <http://www.em.doe.gov/itrd/oakstat.htmlhttp://www.em.doe.gov/itrd/oakstat.html>).

### 9.2.6 Regulatory Standards and Guidance of Carbon Tetrachloride

Carbon tetrachloride is no longer registered under FIFRA Section 3 and is no longer used in pesticides. Carbon tetrachloride is designated as a hazardous air pollutant under Section 112 of the Clean Air Act [40 CFR 61.01 (7/1/99)]. The compound is also designated as a hazardous substance under Section 311(b)(2)(A) of the Federal Water Pollution Control Act and is also regulated under the Clean Water Act Amendments of 1977 and 1978 [40 CFR 116.4 (7/1/99)]. The MCL established by the National Revised Primary Drinking Water Regulations for carbon tetrachloride in community and nontransient, noncommunity water systems is 5 micrograms per liter [40 CFR 141.61 (7/1/99)]. Specific state and federal soil cleanup guidelines for carbon tetrachloride and its degradation products are summarized in Appendix A. Certain states have promulgated numeric water standards for carbon tetrachloride and its degradation products, as

shown in the following table for selected states. Due to the differences in groundwater standards for carbon tetrachloride and its degradation products, the reader should be aware of differing cleanup standards between states.

**Table 9-2. Selected State Groundwater Standards**

<i>State</i>	<b>Numeric Standards (µg/L)</b>				<b>State Regulation</b>
<b>New Mexico</b>	CT – 10 CF – 100 DCM – 100 CM – no numeric standard				<b>New Mexico Water Quality Control Commission Regulation 20.6.2.3103 NMAC</b>
<b>New Hampshire</b>	CT – 5 CF – 6 DCM – 5 CM – 3				<b>New Hampshire Groundwater Management and Groundwater Release Detection Permits Env-Wm 1403</b>
<b>Arizona</b>	CT– 5 CF – no numeric standard DCM – 5 CM – no numeric standard				
<b>Virginia</b>					<b>Uses Safe Drinking Water Act, part 141, title 40 CFR.</b>
<b>Colorado</b>	CT– 0.27 CF – 6 DCM – 4.7 CM – no numeric standard				<b>Water Quality Control Commission (5 CCR 1002-41)</b>
<b>Missouri</b>		<b>Scenario A</b>	<b>Scenario B</b>	<b>Scenario C</b>	<b>RSMo §260.565 - 260.575 and administrative rule 10 CFR 25-15.010</b>
	CT	2	3	5	
	CF	0.8	1	1	
	DCM	51	71	150	
	CM	No numeric standard			
<b>Oklahoma</b>	CT– 4 CF – 10 DCM – no numeric standard CM – 2.7				<b>Oklahoma Standard for Groundwater Protection and Corrective Action Subchapter 7, §785:45-7-2</b>
<b>North Dakota</b>	CT – 5 CF – 100 MCL or HAL DCM – 5 CM – 3				<b>Standards of Quality for Waters of the State, Chapter 33-16-02, North Dakota Administrative Code</b>

<i>State</i>	<b>Numeric Standards (µg/L)</b>		<b>State Regulation</b>	
<b>Pennsylvania</b>	<b>Used Aquifers</b>		<b>Pennsylvania Land Recycling Program Regulations Subchapter C, §250.304 and §250.305</b>	
	<b>TDS &lt; 2,500</b>			
	<b>Used Aquifers</b>	<b>Used Aquifers</b>		
	<b>CT</b>	<b>5</b>		<b>500</b>
	<b>CF</b>	<b>100</b>		<b>10,000</b>
	<b>DCM</b>	<b>3</b>	<b>300</b>	
	<b>CM</b>	<b>3</b>	<b>300</b>	

CT =carbon tetrachloride; CF= chloroform; DCM=dichloromethane (methylene chloride); CM= chloromethane

### 9.3 Site Description/Characterization

Adequate site characterization is required at any carbon tetrachloride–contaminated site prior to remediation. The extent and magnitude of a carbon tetrachloride plume must be fully characterized. The persistence of carbon tetrachloride in the environment mandates characterization of the contamination, including identifying carbon tetrachloride sources in the vadose zone. Since carbon tetrachloride is a DNAPL, characterization of a site should identify and address DNAPL presence, if possible. Following site characterization and evaluation, ISB may be the chosen remediation technology; however, source control must be addressed prior to achievement of closure criteria. The following section discusses site characterization as it relates to enhanced ISB of carbon tetrachloride. This section discusses which hydrogeologic and geochemical parameters should be characterized and why for ISB of carbon tetrachloride.

#### 9.3.1 Hydrogeologic Environment

All hydrogeologic conditions at the site should be defined (i.e., vadose zone source, lithology, K, K<sub>ow</sub>, K<sub>oc</sub>, K<sub>d</sub>, or the R<sub>f</sub>.) and measured to estimate the movement of fluids and solutes through the subsurface. Section 3.1.1 describes the elements used to estimate the retardation of a compound. Retardation is necessary to develop a representative conceptual characterization of the contaminant plume and unsaturated zone sources from residual compound. Carbon tetrachloride, in a relative view, has a higher retardation than does MTBE but lower than other DNAPLs such as TCE. Understanding the retardation of the compound and the external elements of the subsurface influencing retardation provides the chemical basis for describing the dimensions of the contaminated plume.

#### 9.3.2 Geochemistry

Carbon tetrachloride reduction occurs during anaerobic respiration. In the absence of oxygen and the presence of a carbon source, bacteria may utilize the carbon tetrachloride as an electron acceptor (reductive dechlorination), or carbon tetrachloride may be transformed cometabolically, depending on the ORP conditions, the bacteria, and available electron acceptors. ISB of carbon tetrachloride is a remediation technology that introduces a carbon source to a contaminated aquifer. Depending on the type of carbon source introduced and the ORP conditions achieved, carbon tetrachloride may either be dechlorinated to its degradation products, or mineralized into carbon dioxide and water with little or no formation of degradation products. Since many shallow aquifers are aerobic, the introduced carbon is initially consumed by the indigenous

aerobic bacteria as a carbon source (electron donor). As the aquifer becomes depleted in dissolved oxygen, conditions become anaerobic. When carbon remains in excess, indigenous denitrifying bacteria proliferate and the reduction of carbon tetrachloride occurs. Figure 9-3 shows the expected sequence of selected subsurface ORP transformations and may be useful for assessing whether degradation products may be expected to appear or disappear, based on site ORP conditions. The reader is cautioned that the figure is meant as a template based on the thermodynamics of the reduction and oxidation reactions considered, and Eh values are referenced to a pH of 7. Accurate ORP measurements in the field are difficult to obtain and may not be representative of the heterogeneous subsurface conditions encountered. Nevertheless, the diagram shows the relative strength (or oxidizing power) of the relevant electron acceptors. Since low dissolved oxygen conditions are necessary for ISB of carbon tetrachloride to occur, the following geochemical parameters should be measured: concentration of carbon tetrachloride and its degradation products, chloride, nitrate, alkalinity, DO, pH, ORP, phosphorous, and possibly dissolved iron and manganese, total organic carbon, and methane.

Table 9-3 describes the importance of geochemical parameter identification for ISB of carbon tetrachloride.

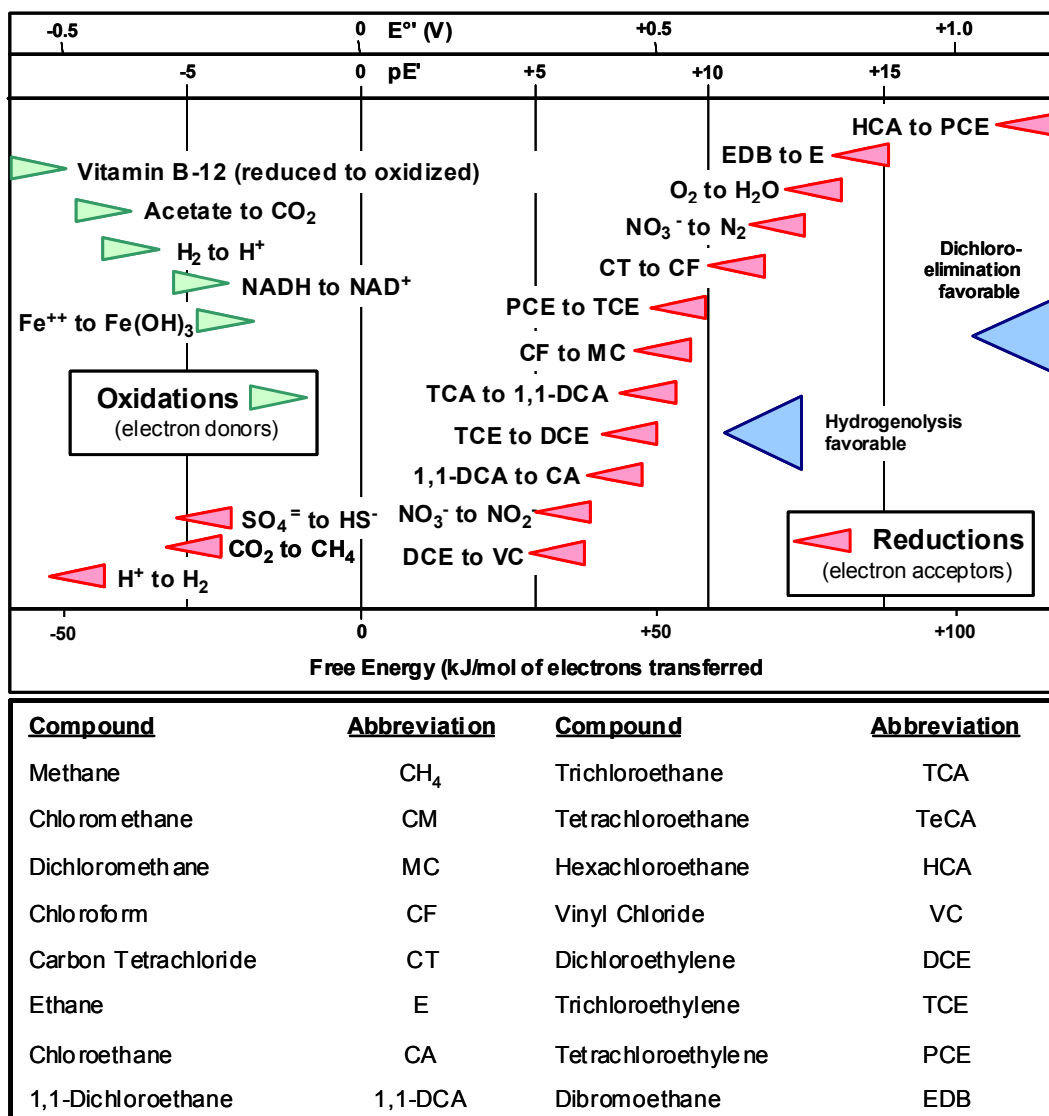

**Figure 9-3. Half-reaction Potentials for ORP of Halogenated Aliphatic Compounds: Potential Electron Acceptors and Electron Donors**

Bases of arrows align with the potentials of the half reaction shown in volts. (Modified from Vogel, 1987). Cookson, 1995.

**Table 9-3. Analytes Important in Evaluating *In Situ* Bioremediation of Carbon Tetrachloride**

PRIMARY ANALYTE	REASON FOR ANALYSIS
Carbon Tetrachloride	Decreases in concentration if ISB is occurring.
Chloroform	This COC is a degradation product of reductive dechlorination of carbon tetrachloride.
Dichloromethane	This COC is a degradation product of reductive dechlorination of carbon tetrachloride.
Methyl Chloride (chloromethane)	This COC is a degradation product of reductive dechlorination of carbon tetrachloride.
Chloride	An increase in chloride concentration from background may indicate a reductive dechlorination of carbon tetrachloride.
Nitrate/nitrite	This COC is expected to decrease in concentration if bioremediation is occurring. Also, if this electron acceptor becomes depleted, carbon tetrachloride may reductively dechlorinate, creating degradation products.
Dissolved Manganese and Iron	If dissolved manganese or iron is present, indicates ORP is too low and matrix Mn/Fe is serving as e <sup>-</sup> acceptor.
Sulfate	If sulfate concentrations are less than background and ORP is low, sulfate may be serving as an electron acceptor and reduction may be occurring.
Sulfide	If sulfide (H <sub>2</sub> S) concentrations are greater than background, sulfate may be serving as an electron acceptor, producing sulfides.
Phosphorous (P)	For ISB of carbon tetrachloride to occur effectively, sufficient P needs to be available for microbial metabolism. (P may need to be added as an amendment.)
Total Organic Carbon	TOC analysis will indicate availability of naturally occurring carbon sources (e <sup>-</sup> donor).
Methane	This constituent may be present as the final degradation product of carbon tetrachloride dechlorination or may be present if ORP conditions are so low that methanogenesis is occurring.

**Table 9-4. Field Parameters Important in Evaluating *In Situ* Bioremediation of Carbon Tetrachloride**

PRIMARY ANALYTE	REASON FOR ANALYSIS
Alkalinity	Due to microbial respiration production of CO <sub>2</sub> , you can expect an increase in alkalinity from background.
Dissolved Oxygen (DO)	For ISB of carbon tetrachloride to occur, DO concentrations must be depleted (<2 mg/l).
pH	ISB of carbon tetrachloride occurs effectively in wide pH ranges (5.5-9.5).
ORP	The ORP may be used in conjunction with electron acceptor concentrations as a qualitative indicator of ORP conditions and in identifying which electron acceptor(s) may be active.

### 9.3.3 Contaminant Degradations/Microorganisms

A carbon tetrachloride direct reductive degradation pathways associated with specific bacteria can be viewed at [http://umbdd.ahc.umn.edu/ctc/ctc\\_map.html](http://umbdd.ahc.umn.edu/ctc/ctc_map.html). Carbon tetrachloride reduction may occur through either a biological sequential reduction or a direct mineralization process. A significant pathway is a sequential two-electron reductive pathway, whereby a chloride ion is removed in each reductive process until methane remains. This ISB process can be accomplished via numerous bacteria. The second pathway is a “simple two-electron reductive process in which chloroform is only a minor product” (Tripp, 2000). This pathway has been identified as a cometabolic pathway using the bacteria *Pseudomonas stutzeri*, strain KC, whereby carbon tetrachloride is mineralized via sulfur and oxygen substitution. The following carbon tetrachloride degradation pathways are possible (see Figure 9.4).

Carbon tetrachloride biological destruction, and its degradation products, has been observed under denitrifying, sulfate-reducing, acetogenic, fermentative, and methanogenic conditions by a variety of organisms. These reductive processes do not solely follow a sequential reduction, whereby a chloride ion is removed during each transformation. Research studies suggest that carbon tetrachloride destruction pathways may be both reductive and substitutional. DOE has presented these research studies and transformation pathways while evaluating carbon tetrachloride contamination at the Hanford site and the Y-2 Oak Ridge site and can be viewed at [http://hanford-site.pnl.gov/groundwater/reports/PNNL\\_13560.pdf](http://hanford-site.pnl.gov/groundwater/reports/PNNL_13560.pdf) under Appendix C, entitled “Literature Review: Natural Attenuation Mechanisms and Rates for Chloromethane Subsurface Contamination at Hanford.” This document provides a comprehensive literature review of studies that identify and evaluate the transformation pathways for carbon tetrachloride and its degradation products.

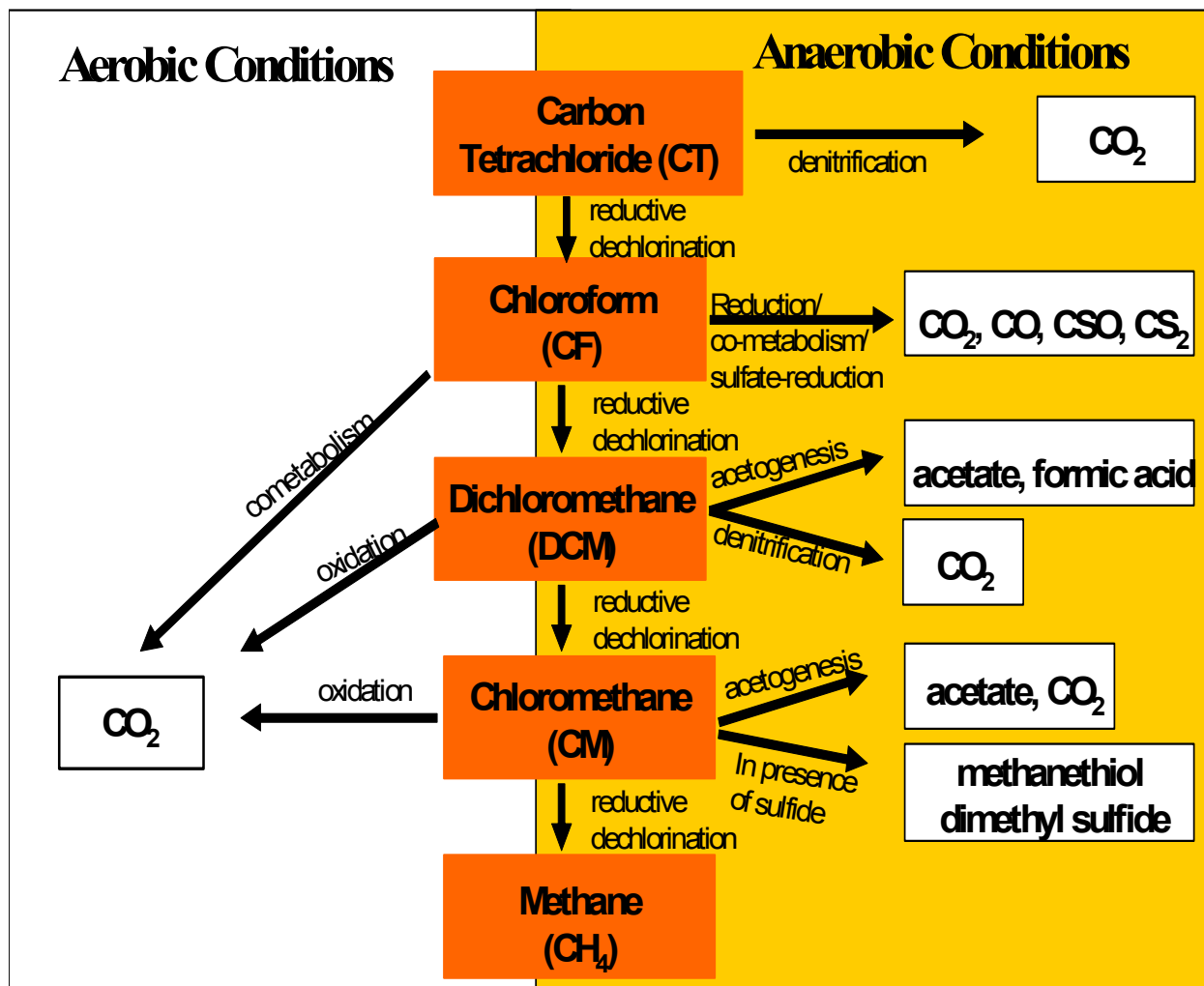

Figure 9-4. CT/CF/DCM/CM Degradation Pathways

The two most significant pathways for ISB systems are under anaerobic conditions and are described below.

#### 9.3.3.1 Reductive Dechlorination

Reductive dechlorination is the process whereby bacteria halorespire the chlorinated compound that serves as an electron acceptor. A carbon source (electron donor) is necessary for this process to occur. Carbon tetrachloride undergoes a series of reductions where the chlorine ion is substituted with a hydrogen ion. During each of these degradations, carbon tetrachloride releases a chlorine ion and gains a hydrogen ion. Two electrons are transferred at each step during this



process, potentially providing a source of energy for the microbe. Therefore, a reduction of carbon tetrachloride would occur, along with an initial increase in chloroform with a subsequent decrease, followed by an increase in dichloromethane (methylene chloride) with its subsequent decrease, and the formation of chloromethane (methyl chloride) with its decrease, until methane becomes the final product. Consequently, the occurrence of reductive dechlorination can be measured by observing the presence of degradation products, such as chloroform, dichloromethane, chloromethane, and methane.

This direct reductive dechlorination pathway whereby carbon tetrachloride and its degradation products serve as electron acceptors has, until recently, not been identified. Due to the multiple biological degradation pathways possible for carbon tetrachloride, this reductive dechlorination pathway may not be easily identified. The following is a hypothetical graph of concentrations of carbon tetrachloride with its degradation products as a function of distance from the source:

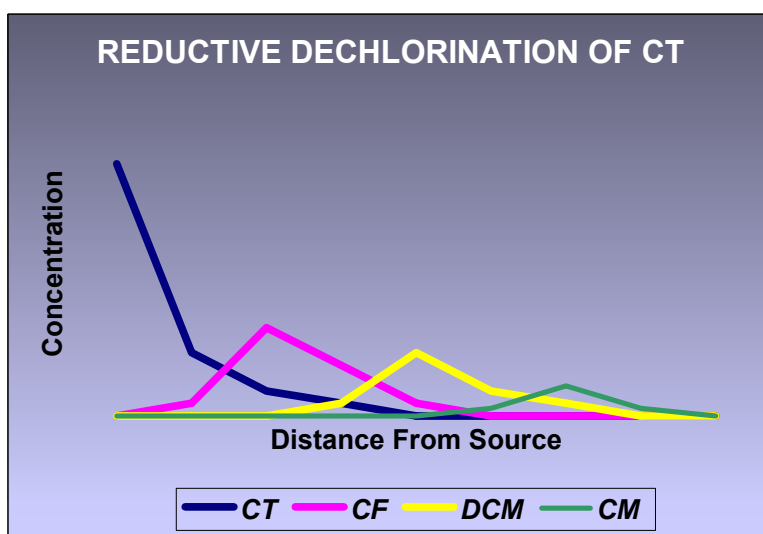

**Figure 9-5. Hypothetical Reduction of Carbon Tetrachloride with Degradation Products** (carbon tetrachloride=CT [ $\text{CCl}_4$ ], CF=chloroform [ $\text{CCl}_3\text{H}$ ], DCM=dichloromethane [ $\text{CCl}_2\text{H}_2$ ], CM=chloromethane [ $\text{CClH}_3$ ])

Reductive dechlorination of carbon tetrachloride needs to be taken to completion, allowing total destruction of carbon tetrachloride and its degradation products. Since chloroform is a degradation product and a known carcinogen, any degradation pathway that does not produce chloroform is preferred.

### 9.3.3.2 Anaerobic Cometabolism

Carbon tetrachloride, like other chlorinated aliphatic compounds, degrade under reducing conditions. Carbon tetrachloride has been shown to degrade under reducing conditions via two major cometabolic pathways. “During cometabolic reactions, chlorinated aliphatic compound degradation is caused by an enzyme or cofactor produced during microbial metabolism of another compound. Chlorinated aliphatic compound degradation or oxidation does not yield any energy or growth benefit for the microorganism mediating the cometabolic reaction.” (EPA, *Engineered Approaches to In Situ Bioremediation of Chlorinated Solvents: Fundamentals and*

*Field Applications*). The following discussion describes the two major reductive cometabolic pathways for carbon tetrachloride.

### 9.3.3.3 *Cometabolic Reductive Dechlorination*

During this reductive pathway, carbon tetrachloride is fortuitously degraded by an enzyme or cofactor during the microbial consumption of an alternate carbon source. There appears to be no benefit to the microorganisms during this process. These enzymes or cofactors reduce carbon tetrachloride, systematically producing degradation products as would be seen during direct anaerobic reductive dechlorination of carbon tetrachloride. “Carbon tetrachloride is degraded to chloroform, dichloromethane, chloromethane, and ultimately methane by hydrogenolytic dechlorinations. Many anaerobic bacteria can catalyze the first two reactions of this pathway using the cofactors heme, factor F<sub>430</sub>, and corrinoids, such as aquocobalamin and methylcobalamin.” ([Carbon Tetrachloride Pathway Map](#) [Anaerobic]). It is difficult in the pilot field test or full-scale deployment to distinguish which is the preferred pathway. It may not be necessary for the site manager to determine which pathway is occurring during field deployment.

### 9.3.3.4 *Cometabolic Denitrification*

The denitrification/cometabolism degradation of carbon tetrachloride results in little to no production of chloroform. However, the mechanisms of this degradation process are not as well understood as reductive dechlorination and contain numerous limiting factors. Basically, carbon tetrachloride is cometabolized to eventually produce carbon dioxide and possibly formate ([Lasatoskie](#), 1999).

This process works as follows: A carbon source is introduced into the contaminant zone to create denitrifying conditions. That is, the ORP is slightly reduced, and all available oxygen has already been consumed as an electron acceptor. If nitrate is in the aquifer, it serves as an electron acceptor and is denitrified ([Dybas](#), 2000), thus removing another contaminant from the aquifer. Various denitrifying bacteria produce oxygenase enzymes, which fortuitously metabolize carbon tetrachloride. The end result is carbon dioxide without production of chloroform.

An important discovery in 1990 by [Criddle](#) identified the bacteria *Pseudomonas stutzeri* KC as being able to reduce carbon tetrachloride without the production of CF. This specific bacteria secretes the molecule [PDTC](#) (pyridine-2,6-bis(thiocarboxylate)) believed to be an iron chelator, which alone may transform carbon tetrachloride into carbon dioxide, chloride ions, formate, and other nonvolatile products. This molecule is thought to be the cometabolic factor for the destruction of carbon tetrachloride. Criddle and colleagues discovered that *Pseudomonas stutzeri* KC must be grown in an anaerobic, alkaline environment (pH 8) that lowers dissolved iron (Mayotte, et al., 1996). Dissolved iron limits the capability of this bacteria to degrade carbon tetrachloride. Criddle’s work along with others resulted in the field deployment of a biocurtain to treat carbon tetrachloride at a site in [Schoolcraft](#), Michigan. Information at <http://scicom.ucsc.edu/SciNotes/9901/kc/kc.htm> provides a simplified understanding of this work.

A feed batch experiment was conducted by [Sherwood and Peterson](#) to test the effects of electron donors and acceptors on the production of chloroform. This study showed that under nitrate-limiting (electron acceptor) conditions, there was chloroform production; while under acetate-

limiting (electron donor) conditions, there was little chloroform production. What this suggests is that if an abundant carbon source (electron donor) is available and nitrate (electron acceptor) is limiting, the bacteria will search out an alternate electron acceptor. Typically, for an alternate electron acceptor to be available to the bacteria, the ORP will be lower. This will occur with an abundant carbon source. When the ORP is lowered, carbon tetrachloride will undergo reductive dechlorination and the denitrifying bacteria that can convert carbon tetrachloride directly to carbon dioxide are out competed. When the electron donor is limited and nitrate is abundant, the denitrifiers remain predominant, producing more oxygenase enzymes and causing minimal production of chloroform and mineralization of carbon tetrachloride to carbon dioxide. Therefore, if an ISB system can be optimized so that denitrification conditions are consistently met (ORP 500-700 mv) and nutrient requirements are supplied, carbon tetrachloride should be reduced without the production of chloroform provided that the bacteria that produce these cometabolic factors are present.

This denitrification/cometabolism of carbon tetrachloride has been observed in the field and has been deployed. [McQuillan](#), et al. (1998) showed through monitored natural attenuation at a commingled gasoline and carbon tetrachloride plume that reductive dechlorination and denitrification/cometabolism of carbon tetrachloride occurred. In the source zone where electron donors (benzene, toluene, ethylbenzene, xylene) were abundant, ORP was suppressed (sulfate-reducing conditions) and nitrate had been depleted, reductive dechlorination of carbon tetrachloride occurred, and degradation products were present. However, where electron donors were limiting, ORP was slightly suppressed, and background nitrate was abundant, direct mineralization of carbon tetrachloride was observed at pH ranging between 7.2 and 7.4. A field demonstration of ISB of carbon tetrachloride and nitrate at the DOE Hanford site showed that nitrate was reduced and carbon tetrachloride was cometabolically mineralized with minor production of chloroform (Truex, et al., 1996).

This denitrification/cometabolic reduction pathway of carbon tetrachloride may be preferred, since little to no chloroform is produced. But as mentioned above, numerous limiting factors or conditions may exist. First, for this reductive pathway to occur, a fine balance between nitrate addition and electron donor amendment must be maintained. This task may be difficult to achieve in field conditions. Secondly, if direct mineralization of carbon tetrachloride is not occurring in spite of achieving optimal conditions (i.e., appropriate electron donor and acceptor amendment), bioaugmentation of suitable bacteria may be necessary as in the Schoolcraft case. Finally, this reductive pathway for carbon tetrachloride has not been deployed at numerous sites and could be considered an emerging application that may impede its acceptance.

#### 9.3.4 Receptors

See Section 3.4 of this document

##### *9.3.4.1 Adverse Human Health Effects*

Carbon tetrachloride and some of its degradation products are considered carcinogens or suspected carcinogens and are regulated substances and hazardous materials. Exposure to high concentrations of carbon tetrachloride may cause liver, kidney, and central nervous system damage ([ATSDR, 1995](#)). Long-term exposure to carbon tetrachloride has the potential to cause liver damage and/or cancer ([EPA-Office of Water, 2001](#)). Studies in certain animals have shown

an increase in liver tumors to some species when ingested. The Department of Health and Human Services has determined that carbon tetrachloride may reasonably be anticipated to be a carcinogen. The International Agency for Research on Cancer has determined that carbon tetrachloride is possibly carcinogenic to humans, and the EPA has determined that carbon tetrachloride is a probable human carcinogen ([ECO-USA, 2001](#)).

#### 9.3.4.2 *Adverse Ecological Effects*

Due to carbon tetrachloride's relatively high evaporation rate when released to the environment, most moves quickly into the air. Carbon tetrachloride is stable in air (30–100 years) and may react with other chemicals that have the potential to destroy upper atmosphere ozone. It is reported not to accumulate in animals, and it is unknown whether it accumulates in plant tissue ([ATSDR, 1995](#)).

### 9.4 Fate and Transport

#### 9.4.1 Stoichiometry and Kinetics

In the case of organic compounds such as carbon tetrachloride, there is not a simple single stoichiometric equation because there are many competing reactions occurring simultaneously and each reaction is catalyzed by different bacteria. The rates for each reaction will vary from site to site and, hence, will impact or alter the overall stoichiometry. Reductive dechlorination of carbon tetrachloride to methane is, however, straightforward. Each molecule of carbon tetrachloride requires 8 electrons from a carbon source (electron donor) to convert it to methane. The single carbon atom in carbon tetrachloride changes valence from fully oxidized (+4) to fully reduced (-4), for a net change of eight electrons. If sodium lactate ( $C_3H_5NaO_3$ ) is the supplied carbon donor, three molecules will ideally reduce two molecules of carbon tetrachloride. The three carbons in sodium lactate have a zero valence and will oxidize with a yield of 12 electrons per sodium lactate molecule. That is:

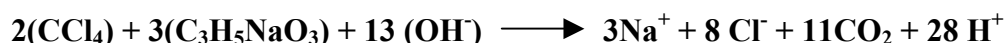

Therefore, if a carbon tetrachloride plume contains a concentration of 100 parts per billion (ppb), 150 ppb of sodium lactate will need to be supplied for complete reductive dechlorination to occur. Please note that many ISB systems add an additional 10% to 20% of amendment as a safety factor.

#### 9.4.2 Modeling

Fate and transport models are site-specific and must be developed accordingly. These models are representations of field conditions. As previously stated, the conceptual model is a simplified version of the particular site's groundwater system as inferred from the site characterization. Groundwater computer models are used to simulate and predict conditions regarding site-specific subsurface flow and transport, specifically to help in determining amendment mixing, hydraulic control, biofouling, first-order decay rates, travel times and directions, number and locations of recovery and injection wells, and flow rates to achieve ISB of carbon tetrachloride. Since this decision criteria module for a systematic approach to ISB is site-specific, generic models are not applicable.

Once the site is characterized to a degree and the various hydrogeological, chemical, and microbial relationships are adequately understood, a conceptual model of carbon tetrachloride behavior is developed. The fate and transport of carbon tetrachloride through porous media is controlled by its density and the pressure resulting from its release into the subsurface. The magnitude of the pressure is proportional to the interfacial tension between the carbon tetrachloride and the water and is inversely proportional to the diameter of the pore openings.

After the conceptual model is developed, a mathematical model is formulated. Proper physical constants, variables, and boundary conditions are identified. There are numerous assumptions and simplifications that can be implemented at this stage, and sensitivity analysis could be performed.

#### 9.4.2.1 *Movement of Carbon Tetrachloride through the Saturated Zone*

In the saturated zone, interaction between carbon tetrachloride, which is a DNAPL, and the water phase is important. Carbon tetrachloride as a product migrates below the water table due to its density, which is 1.59 g/cc. The dissolved component of carbon tetrachloride forms the plume, which travels in the direction of groundwater flow. More permeable media and higher carbon tetrachloride saturation will cause a higher rate of flow. Nearly all movement takes place through the “connected pores” under the influence of gravity. In order to displace the water in the pores, any DNAPL must have sufficient mass to overcome the capillary forces that hold the water in the pores.

#### 9.4.3 Applicability

The first step to establish the suitability of a site for ISB for carbon tetrachloride is to determine site conditions as defined above. The most critical factor at a site is the presence or absence of an electron donor that will affect the ORP. A decreased ORP indicates reducing conditions required for carbon tetrachloride reduction, through either reductive dechlorination or denitrification/cometabolism. This condition can only occur if a carbon source is or has been present to reduce the ORP. However, the level of ORP is the factor for determining which reductive process is dominant. If the ORP is systematically lowered, then reductive dechlorination of the carbon tetrachloride will be preferred. This can be achieved by electron donor selection. For instance, lactate typically can reduce the ORP to sulfate-reducing and, possibly, methanogenic conditions, thus favoring reductive dechlorination. On the other hand, if an electron donor such as acetate or ethanol is chosen, the ORP will not be reduced as much. If the ORP is maintained at denitrification conditions, then cometabolism of the carbon tetrachloride will occur with minor or no production of degradation products. A laboratory-scale treatability study or determination will assist the project manager in determining which pathway is preferred and what conditions can be manipulated.

During site characterization, if there are no electron donors present, then site conditions should indicate

- little or no decrease in carbon tetrachloride concentration attributed to biological activity;
- little to no decrease in ORP, little to no decrease in nitrate concentrations if present;
- little to no increase in dissolved iron, manganese, or sulfides;
- little to no decrease in sulfate concentrations; and

- lack of carbon tetrachloride degradation products (i.e., CF, DCM, CM).

Realistically though, many carbon tetrachloride sites are discovered at sites suspected of other VOC releases such as petroleum hydrocarbons. If this is the case, then an electron donor will be present in groundwater as another contaminant of concern. If an electron donor is present, certain site conditions may be observed such as the presence of degradation products (i.e., CF, DCM, CM); a decrease in ORP and dissolved oxygen, nitrate, and sulfate concentrations; and an increase in dissolved manganese and/or iron and sulfides. With this information, first-order decay rates can be calculated for the site. Furthermore, the site data will help in determining what nonbiological attenuation factors are occurring in the contaminant plume.

With this site characterization data, a project manager can decide which ISB reduction pathway is most suited for the site. That is, if conditions are not reductive or slightly reductive, then the addition of a specific electron donor to the saturated zone that favors denitrification/cometabolism of the carbon tetrachloride may be preferred and chosen as the ISB remediation process. Please note that in this case, nitrate addition may be necessary to maintain these conditions to prevent the production of chloroform and other degradation products. This can be determined through stoichiometry and mass balance equations. On the other hand, if conditions are already reductive and reductive dechlorination of the carbon tetrachloride is present at the site, then these conditions may be maintained by the addition of specific electron donors to keep the ORP suppressed. These conditions must be maintained so that degradation products do not remain but are completely reduced, thus preventing the persistence of a degradation product (e.g., CF) in groundwater.

#### 9.4.3.1 *Monitored Natural Attenuation*

Dilution, dispersion, and sorption of a carbon tetrachloride plume will occur to some degree. These physical conditions should have been determined and quantified during the site characterization process. However, microbiological effects of MNA will not occur unless an electron donor is present in the subsurface and conditions are reductive. If an electron donor is present, the degree of MNA occurrence should be identified and evaluated during site characterization. That is, the analyses of the analytes described in Table 9-3 should have been performed, a determination of which reductive pathway is predominant, and an evaluation to see if remediation goals can be achieved through MNA alone. Once MNA evidence has been gathered, it must be presented in a clear and logical sequence to secure acceptance from the responsible party and regulators. Please refer to Sect. 4.4.1 for further definition of MNA and its evaluation, as well as ITRC's [\*Natural Attenuation of Chlorinated Solvents in Groundwater: Principles and Practices\*](#) (ISB-3), 1999.

#### 9.4.3.2 *Enhanced ISB Systems*

If following site characterization, evaluation of MNA, and the laboratory treatability test, all data indicates that an enhanced ISB system will reduce the carbon tetrachloride, then a pilot test system should be engineered to introduce amendments (i.e., electron donor, electron acceptor, nutrients, or microbes) to the subsurface. An enhanced ISB system should be tailored for a specific contaminant site and should be dictated by site-specific conditions. Please refer to ITRC's [\*Natural Attenuation of Chlorinated Solvents in Groundwater: Principles and Practices\*](#) (ISB-3) and EPA's [\*Engineered Approaches to In Situ Bioremediation of Chlorinated Solvents\*](#):

[Fundamentals and Field Applications](#) for good descriptions of engineered systems with associated references.

#### 9.4.3.3 *Hybrid Treatment Systems*

The site manager should determine if an enhanced ISB system for carbon tetrachloride reduction can stand alone to meet remediation goals based on the site characterization, laboratory treatability studies, and field pilot test. If these remediation goals cannot be achieved solely through an enhanced ISB system, then a hybrid treatment system that includes an enhanced ISB system should be instituted. Since carbon tetrachloride is a volatile, an ISB system may be used in conjunction with volatilization technologies such as air sparging, soil vapor extraction, six-phase heating, *in situ* thermal destruction, and bioventing. Be aware that these volatilization technologies may aerate groundwater, thus changing the ORP conditions and making the site unsuitable for ISB anaerobic reduction of carbon tetrachloride. Furthermore, if a site already contains remediation systems, then an enhanced ISB system may be suitable as a “polishing” technology in the final stages of achieving remediation goals or standards in a more timely fashion. ISB remediation technologies for carbon tetrachloride should be considered and deployed, where appropriate, as part of a treatment system to reach remediation goals.

#### 9.4.3.4 *Laboratory-scale Treatability Tests*

Laboratory treatability studies are necessary to determine if bioremediation of carbon tetrachloride can or will occur at the contaminant site and to determine which reductive pathway maybe most beneficial and productive. A laboratory treatability study, along with site characterization data, will identify if reductive dechlorination of carbon tetrachloride is occurring or has the potential to occur at the site. If it has been determined that reductive dechlorination is occurring at the site, the laboratory treatability study will provide information on how to maximize this reductive process. The study will show which electron donor is most suitable to reduce the ORP to low enough levels to assure that the degradation products are completely reduced. The study may include an evaluation of different electron donors that may be suitable. If no reductive dechlorination is occurring at the site, the laboratory treatability study will determine if the site is capable of sustaining this reductive process. The study will also determine not only which electron donor is most appropriate but what nutrients, if any, are necessary, what will be the reductive rates for each degradation product, and assist in designing the quantity of amendments needed to add to the subsurface. Furthermore, if reductive dechlorination is occurring at the site and the project manager decides to pursue the denitrification/cometabolism of carbon tetrachloride instead of reductive dechlorination, the laboratory treatability study will help determine how to adjust site conditions to induce the denitrification/cometabolism reductive pathway. For instance, the study can be tailored to increase the ORP to denitrification conditions that may eliminate degradation product production and stimulate the denitrification/cometabolism reductive pathway.

If the denitrification/cometabolism pathway is the preferred reductive pathway, the laboratory treatability study will provide the essential data of electron donor selection (one that does not reduce the ORP below denitrification levels), any nutrient requirements (e.g., phosphorous), and what is required to maintain these finely balanced conditions. Furthermore, the study will determine if bacteria that produce the cometabolic factor are present or if bioaugmentation of these bacteria is necessary (e.g., *Pseudomonas stutzeri* KC). The study will further determine the

ORP values that must be maintained and whether nitrate (electron acceptor) must be added to maintain these conditions.

In general, these studies are recommended to provide specific contaminant degradation information, provide information about the types of biodegradation that occur naturally at the site, and assist in determining the best amendments to be added. Also, these studies can evaluate different amendments and different levels of amendments to determine which is most effective. The types of laboratory treatability study that may be selected are described under Section 4.4.4.

#### 9.4.3.5 *Pilot-scale Field Demonstration*

Pilot studies provide needed information to determine the viability of the use of full-scale *in situ* bioremediation technologies for a site's cleanup instead of traditional technologies. Sites like the Schoolcraft Project in Schoolcraft, Michigan, the DOE Hanford Site in Washington state, and the DOE Oak Ridge Y-12 site used pilot studies to prove that ISB would effectively remediate the carbon tetrachloride plumes from their respective aquifers. Additional large-scale field demonstrations are planned for the summer of 2002 at Oak Ridge, and results are pending.

A plume of carbon tetrachloride and nitrate was found in the Schoolcraft aquifer. Since the contaminant plume was extensive, traditional technologies were determined to be very costly and slow. With the discovery of the nonnative bacterium, *Pseudomonas stutzeri* KC, a novel technology was proposed using *in situ* bioaugmentation to remediate the carbon tetrachloride and nitrate plume. The *Pseudomonas stutzeri* KC bacterium degraded the carbon tetrachloride with little or no production of chloroform. The pilot site was constructed. The aquifer's water was extracted and mixed with a base to pH 8.2. The buffered water was injected into the injection well and allowed to re-equilibrate. The pumping system was allowed to become fully operational. While site preparation occurred, the *Pseudomonas stutzeri* KC bacterium was grown in filtered sterilized groundwater amended with phosphate, acetate (food), and base. The resultant inoculum was pumped into the test site through the injection well. The pilot test results determined that the *in situ* bioaugmentation was successful if the pH was maintained at levels above pH 8.0 and if the *Pseudomonas stutzeri* KC bacterium was kept viable with a proper acetate diet. (<http://www.egr.msu.edu/schoolcraft>)

Over the long history of various DOE sites, many contaminants were discharged into the subsurface, migrating to and affecting their aquifers. Traditional treatment technologies were determined to be too costly and time-consuming to remediate the sites. The 200 Area at Hanford was chosen for a pilot study for the DOE Hanford, Washington Site. This pilot study used indigenous microorganisms to remediate the carbon tetrachloride and nitrate plume under anaerobic conditions. The pilot study included the use of a computer-based Accelerated Bioremediation Design Tool (ABDT), which proved effective in the design, monitoring, and operation of the pilot study site. The resultant pilot study determined that with the proper pulsed additions of nutrient (acetate) solution alternating with the correct nitrate pulses, the indigenous anaerobic microorganisms reduced nitrates to nitrogen gas, and reduced carbon tetrachloride to CO<sub>2</sub> and chlorine ions. Some chloroform was produced as a byproduct. The use of the ABDT system allowed for the controlled growth of the microorganisms without plugging the reinjection well ("[In Situ Bioremediation for the Hanford Carbon Tetrachloride Plume, Subsurface Contaminants Focus Area](#)," U.S. Department of Energy, April 1999).



## 9.5 Limitations

An enhanced ISB system for carbon tetrachloride has four major limitations. The first two are described in Sections 4.4.7 and 4.4.8 and are the biofouling and amendment mixing issues. Please refer to these sections. The third major limitation is not just determining the reductive pathway that is most suitable for the site, but managing the balance of amendment injections to achieve the carbon tetrachloride reductive pathway that has been chosen. Please refer to Section 9.4.3 for a description of applicability of an enhanced ISB system for carbon tetrachloride. The final limitation is that very few pilot-scale and full-scale field demonstrations have been deployed to date. What this indicates is that as more pilot-scale field demonstrations and full-scale deployment systems are installed, further information and data should help define and optimize ISB systems for carbon tetrachloride.

## 9.6 Issues and Solutions

Chlorinated solvents have received considerable attention in the recent past due to the discovery that they have caused widespread contamination at numerous different sites. Since carbon tetrachloride is a chlorinated volatile organic compound, the ISB Team has not defined any other issue related to ISB of carbon tetrachloride other than those defined under Section 7.0. Please refer to this section for clarity.

## 10.0 A SYSTEMATIC APPROACH TO *IN SITU* BIOREMEDIATION OF PERCHLORATE

### 10.1 Purpose

The purpose of this section is to determine if ISB is site-suitable to remediate perchlorate contamination in groundwater. This section discusses the necessary physical, chemical, and biochemical parameters typically used to evaluate the usefulness and efficacy of *in situ* bioremediation of perchlorate. Following the decision tree, and supporting information in this module, this section provides the user with sufficient information to evaluate ISB of perchlorate at specific sites.

It is important to note that technologies for the remediation of perchlorate are in the developmental stage. While *ex situ* bioremediation of perchlorate is field-proven and commercially available, few *in situ* field applications have been completed. This document is intended to represent the current state of the art. New information may be added as *in situ* biodegradation applications are completed.

The following decision tree, Figure 10-1, is a continuance from the site characterization flow diagram represented in Figure 1-1. Together, they provide a decision pathway to assess the applicability of *in situ* bioremediation of perchlorate in groundwater. This document does not evaluate bioremediation in the unsaturated zone and does not intend to replace the regulatorily defined phases of initial contaminant identification and assessment.

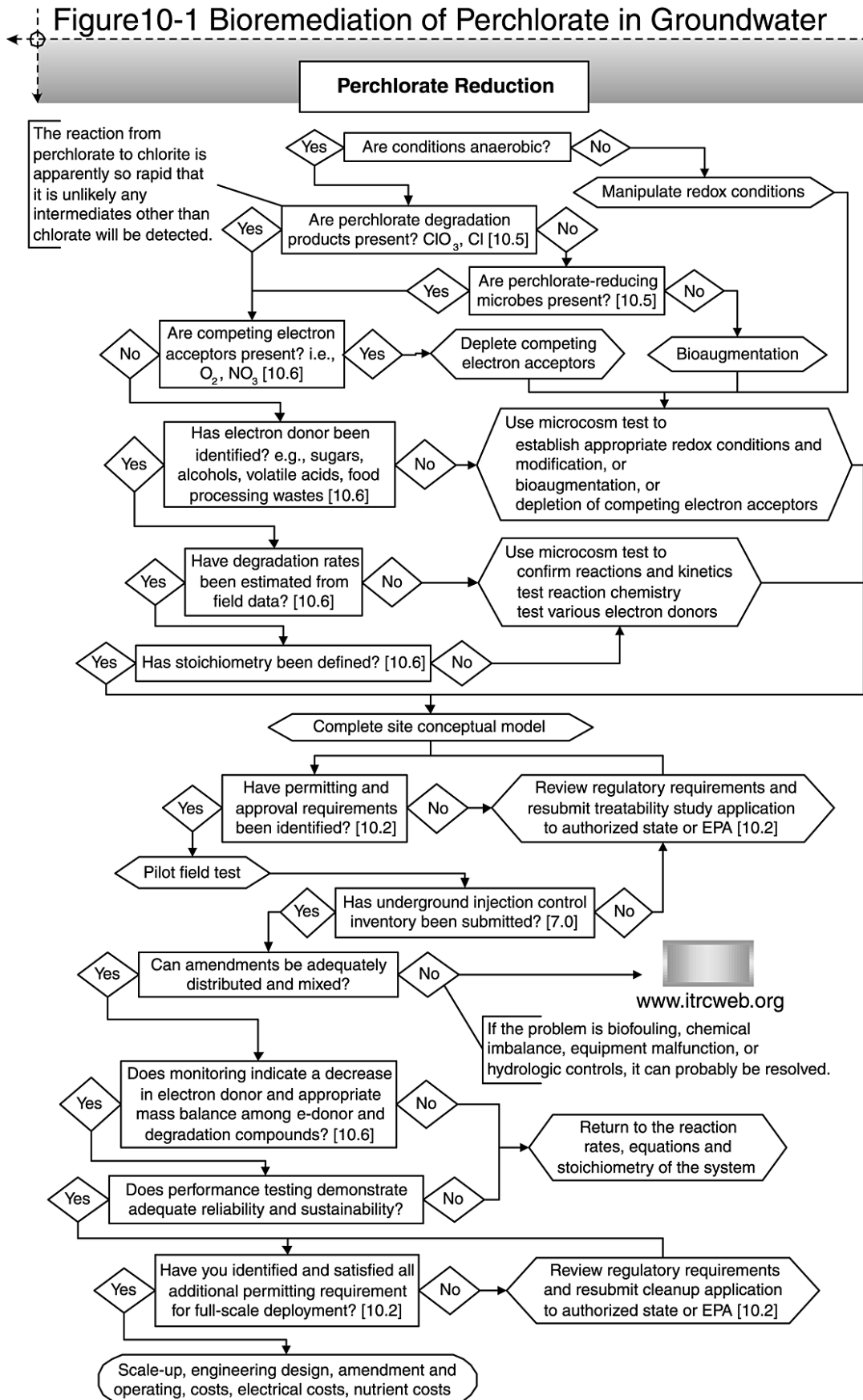

## 10.2 Pervasiveness of Perchlorate Contamination

Perchlorate compounds are used in solid fuels for rockets and missiles, military and commercial munitions, pyrotechnic devices, fireworks, explosives, blasting agents, matches, nuclear reactors, electronic tubes, additives in lubricating oils, tanning and finishing leather, fixers for fabric and dye, electroplating, aluminum refinishing, rubber manufacturing, paint and enamel production, automobile air bag inflators, and pharmaceutical and analytical chemicals (EPA, 1998). It is also a minor constituent in commercial fertilizers that are, or have been, manufactured with Chilean nitrate. It is known that perchlorate compounds have been shipped to at least 40 states according to EPA. See Figure 10-2.

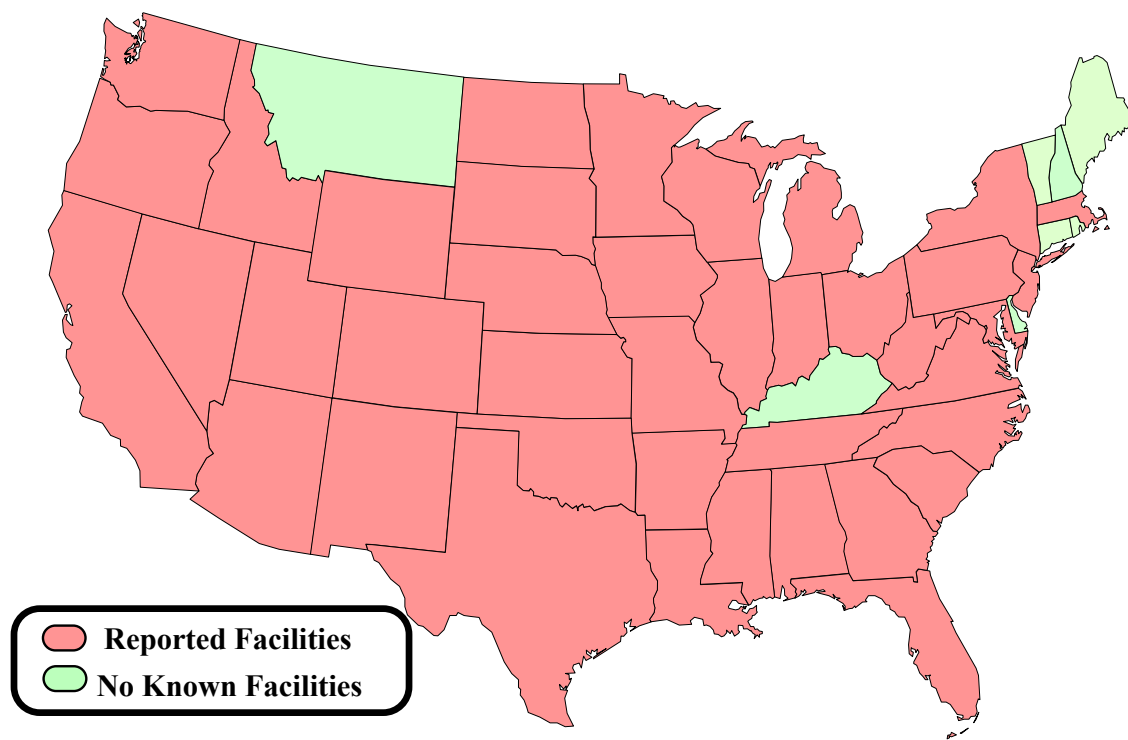

**Figure 10-2. States with Perchlorate Manufacturers or Users**

(Taken from presentation by Kevin Mayer, EPA Technology Innovation Office Seminar “Perchlorate in the Environment,” 2002, available at <http://clu-in.org/studio/perchlorate>.)

Perchlorate was not perceived as a contaminant of concern until recently. The Environmental Working Group reported (Sharp, et al., 1998), “For more than 50 years the chemical industry, defense contractors, or the military disposed of millions of pounds of perchlorate waste by simply flushing it with high-pressure jets. The waste stream was enormous, because if a launch-ready rocket sits idle for too long, the fuel can go ‘flat’ and hundreds of thousands of pounds of perchlorate must be replaced with a fresh supply. A space shuttle rocket motor, for instance, contains about 700,000 pounds of perchlorate (NASA, 1989). Flushing generates large volumes of wastewater contaminated with perchlorate at levels up to 1 % of the total volume. (EPA 1998:

EPA 2001c) For decades, the wastewater was either allowed to drain directly onto the ground or, as in Sacramento County, was pumped into abandoned gold-mining pits (JAWA, 1957).”

Not until recently, and in only a few places, the technology has been installed to reclaim perchlorate from the wastewater stream. Even after reclamation, perchlorate concentrations in the process wastewater remains at high concentrations.

## **10.3 Contaminant Background**

### 10.3.1 Sources of Perchlorate Contamination

Sites where perchlorate salts may potentially be found as groundwater or soil contaminants fall into two main categories: manufacturers and users. U.S. manufacturers of perchlorate compounds historically have operated at sites located in Nevada and Utah. These sites can be heavily contaminated, resulting in impacts to soil, groundwater, and/or surface water. Concentrations in groundwater can range up to the thousands of ppm or more. Plumes in groundwater may be measured in terms of miles from the source in some cases.

The other main category of site is that of the perchlorate user. These sites utilize one or more of the salts of perchlorate as shipped from the manufacturing sites and include DoD sites, NASA and associated sites, industrial sites, and potentially some landfills. The DoD sites associated with potential and known perchlorate releases are scattered across the United States. See Figure 10-3. These sites range from active military bases and ranges to some abandoned and BRAC sites. Some research and test facilities may also be impacted. NASA and some of its contractors use perchlorate in many operations. Industry also uses perchlorate compounds in the manufacture of various products and in processes to make products. Landfills are sites whose potential for perchlorate contamination is largely unknown, although Schooner (May 2002) noted groundwater contamination from Landfill 16 at the Longhorn Army Ammunition Plant in Karnack, Texas. As more environmental testing for perchlorate is completed, more impacted areas may be found. Low levels of perchlorate contamination have now been found in association with certain nitrate plumes of agricultural origin (Urbansky, 2001).

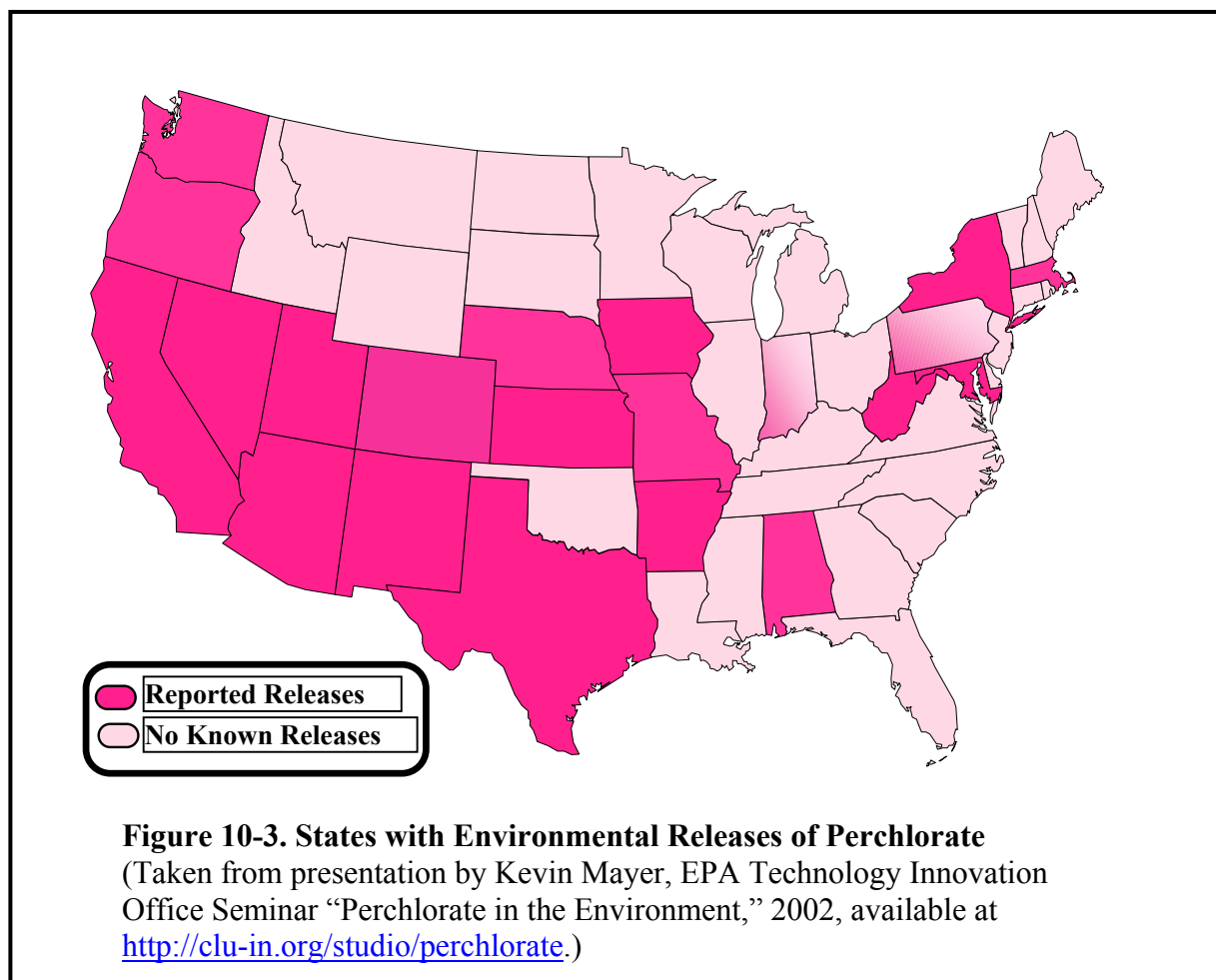

The perchlorate ion is introduced to the environment as compounds such as ammonium, potassium, or sodium perchlorate. Ammonium perchlorate is manufactured as an oxygen-adding component in solid fuel propellant for rockets, missiles, and fireworks. Solid rocket fuels typically consist of ammonium perchlorate (potassium perchlorate or sodium perchlorate may also be used), which serves as the oxidizer; aluminum, which serves as the fuel; a binder; and a plastic that serves to give the material its rigidity. Perchlorate salts are also used in certain munitions, fireworks, the manufacture of matches, and in analytical chemistry to preserve ionic strength. Potassium perchlorate is used in breathing equipment on Air National Guard aircraft in naval emergency escape equipment. About 90% of perchlorate compounds produced by major U.S. manufacturers has been shipped as ammonium perchlorate for use as rocket fuel oxidizer, with most of the remainder used in explosives.

Areas of naturally occurring perchlorate are rare. A known natural source of perchlorate ion is potassium nitrate from Chile (Chile saltpeter). Potassium perchlorate has also been found in samples of sylvite in New Mexico by the U.S. Geological Survey (USGS) and the Air Force Research Laboratory (Harvey, 1999; Urbansky 2001). Other naturally occurring perchlorate compounds have not been identified but are presumed to exist based on the isolation of several genera of perchlorate-reducing microorganisms (PRM) isolated from nonperchlorate-contaminated environments.

### 10.3.2 Properties of Perchlorate

Perchlorate salts bind weakly to soil particles and are not significantly broken down in the environment (EPA, 1998 [1]). Since both soil particles and perchlorate ions are negatively charged, there is minimal adsorption. The accepted mechanism for perchlorate adsorption to soil particles is through outer-sphere complexes, where the ions engage in simple electrostatic bonds (Vanderwalls) and serve to balance electric charge on the surface (Sparks, 1995; Sposito, 1989). Such adsorption is often influenced by pH, soil mineralogy, organic content, ionic strength, and competing ions (Urbansky, 2001).

These ionic salts of perchlorate will readily dissolve and dissociate in a polar solvent such as water. The upper limit of a solid that can be dissolved in a liquid is its solubility. Salts of perchlorate have different solubilities in water, with potassium perchlorate being the least soluble (Table 10-1). In groundwater, the perchlorate ion is highly mobile, migrating faster than many other water contaminants. It can persist in the environment for many decades under typical groundwater and surface water conditions because of its resistance to reactions with other available constituents.

**Table 10-1. Properties of Perchlorate Compounds**

<b>Properties</b>	<b>Ammonium Perchlorate<sup>6</sup> (N-H<sub>4</sub>-Cl-O<sub>4</sub>)</b>	<b>Potassium Perchlorate<sup>7</sup> (K-Cl-O<sub>4</sub>)</b>	<b>Sodium Perchlorate<sup>8</sup> (Na-Cl-O<sub>4</sub>)</b>	<b>Perchloric Acid<sup>9</sup> (Cl-H-O<sub>4</sub>)</b>
<b>CAS #</b>	<b>7790-98-9</b>	<b>7778-74-7</b>	<b>7601-89-0</b>	<b>7601-90-3</b>
<b>Molecular weight</b>	<b>117.49</b>	<b>138.55</b>	<b>122.44</b>	<b>100.47</b>
<b>Color/form</b>	<b>White orthorhombic crystal</b>	<b>Colorless orthorhombic crystal or white crystalline powder</b>	<b>White orthorhombic crystal</b>	<b>Colorless oily liquid</b>
<b>Taste/Odor</b>	<b>Odorless</b>	<b>Slightly salty taste</b>	<b>Odorless</b>	<b>Odorless</b>
<b>Density/ Specific Gravity</b>	<b>1.95 g/cm<sup>3</sup></b>	<b>2.53 g/cm<sup>3</sup></b>	<b>2.52 g/cm<sup>3</sup></b>	<b>1.67 g/cm<sup>3</sup></b>
<b>Solubility</b>	<b>200 g/L water @ 25°C</b>	<b>15 g/L water @ 25 °C</b>	<b>2096 g/L water @ 25°C</b>	<b>Miscible in cold water</b>
<b>Sorption Capacity</b>	<b>Very low</b>	<b>Very low</b>	<b>Very low</b>	<b>Very Low</b>
<b>Volatility</b>	<b>Nonvolatile</b>	<b>Nonvolatile</b>	<b>Nonvolatile</b>	<b>Volatile</b>
<b>Octanol/Water Partition Coefficient (log K<sub>ow</sub>)</b>	<b>-5.84</b>	<b>-7.18</b>	<b>-7.18</b>	<b>-4.63</b>
<b>Vapor Density (Air=1)</b>	<b>No information</b>	<b>4.8</b>	<b>No information</b>	<b>3.5</b>
<b>Vapor Pressure (mmHg)</b>	<b>No information</b>	<b>No information</b>	<b>No information</b>	<b>No information</b>
<b>Evaporation Rate (BuAc=1)</b>	<b>No information</b>	<b>No information</b>	<b>No information</b>	<b>No information</b>

<sup>6</sup> Ashford, 1994; Chemfinder Database, <http://chemfinder.cambridgesoft.com> KowWin Calculator, <http://esc.syrres.com/interkow/logkow.htm>; Lide, 1995-96; TOXNET, <http://toxnet.nlm.nih.gov> EPA Perchlorate Overview, <http://www.epa.gov/safewater/ccl/perchlor/perchlo.html>

<sup>7</sup> Ashford, 1994; Merck Index, Budavari, 1996; Chemfinder, <http://chemfinder.cambridgesoft.com>; Kirk-Othmer Encyclopedia of Chemical Technology, 1991; KowWin Calculator, <http://esc.syrres.com/interkow/logkow.htm>; Lide, CRC Handbook on Chemistry and Physics 76<sup>th</sup> edition; MSDS, Mallinckrodt, 1999; McEvoy, 1996; EPA Perchlorate Overview; TOXNET.

<sup>8</sup> Merck Index, 1996; Chemfinder; Kow/Win Calculator: Lide, 1995-96; MSDS Fischer Scientific, 2000; EPA Perchlorate Overview; TOXNET;

<sup>9</sup> Chemfinder; Kow/Win Calculator; MSDS, 1998; Merck Index 10<sup>th</sup> Edition; National Fire Protection Association, 7<sup>th</sup> Edition; Urbansky et al, 1999; US Department of Health and Human Services, Registry of Toxic Effects of Chemical Substances; TOXNET; Weast, Handbook of Chemistry and Physics 64<sup>th</sup> Edition.

Perchlorate ions are very dense, so concentrated solutions will tend to sink in slow-moving liquids. This should be considered during characterization and remediation of contaminated aquifers. EPA (1998) notes that in high enough concentrations, perchlorate will precipitate out of solution, but the salt thus formed will resolubilize readily. Field observations at the NASA Jet Propulsion Laboratory over the last few years appear to support this idea. Monitoring wells at the site have seen a seasonal high level of perchlorate, which corresponds to the infiltration of precipitation at the site (Zuromski, personal communication, 2001).

Treatment of perchlorate contamination in water is complicated because the perchlorate anion does not respond to typical water treatment techniques due to its fundamental physical and chemical nature. The perchlorate tetrahedron itself is structured such that the four oxygen atoms surround the central chlorine atom, effectively blocking reductants from directly attacking the chlorine. While perchlorate is thermodynamically a strong oxidizing agent, with chlorine in the +7 oxidation state, its reactions are kinetically slow, so that reduction is generally very slow, rendering common chemical reductants ineffective. The most common natural degradation pathway for perchlorate is respiratory microbial reduction. For this to occur, oxygen and nitrate must be depleted and an appropriate electron donor must be present.

### 10.3.3 Contaminant Relationships

According to the Air Force Research Laboratory, nearly every major weapons system that has solid propulsion, explosive devices, or pyrotechnic devices contain perchlorate compounds. At such sites, typical co-contaminants will include volatile organic compounds (VOCs), halogenated solvents, and explosive compounds such as trinitrotoluene (TNT); hexahydro-1,3,5-trinitro-1,3,5-triazine (RDX); and octahydro-1,3,5,7-tetranitro-1,3,5,7-tetrazocine (HMX). The presence of these compounds in the contaminated media could impact the functioning of perchlorate-reducing microbes, sometimes referred to as perchlorate-reducing bacteria (CIRB).

The most common co-contaminants at sites are nitrate and sulfate. The most prevalent degradation product of perchlorate reduction is chlorate and chloride (see Table 10.2). Nitrate concentrations in contaminated media are generally far greater than perchlorate levels. Since denitrification is a reductive process, the presence of nitrate may interfere with the efficient reduction of the perchlorate anion. Therefore, for ISB of perchlorate to occur, oxygen and nitrate must be biologically removed before perchlorate reduction occurs, although instances of co-reduction can be found.



**Table 10-2. A Partial List of Characterized Perchlorate Contaminated Sites with Listed Co-Contaminants<sup>10</sup>**

Site	Contaminated Media	Other Identified Contaminants	Identified Perchlorate Degradation Products
Aerojet Facility, Rancho Cordova, CA	Groundwater	Trichloroethylene (TCE), N-nitrosodimethylamine (NDMA), nitrate, sulfate	
Aerojet Facility, San Gabriel, CA *	Groundwater	Nitrate, TCE	
Big Dalton Well Site, Los Angeles, CA*	Groundwater	Nitrate, sulfate	
La Puente, CA*	Groundwater	NDMA, 1,4-dioxane, sulfate, volatile organic compounds (VOCs)	
Confidential Site	Groundwater	Nitrate	Chlorate
DoD Site, WV	Groundwater	Nitrate, sulfate	
Edwards Air Force Base, CA	Groundwater	Nitrate, sulfate	
Henderson, NV	Groundwater	Sulfate, sodium, calcium, magnesium, nitrate, boron, hexavalent chromium	Chlorate, chloride
Lawrence Livermore National Laboratory, Site 300, Livermore, CA	Groundwater	VOCs, nitrate, explosive compounds	
Pueblo Chemical Depot, CO	Soil, Groundwater	HMX, RDX, nitrate	

\* These three sites are located in the Baldwin Park Operable Unit of the San Gabriel Valley Superfund Site (EPA, Wayne Praskins, 2002, personal communication).

<sup>10</sup> Zuromski, 2001; Roote, 2001; Air Force Research Laboratory, 1998, EPA Perchlorate Overview; Burge, 1999; EPA Perchlorate Information Page <http://www.epa.gov/ogwdw/ccl/perchloor/>

## 10.4 Regulatory Standards/Guidance

EPA has several aspects of perchlorate contamination under review and is considering potential contamination limits and cleanup standards. In the mean time, several states have found it necessary to set temporary and interim standards. These states and standards are listed below.

**Table 10-3. Standards and Guidance Concentration Levels Currently Set for Perchlorate in the Environment**

All levels are reported in µg/l or µg/kg (both are ppb).

State/Agency	Drinking Water ug/l	Water Remediation	Citation
Arizona	31	14.0 ppb	Health-Based Guidance Level, HBGL
California		4.0 ppb <sup>11</sup>	<a href="http://www.dhs.ca.gov/ps/ddwem/chemicals/perch/actionlevel.htm">www.dhs.ca.gov/ps/ddwem/chemicals/perch/actionlevel.htm</a>
Massachusetts	1.5 ppb		Drinking Water Advisory Level (see EPA Region 1)
New Mexico		1.0 ppb <sup>12</sup>	
New York	5.0 ppb <sup>13</sup>		
Nevada	18 <sup>14</sup>	18	
Texas		4.0 <sup>15</sup>	
US EPA Guidance	4.0 to 18.0		
EPA Region 1		1.5 <sup>16</sup>	
EPA Region 9	4.0 <sup>17</sup>		

<sup>11</sup> California Action Level and replaced the 18.0 ug/l

<sup>12</sup> Recently released interim screening level by the New Mexico Environment Department, 2002

<sup>13</sup> Planning Step Trigger 5.0 ppb, Public notification at 18.0 ppb

<sup>14</sup> Nevada State Health Division Public Notice Standard

<sup>15</sup> Interoffice memorandum from Michael Honeycutt, Ph.D., Toxicology and Risk Assessment Section, Office of Permitting, Remediation and Registration, Texas Natural Resource Conservation Commission

<sup>16</sup> Established in July 1991 as a cleanup level for Camp Edwards, Massachusetts

<sup>17</sup> Established in July 2001 in a superfund ROD at Aerojet's Sacramento site in Rancho Cordova, California and a groundwater cleanup value and a surface water discharge criteria.

## 10.5 Site Description/Characterization

Adequate site characterization is critical to any decisions regarding ISB. Given the characteristics of perchlorate compounds in the environment, accurate knowledge of the geology, hydrogeology, and geochemistry of the site is needed. The following sections discuss site characterization as it relates to enhanced ISB of perchlorate contamination.

### 10.5.1 Geology and Hydrogeology

Perchlorate compounds contaminating the subsurface pose challenging problems in remediation. With the experience gained at other sites, it is now known that the vadose zone can act as a secondary and recurring source of perchlorate contamination for some compounds. It is also known that, in great enough concentrations, perchlorate-contaminated water can be denser than water and, thus, stratify at the bottom of an aquifer. These characteristics must be taken into account when considering remediation.

Complex geologic environments, such as river and stream valleys, fractured rock, and karst strata, offer additional challenges to remediation decisions, especially if there will be a need to inject amendments to stimulate bacterial growth. Given the potential density characteristic of the contaminant and the potential of the vadose zone to act as a secondary and intermittent source, contaminant modeling may reveal complex migration pathways. Please refer to Section 4.3 for additional discussion on modeling the contaminated subsurface.

### 10.5.2 Geochemistry

Favorable geochemical conditions in the subsurface are important to successful biodegradation. Without them, or without the ability to create favorable conditions, bioremediation may not be a viable option. The accepted mechanism for perchlorate adsorption to soil particles is through outer-sphere complexes, where ions engage in simple electrostatic bonds (Vanderwalls) and serve to balance electric charge on the surface (Sparks, 1995; Sposito, 1989[5]). Such adsorption is often influenced by pH, soil mineralogy, organic content, ionic strength, and competing ions (Urbansky, 2001). Potentially favorable geochemistry includes a pH between 6.5 and 7.5, ORP potential (Eh) between 0 and -100mv, depleted oxygen, and low nitrate levels. It is important to remember that the addition of electron donor can reduce oxygen and nitrate levels at the site because many of the widely distributed naturally occurring soil bacteria isolated to date are denitrifiers (Logan, 2001).

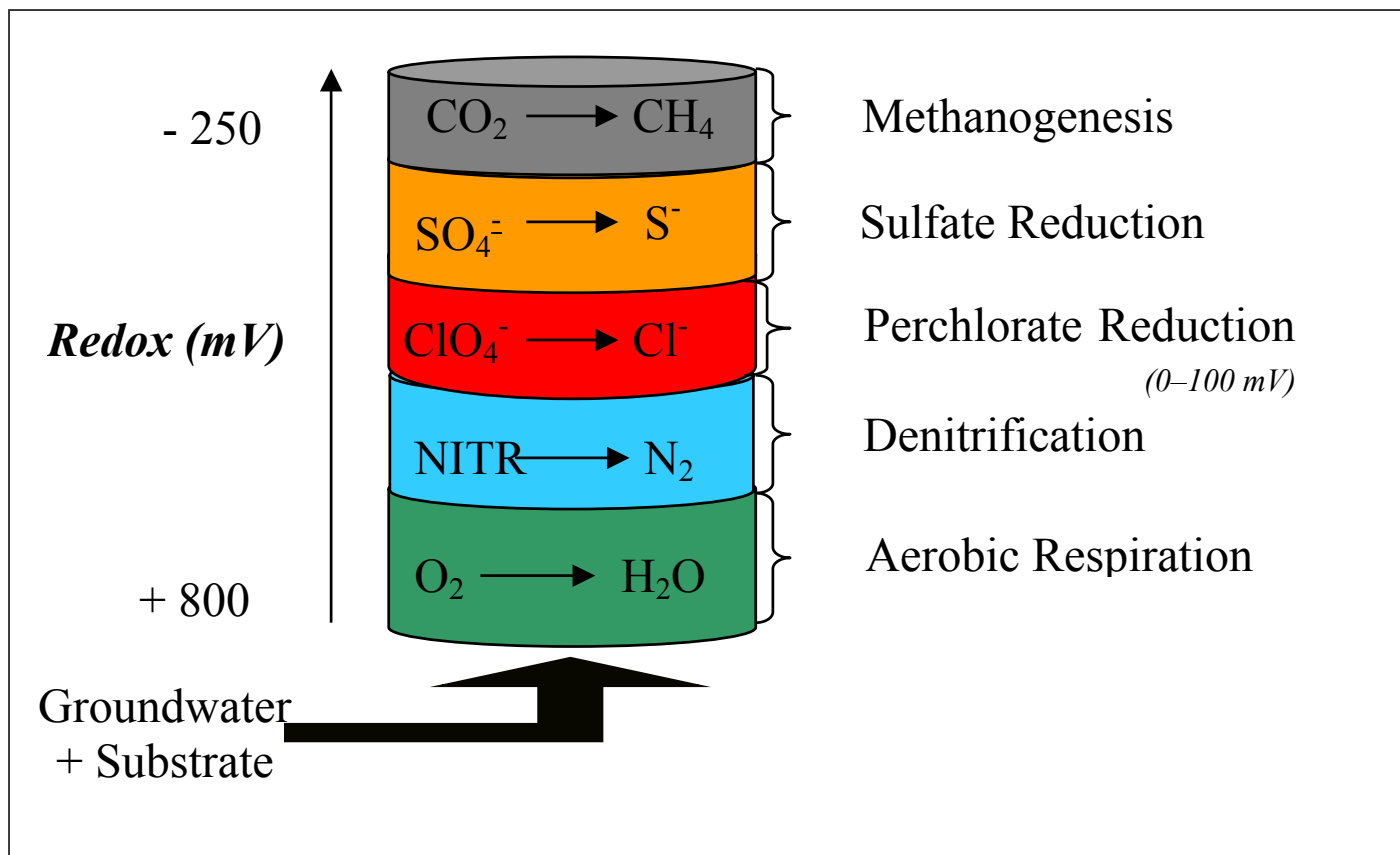

**Figure 10-4. Relative Redox Potential for Associated Degradation Processes**  
(From Hatzinger, P., *Envirogen*, "Bioremediation of Perchlorate in Groundwater," May 2, 2001)

In addition to pH and Eh, analyses for the parameters below will assist in determining feasibility of using ISB to remediate perchlorate compounds.

**Table 10-4. Analytes Important for Evaluating *In Situ* Bioremediation of Perchlorate**

PRIMARY ANALYTES	REASON FOR ANALYSIS
Total Dissolved Oxygen	For anaerobic bacteria to flourish, DO must be low to absent.
pH	6.5–7.5
ORP	If too low, sulfate may become the electron acceptor; and if too high, Mn or nitrate will be the primary electron acceptor (0 to 100 mV).
Total Organic Carbon	For reductive degradation to occur, there must be adequate organic carbon to act as an electron donor.
Nitrate + Nitrite	Nitrate and nitrite appear to inhibit the activity of the halorespirers, which, in some cases, is necessary to the degradation process.
Chlorate	This is a degradation product of the reductive process and may indicate that $\text{ClO}_4^-$ is being reduced.

PRIMARY ANALYTES	REASON FOR ANALYSIS
Chlorite	This is a degradation product of the reductive process and may indicate that $\text{ClO}_4^-$ and $\text{ClO}_3^-$ are being reduced. The kinetics of the transformation reaction are rapid and, therefore, levels may be unnoticeable in analyses (see Section 10.5.3).
Chloride	This is a degradation product of the reductive process and may indicate that $\text{ClO}_4^-$ and $\text{ClO}_3^-$ are being reduced

### 10.5.3 Perchlorate Transformations/Microorganisms

More than 30 different strains of perchlorate-reducing microbes have been isolated from diverse environments (Coates, et al., 2001). In this reductive process, bacteria utilize the perchlorate ion as a terminal electron acceptor. A carbon or hydrogen electron donor (e.g., acetate) is normally necessary to drive the reaction sequence for optimal remediation rate. It is now generally accepted that microbial reduction of perchlorate proceeds according to the following:

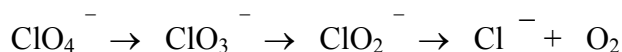

(Perchlorate) (Chlorate) (Chlorite) (Chloride)

As can be seen, perchlorate is ultimately completely converted into chloride and oxygen through the anaerobic reduction process. The perchlorate-to-chlorate step is thought to be the rate-limiting step, being considerably slower than the other steps. Buildup of toxic intermediates, specifically chlorite, does not occur because the chlorite-to-chloride step proceeds at a rate on the order of 1000 times that of the accepted rate-limiting step.

Bacterial species that are capable of dissimilatory (per) chlorate reduction have now been isolated from many different environments, including pristine soils. The majority of these organisms have been classified in the *Proteobacteria* class of the bacteria kingdom. Isolates have been identified that belong in the alpha, beta, and gamma subclasses of the *Proteobacteria*, demonstrating that this type of metabolism is widespread in the class (Coates, et al., 1999). Soil and groundwater samples collected from around the country have confirmed the pervasiveness of perchlorate-reducing bacteria. Sample locations include military bases, military contractor facilities, agricultural areas, and pristine environments (Coates, et al., 2001; Cox, et al., 2001; Hatzinger, et al., 2001). These bacteria appear to be ubiquitous (Cox, et al., 2001). The isolated bacteria to date have been either facultative anaerobes or microaerophiles (Coates, et al., 2001). The presence of oxygen, nitrate, and low pH are inhibitory of perchlorate reduction by these bacteria (Hatzinger, et al., 2001). Most perchlorate-respiring microorganisms are capable of functioning under varying environmental conditions and use oxygen, nitrate, and chlorate but not sulfate as a terminal electron acceptor (Logan, 2001). As a result, both *in situ* and *ex situ* biological remediation techniques are possible as treatment alternatives for ground and surface waters. Most, but not all, of these species are also capable of reducing nitrate as well.

#### 10.5.4 Adverse Human and Ecological Health Effects

Public health concerns surrounding perchlorate involve its ability to affect the human thyroid gland, which regulates metabolism, growth, and development. Potassium perchlorate has, until recently, been used therapeutically to treat hyperthyroidism resulting from an autoimmune condition known as Graves' disease. It is still used diagnostically to test thyroid hormone (TSH, T3 and T4) production in some clinical settings. This use identified a health concern in healthy populations. The high mobility and persistence of the perchlorate ion in groundwater added to the concern. Toxicological studies to quantify the Lowest Observed Effect Level (LOEL), No Observed Effect Level (NOEL), and safe concentrations in drinking water are ongoing. Other studies are striving to determine the ecological effects and impact on the food chain and our food supply. Although some exposure pathways have been identified, we are far from identifying all, or even important ones. Analytical techniques of sufficient sensitivity have not even been perfected for all exposure pathways so far identified.

### **10.6 Fate and Transport**

The U.S. Air Force has begun to study the fate and transport of ammonium perchlorate in the environment. This information can be used to predict the flow of perchlorate in the subsurface. Currently, a literature search has been completed, which describes fate and transport of ammonium perchlorate in the subsurface. The study identifies and assesses factors such as solubility, adsorption, biodegradation, chemical reactions, dispersion, diffusion, and other processes affecting fate and transport of perchlorate.

Dilution and precipitation reactions are presumed to have the most significant effect on perchlorate migration. Through dilution, concentrations would be expected to be significantly less away from the source. Precipitation can help decrease mobility of perchlorate, but the salt can then redissolve, be transported, and precipitate repeatedly. Sorption is not expected to attenuate perchlorate since it absorbs weakly to most soil minerals. Since perchlorate is chemically stable, natural chemical reduction in the environment is not expected to be significant.

A U.S./Swiss team, sponsored by the National Science Foundation, is researching and developing models to describe solute interactions and transport in the vadose zone in soil and geological strata. This research includes analysis of ion-exchange selectivity coefficients and the affinity of exchange as a function of counter ions, where perchlorate was included as a counter ion.

#### 10.6.1 Stoichiometry and Kinetics

The bacteria-catalyzed reduction of perchlorate is similar to biodenitrification and reductive dechlorination. In this case, oxygen ions are successively stripped from perchlorate, leaving a chloride ion in solution as an end product and producing carbon dioxide as the main byproduct.

The balanced equation for reduction of perchlorate using acetate as the electron donor is:



In the above reaction, perchlorate is the acceptor, gaining eight electrons; and acetate is the donor, losing eight electrons. The steps are perchlorate to chlorate and finally chlorite ( $\text{ClO}_2^-$ ) to a chloride ion (Nuttall, personal communication, 2002). The reaction kinetics are so rapid in many cases that chlorite may not be discernable in the subsurface (see Section 10.6.3 and Table 10-4).

### 10.6.2 Modeling Needs for Perchlorate

Fate and transport modeling is site-specific and must be developed according to site-specific field conditions. The conceptual model is a simplified version of the site's groundwater system as determined through the site investigation. Groundwater computer models are used to test conceptualizations and hypotheses regarding site-specific subsurface flow and contaminant transport. See Section 4.3 for a discussion of modeling requirements.

### 10.6.3 Feasibility of ISB for Perchlorate

As discussed previously, a suitable electron donor is necessary in order to reduce perchlorate to chloride and oxygen. The electron donor serves as the food source for the bacteria to reduce the perchlorate. The same electron donors that can be used for chlorinated solvent reduction can be used for perchlorate reduction. It is important to apply adequate electron donor to consume all the oxygen, nitrate, and perchlorate. Important considerations when considering electron donor application include whether any unoxidized substrate could remain in the drinking water. Residual substrate can stimulate bacterial growth in water distribution systems and contribute to the formation of disinfection byproducts in water disinfected with chlorine. (Logan, 2001).

Bioremediation of perchlorate has been demonstrated at a number of sites under anaerobic conditions. Hatzinger (2000) reports that perchlorate persists in groundwater due to

- absence of a suitable electron donor,
- inhibition by alternate electron acceptors,
- lack of indigenous bacteria capable of perchlorate reduction, and
- unfavorable environmental conditions.

A wide variety of electron donors have been reported as suitable amendments to an anaerobic environment to encourage halorespiration of perchlorate. Britto (2000) identified naturally occurring substrates (compost, cottonseed, mulch chips, vegetable oil, and Kenaf) and synthetic substrates (fructose/sucrose, acetate, lactate, ethanol, citrate, slow-release patented lactate compounds, and *in situ* reactive barriers).

Perlmutter (2000) reported using compost, canola oil coated wood shavings, cottonseed meal, granular activated carbon, fructose, and citric acid. Evan Cox, et al. (2000) has demonstrated that many sugars (molasses), alcohols (methanol and ethanol), volatile acids (acetate and lactate), food processing wastes, and manure at specific sites can serve as adequate electron donors. From the list of amendments, it is apparent there is a range of potential electron donors, all of which have particular affinities for certain geochemical and biochemical conditions. Laboratory treatability tests have shown a variety of responses dependent upon these site conditions, and it is advised that the effectiveness of the selected amendment be validated in microcosm studies.

Competition from other electron acceptors impedes the rate of degradation. Preferential electron acceptors include O<sub>2</sub>, nitrate, perchlorate, and sulfate. Under the required anaerobic conditions, oxygen will be of negligible concern; however, nitrate under denitrifying conditions (see decision tree for nitrates) may inhibit reduction of perchlorate under low pH conditions since most PRMs are capable of using nitrate as a terminal electron acceptor (Hatzinger, 2000). Geochemical and biochemical conditions for denitrification are very similar to those for reduction of perchlorate. Cox, et al. (2000) has also demonstrated that perchlorate commingled with chlorinated solvents, a common association, can be degraded simultaneously using molasses and an isolated microbe referred to as KB-1. Not only does perchlorate degradation go to completion, but also TCE is degraded to ethene/ethane in less than 20 days.

#### 10.6.4 Laboratory-scale Treatability Test for Perchlorate

Treatability studies help one refine the conceptual site model by experimentally estimating the rate of degradation, reaction kinetics, and stoichiometry. Suitable electron donors and ORP and pH conditions are tested in laboratory studies. The experiments record the rate of degradation using various electron donors under varying geochemical conditions to estimate the time necessary to reduce perchlorate to acceptable levels. Once an experiment narrows the possibilities to a few, site variables must be tested and the conceptual model and engineering design further refined to accommodate site-specific conditions (see Section 4.4.4). Perchlorate treatability tests can be reviewed in Cox, et al. (2000).

#### 10.6.5 Pilot-scale Field Demonstration

Once the site conceptual model for ISB of perchlorate is refined through laboratory treatability tests and site characterization, site variables are tested with a field demonstration to validate the conceptual site model in field conditions. Perchlorate is very soluble; however, in the unsaturated zone it can be rather immobile until a wetting front solubilizes the contaminant. As stated earlier in Section 10.3.2, high concentrations of dissolved perchlorate may produce density variations causing stratification of contaminated groundwater within a contaminated zone. Refer to Section 4.4.6 for general objectives for *in situ* bioremediation during field pilot studies.

### **10.7 Biofouling**

See Section 4.4.7

### **10.8 Alternative to *In Situ* Perchlorate Treatment**

ISB for perchlorate remediation is an emerging technology and not yet fully developed. Although this section is directed toward the ISB of perchlorate, it must be acknowledged that not all sites or circumstances will prove amenable to ISB. The following sections very briefly describe several other technologies that have been investigated and/or deployed at full scale for treatment of perchlorate. The descriptions are not exhaustive and should not be used as decision-making tools. Other potential technologies may be found by following the alternative treatment technologies path in the chapter's decision tree.

The Ground-Water Remediation Technology Analysis Center (GWRTAC) published a technology status report for perchlorate treatment technologies (Roote, 2001). The report



contains data on the limited case study information currently available. It is likely that current research will yield additional options for perchlorate treatment. Current remedial solutions are discussed below.

### 10.8.1 *Ex Situ* Biochemical Processes

Aerojet, a significant user of ammonium perchlorate, is developing a proprietary *ex situ* bioremediation system to remediate perchlorate-contaminated groundwater (American Water Works Association Research Foundation, 1997). Pilot-scale testing of the biochemical process is taking place at the San Gabriel Valley Superfund Site. The purpose of the test is to determine whether the bioreactor, if followed by filtration and other post-bioreactor treatment, could produce potable water. The test was completed in December 2000, and in April 2002 the California Department of Health Services accepted the technology for use in the production of drinking water (Phase 2 Treatability Study Report *Aerojet GET E/F Treatment Facility, Sacramento, CA, September 2001*). Additional information on this technology, including a report describing the pilot-scale test results, is available from EPA Region 9.

Four full-scale bioreactors, in operation since 1998 at Aerojet's northern California facility, have consistently reduced perchlorate levels from about 2,500 ug/l to nondetectable levels (> 4.0 ug/l). Research at Pennsylvania State University is currently under way to optimize bioremediation of perchlorate and chlorate. Using a bench-scale fixed bed bioreactor, a combination of activated carbon and a perchlorate-reducing microorganism (PRM), perchlorate concentrations were reduced from 240 mg/Liter (L) to less than or equal 8 mg/L (Logan, et al., 1999). In bench-scale tests, researchers have demonstrated destruction of perchlorate using naturally occurring PRMs with a polylactate substrate (Logan, 2000). Research has also taken place using hydrogen and ethanol as substrates (Logan, 2001).

The U.S. Air Force's Armstrong Laboratory Environics Directorate has successfully tested a pilot-scale bioreactor that uses culture of the anaerobic organism *Wolinella succinogenes* HAP-1. This bacterium has been shown to be capable of reducing ammonium perchlorate brines to a nontoxic chloride product.

In the Air Force demonstration, perchlorate brines, along with nutrient amendments, were added to process bioreactors. After a treatment time of approximately 24 hours, the process effluent passed through a clarifier that recycled most of the biomass back into the reactor and allowed the effluent to pass to a holding tank. The effluent was analyzed to ensure that treatment goals had been achieved, and then sent to a sewage treatment facility. Performance results for the Thiokol demonstration of the Applied Research Associates, Inc. anaerobic bioreactor system are summarized in the following table.

**Table 10-5. Pilot-scale Studies, Thiokol Demonstration Site, Brigham City, Utah**

Contaminant	Influent Concentration	Effluent Concentration
Perchlorate	5,000–90,000 ppm	<20 ppm
Nitrate	2,000–16,000 ppm	Nondetect
Nitrite	10,000 ppm	Unchanged
Sulfate	1,800–3,900 ppm	Nondetect
BOD	Not Analyzed	4,000 ppm
COD	Not Analyzed	3,000 ppm

(Adapted from Air Force Research Laboratory, Airbase and Environmental Technology Division, 1998)

The effectiveness of *ex situ* biological processes is dependent upon the careful monitoring and maintenance of environmental conditions and the delivery and mixing of nutrient sources in the reactor vessel (*ex situ* applications). Control of these parameters is required to ensure an optimal growth environment that enhances the ability of bacteria to reduce perchlorate. Because biological treatment processes are new to many water utilities, any treatment process that depends on the use of living bacteria and added growth nutrients to generate potable water may face opposition from the drinking water supply industry or the public (EPA Region 9, OGWDW). For this reason, whether using *in situ* or *ex situ* biotreatment technologies, adequate and continual communication with the receptor community is essential.

### 10.8.2 Phytoremediation

Bench-scale perchlorate phytoremediation studies have been conducted using parrot-feather (*Myriophyllum aquaticum*), an aquatic plant believed to be native to South America that was accidentally introduced into the United States in the late 1800s. Parrot-feather occurs throughout the United States as a nuisance plant. Previous studies had found that the plant could degrade TNT, TCE, and PCE. In the perchlorate study, 600-ml beakers containing one plant, 320 g of sand and 300 ml of perchlorate solutions (0.2, 2.0 and 20 ppm) were prepared, along with control samples that had no plants. After 20 days, no changes were found in the samples without plants. All perchlorate-containing samples showed statistically significant decreases in perchlorate concentration, and the decreases were greater for plants containing higher concentrations of perchlorate (Susaria, et al., 1999).

The work conducted for this project has culminated in discovery of new information fundamental to understanding biological perchlorate degradation by plant and bacterial systems and practical information directly applicable to the perchlorate issues of the Longhorn Army Ammunition Plant. The results suggest that biological degradation does occur under certain environmental conditions and the potential exists to create a passive phytoremediation/rhizodegradation system at the site.

Schooner (May 2002) demonstrated that poplar trees are capable of both uptake and conversion of perchlorate. He reported:

Trees growing in hydroponic solution were shown to reduce the concentration of  $\text{ClO}_4^-$  in solution by 50% in 30 days. Uptake of perchlorate was verified by recovery of radioactivity from the leaves. Additionally, conversion of perchlorate in these semisterile conditions was shown by the recovery of perchlorate metabolites containing  $^{36}\text{Cl}$ . Of radio-labeled  $^{36}\text{Cl}$  recovered from the leaves, 68%, 15%, 8%, and 15% was recovered as  $\text{ClO}_4^-$ ,  $\text{ClO}_3^-$ ,  $\text{ClO}_2^-$ , and  $\text{Cl}$ , respectively. 33% of radio-labeled compound remaining in solution was recovered as chloride, which did not appear to be due to microbial conversion.

The degradation of perchlorate by both the plant and associated bacterial systems shows promise to the development of passive bioremediation systems to treat perchlorate contamination.

### 10.8.3 Physical Removal Processes

The treatment and removal of perchlorate from groundwater can also be accomplished with some of the traditional water treatment technologies. However, the conventional physical/chemical treatment processes such as filtration, sedimentation, or air stripping are not effective at removing perchlorate from water.

According to EPA, perchlorate is only weakly removed by activated carbon filtration (EPA, 1998). Studies have been conducted using tailored granulated active carbon (GAC) and chemical regeneration to remove perchlorate. Researchers used GAC preloaded with an iron-organic complexing solution. The solution appears to increase the perchlorate absorption capacity of the GAC (Cannon and Na, 2000).

There is little doubt that physical processes such as ion exchange and reverse osmosis can remove perchlorate from water. DOE has conducted tests of *ex situ* ion exchange systems for the removal of perchlorate. In 1999, a bench-scale system developed by Krudico, Inc., was evaluated at DOE's Lawrence Livermore National Laboratory. During bench-scale tests, perchlorate influent concentrations of 27 micrograms per liter were reduced to nondetectable levels (Burge and Halden, 1999). DOE's Oak Ridge National Laboratory (ORNL) and the University of Tennessee at Knoxville conducted tests of another ion exchange technology. The resin, called BiQuat, was evaluated in a pilot-scale field trial, but performance data is not yet available (Oak Ridge National Laboratory Review, 1999).

Calgon Carbon Corporation has developed a counter-current *ex situ* ion exchange ISEP system for the removal of perchlorate. The technology has undergone pilot-scale testing at California's Big Dalton site. Performance information for the pilot-scale system is summarized in Table 10-6. Based on the successful pilot-scale system, a full-scale facility was constructed and began operation in 2000. The full-scale unit has a capacity of 2500 gallons per minute (gpm) and achieves an effluent perchlorate concentration of less than 4 ppb, personal communication, Wayne Praskins, USEPA Region 9, Minutes of the Board of Directors meeting of the Upper San Gabriel Valley Municipal Water District, February 12, 2002, available at <http://www.usgvmwd.org>.

**Table 10-6. Pilot-scale Studies, Big Dalton, California**

Contaminant	Influent Concentration	Effluent Concentration	Secondary Waste Concentration
Perchlorate	18–76 ppb	<4 ppb	2,000–10,000 ppb
Nitrate	20–28 ppm	5–14 ppm	800–1,900 ppm
Sulfate	41–67 ppm	0.1–2 ppm	3,000–9,000 ppm
Chloride	20–35 ppm	20–120 ppm	25,000–40,000 ppm

(Adapted from Big Dalton Perchlorate Removal Pilot Study, Calgon Carbon Corporation, October 30, 1998)

Ion exchange is energy-intensive due to the “pump and treat” nature of its operation. It requires frequent changing or regeneration of exchange resins and generates a problematic residual waste in the form of brine or contaminated resins that still contain the perchlorate. The secondary wastes generated during treatment would require additional treatment or disposal. It is possible that a treatment train using ion exchange and *ex situ* biological treatment of the secondary waste could be used to treat low levels of perchlorate contamination in surface waters and wetlands (Gilland and O’Brien, 1999).

#### 10.8.4 Chemical Processes

Because perchlorate is a highly oxidized compound, it would be expected that the addition of a chemical-reducing agent would convert its chlorine to chloride, an environmentally benign component of common table salt. However, the chemical reaction between perchlorate and most commonly used reducing agents is too slow to be of practical use at ambient temperatures and low-level concentrations (EPA, 1998).

Researchers at Georgetown University have, however, successfully reduced perchlorate to chloride using titanous ions (Ti(III)). While the researchers believe that *ex situ* batch, or a continuous process using Ti(III) plus a university-developed catalytic media, can be used for the rapid reduction of perchlorate in contaminated water, this assertion has not been fully demonstrated. Although water treatment technologies based on these new catalysts are not currently available, work with rhenium catalysts and sulfides show greater promise for perchlorate reduction (Roote, 2001).

Ozone-peroxide treatment by itself appears to have minimal effect on perchlorate in water. However, ozone-peroxide followed by liquid-phase carbon treatment has been demonstrated to remove perchlorate from groundwater at a water supply well in the San Gabriel Valley. The useful life of the columns is an issue, with further testing required to determine the economic viability (Roote, 2001).

#### 10.8.5 Thermal Processes

Most thermal processes are not applicable to aqueous waste streams. Supercritical water oxidation (SCWO), however, has been proven to destroy perchlorate in aqueous streams. As water is subjected to temperatures and pressures above its critical point (374.2° Celsius,

22.1 MPa), it exhibits properties that differ from both liquid water and steam. At the critical point, the liquid and vapor phase of water have the same density. If temperature or pressure is then increased, hydrogen bonding between water molecules essentially stops. Supercritical water sustains combustion and oxidation reactions because it mixes well with oxygen and with nonpolar organic compounds. Reductions, such as those necessary to destroy the perchlorate ion, also take place (Thomason, et al., 1995).

In 1995, General Atomics (GA) used a bench-scale SCWO reactor at Thiokol, Utah to treat CYH propellant, a solid rocket fuel containing nitroglycerin, nitrocellulose, HMX explosive, ammonium perchlorate, and aluminum metal. The concentration of ammonium perchlorate in CYH is 10.8%. In all laboratory and bench-scale tests, the aluminum metal was transported through the system and separated from the treated effluent solution. During optimization testing, DREs of up to 99.9% were achieved. In initial pilot-scale testing at Thiokol, the unit processed approximately 25 pounds of CYH propellant. The material was processed as a 1% hydrolyzed solution at various operating conditions over a 24-hour continuous run. A subsequent test successfully treated a 695-pound batch of CYH propellant at concentrations of up to 21%, and propellant throughput rates of up to approximately 800 pounds were achieved during testing (Spritzer, et al., 1995).

The costs of SCWO treatment would be very high due to the high temperatures and pressures required for processing. This would likely limit the use of the technology to very complex waste streams containing perchlorate and other compounds that cannot be easily treated using other methods (Gilland and O'Brien, 1999).

## 11.0 REFERENCES

### General In Situ Bioremediation

Agency for Toxic Substances and Disease Registry (ATSDR). Internet Web Site

<http://www.atsdr.cdc.gov/>

American Society of Testing and Materials (ASTM). *Standard Practice for Oxidation-Reduction Potential of Water*. ASTM D 1498-93. 1993.

American Society of Testing and Materials. *Standard Guide for Remediation of Groundwater by Natural Attenuation at Petroleum Release Sites*. Designation: E 1943-98. August 1998.

American Society of Testing and Materials. *Standard Guide for Site Characterization for Environmental Purposes with Emphasis on Soil, Rock, Vadose Zone and Groundwater*. Method D5730-96. 1996.

Bailar, John, C. Jr., et al. 1978. *Chemistry*. Academy Press, New York, New York.

Bailey, James E. and David F. Ollis. 1986. *Biochemical Engineering Fundamentals*, Second Edition. McGraw-Hill.

Bates, Robert L. and Julia A. Jackson. 1987. *Glossary of Geology*. Third Edition. American Geological Institute.

Buscheck, T.A., et al. 1991. "Infiltration of a Liquid Front in an Unsaturated, Fractured Porous-Medium." *Water Resources Research*. Vol. 27, pg. 2099.

ChemFinder. Internet Web Site. <http://chemfinder.cambridgesoft.com/>

Centers for Disease Control and Prevention. Internet Web Site. <http://www.cdc.gov>

Cookson, John A. 1995. *Bioremediation Engineering, Design and Applications*. McGraw-Hill.

Committee on the Waste Isolation Pilot Plant. 1996. *The Waste Isolation Pilot Plant: A Potential Solution of Transuranic Waste*. National Academy Press, Washington, D.C., pg. 157.

Cotsworth, Elizabeth. December 27, 2000. Memorandum: "Applicability of RCRA Section 3020 to In Situ Treatment of Groundwater." Office of Solid Waste, EPA.

Driscon, Fletcher G. 1989. *Groundwater and Wells*. Second Edition. Johnson Filtration Systems, Inc.

Editors. 1989. *The New Merriam-Webster Dictionary*. Merriam-Webster Inc., Springfield, Mass.

Environmental Protection Agency. 2000. *Engineered Approaches to In Situ Bioremediation of Chlorinated Solvents: Fundamentals and Field Applications*. Solid Waste and Emergency Response. EPA542-R-00-008.

- Environmental Protection Agency. December 27, 2000. Memorandum: “Applicability of RCRA Section 3020 to In-Situ Treatment of Groundwater.” Elizabeth A. Cotsworth, Director, Office of Solid Waste.
- Environmental Protection Agency. September 1998. *Technical Protocol for Evaluating Natural Attenuation of Chlorinated Solvents in Groundwater*. Office of Research and Development. EPA/600/R98/128. Washington, D.C.
- Environmental Protection Agency. *State Policies Concerning the Use of Injectants for In-Situ Ground Water Remediation*. Technology Innovation Office, EPA/542-R-96-001. <http://www.gwrtac.org/pdf/Inject.pdf>
- Environmental Protection Agency, April 21, 1999. *Use of Monitored Natural Attenuation at Superfund, RCRA Corrective Action, and Underground Storage Tank Sites*. OSWER Directive 9200.4-17P.
- Environmental Security Technology Certification Program. February 1998. *A Treatability Test for Evaluating the Potential Applicability of the Reductive Anaerobic Biological In Situ Treatment (RABITT) to Remediate Chloroethenes*. [http://www.estcp.org/documents/techdocs/Rabbitt\\_Protocol.pdf](http://www.estcp.org/documents/techdocs/Rabbitt_Protocol.pdf)
- Federal Remediation Technologies Roundtable. October 1998. *Guide to Documenting and Managing Cost and Performance Information for Remediation Projects*. EPA-524-B-96-007. <http://www.frtr.gov/cost/>
- Federal Remediation Technologies Roundtable. October 1998. *In Situ Bioremediation Using Molasses Injection at an Abandoned Manufacturing Facility, Emeryville, California*. <http://www.frtr.gov/cost/>
- Felder, Richard M. and Ronald W. Rousseau. 2000. *Elementary Principles of Chemical Processes*. John Wiley & Sons, Inc.
- Fogler, H. Scott. 1986. *Elements of Chemical Reaction Engineering*. Prentice-Hall.
- Kookanar, R.S. and Aylmore Lag Dihj. 1995. “A Field-Study of Leaching and Degradation of Nine Pesticides in a Sandy Soil.” *Australian Journal of Soil Research*, Vol. 33, No. 6, pp. 1019–1030.
- Looney, Brian and Ronald Falta. 2000. *Vadose Zone: Science and Technology Solutions*. Battelle Press, Columbus, Ohio, p. 1120.
- Iowa State University. *Kinetics of Cometabolism: A Comparison of Current Models Based on Their Ability to Predict Actual Data*. [http://www.public.iastate.edu/~shanes/cometabolism/Kinetics\\_web.html](http://www.public.iastate.edu/~shanes/cometabolism/Kinetics_web.html)
- Heath, Ralph. 1983. “Basic Ground-Water Hydrology,” U.S. Geological Survey, Paper 2220, Library of Congress.

Henderson, T. May–June 1994. “Geochemical Reduction of Hexavalent Chromium in the Trinity Sand Aquifer,” *Groundwater*. Vol. 32, No. 3, pp. 477–486.

Interstate Technology and Regulatory Council. December 1997. *Cost and Performance Reporting for In Situ Bioremediation Technologies*.  
<http://www.itrcweb.org/common/content.asp?en=TA301724&sea=Yes&set=Both&sca=Yes&sct=Long>

Interstate Technology and Regulatory Council. June 2000. *Technology Overview: Emerging Technology for Enhanced In Situ Bionitrification (EISBD) of Nitrate-Contaminated Groundwater*.  
<http://www.itrcweb.org/common/content.asp?en=TA172940&sea=Yes&set=Both&sca=Yes&sct=Long>

Interstate Technology and Regulatory Council. September 1999. *Five Course Evaluation Summary, ITRC/RTDF Training Course: Natural Attenuation of Chlorinated Solvents in Groundwater*.  
<http://www.itrcweb.org/common/content.asp?en=TA301724&sea=Yes&set=Both&sca=Yes&sct=Long>

Interstate Technology and Regulatory Council. September 1999. *Natural Attenuation of Chlorinated Solvents in Groundwater: Principles and Practices*.  
<http://www.itrcweb.org/common/content.asp?en=TA301724&sea=Yes&set=Both&sca=Yes&sct=Long>

Interstate Technology and Regulatory Council. December 1998. *Technical and Regulatory Requirements for Enhanced In Situ Bioremediation of Chlorinated Solvents*.  
<http://www.itrcweb.org/common/content.asp?en=TA301724&sea=Yes&set=Both&sca=Yes&sct=Long>

Interstate Technology and Regulatory Council. 1999. “Natural Attenuation of Chlorinated Solvents in Groundwater: Training Course.”

Interstate Technology and Regulatory Council. April 2001. *Technical/Regulatory Guidelines: Phytotechnology Technical and Regulatory Guidance Document*, p. 34.  
<http://www.itrcweb.org/common/content.asp?en=TA863827&sea=Yes&set=Both&sca=Yes&sct=Long>

Interstate Technology and Regulatory Council. June 2001. *Technical/Regulatory Guidelines: Technical and Regulatory Guidance for In Situ Chemical Oxidation of Contaminated Soil and Groundwater*, pp. 9–11.  
<http://www.itrcweb.org/common/content.asp?en=TA339169&sea=Yes&set=Both&sca=Yes&sct=Long>

Iowa State University. 2001. “Kinetics of Cometabolism: A Comparison of Current Models Based on Their Ability to Predict Actual Data.”  
[http://www.public.iastate.edu/~shanes/cometabolism/Kinetics\\_web.html](http://www.public.iastate.edu/~shanes/cometabolism/Kinetics_web.html)



James E. and David F. Ollis. 1986. *Biochemical Engineering Fundamentals*, Second Edition. McGraw-Hill.

Material Safety Data Sheets. “Where to Find Material Safety Data Sheets on the Web.” Internet Web Site. <http://www.ilpi.com/msds/index.html#Internet>

Millar, Kelly, et al. “Biocide Application Prevents Biofouling of a Chemical Injection/Recirculation Well.” Sixth Annual Symposium on *In Situ* and On-Site Bioremediation. Battelle Conferences. San Diego. June 4–7, 2001.

National Center for Environmental Assessment (NCEA). Internet Web Site. <http://cfpub.epa.gov/ncea/cfm/nceahome.cfm>

National Exposure Research Laboratory (NERL). Internet Web Site. <http://www.epa.gov/nerl/>

National Health and Environmental Effects Research Laboratory (NHEERL). Internet Web Site. <http://www.epa.gov/nheerl/>

National Institute of Occupational Safety and Health. International Chemical Safety Cards. Internet Web Site. <http://www.cdc.gov/niosh/ipcs/icstart.html>

National Research Council. 1993. *In Situ Bioremediation: When does it work?* National Academic Press.

National Toxicology Program. Health and Safety Reports. Internet Web Site. [http://ntp-db.niehs.nih.gov/htdocs/Chem\\_Hs\\_Index.html](http://ntp-db.niehs.nih.gov/htdocs/Chem_Hs_Index.html)

Nitao, J. and T. Buscheck. December 1993. “Cell Growth Kinetics.” *Water Resource Research*. Vol. 29, No. 12, pp. 4177–4177.

Nuttall, E. and B. Faris. “In Situ Denitrification Field Demonstration.” Remediation of Chlorinated and Recalcitrant Compounds, Third International Conference. Monterey, Calif., May 2002.

Quinton, Gary E., R.J. Buchanan, D.E. Ellis, and S.H. Shoemaker. Autumn 1997. “A Method to Compare Groundwater Cleanup Technologies.” *Remediation*.

Sandia National Laboratories. Geochemistry Department. MNAtoolbox. Internet Web Site. <http://www.sandia.gov/eeselector/gc/gc/na/mnahome.html>

Sandia National Laboratories. Geochemistry Department. March 1999. *Site Screening and Technical Guidance for Monitored Natural Attenuation at DOE Sites*. Sandia 99-0464. <http://www.sandia.gov/eeselector/gc/gc/na/mnatoolbox.pdf>

Spectrum Laboratories, Inc. Internet Web Site. <http://www.speclab.com/compound/chemcas.htm>

Strategic Environmental Research and Development Program. November 2000. *Exploratory Development Program: Alternatives to Microbial Microcosm Studies*. <http://www.serdp.org.seed-sons/SEEDSON-02002.html>

Stumm and Morgan. 1981. *Aquatic Chemistry*. Second Edition. John Wiley & Sons, Inc., New York.

Syracuse Research Corporation. Internet Web Site. Biological Chemical Search.  
<http://esc.syrres.com/efdb/biolog.htm>

TOXNET. Toxicology Data Network. <http://toxnet.nlm.nih.gov/>

United Nations Environmental Programme. Internet Web Site. <http://www.chem.unep.ch/irptc/>

University of Minnesota, Biocatalysis/Biodegradation Database. Internet Web Site.  
<http://umbbd.ahc.umn.edu/>

### References for Nitrate

Blair, A., S.H. Zahm, K.P. Cantor, and M.H. Ward. 1997. "Occupational and Environmental Risk Factors for Chronic Lymphocytic Leukemia and Non-Hodgkin's Lymphoma," Proceeding from 1997 U.S. Public Health Service Workshop: *Determining the Role of Environmental Exposures as Risk Factors for B-Cell Chronic Lymphoproliferative Disorders*, <http://www.cdc.gov/nceh/programs/lab/flowcyto/pub/1997/html/doc16.htm>.

Bohn, Hinrich, et al. 1979. *Soil Chemistry*. John Wiley & Sons. New York, N.Y.

Burkholder, J.M. and H.B. Glasgow, Jr. 1997. "*Pfiesteria piscicida* and other *Pfiesteria*-like dinoflagellates: Behavior, impacts, and environmental controls," *Limnology and Oceanography*, Vol. 42, No. 5, pp. 1052–1075.

Centers for Disease Control and Prevention. 1996. "Spontaneous Abortions Possibly Related to Ingestion of Nitrate-Contaminated Well Water – LaGrange County, Indiana, 1991–1994," <http://www.cdc.gov/epo/mmwr/preview/mmwrhtml/00042839.htm>.

Chapelle, Francis H. 1993. *Ground-Water Microbiology and Geochemistry*, John Wiley & Sons, Inc., pp. 251–253.

Deng, L.J. 1998. *In Situ Biological Denitrification of Groundwater*. Master Thesis, University of New Mexico, Department of Chemical and Nuclear Engineering.

European Commission Directorate General-Environment. September 2000. *Study on Investment and Employment Related to EU Policy on Air, Water, and Waste: Final Report, Best Estimate of Cost*. WRc: Ref EC 4739/A.1.  
[http://europa.eu.int/comm/environment/enveco/industry\\_employment/inv\\_and\\_empl\\_annex\\_1.pdf](http://europa.eu.int/comm/environment/enveco/industry_employment/inv_and_empl_annex_1.pdf)

Hatzinger, Paul, et al. March 2002. "In Situ and Ex Situ Bioremediation for Treating Perchlorate in Groundwater." *Journal of Remediation*.

Jones, Clayton. 2001. *Enhanced In Situ Biotenitrification*. Master Thesis, University of New Mexico, Chemical Engineering Department.

- Material Safety Data Sheets. “Potassium Nitrate and Ammonium Nitrate.” Mallinckrodt Baker Inc. <http://www.jtbaker.com/msds/p5950.htm>
- McCarty, P., L. Beck, and P. St. Amant. “Biological Denitrification of Wastewaters by Addition of Organic Materials.” Proceedings, 24<sup>th</sup> Industrial Waste Conference. Lafayette, Ind. May 6–8, 1969, pp. 1271–1286.
- McQuillan, Dennis. May 1995. “High Ground-water Nitrate in Tijeras Arroyo, Hells Canyon, and Abo Arroyo: Evidence for a Natural Geologic Origin,” *New Mexico Geology*, Vol. 17, No. 2.
- McQuillan, et al. “Intrinsic Cometabolism of Carbon Tetrachloride with Gasoline: Regulatory Site-Closure,” First International Conference on Remediation of Chlorinated and Recalcitrant Compounds, Battelle Press, Monterey, Calif., May 18–21, 1998.
- Meyer, M. “How Common is Methemoglobinemia from Nitrate-contaminated Wells? – A South Dakota Perspective,” Proceedings of the 39<sup>th</sup> Annual Midwest Ground-Water Conference. Bismark, North Dakota, October 16–18, 1994.
- Rabalais, N.N., E. Turner, and W.J. Wiseman. 1999. “Hypoxia in the Gulf of Mexico.” *Journal of Environmental Quality*.
- Spalding, R., and M. Exner. July – September 1993. “Occurrence of Nitrate in Groundwater,” *Journal of Environmental Quality*, Vol. 22, No. 3., Madison, Wis.
- Titus, F.B., Jr. 1980. “Groundwater in the Sandia and Northern Manzano Mountains, Socorro, New Mexico,” Bureau of Mines and Mineral Resources, Hydrologic Report 5.
- Water Technology On Line. “Study Finds Nitrate-Cancer Link,” April 19, 2001. [http://waternet.com/News.asp?mode=4&N\\_ID=21690](http://waternet.com/News.asp?mode=4&N_ID=21690)

### References for Carbon Tetrachloride

- Agency for Toxic Substances and Disease Registry. Centers for Disease Control and Prevention. September 1995. <http://www.atsdr.cdc.gov/tfacts30.html>
- Agency for Toxic Substances and Disease Registry. Centers for Disease Control and Prevention. ToxFAQs<sup>TM</sup> for Dichlorvos. September 1997. [ATSDR - ToxFAQs: Dichlorvos](#)
- Agency for Toxic Substances and Disease Registry. Centers for Disease Control and Prevention. Public Health Statement for Dichlorvos. September 1997. [ATSDR - Public Health Statements: Dichlorvos](#)
- Agricultural Research Service. U.S. Department of Agriculture. ARS Methyl Bromide Research. January 31, 2002. [Methyl Bromide Home Page](#)

- Bower, E.J. and P. McCarty. 1983. "Transformation of 1- and 2-Carbon Halogenated Aliphatic Organic Compounds under Methanogenic Conditions." *Applied Environmental Microbiology*, Vol. 45, p. 1286.
- Bower, E.J. and P. McCarty. 1983. "Transformation of Halogenated Organic Compounds under Denitrification Conditions." *Applied Environmental Microbiology*, Vol. 45, p. 1295.
- Chicurel, Marina. 1999. "KC and the Ground Sludge Band." *Science Notes*, Science Communication Program, University of California, Santa Cruz. [Science Notes 1999—KC and the Ground Sludge Band](#)
- Cookson, John T., Jr. 1995. *Bioremediation Engineering: Design and Application*. McGraw-Hill, Inc., New York, N.Y., p. 156.
- Doherty, Richard E. 2000. "A History of the Production and Use of Carbon Tetrachloride, Tetrachloroethylene, Trichloroethylene, and 1,1,1-Trichloroethane in the United States: Part 1 – Historical Background; Carbon Tetrachloride and Tetrachloroethylene." *Journal of Environmental Forensics*, Vol. 1, pp 69–81.
- Dybas, M. J., D.W. Hyndman, R. Heine, J. Tiedje, T. Voice, R. Wallace, D.C. Wiggert, X. Zhao, R. Artuz, and C.S. Criddle. 2000. "Operation and Long-term Performance of a Full-Scale Biocurtain." *Environmental Science & Technology* (in prep). [Publications](#)
- ECO-USA. Carbon Tetrachloride. <http://www.eco-usa.net/toxics/ccl4.shtml>
- Elig, C., T. Tschan, R. Scholtz, A. Cook, and T. Leisinger. 1988. "Transformation of Tetrachloromethane to Dichloromethane and Carbon Dioxide by *Acetobacterium woodii*." *Applied Environmental Microbiology*, Vol. 54, p. 2819.
- Environmental Protection Agency. 2001. Office of Water. Ground Water and Drinking Water. "Consumer Fact Sheet: Carbon Tetrachloride." <http://www.epa.gov/safewater/dwh/c-voc/carbonte.html>
- EXTOXNET, Extension Toxicology Network. June 1996. "Pesticide Information Profiles: Malathion." [EXTOXNET PIP - MALATHION](#)
- EXTOXNET. Extension Toxicology Network. "Pesticide Information Profiles: Chloropicrin." [EXTOXNET PIP - CHLOROPICRIN](#)
- Freeman, D., M. Lasecki, S. Hasahsham, R. Scholze. 1995. *Accelerated Biotransformation of Carbon Tetrachloride and Chloroform by Sulfate-reducing Enrichment Cultures*, p. 123. R. Hinchee, A. Leeson, L. Semprini, Eds., Batelle Press.
- Gupta, M., A. Gupta, M. Suidan, G. Sayles. 1996. "Biotransformation Rates of Chloroform under Anaerobic Conditions: Methanogenesis." *Water Research*, Vol. 30, p. 1377.

- Gupta, M., A. Gupta, M. Suidan, G. Sayles. 1996. "Biotransformation Rates of Chloroform under Anaerobic Conditions: Sulfate Reduction." *Water Research*, Vol. 30, p. 1387.
- Hansen, J., D. Johnstone, J. Fredrickson, and T. Brouns. 1993. "Transformation of Tetrachloromethane under Denitrifying Conditions by a Subsurface Bacterial Consortium and Its Isolates." *Bioremediation of Chlorinated and Polycyclic Aromatic Hydrocarbon Compounds*, p. 293. R. Hinchee, A. Leeson, L. Semprini, S.K. Ong, Eds., Battelle Press.
- Innovative Treatment Remediation Demonstration Program. 2000. Literature Review: "Natural Attenuation Mechanisms and Rates for Chloromethane Subsurface Contamination at Hanford." Hanford Carbon Tetrachloride Project. [http://hanford-site.pnl.gov/groundwater/reports/PNNL\\_13560.pdf](http://hanford-site.pnl.gov/groundwater/reports/PNNL_13560.pdf)
- "Dichloroethene and Vinyl Chloride by Dehalococcoides ethenogenes." *Environmental Science Technology*, Vol. 35, p. 516.
- Michigan State University. 2000. "Carbon Tetrachloride Degradation by *P. stutzeri* strain KC." <http://www.egr.msu.edu/schoolcraft/kcphysiol.htm>
- "Oak Ridge: DNAPL in Fractured Bedrock." [Oak Ridge DNAPL Project Home Page](#)
- "Oak Ridge Y-12 Project Status." [Oak Ridge Y-12 Project Status](#)
- Pinder, G. and L.M. Abriola. 1986. "On the Simulation of Nonaqueous-Phase Organic Compounds in the Subsurface." *Water Resources Research*, Vol. 22, No. 9, pp. 109S–119S.
- Purdue University Cooperative Extension Service. June 1984. "Preventing Insect Problems in Farm-stored Corn," *National Corn Handbook*, Pest Management chapter (NCH-7). West Lafayette, Ind. [NCH-7](#).
- Sherwood, Juli, James Peterson, and Rodney Skeen. 1996. "Effects of Nitrate and Acetate Availability on Chloroform Production during Carbon Tetrachloride Destruction." *Biotechnology and Bioengineering*, Vol. 51. John Wiley & Sons, Inc. [Battelle Bioprocessing - Abstract](#)
- Synclair, Wayne. Health Library: Malation Index. [Malathion Health Research](#)
- Tripp, T. and J. Liu. November 2000. "Carbon Tetrachloride Pathway Map (Anaerobic)." University of Minnesota. [Carbon Tetrachloride Degradation Pathway](#)
- Truex, M.J., B.S. Hooker, and D.B. Anderson. July 1996. *Accelerated In Situ Bioremediation of Groundwater: Innovative Technology Summary Report*. Pacific Northwest National Laboratory. U.S. Department of Energy.

Truex, M.J., C.J. Murray, C.R. Cole, R.J. Cameron, M.D. Johnson, R.S. Skeen, C.D. Johnson. May 2001. *Assessment of Carbon Tetrachloride Groundwater Transport in Support of the Hanford Carbon Tetrachloride Innovative Technology Demonstration Program*. Pacific Northwest National Laboratory, U.S. Department of Energy.

U.S. Department of Energy. 1999, *In Situ Bioremediation of the Hanford Carbon Tetrachloride Plume: Innovative Technology Summary Report*, OST Reference # 1742.

Ware, George. 1983. *Pesticides: Theory and Application*. W.H. Freeman and Company.

### References for Table 9.1 Carbon Tetrachloride

Chemical Formula: Listed as peer reviewed, no citation provided.

Molecular Weight: [Lide, D.R. (ed.). 1998–1999. *CRC Handbook of Chemistry and Physics*. 79th Edition. CRC Press, Inc., Boca Raton, Fla., pp. 3–207] \*\*PEER Reviewed\*\*

Color/Form: [Budavari, S. (ed.) 1996. *The Merck Index -An Encyclopedia of Chemicals, Drugs, and Biologicals*. Merck and Co., Inc., Whitehouse Station, N.J., p.297] \*\*PEER Reviewed\*\*

Taste/Odor: [NIOSH. 1997. *NIOSH Pocket Guide to Chemical Hazards*. DHHS (NIOSH) Publication 97-140. U.S. Government Printing Office, Washington, D.C., p. 54] \*\*PEER Reviewed\*\*

Density/Specific Gravity: [Lide, D.R. (ed.) 1998–1999. *CRC Handbook of Chemistry and Physics*. 79th Edition. CRC Press, Inc., Boca Raton, Fla., pp. 3–207] \*\*PEER Reviewed\*\*

Boiling Point: [Lide, D.R. (ed.). 1998–1999. *CRC Handbook of Chemistry and Physics*. 79th Edition. CRC Press, Inc., Boca Raton, Fla., pp. 3–207] \*\*PEER Reviewed\*\*

Melting Point: [Lide, D.R. (ed.) 1998–1999. *CRC Handbook of Chemistry and Physics*. 79th Edition. CRC Press, Inc., Boca Raton, Fla., pp. 3–207] \*\*PEER Reviewed\*\*

Octanol/Water Partition Coefficient ( $\log K_{OW}$ ): [Hansch, C., A. Leo, D. Hoekman. 1995. *Exploring QSAR - Hydrophobic, Electronic, and Steric Constants*. American Chemical Society, Washington, D.C., p. 3] \*\*PEER Reviewed\*\*

Partition Coefficient ( $K_{OC}$ ): *Technical and Administrative Guidance Document 4046*. January 1994. New York State Department of Environmental Conservation. For carbon tetrachloride,  $K_{OC} = -0.55 \log S$  (solubility in water in ppm) +3.64

Solubility: [Horvath A.L. 1982. *Halogenated Hydrocarbons: Solubility-Miscibility with Water*. Marcel Dekker, Inc., New York, N.Y., p. 889] \*\*PEER Reviewed\*\*

Vapor Density: [Spencer, E.Y. 1982. *Guide to the Chemicals Used in Crop Protection*. 7th Edition. Publication 1093. Research Institute, Agriculture Canada, Ottawa, Canada: Information Canada, p. 82] \*\*PEER Reviewed\*\*

Vapor Pressure: [Boublik, T., et al. 1984. *The Vapor Pressures of Pure Substances: Selected Values of the Temperature Dependence of the Vapor Pressures of Pure Substances in the Normal and Low Pressure Region*. Vol. 17. Elsevier Science Publications, Amsterdam, Netherlands.] \*\*PEER Reviewed\*\*

Evaporation Rate: [Mackison, F.W., R.S. Stricoff, and L.J. Partridge, Jr., (Editors). January 1981. *NIOSH/OSHA - Occupational Health Guidelines for Chemical Hazards*. DHHS (NIOSH) Publication No. 81-123 (3 Volumes). U.S. Government Printing Office, Washington D.C., p. 2] \*\*PEER Reviewed\*\*

Henry's Law Constant: [Leighton, D.T., Jr. and J.M. Calo. 1981. *Journal of Chemical Engineering*. Vol. 26, pp. 382-385] \*\*PEER Reviewed\*\*

### References for Table 9.1 Chloroform

Chemical Formula: [*The Merck Index*. 1983. 10th Edition. Merck Co., Inc., Rahway, N.J., p. 300] \*\*PEER Reviewed\*\*

Molecular Weight: [Budavari, S. (Editor). 1996. *The Merck Index -An Encyclopedia of Chemicals, Drugs, and Biologicals*. Merck and Co., Inc., Whitehouse Station, N.J., p.357] \*\*PEER Reviewed\*\*

Color/Form: [Prager, J.C. 1995. *Environmental Contaminant Reference Databook Volume 1*. Van Nostrand Reinhold, New York, N.Y., p. 453] \*\*PEER Reviewed\*\*

Taste/Odor: [Prager, J.C. 1995. *Environmental Contaminant Reference Databook Volume 1*. Van Nostrand Reinhold, New York, N.Y., p. 453] \*\*PEER Reviewed\*\*

Boiling Point: [Lewis, R.J., Sr. (Editor). 1997. *Hawley's Condensed Chemical Dictionary*. 13th Edition. John Wiley & Sons, New York, N.Y., p. 256] \*\*PEER Reviewed\*\*

Melting Point: [*Kirk-Othmer Encyclopedia of Chemical Technology*. 1991-Present. 4th Edition. Volume 1. John Wiley & Sons, New York City, N.Y., p. V5 (93)] \*\*PEER Reviewed\*\*

Specific Gravity: [Lewis, R.J., Sr. (Editor). 1997. *Hawley's Condensed Chemical Dictionary*. 13th Edition. John Wiley & Sons, New York, N.Y., p. 256] \*\*PEER Reviewed\*\*

Octanol/Water Partition Coefficient (log  $K_{OW}$ ): [Hansch, C., A. Leo, and D. Hoekman. 1995. *Exploring QSAR - Hydrophobic, Electronic, and Steric Constants*. American Chemical Society, Washington, D.C., p. 3] \*\*PEER Reviewed\*\*

Partition Coefficient ( $K_{OC}$ ): *Technical and Administrative Guidance Document 4046*. January 1994. New York State Department of Environmental Conservation. Experimental Value

- Solubility: [DeWulf, J. and H. VanLangenhove. 1997. *Water Resources*, Volume 31, pp. 1825–1838.] \*\*PEER Reviewed\*\*
- Vapor Density: [Weiss, G. 1986. *Hazardous Chemicals Handbook*. Noyes Data Corporation, Park Ridge, N.J., p. 261] \*\*PEER Reviewed\*\*
- Vapor Pressure: [Boublik, T., et al. 1984. *The Vapor Pressures of Pure Substances: Selected Values of the Temperature Dependence of the Vapor Pressures of Pure Substances in the Normal and Low Pressure Region*. Second Revised Edition. Elsevier Science Publications, Amsterdam, Netherlands.] \*\*PEER Reviewed\*\*
- Evaporation Rate: [Mackison, F.W., R.S. Stricoff, and L.J. Partridge, Jr., (Editors). January 1981. *NIOSH/OSHA - Occupational Health Guidelines for Chemical Hazards*. DHHS (NIOSH) Publication No. 81-123 (3 Volumes). U.S. Government Printing Office, Washington, D.C., p. 2] \*\*PEER Reviewed\*\*
- Henry's Law Constant: [Gossett, J.M. 1987. *Environmental Science and Technology*, Vol. 21, pp. 202–206] \*\*PEER Reviewed\*\*

#### References for Table 9.1 Dichloromethane

Chemical Formula: Listed as peer reviewed, no citation provided.

Molecular Weight: [Budavari, S. (ed.). 1996. *The Merck Index -An Encyclopedia of Chemicals, Drugs, and Biologicals*. Merck and Co., Inc., Whitehouse Station, N.J., p.1035] \*\*PEER Reviewed\*\*

Color/Form: [Budavari, S. (ed.). 1996. *The Merck Index -An Encyclopedia of Chemicals, Drugs, and Biologicals*. Merck and Co., Inc., Whitehouse Station, N.J., p.1035] \*\*PEER Reviewed\*\*

Taste/Odor: [NIOSH. *NIOSH Pocket Guide to Chemical Hazards*. 1994. DHHS (NIOSH) Publication 94-116. U.S. Government Printing Office, Washington, D.C., p. 208] \*\*PEER Reviewed\*\*

Melting Point: [Budavari, S. (ed.). 1996. *The Merck Index -An Encyclopedia of Chemicals, Drugs, and Biologicals*. Merck and Co., Inc., Whitehouse Station, N.J., p.1035] \*\*PEER Reviewed\*\*

Boiling Point: [Budavari, S. (ed.). 1996. *The Merck Index -An Encyclopedia of Chemicals, Drugs, and Biologicals*. Merck and Co., Inc., Whitehouse Station, N.J., p.1035] \*\*PEER Reviewed\*\*

Density/Specific Gravity: [Budavari, S. (ed.). 1996. *The Merck Index -An Encyclopedia of Chemicals, Drugs, and Biologicals*. Merck and Co., Inc., Whitehouse Station, N.J., p.1035] \*\*PEER Reviewed\*\*



- Octanol/Water Partition Coefficient ( $\log K_{OW}$ ): [Hansch, C., A. Leo, D. Hoekman. 1995. *Exploring QSAR - Hydrophobic, Electronic, and Steric Constants*. American Chemical Society, Washington, D.C., p. 3] \*\*PEER Reviewed\*\*
- Partition Coefficient ( $K_{OC}$ ): *Technical and Administrative Guidance Document 4046*. January 1994. New York State Department of Environmental Conservation. Experimental Value
- Solubility: [Horvath A.L. 1982. *Halogenated Hydrocarbons: Solubility-Miscibility with Water*. Marcel Dekker, Inc., New York, N.Y., page not listed] \*\*PEER Reviewed\*\*
- Vapor Density: [*Kirk-Othmer Encyclopedia of Chemical Technology*. 1991–Present. 4th Edition. Volume 1. John Wiley & Sons, New York City, N.Y., p V5 (93), p. 1042] \*\*PEER Reviewed\*\*
- Vapor Pressure: [Boublik, T., et al. 1984. *The Vapor Pressures of Pure Substances: Selected Values of the Temperature Dependence of the Vapor Pressures of Pure Substances in the Normal and Low Pressure Region*. Second Revised Edition. Elsevier Science Publications, Amsterdam, Netherlands] \*\*PEER Reviewed\*\*
- Evaporation Rate: [McGovern, E.W. 1943. *Industrial Engineering Chemistry* Vol. 35, pp. 1230–1239] \*\*PEER Reviewed\*\*
- Henry's Law Constant: [Leighton, D.T., Jr. and J.M. Calo. 1981. *Journal of Chemical Engineering*, Vol. 26, pp. 382-385] \*\*PEER Reviewed\*\*

### References for Perchlorate

- Air Force Research Laboratory, Airbase & Environmental Technology Division. 1998. "Operational Implementation of Ammonium Perchlorate Degradation." Final Report.
- American Water Works Association Research Foundation. 1997. "Final Report of the Perchlorate Research Issue Group Workshop," September 30 to October 2. American Water Works Association Research Foundation, Denver, Colo.
- Ashford, R.D. 1994. *Ashford's Dictionary of Industrial Chemicals*. Wavelength Publications Ltd., London, England.
- Britto, Ronnie. 2000. "Mechanisms of Perchlorate Degradation: An Overview," Proceedings from the Perchlorate Technology Workshop, August 23 & 24, 2000. 5<sup>th</sup> Annual Joint Services Pollution Prevention and Hazardous Waste Management Conference and Exhibition, San Antonio, Texas.
- Budavari, S. (ed.). 1996. *The Merck Index - An Encyclopedia of Chemicals, Drugs, and Biologicals*. Merck and Co., Inc. Whitehouse Station, N.J.

Burge, Stephaney and Rolf Halden. September 1999. *Nitrate and Perchlorate Removal from Groundwater by Ion Exchange—Pilot Testing and Analysis*. Lawrence Livermore National Laboratory, UCL-ID-135639. Livermore, Calif.  
<http://www.erd.llnl.gov/library/ID-135639.pdf>

Calgon Carbon Corporation. 1998. “Big Dalton Perchlorate Removal Pilot Study,” Prepared for the Main San Gabriel Basin Water Master

Cannon, F.S. and C Na. 2000. “Perchlorate Removal Using Tailored Granulated Activated Carbon and Chemical Regeneration,” Presented at the Perchlorate Workshop of the Pollution Prevention Technology Transfer Conference of the Joint Armed Services, San Antonio, Texas.

Chemfinder Database. <http://chemfinder.cambridgesoft.com>.

Coates, J.D., U. Michaelidou, R.A. Bruce, S.M. O’Conor, J.N. Crespi, and L.A. Achenbach. 1999. “Ubiquity and Diversity of Dissimilatory (Per)chlorate-Reducing Bacteria,” *Appl. Environ. Microbiol.* Vol. 65, No. 12, pp. 5234–5241.

Coates, et al. SERDP in Progress Review, May 2001.

Cowan, D., M. Perlmutter, and P. Hatzinger. 2000. Presentations at the 5<sup>th</sup> Annual Joint Services Pollution Prevention and Hazardous Waste Management Conference and Exhibitions August 23 & 24, 2000.

Cox, E., E. Edwards, S. Neville, and M. Girard. 2000. “Cost-Effective Bioremediation of Perchlorate in Ground Water,” *Proceedings from the Perchlorate Technology Workshop August 23 & 24, 2000*. Held in conjunction with the 5th Annual Joint Services Pollution Prevention and Hazardous Waste Management Conference and Exhibition

Cox, et al., SERDP in Progress Review, May 2001.

Gilland, K.R. and M.H. O’Brien. 1999. “Perchlorate Remediation Technologies—Performance and Applicability to Contaminated Wetlands,” Poster session presented at Battelle Wetlands & Remediation Conference, Salt Lake City, Utah.

Harvey, G.J., D.T. Tsui, J.E. Eldridge, and G.J. Orris. 1999. 20th Annual Meeting Abstract Book, Society of Environmental and Toxicological Chemists. Abstract PHA015, p. 277.

Hatzinger, P. 2000. “*In Situ* Bioremediation of Perchlorate in Groundwater,” *Proceedings from the Perchlorate Technology Workshop, August 23 & 24, 2000*. Held in conjunction with the 5th Annual Joint Services Pollution Prevention and Hazardous Waste Management Conference and Exhibition.

Hatzinger, et al., SERDP in Progress Review, May 2001.

*Kirk-Othmer Encyclopedia of Chemical Technology*. 1991–Present. Volume 1, 4th Edition. John Wiley & Sons. New York City, N.Y., p. V10 85.

KowWin Calculator. Found at <http://esc.syrres.com/interkow/logkow.htm>.

Lide, D.R. (ed.). *CRC Handbook of Chemistry and Physics*. 1995–1996. 76th Edition. CRC Press, Inc., Boca Raton, Fla..

Logan, B.E., K. Kim, J. Miller, P. Mulvaney, and R. Unz. 1999. “Biological Treatment of Perchlorate-contaminated Waters,” 5<sup>th</sup> International In Situ and On-Site Bioremediation Symposium: Bioremediation of Metals and Inorganic Compounds, San Diego, Calif.

Logan, B.E. and S.S. Koenigsberg. 2000. “The Potential for In Situ Perchlorate Degradation.” 2<sup>nd</sup> International Conference on Remediation of Chlorinated and Recalcitrant Compounds, Monterey, Calif.

Logan, B.E. 2001, “Assessing the Outlook for Perchlorate Remediation.” *Environmental Science & Technology*, Vol. 35, No. 23.

Logan, Bruce E., Husen Zhang, Peter Mulvaney, Michael G. Milner, Ian M. Head, and Richard F. Unz. 2001. “Kinetics of Perchlorate and Chlorate–Respiring Bacteria,” *Applied and Environmental Microbiology*, June 2001, pp. 2499–2506.

Material Safety Data Sheet. Boston University. Boston Mass., March 1998.  
<http://www.bu.edu/es/LabSafety/ESMSDSPerchloric Acid.html>.

Material Safety Data Sheet. Fisher Scientific. Last Updated, June 2000.

Material Safety Data Sheet. Mallinckrodt Baker. Phillipsburg, N.J., November 1999.

*Merck Index*. 1983. 10th Edition. Merck Co., Inc., Rahway, N.J., p. 1028.

McEvoy, G.K. (ed.). 1996. *American Hospital Formulary Service—Drug Information 1996*. American Society of Health-System Pharmacists, Inc., Bethesda, Md. (plus supplements), p. 2767.

National Fire Protection Association. 1978. *Fire Protection Guide on Hazardous Materials*. 7th Edition. National Fire Protection Association, Boston, Mass., p. 49–231.

Nuttall, E., Ph.D. Personal Communication, University of New Mexico, 2002.

Oak Ridge National Laboratory. 1999. “Novel Ion Exchange Resin Removes Groundwater,” *Oak Ridge National Laboratory Review*, Vol. 32, No. 2, p. 23.

Perlmutter, M., “Implementation of Innovative In Situ Biotreatment Technology at NWIRP McGregor, Texas,” 5<sup>th</sup> Annual Joint Services Pollution Prevention and Hazardous Waste Management Conference and Exhibition, San Antonio, Texas, August 23 & 24, 2000.

Roote, Diane S. May 2001. *Technology Status Report, Perchlorate Treatment Technologies*, First Edition, Ground-Water Remediation Technologies Analysis Center, TS-01-01. Pittsburgh, Penn. [http://www.gwrtac.org/html/tech\\_status.html#PERC](http://www.gwrtac.org/html/tech_status.html#PERC)

- Schooner, L.L., G.F. Parkin, C.L. Just, B.V. Aken, and J.D. Shrout. 2002. "Phytoremediation and Bioremediation of Perchlorate at the Longhorn Army Ammunition Plant," Final Report, University of Iowa, May 2002.
- Sharp, Renee and B. Walker. July 1998. "Rocket Science: Perchlorate and the Toxic Legacy of the Cold War," Environmental Working Group, [www.erg.org](http://www.erg.org).
- Siddiqui, Mohamed, et al. 1998. *Occurrence of Perchlorate and Methyl Tertiary Butyl Ether in Groundwater of the American Water System*. American Water Works Service Co., Voorhees, N.J., September 30, 1998.
- Sparks, D.L. 1995. *Environmental Soil Chemistry*. Academic Press, San Diego, Calif., Chapter 5.
- Sposito, G. 1994. *Chemical Equilibria and Kinetics in Soil*. Oxford University Press, New York, N.Y., Chapters 4–5.
- Spritzer, M.H., D.A. Hazlebeck, and K.W. Downey. 1995. "Supercritical Water Oxidation of Chemical Agents, Solid Propellants, and Other DoD Hazardous Wastes," Prepared for the U.S. Army Program Manager for Chemical Demilitarization.
- Susaria, S., S.T. Bacchus, N.L. Wolfe, and S.C. McCutcheon. 1998. "Phytotransformation Using Parrot-Feather," *Soil & Groundwater Cleanup*, Vol. 20, No. 23.
- Thomason, T.B., G.T. Hong, K.C. Swallow, W.R. Killilea. 1990. "The MODAR Supercritical Water Oxidation Process," *Innovative Hazardous Waste Treatment Technology Series*. Volume 1: Thermal Processes.
- TOXNET, U.S. National Institute of Health TOXNET database. <http://toxnet.nlm.nih.gov>.
- U.S. Department of Health and Human Services, Public Health Service, Centers for Disease Control and Prevention, National Institute for Occupational Safety Health. *Registry of Toxic Effects of Chemical Substances* (RTECS). National Library of Medicine's current MRDLARS file, p. 85/8308.
- U.S. EPA Perchlorate Overview. EPA Office of Groundwater and Drinking Water. <http://www.epa.gov/ogwdw000/ccl/perchlo.html> , p. 13.
- U.S. EPA Region IX, Office of Ground Water and Drinking Water (U.S. EPA, Region IX Fact Sheet on Perchlorate, June 1999. <http://www.epa.gov/safewater/ccl/perchlor/>)
- U.S. EPA Office of Water, Office of Ground Water and Drinking Water. October 1, 1998, Perchlorate. <http://www.epa.gov/ogwdw/ccl/perchlor/perchlo.html>. (This Web page has been updated and no longer contains the information referenced in the report).
- U.S. National Institute of Health TOXNET database. <http://toxnet.nlm.nih.gov>.
- Urbansky, et al. May 2001. *Survey of Fertilizers and Related Materials for Perchlorate (ClO<sub>4</sub><sup>-</sup>)*, EPA/600/R-01/tba.

Urbansky, E.T. and M.R. Schock. 1999. "Issues in Managing the Risks Associated with Perchlorate in Drinking Water," *Journal of Environmental Management*, Vol. 56, pp. 79–95, Article No jema.1000.0274, available at <http://www.idealibrary.com>.

Weast, R. C. (ed.). 1983–1984. *Handbook of Chemistry and Physics*. 64th Edition. CRC Press, Inc., Boca Raton, Fla., p. B-84.

Zuromski, Personal Communication, April 2001.

## 12.0 ADDITIONAL READING REFERENCES

Perchlorate Occurrence at RCRA Facilities in New Mexico. 2000. PowerPoint Presentation by Julie Wanslow, New Mexico Environment Department, Hazardous Waste Bureau, October 24, 2000.

Kim, Kijung and Bruce Logan. 2001. "Microbial Reduction of Perchlorate in Pure and Mixed Culture Packed-Bed Bioreactors," Elsevier Science Ltd., Great Britain, pp. 1–6, [www.elsevier.com/locate/watres](http://www.elsevier.com/locate/watres).

Wu, Jun, Richard F. Unz, Husen Zhang, and Bruce Logan. 2001. "Persistence of Perchlorate and the Relative Numbers of Perchlorate- and Chlorate-Respiring Microorganisms in Natural Waters, Soils, and Wastewater," *Bioremediation Journal*, Battelle Memorial Institute, Vol. 5, No. 2, pp. 119–130.

Miller, Joel P. and Bruce E. Logan. 2000. "Sustained Perchlorate Degradation in an Autotrophic, Gas-Phase, Packed-Bed Bioreactor," *Environmental Science & Technology*, Vol. 34, No.14, pp. 3018–3022. American Chemical Society published on Web 06/16/2000.

Sharp, R. and B Walker. 2001. "Rocket Science: Perchlorate and the Toxic Legacy of the Cold War." Environmental Working Group Report, Washington D.C.

Calgon Carbon Corporation, Presentation at Main San Gabriel Watermaster Meeting, December 6, 2001.

Gu, B. Presentation at Main San Gabriel Watermaster Meeting, December 6, 2001.

American Society of Testing and Materials. 1993. *Standard Guide for Application of Groundwater Flow Model to a Site-Specific Problem*. ASTM D-5447-93.

American Society of Testing and Materials. 1984. *Standard Practice for Evaluating Environmental Fate Models of Chemicals*. E978-94.

Bear, J. and A. Verruijt. 1987. *Modeling Groundwater Flow and Pollution*. Reidel Publishing. Boston, Massachusetts.

Environmental Protection Agency. Center for Subsurface Modeling Support. 1997. VLEACH. CHEMFLOW. Kerr Laboratories. Ada, Oklahoma.

Fetter, C.W. 1993. *Contaminant Hydrogeology*. Macmillan Publishing Company. New York, New York.

Freeze, R.A. and J.A. Cherry. 1979. *Groundwater*. Prentice-Hall, Inc.

Mangold, D.C. and C.F. Tsang. 1991. "A Summary of Subsurface Hydrological and Hydrochemical Models." Rev. of *Geophysics*. Vol. 29 (1), pp. 51–79.

U.S. Department of Agriculture/Agricultural Research Station. United States Salinity Laboratory. HYDRUS-1D. Riverside, California.

This page intentionally left blank.

# **APPENDIX A**

## **Acronyms**



This page intentionally left blank.

## Acronyms and Abbreviations

ASTM	American Society of Testing and Materials
Br	Bromide
cm/sec	centimeters per second
CERCLA	Comprehensive Environmental Response, Compensation and Liability Act
Cl	Chloride
ClO <sub>4</sub>	Perchlorate
CH <sub>4</sub>	Methane
CO <sub>2</sub>	Carbon Dioxide
CO <sub>3</sub> <sup>=</sup>	Carbonate
COC	Contaminant of Concern
CT	Carbon Tetrachloride
DO	Dissolved Oxygen
dtw	Depth to Water
Eh	Electron Potential
EISBD	Enhanced In Situ Biotenitrification
EPA	Environmental Protection Agency
Fe <sup>+2</sup>	Ferrous Irons
Fe(OH) <sub>3</sub>	Iron (III) Hydroxide
ft/day	foot per day
FRTR	Federal Remediation Technologies Roundtable
GPM	Gallons Per Minute
H <sub>2</sub>	Hydrogen
HCO <sub>3</sub> <sup>-</sup>	Bicarbonate
H <sub>2</sub> S	Hydrogen Sulfide
<i>i</i>	Hydraulic Gradient
ISB	<i>In Situ</i> Bioremediation
ITRC	Interstate Technology and Regulatory Council
K	Hydraulic Conductivity
K <sub>d</sub>	Distribution or Partitioning Coefficient
K <sub>OC</sub>	Organic Carbon Partitioning Coefficient
K <sub>OW</sub>	Octanol:Water Partitioning Coefficient
Mn	Manganese
Mn <sup>+2</sup>	Manganese (II)
MnO <sub>2</sub>	Manganese Oxide
MCL	Maximum Contaminant Level
mg/l	milligrams per liter
MNA	Monitored Natural Attenuation
MSDS	Materials Safety Data Sheet
mv	millivolts
<i>n</i>	Porosity
<i>n<sub>e</sub></i>	Effective Porosity
NAPL	Non-Aqueous Phase Liquid
NO <sub>2</sub>	Nitrite
NO <sub>3</sub>	Nitrate

NO <sub>3</sub> -N	Nitrate-Nitrogen
NPL	National Priority List
ORP	Oxidation Reduction Potential
PCE	Perchloroethylene (Tetrachloroethylene/Tetrachloroethene)
RABITT	Reductive Anaerobic Biological <i>In Situ</i> Treatment
R-CL	Chlorinated Organic
RCRA	Resource Conservation and Recovery Act
Redox	Reduction Oxidation
Rf	Retardation Coefficient
RP	Responsible Party
SNL	Sandia National Laboratories
SERDP	Strategic Environmental Research and Development Program
SO <sub>4</sub> <sup>=</sup>	Sulfate
t <sub>1/2</sub>	Half Life
TIO	Technology Innovation Office
TOC	Total Organic Carbon
TCE	Trichloroethylene (Trichloroethene)
VC	Vinyl Chloride
VOC	Volatile Organic Compound

## **APPENDIX B**

### **Carbon Tetrachloride and Degradation Products Selected State Soil Screening Guidelines**

This page intentionally left blank.

## Soil Screening Guidelines and Standards from Selected States

carbon tetrachloride=Carbon Tetrachloride; CF=Chloroform; DCM=Dichloromethane;  
MC=Chloromethane

(Sources referenced by this table are included below.)

Compound	Regulatory Authority	Limit	Date Verified
carbon tetrachloride	EPA Toxicity Characteristic (TC) Rule	0.5 milligrams per liter	4/90
carbon tetrachloride	State of Indiana Soil Default Closure Level	0.066 milligrams per kilogram (mg/kg)	9/00
carbon tetrachloride	State of Iowa Soil Cleanup Criteria	16 mg/kg, based on incidental and ingestion of soil and dust only	10/99
carbon tetrachloride	State of Minnesota Tier 1 Soil Reference Value (SRV) (Working Draft)	0.3 mg/kg	1/99
carbon tetrachloride	State of Missouri Soil Target Concentration	2 mg/kg for Scenario A. 3 mg/kg for Scenario B. 5 mg/kg for Scenario C.	9/01
carbon tetrachloride	State of New Hampshire Soil Standards	6 mg/kg for Category S-1. 12 mg/kg for Category S-2. 12 mg/kg for Category S-3.	1/98
carbon tetrachloride	State of New Jersey Soil Cleanup Criteria	2 mg/kg for residential direct contact. 4 mg/kg for nonresidential direct contact. 1 mg/kg for impact to groundwater.	5/99
carbon tetrachloride	State of New York Soil Standards	0.6 mg/kg to protect groundwater quality. 0.6 mg/kg recommended soil cleanup objective.	1/94
carbon tetrachloride	State of Ohio Generic Soil Cleanup Standards	1.80 mg/kg for residential land use. 15.00 mg/kg for commercial land use. 15.00 mg/kg for industrial land use.	9/97
carbon tetrachloride	State of Oregon Soil Cleanup Standards	0.2 mg/kg	9/97

Compound	Regulatory Authority	Limit	Date Verified
Carbon tetrachloride	State of Kansas, Risk-Based Standards	Soil residential = 2.5 mg/kg. Soil nonresidential = 7.0 mg/kg Soil – groundwater • Residential = 0.2 mg/kg • Nonresidential = 0.2 mg/kg	9/01
CF	EPA TC Rule	6 milligrams per liter	4/90
CF	State of Indiana Soil Default Closure Level	0.59 mg/kg	9/00
CF	State of Iowa Soil Cleanup Criteria	350 mg/kg, based on incidental and ingestion of soil and dust only.	10/99
CF	State of Missouri Soil Target Concentration	0.8 mg/kg for Scenario A. 1 mg/kg for Scenario B. 1 mg/kg for Scenario C.	9/01
CF	State of Minnesota, Tier 1 Soil Reference Value (SRV) (Working Draft)	2.5 mg/kg	1/99
CF	State of New Jersey Soil Cleanup Criteria	19 mg/kg for residential direct contact. 28 mg/kg for nonresidential direct contact. 1 mg/kg for impact to groundwater.	5/99
CF	State of New York Soil Standards	0.3 mg/kg to protect groundwater quality. 0.3 mg/kg recommended soil cleanup objective.	1/94
CF	State of Oregon Soil Cleanup Standards	0.4 mg/kg	9/97
CF	State of Kansas, Risk-Based Standards	Soil residential = 3.9 mg/kg Soil nonresidential = 6.0 mg/kg Soil – groundwater • Residential = 1.2 mg/kg • Nonresidential = 1.2 mg/kg	9/01
DCM	State of Indiana Soil Default Closure Level	0.023 mg/kg	9/00
DCM	State of Iowa Soil Cleanup Criteria	280 mg/kg, based on incidental and ingestion of soil and dust only.	10/99
DCM	State of Minnesota, Tier 1 Soil Reference Value (SRV) (Working Draft)	97 mg/kg	1/99

Compound	Regulatory Authority	Limit	Date Verified
DCM	State of Missouri Soil Target Concentration	51 mg/kg for Scenario A. 71 mg/kg for Scenario B. 150 mg/kg for Scenario C.	9/01
DCM	State of New Hampshire Soil Standards	0.1 mg/kg for Category S-1. 0.1 mg/kg for Category S-2. 0.1 mg/kg for Category S-3.	1/98
DCM	State of New Jersey Soil Cleanup Criteria	49 mg/kg for residential direct contact. 210 mg/kg for nonresidential direct contact. 1 mg/kg for impact to groundwater.	5/99
DCM	State of New York Soil Standards	0.1 mg/kg to protect groundwater quality. 0.1 mg/kg recommended soil cleanup objective.	1/94
DCM	State of North Carolina Cleanup Standard for Hydrocarbon-contaminated Soil	85 mg/kg for residential use. 763 mg/kg for industrial or commercial use. soil-to-water maximum contaminant concentration 0.02 mg/kg.	2/01
DCM	State of Ohio Generic Soil Cleanup Standards	220.00 mg/kg for residential land use. 1,000.00 mg/kg for commercial land use. 1,000.00 mg/kg for industrial land use.	9/97
DCM	State of Oregon Soil Cleanup Standards	0.1 mg/kg	9/97
DCM	State of Kansas, Risk-Based Standards	Soil residential = 150.0 mg/kg Soil nonresidential = 230.0 mg/kg Soil – groundwater • Residential = 0.3 mg/kg • Nonresidential = 0.3 mg/kg	9/01



## **Citation Information for carbon tetrachloride Soil Cleanup Criteria**

- Brownfields Information and Resource Guidebook. The Cuyohoga County Planning Commission and Neighborhood Progress, Inc. September 1997.  
<http://my.en.com/~cpc/brownfields/index.htm>
- Contaminated Sites Risk Characterization and Management Policy. New Hampshire Department of Environmental Services, Waste Management Division. January 1998.  
<http://des.state.nh.us/orcb/rcmp.htm>
- Technical and Administrative Guidance Document 4046. New York State Department of Environmental Conservation. January 1994.  
<http://www.dec.state.ny.us/website/der/tagms/prtg4046.html>
- Soil Cleanup Table (OAR 340-122-045). Oregon Department of Environmental Quality. 1997.  
<http://www.deq.state.or.us/wmc/cleanup/122table.htm>
- Standards for Soil, Iowa Land Recycling Program. Iowa Department of Natural Resources. October 1999. <http://www.state.ia.us/dnr/organiza/wmad/lqbureau/contam/cont2.pdf>
- Soil Cleanup Criteria. New Jersey Department of Environmental Protection. May 1999.  
<http://www.state.nj.us/dep/srp/regs/scc/index.html>
- Regulation of Petroleum Leaking Underground Storage Tanks. Illinois Pollution Control Board. September 1994.  
<http://www.ipcb.state.il.us/Archive/dscgi/ds.py/Get/File-9230/94-002ar091594.PDF>
- Risk Integrated System of Closure (RISC). Default Closure Tables, Appendix 1. Indiana Department of Environmental Management. September 2000.  
[http://www.state.in.us/idem/olq/risc/tech\\_guide/risc\\_app1p01to28.pdf](http://www.state.in.us/idem/olq/risc/tech_guide/risc_app1p01to28.pdf)
- Draft Guidelines: Risk-Based Guidance for the Soil - Human Health Pathway, Volume 2, Technical Support Document, Working Draft. Minnesota Pollution Control Agency, Site Remediation Section. January 1999.  
[http://www.pca.state.mn.us/cleanup/pubs/srv3\\_99.pdf](http://www.pca.state.mn.us/cleanup/pubs/srv3_99.pdf)
- Cleanup Levels for Missouri (CALM). Missouri Department of Natural Resources, Division of Environmental Quality. September 2001. <http://www.dnr.state.mo.us/deq/hwp/calm.htm>
- Contaminated Soil Sediment & Water. Association for Environmental Health and Sciences (AEHS). February 2001.
- Tier 2 Risk-Based Summary Table, Appendix A, Risk-Based Standard, RSK Manual, 2<sup>nd</sup> Version. Kansas Department of Health and Environment. September 4, 2001.

## **APPENDIX C**

**ITRC Contacts, ITRC Fact Sheet, ITRC Product List,  
and User Survey**

This page intentionally left blank.

## **ITRC *In Situ* Bioremediation Team Contacts**

### **Bart Faris, Hydrogeologist, Co-Team Leader**

Assessment and Abatement Section  
Groundwater Quality Bureau  
New Mexico Environment Department  
4131 Montgomery, NE  
Albuquerque, NM 87109  
P: (505) 841-9466  
F: (505) 884-9254  
[bart\\_faris@nmenv.state.nm.us](mailto:bart_faris@nmenv.state.nm.us)

### **Kris Roberts, Co-Team Leader**

Department of Environmental Quality, ND  
1200 Missouri Avenue  
PO Box 5520  
Bismarck, ND 58506  
P: (701) 328-5236  
F: (701) 328-5200  
[kroberts@state.nd.us](mailto:kroberts@state.nd.us)

### **Dr. Eric Nuttall, Professor**

Department of Chemical and Nuclear  
Engineering  
The University of New Mexico  
221 Farris Engineering Center  
Albuquerque, NM 87131-1341  
P: (505) 277-6112  
F: (505) 277-5433  
[nuttall@unm.edu](mailto:nuttall@unm.edu)

### **Dr. Roy Spalding, Professor**

School of Natural Resources  
University of Nebraska-Lincoln  
103 NRH  
Lincoln, NE 68583-0844  
P: (402) 472-8214  
F: (402) 472-9599  
[rspalding@unl.edu](mailto:rspalding@unl.edu)

### **Dr. Ron Buchanan, Jr.**

DuPont Corporate Remediation Group  
Barley Mill Plaza 27  
PO Box 80027  
Wilmington, DE 19880  
P: (302) 992-5972  
F: (302) 892-1533  
[ron.j.buchanan@usa.dupont.com](mailto:ron.j.buchanan@usa.dupont.com)

### **Dr. Jim Shirazi, Soil Scientist, Hydrogeologist**

Water Quality Services Division  
Oklahoma Dept. of Agriculture  
2800 N. Lincoln  
Oklahoma City, OK 73105  
P: (405) 522-6144  
[Gashirazi@aol.com](mailto:Gashirazi@aol.com)

### **Candy McGhee**

Superfund Section  
Hazardous Waste Program  
Missouri Department of Natural Resources  
PO Box 176  
Jefferson City, MO 65102  
P: 573-751-1738  
F: 573-751-7869  
[nrmcghc@mail.dnr.state.mo.us](mailto:nrmcghc@mail.dnr.state.mo.us)

### **Donna Porter, Environmental Geologist**

Remedial Section  
Bureau of Environmental Restoration  
Kansas Department of Environment and  
Health  
1000 SW Jackson Street, Suite 410  
Topeka, KS 66612-1367  
P: (785) 296-1936  
F: (785) 296-7030  
[dporter@kdhe.state.ks.us](mailto:dporter@kdhe.state.ks.us)

**Geoff Cullison**, CNO N453D  
**Environmental Engineer (IR/BRAC)**  
Office of Chief of Naval Operations  
Environmental Protection, Safety, &  
Occupational Health Division  
Crystal Plaza 5, Room 718  
2211 S. Clark Street  
Arlington, VA 22202-3735  
P: (703) 602-5329  
(DSN 332-5329)  
F: (703) 602-2676  
[Cullison.Geoffrey@hq.navy.mil](mailto:Cullison.Geoffrey@hq.navy.mil)

**Bill Guarini**  
VP, Government Programs  
Envirogen, Inc.  
Princeton Research Center  
4100 Quakerbridge Road  
Lawrenceville, NJ 08648  
P: (609) 936-9300  
F: (609) 936-9221  
Voice Mail: (609) 936-1815, ext. 135  
[Guarini@envirogen.com](mailto:Guarini@envirogen.com)

**Dr. Garth James**, Senior Microbiologist  
MSE Technology Applications  
920 Technology Blvd. Ste. B  
Bozeman, MT 59718  
Tel: (406) 586-7869  
Fax: (406) 587-7008  
[Gjames@mse-ta.com](mailto:Gjames@mse-ta.com)

**Linda Fiedler**, Environmental Engineer  
EPA (5102G)  
Technology Innovation Office  
1200 Pennsylvania Avenue, NW  
Washington, DC 20460  
703-603-7194  
703-603-9135 (fax)  
[fiedler.linda@epa.gov](mailto:fiedler.linda@epa.gov)

**Fred McGarry**, PE, DEE  
**Chief Engineer**, Site Remediation Programs  
New Hampshire Department of  
Environmental Services  
P.O. Box 95  
Concord, NH 03302-0095  
P: (603) 271-4978  
F: (603) 271-2456  
[Fmcgarry@des.state.nh.us](mailto:Fmcgarry@des.state.nh.us)

**Steve Hill**, Contract Support  
RegTech, Inc  
HC-87, Box 371  
Pine, ID 83647  
Tel: 208-653-2512  
Fax: 208-653-2511  
Cell: 208-250-4392  
[srhill1@mindspring.com](mailto:srhill1@mindspring.com)

**Mike Meyer**  
Geotek Engineering  
909 E. 50<sup>th</sup> St., North  
Sioux Falls, SD 57104  
P: (605) 335-5512  
[Geotek@ideesign.com](mailto:Geotek@ideesign.com)

**Anne Williams Callison**, President  
Barbour Communications Inc.  
437 S Pontiac Way  
Denver, CO 80224 – 1337  
P: (303) 331-0704  
F: (303) 331-0704 (Hit \*2 while the phone is  
ringing and the fax will pick up)  
[awbarbour@aol.com](mailto:awbarbour@aol.com)

**Dr. Ted Meiggs**  
Foremost Solutions, Inc. 350 Indiana St.  
Suite 415  
Golden, CO 80401  
P: (303) 271-9114  
F: (303) 216-0362  
[tmeiggs@foremostsolutions.com](mailto:tmeiggs@foremostsolutions.com)

**Hassan Vakili**

Virginia Department of Environmental  
Quality  
629 East Main St.  
Richmond, VA 23219  
P: (804) 698-4155  
F: (804) 698-4319  
[hvakili@deq.state.va.us](mailto:hvakili@deq.state.va.us)

**Dr. Dimitrios Vlassopoulos**

S. S. Papodopulos & Assoc., Inc.  
7944 Wisconsin Avenue  
Bethesda, MD 20814-3620  
P: (301) 718-8900  
F: (301) 718-8909  
[dimitri@sspa.com](mailto:dimitri@sspa.com)

**Stephen Hoffine**

Burns & McDonald, Inc.  
9400 Ward Parkway  
Kansas City, MO 64114  
P: (816) 822-3892  
F: (816) 822-3494  
[shoff@burnsmcd.com](mailto:shoff@burnsmcd.com)

**Dr. Jack Adams**

Applied Biosciences  
Post Office Box 520518  
Salt Lake City, UT 84152  
P: (800) 280-7852 ext. 610  
F: (801) 468-1897  
[djadams@bioprocess.com](mailto:djadams@bioprocess.com)

**Bryan Harre**

NAVFAC  
1100 23<sup>rd</sup> Avenue  
Port Hueneme, CA 93043  
P: (805) 982-1795  
F: (808) 982-4304  
[harrebl@nfesc.navy.mil](mailto:harrebl@nfesc.navy.mil)

**Ken Gilland**

Research Triangle Institute  
3040 Cornwallis Road  
Research Triangle Park, NC 27709-2194  
P: (919) 485-2601  
F: (919) 485-7777  
[krge@rti.com](mailto:krge@rti.com)

**Dr. Betty Strietelmeier**

Los Alamos National Laboratories  
Group E-ET  
MS J514  
Los Alamos, NM 87545  
P: (505) 665-4986  
F: (505) 665-4955  
[bastriet@lanl.gov](mailto:bastriet@lanl.gov)

**Clay Trumpolt**

Colorado Department of Public Health and  
Environment  
4300 Cherry Creek Drive South  
Denver, CO 80246  
P: (303) 692-3461  
F: (303) 759-5355  
[clayton.trumpolt@state.co.us](mailto:clayton.trumpolt@state.co.us)

