

BUILDING PARTNER CAPACITY/ SECURITY FORCE ASSISTANCE: A NEW STRUCTURAL PARADIGM

BY

COLONEL SCOTT G. WUESTNER
United States Army

DISTRIBUTION STATEMENT A:

Approved for Public Release.
Distribution is Unlimited.

USAWC CLASS OF 2008

This SRP is submitted in partial fulfillment of the requirements of the Master of Strategic Studies Degree. The views expressed in this student academic research paper are those of the author and do not reflect the official policy or position of the Department of the Army, Department of Defense, or the U.S. Government.



U.S. Army War College, Carlisle Barracks, PA 17013-5050

Report Documentation Page

Form Approved
OMB No. 0704-0188

Public reporting burden for the collection of information is estimated to average 1 hour per response, including the time for reviewing instructions, searching existing data sources, gathering and maintaining the data needed, and completing and reviewing the collection of information. Send comments regarding this burden estimate or any other aspect of this collection of information, including suggestions for reducing this burden, to Washington Headquarters Services, Directorate for Information Operations and Reports, 1215 Jefferson Davis Highway, Suite 1204, Arlington VA 22202-4302. Respondents should be aware that notwithstanding any other provision of law, no person shall be subject to a penalty for failing to comply with a collection of information if it does not display a currently valid OMB control number.

1. REPORT DATE 15 MAR 2008	2. REPORT TYPE Strategy Research Project	3. DATES COVERED 00-00-2007 to 00-00-2008			
4. TITLE AND SUBTITLE Building Partner Capacity/Security Force Assistance: A New Structural Paradigm		5a. CONTRACT NUMBER			
		5b. GRANT NUMBER			
		5c. PROGRAM ELEMENT NUMBER			
6. AUTHOR(S) Scott Wuestner		5d. PROJECT NUMBER			
		5e. TASK NUMBER			
		5f. WORK UNIT NUMBER			
7. PERFORMING ORGANIZATION NAME(S) AND ADDRESS(ES) U.S. Army War College ,122 Forbes Ave.,Carlisle,PA,17013-5220		8. PERFORMING ORGANIZATION REPORT NUMBER			
9. SPONSORING/MONITORING AGENCY NAME(S) AND ADDRESS(ES)		10. SPONSOR/MONITOR'S ACRONYM(S)			
		11. SPONSOR/MONITOR'S REPORT NUMBER(S)			
12. DISTRIBUTION/AVAILABILITY STATEMENT Approved for public release; distribution unlimited					
13. SUPPLEMENTARY NOTES					
14. ABSTRACT see attached					
15. SUBJECT TERMS					
16. SECURITY CLASSIFICATION OF:			17. LIMITATION OF ABSTRACT Same as Report (SAR)	18. NUMBER OF PAGES 70	19a. NAME OF RESPONSIBLE PERSON
a. REPORT unclassified	b. ABSTRACT unclassified	c. THIS PAGE unclassified			

The U.S. Army War College is accredited by the Commission on Higher Education of the Middle State Association of Colleges and Schools, 3624 Market Street, Philadelphia, PA 19104, (215) 662-5606. The Commission on Higher Education is an institutional accrediting agency recognized by the U.S. Secretary of Education and the Council for Higher Education Accreditation.

USAWC STRATEGY RESEARCH PROJECT

**BUILDING PARTNER CAPACITY/SECURITY FORCE ASSISTANCE:
A NEW STRUCTURAL PARADIGM**

by

Colonel Scott G. Wuestner
United States Army

Dr. Douglas Johnson
Project Adviser

This SRP is submitted in partial fulfillment of the requirements of the Master of Strategic Studies Degree. The U.S. Army War College is accredited by the Commission on Higher Education of the Middle States Association of Colleges and Schools, 3624 Market Street, Philadelphia, PA 19104, (215) 662-5606. The Commission on Higher Education is an institutional accrediting agency recognized by the U.S. Secretary of Education and the Council for Higher Education Accreditation.

The views expressed in this student academic research paper are those of the author and do not reflect the official policy or position of the Department of the Army, Department of Defense, or the U.S. Government.

U.S. Army War College
CARLISLE BARRACKS, PENNSYLVANIA 17013

ABSTRACT

AUTHOR: Colonel Scott G. Wuestner

TITLE: Building Partner Capacity/Security Force Assistance: A New Structural Paradigm

FORMAT: Strategy Research Project

DATE: 25 March 2008 **WORD COUNT:** 11,186 **PAGES:** 70

KEY TERMS: Building Partner Capacity, Security Force Assistance, Theater Security Cooperation, TMAAG, Regional Ministry Teams

CLASSIFICATION: Unclassified

This paper examines the current Building Partner Capacity and Security Force Assistance capabilities and capacities within the United States Army as well as Department of Defense. The current operational environment calls for us to look at history, policy, doctrine and other academic proposals to identify capability and capacity gaps. As the General Purpose Force looks forward to expanding roles in Irregular Warfare, Foreign Internal Defense and Security Assistance, does the U.S. Army have the proper force structure and minimal capability to fight and win the counterinsurgency of the future? This paper analyzes this construct and provides a framework for identifying proponentcy, institutionalizing lessons learned from OIF and OEF as well as providing military, police and governance structure as a tool for global engagement. This new structural paradigm will help the United States gain access, influence and build capacity throughout this new world order.

BUILDING PARTNER CAPACITY/SECURITY FORCE ASSISTANCE: A NEW STRUCTURAL PARADIGM

Until our government decides to plus up our civilian agencies like the Agency for International Development, Army Soldiers can expect to be tasked with...standing up and mentoring indigenous forces...reviving public services, rebuilding infrastructure, and promoting good governance. All these so-called “nontraditional capabilities” have moved into the mainstream of military thinking, planning and strategy – where they must stay.¹

The United States Army is at a significant crossroads as it defines its roles, missions and force structure for future operations. The Army began reorganizing in 2003 to a brigade-based full-spectrum force called the Modular Brigade Combat Team (BCT). This reorganization stemmed from a requirement to become more flexible and adaptive and provide a larger pool of forces available for both conflicts in Iraq and Afghanistan. In response, “the Department of Defense (DOD) and the Army initiated significant changes in doctrine, education, and training, focusing on counterinsurgency, stabilization, and training/advising foreign militaries.”² Secretary Gates has challenged the Army to prepare for asymmetric warfare, partner capacity building as well as Stability, Security, Transition, and Reconstruction³ (SSTR) operations. What has lagged behind these initiatives is a commensurate degree of force structure change to meet our future requirements.

According to the Army’s 2006 Posture Statement,

the Army is required to be able to conduct joint, multinational operations anywhere across the spectrum of operations. This spectrum ranges from the low end – emphasizing stability and civil support operations – to high end – emphasizing major combat operations.⁴

The impetus to accomplish these missions is the new Modular Brigade Combat Team (BCT). The configuration will be “more flexible to deal with irregular, catastrophic, and disruptive challenges as well as traditional warfare.”⁵

The question then remains. Can the Army, as a full-spectrum, rotational, and expeditionary force, meet its Partner Capacity Building (PCB) mission from Phase 0 (Shaping Operations) through Phase 4 (Stability Operations) without additional force structure? The Army faces a gap in its ability to meet the Combatant Commanders’ daily operational requirements regarding Theater Security Cooperation (TSC), military engagement, and PCB. This gap is widening as the Army believes it is in a period of “persistent conflict”. However, others believe that even without the current Global War on Terror (GWOT), the Army must shift from its paradigm (full-spectrum capable) and create organizations that can meet both Shaping Operations and Stability Operations.⁶ This paper examines the changes to our current operational environment to include our long history in U.S. Security Force Assistance (SFA), the current requirements for PCB and its relationship with SSTR and other proposals, the doctrinal construct for PCB and the current capability gaps. This paper also addresses other options for the creation of specialized units such as Theater Military Advisory and Assistance Groups (TMAAGs) as well as National and Theater Reconstruction Teams (NRTs-TRTs). The development and incorporation of these new units will enable the Army to meet its full-spectrum requirements creating new tools that can enhance our TSC-PCB strategies as well as stabilization and advisory missions.

Changes to the Environment

Since the end of the bi-polar confrontation with the Soviet Union, the United States has faced a varied and unstable world. The emergence of non-state actors in failed nations or ungoverned spaces has increased the risk from transnational terrorists seeking to harm the United States. These terrorists seek to operate asymmetrically, using tools of insurgency and irregular warfare to avoid U.S. conventional strength:

This type of warfare has been historically disadvantageous to the U.S.; it is expensive, protracted, creates persistent casualties, and provides the terrorist a strategic psychological advantage against an impatient U.S. general population.⁷

Additionally, this asymmetric threat has challenged our Soldiers to execute many additional and varied tasks. Soldiers are required to become:

nation builders as well as warriors, they must be prepared to help reestablish institutions and local security forces and assist in rebuilding infrastructure and basic services ...performing these tasks involves extensive coordination and cooperation.⁸

Historical U.S. Security Force Assistance

This is not the first time in our nation's history that we have been called to perform these tasks (See Figure 1). The U.S. Army has been involved with nation building, advising or training indigenous forces for most of its history. Most of these tasks were associated with counterinsurgency operations. During the Philippine War in 1899, the US Army was heavily involved with training and advising the Philippine Scouts to combat an insurgency. The United States executed President McKinley's "Benevolent Assimilation" policy. This policy was founded on protecting the populace while executing civil projects. The policy focused on infrastructure improvements as well as establishing police, schools and local governance. The Army was trained and

ready to execute this mission as it drew from experiences in the Civil and Indian Wars. Additionally, the combination of regular and volunteer forces provided the Army the appropriate skill sets to accomplish the benevolence policy as well as pacification requirements.⁹

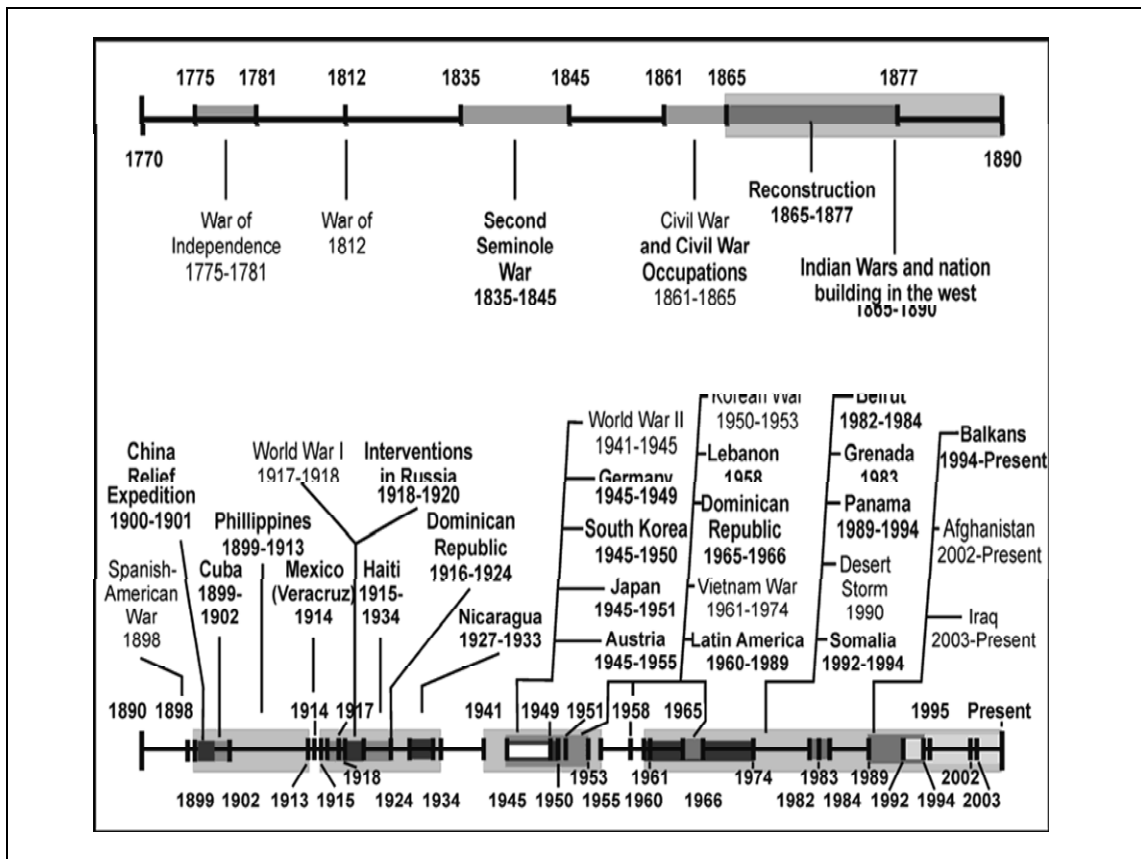

Figure 1: Historical U.S. Security Force Assistance¹⁰

During World War II, the U.S. Army conducted large scale training and advisory missions with the Chinese and French North African forces. After the landings in North Africa, some 500 US Army advisors retrained over 260,000 French troops in eight divisions for combat in Italy and France. By late 1944, 4,800 dedicated US Army advisors were with 30 divisions of the Nationalist Chinese forces. General Albert C. Wedemeyer believed that retaining these advisors after 1945 could have saved China.¹¹

After World War II, U.S. Army advisors served around the world most significantly in Greece, Turkey, Korea, and South Vietnam as part of Military Advisory Groups (MAGs). With less than 300 advisors by 1953, KMAG in Korea successfully reorganized the Republic of Korea Army of over 20 divisions into an effective combat force.¹²

Unfortunately, in Vietnam, the Army ignored the insights from its past. Initial attempts to change counterinsurgency tactics and procedures failed due to a “very strong organizational culture predisposed to a conventional attrition-based doctrine.”¹³ Roger Hilsman, an aide and advisor to President John F. Kennedy, whose views on counterinsurgency were formed as a member of Merrill’s Marauders in World War II gave a speech on 10 August 1961. He decried that “traditionalists believe that well-trained regulars can do anything...for effective counterinsurgency operations we need radical changes in organization, combat doctrine, and equipment.”¹⁴ Fortunately, changes were made.

The CIA developed a program called the Civilian Irregular Defense Group (CIDG). This concept focused on pacification and oil spot security especially in the Darlac Province.¹⁵ They were successful until the CIDG transferred to the Military Assistance Command – Vietnam (MACV) in 1963 due to a report that the Special Forces Advisors were being used improperly.¹⁶ Their focus changed from population security and pacification to offensive operations with the Army of Vietnam.

Unfortunately, this tactic did not work and in 1966, prompted Secretary of Defense Robert McNamara to state that military solutions alone will not win the war. Despite great debate, little effort was given to political military efforts to defeat the insurgency.

Robert Komer commented that there was no organization within the U.S. government trained and equipped to perform this political and economic mission. “It’s the great difficulty of getting things done by the bureaucracy, especially when you’re confronted with an exceedingly atypical situation which requires exceedingly atypical responses.”¹⁷

Komer was instrumental in helping to create the Civil Operations and Revolutionary Development Support organization called CORDS. “CORDS were a dramatic change from business as usual, incorporating personnel from the CIA, USIA, AID, the State Department and military services.”¹⁸ He knew that military support was key to the CORDS success and they directed “unified civil-military advisory teams in all 250 districts and 44 provinces.”¹⁹ By the time troops were pulled out, the CORDS program helped pacify most of the hamlets in South Vietnam. In the end, the MACV employed over 14,000 U.S. Army field advisors at its peak in 1970 including 1,800 Special Forces (SOF) advisors.²⁰

After Vietnam, this advisory role and the broader mission of Foreign Internal Defense (FID) belonged almost exclusively to SOF. Modest operations were successfully conducted in Central and South America (especially in El Salvador), and more recently in the Balkans and Philippines. Since 9/11 the requirement to conduct large military advisory missions in Afghanistan, Iraq, and elsewhere as part of the Global War on Terror has expanded beyond the capacity of SOF alone.

Unfortunately, organizations such as the CORDS were disbanded and other US agencies reduced as part of peace dividends. Today, the United States Agency for International Development (USAID) consists of just 1,000 Foreign Service Officers (FSOs), 1,000-plus government service employees, and about 6,000 service contract

and foreign nationals.²¹ The Department of State is also at an all time low with just over 6,000 FSOs as well, while the requirements of Iraq and Afghanistan virtually mirror those of Vietnam. As COL H.R. McMaster notes:

Afghanistan, Iraq and Lebanon reveal the need for balanced joint capabilities and additional capacity in other agencies to assist in post conflict stability and counter-insurgency operations. At the operational level, forces must be capable of conducting counter-insurgency, stability or state-building operations.²²

Current Requirements for Stability Operations

Despite the ad-hoc nature of these historic endeavors, U.S. Army advisors succeeded in providing an integrated program of pacification, civic action and economic development through each of these conflicts. Despite that record, the military continues to ignore the lessons of the past. The Army has created ad-hoc war time SSTR capabilities with no real joint or interagency backbone or lasting capability. These efforts have focused solely on post-conflict operations with no thought of expanding our tools of preemption. Currently, no one agency executes operational control of U.S. soft and hard power Stability Operations capabilities. The United States ability to project civilian instruments of national power such as diplomacy, foreign assistance, economic reconstruction and development as well as rule of law is underfunded and underdeveloped. As Secretary Gates pointed out:

I remain concerned that we have yet to create any permanent capability or institution to rapidly create and deploy these kinds of skills in the future,we need to develop a permanent sizeable cadre of immediately deployable experts with disparate skills.²³

Secretary Gates emphasizes the way to institutionalize these capabilities is probably not to recreate or repopulate institutions such as USAIA or USAID, or to the development of elements in the Departments of Agriculture, Treasury, Commerce or

Justice that would be deployable overseas but “new institutions are needed for the 21st century, new organizations with a 21st century mind-set.”²⁴

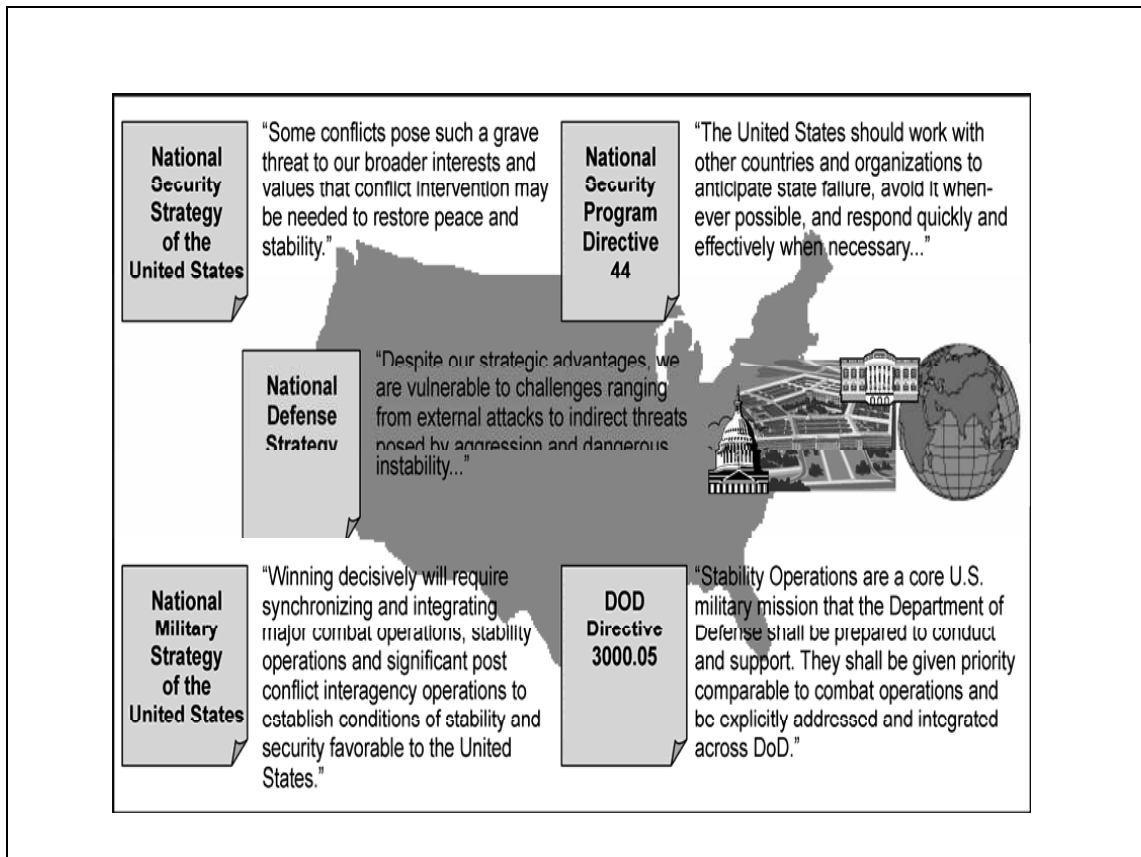

Figure 2: National Security References for Stability Operations²⁵

Figure 2 clearly lays out the national security requirements for Stability Operations. National Security Presidential Directive 44 (NSPD44) - Management of Interagency Efforts Concerning Reconstruction and Stabilization states:

The U.S. will work to anticipate state failure, avoid it wherever possible, and respond quickly and effectively when necessary and appropriate to promote peace, security, development, democratic processes, market economies and the rule of law.²⁶

In response, with the publication of DODD 3000.05 (Military support for SSTR operations), the Department of Defense announced Stability Operations would become

a core U.S. military mission. Additionally, the 2006 Quadrennial Defense Review articulated the concept of Stability Operations and Partner Capacity Building – which includes enhancing TSC activities – as an important element for future national security. Specifically PCB is to enhance the capabilities of, and cooperation with our international partners. Another internal objective is to improve interagency planning and operational procedures.

In response to NSPD 44, the Secretary of State is required to:

Coordinate and lead integrated United States Government efforts, involving all U.S. Agencies with relevant capabilities, to prepare, plan for, and conduct stabilization and reconstruction activities. The Secretary of State shall coordinate such efforts with the Secretary of Defense to ensure harmonization with any planned or ongoing U.S. military operations across the spectrum of conflict.²⁷

Through NSPD 44, the Civilian Stabilization Initiative, a modern day version of the CORDS was born. Through this initiative, the State Department created the Coordinator for Reconstruction and Stabilization (S/CRS) with a mission to build a U.S. Government Civilian Response Capability to support Stabilization and Reconstruction (R&S) operations.

The S/CRS developed the following core issues with reconstruction and stabilization and focused on finding a solution to each unique set of problems:²⁸

- Lack of common planning approach, assessment tools and reliable measures of progress
- No unified operating system to ensure command and control.
- Limited civilian capacity to manage and implement R&S response
- Gap in specialized training and preparation for civilians deploying quickly to conflict and unstable environments.

- No common repository for capturing and applying lessons learned and best practices.
- Critical shortage of rapid, flexible funding for non-humanitarian activities -- constrains effective allocation and management of R&S resources; slows rate of U.S. civilian deployments.

In response, the S/CRS created three organizations.²⁹ The nucleus of the new organization is the Active Response Corps (ARC). It will include 250 active responders from State, USAID, Justice, Commerce, Agriculture, Health and Human Services, Department of Homeland Security, and Treasury. The United States Government staff is trained and ready to deploy within 72 hours of an announcement of an U.S. military operation. The team will assess the situation, design a response and begin R&S implementation. The team also has the capability to deploy up to a year.

The second group is roughly a 2,000-strong Standby Response Corps (SRC) pulled from the same demographics as the ARC. The SRC would train for two to three weeks a year and is the second element to deploy. It deploys within 45 to 60 days up to 180 days a rotation.

The third element is the Civilian Reserve Corps (CRC) consisting of 2,000 personnel. It will consist of experts drawn from jobs outside the federal government. The CRC would become United States Government employees when mobilized and are fully trained and deployable in 30-60 days for up to one year. They will provide sector-specific civilian response expertise and maintain a four year service obligation. This is the type of organization the Secretary Gates has advocated. The 2009 budget is

seeking \$249 million for the program but as Gates points out “arguing for more funds for another agency is considered blasphemy.”³⁰

Army Force Requirements for Stability Operations

Now that the S/CRS has an organizational construct for Reconstruction and Stabilization Operations, what has the Army done to train, man, and equip General Purpose Forces (GPF) to conduct Stability Operations as well as TSC tasks? To date the Army has developed temporary ad-hoc Transition Teams (TT) and Provincial Reconstruction Teams (PRTs). Additionally, the Army added permanent force structure for Human Terrain Teams (HTT)³¹ as well as Red Teams.³² There has also been a shift in Cold War structure to form more modular contemporary capabilities such as adding MI, MP and Engineer companies. However, these “new” units are not specifically designed for counterinsurgency, stabilization, training and advisory missions, but instead are full-spectrum capable units.³³ These initiatives combined with the increase of over 1,300 Civil Affairs personnel in the Army will form the same capabilities as those found in the CORDS.³⁴ What is misleading is that approximately 400 of these Civil Affairs (CA) personnel are active duty and only support special operations. None of these personnel belong to permanent organizations with specified missions and tasks. TRADOC has also responded to the requirements for increased foreign language knowledge as well as cultural understanding. TRADOC has developed “the TRADOC Cultural Center (TCC), expanded the Defense Language Institute Foreign Language Center (DLIFLC) operations and has developed the University of Foreign Military and Cultural Studies (UFMCS).”³⁵ All are important first steps but how do we operationalize language and cultural understanding and make it an enduring capability?

Secretary Gates again argues “the most important military component in the War on Terror is not the fighting we do ourselves, but how well we enable and empower our partners to defend and govern their own countries.”³⁶ This statement identifies the central theme of this paper. Unfortunately, neither our historical experiences nor national directives have focused the Army to organize to meet these current and enduring challenges. FM 3-24 (Army and Marine Corps Counterinsurgency Field Manual) and the Draft FM 3-07 (Stability Operations) fail to discuss the requirements for specialized and dedicated stability or support units. Instead, the doctrine recommends that unit’s task organize forces to meet individual mission requirements. Task organization occurs all the time within the Army and the Joint Force. However, these forces are not ad-hoc organizations. They are units with Tables of Organization and Equipment (TOE) designed to accomplish specific missions. Yet, the Army does not possess even the minimum required experts to accomplish stabilization or advisory missions.

To further amplify the shortfalls, the Irregular Warfare Joint Operating Concept (IWJOC) calls on the GPF to do more. The relationship between Irregular Warfare (IW), SSTR and Major Combat Operations (MCO) is complex at best and requires multiple capabilities (See Figure 3). Specific GPF requirements for IW include three key tasks:³⁷

- Build surrogate and partner nation security force capacity on a global scale.
- Provide interim military government or perform civil administration functions.
- Expand the role of the US Military Group (MILGRP) to support IW.

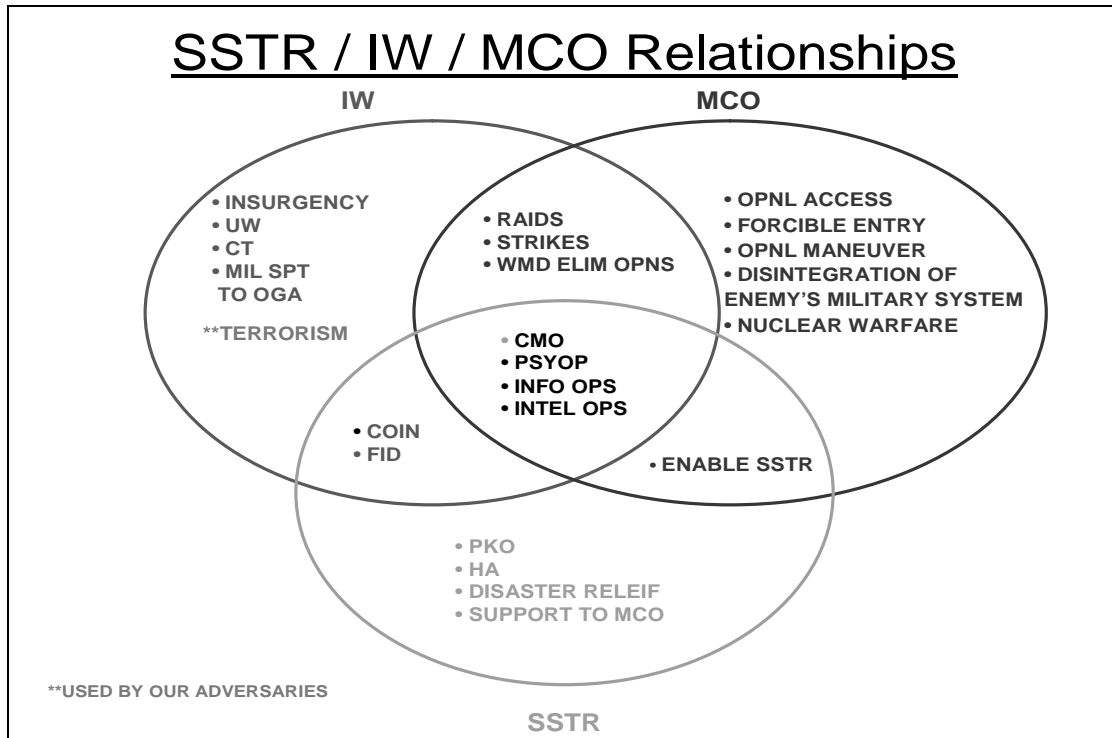

Figure 3: JOC Relationships³⁸

In spite of these growing specialized requirements, the Army has argued against “specialized forces” to conduct Stability Operations. In accordance with the Army Position Paper on Force Structure for Stability Operations,

operational experience supports the Army’s view that a combined-arms modular force, fully trained to conduct full-spectrum operations, is more effective in current environment and more flexible to meet the range of joint force requirements under realistic, fiscal and end-strength restrictions.³⁹

The Army conducted modeling over a seven year period that compared two different force structure configurations to attempt to validate its position. One was a BCT-based modular force and the second was a force that contained a mix of approximately 60% SO specialized forces and 40% BCT modular forces. “The pure BCT modular structure was capable of executing 93% of its total mission load (including SO) and 100% of its Major Combat Operations (MCO) requirement. The

BCT/specialized mix was capable of executing 68% of its total mission load (including SO) and only 20% of its MCO requirement.”⁴⁰ Critics argue this mix is unrealistic and that the all or nothing approach is fundamentally flawed.

Other Proposals for Specialized Units

Historically, Special Forces were the only units to provide regionally –oriented Soldiers with language skills capable of executing Foreign Internal Defense (FID), host nation Internal Defense and Development (IDAD) programs and training of indigenous forces.⁴¹ That paradigm has shifted. Currently, Army and Marine SOF units seek only to train other foreign SF units leaving the GPF to execute basic and advanced individual skills.⁴² Additionally, there have been proposals to create specialized units to deal exclusively with stabilization, security, and reconstructions operations as well as peace keeping and enforcement operations.

Stabilization Units

In May of 2005, the House Armed Services Committee (HASC) requested that the Congressional Budget Office (CBO) publish a study on how to increase the Army’s ability to do stability type missions and decrease the reliance on the Reserve Component. One of the options was to establish R&S Divisions.

CBO’s option was to eliminate one heavy and one light division from our current force structure, each with 3 Brigade Combat Teams (BCTs) and supporting units. These resources would then create five R&S Divisions – four in the active component and one in the reserves. Each R&S division would include MPs, engineers, medical, civil affairs, and psychological operations units as well as a Stryker BCT.⁴³ These

designs according to the CBO “could save \$18 billion in operational and support costs through 2022, and 1 billion annually thereafter.”⁴⁴ The Army counters this position by arguing it would reduce the Army’s ability to fight and win our nations wars. Again, central to this argument is the Army’s belief that we must continue to focus on MCO as a priority versus restructuring for COIN. Secretary Gates has stated “asymmetric warfare will be the mainstay of the contemporary battlefield for some time. These conflicts will be fundamentally political in nature, and require the application of all elements of national power.”⁴⁵

Another CBO proposal was to integrate stabilization force packages into BCTs or create multi-functional stabilization battalion task forces. Units would consist of a mix of combat and support elements that could execute both security as well as infrastructure repair at the local level. A counter argument against this concept was that advisory and assistance tasks are normally senior officer and non-commissioned officer heavy. The question becomes what do you do with the other 3-400 young enlisted soldiers?

In December 2006, Andrew Krepinevich produced a study looking at eight possible scenarios for future Stability Operations.⁴⁶ They included:

- Large State Failure – Indonesia or Nigeria.
- Nuclear State Failure – Pakistan.
- Ambiguous Aggression – Kenya.
- Pandemic – Mexico.
- Global Commerce Raiding.
- Narco Trafficking – Colombia.
- Great Power Proxy War – Central Asia.

- Creating Positions of Strength – Afghanistan.

Based on these possible future conflicts, Krepinevich developed recommendations to address requirements for stability operations as well as training and advisory units. His world view believes there is a lack of peer or near-peer adversary and presents IW and COIN as a low-risk opportunity to designate these types of warfare as our primary mission. As such, they then should be given the appropriate force structure to function in that role. His organizational vision included:

- Forward Liaison and Assistance Groups (FLAGs): SSTR-optimized brigades to conduct “ink spot” stabilization operations – 45 brigades (27 Active Component, 3 USMC, 15 National Guard).
- Military Assistance Advisory Groups (MAAGs): Headquarters with additional economic and political staff; 2/3 command; 300 – 3,000 troops.
- Security Training and Equipping Groups (STEGs): 1/2 command; 2,000-3,000 troops. Their mission is to train and equip military and police forces, and ministries. This is described as Multi-National Security Transition Command - Iraq (MNSTC-I) in a box.
- Civil Operations, Reconstruction, and Development Support Groups (CORDSGs): 1/2 command; 4,000-5,000 troops. Their mission is to advise, mentor and support to non-security structures such as civil administration, rule of law, health, and economic development.

Again, the Army’s position is similar to the R&S divisions. The commitment of almost all of the Army’s combat power to R&S tasks is not prudent.

On 21 February 2008, the G-35-SSO Internal Study on Army Civil Affairs in Full Spectrum Operations produced some stunning analysis on the way ahead for CA in Stability Operations. Army CA realized it “lacks the capability and capacity to support the Army through all phases of Full Spectrum Operations in a Joint, Interagency and Multinational (JIM) environment.”⁴⁷ They seek to transform SO from the strategic level down to the tactical level. They see the current conditions facing CA in the following context:

- Era of Persistent Conflict:
 - Operations among the people
 - Unpredictable, asymmetric threats
 - Must operate across all phases of the war (Phase 0 through Phase
 - Integrate operations within the five Civil Sectors
 - Applicable capabilities from Military Strategic National level through tactical level
- Whole of Government Approach
 - Integrating Military-Civilian Teams
 - A pervasive information environment
 - Leading to Conflict resolution
- Evolving Policies
- Evolving Doctrine
 - Simultaneous or sequential offense, defense, and stability operations, Army, Joint, U.S. Government

Figure 4 below, shows the overall relationship of USG requirements and CA means to meet those ends. The design provides for the integration of Reserve Component Soldiers with unique skills and integrating them into an interagency approach. It provides scalable capabilities based on the security situation and/or conditions-based intervention. The concept provides for quick deploying/modular formations while maximizing the power of information in operations. It also allows the US to offer “best practices” to Indigenous Government and Host Nation leadership.⁴⁸

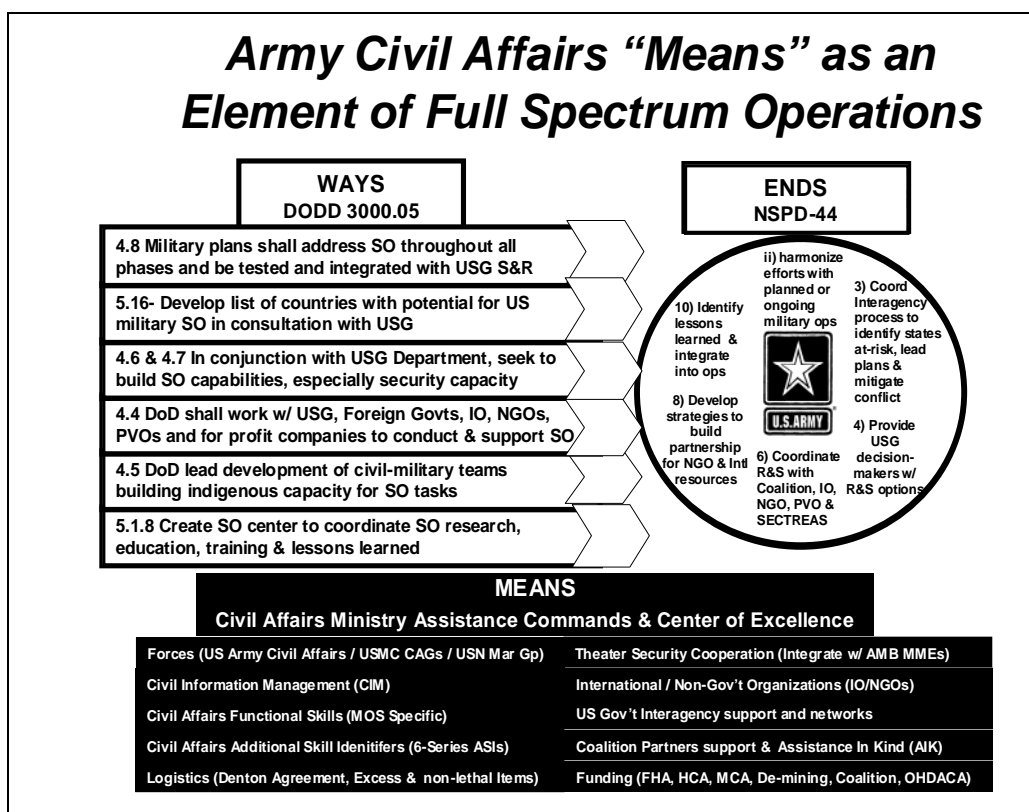

Figure 4: Civil Affairs “Means” as an element of Full Spectrum Operations⁴⁹

The design (Figure 5) change calls for realistic restructuring to make Army Civil Affairs viable again at all levels of policy, strategy and execution. That includes adding additional personnel to commands at the strategic as well as operational levels. The operational concept focuses on deployable teams that possess various tailorable

and advise military and police forces from the Ministry level down to battalions. This concept is based on the future requirements for both OIF and OEF as well as for future COIN fights. Currently, the Army uses an ad-hoc structure of senior NCOs and Officers to manage these tasks. The Army stood down the 1st Infantry Division at Fort Riley as well as two brigades and developed the training program to train senior NCOs and Officers for this mission. An inefficient use of combat power but the only real option the Army had at that time.

Major General (MG) Anthony Cuculo, the Chief of Army Public Affairs, reportedly rejected the notion of a permanent advisory corps noting the capabilities would be provided by an advisory corps are already being provided by Special Forces.⁵¹

Lieutenant General (LTG) Peter Chiarelli stated, “The Special Forces do this mission well on the scale that is normally required for TSC and other routine foreign internal defense missions.”⁵² Yet, the IW JOC clearly articulates that GPF will build surrogate and partner nation security force capacity on a global scale. This task far exceeds Special Forces capability even with the addition of Special Forces battalions that is currently proposed. Secretary Gates emphasizes “the standing up and mentoring of indigenous army and police – once the province of Special Forces – is now a key mission for the military as a whole.”⁵³

In spite of the confusion and unified understanding of roles and missions among senior leaders, the Chief of Staff of the Army, General George Casey directed Training and Doctrine Command (TRADOC) to identify shortfalls regarding TSC, military engagement as well as PBC in our Combatant Commands. The intent of the study was to develop an operational concept and range of organization designs to meet those

gaps. It appears that the Army elevated the requirement for the training and advisory mission to a core task just as DOD Directive 3000.5 elevated the stability mission to a core Army mission.

In response, the Army created the Theater Military Advisory Assistance Group – Forward (TMAAG-F) (Figure 6 and 7). The TMAAG-F is designed to provide TSC activities during the period of Shaping Operations (Phase 0) and would not be a crisis response force.⁵⁴

It would contribute to the theater-wide security cooperation activities of the U.S. embassy-based MILGROUPS⁵⁵ by providing a standing structure to execute specific TSC tasks, as tasked by the Geographic Combatant Commander (GCC) and Theater Army/Army Service Component Command (ASCC)...The TMAAG-F would consist of a small organic administrative headquarters with assigned training teams and focus on the Host Nations' land forces at the brigade and below level.⁵⁶

As noted below, each GCC would have three Training Teams (TTs) of 22 personnel each to use in theater. The organization contains no operational or strategic structure nor does it provide a proponent office for TRADOC or the Army to improve overall efficiencies and manage costs.

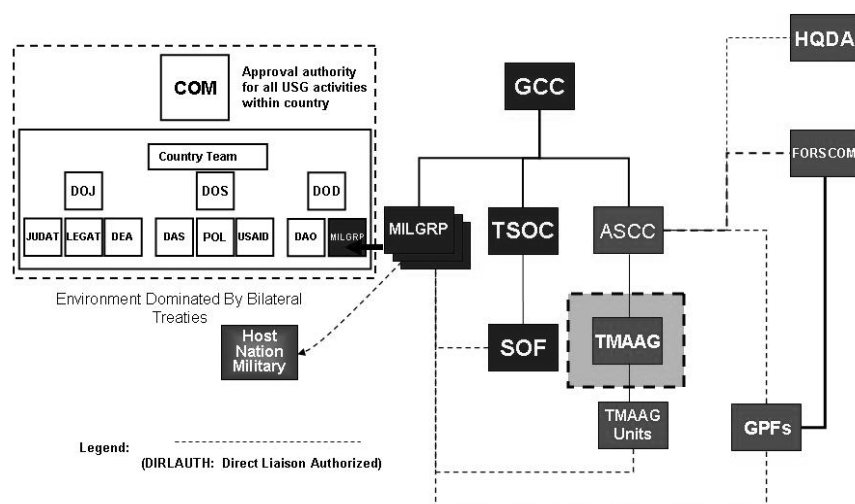

Figure 6: Proposed Army TMAAG Location within TSC Structure⁵⁷

Specifically, this design does not provide a single entity charged with keeping our doctrine, organizational design, training, material development, leader development, personnel policies, and facility design (DOTLM-PF).

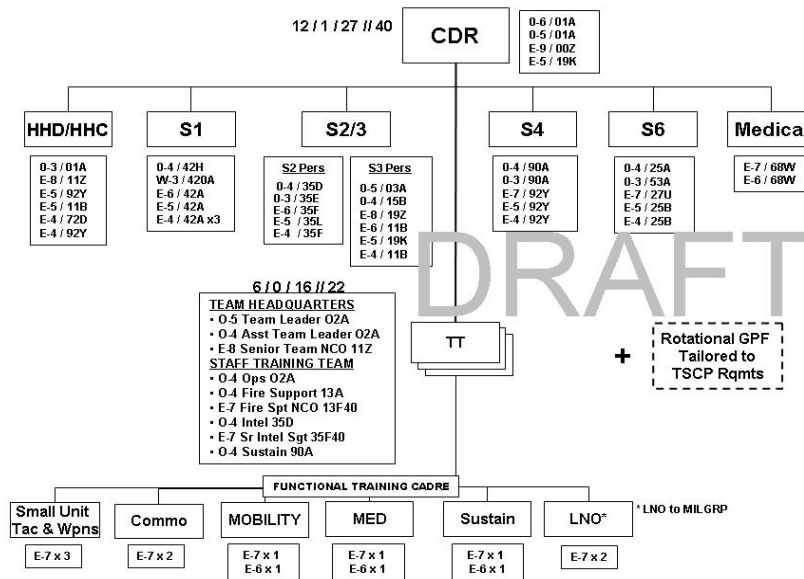

Figure 7: Proposed TMAAG-F Organizational Design⁵⁸

Additionally, the design fails to address the requirements directed in DOD 3000.5 for Stability Operations and as identified by the Army's G-35-SSO's internal study. This includes the requirements for Police Trainers (PTs) as well as Governance Advisors. The Army also states the TMAAG is just like a Special Forces Operational Detachment Alpha (ODA) team. This is far from the truth. The TMAAG, as part of the GPF, is a focused specialty that enables Soldiers to go back and forth from the Global Force pool. The cultural understanding, relationships and operational experience is an incredible combat multiplier for our GPF in future TSC operations as well as SO.

Another option the Army is considering is expanding MILGRPs. This is a great idea and should be part of the overall relook of our engagement strategy. However, MILGRP expansion alone without some form of TMAAG is short sighted. MILGRPs do not offer the GCC with any additional flexible deterrent options. MILGRPs are located in specific countries in which the U.S. has normalized relations. They are normally not located in failed or failing states. These are the exact countries the USG is targeting through a comprehensive TSC and engagement strategy. The TMAAGs and Regional Ministry Teams can surge in accordance with either DoD, DoS or GCC guidance on a selected country and develop partner capacity.

The TMAAG and governance advisors are complementary efforts to both ODA and MILGRP efforts. Unfortunately, on 22 March 2008, HQDA made a decision that the TMAAG, as designed, is not an Army requirement (at least not at this point).⁵⁹

The CSA believes our forces are the best trainers in the world and explored the possibility that another alternative approach to building partnership capacity could be accomplished by using the Army Force Generation (ARFORGEN) process through the assignment and focus of a brigade combat team. However, he also indicated that he recognized the skills associated with working with indigenous forces and how that would be good for the conventional army.⁶⁰

Unfortunately, the problem with aligning BCTs according to geographical regions faces the same challenges as the “full-spectrum” argument. The Army is in a period of persistent conflict. It relies on the ARFORGEN model to provide the right forces, with the right training, at the right time. The lack of trained senior advisor cadre with cultural understanding and language capability will be ad-hoc at best. Also this fails to take into account the current mission overload and “jack of all trades” mentality.

The Marines have addressed the future in their Long War strategy. Their strategy clearly identifies the requirement for “new capabilities” such as the Security-

Cooperation Marine Air Ground Task Force (SC-MAGTF). The SC-MAGTF is designed as a Marine Expeditionary Unit but task organized for security cooperation and civil military operations.⁶¹ They will focus on building partner nation security capacity and supporting partner nation security efforts. This is no different than aligning BCTs within the ARFORGEN model on specific Areas of Responsibility (AORs). What is different is the development of Marine Corps Advisors. The Marines, through experiences in Iraq and Afghanistan, have realized there is a requirement for a more robust SFA capability. In October of 2007, the Marine Corps Training and Advisory Group (MCTAG) was commissioned by the Commandant.⁶² The Advisors will receive special training and will interface with partner nations assisting SC-MAGTFs and U.S. country teams and attaches. The teams will train with SC-MAGTFs. SC-MAGTFs will also include assignment of Foreign Area Officers (FAOs), Regional Affairs Officers (RFOs), linguists as well as Officers and NCOs with academic backgrounds in specific regions.⁶³

Although the Army has far superior resources to execute this mission, the Marines understand the importance of engagement and what it means to our foreign policy. The Marine concept still lacks the incorporation of police and foreign governance training, it does recognize the need for permanent advisors to meet the new challenges of today's security environment.

Doctrinal Considerations

This paper has identified the Stability Operation policy requirements and Army shortcomings in accordance with NSPD 44 as well as DoD 3000.5. Before attempting to clarify the capacity and capability gaps, it is important to understand what Joint and

Army doctrine says about the Army's roles and responsibilities. Additionally, what tools are currently used by the GCC in TSC and PCB operations?

Foreign nations must develop their own plans for growth and stability before they request U.S. assistance. The military calls that plan the Internal Defense and Development (IDAD) plan. It is defined as the:

full range of measures taken by a nation to promote its growth and to protect itself from subversion, lawlessness, and insurgency. It focuses on building viable institutions (political, economic, social, and military) that respond to the needs of society.⁶⁴

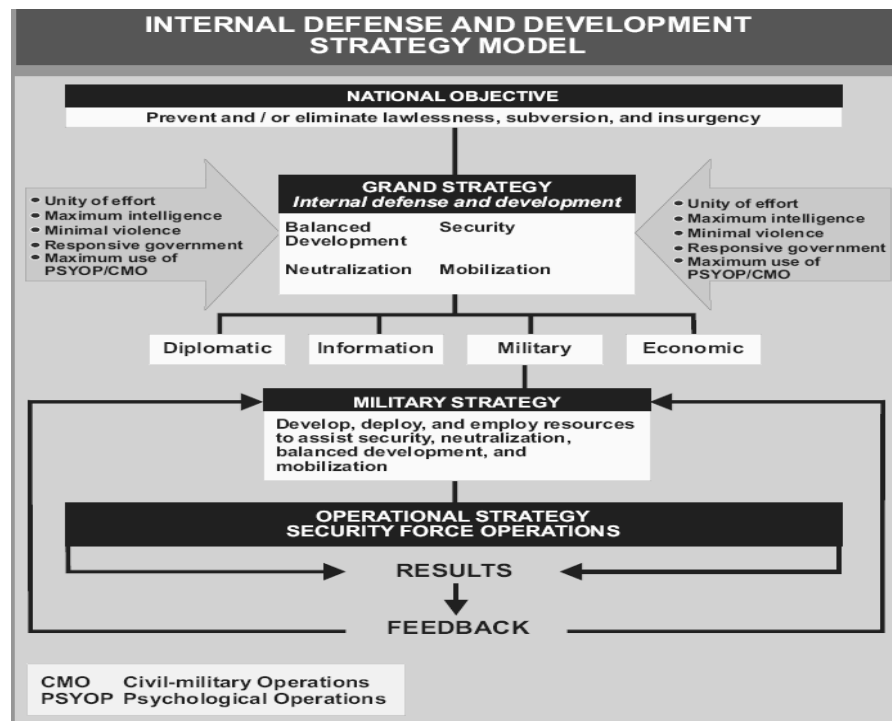

Figure 8: IDAD Strategy Model⁶⁵

“Commensurate with U.S. policy goals, the focus of all U.S. Foreign Internal Defense (FID) efforts is to support the Host Nations (HN’s) program of IDAD.”⁶⁶ FID is defined as “the participation by civilian and military agencies of a government in any of the action programs taken by another government or other designated organization to

free and protect its society from subversion, lawlessness, and insurgency.”⁶⁷ Most likely the needs of that country will be economic, social, political and informational. The U.S. will then employ a combination of both soft and hard power options to support the HN. So then what are the tools of the FID trade?

Military doctrine addresses indirect and direct support to FID.⁶⁸ The indirect approach contains many of the options typically used in TSC activities. Typical activities include multinational training and exercises, multinational education, military to military contacts, humanitarian and civic assistance, and other activities such as exercise related construction, intelligence security cooperation, information operations, command and control programs. Security Assistance (SA) is also part of TSC.

SA is a group of programs authorized by the Foreign Assistance Act of 1961, as amended, and the Arms Export Control Act of 1976, as amended, or other related statutes by which the United States provides defense articles, military training, and other defense-related services by grant, loan, credit, or cash sales in furtherance of national policies and objectives.⁶⁹

DoD defines Security Cooperation as

the interactions with foreign defense establishments to build defense relationships that promote specific U.S. security interests, develop allied and friendly military capabilities for self-defense and multinational operations, and provide U.S. forces with peacetime and contingency access to a host nation.⁷⁰

PCB is defined as the targeted efforts to improve the collective capabilities and performance of DoD and its partners. Additionally, FM 3-0 directs the Army to meet its Full-Spectrum requirements. These are civil security, support to governance, provision of essential services, support to economic development and infrastructure and civil control. So what does this all mean? It suggests that our doctrine is consistent with national policy.

Figure 9 describes the asymmetric paradigm and conditions the military faces during all phases of conflict. The importance of Shaping Operations during Phase 1 Insurgencies is critical. General Charles Wald, USAF (Ret) describes “Phase 0 (Shaping Operations) as a campaign unto itself...and the preventative focus of Phase 0 is less costly in (both blood and treasure) than a reactive approach to a crisis.”⁷¹

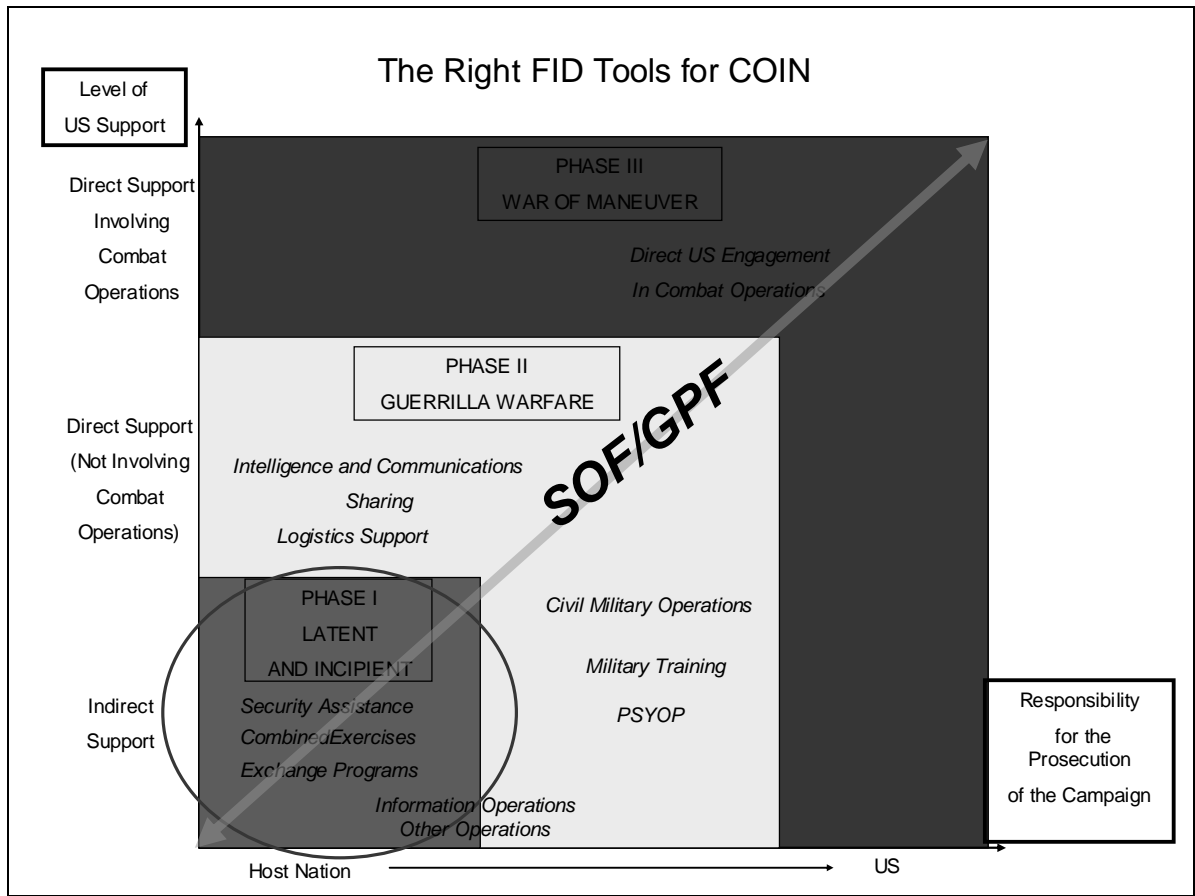

Figure 9: FID Paradigm across Full Spectrum Insurgencies ⁷²

So does the Army have all the tools required to execute Full-Spectrum Operations throughout the construct of FID and TSC operations from Phase 0 to Phase 5? The answer is simply no. The U.S. Army lacks the minimum force structure to meet current or future requirements for stabilization, training, and advising.

Capability and Capacity Gaps

As outlined above, our government's ability to execute Partner Capacity Building, Security Force Assistance, Theater Security Operations, Foreign Internal Defense, Irregular Warfare and SSTR is critical as we face a time of persistent conflict. There are capability gaps beyond the military requirement such as police and military training, regional and local governance and civil works type operations. In the absence of interagency capability, DoD and as a major subset – the Army, must develop these kinds of capabilities. Additionally, these requirements will likely increase over time as the U.S. builds AFRICOM and the associated challenges of that AOR. So capacity is an issue as our nation faces a continued terrorist threat. How does our military meet both GWOT requirements and engagement world wide?

The Proponency Requirement

As outlined in the Joint Center for International Security Force Assistance (JCISFA) Draft working Paper (March 2008), there is a:

requirement for a forcing function to unify the efforts of the services, DoD, and the U.S. Government to establish a meaningful Security Force Assistance (SFA) capability with sufficient capacity to execute our national strategy that is sustainable over time.⁷³

SFA is synonymous with Train, Advise and Assist.⁷⁴ SFA and PCB are virtually identical. This “Proponent” should be joint and interagency in nature. Because the Army maintains a robust military, military police, and CA capability, the Army should play significant role in the execution of these tasks. Without a proponent for Stability Operations, TSC, SFA and PCB operations, from the strategic to tactical level, we will continue to attack this complex problem in a piecemeal fashion resulting in incomplete proposals. To amplify the need to establish proponency first, the Army's Draft White

Paper (February 2008) describes the need for a Stability Operations and Training Assistance Proponent very well. Our current structure for language, cultural studies, military training teams, provincial reconstruction teams etc. are ad-hoc at best.

For example, the Army proponent for language contracts (linguists) is the DA G-2, while the DA G-3 is the designated member of the DoD language board. The Secretary of the Army is executive agent for Defense Language Institute Foreign Language Center (DLIFLC) and has designated DA G-3 as lead. The DA G-3/5/7 has designated G3-Training as the Senior Language Authority for the Army. DLIFLC language instruction is managed by Training and Doctrine Command (TRADOC) G-3/5/7. The TRADOC G-2 runs University of Foreign Military and Cultural Studies (UFMCS) as a TRADOC school and has proponentcy for Red Teams. United States Army Intelligence School and Center (USAISC) sponsors the TRADOC Culture Center and has training proponentcy for cultural understanding. FORSCOM currently trains the Transition Teams (TT) and with the State Department, trains the Provincial Reconstruction Teams (PRT). The Combined Arms Center is conducting work on behalf of CG, TRADOC and HQDA to develop the TMAAG-Fs as well as the enduring training concept for TTs and PRTs. This does not include the list of current organizations working within Stability Operations to one extent or another – the Peacekeeping and Stability Operations Institute (PKSOI) at Carlisle Barracks, the Counter Insurgency Center (COIN) at Ft. Leavenworth and the Joint Center for International Security Force Assistance (JCISFA) also at Ft. Leavenworth. Additionally, as the USAR Civil Affairs (USAR CA) units and Psychological Operations (USAR

PSYOPS) units no longer fall under U.S. Army Special Operations Command, they essentially have lost their proponent.⁷⁵

Within this myriad of ongoing activities, there is no single proponent that integrates all activities to provide a common overarching direction and can justify/prioritize requirements for engagement and stability operations. Without that voice, there is no funding, synchronization and little effectiveness. In addition to the proponent, there are many other gaps in U.S. capability to further U.S. interests from the strategic to tactical levels.

Stabilization, Advise and Train Capability/Capacity Gaps and Requirements

- Strategic National Level
 - Advocate the creation of a dedicated U.S. Government office to develop top-level policies for SFA to coordinate actions across the USG in support of the National Security Strategy.⁷⁶
 - Establish Joint and Service Proponents to synchronize actions across Doctrine, Organizational, Training, Leader, Material, Personnel and Facility construct (DOTLM-PF) and institutionalize lessons learned. Unity of effort will not occur without responsibility and authority.
 - Develop scalable organizations to train and advise foreign security forces and security institutions (unilaterally or as part of civilian-military) teams in permissive and contested areas.⁷⁷
 - Propose comprehensive legislative changes (including the Police Training Prohibition) to enhance operational effectiveness of PCB and

SFA related Authorities in Section 1206 of the FY 2006 National Defense Authority Act and DoS Title 22 Legislation.⁷⁸

- Develop funding streams (either Title 10 or 22 or new) that facilitate long term execution of Phase 0 to Phase V operations using TMAAGs and Ministry Teams (MTs).
- Develop DoD/DoS Memorandum of Agreement on specific responsibilities for Shaping Operations through Stability Operations.
- Build upon existing expertise; establish a Joint-Interagency-Intergovernmental-Multinational Advisory and Assistance Center of Excellence (COE) to include a Joint Interagency Foreign Governance Center of Excellence.
- Establish a Joint and Interagency Training Center of Excellence for Stability Operations and Training Assistance.
- Advocate reestablishing the U.S. Information Agency to positively engage U.S. and international opinion regarding SFA operations and activities.⁷⁹
- Develop incentive programs such as focused recruitment, retention bonuses, specialty pays and promotion incentives to build, enhance and retain GPF personnel with TMAAG and MT skills.⁸⁰
- Develop educational opportunities for GPF personnel by undertaking tours of duty with foreign security institutions, other U.S. Departments and Agencies, International Organizations, NGOs.

- Adjust Professional Military Education (PME) to facilitate social science and cultural understanding instruction.
- Strategic Theater Level
 - Future capacity efforts focus on Phase 0 while current capacity efforts focus on Phase IV. The capacity must be able to expand and contract based on demand to cover steady state to major stability operations and have the capability to rotate forces.⁸¹
 - SFA and PCB activities require institutionalization.⁸²
 - Maintain expeditionary units organized, trained and equipped to provide civil security, restore essential governmental functions, repair key infrastructure necessary to government functions to sustain human life, and reform or rebuild indigenous security institutions indigenous, international, or U.S. civilian personnel can do so.⁸³
 - Train and advise foreign security forces and partners at the institutional, operational and tactical levels to strengthen indigenous irregular and traditional warfare capabilities.⁸⁴
 - Develop pool of active Army Civil Affairs specialists to serve as staff principals on both strategic and operational level commands and agencies.⁸⁵
 - Civil Affairs or General Purpose Forces MOSs and ASIs should be modified to meet the new reality of foreign governance challenges and ministries. This list should include but is not limited to; public health, internally displaced personnel and refugee resettlement, power

generation, public works, culture, public integrity, water resources, agriculture, defense, interior, justice and courts, human rights, transportation, communications, environment, youth and sports, education, banks and financial institutions, trade, industry and minerals, science and technology, housing and construction, and planning and development.⁸⁶

- Develop GPF active duty CA with the requisite MOSs and ASIs to integrate into permanent force structure and nest with follow-on S/CRS assets as the security environment permits.⁸⁷
- Significantly increase the training and education of CA. Specifically, how to train, advise, assist, lead, mentor and educate ministries or local governments.⁸⁸
- Develop clinical or cyclical testing to maintain CA proficiency especially in ministerial type operations.⁸⁹
- Military Operational Level
 - Develop regionally oriented TMAAG (Army and Police capabilities) and National/Regional Ministry Teams (NMTs/RMTs) as a “Ranger” like organization with specified command opportunities.⁹⁰
 - “Operationalize” culture or language training within the GPF Army through service in TMAAG, NMT, and RMT organizations.
 - Direct development of effective personnel mechanisms to assess, train, educate, employ and track advisory and ministry assistance personnel.⁹¹

- Provide brigade and battalion command and CSM opportunities for officers and NCOs who pursue opportunities in this capability. Ensure personnel are given equal opportunity for advancement. Advisors must “escape the nagging feeling that he is a second class citizen.”⁹²
- Tactical Level
 - Review procedures to obtain qualified and reliable linguist contractors in a contingency environment.

Force Structure Overview – A New Paradigm

As Secretary Gates has stated, our armed forces must take a different look at our operational design and how we can best address the needs for PCB and SFA throughout the continuum of conflict especially during TSC operations. The United States European Command Posture Statement of 2006 stated that:

proactive peacetime engagement activities reassure allies and partners, promote stability and mitigate the conditions that lead to conflict. We base our strategies on the principle that it is much more cost effective to prevent conflict than it is to stop once it has started.”⁹³

If it is that important, then it is time to give Geographic Combatant Commanders more tools to fight in this asymmetric environment.

There are several imperatives that must be incorporated into the design. They are:

- First, there must be a significant mind shift among senior governmental and military leaders in regard to force structure for TMAAGs, Police Advise and Assist Training Teams (PAATTs) as well as National and Regional Ministry Teams. It is not an argument of getting away from the Army’s core

competency or fighting and winning our nations wars but having a minimal effective capability within our Army. By having a small core of Army, Police and Ministry Trainers, the United States will have a professional, trained, and focused capability that is not ad-hoc or temporary in nature and can complement MCO.

- Establish a Joint or Service Proponent responsible for DOTLM-PF and statutory (i.e. flexibility to Title 10 and 22, expand GCC TSC discretionary funding as well as expanding Section 1206 authorities) requirements.
- Force Design – (This paper will assume that the Army has the lead in the development of structure. It will not attempt to create Joint positions throughout the organization although ultimately that is preferred).
 - Leverage existing structure from DoD and DoS to build capacity and limit manpower bill requirements (i.e. combine S/CRS, PKSOI and JCISFA, UFMCS. Reorganize CA, etc). Most of the capability already exists in our government.
 - Establish COEs for Stability/Foreign Governance Operations, Advisor Operations as well as training. Institutionalize DOTLM-PF construct.
 - Design must include national/theater to battalion/local level capability that is capable of planning and executing in both peace and wartime. Capability will be scalable in nature.
 - Design will correspond to GCCs AOR.
 - Units must be able to operate in an environment that is permissive as well as non-permissive.

- Cultural and language training is operationalized throughout organization.

Force Structure Operational Concept – An Option

The Security Advisory and Assistance Command (SAAC) (See Figure 10) is the capstone proponent that serves as the Joint Center of Excellence for Stability Operations, PCB, SFA and SSTR operations. JCISFA would embed into this command and facilitate proponentcy for the SAAC. Additionally, SAAC would work in close coordination with the Security Force Assistance and other Security Assistance programs to optimize requirements. If required, and under future reorganization, these commands could fall under SAAC to gain synergies. The commands and their capabilities are:

- The U.S. Army Security Assistance Command (USASAC) implements approved U.S. Army security assistance programs, including Foreign Military Sales (FMS) of defense articles and services to eligible foreign governments. They are also responsible for the entire process of initial fielding to management of each FMS case in approximately 168 countries.⁹⁴
- The Security Assistance Training Directorate (SATD) is a subordinate element of TRADOC and the G-3/5/7. It functions as the Army program manager for U.S. Government-authorized and DOD-executed Security Assistance Training Programs (SATP). It provides Army-managed training to approved countries and international military students in CONUS and outside continental United States (OCONUS) in support of combatant commands (COCOM), Army component commanders, and HQDA security cooperation

objectives. Assists the CG, TRADOC as executive agent (EA) for security assistance training.⁹⁵

- SATD includes the Security Assistance Training Field Activity (SATFA) at Fort Monroe and the Security Assistance Training Management Organization (SATMO) at Fort Bragg. SATFA manages the training of over 9,000 international students in nearly 10,000 seats per year. Students come from 165 countries to 90 Army-managed training activities, including 22 TRADOC schools. SATMO deploys nearly 400 personnel in 69 teams to over 37 countries each year to train international personnel. SATMO maintains 10 PCS teams in CENTCOM, EUCOM and SOUTHCOM.⁹⁶

SAAC is a TRADOC Table of Distribution and Allowances (TDA) unit that falls under the Combined Arms Center and consists of approximately 1,300 personnel. It is commanded by a Major General who is responsible for all DoD SFA and PCB issues as it relates to TSC, SSTR, COIN, FID, UW, IW, and MCO. SAAC, as the proponent, would conduct long range planning to ensure the combined capabilities and capacities of other Services as well as OGAs meet future operational requirements. In a sense SAAC would attempt to, through coordination, facilitate a Joint Strategic Capabilities Plan (JSCP) for the interagency in cooperation with the DoS and National Security Council.

SAAC also would manage DOTLM-PF for the interagency and joint force and work legislative and funding issues with Congress. Most authorities regarding SFA and PCB were designed during the cold war and therefore do not offer timely response in our current environment. The command would conduct liaison with other Services,

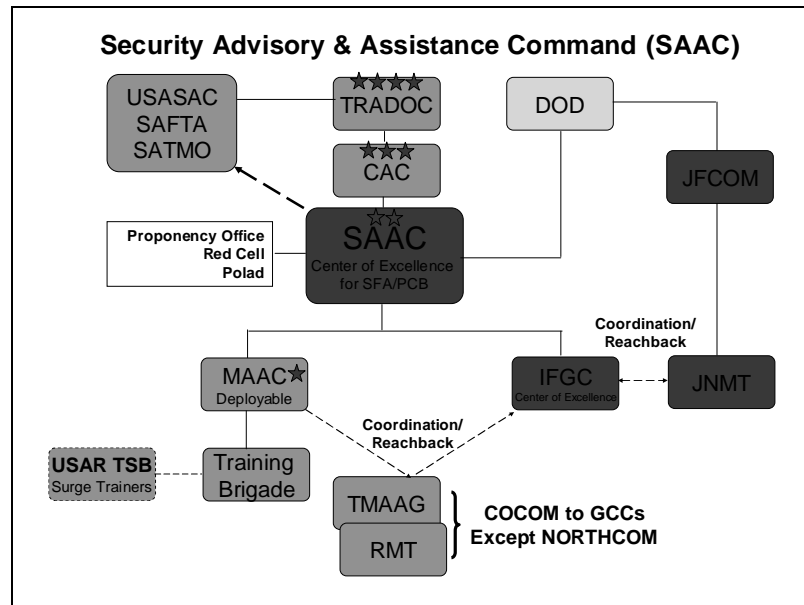

Figure 10: Security Advisory and Assistance Command⁹⁷

allies, OGAs, U.S. country teams as well as the Geographic Combatant Commanders. The SAAC would either integrate or coordinate with Joint Forces Command J7/9, Naval Expeditionary Combat Command-ETC, MARSOCs – Foreign Military Training Units, U.S. Army Special Forces, USAFSOC-FID Squadron as well as the DoS-S/CRS. Additionally, this command could assist Security Cooperation - Marine Air Ground Task Forces (SC-MAGTFs) with additional capability or support during Advisory and Assistance missions.

In addition to its Title 10 responsibilities and Generating Force requirements, SAAC would contain a deployable command headquarters called the Military Advisory Assistance Command or MAAC commanded by a Brigadier General (See Figure 11). The MAAC consists of a deployable Headquarters and Training Group with coordinating responsibilities to the TMAAGs. The TMAAG remains an assigned and theater committed unit under each ASCC. The SAAC would also oversee the Interagency

Foreign Governance Center of Excellence (IFGC). The IFGC would be lead by a civilian Senior Executive Service officer. The IFGC would contain a Deployable Joint National Ministry Team and maintain coordination with the Regional Ministry Teams (RMT) that are subordinate to the ASCCs and partners with TMAAGs during tactical operations.

The MAAC is a comparable to small deployable MNSTC-I and will consist of approximately 116 personnel. At home station, it would manage the daily assessment/training of advisors (Training Brigade) and assist deployments of all TMAAG and RMTs. If more than one TMAAG or RMT is required for operations, the MAAC can deploy as part of the JFC's force package.

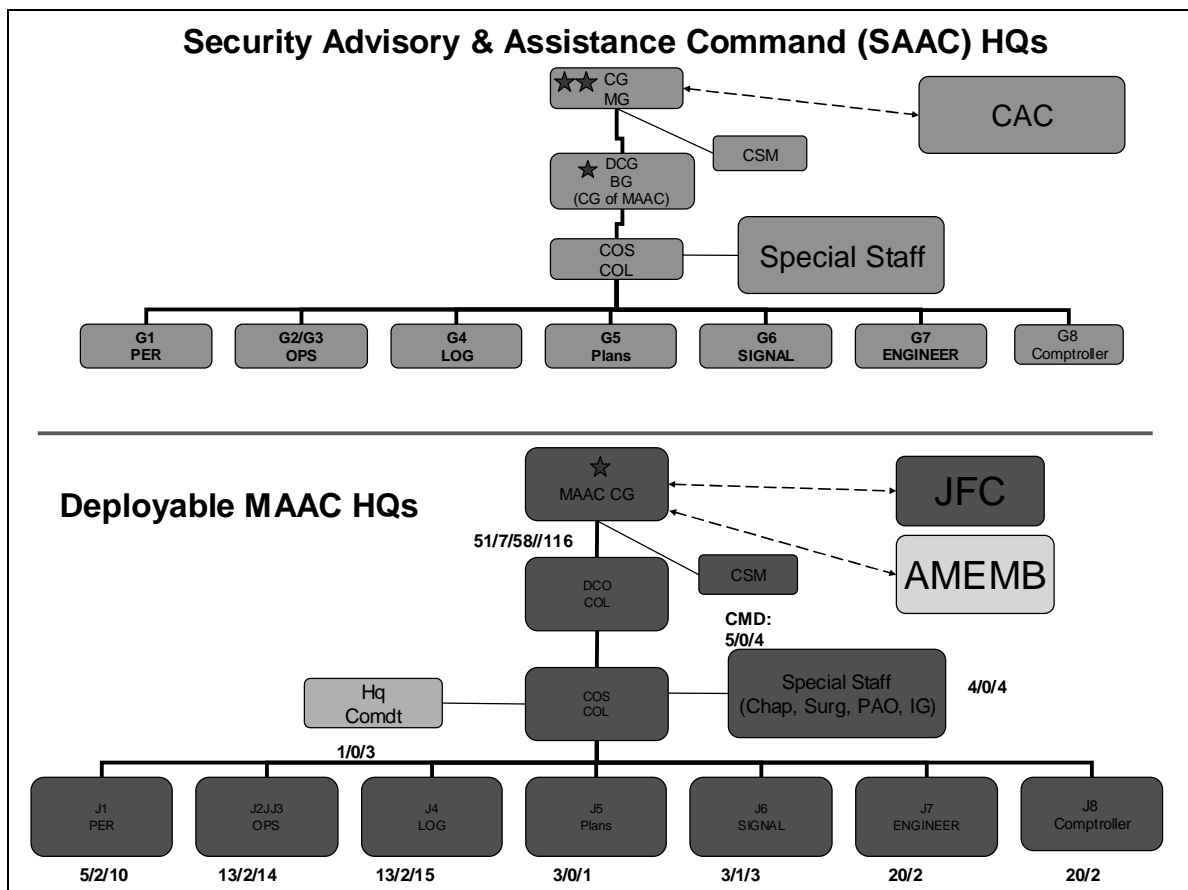

Figure 11: Military Advisory and Assistance Command⁹⁸

In addition to executing security cooperation tasks it can also under the proper authorities conduct combat advising or contingency operations. The MAAC assists Regional TMAAGs in AOR-wide planning, coordination and support of GCC TSCP requirements and coordinates request for forces with FORSCOM for assets beyond their organic capability. Additionally, they would work for the Joint Force Commander as well as host country and U.S. Country Team or MILGROU. Its functions would include assisting the GCCs and subordinate ASCCs, in professionalizing Foreign Security Forces (FSF), conducting traditional Foreign Internal Defense (FID), executing Security Assistance operations (FMS, IMET, MTTs, etc), developing partner nation FSF Title 10 capabilities - legal and legislative authorities - interagency operability in addition to combat advising.⁹⁹ The headquarters is organized as a battle rostered headquarters with manning document additions from the ASCC. Specific manning would come from both the Active and Reserve components. The MAAC would act as seed-corn for larger operations in the required AOR and determine when scalable or ad-hoc units were required.

The Training Brigade (See Figure 12) of the SAAC consists of a TRADOC TDA organization that is supervised by the MAAC (currently the Army is moving the Fort Riley Advisor Training Brigade capability to JRTC and Fort Polk, Louisiana). The Brigade size element of approximately 900 personnel will consist of a standard staff with a Training Support Battalion (TSB), Individual Training Battalions (ITB), Operations Group (OG) and the University of Foreign and Cultural Studies (relocated from Fort Leavenworth, Kansas). Additionally, the Training Brigade will partner with a United States Army Reserve Training Support Brigade (TSB). The TSB will provide surge

instructor capacity during contingency operations so that an active Division or Brigade does not have to shut down in order to support the advisor training mission.

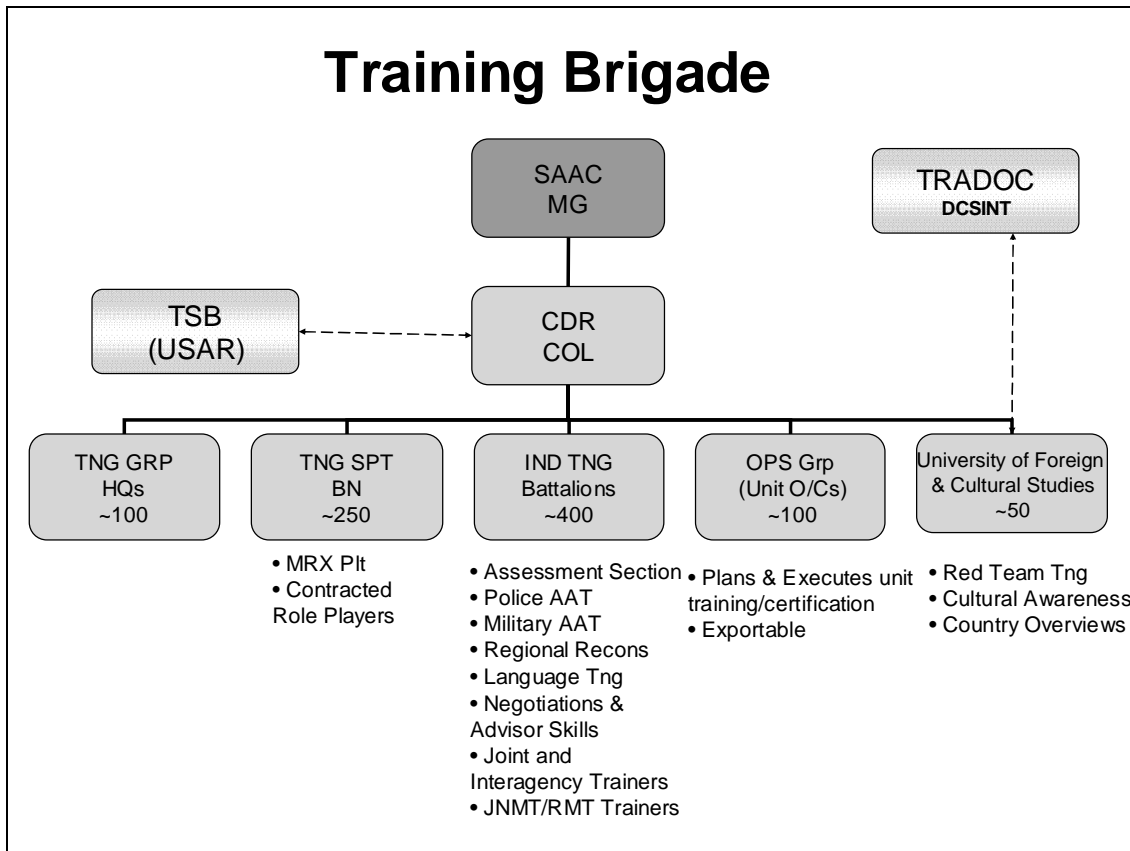

Figure 12: SAAC Training Brigade Organization ¹⁰⁰

What is different from the current TT Brigade at Fort Riley is the Individual Training Battalion will assess each candidate to include background screening, a psychological profile, medical and physical screening and a selection board. The criticality of this assessment is paramount to ensure our best are conducting engagement for America. Additionally, the Individual Training Battalion will train Army, Police as well as Governance Advisors. Skills sets required for each advisor will include subject matter expert skills, combat and advisor skills, and advanced individual training such as language and cultural studies. Language and cultural training will focus on

regional orientation by national priorities. The ITB will also contain elements from the interagency to train both civilian and military personnel in Embassy, USAID, DoS, Treasury, Justice and other interagency components in regards to SFA and PCB. Additionally, the ITB will facilitate AOR familiarization tours similar to that of Foreign Area Officers to gain situational awareness and understanding.

Another operational function for the MAAC is to retain a linkage between the ASCC and the Interagency Governance Center. Additionally, it would manage contracted and local hire personnel for the teams at home station or when deployed.

The Interagency Foreign Governance Center of Excellence would consist of numerous agencies, departments, and civilian think tank representatives as well as military personnel that span numerous government agencies and responsibilities (See Figure 13). Additionally, Joint Civil Affairs personnel, elements of the S/CRS and the

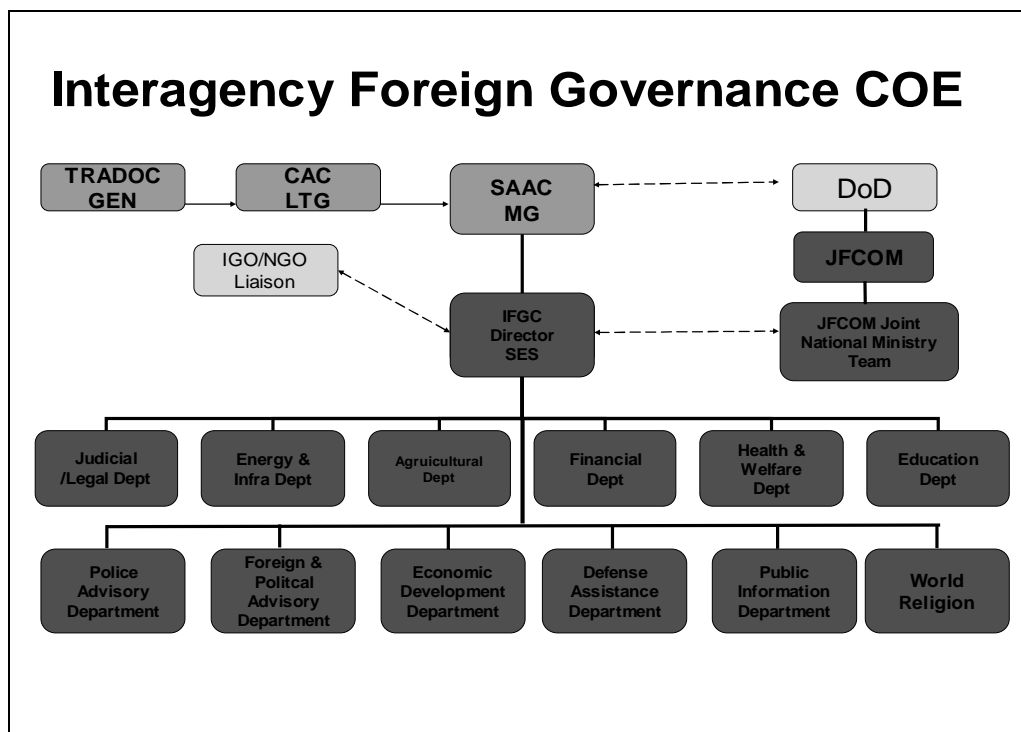

Figure 13: Joint Interagency Foreign Governance Center of Excellence ¹⁰¹

Army's Peace Keeping and Stability Operations Institute and others would man the IFGC to reduce the bill-payer requirements. The Center will contain approximately 200 personnel. The center's purpose is to study and advise on full-spectrum stability and security operations as well as synchronize SFA and PCB. S/CRS currently focuses only on Reconstruction and Stabilization Operations (Phase V). There is no single central coordination and management agency that spans control from steady state to major stability operations in regards to governance issues. Therefore, the requirement for the Joint IFGC exists.

Additionally, the IFGC is responsible for joint and interagency concept development, experimentation and analysis for FID, PCB and SFA. The organization could provide policy recommendations through the SAAC Commander to the Country Reconstruction and Stabilization Group (CRSG) at the State Department. The CRSG could then make recommendations to principals on strategic planning guidance. They could assist the NSC in wargaming of interagency plans as well as facilitating the synchronization of the diplomatic, informational as well as economic elements of National power. The IFGC also works authorities issues (Title 10/22 and 1206) and provides reachback capabilities for deployed National and Regional Ministry Teams. The Center is also capable of facilitating the development of DoD/DoS Memorandums of Agreement, developing DOTLM-PF solutions for foreign governance assistance as well as providing themes and messages to positively engage U.S. and international opinion regarding PCB, SFA and SSTR operations.

The design of the IFGC includes coordination with a deployable Joint National Ministry Team assigned to JFCOM as well as a Red Team. The Red Team would

challenge plans, operations, concepts, organizations and capabilities that are developed by the IFGC as well as the MAAC from an asymmetric adversary perspective.

The Joint National Ministry Team (JNMT) (Figure 14) works for JFCOM but is the operational arm of the IFGC. It is manned in a Joint Manning Document under JFCOM and consists of 116 personnel. The Team Director is a DoS representative. The Deputy is a 38A (Civil Affairs) Joint qualified Colonel. The JNMT consist of senior level

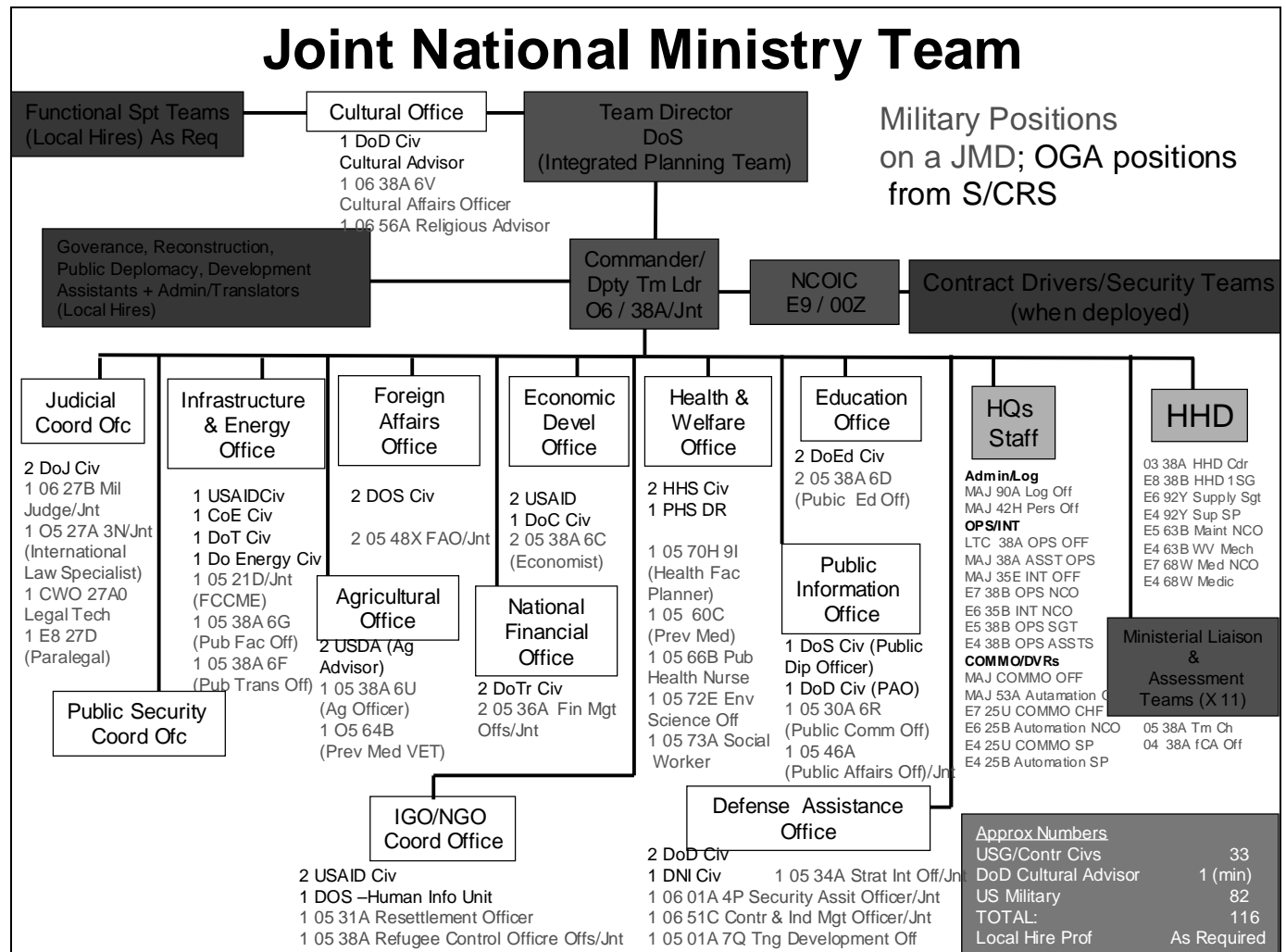

Figure 14: Joint National Ministry Team ¹⁰²

experts in broad and diverse governance functions from both the military and civilian sectors. The JNMT conducts national level planning and deployment capability for the military in conjunction with the S/CRS Integration Planning Cell (IPC) (See Figure 15).

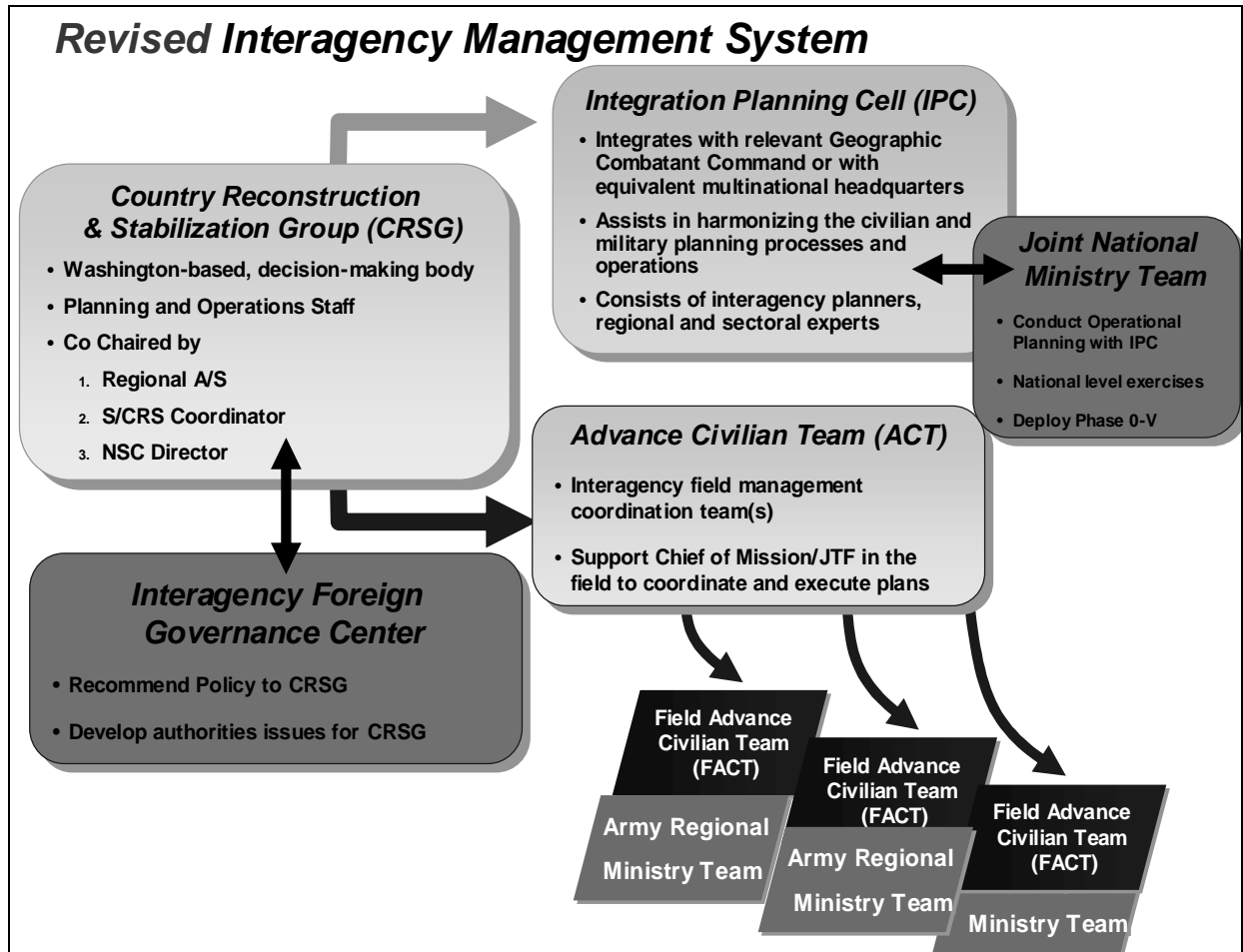

Figure 15: Revised S/CRS Interagency Management System¹⁰³

They can assist GCCs in developing their TSCPs and facilitate RMTs deployment and execution. The unit would participate in national level exercises as a full-spectrum Ministry Team capability and during contingency operations the unit would deploy with the MAAC and form the core governance function for the Joint Force Commander, Embassy or USG presence. Military personnel would assume most of the capability during combat operations and transition to full capability (i.e. ARC, SRC, CRC or

assigned personnel) as hostilities decreased (See Figure 16). Again, it is important to note that the ARC, SRC and CRC are post conflict capabilities and are not focused on steady state TSC operations.

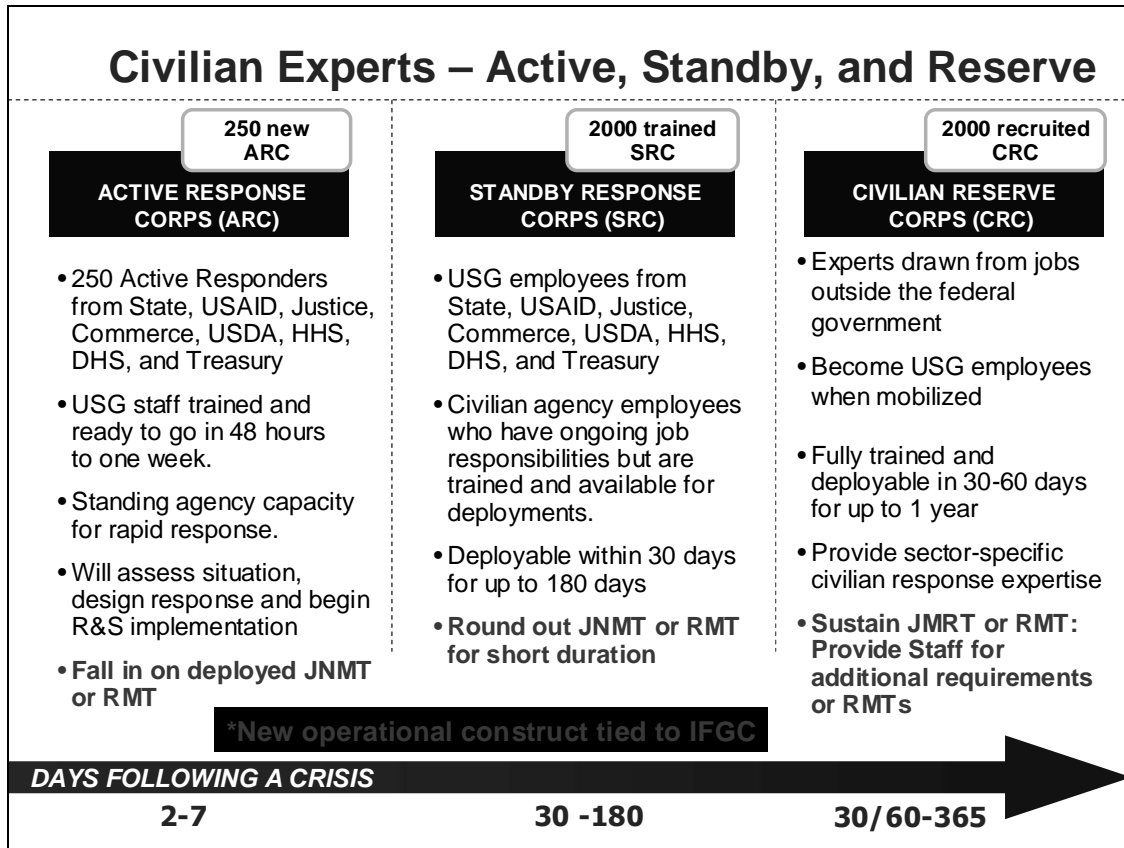

Figure 16: Civilian Response and Reserve System¹⁰⁴

Regional Ministry Teams (See Figure 17) are assigned to each GCCs ASCC and partnered with the TMAAG for training and operations when feasible. They are capable of spanning advisory capability from the local to the provincial level. During MCO, the RMT can be augmented by additional CA Task Forces or by ARC, SRC or CRC based on combat conditions. Like the JNMT, the RMT is lead by a civilian Team Leader partnered with a Civil Affairs Lieutenant Colonel Deputy. Again, military personnel would assume most of the capability during combat operations and transition to full

capability with it's civilian counterparts as hostilities decreased. The organization does not contain as many functions as the JNMT but can provide extensive services to a Host Nation. The RMT can be task organized with engineers, other CA units or combat forces in order to accomplish a TSC or FID type mission. The RMTs would work closely with the S/CRS Field Advance Civilian Team during R&S operations.

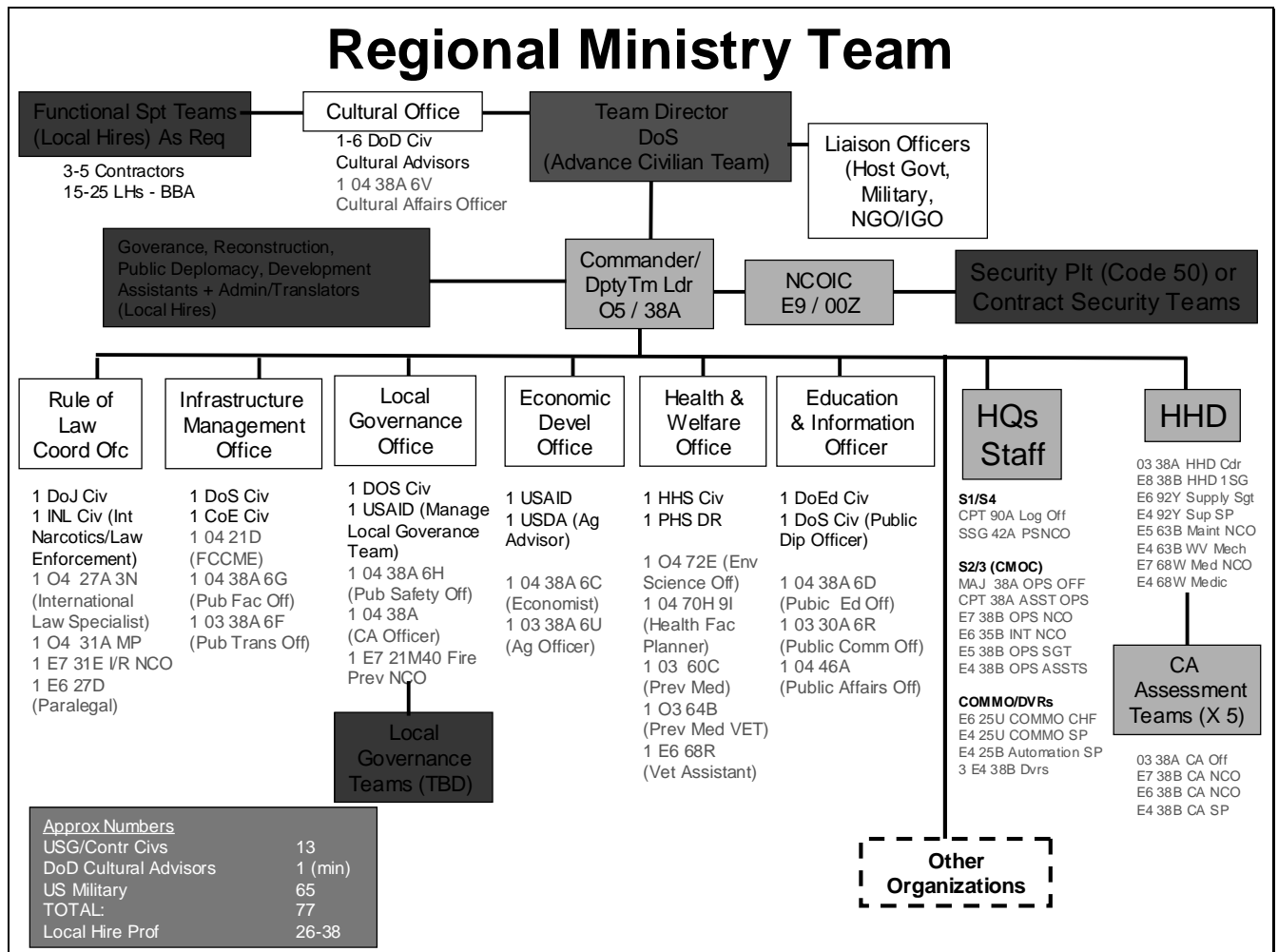

Figure 17 – Regional Ministry Team ¹⁰⁵

The TMAAG (See Figure 18) is a subordinate assigned theater committed unit to each Army Service Component Commander. This calls for five regionally aligned TMAAGs (all except for NORTHCOM). The TMAAG consists of a Headquarters

Detachment (14 personnel), a Rear Detachment (4 personnel), a Human Terrain Team (5 personnel) and the TMAAG Headquarters itself (47 personnel).

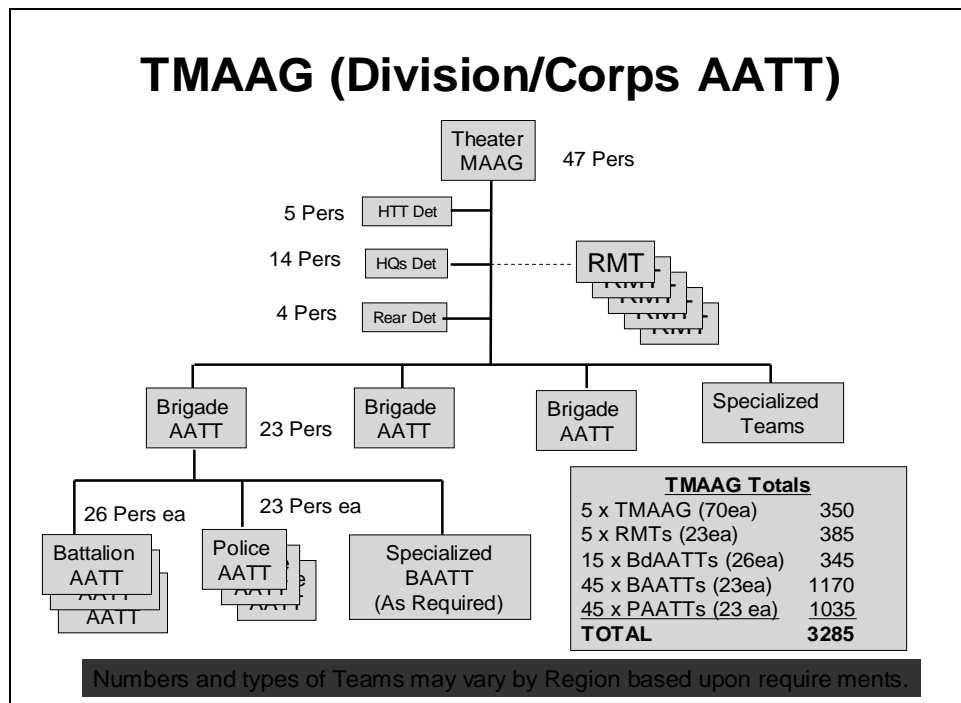

Figure 18: Theater Military Advisory and Assistance Group Structure¹⁰⁶

The TMAAG Headquarters itself can execute Division or Corps level TT missions (See Figure 19). It receives its missions from the ASCC and coordinates with the MILGRP or JFC. The TMAAG has coordination responsibilities with the RMT if deployed and can work for the TMAAG Commander if assigned as a JTF. The TMAAG and associated units provide additional capacity to SF units and can work for other JTFs such as a Maneuver Enhancement Brigade (MEB) if required. TMAAGs or their elements may be placed TACON/OPCON to BCTs for Combat Advisory missions as well. The TMAAG is optimized to provide additive TSC and SFA/PCB capability enabling SF units to focus on HN Special Operations training. They may serve to train and advise Host Nation

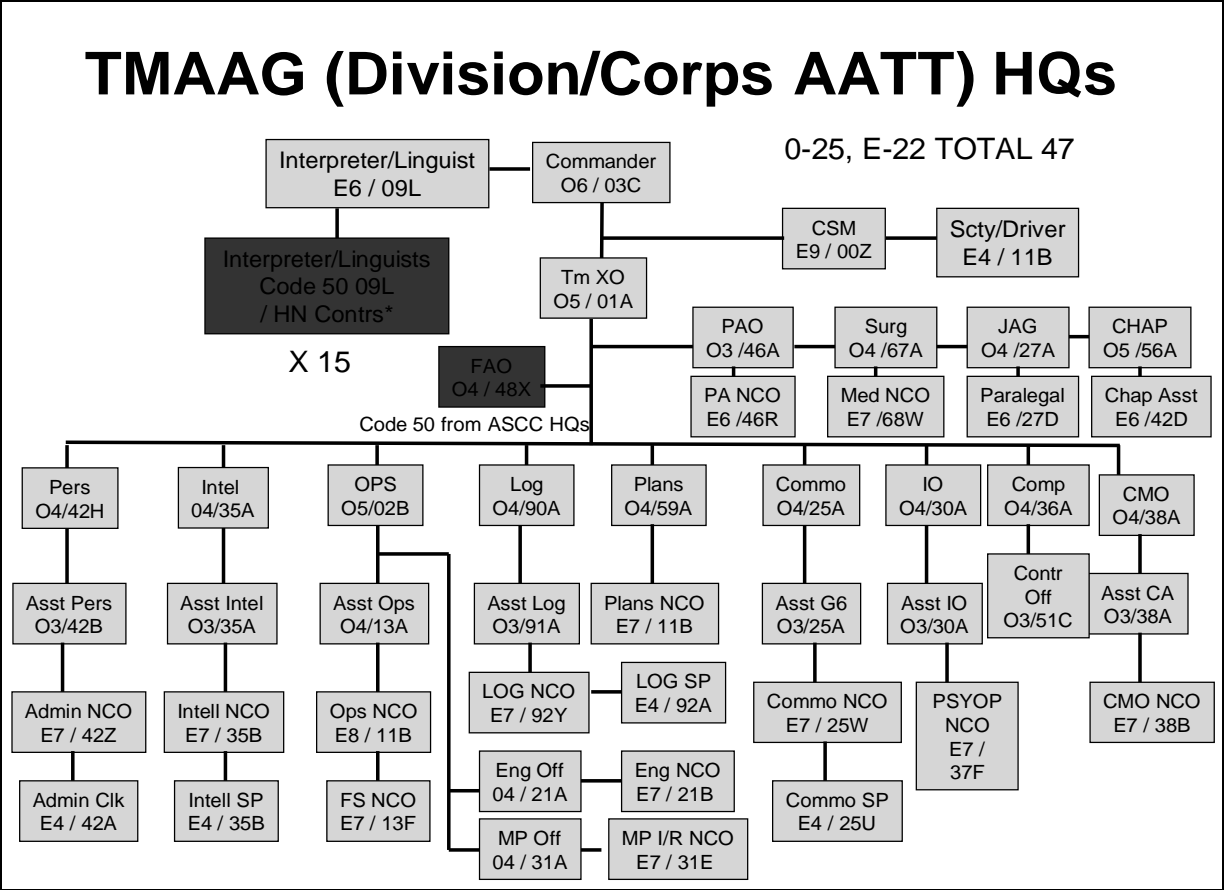

Figure 19: TMAAG Headquarters¹⁰⁷

conventional land forces, provide unit evaluations and assessments, conduct in-country assessments and train the trainer missions, procure U.S. defense articles, conduct multinational education and facilitate mil to mil exchanges to name a few. The TMAAG is capable of assisting in other activities such as exercise related construction with the RMT, intelligence security cooperation, information operations, and command and control programs.

TMAAGs may also form specialized BAATTs (i.e. Border Police, Field Artillery or Logistic Support etc.) to complete a function for a host nation. These special teams are

not limited to Army functions. The TMAAG could support HN aircraft training, port operations, or border security as well with proper augmentation from other components.

The TMAAG and RMT can operate under two different Command and Control (C2) relationships. First, under an advise/assist mission the TMAAG or RMT may be OPCON to a JTF or Ambassador while ADCON through the ASCC. The ASCC will coordinate with the Chief of Mission to determine the OPCON/TACON command relationships. During MCO, units are TACON to a Corps, a Division or even a BCT while remaining ADCON to the ASCC until the MAAC is deployed.

The TMAAG normatively commands three Brigade Advisory/Assist Training Teams (BdAATT) consisting of three Battalions of Battalion Advise/Assist Training Teams (BAATTs) and three Police Advise/Assist Training Teams (PAATT) (See Figures 20-22) in order to maintain an ARFORGEN like deployment cycle. The TMAAG analyzes missions and assigns subordinate teams to execute tasks within its capability. The TMAAG will provide LNO capability in order to facilitate operations. The TMAAG is commanded by a centrally selected Colonel while BdAATTs are commanded by centrally selected Lieutenant Colonels.

It is important to note that through the Police Advisory Department of the IFGC, civilian police trainers are provided to the PAATs. This is a critical component to HN success in teaching topics such as patrolling, community policing, criminal investigations etc. Given the proper legal authorities in the new asymmetric environment, PAATTs become a significant combat multiplier for any IDAD program and for the TMAAGs TSC capabilities.

Brigade Advisory/Assist TT (BdAATT)

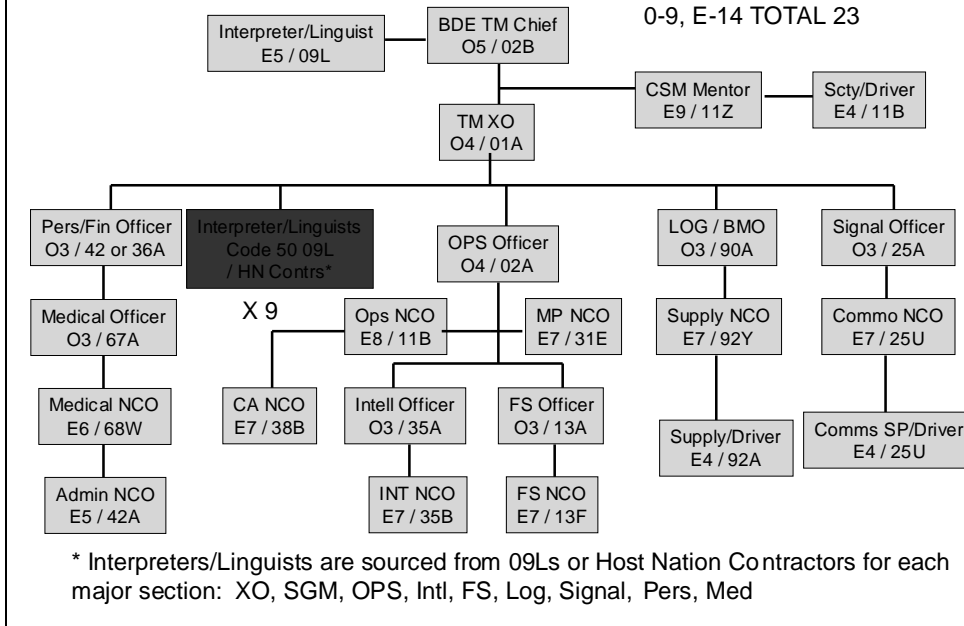

Figure 20: Brigade Advisory/Assist Training Team¹⁰⁸

IN Battalion Advisory/Assist TT (BAATT)

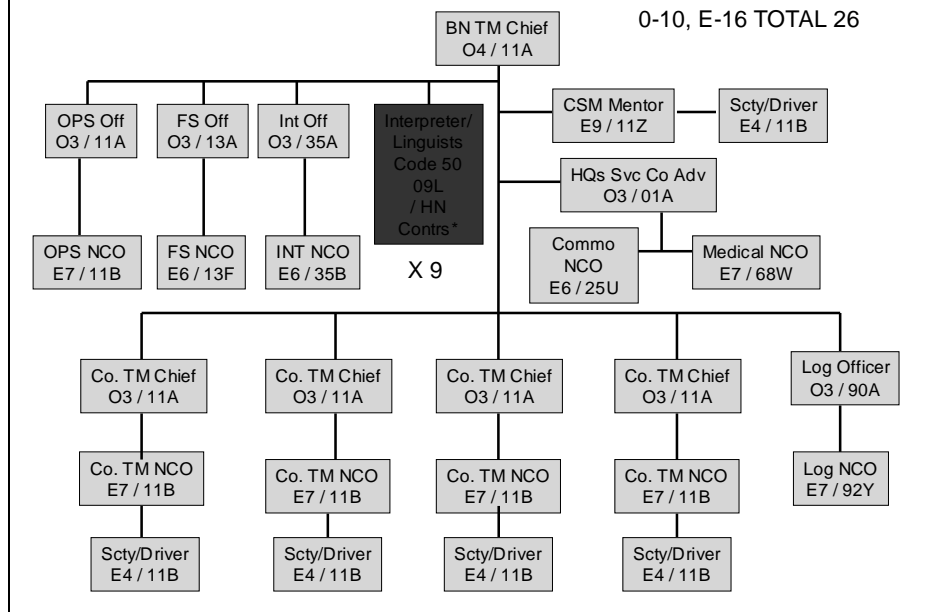

Figure 21: Battalion Advisory/Assist Training Team¹⁰⁹

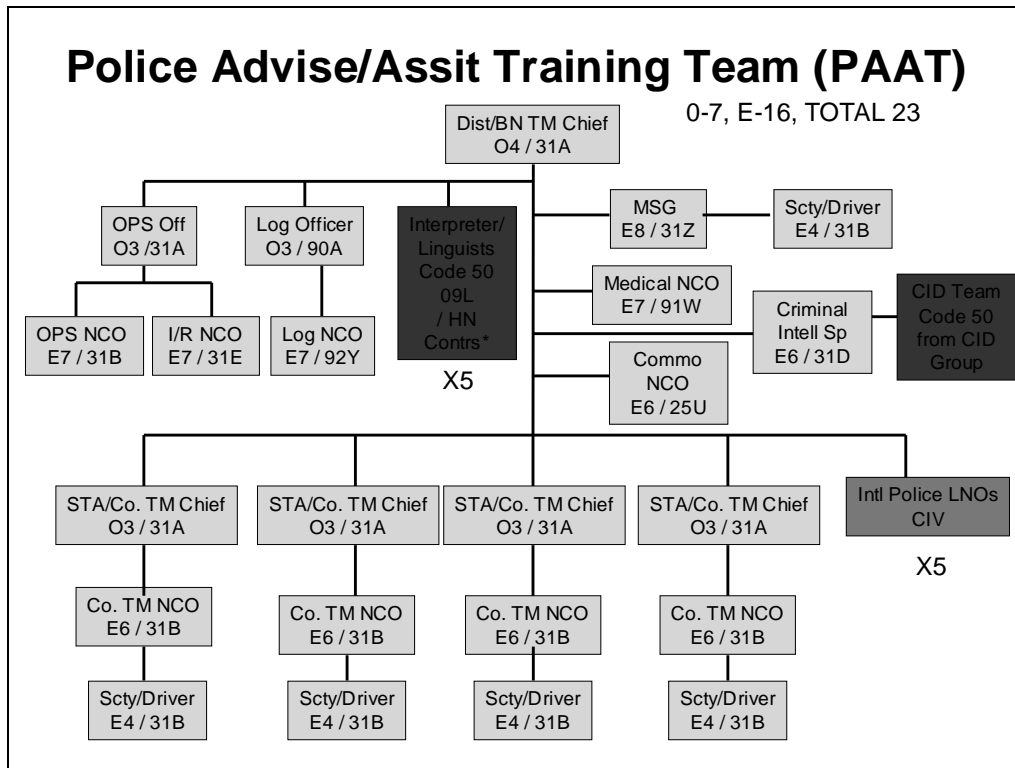

Figure 22: Police Advisory/Assist Training Team¹¹⁰

Other DOTLM-PF Considerations

- Doctrine
 - Synthesize a joint publication that discusses the employment, capabilities, standards, responsibilities, terms and other considerations for military, police, and governance SFA and BPC operations.
 - Capture lessons learned and tactics, techniques and procedures from past and recent history of military, police and governance advisory missions.
 - Create a menu of new and traditional shaping activities for SFA and BPC.
 - Establish Human Terrain Team data bases.

- Create standard military, police and governance readiness assessment reports.
- Organization
 - DoD completes a comprehensive interagency study on organizations to include police and governance structure.
 - Gain Congressional understanding and funding for the benefits of SFA/BPC activities.
 - Gain authorities to conduct police advising and training in order to meet our current asymmetric threat.
 - Establish interagency proponentcy for all phases of SFA, BPC and stability operations.
 - Institutionalize minimal capability through proposed design.
 - Analyze requirements or possibilities for contractor supported positions (i.e. currently a requirement for civilian police as members of PAATTs).
 - Baseline organization is scalable with augmentation. Develop phased requirements for OPLANs of follow-on TMAAG or RMT forces for the GCC.
 - TMAAGs and RMTs will depend on ASCC in order to reduce redundancies for administrative functions such as SJA, IG and comptroller.
- Training
 - Increase depth of advisor training through PME and practical experience.

- Develop detailed training plans for TT during contingency operations.
 - Develop steady state training plans for SFA and BPC.
 - Send cadre of Training Brigade through the Defense Institute of Security Assistance Management (DISAM) in order to perform that mission.¹¹¹
 - Fully man interagency positions at Training Brigade. DoS consider conducting all R&S training with Training Brigade.
 - TMAAGs will train to GCCs number one priority country in both language and cultural skills.
 - Each BdAATT will get a focus area for language and cultural studies IAW GCC priorities.
 - TTs will train to ARFORGEN like model and conduct JRT rotation prior to deployment. Additionally, support CTCs when applicable.
- Leadership
 - TTs conduct approximately one year of training prior to becoming operational.
 - TTs conduct AOR familiarization with the GCCs priority countries.
 - SAAC develops knowledge, skill and ability profile of leader skills IOT select the best candidates.
 - Provide one year internships with interagency before or after assignment in SAAC prior to returning to GPF.
 - Allow Officers and NCOs to stay in this area without promotion discrimination.

- Material
 - Equip SAAC with GPF equipment plus TMAAG specific items required for advisor duties.
 - SAAC develops new equipment and technologies to make this mission more effective.
 - Secure funding through Title 10, Title 22 or 1206.

- Personnel
 - SAAC would not be a branch but would recruit Advisors from the GPF.
 - Voluntarily assess candidates into program. Assign at last resort.
 - Candidates would conduct an assessment for entrance into program. Operational psychologists would have to be part of assessment team.
 - Optimal assignment length is 4 years. First year is training with 3 years of execution. Officer tours would occur after company command prior to CGSC. NCOs after branch qualifying jobs as a Staff Sergeant.
 - Consider cohort concept for TMAAG teams.
 - Provide ASI and pro-pay to advisors.
 - Track unique capabilities in Army for future operations in TMAAGs.
 - Refine board guidance for promotion and command opportunities as well as First Sergeant and Command Sergeants Major positions.
 - Develop unique Advisor patch and Tab for wear after specific criteria have been met (i.e. five advisor tours in country etc).
 - BdAATTs and BAATTs may contain a mixture of combat arms officers (i.e. not pure fleet infantry if armor officers or NCOs are available).

- Facilities
 - Basing options for the relative HQs are based on the preponderance of current capabilities around the country.
 - SAAC and MAAC could be stationed at Fort Leavenworth based on JCISFA and current commanders at that location.
 - The Training Brigade should continue to go to Fort Polk as currently planned. This would optimize CTC rotation integration and training area availability.
 - The TMAAGs and RMTs should co-locate with the ASCC (either forward or at home station). Another option is to pair them with SF groups to develop common training synergies, develop AORs, and share TTPs.
 - The IFGC could be stationed at Carlisle Barracks, PA. They would integrate PKSOI into their force structure and would be close to Washington D.C. to facilitate coordination.
 - The JNMT would be co-located with JFCOM at Norfolk, VA.

Conclusion

The United States is faced with expanding Islamic extremism, changing European and Sino-American relations, economic and financial globalization, population growth, environmental and energy imperatives while simultaneously conducting a war in two countries. We live in an era of persistent conflict where state, non-state and individual actors will use terrorism and violence to threaten our safety and freedoms.

Operations in the future will be executed in complex environments and will range from peace engagement to counterinsurgency to major combat operations. This era of persistent conflict will result in high demand for Army forces and capabilities.¹¹²

To gain access, acquire influence and build partner capacity on a global scale, we must relook our engagement strategy and the tools we have to apply to that strategy. Our history, our policy, our doctrine and our current requirements for Security Force Assistance and Building Partner Capacity clearly highlight our capability and capacity gaps. Our Army must institutionalize military, police and governance operations and provide a new structural paradigm for the manner in which we interact with the world.

The requirement to streamline processes from Shaping to Stability Operations is in our vital national interest. The Army does possess sufficient force structure to fill a portion of our current capability and capacity gaps. However, the Army is committed to employing “full-spectrum” BCTs to meet every mission requirement. This paper suggests that we only build five more BCTs rather than six. The recommended Security Assistance and Advisory Command would contain 4,717 personnel to meet the demands of our new operational environment. With this construct, we could meet our global engagement missions, which have been deferred worldwide, while continuing to fight in Iraq and Afghanistan. GCCs and Ambassadors would have regionally trained experts to employ, shape and develop ungoverned areas and reduce global risk. A permanent military, police and governance capability would complement the work of MILGRPs, SF ODA FID missions as well as regionally aligned BCTs.

Together these organizations could be task organized to provide optimal Army capability to meet our National Security Strategy. It is time to take the initiative and

create new structures that provides a more effective Joint, Interagency and Multinational team.

Endnotes

¹ Robert M. Gates, Secretary of Defense, "Association of the United States Army Speech," Washington, D.C., 10 October 2007.

² Andrew Feickert, *CRS Report for Congress, Does the Army Need a Full-Spectrum Force or Specialized Units? Background and Issues for Congress* (Washington, D.C.: U.S. Library of Congress, Congressional Research Service, January 2008), Summary Page.

³ The term Stability, Security, Transition, and Reconstruction (SSTR) consists of "Stability Operations"- an overarching term encompassing various military missions, tasks, and activities conducted outside the United States in coordination with other instruments of national power to maintain or reestablish a safe and secure environment, provide essential governmental services, emergency infrastructure reconstruction, and humanitarian relief. Stability operations support USG plans for stability, security, transition, and reconstruction (SSTR) operations and likely will be conducted in coordination with and in support of Host Nation authorities, OGAs, IGOs, and/or NGOs. "Stabilization" - is the process of managing underlying tensions and preventing or halting the deterioration of security, economic, and or political systems, thus creating the preconditions for reconstruction efforts. "Reconstruction" - is the process of rebuilding degraded, damaged, or destroyed political, socio-economic, and physical infrastructure of a country or territory to create the foundation for longer-term development. "Development" - transforms countries, through far reaching, fundamental changes in institutions of governance, human capacity and economic structure that enable a county to sustain further economic and social progress without depending on foreign aid. U.S. Department of the Army, *Stability Operations*, Initial Draft Field Manual 3-07 (Washington, D.C.: U.S. Department of the Army, n.d.), 2-2.

⁴ Francis J. Harvey and Peter J. Schoomaker, *A Campaign Quality Army with Joint and Expeditionary Capabilities, 2007 Posture Statement, Fiscal Year 2007*, Posture Statement presented to the 110th Cong., 1st sess. (Washington, D.C.: U.S. Department of the Army, 2007), 10.

⁵ The Institute of Land Warfare, Association of the United States Army, *An Analysis of the Fiscal Year 2008 Army Budget* (Arlington: Association of the United States Army, September 2007), 55.

⁶ There are five basic tasks included in Stability Operations: "Civil Security" - protecting the populace from external and internal threats. Security is essential to success; it provides for the basic safety of the force and populace and underpins the efforts of the other instruments of national power. "Civil Control" - regulating the behavior and activities of individuals and groups to reduce risk to individuals or groups and to promote security. Control channels the population's activity to allow for the provision of security and essential services while coexisting with a military force conducting operations. "Restore Essential Services" - essential services include emergency life saving medical care, the prevention of epidemic disease, provision of food and water, provision of emergency shelter from the elements, and the provision of basic

sanitation. "Support to Governance" - the provision of societal control functions that include regulation of public activity, rule of law, taxation, maintenance of security, control and essential services, and normalizing means of succession of power. "Support to Economic and Infrastructure Development" - direct and indirect military assistance to local, regional, and national economic and infrastructure development to provide an indigenous capacity and capability for continued economic and infrastructure development. U.S. Department of the Army, *Operations*, Field Manual 3-0 (Washington, D.C.: U.S. Department of the Army, 27 February 2006), 2-6.

⁷ LTC Howie Brewington, Chief, Requirements Branch, Force Management Directorate, Combined Arms Center, Fort Leavenworth, Kansas, "Future Theater Military Advisory and Assistance Group, Concept White Paper Draft," e-mail attachment to Dr. John Bonin, 3 December 2007, e-mail message to author, 4 December 2007, 2.

⁸ U.S. Department of the Army, *Counterinsurgency Operations*, Field Manual 3-24 (Washington, D.C.: U.S. Department of the Army, 15 December 2006), 2-9.

⁹ Brain McAllister Linn, *The Philippine War 1899-1902* (Kansas: University of Kansas Press, 2000), 30.

¹⁰ FM 3-07 Draft, 1-2.

¹¹ Michael Vigenas, *Rearming the French, United States Army in World War II, Special Studies* (Washington, D.C.: Office of the Chief of Military History, 1957), 231-235, 293-296; Charles F. Romanus and Riley Sunderland, *Time Runs Out in CBI* (Washington, D.C.: Office of the Chief of Military History, 1959), 231-238; and Marc Gallicchio, "Army Advisors and Liaison Officers and the Lessons of America's Wartime Experience in China," in *The US Army and World War II, Selected Papers from the Army's Commemorative Conferences*, ed. Judith L. Bellafaire (Washington, D.C.: Center of Military History, 1998), 363-364.

¹² Robert D. Ramsey III, *Advising Indigenous Forces: American Advisors in Korea, Vietnam, and El Salvador, Global War on Terror Occasional Paper #18* (Fort Leavenworth, Kansas: Combat Studies Institute Press, 2006), 1, 10.

¹³ John A. Nagl, *Learning to Eat Soup with a Knife* (Chicago: The University of Chicago Press, 2002), 116.

¹⁴ *Ibid.*, 125.

¹⁵ *Ibid.*, 128.

¹⁶ *Ibid.*, 129.

¹⁷ Robert Komer, *Bureaucracy Does Its Thing: Institutional Constraints on U.S.-GVN Performance in Vietnam* (Santa Monica, CA: RAND, 1973), 111.

¹⁸ Nagl, 165.

¹⁹ Komer, 115.

²⁰ Ramsey, 15.

²¹ Tom Washburn, "Bureau of Political-Military Affairs Office of International Security Operations," briefing slides, Washington D.C., U.S. State Department, 5 February 2008.

²² Herbert R. McMaster, "On War: Lessons to be Learned," *Survival: Global Politics and Strategy*, February 2008 [journal on-line]; available from <http://www.informaworld.com/smpp/title~content=t713659919>; Internet; accessed 17 February 2008.

²³ Robert M. Gates, Secretary of Defense, "Landon Lecture," Manhattan, Kansas, Kansas State University, 26 November 2007; available from www.defenselink.mil/speeches/speech.aspx?speechid=1199; Internet; accessed 14 December 2007.

²⁴ *Ibid.*, 5.

²⁵ FM 3-07 Draft, Figure 1-4, 1-6.

²⁶ George W. Bush, *National Security Presidential Directive 44, Management of Interagency Efforts Concerning Reconstruction and Stabilization* (Washington, D.C.: The White House, December 2005), 1.

²⁷ *Ibid.*, 1.

²⁸ John E. Herbst, "Civilian Stabilization Initiative: Building a USG Civilian Response Capability to Support Stabilization and Reconstruction Operations," briefing slides with scripted commentary, Washington, D.C., U.S. State Department, 5 February 2008.

²⁹ *Ibid.*, 4.

³⁰ Robin Wright, "Civilian Response Corps Gains Ground," *Washington Post*, 15 February 2008, p. 19.

³¹ Human Terrain Teams (HTTs) use history and social science to provide cultural awareness that support brigade level combat operations. HTT consists of the team chief, an area specialist, a social scientist, and a research manager.

³² Red Teaming is defined as: structured, iterative process executed by trained, educated and practiced team members that provides commanders an independent capability to continuously challenge plans, operations, concepts, organizations and capabilities in the context of the operational environment and from our partners and adversaries perspectives. U.S. Army Training and Doctrine Command (TRADOC), "Army Approves Plan to Create School for Red Teaming," 13 July 2005; available from <http://www.tradoc.army.mil/pao/tnsarchives/July05/070205.htm>; Internet; accessed 3 April 2008.

³³ Feickert, 8.

³⁴ Mark Gerner and Tim Zack, "Re-aligning and Rebalancing Civil Affairs and Psychological Operations Capabilities," Draft White Paper, 30 January 2008, 3.

³⁵ U.S. Army Combined Arms Center, “The Need for a Stability Operations and Training Assistance Proponent,” Dr. John Bonin, e-mail message to author, 18 February 2008.

³⁶ Fred Kaplan, “Secretary Gates Declares War on the Army Brass: Unfortunately He Doesn’t Have Time to Fight the Battle,” *Slate Magazine*, 12 October 2007, 2.

³⁷ *Ibid.*, 19.

³⁸ U.S. Department of Defense, *Irregular Warfare Joint Operating Concept (JOC), Version 1.0* (Washington, D.C.: U.S. Department of Defense, 11 September 2007), 15.

³⁹ U.S. Department of the Army, *Army Position Paper: Force Structure for Stability Operations* (Washington, D.C.: U.S. Department of the Army, 23 March 2007), 6.

⁴⁰ *Ibid.*, 6.

⁴¹ “Foreign Internal Defense” – Foreign internal defense (FID) is the participation by civilian and military agencies of a government in any of the action programs taken by another government or other designated organization, to free and protect its society from subversion, lawlessness, and insurgency. Commensurate with US policy goals, the focus of all US foreign internal defense (FID) efforts is to support the host nation’s (HN’s) program of “Internal Defense and Development (IDAD)”. These national programs are designed to free and protect a nation from subversion, lawlessness, and insurgency by emphasizing the building of viable institutions that respond to the needs of society. The most significant manifestation of these needs is likely to be economic, social, informational, or political; therefore, these needs should prescribe the principal focus of US efforts. The United States will generally employ a mix of diplomatic, economic, informational, and military instruments of national power in support of these objectives. Military assistance is often necessary in order to provide the secure environment for the above efforts to become effective. U.S. Department of the Army, *Special Forces Foreign Internal Defense Operations*, Field Manual 3-05.202 (Washington, D.C.: U.S. Department of the Army, 2 February 2007), 1-2.

⁴² U.S. Marine Corps, Special Operations Command (MARSOC), “Command Brief,” briefing slides, document provided to author by Dr. John Bonin, Professor, U.S. Army War College, April 2007.

⁴³ Feickert, 13.

⁴⁴ Feickert, 13.

⁴⁵ Gates, “Landon Lecture,” 4.

⁴⁶ Andrew F Krepinevich, Nadia Schadow, and Marin J. Strmecki, “Stability, Security Transition, and Reconstruction Operations: Meeting the Challenge,” briefing slides with scripted commentary, Washington D.C., U.S. Department of Defense Study, 1 December 2006.

⁴⁷ LTC Todd Goehler, “G-35-SSO Internal Study – Army Civil Affairs in Full Spectrum Operations,” briefing slides, Washington D.C., U.S. Department of the Army, 21 February 2008.

⁴⁸ *Ibid.*, 7.

⁴⁹ Ibid., 24.

⁵⁰ Ibid., 16.

⁵¹ Fawzia Sheik, "Army Opposes Permanent Advisor Corps to Train Foreign Forces," *Inside the Pentagon*, 13 September 2007, 22.

⁵² LTG Peter W. Chiarelli, "Learning From Our Modern Wars: The Imperatives of Preparing for a Dangerous Future," *Military Review*, September-October 2007, 4.

⁵³ Gates, "Landon Lecture," 4.

⁵⁴ Training and Doctrine Command Combined Arms Center, *Future Theater Military Advisory and Assistance Group*, White Paper Draft (Fort Leavenworth, KS: U.S. Army Training and Doctrine Command, Combined Arms Center, n.d.) 1. Document provided to author by Dr. John Bonin, Professor, U.S. Army War College, 12 December 2007.

⁵⁵ There are numerous names given to State Department personnel given the political sensitivities of the Host Nation. Names include "Military Group" MILGROU. Others include "Office of Defense Cooperation" (ODC); "Military Advisory and Assistance Group" (MAAG); "Office of Military Cooperation" (OMC); "Security Assistance Office" SAO; and Office of Defense Liaison" (ODL. In this paper, MILGROU represents all of these organizations.

⁵⁶ TRADOC, *Future Theater Military Advisory and Assistance Group*, 1.

⁵⁷ Ibid., 5.

⁵⁸ Ibid., 10.

⁵⁹ LTC Howie Brewington, Chief, Requirements Branch, Force Management Directorate, Combined Arms Center, Fort Leavenworth, Kansas, "Theater Military and Advisory and Assistance Group FDU," e-mail message to Dr. John Bonin, 22 March 2008, e-mail message to author, 24 March 2008.

⁶⁰ LTC Howie Brewington, Chief, Requirements Branch, Force Management Directorate, Combined Arms Center, Fort Leavenworth, Kansas, "EXSUM: Future Theater Military Advisory and Assistance Group (TMAAG-F) information brief to the CSA," e-mail message to Dr. John Bonin, 3 March 2008, e-mail message to author, 4 March 2008.

⁶¹ U.S. Marine Corps, *The Long War, Send in the Marines, A Marine Corps Operational Employment Concept to Meet An Uncertain Security Environment*. (Washington, D.C.: U.S. Marine Corps, January 2008), 16.

⁶² Ibid., 24.

⁶³ Ibid., 17.

⁶⁴ FM 3-05.202, 1-2.

⁶⁵ LTC Scott Morrison, "The Indirect Approach: An Existent Doctrinal Framework for Prosecution of the Long War," briefing slides, Washington D.C., U.S. Department of the Army, 28 February 2007, 5.

⁶⁶ FM 3-05.202, 1-2.

⁶⁷ *Ibid.*, 1-1.

⁶⁸ Indirect Approach - meeting security objectives by working with and through foreign partners. Direct Approach - meeting security objectives through the U.S.-led application of military power. FM 3-05.202, 1-3.

⁶⁹ *Ibid.*, 2-1.

⁷⁰ U.S. Department of Defense, *Joint Operations*, Joint Publication 3-0 (Washington, D.C.: U.S. Department of Defense, 17 September 2006), GL-28.

⁷¹ Thomas P. Galvin, "Extending the Phase Zero Campaign Mindset: Ensuring Unity of Effort," *Joint Force Quarterly* (2d Quarter 2007): 47.

⁷² Morrison, 24.

⁷³ Joint Center for International Security Force Assistance, *Security Force Assistance Proponency*, White Paper Draft (Fort Leavenworth, KS: Joint Center for International Security Force Assistance, n.d.), 1. Document provided to author by Dr. John Bonin, Professor. U.S. Army War College, 10 February 2008.

⁷⁴ Security Force Assistance consists of the following but is not limited to; Organize, man, train, equip, base and sustain Foreign Security Force (FSF) (DOTLM-PF); assist employment of FSF in support of campaigns and major operations; conduct traditional Foreign Internal Defense (FID) and Security Assistance (FMS, IMET, MTTs, etc); develop "Title X" capabilities by FSF; development of legislative and legal authorities by partner nations; integrate FSF into the broader interagency of the partner nation; Professionalize FSF as the legitimate forces of a partner nation. U.S. Department of the Army, *Counterinsurgency*, Field Manual 3-24 (Washington, D.C.: U.S. Department of the Army, December 2006), 6-9.

⁷⁵ COL Joe Gallagher, G3 Plans, TRADOC, Fort McPherson, Georgia, "The Need for a Stability Operations and Training Assistance Proponent," e-mail attachment to Dr. John Bonin, 14 February 2008, e-mail message to author, 14 February 2008, 3.

⁷⁶ Joint Center for International Security Force Assistance, *Security Force Assistance Proponency*, 2.

⁷⁷ U.S. Department of Defense, "U.S. Department of Defense on Irregular Warfare Directive – Planners Coordinating Draft" e-mail attachment to Dr. John Bonin, 11 March 2008, e-mail message to author, 12 March 2008, 7.

⁷⁸ Bureau of Political Affairs, "Report to Congress: Section 1206 of the 2006 National Defense Authorization Act," 3 July 2007; available from <http://www.fas.org/asmp/resources/110th/1206report.htm>; Internet; accessed 2 March 2008.

⁷⁹ Joint Center for International Security Force Assistance, *Security Force Assistance Proponency*, 2.

⁸⁰ DoD IW Directive, 5.

⁸¹ Joint Center for International Security Force Assistance, *Security Force Assistance Proponency*, 8.

⁸² *Ibid.*, 10.

⁸³ DoD IW Directive, 8.

⁸⁴ DoD IW Directive, 2

⁸⁵ Goehler, 12.

⁸⁶ *Ibid.*, 27-29.

⁸⁷ *Ibid.*, 12.

⁸⁸ *Ibid.*

⁸⁹ *Ibid.*

⁹⁰ General Creighton Abrams, Army Chief of Staff formulated the idea of the reformation of the first battalion-sized Ranger units since World War II. In January 1974, he sent a message to the field directing formation of a Ranger Battalion. He selected its missions and picked the first officers. He felt a tough, disciplined and elite Ranger unit would set a standard for the rest of the U.S. Army and that, as Rangers "graduated" from Ranger units to Regular Army units, their influence would improve the entire Army. This similar concept would be applied to Shaping and Stability operations with the employment of TMAAGs and Ministry Teams.

⁹¹ Joint Center for International Security Force Assistance, *Security Force Assistance Proponency*, 14.

⁹² Nagl, 171. Comments by Army Chief of Staff Johnson during Vietnam War in reference to U.S. advisors to the ARVN.

⁹³ General James L Jones, USMC, statement before the Senate Armed Services Committee, 7 March 2006, available from armed-services.senate.gov/statement/2006/March/Jones%2003-07-06.pdf; Internet; accessed 28 February 2008.

⁹⁴ United States Army Security Assistance Command, "About Us," available from <http://www.usasac.army.mil/About/about.htm>; Internet; accessed 17 March 2008.

⁹⁵ United States Training and Doctrine Command, Security Assistance Training Directorate, "Welcome to - U.S. Army Security Assistance Training," available from <http://www.tradoc.army.mil/dcsopst/satfa/>; Internet; accessed 17 March 2008.

⁹⁶ *Ibid.*

⁹⁷ Dr. John Bonin and COL Scott Wuestner, "Organizing for Security Force Assistance," briefing slides, Carlisle Barracks, U.S. Army War College, 13 July 2007, 14.

⁹⁸ Ibid., 15, 19.

⁹⁹ COL Sean Ryan, "Joint Center for International Security Force Assistance," briefing slides, Fort Leavenworth, KS: Joint Center for International Security Force Assistance, 10 March 2007.

¹⁰⁰ Bonin and Wuestner, 16.

¹⁰¹ Ibid., 18.

¹⁰² Ibid., 48.

¹⁰³ Herbst, 4.

¹⁰⁴ Herbst, 6.

¹⁰⁵ Bonin and Wuestner, 48.

¹⁰⁶ Ibid., 26.

¹⁰⁷ Ibid., 29.

¹⁰⁸ Ibid., 31.

¹⁰⁹ Ibid., 32.

¹¹⁰ Ibid., 35.

¹¹¹ Joint Center for International Security Force Assistance, *Security Force Assistance Proponency*, 12.

¹¹² Pete Geren and George W. Casey, *A Campaign Quality Army with Joint and Expeditionary Capabilities: Army Posture Statement, Fiscal Year 2008*. Posture statement presented to the 110th Cong., 2d sess. (Washington, D.C.: U.S. Department of the Army, 2008), 2.

