

Morphing Aircraft Technology – New Shapes for Aircraft Design

Terrence A. Weisshaar¹
 Aeronautics and Astronautics Department
 Purdue University
 West Lafayette, Indiana 47907
 USA

1.0 THE MORPHING CHALLENGE

Morphing aircraft are multi-role aircraft that change their external shape substantially to adapt to a changing mission environment during flight.² This creates superior system capabilities not possible without morphing shape changes. The objective of morphing activities is to develop high performance aircraft with wings designed to change shape and performance substantially during flight to create multiple-regime, aerodynamically-efficient, shape-changing aircraft.

Compared to conventional aircraft, morphing aircraft become more competitive as more mission tasks or roles are added to their requirements. This paper will review the history of morphing aircraft, describe a recent DARPA program, recently completed, and identify critical technologies required to enable morphing.

As indicated in Figure 1, designing and building aircraft shape changing components is not new. In the past, aircraft have used variable sweep, retractable landing gear, retractable flaps and slats, and variable incidence noses. However, recent work in smart materials and adaptive structures has led to a resurgence of interest in more substantial shape changes, particularly changes in wing surface area and controlled airfoil camber.



Figure 1: Morphing aircraft design components.

¹ Formerly, Program Manager, DARPA Defense Sciences Office, Arlington, Virginia, USA.

² Morphing aircraft are also known as variable geometry or polymorphous aircraft.

Weisshaar, T.A. (2006) Morphing Aircraft Technology – New Shapes for Aircraft Design. In *Multifunctional Structures / Integration of Sensors and Antennas* (pp. O1-1 – O1-20). Meeting Proceedings RTO-MP-AVT-141, Overview 1. Neuilly-sur-Seine, France: RTO. Available from: <http://www.rto.nato.int/abstracts.asp>.

Report Documentation Page

Form Approved
OMB No. 0704-0188

Public reporting burden for the collection of information is estimated to average 1 hour per response, including the time for reviewing instructions, searching existing data sources, gathering and maintaining the data needed, and completing and reviewing the collection of information. Send comments regarding this burden estimate or any other aspect of this collection of information, including suggestions for reducing this burden, to Washington Headquarters Services, Directorate for Information Operations and Reports, 1215 Jefferson Davis Highway, Suite 1204, Arlington VA 22202-4302. Respondents should be aware that notwithstanding any other provision of law, no person shall be subject to a penalty for failing to comply with a collection of information if it does not display a currently valid OMB control number.

1. REPORT DATE 01 OCT 2006		2. REPORT TYPE N/A		3. DATES COVERED -	
4. TITLE AND SUBTITLE Morphing Aircraft Technology New Shapes for Aircraft Design				5a. CONTRACT NUMBER	
				5b. GRANT NUMBER	
				5c. PROGRAM ELEMENT NUMBER	
6. AUTHOR(S)				5d. PROJECT NUMBER	
				5e. TASK NUMBER	
				5f. WORK UNIT NUMBER	
7. PERFORMING ORGANIZATION NAME(S) AND ADDRESS(ES) Aeronautics and Astronautics Department Purdue University West Lafayette, Indiana 47907 USA				8. PERFORMING ORGANIZATION REPORT NUMBER	
9. SPONSORING/MONITORING AGENCY NAME(S) AND ADDRESS(ES)				10. SPONSOR/MONITOR'S ACRONYM(S)	
				11. SPONSOR/MONITOR'S REPORT NUMBER(S)	
12. DISTRIBUTION/AVAILABILITY STATEMENT Approved for public release, distribution unlimited					
13. SUPPLEMENTARY NOTES See also ADM202433., The original document contains color images.					
14. ABSTRACT					
15. SUBJECT TERMS					
16. SECURITY CLASSIFICATION OF:			17. LIMITATION OF ABSTRACT	18. NUMBER OF PAGES	19a. NAME OF RESPONSIBLE PERSON
a. REPORT unclassified	b. ABSTRACT unclassified	c. THIS PAGE unclassified			

Morphing Aircraft Technology – New Shapes for Aircraft Design

Morphing aircraft design features reconcile conflicting mission requirements so that an aircraft can perform several mission functions or roles. These functions could be as simple as being able to use a small engine but land and take off from a short length field. These conflicting requirements make landing flaps appear on wings to increase area and lift coefficient at low speed, despite the increased weight that they add to the system. If morphing devices are not added then the wing design is compromised so that the aircraft may do one thing very well, but have problems executing other parts of the mission.

Figure 2 shows a notional diagram with the operational loiter/high speed dash capabilities of different airplane designs plotted as points in the loiter time/high speed dash speed design space. Each point on the plot represents a different outer mold line geometry and engine/fuel/weight combination. In general, the requirement for high speed dash reduces the designer's ability to provide long loiter times.

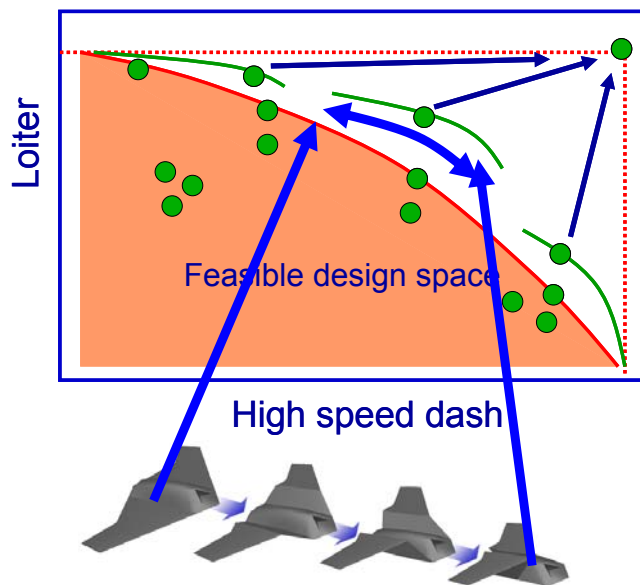

Figure 2: Design space with conflicting objectives. Points represent feasible designs for different combinations of conflicting goals. Curved line represents range of performance with morphing.

Shape changing features provides a wing that will increase its wing area, sweep angle or span. For instance, the short curved lines in Figure 2 represent an aircraft that changes its wing sweep angle during flight to allow it to have long loiter time, but also efficient dash speed.

The ideal morphing airplane is represented as a single point in the upper right corner of Figure 2. This aircraft has the ability to change outer mold line shape so drastically that it fulfills extreme mission requirements by simply changing shape to match shape to required performance. The ability to change aircraft form and function was the goal of DARPA's Morphing Aircraft Structures (MAS) program, managed by DARPA's Defense Sciences Office (DSO).

2.0 THE DARPA MORPHING AIRCRAFT STRUCTURES PROGRAM

It is one thing to draw a morphing wing design or to calculate shape changing wing performance. It is quite another to conceive, design, build and operate shape changing designs, particularly when the geometrical shape changes are large. In January 2003 the Defense Advanced Research Projects Agency, DARPA, began a 2 ½ year program whose objective was to design and build active, variable-geometry, wing structures with the ability to change wing shape and wing area substantially.

The MAS program had two primary technical goals:

- 1) To develop active wing structures that change shape to provide a wide range of aerodynamic performance and flight control not possible with conventional wings.
- 2) To enable development of air vehicle systems with fleet operational effectiveness not possible with conventional aircraft. This includes both Navy and Air Force operations.

The MAS effort was an extension of activities that began more than a decade ago with DARPA's development of smart materials and devices; this effort was led by Dr. Robert Crowe, then a Program Manager in the DARPA/Defense Sciences Office (DSO). He followed this with demonstration projects such as the Smart Wing Program, SAMPSON (an advanced inlet morphing program), and the Smart Rotor Program. The Compact Hybrid Actuator Program (CHAP) was developed by Dr. Ephraim Garcia during his tenure as a DARPA Program Manager.

Three contractors--Lockheed-Martin (Palmdale, California), Hypercomp/NextGen (Torrance, California) and Raytheon Missile Systems (Tucson, Arizona)--were competitively selected in April 2002 for a 12-month Phase 1 effort to develop wing morphing concepts that would lead to radically different, transitionable air vehicles. All three MAS contractors adopted a systems approach and conducted a functional analysis that concluded that changing wing planform area (to allow a wide range of wing loadings in flight) and wing span were the primary enablers of a new class of morphing air vehicles.

3.0 MAS DESIGNS

The MAS missions considered by the three contractors were structured to provide general system performance for:

- Responsiveness – time critical deployment with the ability to respond to unpredictable crisis situations
- Agility – the ability to attack fast moving air and ground targets
- Persistence – the ability to dominate large operational areas for long time periods

Each of the three contractors used a systems level approach to define combinations of range and loiter requirements to produce a system of Hunter-Killer Unmanned Air Vehicles (UAV's) or cruise missiles with range/loiter capability far greater than current or planned systems.

The Hypercomp/NextGen design, shown in Figure 3, used substantial in-plane shape changes and surface area reduction to transform the wing from an efficient, high-aspect-ratio loiter shape to an efficient, swept, reduced-wing-area transonic, low altitude dash shape.

Morphing Aircraft Technology – New Shapes for Aircraft Design

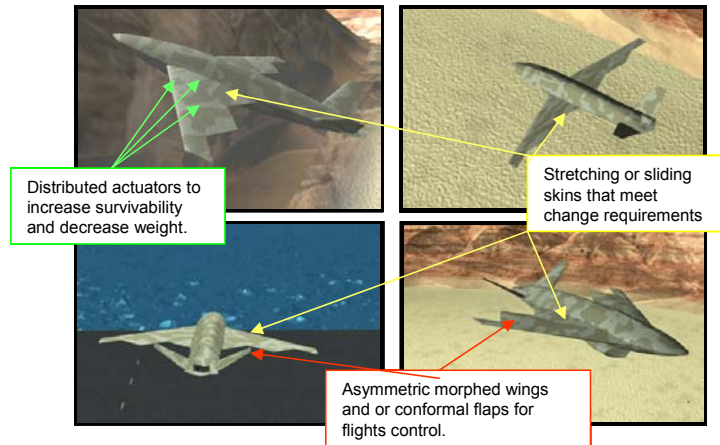

Figure 3: NextGen morphing design.

Figure 4 shows the Lockheed-Martin design in its morphed and unmorphed configurations. This innovative design “hides” a substantial portion of the wing area during the low altitude, transonic dash portion of its mission. This design also requires substantial use of advanced skin materials to maintain surface smoothness for aerodynamic efficiency when the wing folds in flight.



Figure 4: Lockheed-Martin Agile Hunter morphing design.

Figure 5 shows the Raytheon telescoping wing design in its morphed and unmorphed configurations. This design addresses a unique challenge since the wing loading is large (of the order of 250 pounds per square foot) and the available volume for actuators and support structure is small.

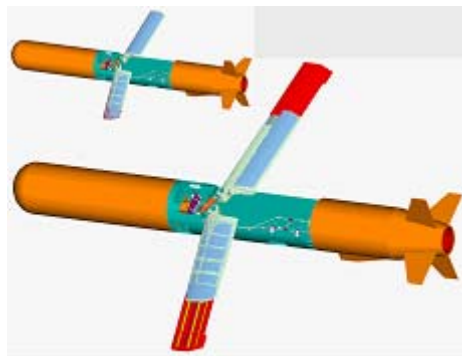

Figure 5: Raytheon morphing wing design.

Controlling aerodynamic drag with shape change is at the heart of morphing. Drag depends on the total surface area exposed to the flow and the span loading - defined as aircraft weight per wing span. Changing these geometric features in flight is essential for efficient aircraft operation. To understand more about this, let's look at airplane drag in the subsonic flight regime.

4.0 CONTROLLING AERODYNAMIC DRAG

For a conventional subsonic aircraft, flying below transonic speeds, the maximum L/D is estimated as

$$\left(\frac{L}{D}\right)_{\max} = \frac{b}{2} \sqrt{\frac{\pi e}{S_{wet} C_f}} \quad (1)$$

The ratio of the unmorphed to the morphed L/D ratios is

$$\frac{\left(\frac{L}{D}\right)_{\max}}{\left(\frac{L}{D}\right)_{\max}^*} = \frac{span}{span^*} \sqrt{\frac{S_{wet}^*}{S_{wet}}} \quad (2)$$

While this maximum value of L/D is a strong function of vehicle shape, the actual value of L/D, and drag in particular, is also dependent on weight, airspeed and altitude. Aerodynamic drag for an airplane with weight W , operating at a *subsonic* flight speed V and an altitude with an air density ρ is written as

$$Drag = thrust\ required = q C_f S_{wet} + \left(\frac{1}{q \pi e}\right) \left(\frac{W}{b}\right)^2 \quad (3)$$

In this equation $q = \rho V^2 / 2$, C_f is the skin friction coefficient, S_{wet} is the total wetted area (fuselage, tails, wings), e is a parameter called the Oswald efficiency factor for the wing (a fraction close to unity) and b is the wing span. The first term is called the parasite drag and approximates the effects of skin friction. It does not include items such as wave drag or pressure drag. The second term is the induced drag or “drag due to lift.”

Parasite drag results from friction in the thin boundary layer surrounding the aircraft surface and a pressure drag component generated by flow separation from protuberances such as small antennas or discontinuities in outer surfaces. For airplanes designed for high speed flight, the parasite drag (including wave and pressure drag components) is so important that minimizing the surface area – smaller wings, for instance – is a prime concern.

Lift is created by vortex action set up by flow over and around a wing. The stronger the vortex system the larger the lift. *Induced drag* comes from the strong vortices shed from wing tips. Reducing induced drag component requires wings with large span. Induced drag is proportional to the inverse of q . As a result, the importance of induced drag decreases with increasing airspeed.

Let's consider the history of morphing aircraft to understand why DARPA is involved in an ancient quest for efficient flight and why they now have a chance to succeed where others have failed.

Morphing Aircraft Technology – New Shapes for Aircraft Design

5.0 ORIGINS OF THE MORPHING AIRCRAFT CONCEPT

Even before the official beginning of controlled human flight in 1903, radical shape changing aircraft appeared and then disappeared, contributing little to aviation.

Clement Ader conducted flight experiments in France as early as 1873 and proposed a wing morphing design as early as 1890, as indicated in Figure 6. He developed ideas for the future of aviation for warfare beginning in the 1890's and described them in a short monograph published in 1909. He advocated three basic types of aircraft as parts of future military air fleets: *Scouts*, *Bombers* and *Airplanes of the Line*. Consider his description of the general military airplane and in particular, the Scout aircraft:

“Whatever category airplanes might belong to, they must satisfy the following general conditions: their wings must be articulated in all their parts and must be able to fold up completely... When advances in aircraft design and construction permit, the frames will fold and the membranes will be elastic in order to diminish or increase the bearing surfaces at the wish of the pilot...”

The Scouts will be designed according to their function...everything should be sacrificed in the interest of speed and flying long distances. Their wings will be bat-type or preferably bird type, long and narrow, with the minimum of surface and hence a heavy load for each square meter. Moreover the wings will be adjustable, so that in flight they can be reduced by a half or a third or even less...Armament will be nonexistent or very little...The real weapon will be speed.”

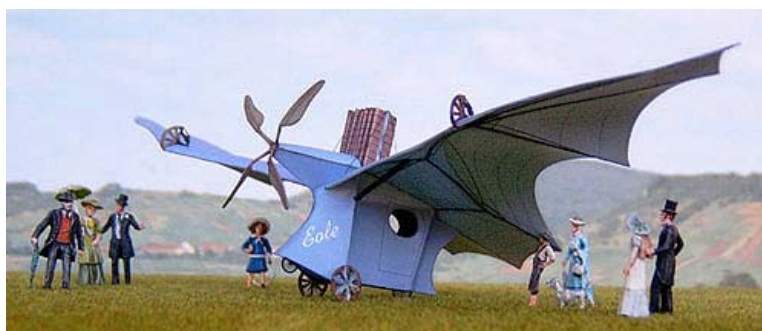

Figure 6: Clement Ader's *Eole* – a shape changer in 1890.

Ader describes his Airplanes of the Line as follows:

“The wings will be extendable in flight and their surface will be increased or decreased at will. These airplanes will be characterized by their agility but will also be of solid construction. To strengthen their framework, both in bat and bird-type construction I propose to make some of them of metal, following experiments and plans already made. Because these airplanes will be stored in great numbers, their wings will fold up completely with great ease...”

Morphing aircraft are also known as *variable geometry* or *polymorphous* aircraft. The first experiments with in-flight variable geometry were allegedly conducted in 1911 in France, although no record survives. In April 1914 Edson F. Gallaudet of Norwich, Connecticut applied for a patent for a “variable skewed” wing and was granted the patent in October 1916.³ This configuration was intended to improve controllability and variable sweep was an alternative to ailerons.

³ “The Annals of the Polymorph-A Short History of V-G,” *Air International*, March 1975, pp. 134-140

G.T.R. Hill's design of the Pterodactyl IV tailless monoplane, shown in Figure 7, drew attention to variable sweep tailless aircraft. This airplane, first flown in 1931, had a variable sweep range between 4 and 75 degrees, enabled by a mechanical worm and wheel arrangement driving hinged wings in-plane to change sweep angle.



Figure 7: Pterodactyl variable sweep wing.

Ivan Makhonine, an expatriate aircraft designer from the Soviet Union, began to produce serious variable geometry wing designs in the 1930's. He developed the telescoping wing MAK-10 that first flew in August 1931. The telescoping wing design concept has appeared in many different designs since then.

Makhonine's telescoping wing had three major parts that slid over each other to change the wing span and area: in operation, this airplane changed wing span 162% (from 13 meters to 21 meters) while the wing area changed 157% (from 21 to 33 square meters). Pneumatic actuators provided the energy for extension and contraction. The wing loading was about 30 lb/square ft and the airplane was considered to be underpowered, with a maximum speed of 186 mph with the wings retracted and 155 mph with the wings fully extended. Makhonine designed other successful variable-geometry aircraft. His last, the MAK-123, was first flown in 1947 in France and demonstrated extension retraction of telescoping wings with no adverse effects.

The MAK-10 inspired designers Georges Bruner and Charles Gourdou to design a small aircraft named the G-11 C-1. Apparently this airplane was never built, but its design had a wing whose area could range between 11.4 and 17.2 square meters with spans between 6.76 and 11.4 meters. Range was predicted to be 466 miles at 310 mph with outer wing panels retracted and 1243 miles at 149 mph with wing panels extended. In the end, the two designers determined that this telescoping scheme was impractical for an airplane as small as theirs and they abandoned their idea.

The Bakshev LIG-7, an unusual and innovative morphing aircraft with two-dimensional in-plane operation, was developed in the Soviet Union in 1937.⁴ This aircraft, shown in Figure 8, had a high-aspect-ratio, thin wing designed for cruising flight. For take-off and landing, six broad-chord wing sections were extended from the fuselage to 2/3 of the wingspan. Each wing section, 50 cm. wide, was made of plywood, with a support rib on the inboard side and a light frame on the outboard side. The telescoping wing sections were retracted and extended by tensioned steel wires, operated manually from the cockpit. All retractable sections were completely hidden inside the fuselage when retracted.

⁴ There are two ways to change wing area: (1) in-plane distortion such as Ader used on the Eole, a two-dimensional surface movement to change the wing sweep, span or chord; and 2) out-of-plane, three dimensional surface movement involving segmented surface rotation. Wing area change requires "hiding" or creating areas within the fuselage or on the wing surface by using local wing skin stretching or by building a collection of sliding surfaces, such as telescoping chordwise or spanwise segments. This requires an increase or decrease of component cell surface area with a collection of internal mechanisms that move freely with pre-planned motions under substantial external surface air loads.

Morphing Aircraft Technology – New Shapes for Aircraft Design

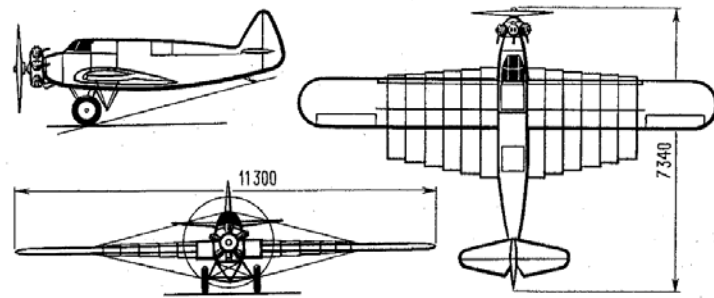

Figure 8: Bakshaev LIG-7.

Ailerons were located on the outer one-third of the wing span. During 1937, flight tests showed that wing retraction (requiring from 20 to 30 seconds) and extension (requiring from 30 to 40 seconds) was easier to perform in-flight than it was on the ground. No handling peculiarities were observed.

According to observers, the effect of morphing on take-off and landing characteristics was impressive and reliable. On the other hand, the morphing impact on performance was not as significant as for this small and slow aircraft (the wing contributed only 20% of total drag).

The IS-1 fighter, designed by Nikitin-Shevchenko in 1932, morphed out-of-plane from a bi-plane to a monoplane that was to operate at high speed.⁵ Like the modern Lockheed-Martin DARPA MAS design, most of the lower wing folded into the fuselage to reduce the wetted area to create a design that resembled a monoplane with a small canard surface.

The XB-70 supersonic bomber also used a form of three-dimensional wing morphing. This design, shown in a frontal view in Figure 9, and in flight in the upper left corner of Figure 10, used outer wing panel rotation to control L/D at both low subsonic and supersonic speeds.

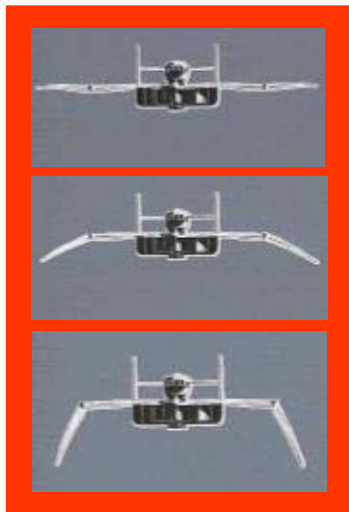

Figure 9: XB-70 Bomber.

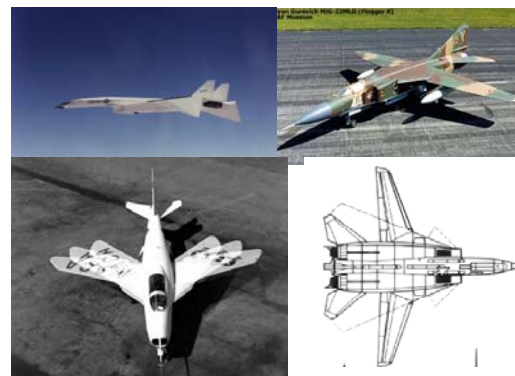

Figure 10: “Modern” variable geometry aircraft.

⁵ Three dimensional morphing designs require out-of-plane wing segment rotation or folding. Wing surface area can be changed discontinuously as one segment folds into another or folds into the fuselage in a gull-like, hinged motion seen on the Lockheed-Martin design.

Morphing Aircraft Technology – New Shapes for Aircraft Design

The most successful morphing wing aircraft today use variable sweep wing design. A favorable trade between increased mission effectiveness and the high weight central pivot mechanisms required to sweep the wing in-plane make it attractive from a performance perspective.

Figure 10 shows four examples of modern variable geometry aircraft. The Bell- X-5 (lower left) was the first jet powered aircraft with variable geometry wings to connect efficient low speed flight with efficient high speed flight. This aircraft was followed by the F-111 (lower right) and F-14 fighter aircraft and, later, by the B-1 bomber. Variable sweep was also used on the Soviet Union's Tupolev-22 (Blackjack) supersonic bomber and the MiG-23 fighter (upper right).

In addition to the added weight of pivots for variable sweep wings, leading and trailing edges must be housed within a cavity in the fuselage. Many designs use air-inflated bags so that there is an aerodynamic seal and a smooth external contour when the wing is positioned at minimum sweep. There is also increased complexity due to the fact that the airplane must be trimmed at different wing sweep angles.⁶

The variable sweep concept comes closest to the present day morphing wing concepts as far as objectives are concerned. The interest in variable geometry wings in the 1950's and 60's arose because of aerodynamically dissimilar mission objectives. These objectives were:

- Long-range subsonic cruise or long endurance on station
- High supersonic speed interception and low-altitude transonic strike
- Operation from limited length runways (or aircraft carriers)

Without independent wing size change for each of these mission requirements, the fixed-wing compromise is nearly always heavier than a variable-geometry, morphing wing. The issue however, is the amount of added complexity and cost required to knit these mission segments together. Figure 11 shows the vortex generator in front of the wing cavity for the variable sweep F-111 aircraft.



Figure 11: F-111 aircraft with vortex generator (circled) deployed to improve flow over wing gap.

Early designs, such as the Bell X-5 and the Grumman XF10F Jaguar shown in Figure 12, placed the wing pivot near the wing root. This reduced the wing wave drag at high speeds, but also introduced a large of a larger tail to control the nose-down pitch introduced by aft aerodynamic center movement. This aft movement became even worse when the aircraft flew into the supersonic regime.⁷

⁶ Ray Whitford (*Design for Air Combat*, Jane's Information Group, 1989, pp. 72) cites evidence of the attractiveness of variable sweep for the Grumman F-14. Grumman pursued a fixed wing F-14 design and tried to reconcile the conflicting requirements of high maximum Mach number, subsonic loiter and carrier suitability but found that this required a larger wing area and a higher thrust to weight ratio, making the fixed wing design considerably heavier (about 4500 lbs. heavier).

⁷ The test pilot of the Jaguar was quoted as saying "The cockpit was difficult to get into. It should have been impossible."

Morphing Aircraft Technology – New Shapes for Aircraft Design



Figure 12: Grumman XF10F Jaguar – 1952.

The Bell X-5 actually used an internal rail system within the fuselage. When the wing was swept back, the pivot moved forward to partially compensate for the aerodynamic center shift. This required a heavy mechanism and a larger fuselage (with larger parasite drag). The NACA later developed an outboard pivot with a glove area inboard to minimize the aerodynamic center travel by redistributing the longitudinal lift distribution as the wing was swept.⁸

The Mission Adaptive Wing project produced wing camber changing concepts and a flight demonstrator, the AFTI/F-111, shown in Figure 13. While wing camber is not considered to be a basic vehicle sizing design parameter (it does not appear explicitly in the drag equations), camber controls important features of wing aerodynamic performance such as low speed performance and transonic drag rise.



Figure 13: AFTI/F-111 experimental aircraft.

Even single mission aircraft must operate at a wide range of altitudes, weights and flight speeds. Variable camber has been shown to improve performance of fighter aircraft at all flight conditions. The F-16 and F-18 aircraft use discrete leading edge and trailing edge flap deflections to control camber, although imperfectly.

The Mission Adaptive Wing (MAW) supercritical airfoil camber was controlled to create optimum camber over a range of airspeeds for low subsonic to supersonic. This control was achieved by continuously deformable leading and trailing edge deflection using internal mechanisms to bending the chordwise shape as required. This allows the wing to be a continuous surface at all times, unbroken by discrete surfaces.

⁸ Whitford notes that British designers still favored the inboard pivot location because the fully swept wing area and the span became smaller were the wing was swept. This helped the high speed flight requirement and trim drag penalties “were not particularly acute for combat aircraft using full sweep only for supersonic dash or low-altitude, high-speed penetration of limited duration.”

An arrangement of internal rods and linkages, powered by hydraulic actuators, allows the mechanism to bend the wing into different chordwise shapes, as indicated in Figure 14. Tests conducted in the 1980's verified the aerodynamic performance of the wing with its adjustable drag polar. The question of whether the wing weight added provided value that could not be obtained with conventional surfaces remains a subject of controversy.

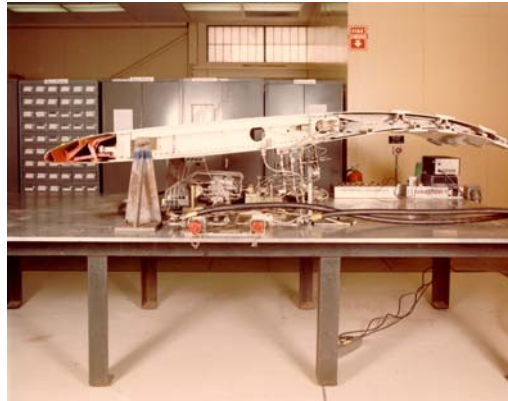

Figure 14: MAW airfoil cross-section in its deformed, cambered position.

What is not in question is the remarkable success of the MAW demonstration. The tests and the innovative process itself encouraged designers to think about compliant structures that could be shaped and molder in flight. The MAW structure had never been designed to be bent or twisted and, as a result, the actuators to re-camber the structure were larger than they might otherwise have been. A negative aspect of the MAW success is that, when the term “morphing wing” is mentioned in technical venues, camber change is assumed. This is not accurate since camber changing is only a small sub-set of morphing objectives.

Sailplane wing designs illustrate another morphing wing example that is a more broad aspect of wing morphing. Sailplane designs have reached a high level of maturity.⁹ Since sailplanes are highly evolved, competition is won by superior pilot skill with reasonably equivalent airplanes. However, the quest for any measure of airplane superiority is highly competitive. One approach has been to match the wing to the flight conditions that the sailplane pilot encounters.

The German fs-29 glider, shown in Figures 15 and 16, was designed with a telescoping wing to improve soaring performance.¹⁰ “Performance soaring” requires an aircraft to cover a given distance in the shortest possible time. To do this, the sailplane must operate at two different speeds, depending on whether it is in the cruise or climb mode. Designers use camber changing flaps and water ballast to improve performance as they move from one mode of flight to the other. The disadvantage of ballast is that, like fuel, once it is gone, it is gone.

⁹ John McMasters notes, in a 1980 article, that “...we have a machine of almost standardized shape. It is characterized by a long slender fuselage of minimum cross-sectional (frontal) area; a narrow high-aspect-ratio wing of superb smoothness and devious contour; and an aft mounted empennage designed as a careful balance between minimum size, adequate stability and control, and good taste. At this level, all sailplanes look alike and are white. This recipe (except for whiteness) was settled on once and for all over forty years ago, and no one has yet demonstrated a better one.” (“Advanced Concepts in Variable Geometry Sailplanes,” *Soaring*, April 1980, pp. 26-29.)

¹⁰ Peter Lert, “The fs-29, a telescoping wing sailplane,” *Soaring*, January 1976, pp. 21-27.

Morphing Aircraft Technology – New Shapes for Aircraft Design



Figure 15: German fs-29 sailplane.

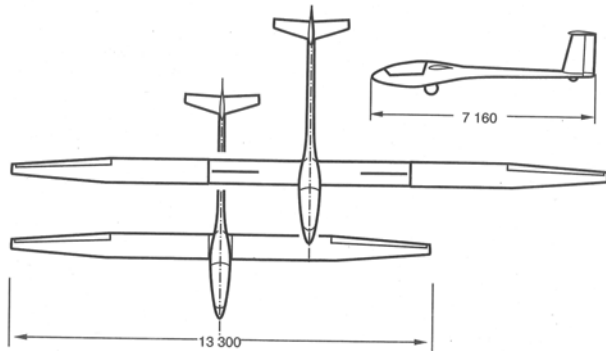

Figure 16: fs-29 planform geometry and side view.

The alternative is to change wing loading in flight by changing the wing area, either by changing the wing chord or the wing span. The ability to effect chord changes, such as using a Fowler flap¹¹ to increase wing area by changing the wing chord for low speed flight, has been around for years. However, employing this chord-changing design strategy reduces aspect ratio and increases the induced drag slightly when it is used in circling flight maneuvers to gain altitude in a thermal. This increased drag is less of a problem in low speed flight.

Telescoping wings increase the wing span and wing area. The key to their success is a structure that can be contained inside a host structure and then deployed when needed. This structure must resist binding under load, particularly under the action of wing deflections that are relatively large for highly loaded, efficient, light-weight structures. A second requirement is power and actuators to drive the system. The fs-29 uses pilot cranking to extend or retract the wing outer surfaces.¹²

The morphing aircraft concept was revived at NASA/Langley Research Center in the mid-1990's and continues today as part of NASA's Breakthrough Vehicle Technologies Project. The goal of the NASA Morphing Project, led by Ms. Anna McGowan, is to develop component technologies that enable aerodynamic surface shape change and that can be integrated into efficient air vehicles to provide a wide range of capabilities.

6.0 MORPHING DESIGN SPACE – TO MORPH OR NOT TO MORPH – THAT IS THE QUESTION

Two essential elements must combine if morphing wings are to succeed. First of all, there must be a strong case for new military capabilities that will occur as the result of new aircraft development. Second, there must be technology solutions for the perceived need. These two elements are not independent since need creates technology and technology suggests capabilities.

In the technology area, four elements must be combined to work together to create a morphing wing structure: sensors to measure positions; control systems to convert the measurements into an activation signal; actuation mechanisms to provide mechanical motion and precise positioning; and efficient power sources to drive actuation.

¹¹ A Fowler flap, like other high lift devices, deflects to provide increased lift. It also extends aft on a set of tracks and is a complex and heavy "morphing system." It is not unusual to have the flap extend 20% of the wing chord. These flaps cover only a small portion of the wing span.

¹² An excellent discussion of sailplane design and performance (as well as Figure 16) is provided by Fred Thomas, *Fundamentals of Sailplane Design* (translated by Judah Milgram), College Park Press, 1993.

One common way to describe an aircraft design is to plot wing loading against thrust loading, as shown in Figure 17. Wing loading (W/S) is defined as take-off gross weight (TOGW) divided by a reference wing area; thrust loading (T/W) is defined as the ratio of total engine thrust at sea level divided by TOGW. Figure 15 indicates that aircraft types operate best for narrow ranges of wing loading. As indicated in Figure 16, wing loading changes are required if an aircraft function is to move from one role to another.

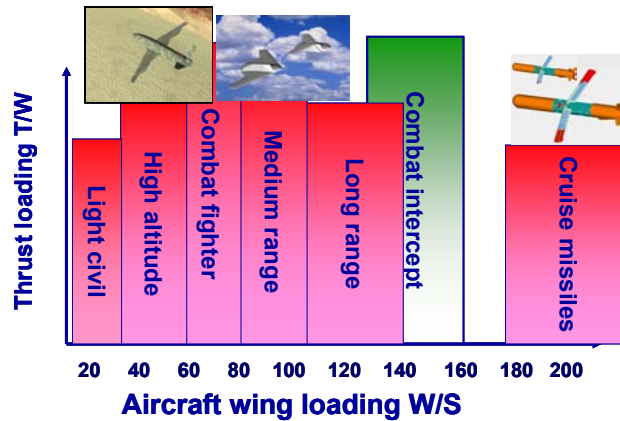

Figure 17: Typical wing loading ranges for different aircraft categories.

Wing loading is one of five basic aerodynamic features that strongly influence aircraft performance. In addition to wing loading, these five include: wing thickness-to-chord ratio (t/c); wing taper; wing span; and wing sweep. With engine thrust and aircraft gross weight held constant, wing area changes ranging from 20% to 50% may be required to move from a high altitude aircraft to a combat fighter class aircraft. Even more drastic changes are required to morph from a high altitude loitering aircraft to a low altitude high speed aircraft.

7.0 WEIGHING DESIGN ALTERNATIVES

Historically, the added complexity and weight required for morphing have not paid for themselves in terms of system performance. A simple analysis can shed light on the trades that apply to morphing technologies. Aircraft weight is the sum of three basic component weights.

$$W_{TOGW} = W_{empty} + W_{fuel} + W_{payload} \tag{4}$$

The expression for empty weight is approximated as

$$W_{empty} = mW_{TOGW} + \delta + \Delta W_{morph} \tag{5}$$

The parameter δ is the weight associated with non-payload/take-off-gross-weight independent flight articles such as avionics packages or bomb racks. The third term is the weight added for morphing structural modifications such as mechanisms, actuators to operate mechanisms and added structure required to morph.

The parameter “m” is a weight fraction associated with a particular class of aircraft and will be affected – over decades – by the ability to manufacture and operate highly efficient aircraft. For instance, the introduction of advanced composite materials should reduce the value of m. As shown in Table 1, long range bombers have different values of m than short range fighters.

Morphing Aircraft Technology – New Shapes for Aircraft Design

Table 1: Weight fractions, m

Vehicle class	m
Military bomber	0.35
Jet fighter	0.50
Jet transport	0.44
Twin turbo-prop	0.56
Flying boat	0.67
Homebuilt	0.45

Mission fuel weight is estimated for a mission with a cruise and a loiter segment as

$$W_{fuel} = \bar{W}_{fuel} W_{TOGW} = W_{TOGW} (1 - e^{-t} e^{-r}) \quad (6)$$

The exponents r and t are related to mission requirements and written as

$$r = \frac{Range * SFC}{airspeed * E} = \frac{Rc_j}{V \left(\frac{L}{D}\right)_{cruise}} \quad (7)$$

and

$$t = \frac{loiter\ time * SFC}{E} = \frac{T_L c_j}{\left(\frac{L}{D}\right)_{loiter}} \quad (8)$$

with $E = \frac{L}{D}$ $SFC = c_j$ is the *thrust specific fuel consumption* of the engines, given in pounds of fuel per hour per pound of thrust (units are 1/hour). SFC is a function of altitude and engine RPM, but not of the number of engines.

If the cruise airspeed, V , is specified then the ratio $\frac{R}{V} = T_{cruise} = T_C$ and

$$r = \frac{T_C c_j}{\left(\frac{L}{D}\right)_{cruise}} \quad (9)$$

Solving for the take-off-gross-weight with these two primary mission segments gives

$$W_{TOGW} \cong \frac{\delta + W_{payload}}{e^{-r} e^{-t} - m - f_{morphing}} \quad (10)$$

where $\Delta W_{morph} = W_{TOGW} f_{morphing}$. Equation 10 is called the “existence equation.” The denominator must be greater than zero for the predicted take-off-gross-weight to be a positive number. Even then the weight predicted may be unacceptably large.

In the ideal case, the addition of morphing technology should not increase the take-off gross weight if it leads to increased mission performance. To pay for itself, the morphing technology must provide the following improvements in performance, compared to its cost in weight.

$$e^{-r} * e^{-t} - m \leq e^{-r^*} * e^{-t^*} - m - f_{morphing} \quad (11)$$

or

$$e^{-r} * e^{-t} + f_{morphing} \leq e^{-r^*} * e^{-t^*} \quad (12)$$

The (*) quantities on the right hand side of Equation 12 are calculated for the morphing vehicle.

The technology “cross-over point” is found by setting both sides equal to each other in Equation 12 and then taking the natural log of both sides (and using the approximation $\ln(a + b) \cong \ln(a) + \frac{b}{a}$ when $\frac{b}{a} \ll 1$). This gives

$$r + t - \frac{f_{morphing}}{\beta} = r^* + t^* \quad (13)$$

where $\beta = e^{-r} e^{-t}$. Solving for the morphing aircraft loiter time, with $E = \frac{L}{D}$, gives

$$\left. \frac{T_L c_j}{E_L} \right|_{morphing} = \left. \frac{T_C c_j}{E_C} \right|_{conventional} - \left. \frac{T_C c_j}{E_C} \right|_{morphing} + \left. \frac{T_L c_j}{E_L} \right|_{conventional} - \frac{f_{morphing}}{\beta} \quad (14)$$

Let’s assume that the thrust specific fuel consumption does not differ for morphing or conventional aircraft, but does change when the airplane changes its role from cruise to loiter, but the cruise speed is the same in both configurations ($T_C = T_C^*$). In this case, Equation 14 becomes

$$\frac{T_L^*}{T_L} = \frac{E_L^*}{E_L} \left[1 - \left(\frac{E_L}{T_L c_j^L} \right) \frac{f_{morphing}}{\beta} \right] + \left(\frac{T_C}{T_L} \right) \left(\frac{c_j^C}{c_j^L} \right) \left(\frac{E_L^*}{E_C^*} \right) \left[\frac{E_C^*}{E_C} - 1 \right] \quad (15)$$

Equation 15 displays several features related to morphing performance and desirability. First, if the purpose of morphing is to increase loiter time, then the primary design parameter is increased morphed wing L/D during loiter. However, this positive effect is reduced by the weight of morphing mechanisms.

Equation 15 shows that if the original aircraft design is loiter efficient (the term $\frac{T_L c_j^L}{E_L}$ is small) then the penalty for morphing is magnified. The morphing penalty is also large if the parameter β is small (this occurs with aircraft having large fuel fractions) because the addition of an extra pound of weight is more pronounced at low structural mass fractions. Finally, the second term on the right hand side of Equation 15 shows that the ability to reduce drag in other mission segments will also benefit loiter by saving fuel in these segments.

Morphing Aircraft Technology – New Shapes for Aircraft Design

The equations used for this illustration assume cruise at constant airspeed V , but also assume constant lift coefficient so that the airplane climbs as it burns fuel and becomes lighter. When the air vehicle is flown at a constant altitude and L/D is adjusted to fit the flight profile there are additional savings.

Figure 18 shows how the ability to adjust L/D in cruise and loiter affects loiter time. The vertical axis represents values of $\frac{L/D_{cruise}^*}{L/D_{cruise}}$ while the horizontal axis represents values of $\frac{L/D_{loiter}^*}{L/D_{loiter}}$. In these plots, there is no weight penalty for morphing.

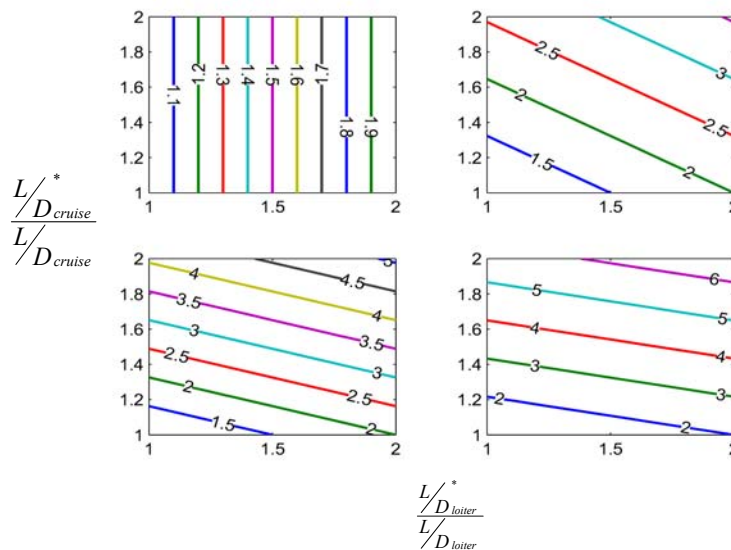

Figure 18: The effects of morphing controlled L/D on increased loiter time for several different cruise-time-to-loiter time ratios.

Each of the four plots in Figure 16 has a different ratio of cruise to loiter time. The lines in the upper left diagram show the benefits when the ratio of cruise to loiter is zero. This means that the aircraft spends all

of its time loitering and changing the value $\frac{L/D_{cruise}^*}{L/D_{cruise}}$ will not increase loiter time. In the upper right

diagram, the ratio of cruise time to loiter time is 0.667 so $\frac{L/D_{cruise}^*}{L/D_{cruise}}$ improvements during cruise have an

effect on morphing loiter time. The lower left diagram is for a ratio of cruise to loiter time of 1.33 while the lower right diagram is for a ratio of cruise to loiter time of 2. Note that fuel savings in the cruise mode now create substantial increases in loiter time for the morphing aircraft.

As additional roles are added to the morphing aircraft mission, additional terms are added to Equation 15. This means that morphing saves additional fuel that can be added to the loiter segment or can be off-loaded to reduce aircraft weight. It is the latter possibility that creates the competitiveness of the morphing aircraft since the conventional aircraft has no other choice than to grow in size as mission roles are added and the fixed wing design is compromised.

8.0 WIND TUNNEL TESTING – MAS PHASE 2

All three contractors successfully met the milestones for the MAS Phase 1 program. New concepts were conceived and limited testing of components was successful. A re-focusing of the effort occurred in Phase 2 so that the concentration of effort could be on UAVs. As a result, Raytheon was eliminated from Phase 2, despite their innovative development.

The design-build-test phase took eighteen months and culminated in both NextGen Aeronautics and Lockheed-Martin testing half-span models in the NASA Langley Transonic Dynamics Wind Tunnel (TDT). These models had self-contained power and actuation units and control systems that moved the wings quickly and accurately between different positions. Test conditions included speeds up to Mach 0.90 and altitudes up to 50,000 feet.

9.0 CHANGING WING AREA – MATERIALS & ACTUATOR SELECTION & MECHANISM DESIGN

Except for the variable sweep, swing-wing concepts, most previous morphing concepts were applied to lightly loaded, relatively low-speed airplane designs. It is fair to ask why we should make a new investment in morphing wings when this concept has been tried in the past and has had so little impact. The answer to this question has two parts, both of which have to do with the technological “ecology” that exists today, compared to that which existed several decades ago.

First of all, many new, novel materials, material systems and actuation devices have been developed during the past decade. These developments allow designers to distribute actuation forces and power optimally and more efficiently. Properly used, these devices reduce, weight compared to other, more established methods.

Finally, missions today differ markedly from those a decade ago. We face both sophisticated and unsophisticated adversaries. Targets are more distributed and are smaller, but with the proliferation of sophisticated air defenses, these targets may be very dangerous to attack. Morphing provides mission flexibility and versatility to deal with these kinds of targets in a cost-effective manner.

Wing shape-changing concepts require actuators attached to internal mechanisms, covered with flexible/sliding aerodynamic surfaces - with load transfer attachments between skin and skeleton. This requires a distributed array of actuators, mechanisms and materials that slide relative to each other or skin materials that stretch. Mechanism design requirements include the range of motion and concerns about binding and friction as well as the effects of wing structural deformability under load and the control of the actuator stroke under loads.

Morphing poses several unique challenges when the wing loading is high. Very flexible materials are the designer’s first choice because they are easily reshaped. However, the wing structure must have high bending stiffness, with in-plane compliance to allow actuators to change area with low energy input. Stretchable, flexible skin surfaces, like Ader’s bat wings sag under surface pressure loads. Preventing the active, shape changing mechanisms from binding or “sticking” as they move from one position to another is another special design challenge for highly loaded wings.

Actuator performance power and actuator force capability are essential to design success. The size, weight and volume of the actuators are an important metric, as is range of motion, bandwidth and fail safe behavior. Locking is important when the wing is under load since, without locking features, the actuators must withstand full load.

Morphing Aircraft Technology – New Shapes for Aircraft Design

Material selection and suitability are particularly important challenges. Multi-functional skin stiffness, as described above, is important, but so too is joining and interface compatibility and the ability to seal openings as the wing transitions from one form to another. A fledging technology to this job may be shape memory polymers. These polymers have two phases, each with a different modulus. When heated, the polymer will assume one shape with low stiffness and can be easily deformed by actuators. At a lower temperature, a second component shape is appears with a larger elastic modulus. These skins must provide a seamless airfoil shape and keep structural integrity under compression, tension, bending and flight loads throughout morphing transitions, but they are ideal for filling gaps created by large motions of surface areas.

Morphing designs may also benefit from geometrically flexible structural designs if the aeroelastic energy from the airstream can be used to activate the shape changing and tabs can use aeroelastic control approaches for maintaining shape. The wealth of new technologies available to the wing designer provides intriguing design possibilities.

Internal control and the strategy used to move from one wing form to another is also an important design goal. This involves sensor selection, braking and locking and the integration of sensors, actuators and the software to link them.

Finally, the speed at which morphing shape change occurs is important. While slow changes may be enough to alter performance for some missions, rapid changes may add to aircraft maneuverability in ways that will make morphing aircraft more efficient. Adding flight control to the list of morphing attributes, instead of adding it to the list of problems, is a challenge.

10.0 THE FUTURE OF AIR VEHICLE MORPHING – MISSIONS AND SYSTEMS

Early aviation enthusiasts, who coined the phrases “polymorphing” and “morphing” aircraft, launched morphing technology and raised the level of awareness of the aeronautical community. The current, enthusiastic revival comes at a time when the UAV community has begun to consider new Army, Air Force and Navy missions. It will become increasingly important to rethink design strategies that are the product of the first century of flight.

Despite the large array of new technologies that add design freedom to the designer’s arsenal of technological tools, we live in a demand based society. The morphing aircraft will have to earn its way into the military planner’s requirements by displaying new capability.

Developers of aircraft should never lose sight of the fact that their airplane is not the system, but is only a part of a system with a central purpose. Excessive worry about the complexity of the aircraft or the cost of the aircraft without looking at system effectiveness (or ineffectiveness) that results from the addition of technologies or features is not productive.

A good example of a systems outlook, as opposed to an airplane centric outlook is the story of the Grumman F4F Wildcat. The F4F-4, shown in Figure 19, was originally introduced in 1942 as a replacement for fixed wing fighters for Navy carrier use. The original F4F could not fold its wings on the ground. The result was a large “spot size” that reduced the number of aircraft that could be carried onboard. The F4F-4 was a modified design with hinges and pivots designed to allow the airplane to fold its wings while on deck.



Figure 19: Grumman F4F-4 folding wing aircraft – 1942.

The F4F-4 weighed slightly more than earlier versions and its turning and climb performance was slightly reduced, compared to earlier models. However, with the fixed wing versions, a fighter squadron numbered only 18 planes. The folding wing F4F-4 allowed 27 planes per squadron. Pilots stopped complaining about the additional folding wing weight when they realized it meant more friendly fighters in the air at one time.

Separation of pilot presence from pilot control of military aircraft means that more severe vehicle maneuvers are now possible and that flight control at the edge of the capabilities of today's aircraft is feasible. Merging flight controllers with performance controllers requires actuators with high bandwidth-low force and low bandwidth-high force capabilities. These advanced actuators are available today, courtesy of the DARPA/DSO CHAP program and others like it.

The inroads of UAV's into a military force structure dominated by manned aircraft have been slow. The use of unmanned aircraft as observation platforms and, more recently, as armed observation aircraft has accelerated. Fundamental problems include how to plan missions and how to allocate tasks to individual aircraft. For instance, is it better to combine multiple roles into one aircraft, such as advocated here? Or is it better to separate roles? Is it better to design an aircraft for loiter at high L/D? Or is it simpler to send automatic refueling aircraft to service aircraft with lesser capabilities? These questions need to be answered during the design process and require analytical tools-some of them not now available- that designers can use to trade-off morphing and non-morphing design features.

The new UAV capabilities introduced by the DARPA MAS program are only one of the ways to liberate the UAV from old design thinking and conventional mission definition. Future generations will improve these designs just as previous designers have succeeded in taking the Wright Brothers aircraft and evolving it into the transportation and military marvel that it has been for nearly a century.

11.0 THE NEED FOR NEW AIRCRAFT SOLUTIONS

Morphing aircraft are distinguished by their ability to change shape to respond to new environments that are encountered as their missions unfold. It is fair to ask "so what, how will that increase my military capabilities?" The answer to that question requires the questioner to accept several assumptions about the future. The first assumption is that enemies of the future will have a substantial, sophisticated air defense composed of a variety of radar directed weapons that can acquire and target airborne assets. A second

Morphing Aircraft Technology – New Shapes for Aircraft Design

assumption is that the enemy of the future will be adept at moving and hiding valuable assets, making them harder to find and more difficult to strike.

The answer to this problem is to develop systems that can search, locate, target and attack both air and ground targets, but can also survive and persist in the face of a dedicated, high-tech enemy. Note that we use the term “systems” not aircraft since the system components will consist of a variety of aircraft and ground based or sea based components. A key trait of these systems is that they possess low observability/stealth and speed as protective measures, or stand-off from the hostile area. If the system stands off too far, then it becomes unresponsive to some types of moving, “pop-up” targets. In addition to protecting itself, the elements of the system that engage in attack must have precision weapons and pervasive knowledge of threats and battle situational awareness to force our way through anti-access areas and enemy denial forces to strike critical targets and to prosecute these targets from multiple directions and dimensions.

To be affordable, the system has to have a small logistical footprint, but provide persistent, high-tempo force application ranging from localized small-scale effects, to persistent effects that can dominate defined geographic regions to deny the enemy freedom of action and immediately deliver forces in multiple unpredictable locations with sufficient combat power to achieve decisive effects.

ACKNOWLEDGEMENTS

The author gratefully acknowledges the people who made the DARPA Morphing Aircraft Structures Program a success. This includes the NextGen Aeronautics, Inc. team, led by Dr. Jay Kudva and the Lockheed-Martin team led by Mr. Derek Bye. It also includes the technical agent team, led by Dr. Brian Sanders. Special acknowledgement is given to Mr. Jason Bowman who assisted the author in the development of the analysis presented in Section 7.0. This analysis and discussions with Mr. Bowman were highly useful in obtaining authority to proceed with Phase 2 of MAS. Acknowledgement is also given to the NASA MAS team, Ms. Anna McGowan, Mr. Thomas Ivanco and Mr. David Piatek, for their assistance in designing the Phase 2 wind tunnel model. Although results are not presented extensively in this paper, this effort provided much needed validation of the concept.