

RESEARCH ON INORGANIC POLYMER SYSTEMS CONTAINING BORON AND ALUMINUM

R. J. Brotherton

U. S. Borax Research Corporation
Anaheim, California

ABSTRACT

The present investigation has been directed toward the preparation of thermally stable inorganic or semi-inorganic polymers. Initial work included investigations of polymers based on boron-boron and aluminum-oxygen bonding systems. Work was subsequently suspended in these areas in favor of more promising boron-nitrogen and boron-oxygen systems. Conversion of borazoles to linear boron-nitrogen systems or to polyborazoles has not given satisfactory materials, but more promising linear boron-nitrogen systems have been prepared by an alternative method. Recently a series of polymers with boron-oxygen or boron-nitrogen bonds and aromatic groups in the basic chains have been investigated.

I. INTRODUCTION

The objective of this research program is the preparation of new inorganic or semi-inorganic polymers which show sufficient thermal stability to meet a variety of current and future Air Force operating requirements. Initial research efforts involved a comprehensive study of systems based on B-B, B-N, and Al-O bonding. Early in this work numerous monomers and prototypes containing these bonding systems were prepared and evaluated; subsequently, monomers and polymers based on other bonding systems have also been investigated. As more information developed, overall emphasis on the program was gradually shifted from B-B and aluminum based systems to B-N bonded materials. More recently promising systems with B-O bonding and with various aromatic groups in the polymer chains have also been initiated including studies of polymer properties, polymerization techniques, and evaluation of end-use products, particularly glass fiber laminates. The results of our initial research on the B-B, Al-O, and B-N systems through December, 1960 have been described previously in Summary Technical Reports, (References 1 and 2). Some of this work has also been published in the open literature, and these references are given in the text. In the present paper, an attempt has been made to summarize our investigations of these systems and to discuss reasons for suspending work in the areas of the B-B and Al-O types. Subsequent work on B-N and borazole polymers will be discussed in addition to initial investigations of a variety of aromatic B-O and B-N materials.

Report Documentation Page

*Form Approved
OMB No. 0704-0188*

Public reporting burden for the collection of information is estimated to average 1 hour per response, including the time for reviewing instructions, searching existing data sources, gathering and maintaining the data needed, and completing and reviewing the collection of information. Send comments regarding this burden estimate or any other aspect of this collection of information, including suggestions for reducing this burden, to Washington Headquarters Services, Directorate for Information Operations and Reports, 1215 Jefferson Davis Highway, Suite 1204, Arlington VA 22202-4302. Respondents should be aware that notwithstanding any other provision of law, no person shall be subject to a penalty for failing to comply with a collection of information if it does not display a currently valid OMB control number.

1. REPORT DATE 1962	2. REPORT TYPE	3. DATES COVERED 00-00-1962 to 00-00-1962	
4. TITLE AND SUBTITLE Research on Inorganic Polymer Systems Containing Boron and Aluminum		5a. CONTRACT NUMBER	
		5b. GRANT NUMBER	
		5c. PROGRAM ELEMENT NUMBER	
6. AUTHOR(S)		5d. PROJECT NUMBER	
		5e. TASK NUMBER	
		5f. WORK UNIT NUMBER	
7. PERFORMING ORGANIZATION NAME(S) AND ADDRESS(ES) Paul V. Galvin Library, 35 W. 33rd Street, Chicago, IL, 60616		8. PERFORMING ORGANIZATION REPORT NUMBER	
9. SPONSORING/MONITORING AGENCY NAME(S) AND ADDRESS(ES)		10. SPONSOR/MONITOR'S ACRONYM(S)	
		11. SPONSOR/MONITOR'S REPORT NUMBER(S)	
12. DISTRIBUTION/AVAILABILITY STATEMENT Approved for public release; distribution unlimited			
13. SUPPLEMENTARY NOTES			
14. ABSTRACT The present investigation has been directed toward the preparation of thermally stable inorganic or semi-inorganic polymers. Initial work included investigations of polymers based on boron-boron and aluminum-oxygen bonding systems. Work was subsequently suspended in these areas in favor of more promising boron-nitrogen and boron-oxygen systems. Conversion of borazoles to linear boron-nitrogen systems or to polyborazoles has not given satisfactory materials, but more promising linear boron-nitrogen systems have been prepared by an alternative method. Recently a series of polymers with boron-oxygen or boron-nitrogen bonds and aromatic groups in the basic chains have been investigated.			
15. SUBJECT TERMS			
16. SECURITY CLASSIFICATION OF:			17. LIMITATION OF ABSTRACT
a. REPORT unclassified	b. ABSTRACT unclassified	c. THIS PAGE unclassified	Same as Report (SAR)
			18. NUMBER OF PAGES 22
			19a. NAME OF RESPONSIBLE PERSON

II. POLYMERS CONTAINING BORON-BORON BONDS

A. INTRODUCTION

At the time of the inception of the present research program there was little published information on materials with covalent boron-boron bonds and essentially none on polymers containing this linkage. Excluded from this discussion are the boron hydrides, some of which have boron-boron single bonds in addition to the bridged bonding which is characteristic of these materials. The initial stage of the present program involved the synthesis and study of simple prototype systems. A major accomplishment of this early work was the development of the first practical syntheses of a variety of diboron compounds, the simplest boron-boron bonded derivatives (References 3-5). Using knowledge gained during the subsequent prototype investigations, various polymerization reactions and methods were studied. Three general types of high molecular weight materials containing boron-boron bonds were prepared. The preparation and some specific properties of selected derivatives of each system are described in the following sections.

B. DISCUSSION

1. Polyborons, $\left\langle \overset{\text{R}}{\text{B}} \right\rangle_n$

a. Disproportionation of Diboron Compounds

The disproportionation of diboron compounds appears to be an ideal method for the preparation of polyboron polymers. Diboron tetrachloride, for example, disproportionates at room temperature and above to give boron trichloride and polyboron polyhalides (Reference 6), but the poor thermal stability of the

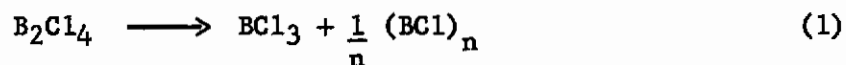

resulting polyhalides eliminates them from any consideration for high temperature applications. During the present prototype studies, however, it became apparent that diboron compounds with substituents having available electrons on the substituent atom adjacent to the boron were significantly more stable than the halogen derivatives. Therefore, the disproportionation of tetraalkoxy and tetra(dialkylamino)diborons to polyborons was investigated. This type of disproportionation is

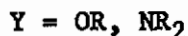
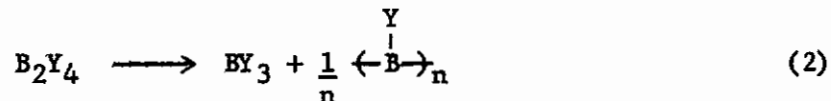

ideal for the formation of high molecular weight materials because the volatile condensation products formed can be removed continuously. However, attempted thermal disproportionation of tetra(dialkylamino)-diborons always led to degradation of the diboron molecule rather than

the desired reaction. Polyalkoxy polyborons, $\left\langle \overset{\text{RO}}{\text{B}} \right\rangle_n$, were obtained from tetraalkoxydiborons by careful heating at about 100°C. However, these systems always tended to eliminate ethers during the heating period, and it was difficult to eliminate this undesirable cross-linking reaction. The final products contained 10-15 ROB units (measured cryoscopically) and decomposed rapidly at 200°C. No additional work was done on these systems because of this lack of thermal stability and their difficulty of preparation.

b. Sodium Reduction

Our recently developed reaction of halo-bis(dimethylamino)boranes with sodium (Equation 3) is an excellent preparative method for diboron compounds (Reference 3). The analogous

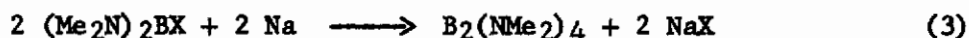

reaction of dihalo(dialkylamino)boranes with sodium is a potential method for preparing polymers, although the probable difficulty of obtaining high molecular weight products from this reaction is

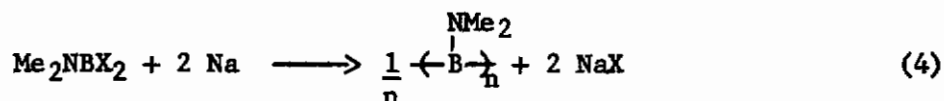

recognized. The reaction of dichloro(dimethylamino)borane with sodium yielded a material which appeared to be $\left\langle \overset{\text{NMe}_2}{\text{B}} \right\rangle_n$ where n was about 15. Elemental analysis suggested the presence of one or more bridging or

$\begin{array}{c} \diagdown \\ \text{B} \\ \diagup \end{array}$

crosslinking boron atoms, >B-B-B< , in the structure. This material decomposed at temperatures below 200°C, whereas the simple diboron analog, $\text{B}_2(\text{NMe}_2)_4$, is stable to 300°C. This poor thermal stability of dimethylamino polyboron suggests that related materials will not be sufficiently heat resistant for projected high-temperature uses, because prototype studies showed that diboron compounds with amine substituents were the most thermally stable of the derivatives investigated.

2. B-B-N Systems, $(-\text{B-B-N-})_n$

a. A number of materials have been prepared in which the boron-boron bonds in the polymer chain are interspersed with nitrogen atoms. These compounds were obtained by the elimination of amines from diboron derivatives of primary amines as shown in Equation 5. The

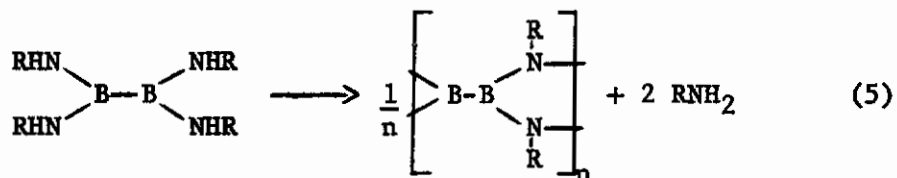

Contrails

final products formed by the elimination of two amine groups from every diboron molecule would be a highly crosslinked material as shown.

b. The initial diboron compound formed in the reaction of excess ammonia with tetra(dimethylamino)diboron was apparently unstable and decomposed spontaneously below room temperature with the evolution of ammonia. The products from this reaction were white crystalline polymers with compositions approaching

$\left[\begin{array}{c} \text{NMe}_2 \quad \text{NH}_2 \\ | \quad | \\ \text{B} \text{---} \text{B} \text{---} \text{NH} \end{array} \right]_n$. These materials were insoluble in common solvents and did not char when heated in an open flame. However, further heating at 500°C. led to continued amine evolution, and it is probable that boron-nitride-like structures such as $\left[\begin{array}{c} \text{NH} \text{---} \text{B} \text{---} \text{NH} \\ | \quad | \end{array} \right]_n$ were approached.

c. Tetra(methylamino)diboron decomposed at about 75°C. to give approximately one mole of methylamine and low-molecular weight products. Heating tetra(*n*-hexylamino)diboron at 140°C. yielded one mole of *n*-hexylamine and an intermediate which was probably a borazole derivative (based on analyses and molecular weight). Further heating at 364°C. gave a viscous green liquid (molecular weight, 1750) which decomposed rapidly at 500°C.; there was some evidence for structural degradation even at 364°C. The elemental analysis of this product suggests a composition approaching

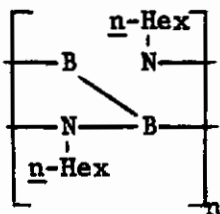

d. The thermal treatment of tetra(anilino)diboron was studied in detail. In this system the initial product evolved on heating at 300-500°C. was one molar equivalent of hydrogen. Varying amounts of aniline were also obtained depending on the conditions used. The results suggest that the initial step is cleavage of the boron-boron bond to give an intermediate borazole followed by amine elimination leading to polyborazoles as shown.

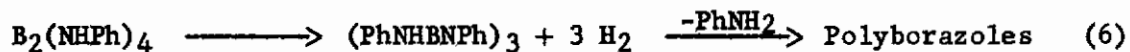

Initial products from this reaction were soluble in organic solvents and had molecular weights in the range of 1000-1100. Continued heating led to the evolution of additional amine and insoluble resins which had good thermal stability. However, these materials, which did not retain any boron-boron bonds, offered little advantages over resins which could be obtained more directly from simple boranes.

3. Aromatic B-B-N Systems, $\left[\begin{array}{c} | \quad | \quad | \\ \text{B} \text{---} \text{B} \text{---} \text{N} \end{array} \text{---} (\text{aromatic}) \right]_n$

a. Phenylenediamine Derivatives

The reaction of tetra(dimethylamino)diboron with phenylenediamines led to a series of thermally stable, intractable

Contrails

materials. The product from the reaction with *o*-phenylenediamine was a crystalline compound which appeared to be monomeric, possibly

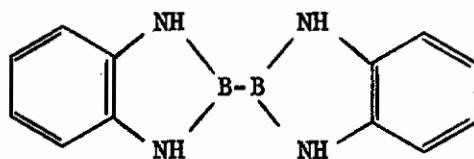

This compound lost little weight up to 500°C., but heating at 500°C. for one hour resulted in the formation of one mole of hydrogen with probable cleavage of the B-B bond. Reactions with various molar ratios of *o*-phenylenediamine showed that the second hydrogens of the amine groups were very difficult to replace. Reaction with two molar equivalents of *p*-phenylenediamine yielded the polymer shown in Equation 7. This crosslinked product was insoluble in organic solvents

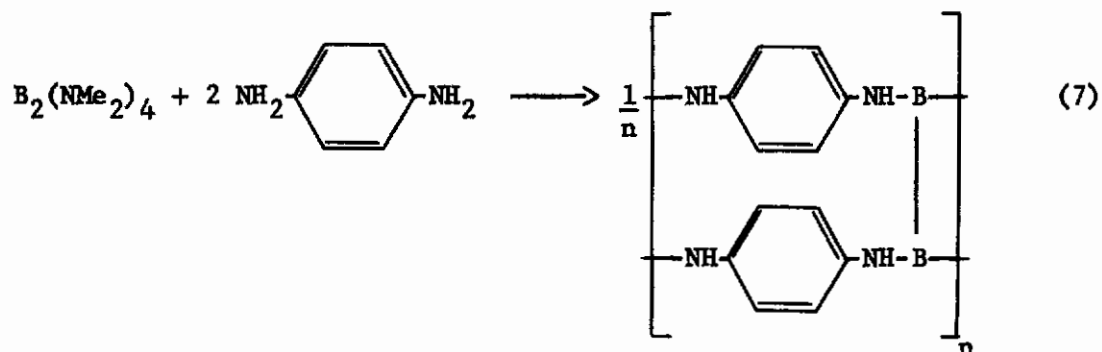

and lost only 4 wt.% when heated to 500°C. During this heating at 500°C., it evolved approximately one mole of hydrogen per boron-boron bond indicating almost complete cleavage as in the case of the *ortho* derivative. Comparable products from *m*-phenylenediamine were also prepared and found to be significantly less stable at 500°C. than those from *o*- and *p*-phenylenediamines.

b. Other Aromatic Polymers

Several polymers of the "polybenzborimidazoline" type have been prepared from tetra(dimethylamino)diboron. These materials are discussed in Section IV-D-3-c.

III. ORGANOALUMINUM POLYMERS

A. INTRODUCTION

The original decision to investigate aluminum-oxygen polymers was based on the known stability of alumina and several reports of thermally stable high-molecular weight aluminum-oxygen derivatives. During this investigation, aluminum-oxygen, aluminum-oxygen-silicon, aluminum-nitrogen, and several other aluminum-based materials were prepared and studied. Earlier prototype studies had shown that aryloxy substituents on aluminum led to materials with optimum stability,

and most of the polymers prepared contained aryloxy substituent groups. The present discussion will include a summary of the major polymerization reactions studied and the properties of the best aluminum-based materials obtained.

B. ALUMINUM-OXYGEN SYSTEMS

1. A number of aluminum-oxygen polymers were prepared by various condensation-polymerization methods. The simplest aluminum-oxygen polymers were prepared by partial hydrolysis-condensation reaction as shown, but they showed poor thermal stability and disproportionated in some cases.

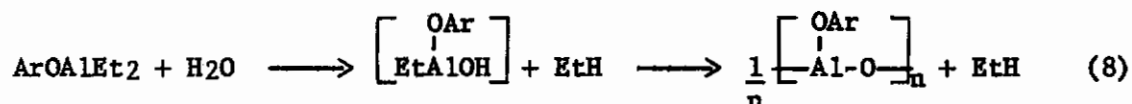

2. Related aluminum-oxygen materials with mixed substituents were prepared by reorganization and pyrolysis with the elimination of alcohols and olefins as shown in Equation 9. These products were

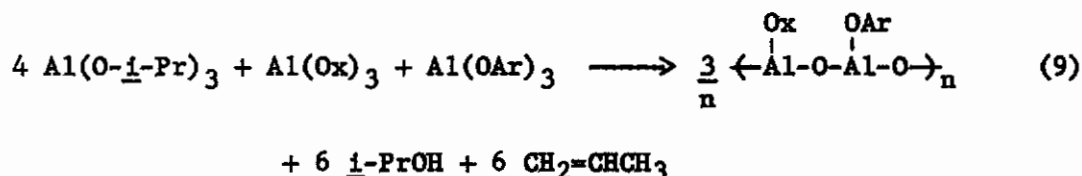

Ox = oxinate,

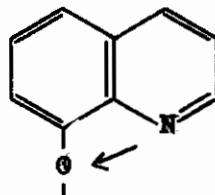

I, Ar = Ph

II, Ar = SiMe₃

more soluble than the simple aryloxyaluminumoxanes prepared as shown in Equation 8 and had molecular weights ranging from 2000-2500. Thermogravimetric analysis of I, which proved to have the best thermal stability of any aluminumoxane prepared during this program, showed 29% weight loss at 500°C.*

* All TGA (Thermogravimetric analysis) results were determined under vacuum at a heating rate of 150°C. per hour.

C. ALUMINUM-OXYGEN-SILICON SYSTEMS

On the basis of thermal stability, the most promising aluminum-based polymers prepared during this program have been aluminosiloxanes obtained by the two general methods illustrated by Equations 10 and 11. The product (III) from Equation 10 had an

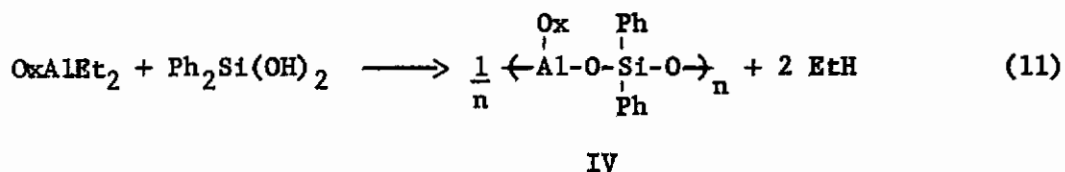
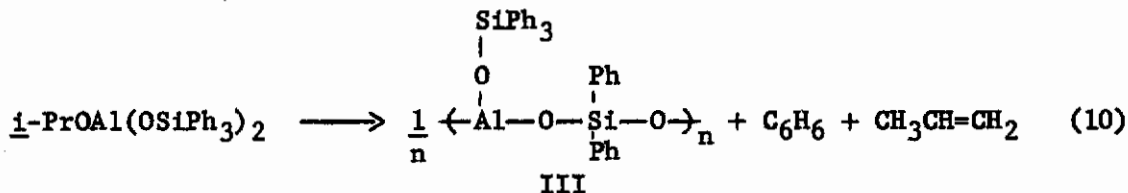

approximate molecular weight of 2000 in benzene but decomposed readily at 350-500°C. It lost about 14% by weight when heated to 500°C. in the TGA equipment. The oxinate derivative (IV) had a measured cryoscopic molecular weight of about 6000 and lost 17% by weight when heated to 500°C. in the TGA equipment. These are the most thermally stable aluminum-based materials studied, but their stability still does not approach that of some of the boron-nitrogen and boron-oxygen systems described in other sections of this paper.

D. ALUMINUM-NITROGEN SYSTEMS

The following aluminum-nitrogen based materials were prepared:

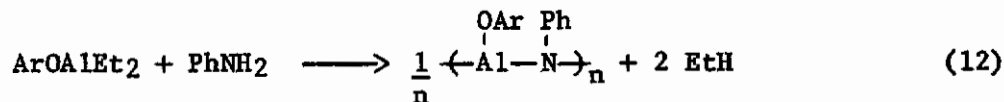

V, Ar = Ph

VI, Ar = oxinate

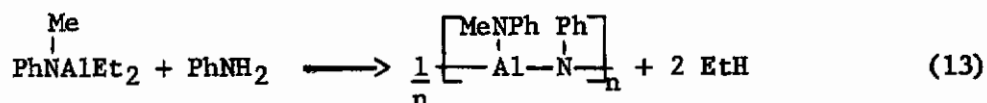

All of these aluminum-nitrogen materials decomposed more readily than the most promising aluminum-oxygen systems; significant decomposition became apparent at 300-400°C.

IV. BORON-NITROGEN AND BORON-OXYGEN SYSTEMS

A. INTRODUCTION

One of the bonding types chosen for initial study was the boron-nitrogen system. This was based primarily on the known thermal stability of boron nitride and other boron-nitrogen compounds. Initial prototype studies involved the synthesis and evaluation of simple aminoboranes and borazoles. Various polymerization methods were developed, but direct preparation of linear boron-nitrogen compounds proved to be very difficult. Subsequent effort was directed toward the preparation of polyborazoles and aromatic boron-nitrogen polymers. More recently, boron-oxygen systems have also been investigated and found to have comparable thermal stability to boron-nitrogen systems. In addition, the boron-oxygen derivatives generally have better solubilities and improved adhesive properties. Work on linear boron-nitrogen systems, polyborazoles, and aromatic systems linked by boron-nitrogen and boron-oxygen bonding is summarized in the following sections.

B. LINEAR BORON-NITROGEN POLYMERS

1. Attempted Preparation from Borazoles

This portion of the program involved prototype studies of monomeric borazoles and attempts to linearize the borazole ring by a variety of methods. The prototype studies demonstrated the encouraging thermodynamic stability of the borazole ring (Reference 5) and the relative stabilizing effects of various substituent groups; for example, methyl groups are particularly advantageous. Linearization of borazoles proved to be very difficult. High molecular weight materials could not be obtained, and the products were not as thermally stable as those which have been developed subsequently. An alternative approach to linear BN polymers is discussed in the next paragraph. Subsequent attempts to polymerize borazoles have been directed toward the preparation of polyborazoles which retain the borazole ring system.

2. Preparation from Benzodiazaborolines

The reaction of difunctional boranes with benzoborolines should lead to linear polymers as shown in Equation 14, since formation

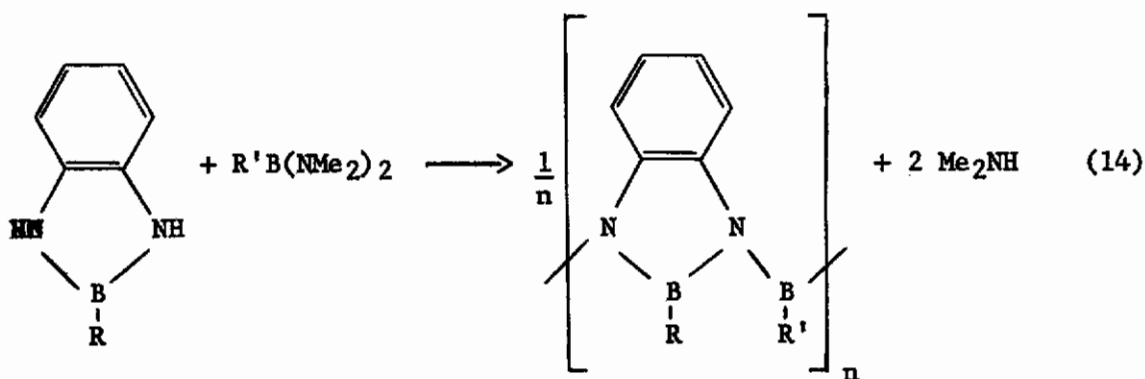

VII, R = R' = Ph

VIII, R = Me, R' = Ph

of the favored borazole structure is prohibited. The completely aromatic polymer (VII) exhibited excellent thermal stability and remained soluble in organic solvents after it was heated to 500°C. The phenylmethyl derivative VIII has not been evaluated. A related compound (IX) has also been prepared recently and found to have good thermal stability. Compounds VII-X have not been completely characterized,

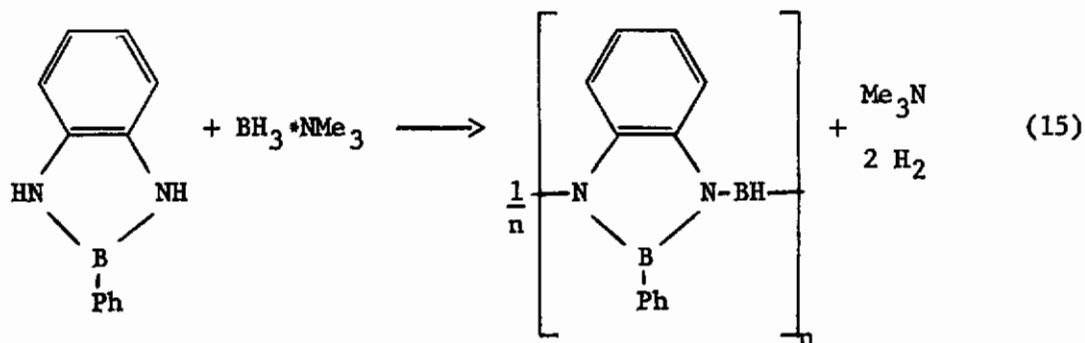

IX

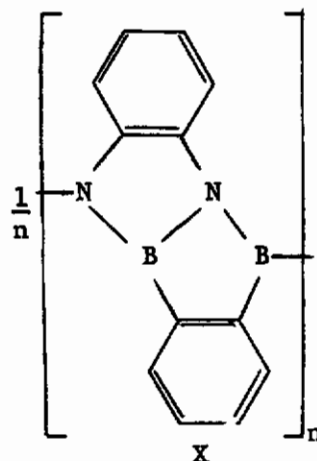

but it is probable that they approach the idealized structures shown.

C. POLYBORAZOLES

1. One of the difficulties in preparing workable polyborazoles is the trifunctional or multifunctional nature of the borazole ring. In order to prepare linear polyborazoles and to avoid intractable crosslinked structures, difunctional borazoles are required. A facile synthesis of these difunctional monomers has been one of the major problems limiting the synthesis of linear polyborazoles. Borazoles can be linked directly as shown in XI, XII, and XIII or through extraneous groups (XIV, XV, and XVI). Little work

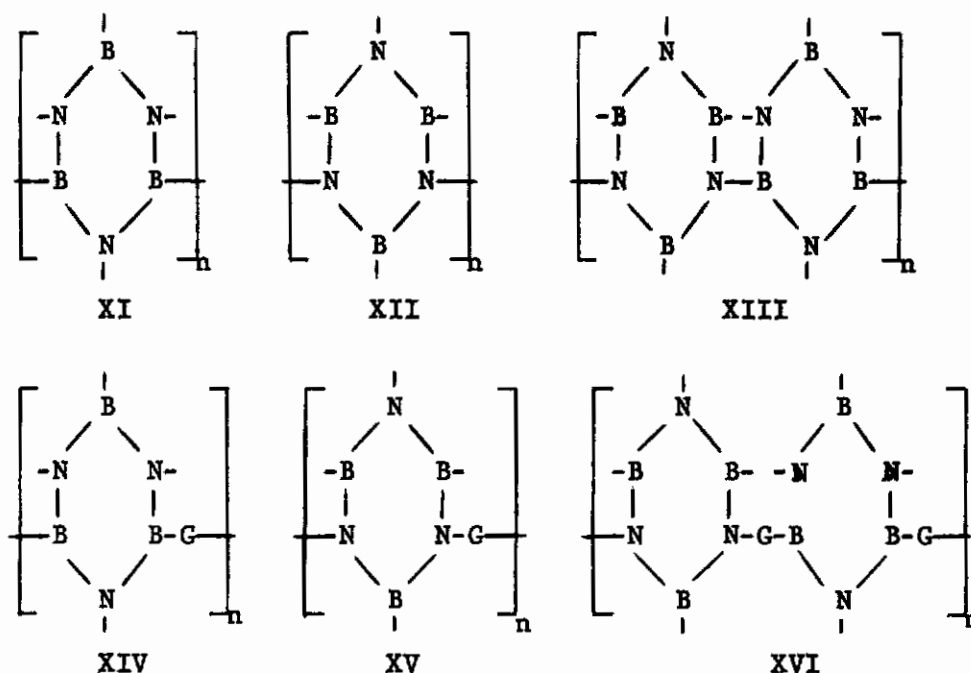

has been done on the preparation of polyborazoles of types XI-XIII, although prototypes of XI have been prepared by the action of sodium on monohaloborazoles. It is believed that the lack of flexibility of these systems and the steric problems introduced by the presence of substituent groups make these materials less attractive than types XIV-XV. No attempt has been made to prepare an example of XVI but approaches to XIV and XV are outlined in the following paragraphs.

2. Linked Through Boron (Type XIV)

Difunctional borazole monomers for the preparation of polyborazoles linked through boron have been prepared by the following reaction sequence. The dichloro derivative has only been obtained in

Contrails

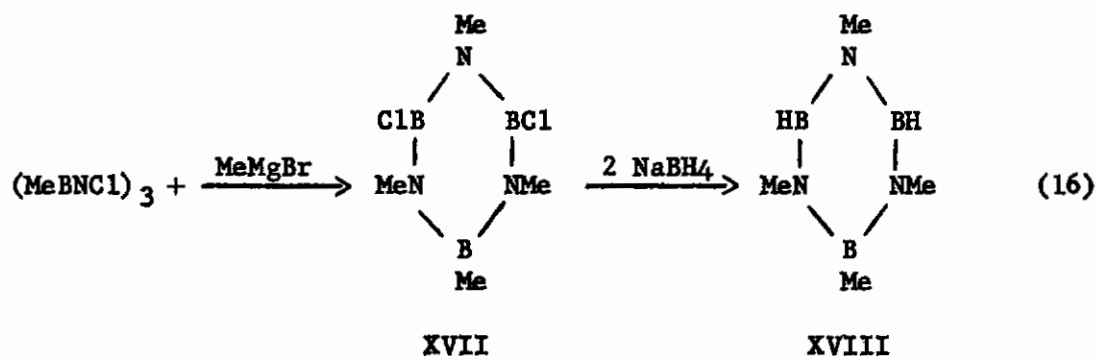

76-84% purity, but it is readily reduced to the pure dihydro compound as shown. Two promising polyborazoles which have been prepared from these difunctional monomers are shown below. The reaction represented

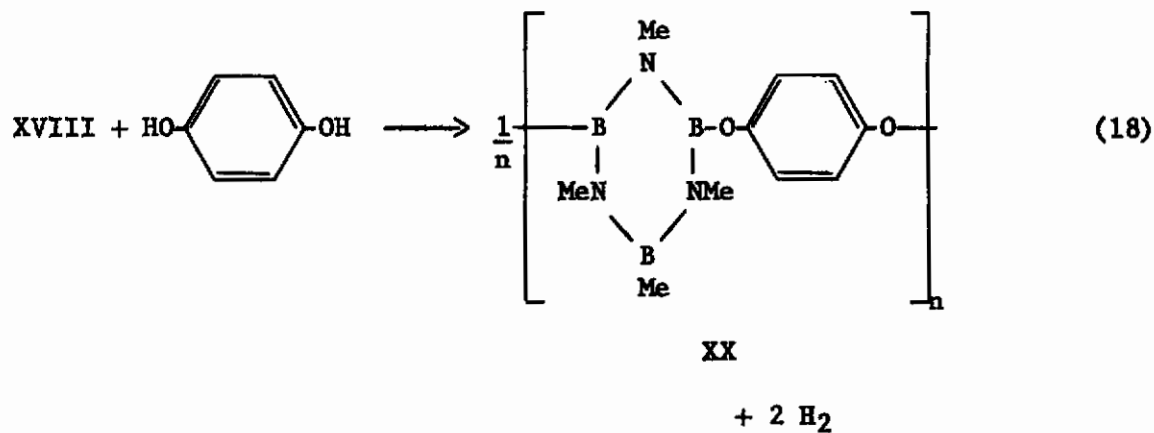
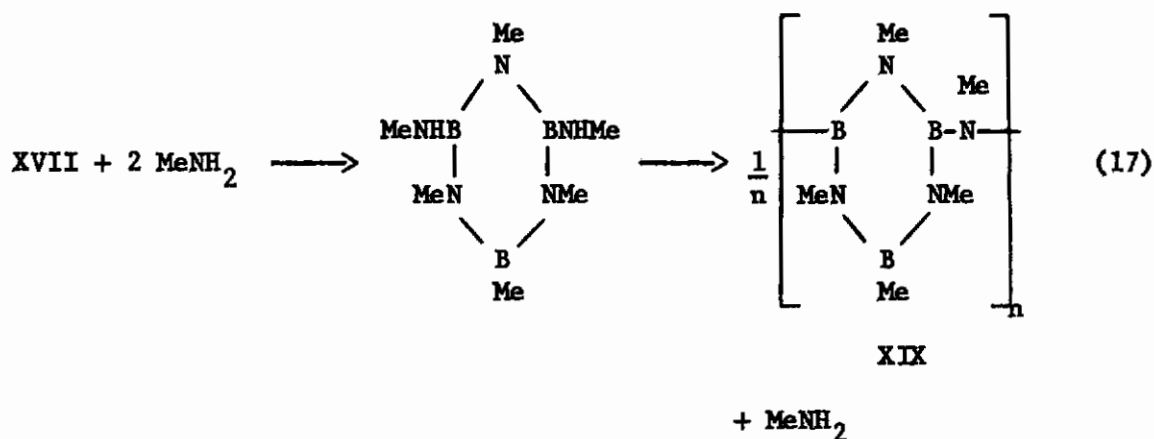

by Equation 17 proceeded readily to give 95% of the theoretical dimethylamine. The polymeric product XIX was infusible and also insoluble in organic solvents but lost 32 wt.% when heated to 500°C. on the TGA equipment. The hydroquinone polymer XX was soluble in

organic solvents and softened at 250-400°. It lost 27 wt.% when heated to 500°C. The structure of this material approaches the idealized polymer XX, but some ring cleavage also occurred.

3. Linked Through Nitrogen (Type XV)

The preparation of polyborazoles linked through nitrogen has been difficult, since the NH linkage of the borazole ring is very unreactive. Reactions with even the most active electrophilic organic reagents (acid chlorides, for example) did not give the desired products. Reactions with isocyanates also failed to give the expected addition of the borazole NH linkage, but did yield a new type of heterocyclic compound (XXI). These materials were soluble

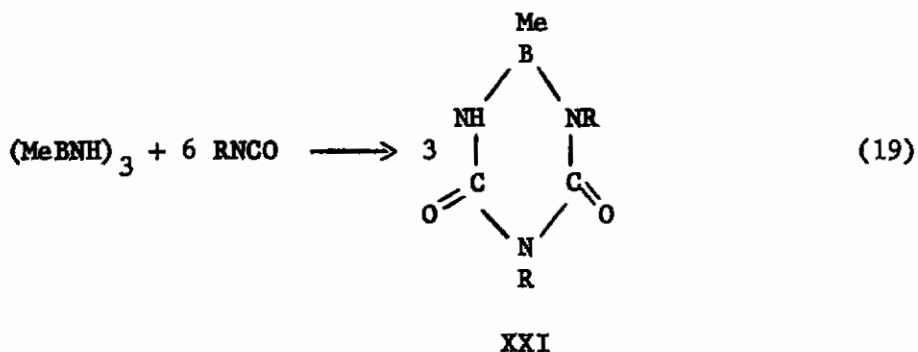

in organic solvents and decomposed at 200-300°C. Reaction of NH borazoles with aromatic diisocyanates should yield polymers incorporating this new ring system. The polymer from toluene diisocyanate and B-trimethylborazole was a white powder which was soluble in some organic solvents and darkened at 320°C. This material will be evaluated further.

D. POLYMERS CONTAINING BO OR BN BONDS AND AROMATIC GROUPS

1. Introduction

Most of the polymeric products based on completely inorganic BN and BO chains were intractable and insoluble in organic solvents. In an attempt to improve these properties, semi-inorganic materials with stable aromatic groups in their backbone have been investigated. The two types which have received the most attention are represented by Structures XXII and XXIII. A number of variations

Contrails

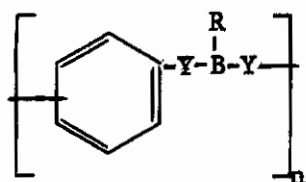

XXII

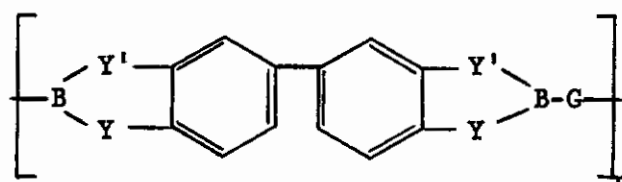

XXIII

Y' or Y = O, NH

R = Me, Ph, ArO

G = a variety of linking groups

of these systems have been investigated and materials with promising properties prepared. As a general class, compounds of type XXIII are the most thermally stable polymers prepared during the present program.

2. Polymers of Type XXII

a. B-N Bonded Materials

The reactions of phenylenediamines with borazoles or with phenyl-bis(dimethylamino)borane led to a series of related polymers. The major difficulty in all polymerization reactions of this type has been elimination of the theoretical amount of volatile condensation products and the consequent formation of high-molecular weight materials. Theoretical amine evolution has been obtained from the reaction of hexamethylenediamine with phenyl-bis(dimethylamino)borane, but the resulting polymers are not thermally stable as might be expected with aliphatic carbon-carbon bonds present. In related reactions with aromatic diamines (Equations 20-25) only 50-90% of the theoretical displaced amine was obtained. The most thermally stable

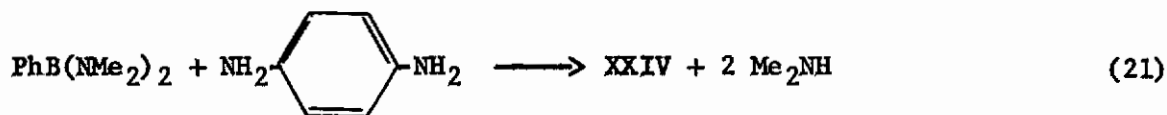
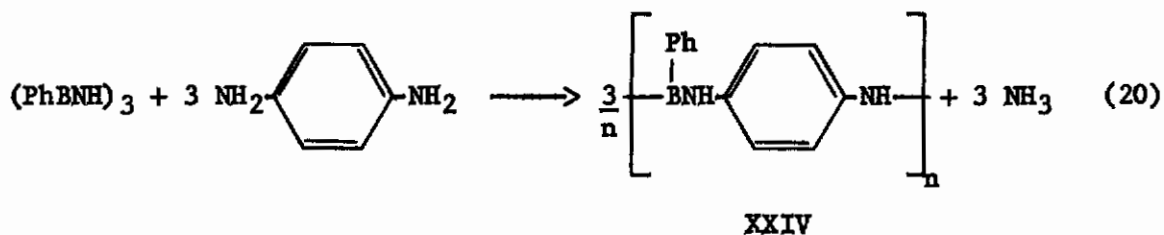

Contrails

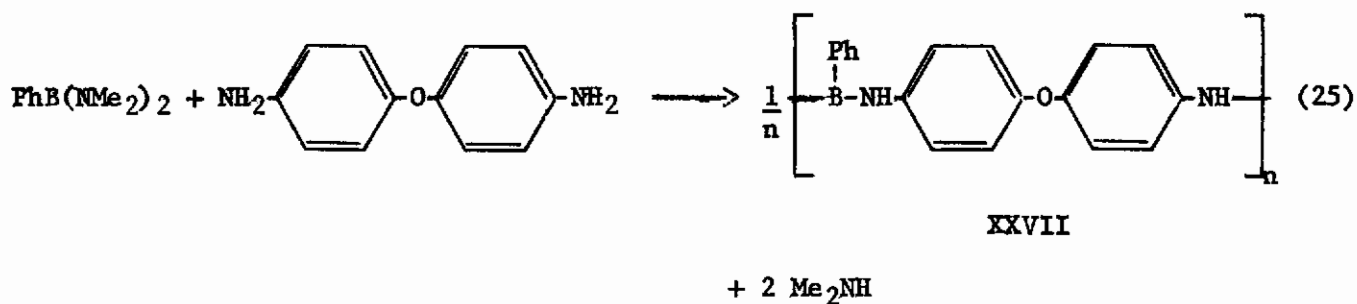
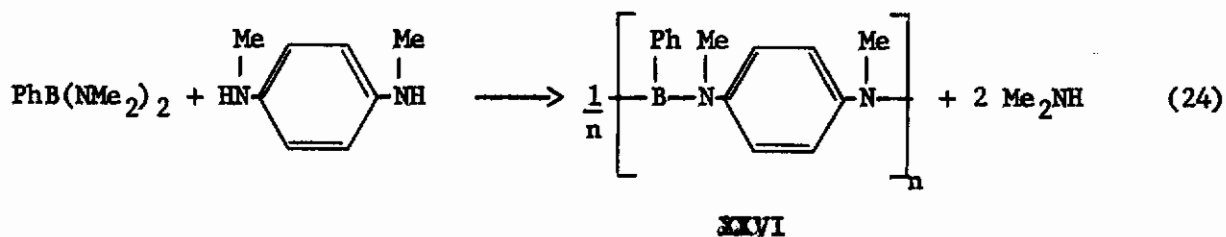
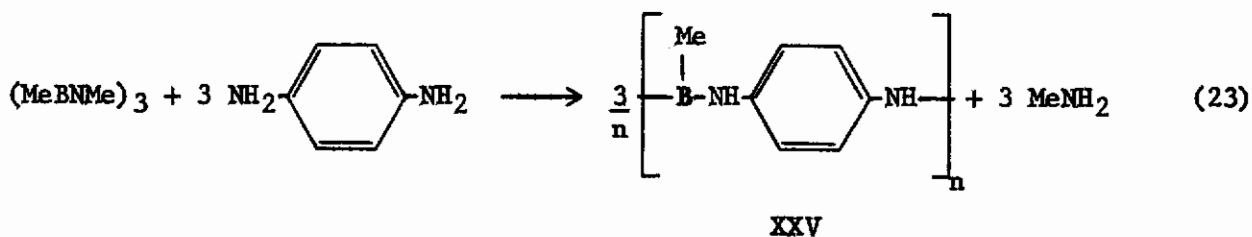

product of this type, XXIV, prepared by the reaction indicated in Equation 21, lost only 8 wt.% when heated to 500°C. on the TGA equipment. All of the other materials listed had significant weight losses at 500°C. Most of these boron-nitrogen derivatives had poor glass adhesion properties and poor to fair solubility in organic solvents. The study of type XXII aromatic systems has recently been expanded to include related boron-oxygen systems, most of which have excellent adhesive properties and give promise of better handling characteristics.

b. Boron-Oxygen Derivatives

The boron-oxygen polymers of type XXII are characterized by excellent adhesion to either glass or metal surfaces and solubility in organic solvents in some cases. Their thermal stability

is good but not as favorable as those of type XXIII. Various boron-oxygen polymers of type XXII have been prepared as shown in the following general equations. The preparation and properties of the resorcinol polymer (XXIX) derived from hexamethylborazole was studied in some detail. This product bonded very strongly to glass and metals and after pretreatment at high temperatures lost 7 wt.% when heated to 500°C. on the TGA equipment. It was soluble in organic solvents but softened at temperatures below 200°C. Polymer XXIX has also been prepared from methyldi-*n*-butoxy borane (Equation 27) and its properties appear to be similar to the material from hexamethylborazole.

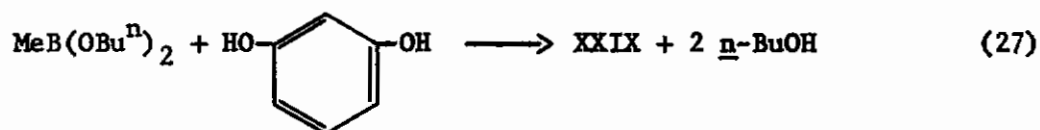
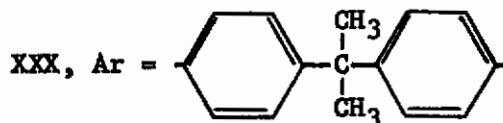
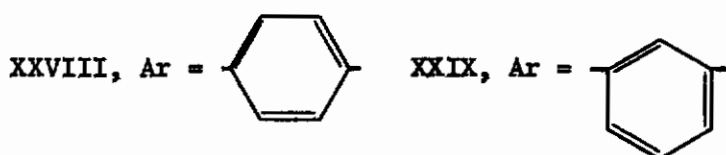
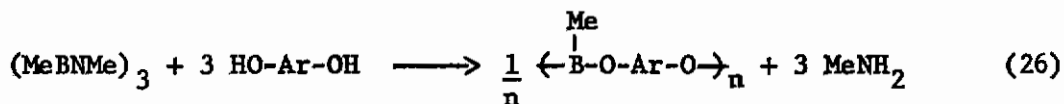

The related hydroquinone derivative (XXVIII) softened at 300-400°C. but was significantly less soluble. Its thermal stability was comparable to that of the resorcinol derivative. In an attempt to increase the softening point and possibly the solubility of this type of polymer, the related compound from bisphenol-A (XXX) was prepared. This material did have improved solubility but softened at 200-300°C. and lost 22 wt.% when heated to 500°C. on the TGA equipment. A polymer (XXXI) related to XXVIII with a phenyl group on boron in place of methyl has also been prepared from phenyldiisopropoxy- or phenyl-bis(dimethylamino)boranes (Equations 28 and 29). Its properties are similar to XXVIII with somewhat poorer thermal stability.

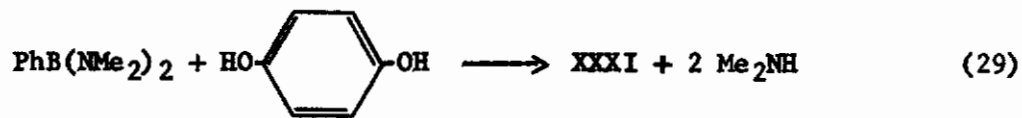
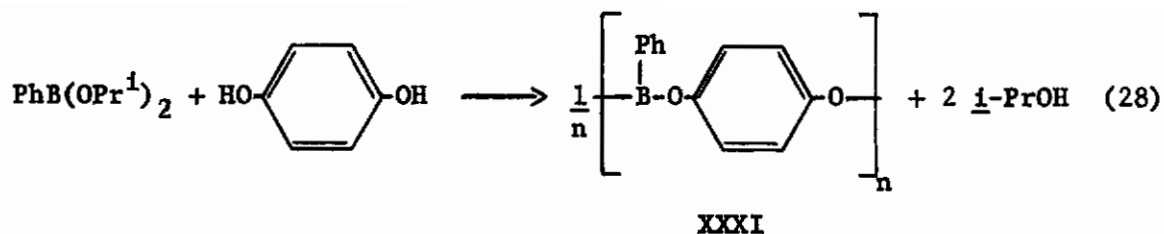

The "ladder" polymer, XXXII, does not soften up to at least 300°C. and is slightly soluble in dimethylsulfoxide.

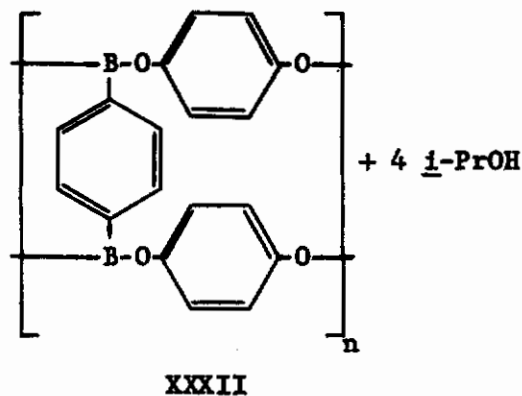
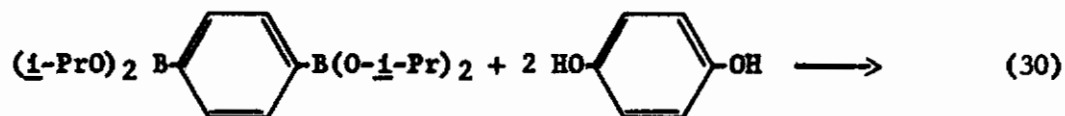

3. Polymers Related to the Benzborimidazolines (Type XXIII)

a. Introduction

In September of 1960 (Reference 8) Bamford and Fordham announced the preparation of a new class of boron-nitrogen polymers, the polybenzborimidazolines, illustrated by XXXIII. Professor C. S. Marvel and co-workers (Reference 9) have also prepared

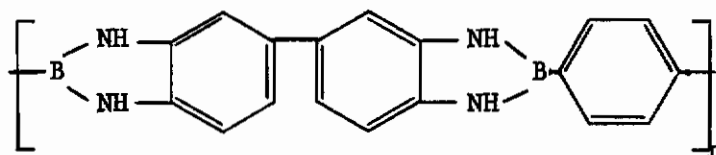

XXXIII

XXXIII and the related derivative of 1,3-benzenediboronic acid as a logical development of their studies on polybenzimidazolines. These polymers are very stable thermally but are infusible and essentially insoluble in organic solvents. The approach followed in the present program was to investigate a series of boron-nitrogen and boron-oxygen substituted analogs of XXXIII in an attempt to improve its solubility and fusibility characteristics with retention of its excellent thermal stability.

b. Derivatives of Diboronic Acids

Prototype compounds (XXXIV-XXXVI) were prepared and found to have comparable thermal stability. However, the oxygen-containing derivatives (XXXV and XXXVI) melted at about 300°C. compared to about 400°C. for XXXIV. They were all soluble

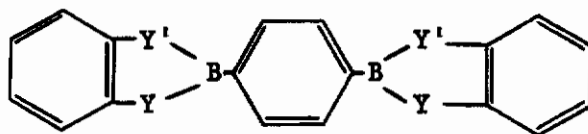

XXXIV, Y = Y' = NH

XXXV, Y = NH, Y' = O

XXXVI, Y = Y' = O

in dimethylsulfoxide and dimethylformamide. The related polymers (XXXVII-XXXIX) were also prepared from the 1,4-diboronate and evaluated. Each had excellent thermal stability losing less than 6 wt.% when

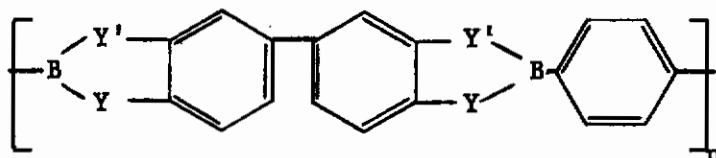

XXXVII, Y = Y' = NH

XXXVIII, Y = NH, Y' = O

XXXIX, Y = Y' = O

heated to 500°C. on the TGA equipment. They were infusible and essentially insoluble in organic solvents.

c. Derivatives of Diboron Compounds

Although the boron-boron bond is not stable in many simple derivatives, aromatic boron-boron containing compounds from phenylenediamines have shown good stability (References 1 and 2). Boron-boron polymers analogous to the derivatives of diboronic acids above have been prepared as follows:

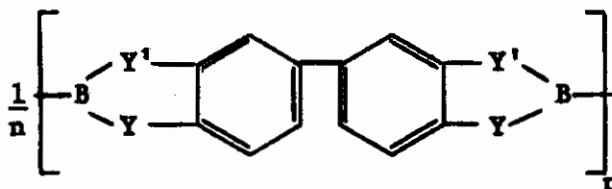
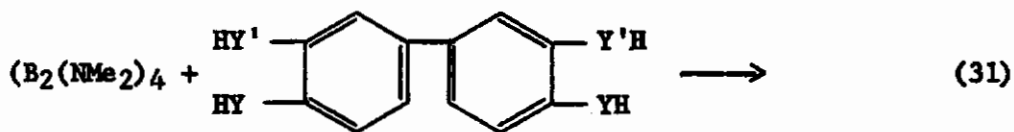

XL, Y = Y' = NH

XLI, Y = NH, Y' = O

XLII, Y = Y' = O

These polymers have the same general characteristics as those prepared from the diboronic acids; infusibility, insolubility, and excellent thermal stability. However, TGA analysis did show XLI and XLII to be slightly less stable than XXXVIII and XXXIX.

d. Other Boron-Oxygen Derivatives

In addition to having the poor handling characteristics noted, the materials described in the two preceding sections have poor adhesive properties. Subsequently, several related compounds have been prepared which have good adhesive properties and improved solubilities and softening points. Evaluation of these compounds is in its initial stages, but TGA tests on XLIV and XLV showed 4 and 6 per cent weight losses respectively on heating to 500°C. The B-O-B polymer XLIV was prepared as shown by

Contrails

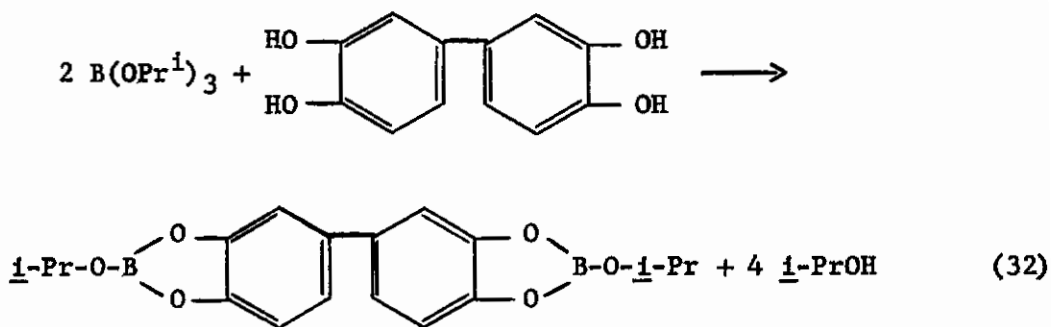

XLIII

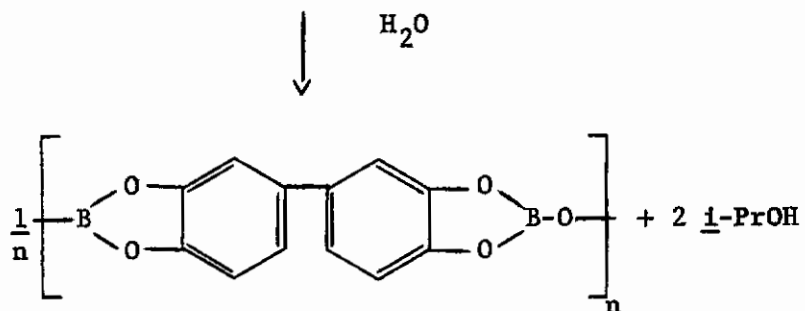

XLIV

a partial hydrolysis-condensation technique similar to that which has been used for the preparation of aluminoxanes. The evaluation of these

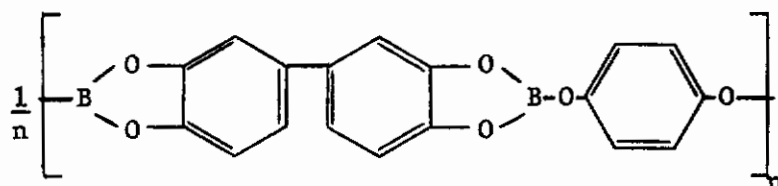

XLV

materials is only in its initial stages, but they appear to be very promising. Their handling characteristics and adhesive properties are better than any of the related compounds described previously.

V. ACKNOWLEDGEMENT

A. This work was supported by the Aeronautical Systems Division, Wright Air Development Center, under Contracts AF 33(616)-5931 and AF 33(616)-7303.

B. It is a pleasure to acknowledge the contributions of A. L. McCloskey and H. Steinberg who have been responsible for the overall supervision of this program and to the following scientists who have been directly responsible for the work discussed.

J. L. Boone	H. M. Manasevit
J. G. Bower	H. C. Newsom
W. D. English	L. L. Petterson
H. Goldsmith	W. C. Teach
M. L. Iverson	G. W. Willcockson
K. Kitasaki	W. G. Woods

REFERENCES

1. A. L. McCloskey, et al., "Research on Inorganic Polymers," WADC TR 59-761, December, 1959.
2. A. L. McCloskey, et al., "Research on Inorganic Polymers," WADD TR 60-911, January, 1961.
3. R. J. Brotherton, A. L. McCloskey, L. L. Petterson, and H. Steinberg, J. Am. Chem. Soc., 82, 6242 (1960).
4. R. J. Brotherton, A. L. McCloskey, J. L. Boone, and H. M. Manasevit, J. Am. Chem. Soc., 82, 6245 (1960).
5. A. L. McCloskey, R. J. Brotherton, and J. L. Boone, J. Am. Chem. Soc., 83, 4750 (1961).
6. G. Urry, T. Wartik, R. E. Moore, and H. I. Schlesinger, J. Am. Chem. Soc., 76, 5293 (1954).
7. H. C. Newsom, W. D. English, A. L. McCloskey, and W. G. Woods, J. Am. Chem. Soc., 83, 4134 (1961).
8. W. R. Bamford and S. Fordham, Paper presented at a Symposium on High Temperature Resistance and Thermal Degradation of Polymers, Society of Chemical Industry, University of London, September 21-23, 1960.
9. C. S. Marvel, et al., "High Polymeric Materials," WADD TR 61-12, April, 1961.

Contrails