



**NAVAL
POSTGRADUATE
SCHOOL**

MONTEREY, CALIFORNIA

THESIS

**THE TOTAL ARMY COMPETITIVE CATEGORY
OPTIMIZATION MODEL: ANALYSIS OF U.S. ARMY
OFFICER ACCESSIONS AND PROMOTIONS**

by

Hise O. Gibson

June 2007

Thesis Co-Advisors:

Robert F. Dell

P. Lee Ewing

Second Reader:

W. Matthew Carlyle

Approved for public release; distribution unlimited

THIS PAGE INTENTIONALLY LEFT BLANK

REPORT DOCUMENTATION PAGE			<i>Form Approved OMB No. 0704-0188</i>
Public reporting burden for this collection of information is estimated to average 1 hour per response, including the time for reviewing instruction, searching existing data sources, gathering and maintaining the data needed, and completing and reviewing the collection of information. Send comments regarding this burden estimate or any other aspect of this collection of information, including suggestions for reducing this burden, to Washington headquarters Services, Directorate for Information Operations and Reports, 1215 Jefferson Davis Highway, Suite 1204, Arlington, VA 22202-4302, and to the Office of Management and Budget, Paperwork Reduction Project (0704-0188) Washington DC 20503.			
1. AGENCY USE ONLY (Leave blank)	2. REPORT DATE June 2007	3. REPORT TYPE AND DATES COVERED Master's Thesis	
4. TITLE AND SUBTITLE: The Total Army Competitive Category Optimization Model: Analysis of U.S. Army Officer Accessions and Promotions			5. FUNDING NUMBERS
6. AUTHOR(S) Hise O. Gibson			
7. PERFORMING ORGANIZATION NAME(S) AND ADDRESS(ES) Naval Postgraduate School Monterey, CA 93943-5000			8. PERFORMING ORGANIZATION REPORT NUMBER
9. SPONSORING /MONITORING AGENCY NAME(S) AND ADDRESS(ES) N/A			10. SPONSORING/MONITORING AGENCY REPORT NUMBER
11. SUPPLEMENTARY NOTES The views expressed in this thesis are those of the author and do not reflect the official policy or position of the Department of Defense or the U.S. Government.			
12a. DISTRIBUTION / AVAILABILITY STATEMENT Approved for public release; distribution unlimited.			12b. DISTRIBUTION CODE
13. ABSTRACT (maximum 200 words) The United States (U.S.) Army's mission is to protect our nation and fight its wars; a mission that requires a substantial resource commitment. The Army today consist of over 505,000 soldiers (more than any other U.S. military service), with over 81,000 of those soldiers comprising the Officer Corps. This thesis develops a linear program to help manage the Army Competitive Category (ACC), a subset of the officer corps consisting of over 51,000 soldiers. The Total Army Competitive Category Optimization Model (TACCOM) prescribes annual accessions and above zone, primary zone, and below zone promotion rates for all grades from Lieutenant to Colonel over a forty-year horizon. We demonstrate TACCOM using data from fiscal year (FY) 2006 and requirement information for all officers in the ACC and also for the subset of officers just in the Aviation (AV) branch. We find a deficit at the grade of Major (MAJ) will continue to exist through FY 2021 if current policy is not changed. Our analysis on just the AV branch shows their mid-grade officer shortage can be remedied by either increasing training capacity by two-thirds, or reducing the attrition of Captains who have five years time in grade. Our analysis also shows the current ACC accessions plan and promotion policies remedy the shortages at the grade of MAJ for the next seven consecutive years, but that there are future shortages ahead. Using TACCOM, we find that one way to reduce the magnitude of the future shortfalls is to adjust the current promotion policy by increasing the number of early promotions to MAJ. By accelerating the promotion to MAJ in the ACC the Army is only facing a shortage of MAJs for four consecutive years, from FY 2013 through FY 2017, versus the seven year shortage without a policy change.			
14. SUBJECT TERMS Manpower Planning, Optimization, Army Transformation			15. NUMBER OF PAGES 75
			16. PRICE CODE
17. SECURITY CLASSIFICATION OF REPORT Unclassified	18. SECURITY CLASSIFICATION OF THIS PAGE Unclassified	19. SECURITY CLASSIFICATION OF ABSTRACT Unclassified	20. LIMITATION OF ABSTRACT UL

THIS PAGE INTENTIONALLY LEFT BLANK

Approved for public release; distribution unlimited

**THE TOTAL ARMY COMPETITIVE CATEGORY OPTIMIZATION MODEL:
ANALYSIS OF U.S. ARMY OFFICER ACCESSIONS AND PROMOTIONS**

Hise O. Gibson
Major, United States Army
B.S., United States Military Academy, 1997

Submitted in partial fulfillment of the
requirements for the degree of

MASTER OF SCIENCE IN OPERATIONS RESEARCH

from the

**NAVAL POSTGRADUATE SCHOOL
June 2007**

Author: Hise O. Gibson

Approved by: Robert F. Dell
Thesis Co-Advisor

LTC P. Lee Ewing
Thesis Co-Advisor

W. Matthew Carlyle
Second Reader

James Eagle
Chairman, Department of Operations Research

THIS PAGE INTENTIONALLY LEFT BLANK

ABSTRACT

The United States (U.S.) Army's mission is to protect our nation and fight its wars; a mission that requires a substantial resource commitment. The Army today consist of over 505,000 soldiers (more than any other U.S. military service), with over 81,000 of those soldiers comprising the Officer Corps. This thesis develops a linear program to help manage the Army Competitive Category (ACC), a subset of the officer corps consisting of over 51,000 soldiers. The Total Army Competitive Category Optimization Model (TACCOM) prescribes annual accessions and above zone, primary zone, and below zone promotion rates for all grades from Lieutenant to Colonel over a forty-year horizon. We demonstrate TACCOM using data from fiscal year (FY) 2006 and requirement information for all officers in the ACC and also for the subset of officers just in the Aviation (AV) branch. We find a deficit at the grade of Major (MAJ) will continue to exist through FY 2021 if current policy is not changed. Our analysis on just the AV branch shows their mid-grade officer shortage can be remedied by either increasing training capacity by two-thirds, or reducing the attrition of Captains who have five years time in grade. Our analysis also shows the current ACC accessions plan and promotion policies remedy the shortages at the grade of MAJ for the next seven consecutive years, but that there are future shortages ahead. Using TACCOM, we find that one way to reduce the magnitude of the future shortfalls is to adjust the current promotion policy by increasing the number of early promotions to MAJ. By accelerating the promotion to MAJ in the ACC the Army is only facing a shortage of MAJs for four consecutive years, from FY 2013 through FY 2017, versus the seven year shortage without a policy change.

THIS PAGE INTENTIONALLY LEFT BLANK

TABLE OF CONTENTS

I.	INTRODUCTION.....	1
A.	PURPOSE.....	1
B.	BACKGROUND.....	1
C.	PROBLEM STATEMENT AND THESIS OUTLINE.....	5
II.	OFFICER MANAGEMENT	7
A.	HISTORY OF OPMS.....	7
B.	MANAGEMENT TOOLS.....	9
1.	Accessions	9
2.	Promotions.....	10
C.	MANAGEMENT GOALS	11
D.	TOOLS AND DECISIONS AIDS	11
E.	RELATED WORK.....	12
III.	MANPOWER PLANNING MODEL	15
A.	ASSUMPTIONS.....	15
B.	PROBLEM FORMULATION	17
1.	Objective Function.....	18
2.	Inventory Constraints.....	18
3.	Primary Zone Promotion Constraints	19
4.	Below the Zone Promotion Constraints.....	19
5.	Above the Zone Promotion Constraints	19
6.	Roll Down Constraints	19
7.	Accessions Constraints	20
8.	Nonnegative Constraints	20
C.	EXPLANATION OF THE MODEL.....	20
1.	The Objective Function	20
2.	Constraints.....	20
IV.	ANALYSIS AND RESULTS	21
A.	MODEL IMPLEMENTATION	21
1.	Assumptions	21
2.	Data	21
a.	<i>Targets and Inventories</i>	<i>21</i>
b.	<i>Parameters for Time in Grade.....</i>	<i>22</i>
c.	<i>Attrition Rates</i>	<i>22</i>
d.	<i>Bounds for Promotion Rates</i>	<i>23</i>
3.	Determining Weights.....	23
B.	SCENARIOS.....	24
1.	Army Competitive Category Scenario.....	25
2.	Aviation Branch Scenario	30
a.	<i>TACCOM Limited to Current Accession Plan</i>	<i>30</i>
b.	<i>TACCOM with Unconstrained Accessions</i>	<i>33</i>

<i>c.</i>	<i>TACCOM with Unconstrained Accessions and Adjusted CPT Attrition Rate</i>	<i>36</i>
<i>d.</i>	<i>Policy Option Comparison.....</i>	<i>39</i>
C.	SUMMARY	44
V.	CONCLUSIONS AND FUTURE RESEARCH.....	47
	APPENDIX. TACCOM DATA	49
	LIST OF REFERENCES.....	53
	INITIAL DISTRIBUTION LIST	55

LIST OF FIGURES

Figure 1.	Army Strength Analysis Forecast.....	4
Figure 2.	Officer Career Path Shown through a Network.....	16
Figure 3.	TACCOM ACC Accession Plan.....	25
Figure 4.	TACCOM Annual MAJ inventory prescription.....	27
Figure 5.	TACCOM Annual ACC CPT Inventory based on current Army accession plan.....	28
Figure 6.	TACCOM Annual MAJ Inventory based on accelerated promotion to MAJ.....	29
Figure 7.	The Current AV Branch Officers' Accession Plan.....	31
Figure 8.	The Future Annual AV MAJ Officer Inventory Given Current Army Policy.....	32
Figure 9.	The Future Annual AV CPT Officer Inventory Given Current Army Policy.....	33
Figure 10.	TACCOM AV Accession Plan when no Limit on the Number of Accessions.....	34
Figure 11.	TACCOM Annual AV MAJ inventory when no Limit on the Number of Accessions.....	35
Figure 12.	TACCOM Annual AV CPT Inventory.....	36
Figure 13.	TACCOM AV Accession Plan with no Limit on Number of Accessions and a 25% Attrition at CPT with Five Years TIG.....	37
Figure 14.	TACCOM Annual AV MAJ Inventory based on Reduction in Attrition at the Grade of CPT.....	38
Figure 15.	TACCOM Annual AV CPT Inventory based on Reduction in Attrition at the grade of CPT.....	39
Figure 16.	TACCOM AV Branch Policy Option Comparison.....	40
Figure 17.	Promotion Policy Impacts on the AV MAJ Officer Inventory.....	43
Figure 18.	Promotion Policy Impacts on the AV CPT Officer Inventory.....	44

THIS PAGE INTENTIONALLY LEFT BLANK

LIST OF TABLES

Table 1.	The OPMS Functional Alignments.....	8
Table 2.	DOPMA and Army Minimum Promotion Rates.	9
Table 3.	The FY 2007 shortage at the grade of MAJ.....	22
Table 4.	The promotion opportunity rate provided by the Army and used by TACCOM.	23
Table 5.	The annual investment the Army estimates per grade.	24
Table 6.	The DAPE-PRS officer inventory projected shortages as of November 2006.....	26
Table 7.	MAJ Fill Rate Percentages.....	41
Table 8.	The initial ACC and AV branch officer inventory data.....	49
Table 9.	The current ACC officer requirements as established by the PMAD.....	49
Table 10.	The current AV officer requirements as established by the PMAD.	49
Table 11.	The TIG of the ACC inventory.	50
Table 12.	The TIG of the AV officer inventory.....	50
Table 13.	ACC attrition rates used in the TACCOM.....	51
Table 14.	AV attrition rates used in the TACCOM.	51

THIS PAGE INTENTIONALLY LEFT BLANK

LIST OF ACRONYMS AND ABBREVIATIONS

1LT	First Lieutenant
2LT	Second Lieutenant
AZ	Above Zone
ACC	Army Competitive Category
AR	Armor
AV	Aviation
BARON	Budget Allocation Resource of Notional Force
BR	Branch
BZ	Below Zone
CCATS	Competitive Category Army Tracking System
COL	Colonel
COMPLIP	Computation of Manpower Programs Using Linear Programming
CPT	Captain
DAPE-PRS	Military Strength Analysis and Forecasting Division, Office of the Deputy Chief of Staff for Personnel
DOPMA	Defense Officer Personnel Management Act
ELIM	Enlisted Loss Inventory Model
FY	Fiscal Year
GAMS	General Algebraic Modeling System
HRC	Human Resource Command
IN	Infantry
LT	Lieutenant
LTC	Lieutenant Colonel
MAJ	Major
MFE	Maneuver, Fires, and Effects
MLPRS	Manpower Long-Range Planning System

OCS	Officer Candidate School
OPMS	Officer Professional Management System
OPMS XXI	Officer Professional Management System 21
OPTEMPO	Operational Tempo
PMAD	Personnel Manning Authorization Document
PZ	Primary Zone
ROTC	Reserve Officer Training Corps
TACCOM	Total Army Competitive Category Optimization Model
TIG	Time in Grade
TAPLIM	Total Army Personnel Lifecycle Model
TTHS	Trainees, Transients, Holdees, and Students
U.S.	United States
USMA	United States Military Academy
YG	Year Group

ACKNOWLEDGMENTS

I would like to thank everyone who made this thesis possible. I would like to thank GOD for the strength to endure this rigorous process, he has allowed me to push my academic limits further than I ever thought possible. Special thanks to Professor Dell for your ability to make complex concepts easy to understand. I appreciate your guidance and direction in this endeavor. This has been the most humbling experience in my life, and I am a better man for it.

My gratitude goes to LTC Lee Ewing. He provided me with an enormous amount of help. Without his guidance, I could not have told my story in a professional manner. I know that this thesis would not be possible without his insight, and willingness to teach me what I needed to know to get started.

I would like to thank LTC Mark Lukens. He made my experience into a truly invaluable professional development opportunity. I thank him for presenting the problem and giving a clear concise framework for the problem. I was truly prepared to dig into my thesis because of his efforts.

My gratitude goes to Professor Matt Carlyle, who has assisted me greatly in model development, and the unique aspects of CPLEX. Thank you for helping complete this academic endeavor. Your enthusiasm motivates me to continue learning more.

The most important people I must acknowledge are my wife Nicole and my daughters Madeline and Morgan. Thank you Nicole for supporting me as I burned myself out the first year of this program, and then put in late nights to work on my thesis. A man could have no better partner than you. Madeline I appreciate your hugs and kisses when I came home from school, and Morgan I love the smile you developed in Monterey. Without the love and support of my ladies, I would not have survived this program. I love you.

THIS PAGE INTENTIONALLY LEFT BLANK

EXECUTIVE SUMMARY

The United States (U.S.) Army's mission is to protect our nation and fight its wars; a mission that requires a substantial resource commitment. The Army today consist of over 505,000 soldiers (more than any other U.S. military service), with over 81,000 of those soldiers comprising the Officer Corps. This thesis develops a linear programming model to help manage the Army Competitive Category (ACC), a subset of the officer corps consisting of over 51,000 soldiers. Our model, the Total Army Competitive Category Optimization Model (TACCOM), prescribes annual accessions and above zone, primary zone, and below zone promotion rates for all grades from Lieutenant (LT) to Colonel over a forty year horizon. We use TACCOM and data provided by the Army to analyze two scenarios.

Our first scenario looks at the ACC inventory and requirements under current Army promotion policy. Based on the current policy, TACCOM proposes annual LT accession and promotions at all grades to meet future requirements at all grades, but we focus our analysis on a pending deficit at the grade of MAJ. We also look at the effect of accelerating promotion to Major (MAJ) by one year on the inventory.

Our second scenario focuses on the Aviation (AV) Officer inventory. TACCOM proposes AV LT accession and promotions at all grades to meet future Army requirements, again with a focus on future deficits at the grade of MAJ. We also examine at the benefit of accelerating promotion to MAJ by one year, and other policy changes.

For the ACC scenario, we find the Army's current accession plan ("current plan") over the next five years similar to what TACCOM proposes. However, under the current plan, the Army will not satisfy its yearly requirements at the grade of MAJ for the next five years (FY 2008 - FY 2012), and for five years in the future (FY 2013 – FY 2018). TACCOM does better: its prescriptions provide a fill rate of 87.14% at the grade of MAJ in FY 2007 (0.74% better than the current plan); a 85.24% fill rate in FY 2008 (again, 0.74% better than the current plan); a 90.22% fill rate in FY 2009 (better than the current plan but exact data is not available for comparison); and 100% fill rate by FY 2010

(again, better than the current plan but exact data is not available for comparison). Additionally, with TACCOM prescriptions, the Army is only facing a shortage of MAJs for four consecutive years, from FY 2013 through FY 2017, versus the seven year shortage.

TACCOM analysis for the AV branch scenario indicates the current AV branch accession plan should be reviewed as it will take an enormous training effort in FY 2009 and FY 2010 to meet the future requirements at the grade of MAJ. Because it is most likely not feasible to ramp up the training effort to a capacity required to meet the AV manning requirements, we propose that the AV branch focuses its efforts on reducing its attrition at the grade of Captain with five years time in grade (TIG) by 50%. With these efforts the future fill rate at the grade of MAJ only goes as low as 86.46%. This is significantly better than the current plan, where the inventory of AV MAJs is below the critical threshold of 85% fill rate starting in FY2015 and stays below for all future years. The ability to compare policies is also insightful, and with the TACCOM we notice that it may be possible to become more selective in the Army's promotion system, at least in the AV branch.

Our analysis shows that retaining officers (at least for the AV branch) is a key aid to filling future officer requirements. At the current operational pace and constant Army transformation, it is imperative the appropriate actions are taken to minimize the future mid-grade officer gap.

I. INTRODUCTION

A. PURPOSE

The United States (U.S.) Army's mission is to protect our nation and fight its wars; a mission that requires a substantial resource commitment. The Army today consist of over 505,000 soldiers (more than any other U.S. military service), with over 81,000 of those soldiers comprising the Officer Corps. The Office of the Deputy Chief of Staff for Operations (Army G-3) develops the force structure requirements for the U.S. Army that prescribes the personnel required to effectively operate the Army organization [U.S. Government Accountability Office, 2006]. The Office of the Deputy Chief of Staff for Personnel (Army G-1) manages the personnel inventory to fill the force structure.

Since the start of the Global War on Terror, the Army has continuously conducted major combat operations, while at the same time attempting to transform itself into a future force. The Army G-3 has developed a force structure that the Army G-1 cannot man with the current officer inventory, and it will take years before the officer inventory is sufficient, because (unlike the private-sector where middle managers are hired and fired based on the needs of the organization) the Army must grow its leaders starting at initial entry.

This thesis develops a linear program to help manage the Army Competitive Category (ACC), a subset of the officer corps consisting of over 51,000 soldiers. The Total Army Competitive Category Optimization Model (TACCOM) prescribes annual accessions and above zone (AZ), primary zone (PZ), and below zone (BZ) promotion rates for all grades from Lieutenant (LT) to Colonel (COL) over a forty year horizon.

B. BACKGROUND

The American soldier remains the Army's primary focus, the centerpiece of all that we do as an Army. Throughout the Army's history, soldiers have answered the call to end tyranny, to free the oppressed and to light the path to democracy for struggling nations [U.S. Army, 2005b]. In order to have an effective fighting force, a nation must have a sufficient number of competent and capable leaders.

The Army currently consists of 81,579 officers divided into two separate categories [Haight, 2006]. The largest of these categories is the ACC which consists of all Army branches and career fields except specialty branches (such as the Medical Service Corps, the Veterinary Corps, Chaplains Corps, etc.). The Army also divides its total inventory of personnel, known as its military account, into three components; (a) the operational force that is available for missions, (b) the institutional force that is available to support the operational force in a training capacity and higher headquarters, and (c) the Trainees, Transients, Holders, and Students (TTHS) that are not available to fill the operational force due to training, permanent change in station, or who are in retirement status. Due to the size of the Army's military account, forecasting and monitoring its personnel is an important aspect of force structure planning and execution. The personnel proponent within the Army is the Army G-1. Different organizations within the Army G-1 contribute to personnel management such as, the Military Strength Analysis and Forecasting Division (DAPE-PRS) who monitors and forecasts the personnel inventory.

The DAPE-PRS conducts officer forecasting based on the Personnel Manning Authorization Document (PMAD). The force structure established by the Army G-3 facilitates the PMAD. The DAPE-PRS forecasts its manning requirements over a seven year time horizon based on budgetary constraints from the Offices of the Secretary of Defense. The Army G-3 determines the size of the force based on the Army Chief of Staff's guidance. Once the force structure has the Army Chief of Staff's approval, the Army G-1 develops the appropriate manning structure [Haight, 2006]. DAPE-PRS currently uses decision aids implemented in a spreadsheet and provides forecasts of officer inventory over an 84 month time horizon [U.S. Army, 2006].

The Army maintains a standard career progression for its officer corps. All officers in the ACC start as 2nd Lieutenants (2LT) (which is accessions) and are promoted based on time in grade and performance through the rank of COL. The Army manages its officers by Year Group (YG), or cohort. A YG is a group of officers who are commissioned within a specific fiscal year (e.g., officers commissioned in FY 1997 are tracked as YG 1997). Over a 30 year period, the system historically has been set-up in a

pyramid fashion. The intent is to have enough senior leaders to lead the operational force from each YG over a military career, with “career” defined as being between 30 to 40 years.

Since 2002, the Army has been transforming itself from a division centric force to a modular force; placing new demands on the officer force that current projections show will not be satisfied until 2013. The Army transformation has caused the basic structure of the Army to be mid-grade officer intensive. With the Army’s continued involvement in the “War on Terror,” and the size of the force required in the current global environment, the Army’s shortages will continue for at least the next six years if the Army continues at the current operational tempo (OPTEMPO) [Henning, 2006]. Unfortunately, due to the lean accessions from FY 1995 through FY 1999; for fiscal year (FY) 2007 the Army projects an officer shortage of nearly 3,000, with the most acute shortfalls in senior Captains (CPT) (i.e. those with time in grade (TIG) greater than five years) and Majors (MAJ) with 11 to 17 years of experience. The Army considers any personnel “fill rate” (the number of officers available to fill requirements) of less than 85% per year, a “critical” shortage, and projects a fill rate of only 82.6% for MAJs in the ACC in FY 2007. Figure 1 illustrates the current state of the Army’s ACC as of November 2006. The Army actually started to fall short of personnel in September 2006. [Lukens, 2006]

THE ACC OFFICER GAP

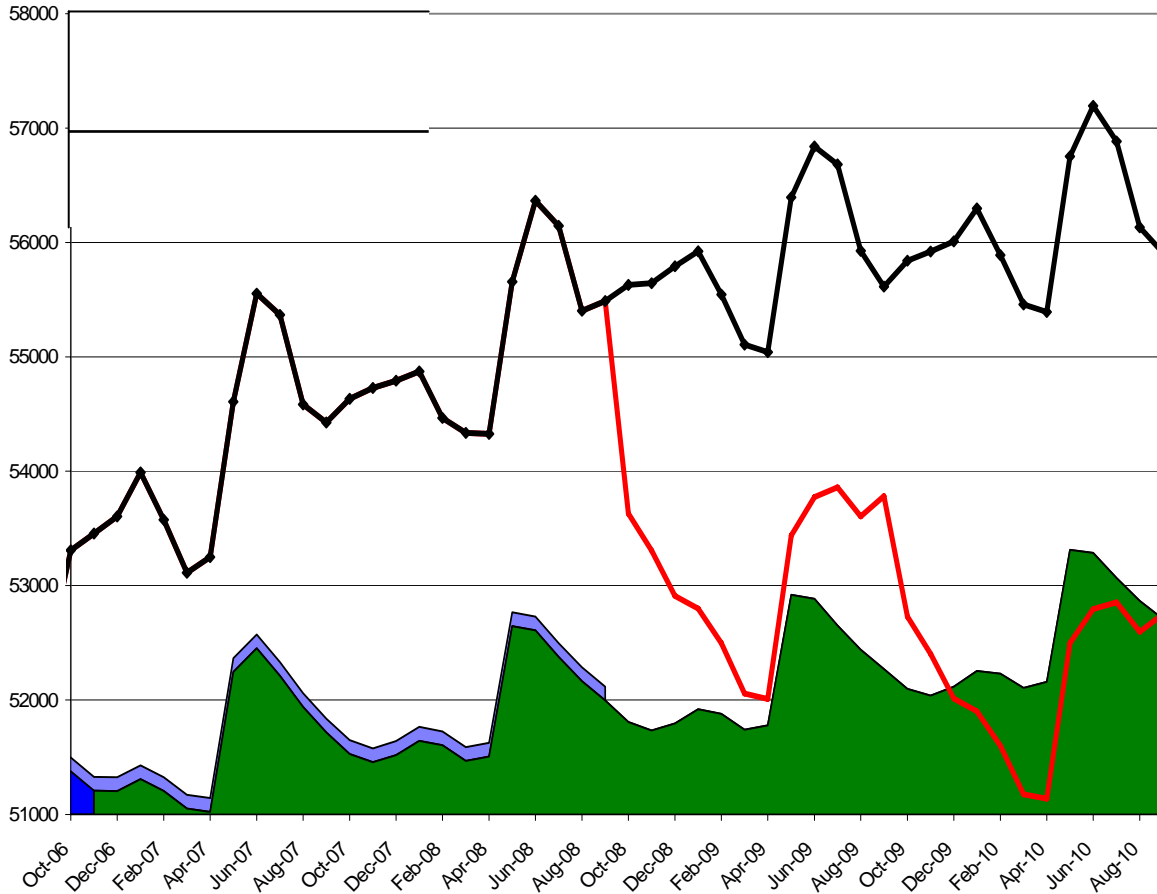

Figure 1. Army Strength Analysis Forecast.

Figure 1 shows the Army Strength analysis forecast. The numbers along the Y-axis represent the number of ACC officers in the inventory. The X-axis represents the month and year. The black line with boxes on the chart shows the force structure requirements consisting of authorized personnel plus TTHS from October 2006 to August 2010. The smooth red line decreasing starting in October 2008 illustrates the effects on the inventory if the Army is reduced to an end-strength of 482,400. The blue area represents the historical strength while the green area represents the forecasted strength through FY 2010. Where the green area does not meet the black line there is an officer deficit. (After Lukens [2006]).

To combat the mid-grade officer shortage, the Officer Retention Division within the Human Resources Command (HRC) has developed a variety of incentives to retain

targeted officers. Additionally, the Army G-1 is re-evaluating current eligibility requirements for promotion to the mid-grade ranks. TACCOM can help the Army quickly investigate the long-term consequences of today's policy decisions as they look for the best way to grow the officer corps.

C. PROBLEM STATEMENT AND THESIS OUTLINE

This thesis develops a linear program to help manage the ACC, a subset of the officer corps consisting of over 51,000 soldiers. The TACCOM prescribes annual accessions and AZ, PZ, and BZ promotion rates for all grades from LT to COL over a forty year horizon. Chapter II describes how the Army officer inventory is managed using the current Officer Personnel Management System (OPMS). Chapter III presents TACCOM. In Chapter IV, we explore the future officer requirements, and look at how different policy decisions can affect the officer inventory. Chapter V provides conclusions and recommendations for future research.

THIS PAGE INTENTIONALLY LEFT BLANK

II. OFFICER MANAGEMENT

This chapter describes the management of the ACC officer inventory under the Officer Personnel Management System (OPMS). It reviews OPMS history, Army personnel management tools and goals, current DAPE-PRS spreadsheet models and concludes with a review of related work and literature.

A. HISTORY OF OPMS

The Army uses OPMS to manage its inventory of officers. This system has undergone several changes since 1970. From 1970 to 1997, the system was primarily a Dual-Track system because it allowed an officer to choose to receive additional qualifications in a specialty function; for advancement purposes, OPMS placed a higher emphasis on success in senior command positions. This system stood the test of time for over two decades, but the Army lost many highly qualified officers in specialty functions because of a lack of command opportunities [Lukens, 2006]. OPMS today hopes to give all officers a broad experience, and make the Army's future leaders better strategic thinkers. Additionally, OPMS assists with the retention of the best officers by giving them more opportunities for advanced civilian education and positions outside of their basic branches [Gillen, 2006].

OPMS XXI replaced the dual-track system in 1997. The dual-track version of the officer corps historically aligned officers into three categories; (a) Combat Arms, (b) Combat Support, and (c) Combat Service Support. These categories were replaced in 1997 with OPMS XXI; (a) the Operational Career Field, (b) Operational Support, (c) Institutional Support, and (d) Institutional Operations. OPMS XXI allowed an officer to specialize and placed higher emphasis on an officer's ability to do a specialized job, versus his ability to perform in senior level leadership roles. This gave officers who chose to leave the operational force an opportunity for advance civilian schooling, and the unique opportunity to become an expert in a specific arena. Additionally, this system broadened the command opportunities for those officers who aspired to senior leadership positions in the operational force. The primary drawback to OPMS XXI was that the officers who chose to lead the operational force had very limited opportunities to do jobs

outside of their respective branches. This type of limitation over time created a narrowly focused officer who, through no fault of his/her own, did not have enough broad experiences to become the strategic thinker needed to lead today's force. Thus, the Army evolved again [Knighton, 2006].

The OPMS Officer Corps re-aligned into three categories; (a) Maneuver, Fires, and Effects (MFE), (b) Operational Support, and (c) Force Sustainment. The Operational Support and Force Sustainment categories are critical to supporting and maintaining the operational forces (MFE branches). However, the MFE branches drive the initial accession requirements of the Army due to the high number of junior officers required to fill these branches. Table 1 illustrates the MFE branches. [Gillen, 2006]

Maneuver, Fires, and Effects	
Maneuver	Fires
ARMOR	FIELD ARTILLERY
INFANTRY	AIR DEFENSE ARTILLERY
AVIATION	
Effects	
INFORMATION OPERATIONS	
PUBLIC AFFAIR OPERATIONS	
Maneuver Support	Special Operations Forces
ENGINEERS	SPECIAL FORCES
CHEMICAL CORPS	CIVIL AFFAIRS
MILITARY POLICE	

Table 1. The OPMS Functional Alignments.

Table 1 shows the functionally aligned OPMS. The Maneuver, Fires, and Effects Branches are what all other branches support. The Army aligned the career fields with the appropriate basic branches. (After U.S. Army [2007])

B. MANAGEMENT TOOLS

Although the Army forecasts its officer requirements over a seven year time horizon for budgetary reasons, the Army manages a typical officer’s career over 30 years; a small number of senior leaders are managed through 40 years of service. The intent is to have enough senior leaders to lead the operational force from each YG over a military career. The primary controls utilized to manage the officer corps are accessions and promotions.

The law dictates the number of officers the Army may maintain on active duty and promote. For example, the provisions established by the 1980 Defense Officer Personnel Management Act (DOPMA) establishes guidelines for Army officer promotions (Table 2) [U.S. Congress, 1981]. The promotion opportunity rate is equal to the number of officers selected for promotion from the three zones (below the Zone (BZ), primary zone (PZ), and above the zone (AZ)) divided by the number of officers eligible in the PZ.

Officer Pay Grade	Opportunity for Promotion (Percentage promoted to grade)	Timing of Promotion (Years of service)
O-1 and O-2	100 if Fully Qualified	1.5
O-3	95	3.5 to 4
O-4	80	10 ± 1
O-5	70	16 ± 1
O-6	50	22 ± 1

Table 2. DOPMA and Army Minimum Promotion Rates.

Table 2 shows the guidelines that the Army must adhere to based on the DOPMA policy (After Schirmer [2006]).

1. Accessions

The Army depends on Accessions Command to appropriately manage the training of officers. It has three primary sources for its pool of officers, the United States Military Academy (USMA) at West Point, New York, the Reserve Officer Training Corps

(ROTC), and the Officer Candidate School (OCS), at Fort Benning, Georgia. These three sources produce a constant stream of officers annually to the Army Officer Corps. USMA produces from 850 to 1,000 2LTs each year, OCS produces from 1,500 to 1,900 new 2LTs, and ROTC produces over 2,200 new officers for the active force. [Lukens, 2006]

Officers normally leave the ACC through three avenues: completion of service obligation; reaching retirement eligibility; or are released. The officer loss rate at the middle management level causes the number of officers that the Army brings into the organization by accessions extremely important.

2. Promotions

Because the Army commissions all officers in the ACC as 2LT, it is vital that the Army manages its inventory at senior grades through promotions. The Army plans on promoting every qualified 2LT to 1LT. The Army may deviate from the DOPMA goals shown in Table 2 based on its requirements.

The Army starts to conduct promotion boards for the rank of CPT and above with each rank having its own board. All boards consist of a general officer as the president and seniors officers, at least one to two grades higher than the officers being considered, but none of the members can be lower than a Lieutenant Colonel (LTC). The promotion boards meet annually and HRC publishes the board for respective FY on or about September. The function of the boards are to review all eligible officers records and determine who is qualified to move the next grade, based on specific guidance from the Chief of Staff, Army [U.S. Army, 2005c].

Promotion boards consider officers in three zones: BZ, PZ, and AZ. For example, an officer commissioned in FY 1997 or in YG 1997 are considered to be in the “primary zone” for promotion to CPT, MAJ, LTC, and COL in FY 2001, 2006, 2013, 2018. All officers in YG 1997 have their records reviewed one year prior to their PZ board, and a small number of officers who have performed exemplary are promoted BZ to MAJ, LTC, or COL, with these boards occurring in 2005, 2012, or 2017. Also, there are a number of officers who are not selected for promotion to the next grade during their

PZ board, and these officers are considered for promotion over the next two years, which is known as AZ. If they are not selected AZ, these officers may elect to be retained at their current grade until retirement eligibility [U.S. Army, 2005c].

The current operating environment has caused the Army to closely look at how it promotes its officers. Due to the increased number of mid-grade officers required in the operational force and Army Transformation, the promotion opportunities afforded to Army Officers are the highest they have ever been. It takes up to eight years to grow a mid-grade officer, so even with a dramatic increase in accessions; the current inventory issue will not be corrected in the near future.

C. MANAGEMENT GOALS

The PMAD sets structure for the Army, from this document the DAPE-PRS establishes a target number of officers for each grade by branch and category [U.S. Army, 2005a]. These targets represent the number of officers required by the Army to complete its mission. In practice, the officer inventory does not meet these targets exactly. However, meeting these targets for field grade officers is necessary to comply with U.S. law. The most stringent requirement is that the number of COLs cannot exceed its target. For LTC, the requirement is slightly more relaxed; the combined number of LTCs and COLs cannot exceed the sum of their targets. Likewise, the combined number of MAJs and LTCs cannot exceed the sum of their targets. The Army calls this process of satisfying field grade and congressional mandates for field grade officers “target roll down” [Yamada, 2000].

D. TOOLS AND DECISIONS AIDS

The Army G-1, DAPE-PRS ensures proper forecasts are done in order to fulfill the Army’s manning requirements. The organization has developed a spreadsheet model to accomplish this task.

DAPE-PRS updates their spreadsheet model monthly to forecast the inventory versus the requirement over the next 84 months. This tool is critical, because it allows for quick analysis of multiple policy issues that decision makers must combat daily. The spreadsheet model took the place of two antiquated models Budget Allocation Resource

of Notional (BARON) Force and the Competitive Category Army Tracking System (CCATS). These two models were virtually the same, but were unable to address the critical issues with the management of the total Officer Corps [Haight, 2006]. Neither BARON nor CCATS provided management control decisions such as setting accession and promotion rates that best met the inventory (or strength) targets. Neither incorporated OPMS XXI, which separates officers with a rank of MAJ or higher into four career fields. Neither BARON nor CCATS accounted for end effects due to having too short a planning horizon [Yamada, 2002]. BARON and CCATS did not allow for quick analysis.

The TACCOM allows the DAPE-PRS to conduct analysis on the future officer corps by looking at the time in grade (TIG). The current model focuses on the aggregate inventory by grade and branch, but lends no insight on when is the pivotal TIG during an officer's career (with "pivotal" defined as the TIG when officers are deciding to leave the Army).

E. RELATED WORK

The operations research literature contains a rich variety of papers answering a myriad of manpower issues. The following are examples of literature which focuses on Army specific manpower issues.

Holz and Wroth [1980] developed a linear program called the Enlisted Loss Inventory Model (ELIM), in order to assist the Army drawdown its personnel end strength after the Vietnam conflict. The ELIM in conjunction with the Computation of Manpower Programs Using Linear Programming (ELIM-COMPLIP) was first used in FY 1972. Over the 1970s and through the 1980s ELIM-COMPLIP enabled senior leaders in DoD to accurately forecast the impact of major policy decisions on the Army's manpower. ELIM-COMPLIP looked at the Army's monthly inventory and forecast on a seven year time horizon. One example of the ELIM-COMPLIP's utility, was in 1974 when the "Army had 13 combat divisions, and the Joint Chiefs of Staff thought that a 16-division Army was needed to meet national defense commitments." During this period, the U.S. Senate had recently passed a reduction of support troops in the European theater. Since standing-up three additional combat divisions meant adding over 16,000 soldiers to

the operational Army, the ELIM-COMPLIP projected that although the operating strength of the Army would increase by almost 40,000 soldiers the Army could remain at 785,000. The ELIM-COMPLIP gave insights on proposals for length of enlistments, retention policies, and budgetary decisions. [Holz and Wroth, 1980]

Durso and Donahue [1995] developed the Total Army Personnel Lifecycle Model (TAPLIM) in 1991 in response to the Defense Authorization Act, requiring the military services to dramatically reduce manpower. The TAPLIM remained a primary tool in the Army G-1 through the 1990s. TAPLIM primarily assisted Army decision makers to combat the rapid drawdown after Desert Storm. The linear program that Durso and Donahue developed has weights on the inventory accessions, losses, and promotions with the intent to minimize the operating strength deviation. The weights translated to the cost to the Army for various decisions in a given year. The insights from their model allowed the Army to determine how many soldiers it needed to access, promote, or release on a 15 year time horizon. [Durso and Donahue, 1995]

Gass et al [1988] developed The Army Manpower Long-Range Planning System (MLPRS). This tool provided the Army with the analytical capability to project the strength of the active force out twenty years. The MLPRS development stage began in 1982. Over a three year period it was moved to the Army's primary computers, and by 1987 the Army utilized the MLPRS to project strength of the Army over a 20 year horizon at skill, years-of-service, and grade level of detail. The Army utilized this system into the early 1990s. The MLPRS is not just one model but is divided into three subsystems: The Data Processing Subsystem; The Flow Model Subsystem; and The Linear Program. Gass's MLPRS gave insight on the impact of competing goals on the Army Force structure [Gass et al, 1988].

Corbett [1995] developed a multi-year linear program designed to maximize the Army's ability to meet forecasted requirements. His model looked across all branches to determine how many junior officers are needed to not only fill the LT ranks, but also how many initial entry combat arms officers would it require to ensure there are enough mid-grade officers available to transition to the non-combat arms branches later in their

career. Corbett focused on techniques from goal programming to give insights to the Army's accessions problem. In our literature research, we cannot find any evidence of the model that Corbett developed was ever used.

More recently Yamada [2000] looked at the ACC of the OPMS XXI. He focused his efforts on developing an Infinite Time Horizon Manpower Planning model. Unlike the other models in this literature review, where there is normally a finite time horizon or particular goal to meet, Yamada's model allows for the uncertainty of military manpower planning, and looks out over an infinite time horizon. His linear program gave insights to decision maker on the management of the ACC. Yamada used OPMS XXI to constrain his model and allow for appropriate analysis [Yamada, 2000]. In our literature research, we cannot find any evidence of the model that Yamada developed was ever used.

Shrimpton and Newman [2005] developed a network optimization model to assist the Army in designating its officers into career fields under OPMS XXI. They created a model that could easily run on a windows based computer system. The model allowed the Army G-1 to determine the number of officers the Army required per career field, and created an upper and lower bound for career field designations boards to consider when assigning officers. The model developed by Shrimpton and Newman was used four times since 2001, assigning over 10,500 officers to career fields.

These are but a few examples of how linear programming has enabled analyst to answer difficult personnel issues. The decision makers are constantly concern if the personnel strength is adequate to fill current and future requirements.

III. MANPOWER PLANNING MODEL

A. ASSUMPTIONS

The following are the Total Army Competitive Category Model (TACCOM) assumptions.

1. The promotion rates are set by DOPMA.
2. The inventory for a year is the officer inventory on September 30th of the year. The model looks annually at the inventory based on time in grade.
3. To allow more flexibility, the TACCOM's PZ, AZ, BZ, Roll down, and accession constraints are elastic. An elastic constraint can be violated at a cost per unit violation [Brown, Dell, and Newman, 2004]. We show elastic constraints by $\overset{o}{\leq}$.

Figure 2 illustrates the flow of officers through the Army career progression in terms of a network. Officers are first accessed through their source of commission, and then move through the network by grade and time in grade. Officers move from one grade to another through promotions.

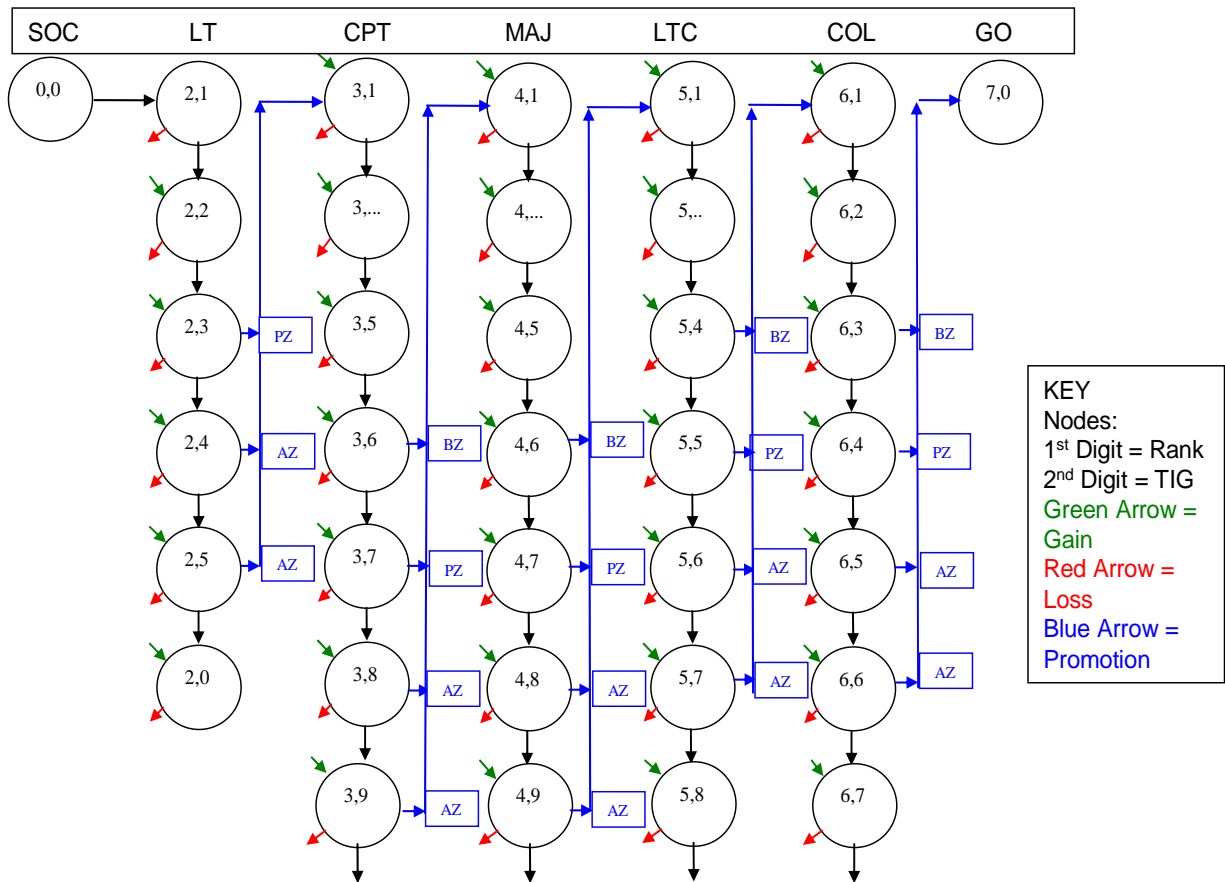

Figure 2. Officer Career Path Shown through a Network.

Figure 2 shows the officer career path as a network. Each node represents a grade at a given time in grade (for example the node labeled (4, 1) represents officers who have been MAJs for one year) inside the nodes). The LT includes 2LTs and 1LTs. Officers are only eligible for promotions during certain periods for a given grade during their career. The green arrows at the top left of each node represent gains into a node, and the red arrows at the bottom left of each node represent losses. The blue arrows represent promotion out of a grade (After Lukens [2006]).

B. PROBLEM FORMULATION

Indices

y	year of planning horizon, $y = 1, 2, 3, \dots$
g	grade, $g = \text{LT, CPT, MAJ, LTC, COL, BG}$
t	years of service based on time in grade
b	Branch, $\text{BR} = \text{IN, AR, AV} \dots$
(g,t,b)	valid combinations of grade g , time in grade t , and branch b , e.g. $(\text{CPT},6,\text{AV}), (\text{MAJ},6,\text{AV}), (\text{LTC},5,\text{AV}), (\text{COL},5,\text{AV})$.

Data

$\alpha_{g,y}$	discount factor in grade g , for year y , $0 < \alpha_{g,y} < 1$
$\underline{acc}_y^b, \overline{acc}_y^b$	minimum and maximum number of lieutenants to access in year y for branch b \underline{acc}_y^b and \overline{acc}_y^b may be the same.
$Req_{g,y}$	total number of officers required to meet the Army needs at grade g during year y
$tgt_y^{g,b}$	targeted number of officers in grade g in branch b at the end of year y
$lr_y^{g,t,b}$	proportion of officers in grade g , time in grade t in branch b who leave during year y
TIG_g	time in grade based on grade g
$\underline{pzp}_g, \overline{pzp}_g$	minimum and maximum promotion opportunity rate for promotion to grade g
$\underline{bzp}_g, \overline{bzp}_g$	minimum and maximum proportion of officers who are promoted from the below zone to grade g
$\underline{azp}_g, \overline{azp}_g$	minimum and maximum proportion of officers who can be promoted from the above zone to grade g
$bg_y^{g,t,b}$	the number of brigadier generals selected in year y , from the grade colonel g population (number of officers) in time in grade t in branch b

Nonnegative Variables: (Decision Variables)

$X_y^{g,t,b}$	number of officers at grade g , time in grade t at the end of year y in branch b . To simplify the inventory balance constraints, $X_{y=0}^{g,t,b}$ represents an initial number of officers in grade g .
$Dev_{g,y}$	the difference between what the Army needs at a particular grade g during year y versus what is available.
$PZ_{y,g,t,b}$	number of officers promoted from the primary zone to grade g and with time in grade t in branch b during year y
$BZ_{y,g,t,b}$	number of officers promoted from the below zone to grade g and with time in grade t in branch b during year y
$AZ_{y,g,t,b}$	number of officers promoted from the above zone to grade g and with time in grade t in branch b during year y
A_y^b	number of lieutenants accessed into the Army during year y in a given branch b

1. Objective Function

$$\text{Minimize } \sum_y \sum_g \alpha_{g,y} Dev_{g,y} + \text{Elastic Penalties} \quad (3.1)$$

Subject to:

2. Inventory Constraints

$$\begin{aligned}
X_y^{LT,t,b} - A_y^b - (1 - lr_y^{LT,t,b}) X_{y-1}^{LT,t-1,b} + PZ_y^{CPT,t-1,b} + AZ_y^{CPT,t-1,b} &= 0 & \forall y > 1, t, b \\
X_y^{CPT,t,b} - (1 - lr_y^{CPT,t,b}) X_{y-1}^{CPT,t-1,b} - \left[PZ_y^{CPT,TIG_{CPT},b} + \sum_{t'=TIG_{CPT}+1}^{TIG_{CPT}+2} AZ_y^{CPT,t',b} \right]_{IF \ t=1} \\
+ BZ_y^{MAJ,t-1,b} + PZ_y^{MAJ,t-1,b} + AZ_y^{MAJ,t-1,b} &= 0 & \forall y > 1, t, b \\
X_y^{MAJ,t,b} - (1 - lr_y^{MAJ,t,b}) X_{y-1}^{MAJ,t-1,b} - BZ_y^{MAJ,t,b} - PZ_y^{MAJ,t,b} - AZ_y^{MAJ,t,b} \\
+ BZ_y^{LTC,t-1,b} + PZ_y^{LTC,t-1,b} + AZ_y^{LTC,t-1,b} &= 0 & \forall y > 1, t, b \quad (3.2) \\
X_y^{LTC,t,b} - (1 - lr_y^{LTC,t,b}) X_{y-1}^{LTC,t-1,b} - BZ_y^{LTC,t,b} - PZ_y^{LTC,t,b} - AZ_y^{LTC,t,b} \\
+ BZ_y^{COL,t-1,b} + PZ_y^{COL,t-1,b} + AZ_y^{COL,t-1,b} &= 0 & \forall y > 1, t, b \\
X_y^{COL,t,b} - (1 - lr_y^{COL,t,b}) X_{y-1}^{COL,t-1,b} - BZ_y^{COL,t,b} - PZ_y^{COL,t,b} - AZ_y^{COL,t,b} \\
+ bg_y^{COL,t,b} &= 0 & \forall y > 1, t, b \\
\sum_{t,b} X_y^{g,t,b} &\geq Req_{g,y} - Dev_{g,y} & \forall g, y > 1, t
\end{aligned}$$

3. Primary Zone Promotion Constraints

$$\begin{aligned}
\underline{pzp}_{CPT} X_{y-1}^{:LT,TIG_{LT},b} &\stackrel{o}{\leq} PZ_y^{CPT,TIG_{LT},b} \leq \overline{pzp}_{CPT} X_{y-1}^{LT,TIG_{LT},b} & \forall y \geq 2, b \\
\underline{pzp}_{MAJ} X_{y-1}^{CPT,TIG_{CPT},b} &\stackrel{o}{\leq} PZ_y^{MAJ,TIG_{CPT},b} \leq \overline{pzp}_{MAJ} X_{y-1}^{CPT,TIG_{CPT},b} & \forall y \geq 2, b \\
\underline{pzp}_{LTC} X_{y-1}^{MAJ,TIG_{MAJ},b} &\stackrel{o}{\leq} PZ_y^{LTC,TIG_{MAJ},b} \leq \overline{pzp}_{LTC} X_{y-1}^{MAJ,TIG_{MAJ},b} & \forall y \geq 2, b \\
\underline{pzp}_{COL} X_{y-1}^{LTC,TIG_{LTC},b} &\stackrel{o}{\leq} PZ_y^{COL,TIG_{LTC},b} \leq \overline{pzp}_{COL} X_{y-1}^{LTC,TIG_{LTC},b} & \forall y \geq 2, b
\end{aligned} \tag{3.3}$$

4. Below the Zone Promotion Constraints

$$\begin{aligned}
\underline{bzp}_{MAJ} X_{y-1}^{CPT,TIG_{CPT}-1,b} &\stackrel{o}{\leq} BZ_y^{MAJ,TIG_{CPT}-1,b} \leq \overline{bzp}_{MAJ} X_{y-1}^{CPT,TIG_{CPT}-1,b} & \forall y \geq 2, b \\
\underline{bzp}_{LTC} X_{y-1}^{MAJ,TIG_{MAJ}-1,b} &\stackrel{o}{\leq} BZ_y^{LTC,TIG_{MAJ}-1,b} \leq \overline{bzp}_{LTC} X_{y-1}^{MAJ,TIG_{MAJ}-1,b} & \forall y \geq 2, b \\
\underline{bzp}_{COL} X_{y-1}^{LTC,TIG_{LTC}-1,b} &\stackrel{o}{\leq} BZ_y^{COL,TIG_{LTC}-1,b} \leq \overline{bzp}_{COL} X_{y-1}^{LTC,TIG_{LTC}-1,b} & \forall y \geq 2, b
\end{aligned} \tag{3.4}$$

5. Above the Zone Promotion Constraints

$$\begin{aligned}
\underline{azp}_{CPT} \sum_{t'=TIG_{LT}+1}^{TIG_{LT}+2} X_{y-1}^{LT,t',b} &\stackrel{o}{\leq} \sum_{t'=TIG_{LT}+1}^{TIG_{LT}+2} AZ_y^{CPT,t',b} \leq \overline{azp}_{CPT} \sum_{t'=TIG_{LT}+1}^{TIG_{LT}+2} X_{y-1}^{LT,t',b} & \forall y \geq 2, b \\
\underline{azp}_{MAJ} \sum_{t'=TIG_{CPT}+1}^{TIG_{CPT}+2} X_{y-1}^{CPT,t',b} &\stackrel{o}{\leq} \sum_{t'=TIG_{CPT}+1}^{TIG_{CPT}+2} AZ_y^{MAJ,t',b} \leq \overline{azp}_{MAJ} \sum_{t'=TIG_{CPT}+1}^{TIG_{CPT}+2} X_{y-1}^{CPT,t',b} & \forall y \geq 2, b \\
\underline{azp}_{LTC} \sum_{t'=TIG_{MAJ}+1}^{TIG_{MAJ}+2} X_{y-1}^{MAJ,t',b} &\stackrel{o}{\leq} \sum_{t'=TIG_{MAJ}+1}^{TIG_{MAJ}+2} AZ_y^{LTC,t',b} \leq \overline{azp}_{LTC} \sum_{t'=TIG_{MAJ}+1}^{TIG_{MAJ}+2} X_{y-1}^{MAJ,t',b} & \forall y \geq 2, b \\
\underline{azp}_{COL} \sum_{t'=TIG_{LTC}+1}^{TIG_{LTC}+2} X_{y-1}^{LTC,t',b} &\stackrel{o}{\leq} \sum_{t'=TIG_{LTC}+1}^{TIG_{LTC}+2} AZ_y^{COL,t',b} \leq \overline{azp}_{COL} \sum_{t'=TIG_{LTC}+1}^{TIG_{LTC}+2} X_{y-1}^{LTC,t',b} & \forall y \geq 2, b
\end{aligned} \tag{3.5}$$

6. Roll Down Constraints

$$\begin{aligned}
\sum_t X_y^{COL,t,b} &\stackrel{o}{\leq} tgt_y^{COL,b} & \forall b, y \geq 2 \\
\sum_t X_y^{LTC,t,b} + \sum_t X_y^{COL,t,b} &\stackrel{o}{\leq} tgt_y^{LTC,b} + tgt_y^{COL,b} & \forall b, y \geq 2 \\
\sum_t X_y^{MAJ,t,b} + \sum_t X_y^{LTC,t,b} &\stackrel{o}{\leq} tgt_y^{MAJ,b} + tgt_y^{LTC,b} & \forall b, y \geq 2
\end{aligned} \tag{3.6}$$

7. Accessions Constraints

$$\underline{acc}_y^b \leq A_y^b \leq \overline{acc}_y^b \quad \forall b, y \quad (3.7)$$

8. Nonnegative Constraints

$$X_y^{g,t,b}, PZ_y^{g,t,b}, BZ_y^{g,t,b}, AZ_y^{g,t,b}, A_y^b, DEV_{g,y} \geq 0 \quad \forall g, t, y, b \quad (3.8)$$

C. EXPLANATION OF THE MODEL

1. The Objective Function

The objective function (3.1) seeks the total minimum weighted deviation from the force structure requirements over the planning horizon. The discount factor ensures there is a higher priority on meeting the near-term requirements versus future ones. The model also places heavy penalties for not meeting the roll down constraints (3.6) and for accessing more officers than a particular Officer Basic School can support in constraint (3.7).

2. Constraints

The constraints in (3.2) maintain the inventory of the officer corps in a given year for a given grade. Constraints (3.3), (3.4), and (3.5) ensures the proper portion of officers are promoted in the PZ, BZ, and AZ based on the promotion rates dictated by DOPMA and the needs of the Army. The rolls down constraints (3.6) are set by law to maintain a proper portion of senior leadership proportional to the total strength of the Army. The accession constraints (3.7) brings the maximum number of LTs to meet future requirements based on loss rates at a given time in grade, and promotion opportunities at future grades.

IV. ANALYSIS AND RESULTS

We implement TACCOM using a 3.72 GHz windows based personal computer running the General Algebraic Modeling System [(GAMS 2003)] and CPLEX 10.0.1 solver. The sections below describe data provided by DAPE-PRS, and analysis of personnel issues posed by DAPE-PRS.

A. MODEL IMPLEMENTATION

1. Assumptions

The loss rate, for TACCOM purposes, is by grade and TIG. DAPE-PRS assumes the loss rate (fraction of officers who leave the service) remains the same for the next 40 years and so does TACCOM.

The time horizon is out to 2047. The cohort that is accessed in 2007 should enter the General Officer ranks and reach retirement eligibility within a forty year time horizon.

The size of the Army stabilizes in 2013 and remains at that level through 2047.

2. Data

The following data, from the DAPE-PRS database as of November 2006, comprise the actual Army inventory data and the future requirements prescribed by the Army G-3 through the Office of the Secretary of Defense [Lewis, 2006].

a. Targets and Inventories

Through a spreadsheet model, DAPE-PRS tracks the ACC inventory and projects future officer targets by grade for the next seven years. See the Appendix, Table 8 for the current ACC and the current Aviation (AV) inventory, Tables 9 and 10 for the future officer requirements for the ACC and AV branch through FY 2013.

The initial aggregate inventory by grade as of September 30, 2006 is what we use as the initial input data for the TACCOM. As data in the Appendix shows, there are no expected shortfalls in ACC or AV branch for the initial year (2006), except in the grade of MAJ. Table 3 shows the expected 2007 shortfall for MAJ.

GRADE	ACC		AV	
MAJ	10541	405	672	100

Table 3. The FY 2007 shortage at the grade of MAJ.

Table 3 shows the FY 2007 shortage at the grade of MAJ. The total inventory for MAJs in the ACC and AV branch in FY 2006 are not sufficient to meet the requirements in FY 2007. The ACC has a shortfall of 405 MAJs, while the AV branch has a shortage of 100 MAJs.

b. Parameters for Time in Grade

The TIG data for the ACC and AV branch that TACCOM uses is displayed in the Appendix, Tables 11 and 12.

c. Attrition Rates

We calculate the attrition rate using a one year time horizon (30 September 2005 through 30 September 2006). Prior to FY 2005, the Army habitually implemented a Stop-Loss policy that directly affects the historical loss rates from FY 2001-FY 2005. This controversial policy allows the service to determine which critical units or military occupational specialties could not to be released from active duty. As an example of its impact, the historical attrition rate of company grade officers is 7% over the past 20 years, but the attrition rate for company grade officers was less than 5% from FY 2001 through FY 2004. In FY 2005, the attrition rate increased to almost 9% when the Stop-Loss policy for deployed units was lifted (officers who were planning to leave 12 months earlier left the service at the exact same time as other officers' service commitment expired) [Lewis, 2006]. The attrition rates of officers within the ACC and the AV branch from FY 2005 to FY 2006 are displayed in the Appendix, Tables 13 and 14.

d. Bounds for Promotion Rates

The lower bounds on the promotion rates are from DOPMA. During FY 2006 the Army promoted over 98% of officers available for promotion to CPT, 95% of officers available for promotion to MAJ, and over 92% of officers available for promotion to LTC [Hoffman, 2006]. This trend should continue for the next few years, illustrating the flexibility in the range for promotion rates. Table 4 displays these promotion rates, and the upper bounds for the AZ are based on current Army practices [Haight, 2006].

	PZ Rate		BZ Rate		AZ Rate	
	Lower	Upper	Lower	Upper	Lower	Upper
CPT	95%	100%	0%	10%	0%	25%
MAJ	80%	95%	0%	10%	0%	25%
LTC	60%	95%	0%	10%	0%	25%
COL	50%	60%	0%	10%	0%	25%

Table 4. The promotion opportunity rate provided by the Army and used by TACCOM.

Table 4 shows the promotion opportunity rate provided by the Army and used by TACCOM. For example the lower bound for promotion to MAJ in the PZ is 80%, but the Army can elect to promote up to 95% of officers available for promotion to MAJ. The Army can also elect to promote as many as 10% of an eligible officer population for promotion BZ to MAJ, and as many as 25% of officers to MAJ who in the AZ category

3. Determining Weights

To access its annual personnel cost for budget requirements, the Army G-1 utilizes an annual cost for officers based on their pay grade. The cost or annual investment for each officer includes base pay, medical benefits, and cost of living allowances. This value is what TACCOM utilizes for the weights in the objective function. Based on the highest grade combination in a constraint, TACCOM uses the highest pay grade value as the penalty when a promotion constraint is not met. These values are shown in Table 5.

Grade	LT	CPT	MAJ	LTC	COL
Value	\$86,516	\$110,400	\$138,107	\$160,189	\$189,181

Table 5. The annual investment the Army estimates per grade.

Table 5 shows the annual investment the Army estimates per grade. For example the Army makes an annual investment of \$110,400 for each CPT (After, Lewis, 2006).

B. SCENARIOS

We look at two different scenarios. The first scenario focuses on the ACC, while the second scenario looks closely at the AV branch. For all scenarios, we limit our focus to accessions of officers, and focus on the point at which the inventory at the grade of MAJ reaches a steady-state, continuously meeting future requirements. The grade of MAJ is critical due to the increased requirements at this grade in the future force structure. We also look at what affect meeting the MAJ inventory requirements has on the CPT inventory. The TACCOM is a dynamic model, changes in one grade affects other grades directly. Such dynamics are currently not captured in the current spreadsheet model past an 84 month time horizon.

The first scenario looks at the ACC inventory and requirements under the current promotion policy. Based on what the Army plans to do, we propose what LT accessions and promotions at all grades are required to meet future requirements. Also within this scenario, we look at the effect of a possible policy to accelerate promotion to MAJ by one year. The resulting linear program has about 4,200 equations and 4,800 variables, and it takes only about 4.0 seconds to produce an optimal solution.

The second scenario focuses on the AV Officer inventory in order to illustrate the utility of the TACCOM to aid in branch specific analysis. Based on what the Army plans to do, we propose what AV LT accessions and promotions at all grades are required to meet future requirements. Also within this scenario, we look at whether there is any benefit to a possible policy to accelerate promotion to MAJ by one year. The resulting linear program has the same number of equations and variables as in the first scenario, and also takes only about 4.0 seconds to produce an optimal solution.

In the second scenario, we adjust the promotion rates. The concern is that the current operational environment does not lend itself to allow the Army to truly be selective in whom it promotes. This scenario tightens the parameters of PZ promotion opportunities to the DOPMA minimum, and looks at its affect on what AV LT accessions are required to meet future requirements at the grade of MAJ in the AV branch.

1. Army Competitive Category Scenario

The first scenario assumes current operational conditions with the current promotion rates and attrition rates. Figure 3 illustrates the current LT accessions and the TACCOM accession plan based on the current promotion rates and attrition rates for the ACC.

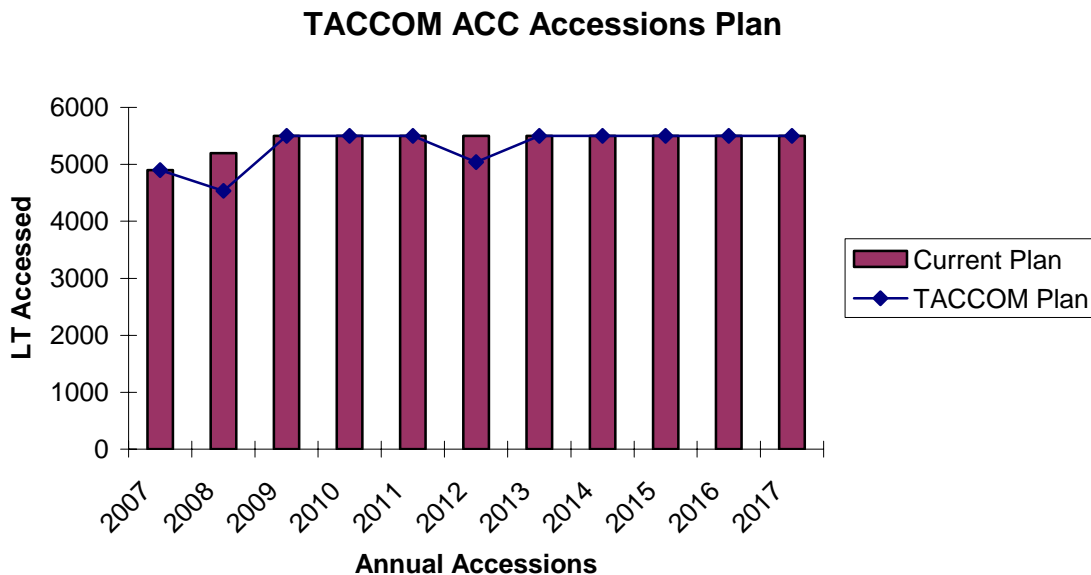

Figure 3. TACCOM ACC Accession Plan.

Figure 3 shows the TACCOM accession plan. The Army currently plans to access 4,900 officers in FY 2007, 5,200 in FY 2008, and 5,500 in FY 2011 and beyond as illustrated by the red bar chart. The TACCOM recommendation is very similar, allowing a slight reduction in FY 2008 and in FY 2012, but under the Army’s accession plan the Army faces significant shortages at the grade of MAJ from FY 2013 through FY 2020.

Currently the total training capacity for the officer corps is 4,617 officers in FY 2007, 4,523 in FY 2008, and possibly up to 6,000 officers by FY 2011 [Haight, 2006]. We ran TACCOM with and without limiting the number officers accessed by these training limits. The results shown in Figure 3 are without a training capacity constraint to maintain consistency with the current Army accession plan. The accession plan that the TACCOM proposes for the ACC places an immediate strain on the agency required to access officers. However, struggling to recruit and train an enormous number of officers now, facilitates the future officer corps not to have large gaps in coverage over its requirements.

The DAPE-PRS use a spreadsheet model to forecast the Army officer inventory. Table 6 illustrates what the DAPE-PRS projects for shortfalls at the grade of MAJ.

ACC	FY07 Endstrength			FY08 Endstrength		
Grade	Strength	Op Str Dev	% Fill	Strength	Op Str Dev	% Fill
COL	2751	217	108.2%	2747	214	108.1%
LTC	7319	359	105.5%	7547	539	108.1%
MAJ	11095	(1453)	86.4%	11064	(1692)	84.5%
CPT	17682	(1275)	92.0%	17576	(1585)	90.1%
LT	14020	425	104.6%	14205	313	103.3%
Total	52867	(1727)	94.0%	53139	(2210)	93.0%

Table 6. The DAPE-PRS officer inventory projected shortages as of November 2006.

Table 6 shows the DAPE-PRS officer inventory projected shortages as of November 2006. The chart shows the forecasted officer end strength at each grade for FY 2007 and FY 2008, and the operational strength deviation at each grade. The numbers in parentheses represent shortages at that grade. The % fill rate column represents the number of officers at that grade divided by the number of officers required at that grade (after Lukens, 2006)

The TACCOM produces a better solution than the current plan (Figure 4). The results from TACCOM suggests an increase in the grade of MAJ to a 87.14% fill rate in FY 2007 which is 0.74% better than the current plan, 85.24% fill rate in FY 2008 which is 0.74% better than the current plan, 90.22% fill rate in FY 2009 (better than the current plan but exact data is not available for comparison), and 100% fill rate by FY 2010

(again, better than the current plan but exact data is not available for comparison). Additionally, the Army's current plan cannot meet officer requirements and grow the force within the next five years.

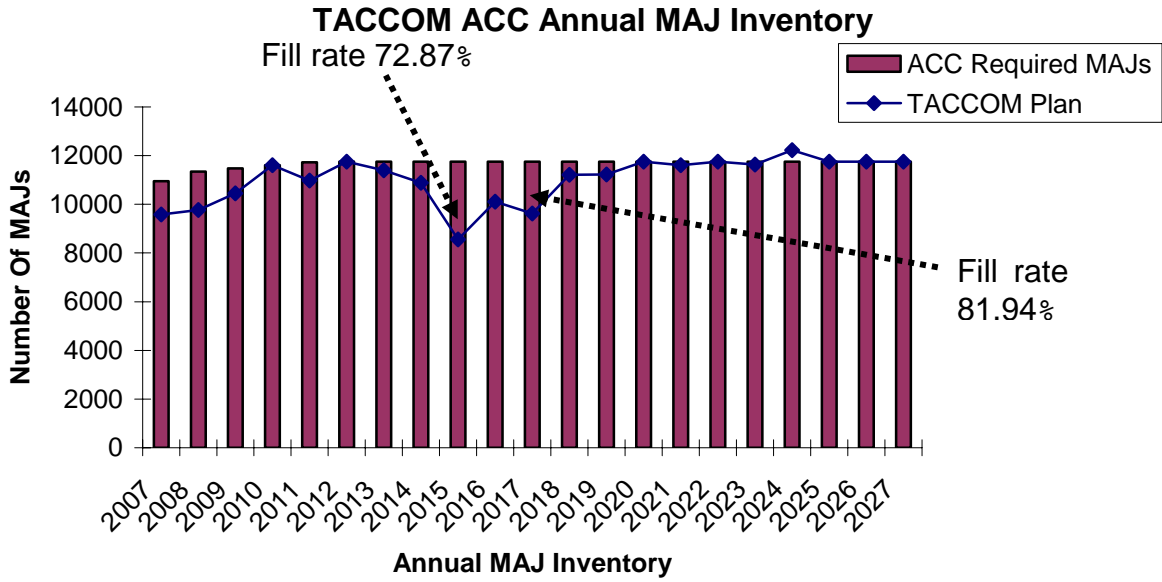

Figure 4. TACCOM Annual MAJ inventory prescription.

Figure 4 shows TACCOM annual MAJ inventory prescription. TACCOM plan shows the Army can satisfy requirements at the grade of MAJ by FY 2021 based on current Army accession plans, promotion policy, and attrition rates, as illustrated by the blue line. The blue line shows the inventory of MAJs based on the TACCOM accession plan (Figure 3) and current promotion rates. The red bar chart represents what the Office of the Secretary of Defense requires the Army to maintain at the grade of MAJ.

Figure 4 shows that the Army does not fill its requirements at MAJ for seven consecutive years, from FY 2013 to FY 2020. This phenomenon is associated with manpower decisions made prior to FY 2004. The TACCOM prescription starting in FY 2007 provides an accession plan that produces an inventory of MAJs that satisfies all requirements by FY 2021.

Figure 5 shows CPT requirements are met or exceeded throughout the whole time horizon after FY 2011. The TACCOM recommended CPT inventory exceeds requirements after FY 2011 thus increasing the pool of eligible MAJs. This is important because it is critical filling the MAJ grade does not create a CPT shortage in the future.

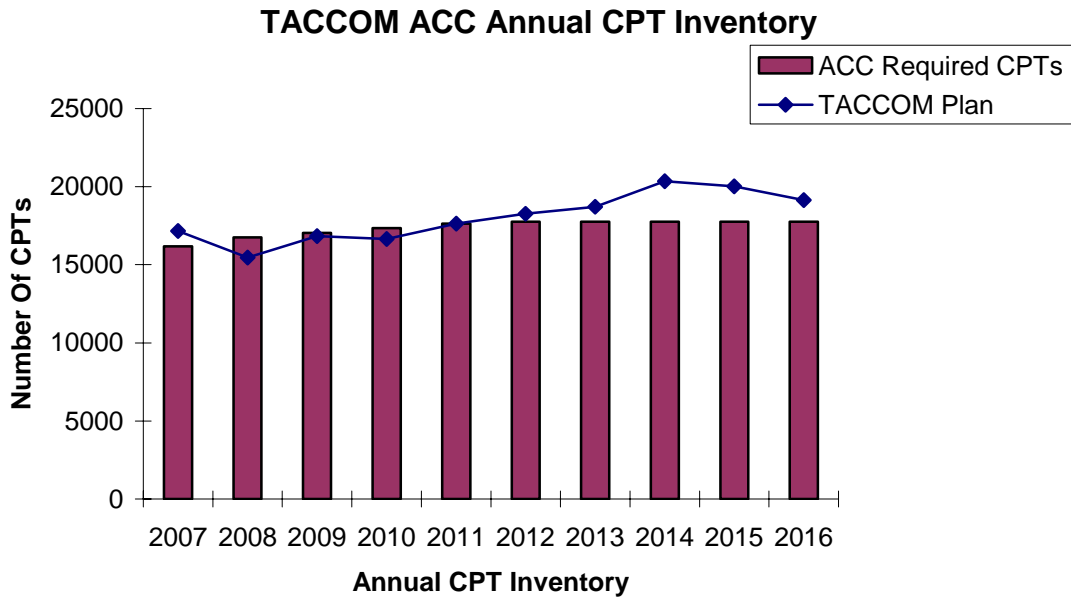

Figure 5. TACCOM Annual ACC CPT Inventory based on current Army accession plan.

Figure 5 shows TACCOM annual ACC CPT inventory based on current Army accession plan. At the current promotion policy and attrition rate, the Army maintains at least the required number of CPTs from FY 2011 and beyond.

The DAPE-PRS is continuously looking at what effects different policies have on the officer inventory. Due to the shortage of officers at the MAJ grade, the Army G-1 has asked for analysis on the affect of accelerating the promotion to MAJ to six years TIG for CPTs, which translate to officers pinning on the rank of MAJ at nine years. Figure 6 illustrates the results from the TACCOM. It shows that if officers are promoted at the current promotion rate, but at the same time accelerate the time of the promotion to MAJ by one year, the Army could meet its requirements at the grade of MAJ in FY 2007.

However, shortfalls still exist in FY 2014 through FY 2016. The Army is only facing a shortage of MAJs for four consecutive years, from FY 2013 through FY 2017, versus the seven year shortage illustrated in Figure 4.

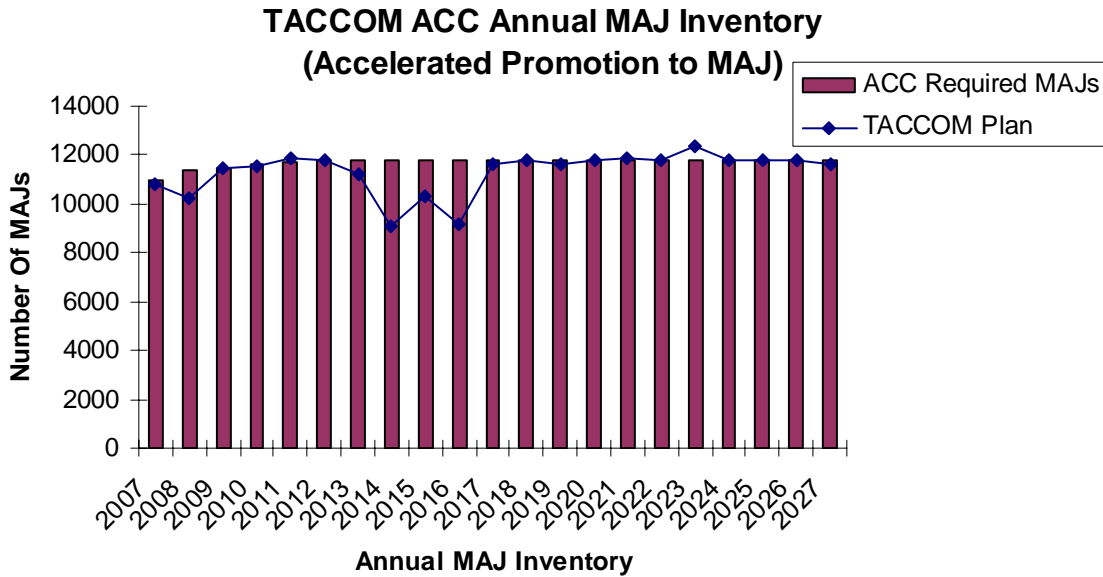

Figure 6. TACCOM Annual MAJ Inventory based on accelerated promotion to MAJ.

Figure 6 shows TACCOM annual MAJ inventory based on accelerated promotion to MAJ. The Army can satisfy requirements at the grade of MAJ by FY 2018, as illustrated by the blue line. The blue line shows the inventory of MAJs based on the TACCOM accession plan in Figure 3 and current promotion rates and an accelerated promotion to the grade of MAJ. The red bar chart represents what the Office of the Secretary of Defense requires the Army to maintain at the grade of MAJ. By accelerating the promotion to MAJ, the Army is only facing a shortage of MAJs for four consecutive years, from FY 2013 through FY 2017, versus the seven year shortage illustrated in Figure 4.

Looking at just the ACC, we see that with minor policy adjustments the Army can immediately fix its shortfall at the grade of MAJ. Accelerating promotions to MAJ does not seem to have any negative effect on the grade of CPT. However,

looking at just the ACC may not illustrate the real issues within the Army Officer Corps. We now focus our efforts on the AV branch to see what affects manpower policy has on the Army's AV branch officer inventory.

2. Aviation Branch Scenario

The second scenario focuses on the manpower concerns within the AV branch. As the Army transforms itself, so do the individual branches. The AV branch requires more training time for new LTs than any other branch. The officers commissioned in the AV branch incur an active duty service obligation of six years, which does not begin until the officer completes flight training. Flight training can last from 12 to 24 months, depending on multiple factors such as the type of airframe the officer is designated to fly and to the time of year the officer begins the actual flying portion of his training. The flight training with the addition of the active duty service obligation normally causes the AV branch to have a large exodus when the officer reaches the grade of CPT with five years TIG. This is illustrated in Table 14 in the Appendix, which shows that the AV branch losses 50% of the officers in the grade of CPT with five years TIG. This attrition rate is a driving factor on how many officers the AV branch should access in order to meet its future requirements. The transformation of the AV branch, like the other MFE branches require more MAJs than it did under its previous structure.

a. TACCOM Limited to Current Accession Plan

Figure 7 illustrates the current AV accessions plan, and the TACCOM recommendations. They match exactly when TACCOM is restricted to access no more than the AV accession plan.

Current AV Accessions Plan

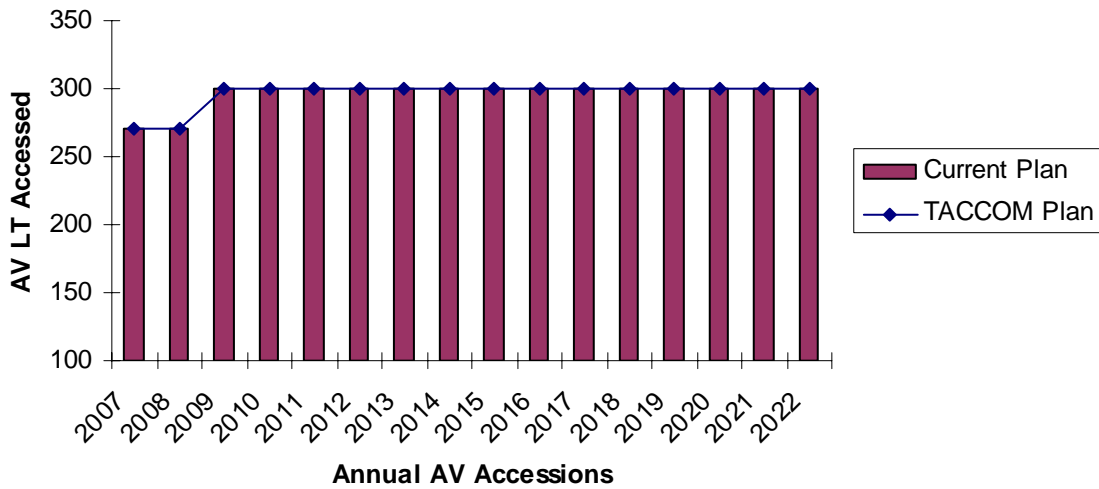

Figure 7. The Current AV Branch Officers' Accession Plan.

Figure 7 shows the current AV branch officers' accession plan. The magenta bars represent the current plan. The blue line provides a TACCOM officer accessions plan.

Figure 8 shows that the AV branch achieves its requirements for MAJ from FY 2009 to FY 2012, but fails to meet its requirements after FY 2013. For this scenario, we assume the current attrition rate for the AV branch shown in the Appendix, Table 14.

Future Annual AV MAJ Inventory

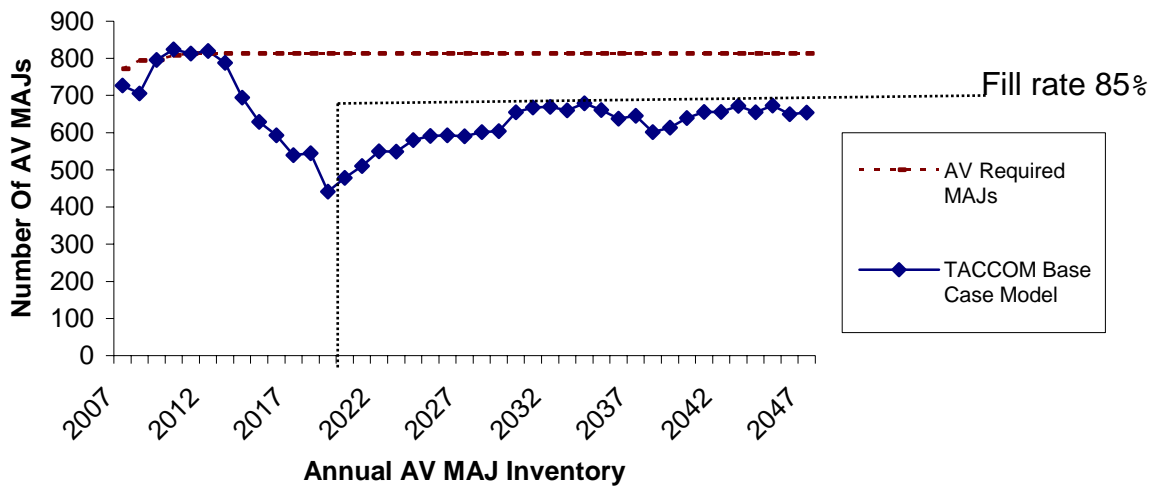

Figure 8. The Future Annual AV MAJ Officer Inventory Given Current Army Policy.

Figure 8 shows the future annual AV MAJ officer inventory given current Army policy. The dark red dotted line represents the requirements for the grade of MAJ. The blue line with diamonds represents the AV MAJ Officer inventory based on the TACCOM accession plan from Figure 7. This Figure shows that the future AV branch inventory is not sufficient to meet the requirements.

Not only does the AV branch current accession plan degrade the possibility for the branch to meet its MAJ requirements, but in Figure 9 we notice the grade of CPT does not meet its future requirements at anytime in the future.

Future Annual AV CPT Inventory

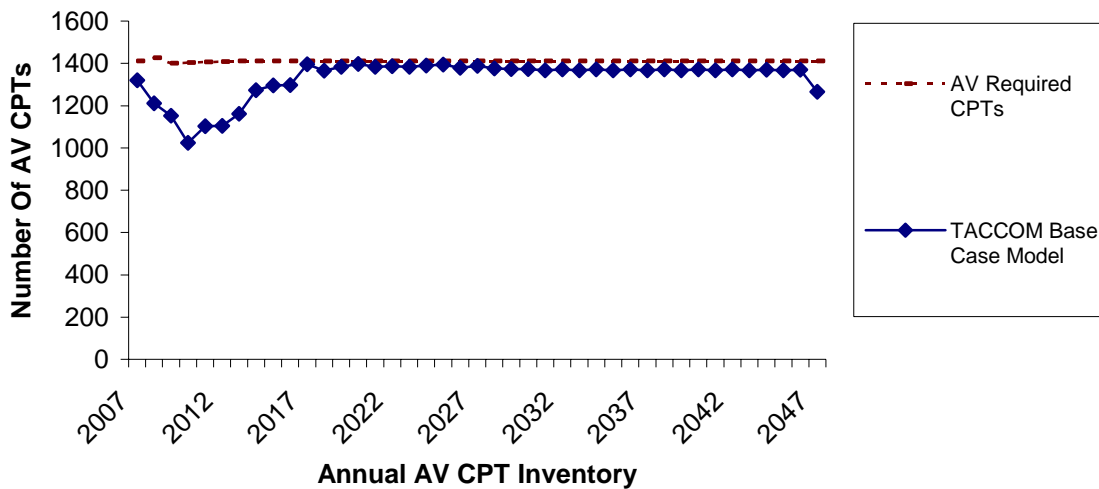

Figure 9. The Future Annual AV CPT Officer Inventory Given Current Army Policy.

Figure 9 shows the future annual AV CPT officer inventory given current Army policy. The dark red dotted line represents the requirements for the grade of CPT. The blue line represents diamonds the TACCOM prescription AV CPT Officer inventory. There is a steady decline in the AV branch CPT inventory for three consecutive years before any noticeable increase; however, at no time in the future does the AV branch have enough CPTs to fulfill its requirements based on the current accession plan from Figure 7.

Under the AV branch’s current accession plan, the MAJ fill rate is at 100% for four consecutive years starting in FY 2009 (Figure 8). However, the fill rate at CPT continues to decrease. The critical future issue, the fill rate at MAJ decreases below 85% starting in FY 2014 and continues to remain well below the Army’s benchmark through FY 2047.

b. TACCOM with Unconstrained Accessions

We provide two possible alternatives to combat the AV branch’s future mid-grade officer issues, and use the TACCOM to gain insights on a variety of possible outcomes. The first removes the cap on LT accessions, and the second reduces by half the attrition of CPTs with five years TIG.

TACCOM AV Accessions Plan

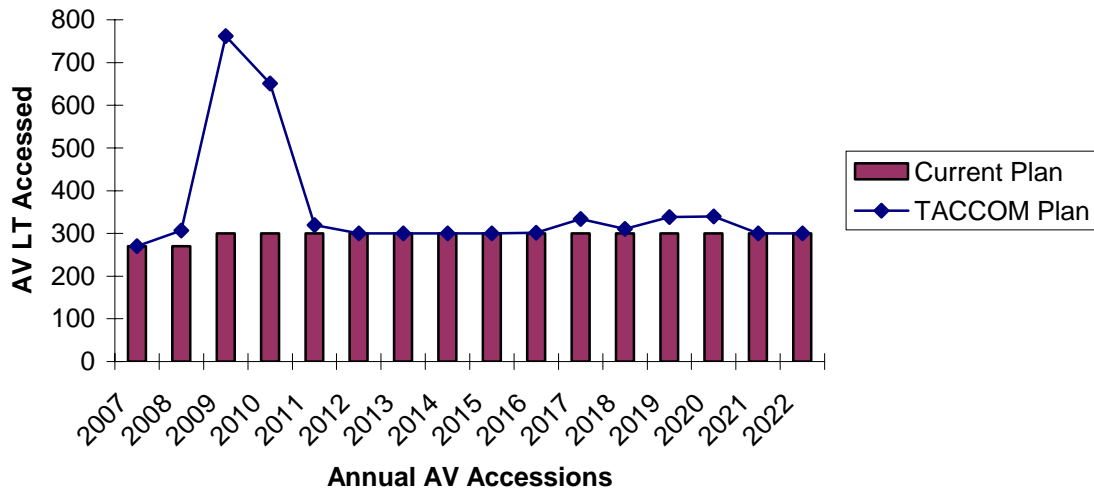

Figure 10. TACCOM AV Accession Plan when no Limit on the Number of Accessions.

Figure 10 shows TACCOM AV accession plan when no limit on the number of accessions. The AV branch currently plan to access 270 officers in FY 2007, 270 in FY 2008, and 300 in FY 2009 and beyond as illustrated by the red bar chart. The TACCOM proposes that the training center at Fort Rucker, Alabama would need to increase its training capacity 150% in FY 2009 and more than 110% in FY 2010. Unfortunately, even if Fort Rucker could increase its training capacity, it still would not completely fix the future shortages at the grade of MAJ (Figure 11). In addition, our infrastructure and personnel increases required for this temporary increase will not be needed in FY 2011. The decrease starting in FY 2013 through FY 2018 is attributed to the manpower decisions made prior to FY 2006.

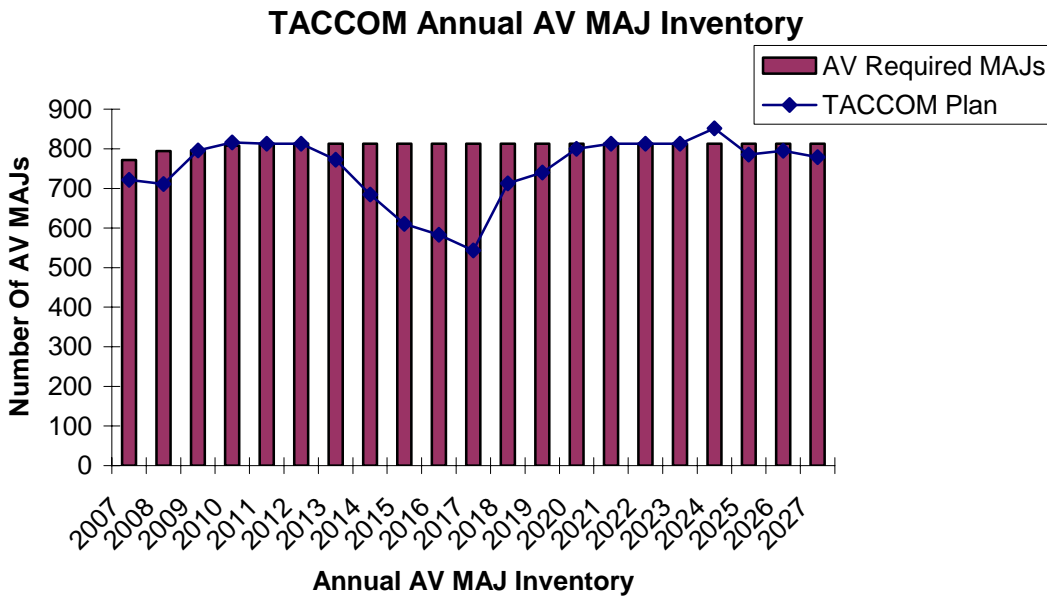

Figure 11. TACCOM Annual AV MAJ inventory when no Limit on the Number of Accessions.

Figure 11 shows TACCOM annual AV MAJ inventory with no Limit on the Number of Accessions. At the current promotion policy and attrition rate the AV branch reaches a steady state at the grade of MAJ by FY 2021, as illustrated by the blue line which represents the inventory of MAJs based on the current accession plan and promotion rates. The red bar chart represents what the Office of the Secretary of Defense requires the Army to maintain at the grade of MAJ. Although the AV branch plan allows the branch to meet its officer requirements by FY 2009, the branch goes eight consecutive years, from FY 2013 to FY 2020, without enough MAJs to meet its requirements. This shortage is a direct result of accessing too few officers in past years, and not working diligently to retain enough officers to meet future requirements.

Figure 12 illustrates the AV branch’s CPT inventory is at the critical fill point for three consecutive years before FY 2011 where the AV branch continuously has a surplus of CPT. The large increase in the grade of CPT inventory from FY 2012 to FY 2018 is needed to satisfy future requirements at MAJ.

TACCOM Annual AV CPT Inventory

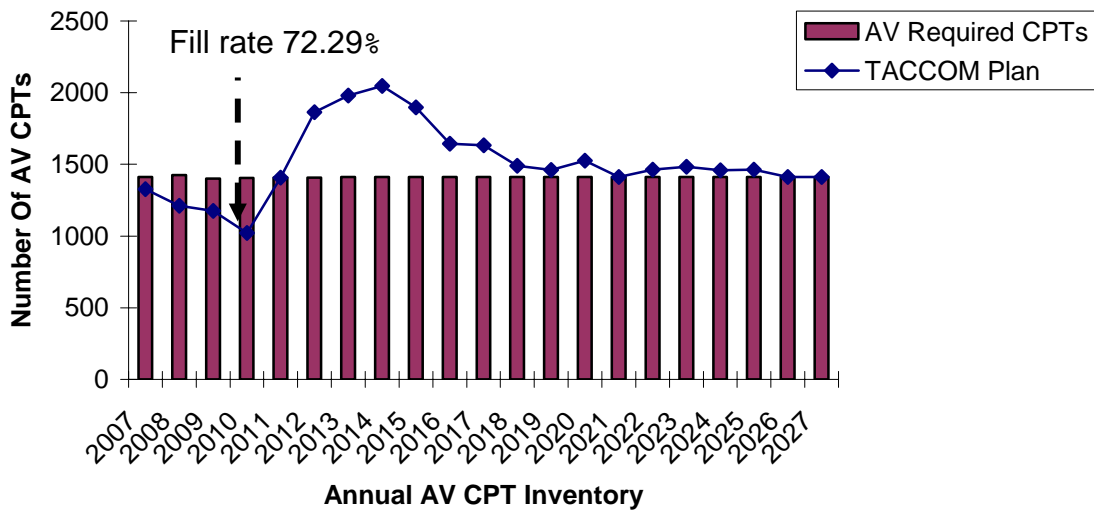

Figure 12. TACCOM Annual AV CPT Inventory.

Figure 12 shows TACCOM annual AV CPT inventory. At the current rate, the AV branch maintains at least the required amount of CPTs from FY 2011 and beyond. The additional CPTs from FY 2012 to FY 2018 are needed to satisfy future requirements at MAJ.

c. TACCOM with Unconstrained Accessions and Adjusted CPT Attrition Rate

To maintain enough AV officers to meet future requirements, the branch must focus its efforts on retention. If the AV branch can retain 75% of the officers when they reach the critical TIG of five years, the difference in training requirements (accessions) are displayed in Figure 13. These accessions are significantly less than those when retention is only 50% (Figure 10). At no time does the MAJ inventory reach a critical fill rate status (Figure 14). The lowest point is in FY 2008 when it reaches as low as 86.46 % (above the 85% bench mark). The fill rate for CPT is also significantly better (Figure 15).

**TACCOM AV Accessions Plan
(Reduce Attrition at CPT with Five Years TIG)**

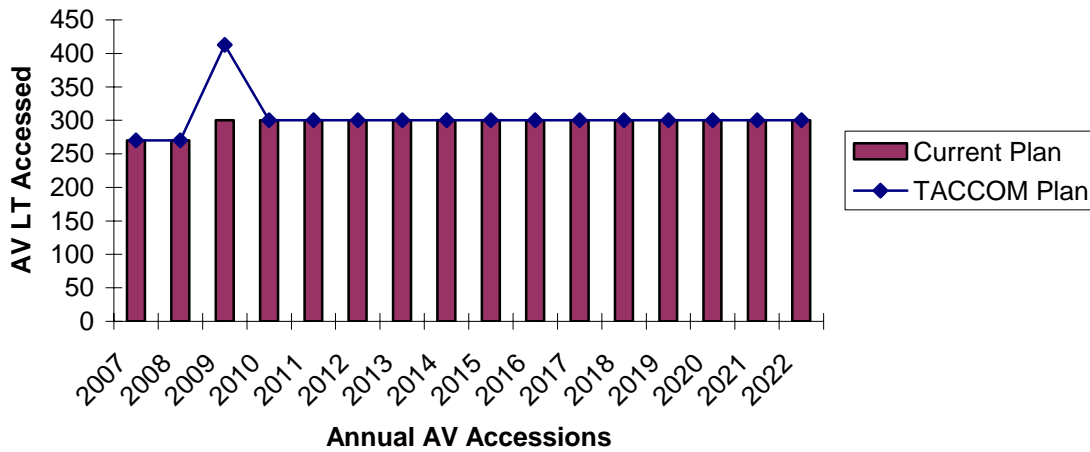

Figure 13. TACCOM AV Accession Plan with no Limit on Number of Accessions and a 25% Attrition at CPT with Five Years TIG.

Figure 13 shows TACCOM AV accession plan with no limit on number of accessions and a 25% attrition at CPT with five years TIG. The TACCOM proposes that the AV branch must surge its training capacity by 112 officers or adjust its training seat allocations in FY 2009 in order to have enough aviators to fill future requirements. This is significantly less than needed when attrition is at 50% (Figure 10).

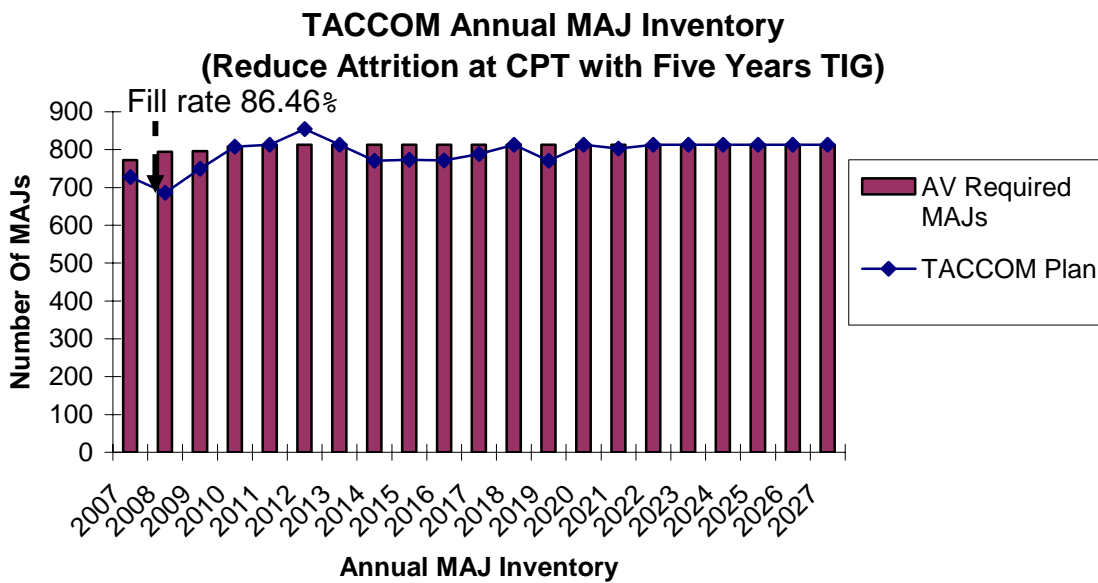

Figure 14. TACCOM Annual AV MAJ Inventory based on Reduction in Attrition at the Grade of CPT.

Figure 14 shows TACCOM annual AV MAJ inventory based on reduction in attrition at the grade of CPT. At no point in the future does the inventory drop below the Army benchmark of 85% fill rate. This is a much more palatable result than what is seen in Figure 12.

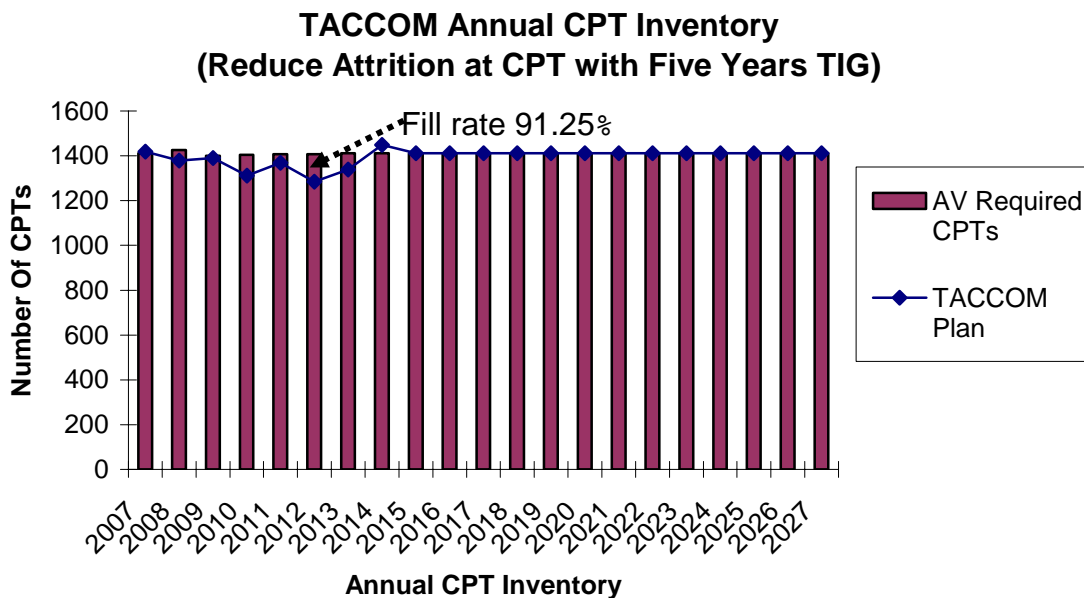

Figure 15. TACCOM Annual AV CPT Inventory based on Reduction in Attrition at the grade of CPT.

Figure 15 shows TACCOM annual AV CPT inventory based on reduction in attrition at the grade of CPT. When the grade of CPT’s TIG attrition rate at five years is decreased to 25% the AV branch maintains at least the required amount of CPTs from FY 2011 and beyond. During the five years it does not meet its requirements, the lowest fill rate is 91.25%. This is a better result than a lowest fill rate of 72.29% (Figure 12).

d. Policy Option Comparison

The TACCOM lends insights to the implementation of various policy options. With TACCOM we are able to adjust the upper and lower bounds on accessions and promotions. We also can adjust attrition rates and select when officers are promoted in order to see the possible future outcomes based on senior leaders’ decisions today. A few of the policies that are currently being considered are; (a) possibly moving the promotion to MAJ to one year earlier making the average total time in service of a new MAJ nine years (b) reverting back to the promotion rates in the 1980s that stayed at the lower end of the DOPMA allowable promotion opportunity rate. To illustrate the utility of the TACCOM, we look at a comparison of these policies (Figure 16 and Table 7).

TACCOM Policy Option Comparison

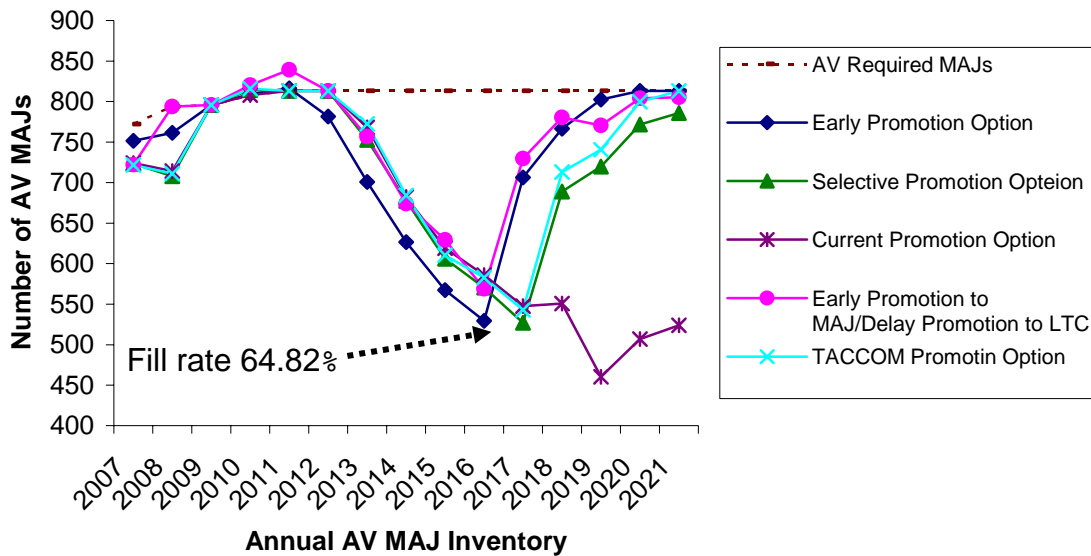

Figure 16. TACCOM AV Branch Policy Option Comparison.

Figure 16 shows TACCOM AV branch policy option comparisons, using the current attrition (Appendix, Table 14). The dark red line with the squares represents the current requirements for the grade of MAJ in the AV branch through FY 2021. The navy blue line with the diamonds represents the proposed solution when the promotion to the grade of MAJ is accelerated by one year. The green line with the triangles represents the population at the grade of MAJ if the Army reverts to a more selective promotion system. The light blue line with the crossed lines represents the inventory at the grade of MAJ based on the initial TACCOM proposal. The magenta line with the star on it represents the current forecast for the grade of MAJ based on the current officer accession plan. The pink diamond represents the MAJ population when the Army promotes to MAJ one year earlier and delay promotions to LTC to one year later. This figure illustrates that although some policies may remedy the AV branch’s MAJ shortage as early as FY 2008, the officer accession decisions made in the past have a direct effect well into the future. All of the policy options converge to their lowest point in FY 2017. (Note: all policy option outcomes shown are based on results from the TACCOM)

We notice that the AV branch MAJ inventory does not meet its requirements initially, even if the Army G-1 passes a policy that promotes officers to the grade of MAJ early. However, this option keeps the grade of MAJ below the critical fill rate for three years, versus the four years on the current path, and five years if the Army reverts to a more selective promotion rate (see Table 7).

MAJ Fill Rate Percentages					
FY	Current Promotion Option	TACCOM Promotion Option	Early Promotion Option	Selective Promotion Option	Early to MAJ / Delay to LTC Promotion Option
2007	93.79%	93.50%	97.37%	93.69%	93.52%
2008	89.94%	89.57%	95.92%	89.13%	100.00%
2009	100.00%	100.00%	100.00%	100.00%	100.00%
2010	100.00%	100.99%	100.14%	100.79%	101.52%
2011	100.00%	100.00%	100.40%	100.00%	103.21%
2012	100.00%	100.00%	96.16%	100.00%	100.00%
2013	94.47%	95.02%	86.21%	92.57%	93.10%
2014	83.89%	84.16%	77.07%	83.32%	82.88%
2015	76.16%	75.09%	69.77%	74.55%	77.42%
2016	72.08%	71.69%	65.14%	70.15%	69.98%
2017	67.36%	66.79%	86.86%	64.82%	89.75%
2018	67.75%	87.71%	94.29%	84.74%	96.01%
2019	56.63%	91.08%	98.70%	88.50%	94.78%
2020	62.37%	98.36%	100.00%	94.94%	98.92%
2021	64.44%	100.00%	100.00%	96.69%	99.03%

Table 7. MAJ Fill Rate Percentages.

Table 7 shows the MAJ fill rate percentage. The six columns represent the MAJ fill rate percentages for the AV Branch based on present promotion rate policies (Table 4) and the current attrition rates (Table 14 in the Appendix). The First column is FY 2007 to FY 2021, the second column is the current course, the third column is the TACCOM proposed fill rate, the fourth is if the policy changes to promote to MAJ one year earlier, the fifth column represents the AV MAJ fill rate if the Army reverts to a more select promotion policy, and the last column represents the AV MAJ fill rate if the Army promotes to the grade of MAJ one year earlier but delays the promotion to LTC by one year. (Note: all policy option outcomes shown are based on results from the TACCOM)

Table 7 also illustrates the impact if the Army incorporates delaying promotions to LTC with the policy to accelerate promotions to MAJ. The result is the AV branch has more than enough MAJs to fill its requirements starting in FY 2008

through FY 2013, and even when the fill rate is below the Army's benchmark of 85% fill rate to MAJ, it is still 5.81% better than just accelerating promotions MAJ in FY 2014, 7.65% better in FY 2015, and 4.84 % better in FY 2016. This comparison shows there is benefit to revisiting this policy as a recommendation to mitigate future AV MAJ officer shortages. Figures 17 and 18 also show the overall impact of this policy on the AV branch over a 40 year time horizon; we notice that although the problem at the grade of MAJ is immediately fixed for a few years, the officer inventory problem is actually shifted to the grade of CPT.

Figure 17 and Figure 18 compare two policy options that are currently being considered by the Army G-1. One option is to both accelerate the promotion to MAJ by one year, and delay the promotion to LTC by one year, making the grade of MAJ longer. Option two proposes that the AV branch increase its training capacity to 500 officers by FY 2011. Figure 17 illustrates how the different policy decisions affect on the MAJ inventory. We notice that the both alternatives do better than the current plan. The best option for the AV branch is to increase its accession if wants to meet its MAJ requirements past FY 2013. Figure 18 illustrates the increasing the accessions of officers into the AV branch is the best course of action to adequately meet it CPT requirements in the future.

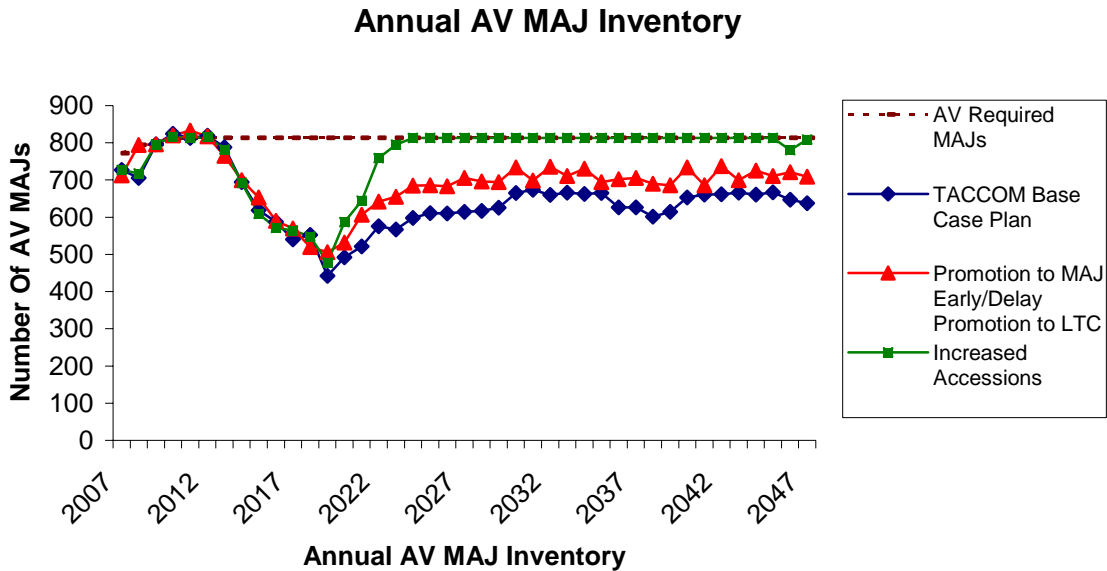

Figure 17. Promotion Policy Impacts on the AV MAJ Officer Inventory.

Figure 17 shows the promotion policy impacts on the AV MAJ officer inventory. The dark red line dotted line with a square represents the AV branch requirements. The blue line with a diamond represents the future inventory based on current promotion policy and attrition rates. The red line with triangles represents the policy option of accelerating promotion to MAJ while at the same time delaying promotion to LTC. The green line with a bold square represents the gradual increase of officer accessions into the AV branch to a steady-state of 500 officers by FY 2011. This Figure illustrates that the one way for the AV branch to meet future requirements is to increase the number of officers it can train from the current plan of 300 officers to at least 500 officers, if it is to overcome the high attrition rate at the grade of CPT, and meet its future requirements.

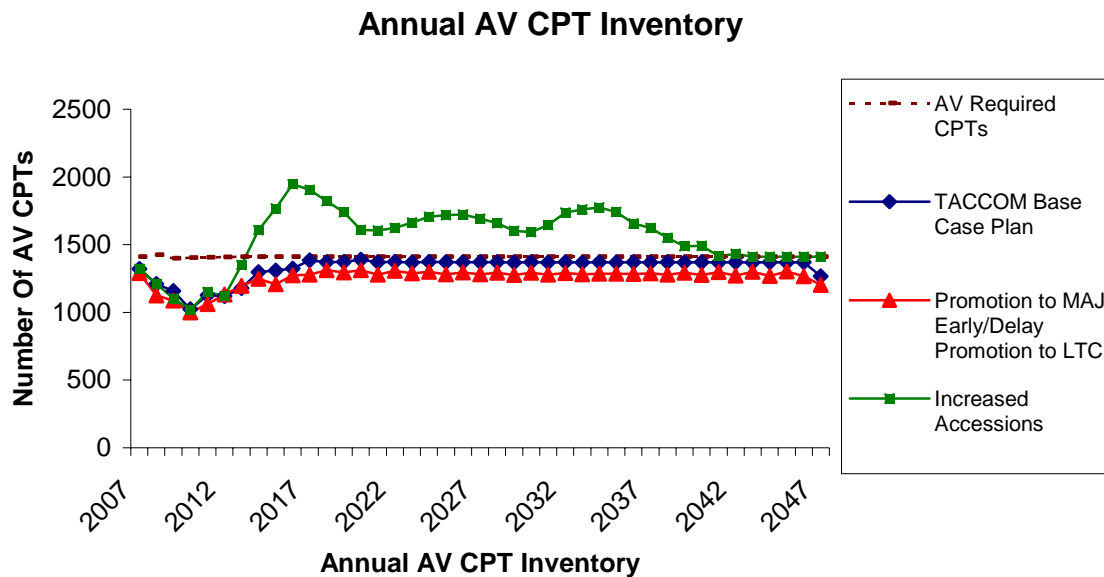

Figure 18. Promotion Policy Impacts on the AV CPT Officer Inventory.

Figure 18 shows the promotion policy impacts on the AV CPT officer inventory. The dark red dotted line with a square represents the AV branch requirements. The blue line with a diamond represents the future inventory based on current promotion policy and attrition rates. The red line with triangles represents the policy option of accelerating promotion to MAJ while at the same time delaying promotion to LTC. The green line with a bold square represents the gradual increase of officer accessions into the AV branch to a steady-state of 500 officers by FY 2011. This figure illustrates that for the AV branch to exceed its requirements at the grade of CPT, it would need to increase its accession to 500 officers per year. Promoting officers early to MAJ and delaying promotions to LTC in order to fill MAJ shortages actually degrades the future CPT inventory.

C. SUMMARY

The analysis in this chapter shows a direct relationship between the accession of officers and the Army’s ability to meet future requirements at higher grades. The TACCOM allows for the insights of what happens if the AV branch does a better job at officer retention. We then see the relationship between the attrition rate at future grades’ impact on future accessions.

There are multiple avenues to take in correcting the Army’s manpower issues. When we look at the aggregate it seems that the manpower problem corrects itself over time. However, as the case with the AV branch shows, Army aggregate solutions can

cover up significant problems at the branch level of detail. When we look specifically at the AV branch it is clear the Army has only a couple of policy options available to correct future manpower shortages. One way to correct the AV branch future manpower problem is the addition of resources to expand its training capability. With increased accession by one-third in FY 2010 to 400, and to access 500 AV officer each year starting in FY 2011 and beyond. Also the AV branch can work more diligently to lower its attrition rate at the critical TIG of five years for CPTs. If these measures are taken soon, then future shortages at the mid-grade level are minimized.

As our analysis shows, retaining officers (at least for the AV branch) is the best course of action for addressing future Army manning requirements. At the current operational pace and constant transformation of the Army, it is imperative the appropriate actions are taken to minimize the future mid-grade officer gap.

THIS PAGE INTENTIONALLY LEFT BLANK

V. CONCLUSIONS AND FUTURE RESEARCH

The research of military manpower alternatives is critical to maintaining a future fighting force. The majority of military manpower decision making models or tools focus on looking at the total annual population of the inventory. The TACCOM takes a different turn, and looks at the officers TIG coupled with the AZ, PZ, and BZ promotion rates to gain insights on possible future issues.

We tested the TACCOM using two scenarios, and summarized our results with tables and figures illustrating the proposed TACCOM outcomes. The first scenario involved looking at the ACC, focusing on the accession plan to meet the future requirements at the grade of MAJ. Our second scenario illustrated that the TACCOM is not just a model that looks at the aggregate; it is also capable of focused analysis for the AV branch.

In the ACC scenario, we notice that the current Army accession and the TACCOM plan are almost identical over the next five years. However, when we look at the specific grade of MAJ we notice that the Army does not meet its requirements at the grade for at least ten years in the future. In the AV branch scenario, we find the current AV branch accession plan should be reviewed. It will take an enormous training effort in FY 2009 and FY 2010 to meet the future requirements at the grade of MAJ. Because it may be difficult to ramp up the training effort to the capacity required to meet the AV branch manning requirements, we propose that the AV branch focuses its efforts on reducing its attrition at the grade of CPT with five years TIG by 50%. These efforts greatly impact the accession numbers and the ability to meet future requirements at the grade of MAJ. The ability to compare policies is also insightful and with the TACCOM we notice that it may be possible to become more selective in the Army's promotion system, at least in the AV branch.

There are two areas for future work that might improve the TACCOM as a manpower modeling tool. TACCOM uses a finite time horizon to determine its optimal solution. The future requirements of any military force are unknown. A look at infinite time horizon techniques would aid in this unknown area. The second area is to

implement the model with multiple branches to conduct analysis on the interactions between the various branches and their individual requirements. Research that allows for this option would be very beneficial to the Army G-1 analyst.

APPENDIX. TACCOM DATA

This appendix contains tables of TACCOM data provided by DAPE-PRS.

Grade	ACC	AV
LT	13518	341
CPT	17962	1612
MAJ	10541	672
LTC	6460	426
COL	2384	171

Table 8. The initial ACC and AV branch officer inventory data.
 For example, there are 13,518 LTs in the ACC of which 341 are in the AV branch.

Grade	2006	2007	2008	2009	2010	2011	2012	2013
LT	9163	9586	9981	10377	10716	11076	11246	11292
CPT	15657	16176	16750	17032	17335	17624	17743	17742
MAJ	10507	10946	11345	11481	11613	11722	11751	11749
LTC	6578	6720	6803	6849	6897	6921	6930	6929
COL	2379	2401	2428	2407	2418	2422	2422	2422

Table 9. The current ACC officer requirements as established by the PMAD.
 For example, the Army requires 16,176 CPTs in FY 2007 and 6,720 LTCs in FY 2007.

Grade	2006	2007	2008	2009	2010	2011	2012	2013
LT	483	471	475	473	473	474	474	474
CPT	1428	1411	1426	1400	1404	1407	1408	1411
MAJ	746	772	794	796	808	813	813	813
LTC	500	514	505	493	492	490	489	489
COL	144	157	153	151	152	152	151	151

Table 10. The current AV officer requirements as established by the PMAD.
 For example, of the officers in the ACC, the Army requires 1,411 CPTs in FY 2007 and 514 LTCs in FY 2007 in the AV branch.

TIG	LT	CPT	MAJ	LTC	COL
1	4294	3850	1584	798	375
2	691	3000	2082	1721	502
3	26	2405	1485	1159	438
4	9	3597	1486	975	372
5	5	2044	1392	781	307
6	0	2090	1507	561	186
7	0	934	491	175	123
8	1	25	250	152	64
9	0	15	173	95	12
10	2	2	91	43	5

Table 11. The TIG of the ACC inventory.

For example, as of November 2006, there were 4,294 ACC LTs with one year TIG, 691 with two years TIG, and 26 with three years TIG.

TIG	LT	CPT	MAJ	LTC	COL
1	271	262	114	45	31
2	58	284	142	106	43
3	2	258	103	68	30
4	6	392	106	54	29
5	2	182	67	61	16
6	0	136	79	41	13
7	0	95	22	19	5
8	1	3	19	13	3
9	0	0	12	15	1
10	1	0	8	4	0

Table 12. The TIG of the AV officer inventory.

For example, as of November 2006, there were 271 AV LTs with one year TIG, 58 with two years TIG, and 2 with three years TIG.

TIG	LT	CPT	MAJ	LTC	COL
1	0.16%	1.54%	1.13%	1.16%	0.29%
2	0.08%	0.28%	1.53%	1.55%	0.15%
3	6.68%	3.98%	0.10%	0.07%	0.02%
4	0.05%	3.42%	0.16%	0.01%	0.06%
5	0.00%	0.81%	0.66%	0.40%	0.10%
6	0.01%	1.30%	0.17%	0.13%	0.01%
7	0.01%	0.02%	0.18%	0.17%	0.02%
8	0.01%	0.01%	0.04%	0.02%	0.03%
9	0.01%	0.03%	0.02%	0.03%	0.00%
10	0.01%	0.02%	0.03%	0.02%	0.00%

Table 13. ACC attrition rates used in the TACCOM.

For example, the attrition rate for CPTs with three years TIG is 3.98% for the ACC.

TIG	LT	CPT	MAJ	LTC	COL
1	0%	0%	0%	1%	3%
2	4%	0%	0%	4%	1%
3	0%	0%	0%	5%	4%
4	29%	5%	0%	0%	1%
5	21%	50%	0%	10%	1%
6	0%	0%	0%	0%	0%
7	0%	0%	0%	0%	1%
8	0%	0%	0%	0%	0%
9	0%	0%	0%	0%	0%
10	0%	0%	0%	0%	0%

Table 14. AV attrition rates used in the TACCOM.

For example, the attrition rate for CPTs with five years TIG is 50% for the AV branch.

THIS PAGE INTENTIONALLY LEFT BLANK

LIST OF REFERENCES

- Brown, G.G., Dell, R.F., and Newman, A.M., 2004, "Optimizing Military Capital Planning," *Interfaces*, v. 34, pp. 415-425, November.
- Corbett, J.C., 1995, *Military Manpower Planning: Optimization Modeling for the Army Officer Accession/Branch Detail Program*, M.S. Thesis, Naval Postgraduate School, Monterey, California, September.
- Durso, A., and Donohue, S.F., 1995, "An Analytical Approach to Reshaping the United States Army," *Interfaces*, v. 25, pp. 109-133, January-February.
- Haight, M.J., Lieutenant Colonel, United States Army, 2006, Officer Personnel Program Analyst, Military Strength Analysis and Forecasting Division, Directorate of Plans, Resources, and Operations, ODCSPER, Interview with author, 6 November.
- Henning, C.A., 2006, "Army Officer Shortage: Background and Issues for Congress," *CRS Report for Congress*, 5 July.
- Hoffman, A., Lieutenant Colonel, United States Army, 2006, Officer Promotions Program Analyst, ODCSPER, Interview with author, November.
- Holz, B.W., and Wroth, J.M., 1980, "Improving Strength Forecasts: Support for Army Manpower Management," *Interfaces*, v. 10, pp. 37-52, December.
- GAMS/CPLEX, (2003), <http://www.gams.com/dd/docs/solvers/cplex.pdf>, Retrieved February 2007.
- Gass, S.I., Collins, R.W., Meinhardt, C.W., Lemon, D.M., and Gillette, M.D., 1988, "The Army Manpower Long Range Planning System," *Operations Research*, v. 36, pp. 5-17, January-February.
- Gillen, M.A., 2006, "Officer Personnel Management System Changes to Grow Adaptive Leaders," Army News Service, 5 September.
- Lewis, W.I., Major, United States Army, 2006, Officer Personnel Program Analyst, Military Strength Analysis and Forecasting Division, Directorate of Plans, Resources, and Operations, ODCSPER, Interview with author, November.
- Lukens, M.W., Lieutenant Colonel, United States Army, 2006, Officer Personnel Program Branch Chief, Military Strength Analysis and Forecasting Division, Directorate of Plans, Resources, and Operations, ODCSPER, Interview with author, 21 November.
- Knighton, C., Colonel, United States Army, 2006, Chief, Leader Development Division, Human Resources Command, Interview with author, 28 November.

- Schirmer, P., 2006, *Challenging Time in DOPMA Flexible and Contemporary Military Officer Management*, Rand, National Defense Research Institute, RAND Corporation.
- Shrimpton, D., and Newman, A.M., 2005, "The U.S. Army Uses a Network Optimization Model to Designate Career Fields for Officers," *Interfaces*, v. 35, pp. 230-237, April.
- U.S. Army, 2005a, *Commissioned Officer Development and Career Management, DA PAM 600-3*, Headquarters, Department of the Army, U.S. Government Printing Office, December.
- U.S. Army, 2005b, *United States Army Posture Statement, FY 06*, Office of the Chief of Staff, U.S. Army, April.
- U.S. Army, 2005c, *Officer Promotions, DA PAM 600-8-29*, Headquarters, Department of the Army, U.S. Government Printing Office, February.
- U.S. Army, 2006, *How the Army Runs: A Senior Leader Reference Handbook, 2006-2007*, U.S. Army War College, U.S. Government Printing Office, April.
- U.S. Army, 2007, https://www.hrc.army.mil/site/active/opmd/Branch_Homepages.htm, April. Retrieved April 2007.
- U.S. Congress, House, Committee on Armed Services, Subcommittee on Military Compensation, 1981, *Hearings on S. 191 8, Defense Officer Personnel Management Act (DOPMA), before the Military Compensation, Subcommittee of the Committee on Armed Services, House of Representatives, Ninety-sixth Congress, second session, April 29, May 7, 13, 14, and September 29, 1980*, Washington, D.C.
- United States Government Accountability Office, Report to Congressional Committees, 2006, *Force Structure* <http://www.gao.gov/cgi-bin/getrpt?GAO-06-745>, September. Retrieved April 2007.
- Yamada, W. S., 2000, *An Infinite Horizon Manpower Planning Model*, M.S. Thesis, Naval Postgraduate School, Monterey, California, June.
- Yamada, W. S., 2002, <http://hces.bus.olemiss.edu/conference/Infinite>, Gainesville, Florida, June. Retrieved May 2007.

INITIAL DISTRIBUTION LIST

1. Defense Technical Information Center
Ft. Belvoir, Virginia
2. Dudley Knox Library
Naval Postgraduate School
Monterey, California
3. Robert F. Dell
Naval Postgraduate School
Monterey, California
4. Lieutenant Colonel Paul L. Ewing
Naval Postgraduate School
Monterey, California
5. Matthew W. Carlyle
Naval Postgraduate School
Monterey, California
6. Office of the Secretary of Defense
ATTN: PA&E, Rm 2D272, LTC Mark Lukens
Washington, D.C.
7. Office of the Deputy Chief of Staff for Personnel
ATTN: DAPE-PRS, Rm 2B453, MAJ Bubba Lewis
Washington, D.C.
8. Major Hise O. Gibson
West Point, New York