

**HEADQUARTERS
AIR FORCE SPECIAL WEAPONS CENTER
AIR FORCE SYSTEMS COMMAND
KIRTLAND AIR FORCE BASE, NEW MEXICO**

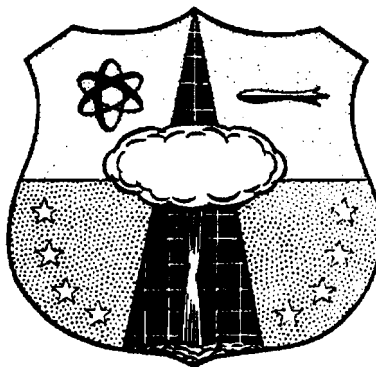

**PRELIMINARY PLAN
for
OPERATION
FISH BOWL (U)
NOVEMBER 1961**

DECLASSIFIED WITH DELETIONS BY DTRA
AUTHORITY: EO. 12958, as amended;

DOE O2SA208000287-ML and

AF NWCA (AF/XCW) Hr dtd 30 Jun 2002

[Signature] DATE: Apr. 6, 2007

DISTRIBUTION STATEMENT A
APPLIES PER NTPR REVIEW.

[Signature] DATE: 12 Apr. 2007

SWRP-1-0115/45

Report Documentation Page

Form Approved
OMB No. 0704-0188

Public reporting burden for the collection of information is estimated to average 1 hour per response, including the time for reviewing instructions, searching existing data sources, gathering and maintaining the data needed, and completing and reviewing the collection of information. Send comments regarding this burden estimate or any other aspect of this collection of information, including suggestions for reducing this burden, to Washington Headquarters Services, Directorate for Information Operations and Reports, 1215 Jefferson Davis Highway, Suite 1204, Arlington VA 22202-4302. Respondents should be aware that notwithstanding any other provision of law, no person shall be subject to a penalty for failing to comply with a collection of information if it does not display a currently valid OMB control number.

1. REPORT DATE NOV 1961		2. REPORT TYPE N/A		3. DATES COVERED 01 MAR 1962 - 01 JUN 1962	
4. TITLE AND SUBTITLE Preliminary Plan for Operation Fish Bowl				5a. CONTRACT NUMBER	
				5b. GRANT NUMBER	
				5c. PROGRAM ELEMENT NUMBER	
6. AUTHOR(S)				5d. PROJECT NUMBER 7811	
				5e. TASK NUMBER 781106	
				5f. WORK UNIT NUMBER	
7. PERFORMING ORGANIZATION NAME(S) AND ADDRESS(ES) Research Directorate Air Force Special Weapons Center Air Force Systems Command Kirtland Air Force Base, New Mexico				8. PERFORMING ORGANIZATION REPORT NUMBER	
9. SPONSORING/MONITORING AGENCY NAME(S) AND ADDRESS(ES)				10. SPONSOR/MONITOR'S ACRONYM(S)	
				11. SPONSOR/MONITOR'S REPORT NUMBER(S)	
12. DISTRIBUTION/AVAILABILITY STATEMENT Approved for public release, distribution unlimited					
13. SUPPLEMENTARY NOTES					
14. ABSTRACT Operation FISHBOWL is a proposed series of high altitude nuclear effects tests to be performed during 1 March 1962 to 1 June 1962. It is concluded that the three intermediate altitude shots have higher priority. It is concluded that one and possibly two of these intermediate experiments can be accomplished during the present time schedule. If the maximum time allowable for the test series were extended two weeks, the third high priority experiment might also be performed. The THOR launched from Johnston Island is suitable as a warhead carrier. Burst phenomenology has been examined and the primary experimental objective determined. These objectives can be satisfied in the execution of the proposed plan.					
15. SUBJECT TERMS High altitude nuclear test Radar and communications Burst phenomenology					
16. SECURITY CLASSIFICATION OF:			17. LIMITATION OF ABSTRACT SAR	18. NUMBER OF PAGES 91	19a. NAME OF RESPONSIBLE PERSON
a. REPORT unclassified	b. ABSTRACT unclassified	c. THIS PAGE unclassified			

HEADQUARTERS
AIR FORCE SPECIAL WEAPONS CENTER
Air Force Systems Command
Kirtland Air Force Base, New Mexico

Major General Charles M. McCorkle
Commander

Colonel Carey L. O'Bryan, Jr.
Deputy Commander

Colonel Donald I. Prickett
Director, Research Directorate

This document is classified ~~SECRET-RESTRICTED DATA~~ because it
contains information on nuclear effects.

WARNINGS

SPECIAL HANDLING REQUIRED--~~NOT~~ RELEASABLE TO FOREIGN
NATIONALS.

The information contained in this document will not be disclosed to
foreign nationals or their representatives.

Reproduction of this document in whole or in part is prohibited except
with the permission of the office of origin.

~~SECRET~~

95 pp

OPERATION FISHBOWL (U)
(PRELIMINARY PLAN)

November 1961

RESEARCH DIRECTORATE
AIR FORCE SPECIAL WEAPONS CENTER
AIR FORCE SYSTEMS COMMAND
KIRTLAND AIR FORCE BASE, NEW MEXICO

APPROVED:



DONALD I. PRICKETT
Colonel USAF
Director
Research Directorate

PROJECT 7811
TASK 781106

1

SWRP-1-0115 Cy 45 of 50 Cys

~~SECRET~~

~~RESTRICTED DATA~~
ATC 1954

THIS IS A BLANK PAGE

ABSTRACT

Operation FISHBOWL is a proposed series of high altitude nuclear effects tests to be performed during 1 March 1962 to 1 June 1962. [

Related

It

is concluded that the three intermediate altitude shots have higher priority. ~~These three experiments and possibly the other two can be done during the time period.~~ The Thor launched from Johnston Island is suitable as a warhead carrier. Burst phenomenology has been examined and the primary experimental objective determined. These objectives can be satisfied in the execution of the proposed plan. (S. [redacted])

*
NOTE
CHANGE
NEXT
PAGE
iii (a)

PUBLICATION REVIEW

This report has been reviewed and is approved.

John J. Dishuck

JOHN J. DISHUCK
Colonel USAF
Deputy Chief of Staff for Operations

Correction to Abstract, AFS&C TR-61-96:

In place of the fourth sentence, put the following:

* "It is concluded that one and possibly two of these intermediate experiments can be accomplished during the present time schedule. If the maximum time allowable for the test series were extended two weeks, the third high priority experiment might also be performed.

INDEX

ABSTRACT

- I. Introduction
- II. Experimental Objectives and Plans
- III. Warhead Selection
- IV. Vehicle Selection
- V. Costs

APPENDICIES

- A. Thor Vehicle
- B. Telemetry and Tracking
- C. Description of Experiments
- E. Chronology
- F. Small Vehicles

BIBLIOGRAPHY

DISTRIBUTION

I. INTRODUCTION

In a previous report, AFSWC TR 61-95, a plan for executing a series of high altitude nuclear tests beginning in July 1962 has been considered. The present report has been prepared to describe a plan for executing a meaningful series of such tests during the time period 1 March 1962 to 1 June 1962. Because of the compressed time scale some experiments cannot be accomplished; however, the burst phenomenology and experimental objectives have been examined more carefully and it is believed that the primary objectives of the series can be met, although there will be some loss of redundancy, reliability and refinement. (SECRET)

The primary objective of the overall series is to obtain data regarding the interference to radar and communication systems produced by a high altitude nuclear burst. The data available at present coupled with theory are sufficient to show that blackout has serious implications for critical defense systems such as BMEWS, Nike-Zeus, ICBM penetration and many communication systems, and conversely that its employment may be an effective ICBM offensive tactic. The magnitude of the effects is tremendously dependent upon the conditions of the burst. Present data and theories are inadequate for evaluation of systems effectiveness in a nuclear war. The present series is intended to cover a range of burst conditions where specific applications are optimized. (SECRET)

The burst phenomenology for various altitudes and yields has been considered and is described in some detail for a specific set of conditions in Section II. In this section also, the primary experimental objectives are discussed along with a suggested set of primary experiments which are considered possible in the time scale. The individual experiments are described in more detail in Appendix D. It is considered important that those tests be conducted with proven warheads and not in conjunction with development tests. However, it may be necessary to conduct these tests in conjunction with the AEC weapon development program, and in particular in conjunction with their proposed OAT program. Therefore, in Section II, there is consideration of acceptable yield and altitude variations which will permit attainment of primary effects test requirements. (SECRET)

Since it may not be possible to complete a five shot program the following priority assignment is suggested:

Priority	Altitude
1	<i>Deleted</i>
1	
2	
3	
3	

The basis of this assignment is discussed in Section II. {

Deleted } (SECRET)

Because of the short time available for development, it is recommended that the Thor vehicle be used as a warhead carrier with essentially no vehicle modifications.

8
Deleted
The warhead considerations are described in Section III and the vehicle considerations are described in Section IV. Launch site possibilities are briefly discussed in Section II. (SECRET ~~DD~~)

II. EXPERIMENTAL OBJECTIVES AND PLANS

A. INTRODUCTION

Considerations of nuclear safety, eyeburn, and operation suitability dictate selection of Johnston Island as the most promising operational base for all tests of Operation Fishbowl. Other operational possibilities considered include Eniwetok, Kwajalein, Christmas Island and the possible use of Atlas training missiles fired from Vandenberg AFB to carry the warhead to the test area. Eniwetok and Kwajalein were ruled out on the basis of possible eyeburn danger to natives of adjacent islands and logistics problems. In addition to the eyeburn problem, Christmas Island has no advantages as a test site which would justify the added complexity of negotiating for its use with the United Kingdom. The use of Atlas training missiles at first seems to offer economic and logistic advantages; however, the CEP of the Atlas poses severe problems in obtaining adequate burst point instrumentation. Furthermore, the political implications of a possible failure of a nuclear armed Atlas over civilian populace seems to outweigh any possible advantages of this choice of warhead carrier. (~~SECRET~~)

[Deleted]

The altitude differential between each of the shots is such that the weapon phenomenology will be quite different for each shot. [Deleted] Two shots are desired to define the altitude at which fireball blackout effects are most intense and persistent. [Deleted]

[Deleted]

[Deleted] (~~SECRET~~)

[Deleted]

These pancakes, both in the burst region and at the magnetic conjugate points, are in addition to the layers of radiation produced ionization. [Deleted]

[Deleted] (~~SECRET~~)

All shots of the Fishbowl series should be detonated at night to facilitate obtaining the maximum in photographic and spectrographic coverage.

In addition to those experiments which are specifically discussed in connection with each shot, an extensive ground and ship based network of riometers, sky cameras, etc., will be employed for all shots. Long range radio propagation experiments will also be carried out by existing ground receiving stations. (~~SECRET~~)

Recognizing that it is impossible to perform three tests on three successive days, some consideration has been given to the required time spacing between shots. Certainly the limiting factor in performing this test series in a very short time is in relocating the experiments and instrumentation from one shot to the next. It should be recognized that the large disturbances of ambient conditions caused by these detonations do not die away within a day or two. Therefore the following minimum times between tests, based on these disturbances, are required:

<u>Test</u>	<u>Minimum time to next test</u>
[Deleted]	2 - 3 days
	3 - 5 days
	6 - 8 days
	1 - 2 weeks
	1 - 2 weeks

It is therefore necessary that the higher altitude shots be performed last to accomplish the total test series in minimum time. (UNCL)

B. BLUEGILL, (Deleted)

1. Phenomenology:

[Deleted]

The fireball at one micro-second after burst is a sphere of less than one Km radius. At that time it is at a temperature between 10 and 20 ev. Air at this temperature and density is a sufficiently good radiator and loses a large part of its energy in a relatively short time. However, the cold air surrounding the radiating fireball is a correspondingly good absorber of the radiations so that only a small portion of the available energy is transported to large distances. The remainder is absorbed in a thin shell surrounding the fireball. This shell is heated and ultimately becomes an integral part of the fireball. This mechanism of radiative diffusion is that by which the fireball cools and expands. (

Deleted

] Then the expansion velocity should drop to about 0.05 Km/sec.
(SECRET)

[Deleted] Again based on scaling from Teak and Orange, the rise velocity is expected to be about 0.5 Km/sec and increases slightly as P/P_0 decreases (as altitude increases). It is this rise of the fireball which accounts for the apparent Northward movement of an area of ionization produced by the trapped beta particles. As it rises, the fireball encounters magnetic field lines which constrain and trap the negatively charged betas and produce ionization in more Northerly areas. This area appears to "move" North with a velocity of 0.95 Km/sec (roughly twice the rise velocity) as the originally produced ionization recombines and new ionization patches are formed. Measurements during the Orange shot did not yield information on the intensity, extent, or "velocity" of this ionization. Also there was no reason to suspect the occurrence of this phenomena until in late 1959 when the mechanism was postulated to account for unexplained riometer data. (SECRET) *

The visible fireball consists of air heated and multiply ionized by the x-rays, bomb debris, and beta particles. From recent calculations by AFSWC and other organizations, it appears that this region is opaque to kilomegacycle frequencies for times possibly as long as 30 seconds. There is, however, an outer ionized region which is formed initially by the prompt gamma radiation and is then held in a highly ionized state by the UV and IR emissions from the visible fireball. This region is not well defined but is thought to extend out to at least another fireball radius. While less opaque than the visible fireball, it is nevertheless an integral part of the fireball blackout problem and must be defined in space as a function of time. (SECRET)

II-3

* The importance of this mechanism of beta induced ionization was not fully recognized until late in 1959 when the phenomena was postulated to account for unexplained riometer data. (SECRET)

Table 1 presents a picture of the fireball from intermediate out to later times. The values given are for the whole fireball, i.e., the visible plus the outer regions. The last column permits the reader to easily calculate the approximate attenuation of various frequencies when expressed in megacycles. (~~SECRET~~)

Table 1 Fireball Parameters

For a pictorial representation of the fireball rise and expansion for various times after burst, refer to figure 1.

<u>Temperature</u> <u>(Degrees K)</u>	<u>Electron</u> <u>Density</u>	<u>Radius</u> <u>(Km)</u>	<u>Time</u> <u>(sec)</u>	<u>Altitude</u> <u>(Km)</u>	<u>Attenuation</u> <u>(db)</u>
--	-----------------------------------	------------------------------	-----------------------------	--------------------------------	-----------------------------------

Deleted

2. Test Objectives:

To determine:

- a. fireball transparency as a function of time and incident EM frequency
- b. fireball rate of growth and rise
- c. spatial extent, persistence, and intensity of beta induced and D-region ionization
- d. structural response to thermal radiation near the visible fireball
- e. radiation flux near the fireball region. (~~SECRET~~)

3. Experimental Plan:

The selection of yield for this experiment is discussed in Section III. (

~~Deleted~~) The allowable error for yield prediction is $\pm 25\%$. (SECRET)

{ ~~Deleted~~)

} Burst position is 35 Km south of Johnston Island. (CONFIDENTIAL)

Table 2 depicts the airborne experiments to be conducted during this test. A more detailed explanation of each experiment is presented in Appendix D. In addition to these experiments, ground instrumentation including riometers, ionosondes, optical and photographic equipment, and radar are planned for the burst area and the northern conjugate point. The ground experiments are deployed in such a manner as to minimize the risk of failure to observe unpredicted events while still maintaining sufficient coverage for the predicted phenomena. ~~Wherever possible, use has been made of existing geophysical facilities to examine the global nature of the effects of a high altitude detonation.~~ These experiments are discussed in the Appendix D. It should be noted that in addition to the fireball blackout measurements, the optical/IR experiments constitute the most important set of measurements to be performed. It is required that this test be conducted at night since a daytime test precludes performance of optical measurements. (CONFIDENTIAL)

Figure 1 is a side view of the fireball blackout experiment and depicts various transmission paths through the fireball region as it expands and rises. The figure shows only one rocket trajectory since a second trajectory would apogee at the same position and would transmit through the region in the same manner. (CONFIDENTIAL)

Figure 2 represents a blown-up top view of the burst area with the various experimental rocket trajectories over the fireball. (UNCLAS)

Figure 3 is a map of the Pacific test area with the approximate area of the fireball with the beta region superimposed. (UNCLAS)

~~Secret~~

Table 2

50 Km Shot - Experimental Plan (Burst Location - 35 Km South of Johnston)

TYPE OF VEHICLE	EXPERIMENT	EXPERIMENT START TIME (sec)	POSITION AT START TIME	LAUNCH LOCATION	APOGEE	CONTRIBUTE TO TEST OBJECTIVE
2 Nike-Cajuns	Fireball Black-out - 1,5,10 KMC Transmitters	T-0	<u>VERTICAL</u> <u>HORIZONTAL*</u>			
	Fireball Black-out - 2,4,8 KMC Transmitters	T-0				
3 Nike-Cajuns	Chemistry	T + 120				
		T + 300				
		T + 600				
2 Nike-Cajuns	MF/HF Attenuation	T - 600				
		T + 1200				
1 Nike-Cajun	Top Side Sounder	T + 120				
1 Nike-Cajun	HF/VHF Attenuation, 30, 100, 1000 Mc	T - 0				
Pods-Thor Carrier	Radiation Measurements	T - 0				
	Thermal Response	T - 0				
	Thermal Response	T - 0				
Aircraft	1 KC-135 Optics and soundings at Conjugate Point 2 U-2 1 at conjugate point - optics and gamma counters 1 in burst area - optics 1 RC-121: Radar Clutter 1 Type UNK: Photography DME/TACAN - Positioning ships and aircraft - located on Johnston and Samoan Island					

Deleted

* Horizontal Distance from Burst Point

** Radial Distance from Burst Point

~~Secret~~

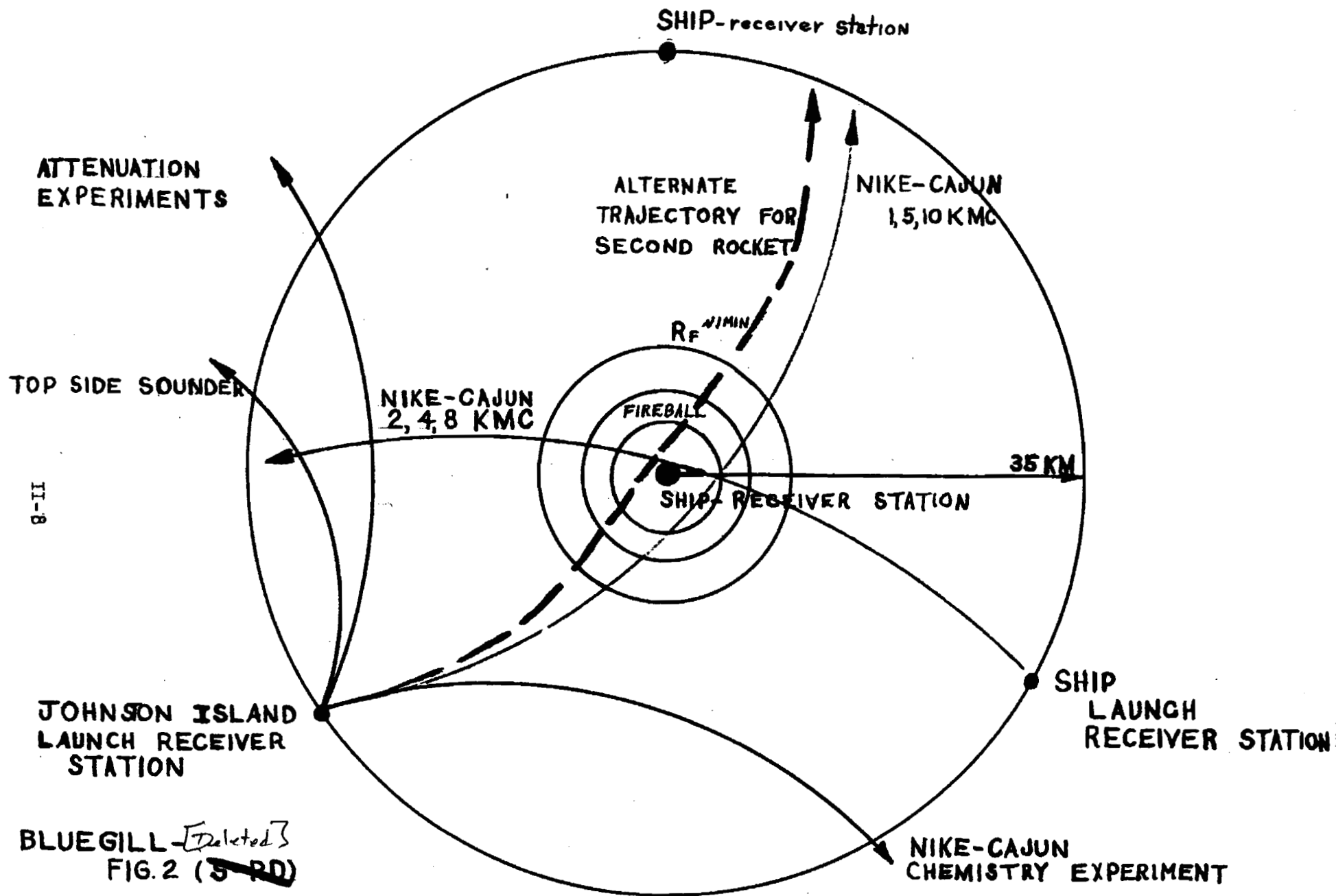

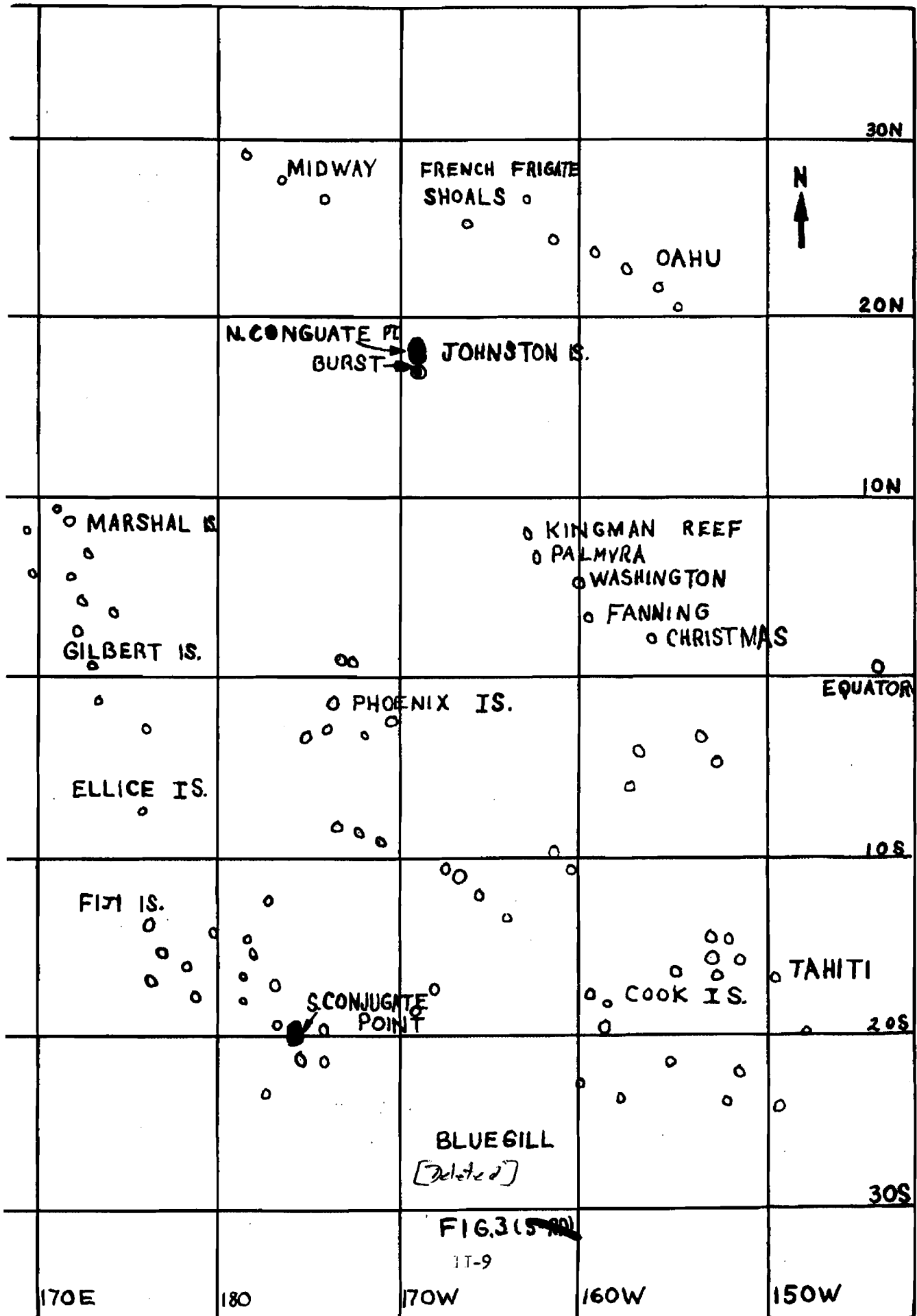

C. KINGFISH, ~~Deleted~~

1. Phenomenology:

At this altitude, the x-ray mean free path is very large (thousands of kilometers horizontally) and there is no sharp "fireball" formed near the burst as in lower altitude bursts. However, air density is still sufficient to be the primary mechanism for containing the expansion of the bomb materials. For example, a 10 Km sphere of air at this density contains approximately 20 times the mass of the bomb. (U)

Figure 4 depicts the situation a few milliseconds after burst. There will be a high electron density in a 10 Km "sphere" due to x-ray deposition. While the bomb materials at this time are 1-2 kilometers from burst point, the betas from the debris are producing ionization patches 2-4 Km wide at the conjugate point, altitudes of 60-70 Km. (~~SECRET~~)

There is at present no adequate theoretical model for predicting the subsequent motion of the debris cloud. Scaling of the Teak rise and expansion velocities by means of a Taylor solution for a strong hydrodynamic shock yields a rise velocity (U) ~ 10 Km/sec and an expansion velocity (v_e) ~ 3.5 Km/sec. While the use of these scaling laws are much in question for this altitude, they are in agreement with machine calculations performed by Aeromutronic which give $U \sim 9$ Km/sec and $v_e \sim 5$ Km/sec. In contrast, the pressure gradient model (the heated sphere is accelerated upward by a pressure gradient resulting from an exponential density distribution), which correctly predicts the Teak rise velocity, yields $U \sim 3$ Km/sec. This range of uncertainty leads to widely and, subsequently, differing effects on EM propagation as can be seen by its effect on the beta patch position. (~~CONF~~)

The rise velocity of the debris is directly translated into northward motion of the north conjugate point beta patch or southward motion of the south conjugate point beta patch. Using a magnetic dip angle of 29° , one obtains the horizontal velocity of the beta patch as 1.8 times the rise velocity of the debris cloud. It is of interest to note that for large dip angles (high latitudes) the beta ionization will be relatively insensitive to the rise of the debris cloud. This would lead to high electron densities in a fixed region. (~~CONF~~)

2. Test Objectives:

- a. Determination of the debris cloud extent and motion as a function of time after burst.
- b. Quantitative measure of the ionization densities and attenuation effects both near the burst and at the conjugate points (D-layer ionization).
- c. Determination of the infra-red and optical radiation effects produced by bursts at this altitude.

d. Low flux x-ray effect measurements (Secondary).

c. Radiation flux measurements (Secondary). (~~CONF~~)

3. Experimental Plan:

[Deleted]
altitude will change the objectives, no variations in detonation altitude are recommended. (~~SECRET~~) (Since a change in

Table I summarized the experiment envisaged for this shot. In addition to these experiments which are described in detail in Appendix D, there will be ground and ship based optical instrumentation for infrared and optical effects. Ionosondes and ricimeters will be used in monitoring ionospheric disturbances whenever possible. Radar will be used for tracking the debris cloud. In addition, three or more aircraft will be used to obtain photographic tracking and coverage of both the debris cloud and northern beta patch. (U)

~~Secret~~

Table 3

- EXPERIMENTAL PLAN (BURST LOCATION-100 km SSW OF JOHNSTON)

Type of Vehicle	Experiment	Experiment Start Time (sec)	Position At Start Time	Launch Location	Apogee	Remarks	Contribute To Test Objective	
3 Thor Pods	X-Ray Flux	T-0						
	Radiation Measurements							
1 XM-33	Gamma Scanner	T-0						
4 Nike-Cajuns	Chemistry Experiments	T-0						
		T+20						
		T-0						
		T-0						
6 Nike Cajuns	MF-HF Absorption	T-500						
		T+120						
		T-0						
		T+10						
		T-600						
		T+0						

Deleted

Nike Cajun Topside Sounder T+120

~~Secret~~

~~Secret~~

Table 3 (Con't)

Type of Vehicle	Experiment	Experiment Start Time (sec)	Position At Start Time	Launch Location	Apogee	Remarks	Contribute To Test Objective
2 Ship	Riometers Ionosondes Optical/IR Propagation Photographic Etc.	T-0	Below Burst	--	--	--	a,
			300-500 km N of Johnston				b, c
Ground, Ship, Airborne	Riometers Ionosondes Optical/IR Propagation Radar Photographic Etc.	T-0	15°S-176°W	--	--	--	a,
			18°S-176°W				b, c
			In Burst Area				

II-13

Page II-14 is deleted.

~~Secret~~

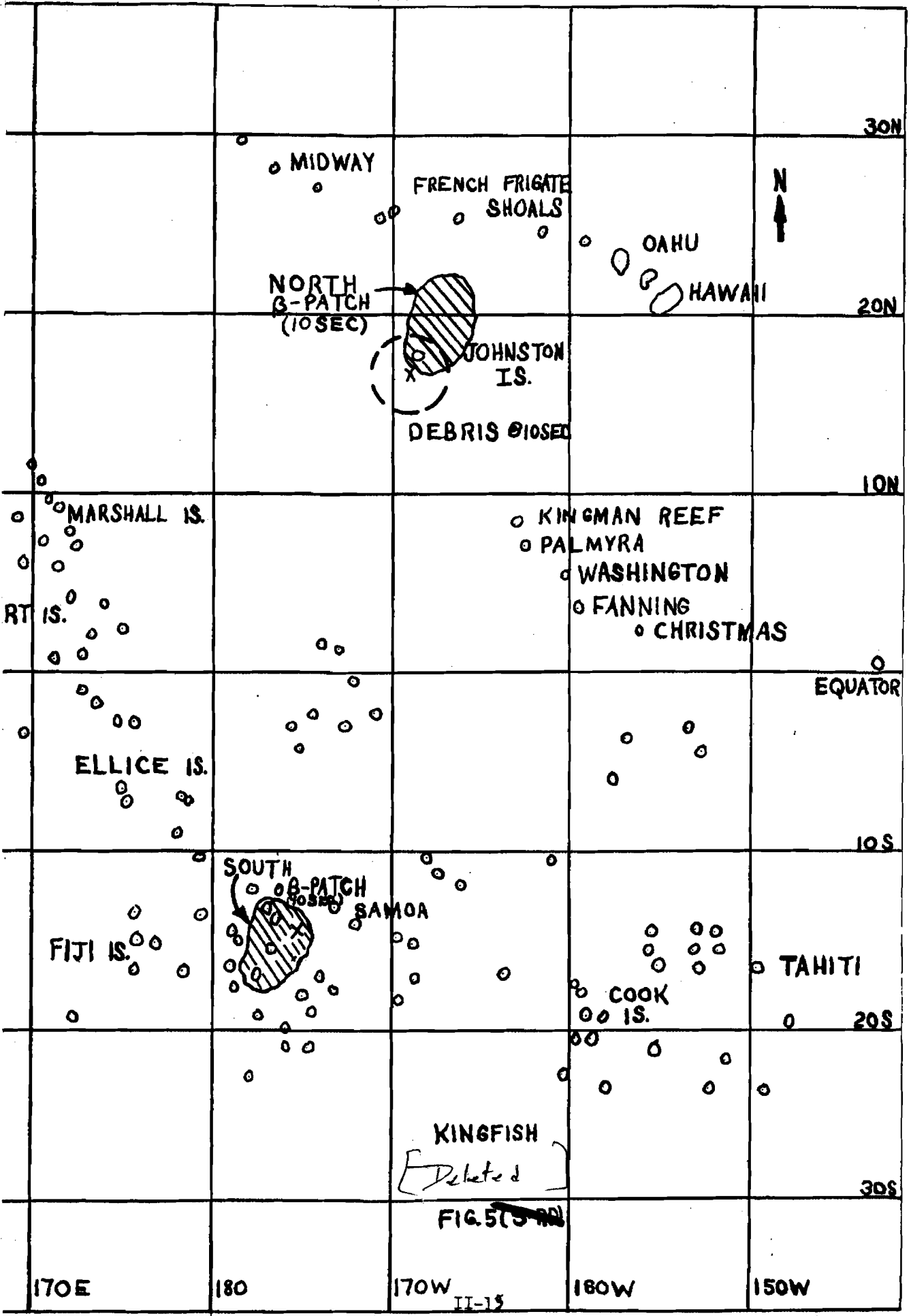

D. STARFISH, 400 km, 1.45 MT

1. Phenomenology:

For bursts above about 200 km the bomb debris and the weapon radiations are not confined by the atmosphere; consequently, the phenomena associated with this detonation are radically different from those of lower altitude detonations. At 400 km the mean free paths for the bomb radiations (X-rays, gamma rays, and neutrons) are hundreds of kilometers. Because of these long mean free paths, the energy of the initial x-ray pulse will be deposited and produce ionization at altitudes from 100 km out to line of sight distance, i.e., about 2000 km. At this distance the initial electron density is about 10^7 electrons/cm³. Decay time is such that electron density becomes approximately 10^6 electrons/cm³ after about 2 minutes and then returns to ambient in about 10 minutes. Ambient at this altitude is about 10^3 electrons/cm³. The prompt gammas and neutrons will be absorbed at altitudes of about 30 to ~~70~~ km to produce ionization which decays in a few minutes. These prompt phenomena occur in times on the order of milliseconds. (CONF)

~~The portion of the bomb debris that is directed downward~~ has an initial velocity of about 10^8 cm per second. After less than $\frac{1}{2}$ of a second, the downward directed debris particles are stopped by the atmosphere in a layer about 20 km thick at an altitude between 110 and 150 km and with a horizontal radius of about 250 km. Debris deposition will cause this region to be slightly heated, causing the pancake to rise with a velocity of about 1 km/second to an altitude of 200 to 250 km in two or three minutes. The gamma rays produced by decay of the fission products in the pancake will be deposited in the D region of the ionosphere at a 70 km altitude out to a line of sight distance of about 1000 km from the pancake. The betas from the debris will be deposited primarily between 65 and 70 km in altitude in an area below and to the north of the pancake. Pancake rise will cause the betas, which are constrained to follow the field lines, to deposit their energy progressively further northward. (SECRET)

The sideward and upward portions of the expanding debris, assuming it is ionized, will be slowed and contained by the ion-loaded magnetic field. The horizontal radius at the time which debris expansion ceases will be about 400 km with an upward stopping distance of nearly 600 km above the detonation altitude. The ion-loaded magnetic field is the stopping mechanism in these directions. Some fraction of the fission debris and betas contained in this region will be trapped by the magnetic field and transported to the conjugate point where it will spread over an area with dimensions of over 1000 km. Fission debris deposition altitude at the conjugate point will be about 110 km, while the betas will be deposited as far down as 60 km. Continued decay of the fission debris will cause increased beta and some gamma ionization over the entire conjugate point region. In addition to the conjugate point effects, some of the betas from the detonation will be trapped in the magnetic field for long times and create an Argus shell. (SECRET)

Figure 6, drawn to scale, shows the extent of ionization caused by particle and radiation deposition in the atmosphere from a detonation at 400 km. The maximum debris expansion distance is shown at a time of about $\frac{1}{4}$ of a second, but the debris deposition at the conjugate points occurs at much later times. Figure 7 is a map showing the extent of ionization produced by each kind of radiation. Beta and gamma induced electron density as a function of time for altitudes below 95 km is plotted in Figure 8. As can be seen, the electron density decays to about 10^4 electrons/cm³ and stabilizes temporarily. In Figures 9 and 10 the ionization levels produced by betas and gammas are shown separately. Figures 8-10 apply to the regions of Figure 6 beneath and to the north of the debris pancake. (SECRET)

2. Test Objectives:

The purpose of this test is to determine the intensity and duration of the ionized layers produced in the upper atmosphere by the deposition of bomb fission debris and radiations, and to determine the efficiency of injection of relativistic electrons into stable orbits in the earth's magnetic field.

These effects produce intense and persistent upper atmosphere ionized layers, both in the burst region and at the magnetic conjugate point, which cause radio and radar blackout over large areas. In order to achieve sufficient understanding of phenomenology of a nuclear burst at this altitude and to permit accurate prediction of system blackout effects, the following test observations must be made: (SECRET)

a. Determination of the location, intensity, extent, and motion of the debris pancakes both ^{near} the burst ~~altitude~~ and at the conjugate points. (SECRET)

b. Determination of the intensity and extent of the stratified ionization produced by x, gamma and beta rays. (UNCLAS)

c. Determination of the time history of the collapse of the debris cloud, subsequent magnetic trapping of betas and fission products, their transport to conjugate points, and the resultant buildup and decay of conjugate point ionization. (UNCLAS)

3. Experimental Plan:

The Detonation: Previous discussions of the phenomenology assumed a nominal yield of 2 MT at an altitude of approximately 400 km. The requirements for understanding this type of burst and the resultant debris pancake phenomena can be satisfied by the detonation altitudes and corresponding yields shown below in Table 4: (SECRET)

TABLE 4

Acceptable Burst Parameters

<u>Altitude (km)</u>	<u>Yield (MT)</u>
400	1.5 - 2.5
350	1.1 - 1.85
300	0.8 - 1.3 (CONF)

After a detonation altitude and corresponding yield have been selected, the following accuracies must apply:

- a. Detonation altitude known with ± 100 meters
- b. Yield known within $\pm 20\%$.

The principle factors in determining the geographical location of the test are the placement of instrumentation and the flash blindness (eyeburn) problem. The latter dictates that the detonation should be as far away as possible from Islands which are within line of sight. (Since line of sight at an altitude of 400 km is about 2200 km there is no location which excludes all inhabited land masses from the line of sight of the burst.) A convenient location from the standpoint of instrumentation is south of Johnston Island since there is much existing equipment which can be used. A detonation 600 km SW of Johnston is suggested. For a detonation at this location, about 0.0041 calories/cm² is the maximum amount of energy in the visible region which an observer in Hawaii (1850 km line of sight) would receive on the eye retina under the conditions most favorable for eyeburn. Islands closer to the detonation, but still at least 1000 km away (see figure 7), will receive only slightly higher thermal fluxes. Based upon previous experiences (Teak and Orange) these intensities are well within any reasonable safety margin. Those islands within 1000 and 2000 km from the proposed burst point are shown in figure 7. (CONF)

Since much valuable data can be obtained from time and spectrum resolved photography, this dictates that the test be performed at nighttime when auroral photographic conditions are best. (UNCLAS)

Instrumentation: The specific experiments of this test and the required instrumentation are listed in Table 5 together with the test objective(s). Each experiment is described in detail in Appendix D. (UNCLAS)

~~Secret~~
TABLE 5

400 km Shot-Experimental Plan (Burst Location-600 km SW of Johnston)

Type of Vehicle	Experiment	Experiment Start Time (Sec)	Position at Start Time	Launch Location	Apogee	Remarks	Contribute to Test Objective
3 XM-33's	Gamma Scanner	T / 60	~ 50 km Altitude	~ 1500 km SE of Burst (Palmyra Island)	~ 300 km	Near vertical launch-some attitude control required	a, b, c
		T / 900		1500 km E of Conj.Pt. Samoa			
		T / 120					
2 Nike-Cajuns	MF-UHF Attenuation	T / 60	~ 50 km Altitude	Ship ~ 100 km NE of Burst	~ 200 km	Near vertical launch	a, b
		T / 400		Johnston Island			
1 Nike Cajun	Debris Magnetometer	T - 0	~ 500 km Altitude ~ 100 km NE of burst	Johnston Island	~ 500 km		c
3-4 Nike-Cajuns	Chemistry Experiments	T / 120	~ 80 km Altitude	Johnston Island	~ 80 km	Launch Slightly Southward	a, b, c
		T / 300					
		T / 400 420					
		T / 600					
2 Nike Cajuns	MF-HF Absorptions	T-600	~ 50 im altitude	Johnston Island	~ 100 km	Launch Slightly southward	b
		T-1200					
1 Nike Cajuns	Topside Sounder	T/120	~ 150 km Altitude	Johnston Island	~ 400 km	Launch Slightly Southward	b
1 Satellite	Beja Detector	In orbit before test	Not of too much importance	—	Apogee < 2000 km Perigee > 200 km	May be piggyback on another satellite	c

~~SECRET~~

TABLE 5 (Cont.)

Type of Vehicle	Experiment	Experiment Start Time (Sec)	Position at Start Time	Launch Location	Apoqee	Remarks	Contribute to Test Objective
2 Ships	Riometers Ionosondes Propagation Optical/IR Photographic etc.	T-0	Midway Between Johnston Is. & Fr. Frigate Shoals	-	-		a, b,
			~100 km N of Burst			Also launches one attenua- tion rocket	c
Ground Ship & Airborne	Riometers Ionosondes Propagation Optical/IR Photographic etc.	T-0	Johnston Is. Fr. Frigate Shoals Conjugate Area	-	-	-	a, b, c

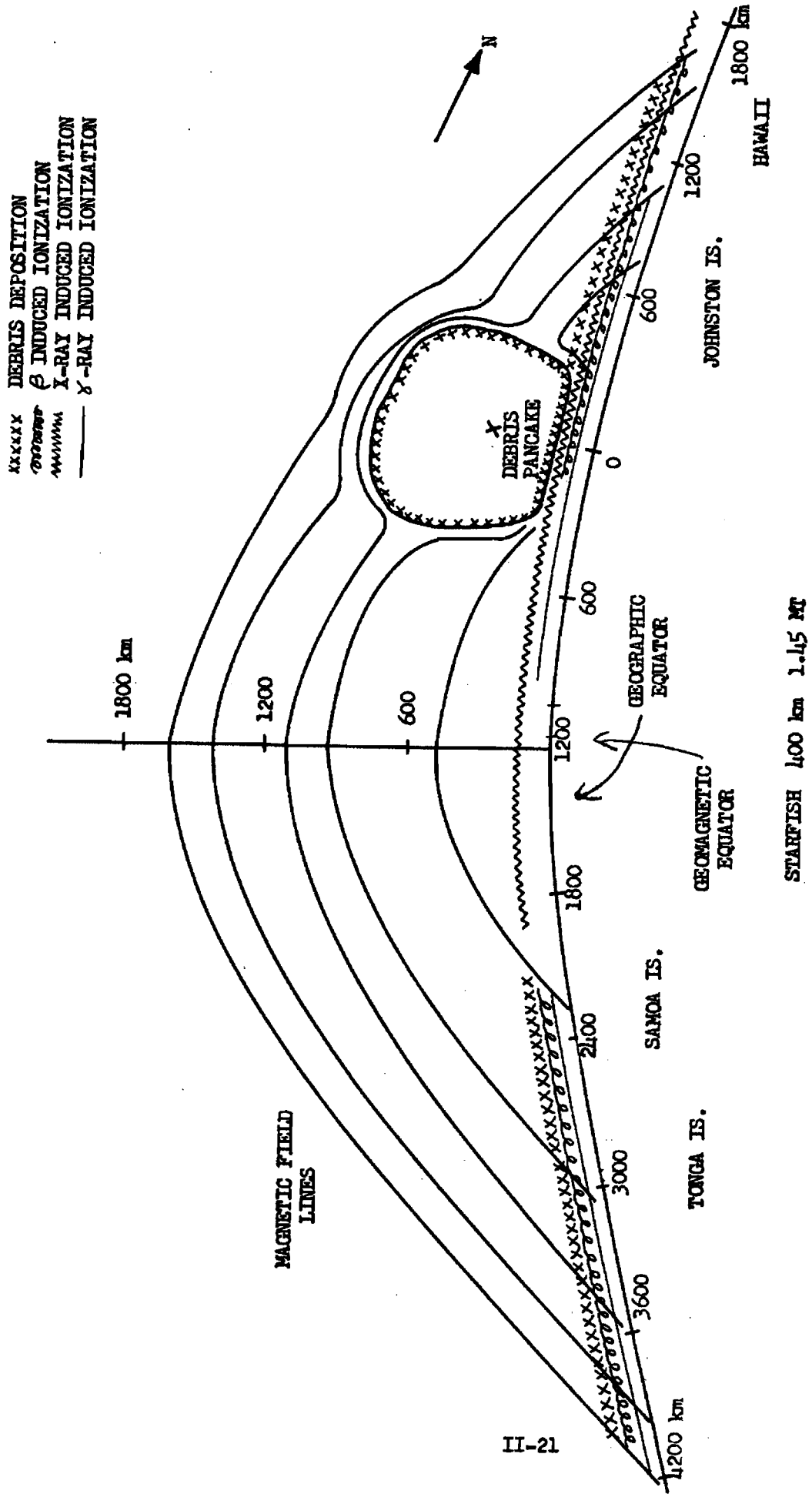
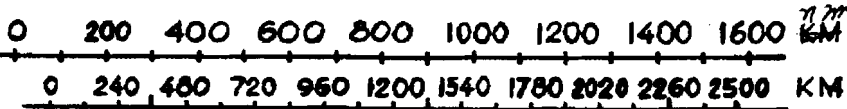

FIGURE 6 (S-RD)



SCALE: 1" = 600 KM.

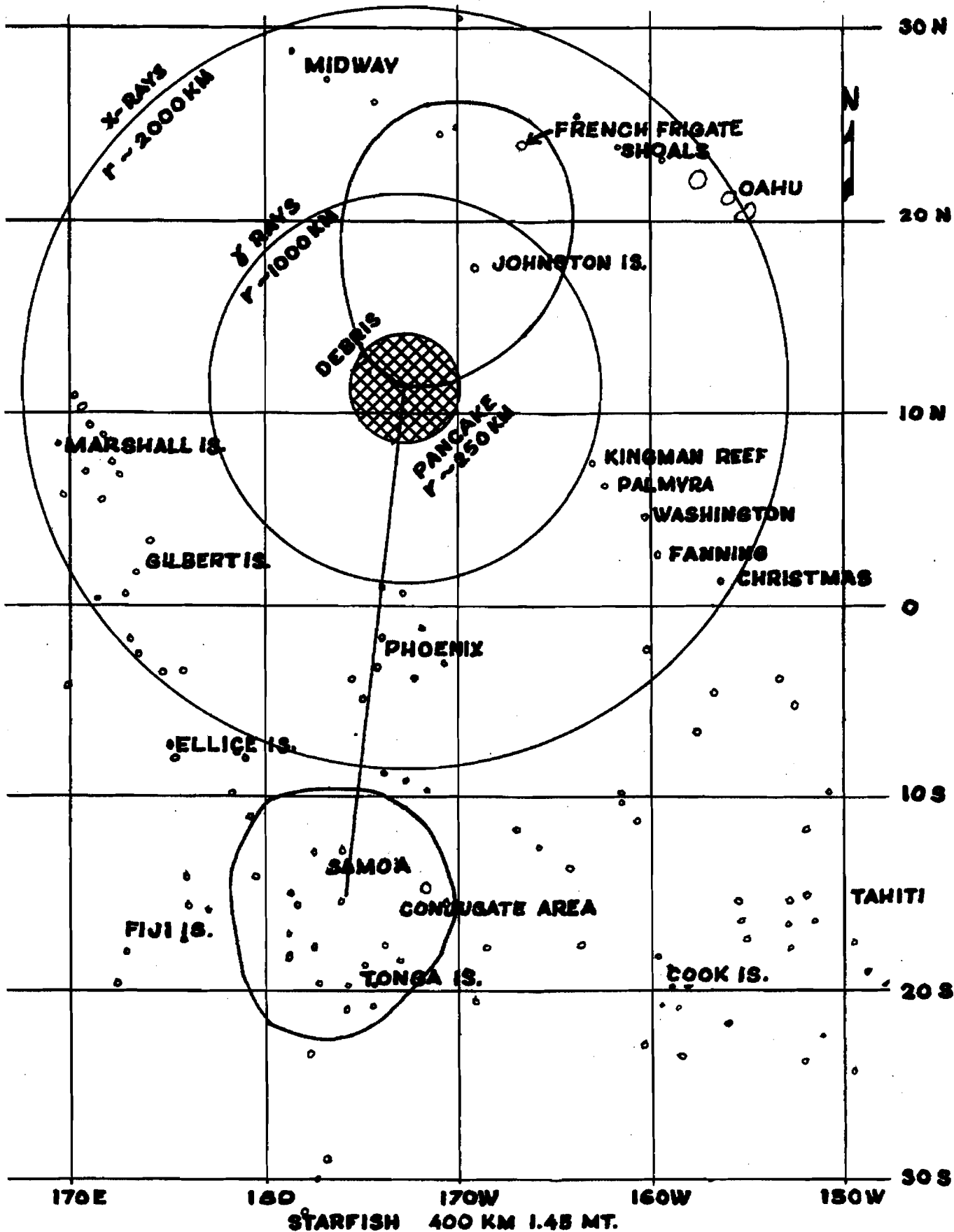
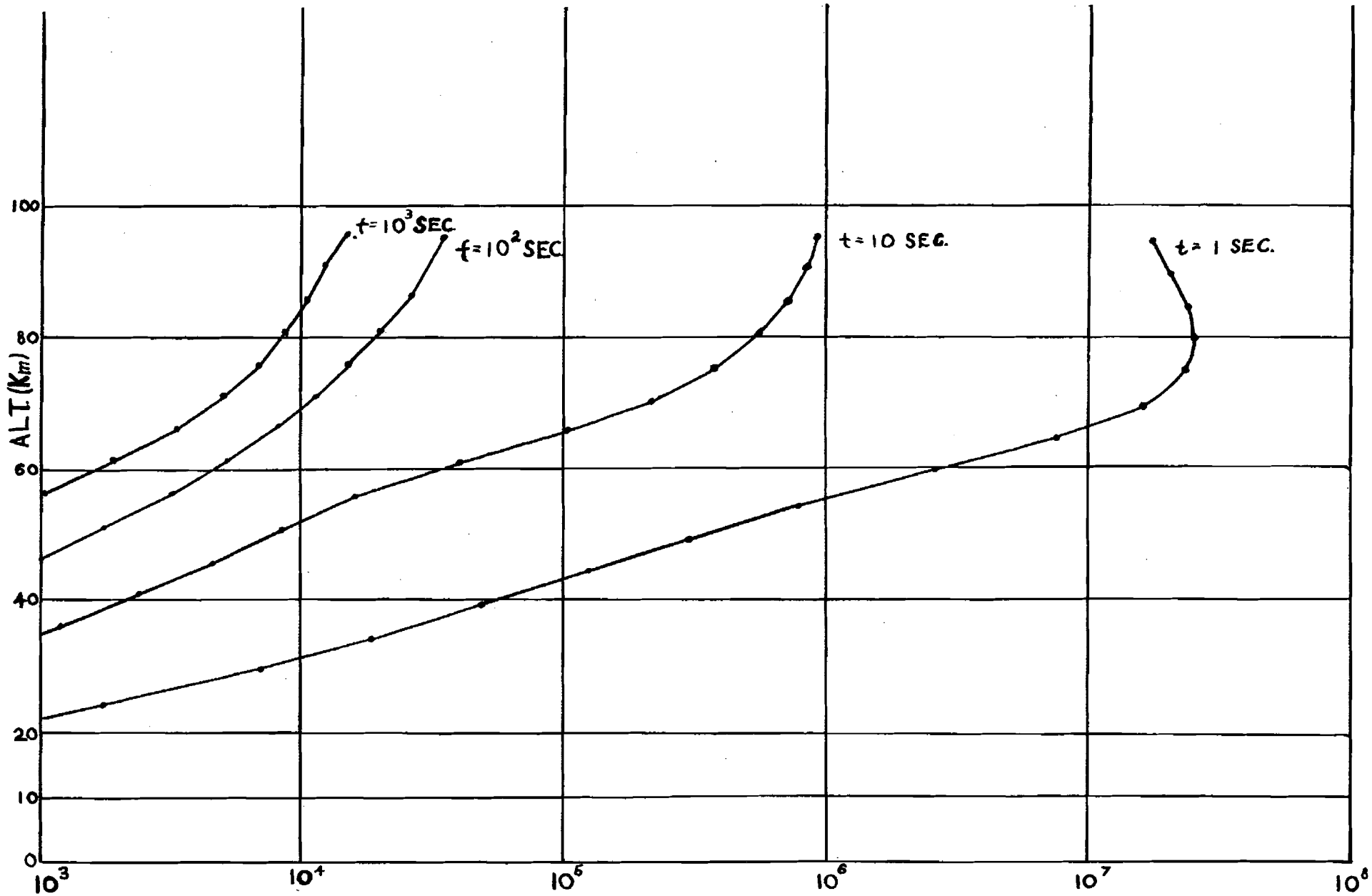
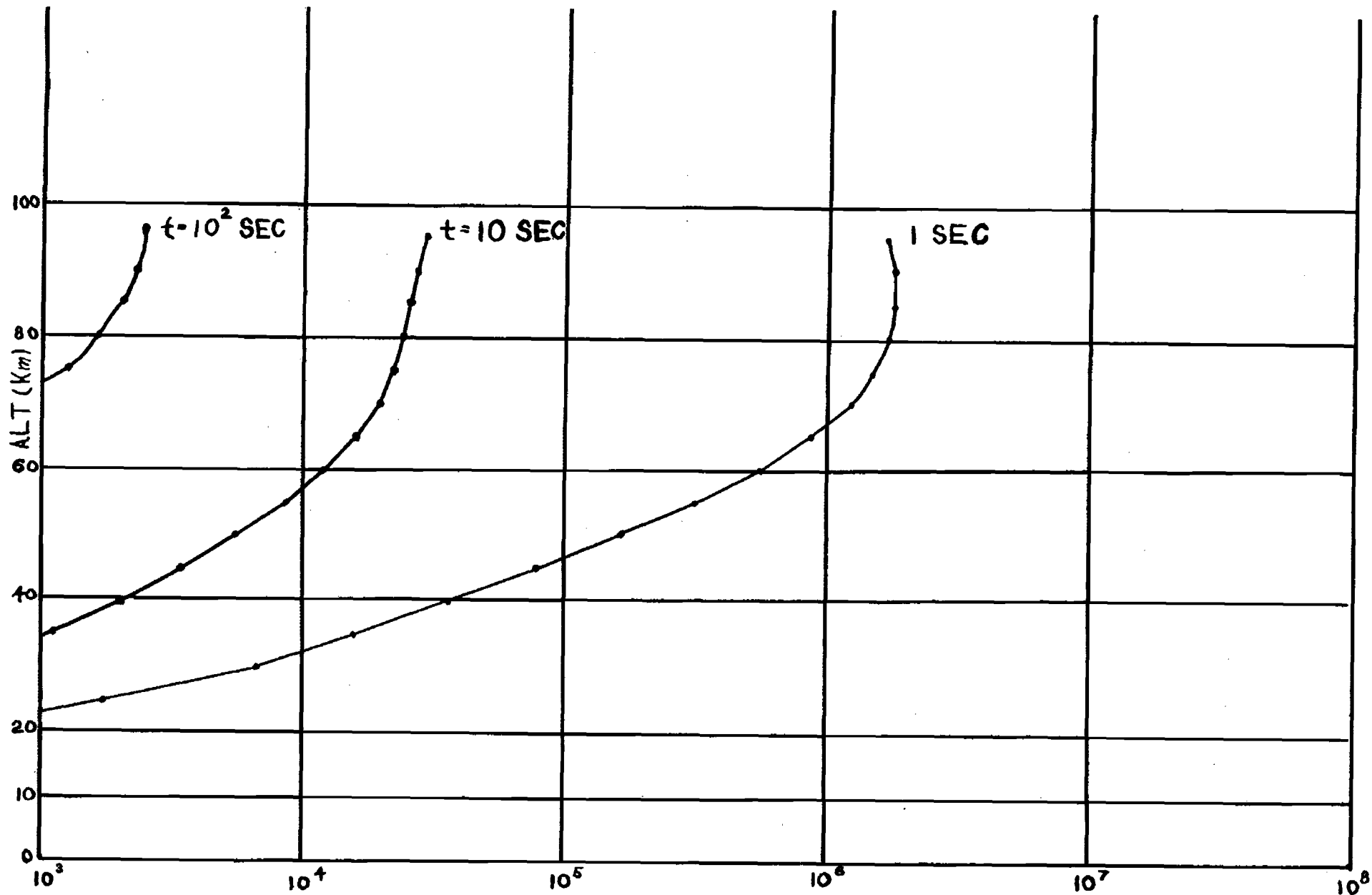

FIG. 7 (S-PA)



ELECTRON DENSITY (e/cm^3)
 $\beta + \gamma$ INDUCED ELECTRON DENSITIES
 FIG. 8 (S) ~~RD~~ II-23



ELECTRON DENSITY (e/cm^3)
 & INDUCED ELECTRON DENSITIES

FIG. 9 (S. RD) II-24

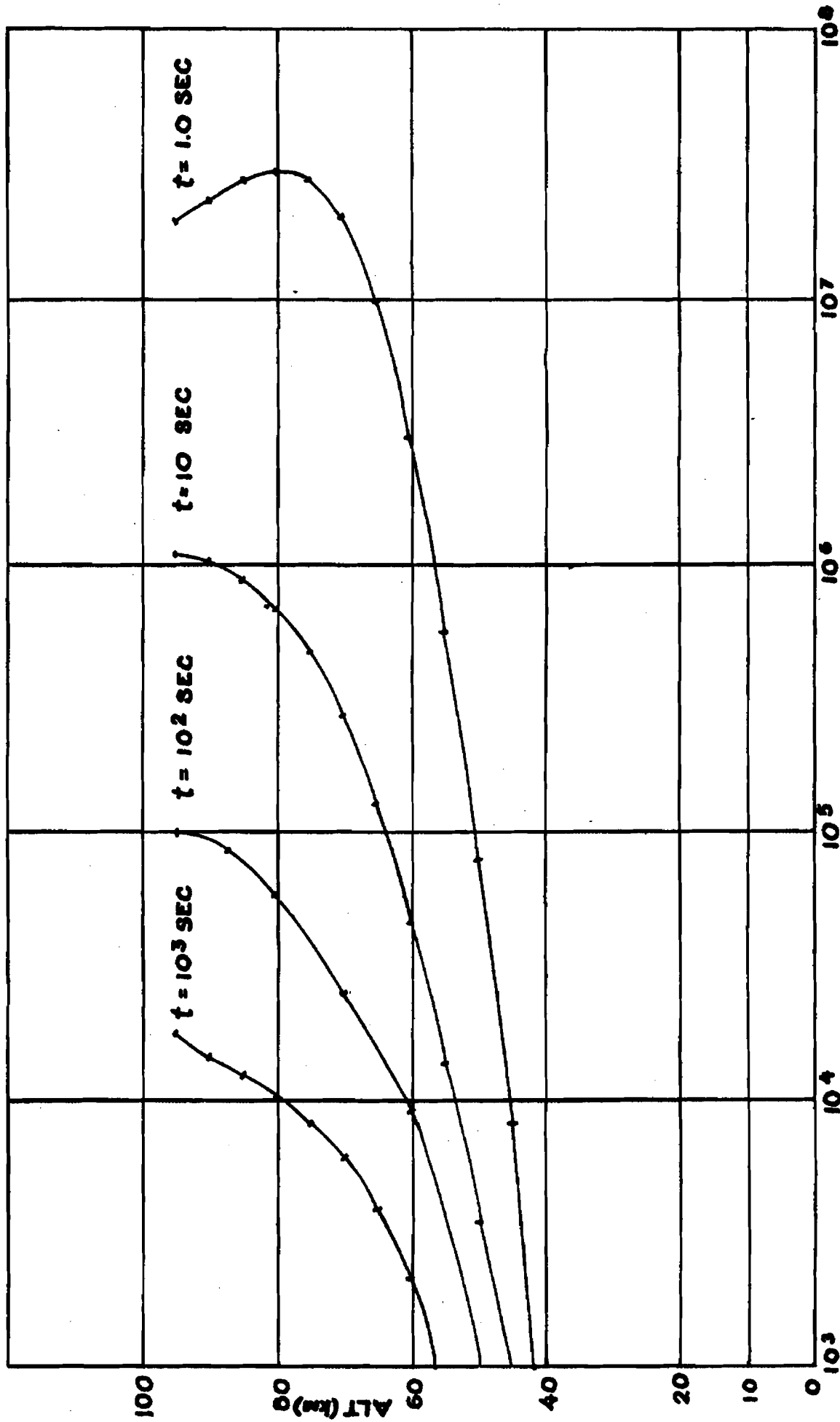

FIG. 10 ELECTRON DENSITY (e/cm^3)
 INDUCED ELECTRON DENSITIES

II-25

E. ADDITIONAL SHOTS FOR CONSIDERATION:

1. Introduction

L Deleted }
To
ensure that these additional shots received adequate consideration in determining the final approved shot schedule for Operation Fishbowl, they are discussed in detail in the following paragraphs. (~~SECRET~~)

2. Deleted

a. Phenomenology:

The space and time history for a burst at this altitude will resemble that given for Bluegill except that it will produce more localized effects. The expansion and rise velocities will be somewhat smaller since the radiation mean free path is much shorter at this altitude. The scaled (from Hardtack) rise velocity for this shot is 0.06 km/sec and the expected expansion velocity is less than 0.1 km/sec. (~~CONF~~)

At this altitude the range of beta particles is roughly 100 meters; hence, they do not escape from the fireball. The net rate of production and the effects of ionization by the betas is indistinguishable from the fireball and will not appreciably change the fireball electron density. Therefore, it is concluded that the betas play an unimportant role in ionization for this detonation. (~~CONF~~)

The figures and tables drawn up for Bluegill will apply to this detonation although the values will be slightly smaller. (UNCLAS)

b. Test Objectives:

(1) To determine the time at which the fireball becomes transparent to kilomegacycle EM frequencies. (UNCLAS)

(2) To perform quantitative measurements on the temperature, state of ionization, and expansion and rise velocities of the fireball as a function of time after burst. (UNCLAS)

c. Experimental Plan:

The experimental plan developed for the Bluegill shot applies to this test with ~~no~~ ^{only one} substantial modification, ~~with one exception~~. Since

the blackout effects will be more locally confined than at higher altitudes, the global propagation experiments will not be performed. Rocket trajectories and deployment of ground based and aircraft-borne measuring stations will be altered commensurate with the smaller dimensions of the phenomena expected. (SECRET)

Radar will be employed to track the fireball from the ground. Other ground based experiments will remain essentially unchanged. Refer to Table 2 for a list of experiments. (UNCLAS)

To properly conduct a nuclear blast acceleration experiment on re-entry vehicles, it is estimated that the minimum lead time required is twelve months. Furthermore, it is believed that three separate shots spaced a few weeks apart are necessary to obtain the necessary data. These requirements preclude the performance of blast measurements during the currently planned series of high altitude tests. (SECRET)

3. [Deleted]

a. Phenomenology:

The limits on the debris expansion for detonations at these altitudes are determined by the earth's magnetic field. The expansion of the ionized debris will push aside the magnetic field lines and produce a field-free "magnetic bubble." The ambient ions pushed along with the magnetic field will absorb some debris energy, slowing the expansion velocity. The debris-magnetic field interaction will continue only as long as the debris remains ionized. At present, however, there is considerable uncertainty regarding the state of ionization of the debris after the first 100 meters of expansion. Depending upon the opacity of the debris atoms, the material may cool radiatively to sufficiently recombine. Since the expansion would proceed unaffected by the magnetic field, this circumstance would have drastic influence upon subsequent effects and is a prime datum to be obtained. Once the debris becomes neutral the magnetic field plays no part in the containment process. Then the neutral debris particles will move radially outward, cross field lines, decay, and cause ions and electrons to be trapped in the magnetic field at large distances from the bubble. (SECRET)

[Deleted] This spheroid will later deform as the debris cools and becomes neutral, and as the magnetic field turbulently penetrates the burst region. As the magnetic bubble decays debris particles will penetrate the atmosphere downward to altitudes of about 100-200 km depending on their energy and mass. In addition, a considerable amount of electrons and debris material are injected into the magnetic field and will cause extensive conjugate point ionization. (SECRET)

~~Deleted~~

) In the downward

direction the debris would be stopped by the ionosphere at approximately 200 km altitude. This very large bubble is disconcerting for several reasons: (1) the extent of beta injection is so large that great difficulty is anticipated in unravelling the spatial distribution of the trapped electrons; (2) parts of the shell were mirror points are high have a very long lifetime and may perturb surveillance satellite development programs; and (3) the debris expansion is limited by different mechanisms in the various directions.

~~Deleted~~ ~~(SECRET)~~

2

b. Test Objectives:

The major purposes of studying this detonation are to investigate the debris-magnetic field interaction, motion of the debris, hydro-magnetic wave propagation, conjugate point ionization and effects, the generation of an Argus shell, and any unpredicted phenomena. This burst should permit study of the turbulent Argus phenomenon, i.e., synchrotron radiation from electrons trapped on the turbulent field lines at the time the magnetic bubble starts to break up. ~~(SECRET)~~

Should the conjugate point ionization be sufficient it would be possible to blackout areas thousands of miles from the burst regions for significant times. ~~(SECRET)~~

c. Experimental Plan:

A burst location several hundred km southwest of Johnston Island appears to present a good location for studying both burst and conjugate point effects. The location and extent of debris at the conjugate points will be determined by collimated gamma ray detectors - two launched at about 1500 km from each conjugate point. The northern conjugate point is initially near French Frigate Shoals while the southern point is just south of Samoa. ~~(SECRET)~~

Fast rise time magnetometers and debris measurement instrumentation will be flown into the burst region by suitable rockets where the debris expanding past the instruments will allow study of the debris-magnetic field interface. Extensive surface and airborne equipment will measure conjugate point ionization, spectrographic and photographic phenomenology of the detonation and conjugate points, and empirical radio and radar attenuation by ionized regions. ~~(SECRET)~~

III. WARHEAD SELECTION

A. Possible Warheads

1. The following devices were considered as having possible application to this series of tests:

<u>Device</u>	<u>Weight (lb)</u>	<u>Diameter (in)</u>	<u>Length (in)</u>	<u>Total Yield</u>	<u>Fission Yield</u>
---------------	--------------------	----------------------	--------------------	--------------------	----------------------

Deleted

~~(SECRET)~~

2. Discussion of Applicability

Each of the warheads which might be used in this test series is listed above. The suitability of each warhead in being, plus those proposed for development during this time period was considered. Consideration was also given to the possible modification of existing warheads to make them compatible with the launch vehicle: (discussed in Section IV). ~~(SECRET)~~

E Deleted Only this warhead would be available for shot Bluegill. It is an acceptable warhead for accomplishing the objectives of this shot. ~~(SECRET)~~

Deleted

~~(SECRET)~~

B. Arming and Fuzing

The Sandia Corporation is developing a safing and fuzing system for high altitude, missile delivered tests of nuclear devices. This system, with very little modification, will be capable of arming and fuzing essentially any nuclear device on command from the ground when delivered with a missile such as the Thor. The package can be made available for this series and will be compatible with all the nuclear devices previously discussed. (SECRET RD)

C. Conclusions

Within the warhead requirement considerations there are no warheads other than those selected which are readily available and compatible with the experimental objectives of Operation FISHBOWL.

1. Warhead selection criteria are as follows:

a. The warheads must have yields suitable to meet the experimental objectives.

b. The warheads must have predictable yields, and therefore must have been tested prior to this test series. In some instances this requirement may be waived if acceptable yield certification is received.

c. The warheads must be available for this test series without a major development or production program on the part of the AEC laboratories.

d. The warheads and their fuzing and systems must be electrically and mechanically compatible with the selected delivery system. (SECRET RD)

2. {

Deleted

2
√ This yield variation is acceptable and will not degrade completion of the test objectives. (SECRET RD)

IV. VEHICLE SELECTION

A. Introduction.

The time scale of the operation poses a serious limitation on selection of necessary vehicles to accomplish the experimental objectives. While a large number of boosters are available with sufficient performance, only a few of these systems would not require extensive engineering for satisfying all warhead fit and warhead positioning requirements.

[Deleted]

In a longer time scale (two years) plan, one can probably provide several desirable features in the warhead carrier not available in a few months time period. For example, self propelled pods and rockets can be mounted on the carrier to improve positioning accuracy of scientific experiments. The operational plan can be simplified by providing warhead carriers on the less complicated solid propellant systems. Booster costs can be reduced by tailoring the vehicle more precisely to the requirements of each experiment although it is only fair to recognize that generally speaking booster costs are a very small part of the total cost of any missile launch. (S)

The decision was made to attempt to satisfy the experimental objectives with vehicles available "on the shelf", and to avoid any vehicle modifications which would lead to Atomic Energy Commission requirements for proof test to satisfy reliability and safety criteria. The vehicles selected meet these objectives. (S)

In addition to the warhead delivery capability it was felt necessary to provide additional capacity for secondary payloads. All of the large boosters considered; Thor, Redstone, Polaris, have excess capability in the lower altitude. If external ejection of secondary payloads could be accomplished the modifications to a payload carrier section would be held to a minimum. The Thor has this external capability while the Polaris does not without extensive engineering. (S)

At low altitudes the Thor is not fully utilized. The consideration of a single system providing operational expediency overcame the objection of "wasting" vehicle performance. Thor trajectories were exceptionally adaptable to the warhead positioning considerations. (S)

B. Selection Parameters - Warhead Carrier.

1. The selection process for the warhead carrier began with consideration of the warhead weight. The payload weights for the warhead

carrier were established as described above at roughly 1500 to 2500 pounds including payload carrier structure and aerodynamic shield. For this weight range and from surface to 1000 kilometers apogee there are a large number of carriers with sufficient performance to accomplish the necessary weapon placement. Those considered were the Aerojet Senior engine in a Blue Scout first stage configuration, the Thor, and the Redstone and Polaris in somewhat less detail. (S)

2. In order to keep costs and support requirements to a minimum it was decided that a single type vehicle currently in production, capable of meeting all altitude requirements, requiring minimum modification and a proven high degree of reliability was the most desirable. Secondary objectives make it desirable to select a vehicle capable of carrying external ejectable scientific instrumentation packages. (S)

3.5

Deleted

C. Blue Scout.

Deleted

Additional

development would be required to adapt the payload carriers to the proposed warhead and also to attach external stores. The additional development required to adapt the Blue Scout configuration to this operation would require a series of test firings in order that reliability could be established. (U)

D. Redstone.

Deleted

It does not appear wise in view of potential requirements for bursts at higher altitudes to accept this limitation. In order to use the present Redstone payload carrier, extensive modifications would have to be accomplished on the warhead fuzing system. Although the Army has said that a sufficient number of these vehicles could be made available to accomplish Operation Fishbowl, the Redstone is not considered the most desirable vehicle. (S)

E. Polaris.

All altitude requirements can be accomplished with the Polaris; however, the payload carrier would require extensive modification to accept

the warheads selected and there are no provisions for attaching external instrumentation packages. Modifications are of such a nature that vehicle proof testing would be required to establish reliability. (S)

The Polaris has one extremely desirable feature which is operational flexibility. The question of withdrawal of these missiles from the operational stockpile was not considered in detail but is believed to be a limitation on the operations plan. The solid propellant systems have a potentially serious drawback. For low altitude applications considerable hardware and propellant remain with the warhead and confuse the diagnostic and debris measurements of the burst. A liquid propellant engine on the other hand can be shut down and the entire booster rejected from the warhead prior to weapon detonation. (S)

Payload capabilities of the Polaris are adequate as shown in the following table:

<u>ALTITUDE - KM</u>	<u>PAYLOAD</u>
[Deleted]

The payload volume restrictions are more severe than in some of the other systems. Payload volumes are adequate however if the operational warhead and missile system is used. In the selection of weapons it was not desired to restrict yields to those available in the operational Polaris. (S-12)

F. THOR

The Thor booster is available from current inventories, can accomplish all altitude requirements, requires only minor modification for adaptation to the proposed warheads, and has an established high degree of reliability. Twenty-three out of twenty-five Thor space boosters launched since 4 October 1960 have been successful. The overall space booster success is 55 in 62 launches. The Thor also has provisions for installation of external ejectable scientific instrumentation packages. (S)

In addition to ^{being} a highly reliable missile, the Thor has the capability of being programmed for booster cut-off at any time during powered flight. This would permit the warhead to be separated from the booster and allow it to proceed on a ballistic path to detonation point; thus, reducing the possibility of the booster interfering with diagnostic and debris investigation. (S)

The average time to complete a countdown is about twelve minutes and the support system is such that the vehicle can be held in approximately T-15 minutes readiness. The launch control officer has complete control to stop a launching up to 0.5 seconds prior to lift-off. In addition, technical holds can be placed into the countdown phase at any time without aborting the mission. This operational feature is extremely valuable for time sequencing other rockets carrying experimental gear aloft. A typical launch emplacement and control area is shown in figure 4, Appendix A.

Payload capabilities of the Thor are adequate as shown in the following table:

<u>ALTITUDE-KM</u>	<u>PAYLOAD</u>
Deleted	13,000# plus 3000# Pods
	13,000# plus 3000# Pods
	3,000# plus 3000# Pods
	3,000# plus 3000# Pods

Payload volume is such that there is no restriction on the selection of a weapon from those proposed.

A more detailed description of the Thor booster characteristics, performance, facilities and AGE is given in Appendix A.

G. Aerospace Ground Equipment.

Aerospace Ground Equipment requirements are similar for the Redstone and Thor. Also, launch pad requirements are similar. The Polaris is designed for tube type launch which would require entirely different operational planning. It was presumed that the U.S. Navy would make their ship USS Observation Island available if the Polaris were selected. Blue Scout facilities and Aerospace Ground Equipment requirements are far less than those of the other three vehicles.

In a program of this nature vehicle reliability is the most important single asset. Although it may be somewhat cheaper to use Blue Scout vehicles from a cost standpoint, it is more desirable to utilize a more expensive vehicle which gives greater assurance of successful mission accomplishment.

H. Summary.

The experimental objectives of this proposal can be met through utilization of a basic Thor configuration to serve as both the warhead

carrier and instrumentation carrier. Additional instrumentation having less stringent placement requirements would be positioned by sounding rockets. It is proposed to use the basic Thor configuration with minor modifications to the operational re-entry vehicle as a means of accomplishing Operation Fishbowl. Attached to the exterior of the vehicle, at the base, would be three ejectable scientific instrumentation pods.

V. PROGRAM COSTS.

A. Funding Requirements

The total cost of the proposed three shot program is estimated to be:

Track and Position Stations (For small rockets)	\$ 5,000,000
Warhead Carrier (Thors and GSE)	14,631,000 (See Appendix A)
Small Rockets, Payload and GSE	12,000,000
Communications (Timing System)	2,000,000
Data Analysis and Publication	1,000,000
Travel	<u>5,000,000</u>
TOTAL	\$39,631,000 (estimated to ± 20%) (U)

These costs do not include the equipping and maintaining of the Joint Task Force. The cost to maintain the project in a state of readiness depends on the scope of the approved experimental program and the resultant need for rocket launch ships and remote sites. The total cost of the missiles is based on all items necessary to provide for the launch of these vehicles with payloads. Launchers are provided for ship launch but no costs are included for the ship. All construction costs unique to missile launch are included. (U)

B. Lead Time

The lead time required to be ready in the field to implement this project is estimated to be five months under the most accelerated, high priority conditions and one year under normal conditions. Limiting items appear to be payload design and fabrication, procurement and installation of ground electronic equipment, Thor ground support equipment installations, and the training of sufficient launch crews to satisfy the small vehicle program. (U)

C. Cost Reductions

Major cost items associated with the prime carrier and probe system will be the ground based equipment. Since these facilities can be used many times with only minor refurbishment there is a real dollar saving

in arranging the experiments to take advantage of existing facilities. This can be done by very careful planning prior to the first detonation. On the other hand, attempting cost savings through reducing spare inventories is a pennywise-pound foolish mechanism in a remote operation of this type. The small rocket "buy" program assumes approximately one spare vehicle for each five vehicles. One spare Thor will be procured. This spare will not be transported to Johnston Island. (U)

In a longer time scale test plan it would be feasible to examine dollar savings through combining experimental payloads. Telemetry transmitters and receivers could be reduced considerably by this approach, as could vehicle tracking costs. (U)

It is possible that some of the Thor launch equipment may be borrowed without formal transfer. Items such as the transport erector cost more than a million dollars. The saving to be gained by using existing government furnished equipment could be very large. (U)

D. Other Support Costs

There is a complete area of support that has been omitted from this section and in fact from the study. This is the general air and ground support for immediate shot analysis and the recording of events for historical purposes. In this category falls all the photographic effort, the aircraft, balloon, or missile cloud sampling for yield determinations, the cloud track, and the ground laboratory facilities. These operations are all reasonably routine in concept as compared to the basic experiments. (

Deleted At the same time, no payload recovery is provided, except with pods, so particulate sampling will necessarily be held to a minimum. Photographic coverage was not believed to impose any operational restrictions and was not considered further. Costs for these additional support operations are presumed to be a very small part of the entire operation, and will only be investigated in detail in an approved operations plan. (U)

APPENDIX A

THE THOR VEHICLE

1. Background.

a. The Thor booster uses a conventional liquid bipropellant system. Fuel is liquid oxygen and either RP-1 or RJ-1. The Rocketdyne main engine develops 150,000 pounds of thrust at sea level conditions and the two vernier engines 1000 pounds of thrust each. The booster is 61 feet long, 8 feet in diameter, with a dry weight of approximately 7,250 pounds and a lift-off weight of 109,200 pounds. Burnout velocity is approximately 13,900 feet per second. Performance curves are shown in figures 1 and 2 of Appendix A. The vehicle profile with nose section attached is shown in Figure 3.

b. This proposal for the use of Thor and its associated equipment as the weapon carrier is based upon use of standard, operationally configured equipment, units of which have been operationally deployed to the United Kingdom. The same equipment is in use at VAFB in support of the R.A.F. combat training launch program.

c. As of 13 October 1961, a total of 101 Thors have been successfully fired out of 128 total launches. The operationally configured, SN-75, Thor has been launched successfully 15 out of 19 times using the standard support equipment during the CTL program. Of these the last eight consecutive shots have been completely successful. A nearly identical vehicle used for a booster in the NASA Delta program has been successfully flown six times in six launches.

d. In addition to a highly reliable missile, the support system has the capability to be held in approximately T-15 minute readiness. The average time to complete a countdown is about twelve minutes. The launch control officer has complete control to stop a launching up to 0.5 seconds of lift-off. In addition, technical holds can be placed into the countdown phase at any time without aborting the mission. This operational feature is also valuable for time sequencing other rockets carrying experimental gear aloft.

e. All items of the Thor weapon system are air transportable. To support the air transportability capability, all pieces of equipment are delivered on roadable undercarriages, thus minimal terminal handling equipment is required.

f. All of the missiles and support equipment are under the management responsibility of the SBAMA at Norton AFB. Approximately fifteen missiles, designated as Combat Training Launch (CTL) or CTL replacements, are in storage at SBAMA. These missiles could be made available almost immediately since all they would require would be compliance with outstanding TCTO's and preparation for shipment. Since these missiles are committed to the CTL program in accordance with agreements with the U.K. a revision to these agreements must be made. In addition, four unassigned

missiles are left over from completed test programs. These missiles would require some reconditioning which could be accomplished in about nine months.

g. The launch complex at Johnston Island will essentially result from disassembly of Pad 6 at Vandenberg Air Force Base, shipment to Johnston Island, and reassembly on a concrete pad poured during the initial work at Vandenberg. AGE spare parts will be supplemented by Pads 8 and 9 at Vandenberg as well as Mira Loma and SBAMA storage. Pad 6 is currently used by SBAMA for in-service engineering efforts. Pads 7 and 8 are used in support of the R.A.F. combat training launch program. This program is not considered to be affected. There is also a liquid oxygen generator in SBAMA storage which is presently unserviceable, but which could be repaired and made available. Re-entry vehicles and A-C guidance systems are available from spares in inventory and appear to pose no procurement problem. (S)

2. Performance.

With some slight modifications to the basic missile the proposed missions can be accommodated by the Thor. Figure 2 shows the operational envelope that can be obtained by the missile. The payloads, including instrumentation pods, are well within the carrier's capabilities. (S)

3. Operation.

The sequence of Thor powered flight events using the inertial guidance system would be as follows:

a. Main stage powered flight starts with ignition of the main engine and two vernier engines. (S)

b. The vehicle rises vertically and rolls to the desired flight azimuth in accordance with pre-set commands. (S)

c. Upon completion of the roll orientation, the missile begins a pre-set pitch program to the desired trajectory. (S)

d. Powered flight continues until main engine cut-off is commanded by the inertial guidance system. The vernier engines then control the missile until cut-off approximately nine seconds after the main engine cut-off. (S)

e. After engine cut-off, latches securing the payload open and solid propellant Retro rockets on the Thor back it away from the payload. (S)

f. Depending upon the details for each test and their instrumentation considerations, the externally attached instrumentation pods would be released during powered flight or at engine cut-off. (S)

g. Utilizing the operational guidance system the volume containing 50% of the normally distributed engine cut-off points is described by an ellipsoid of revolution. [

Deleted
The minor axis of the ellipsoid are 0.25 N. mile long. The accuracy improves proportionately for the lower altitudes and reduced flight times. (S)

4. Ground Environment.

a. It is proposed to use one minimized operational emplacement as the launch area in support of this program. Figure 3, Appendix A, presents the equipment layout which is composed of:

- (1) Missile Shelter
- (2) Nitrogen Storage Trailers
- (3) Liquid Oxygen Storage Tank
- (4) Electrical Substation
- (5) Launcher Power Pack
- (6) Electrical Equipment Trailer
- (7) Air Conditioning Trailer
- (8) Short Range Theodolites
- (9) High Pressure Gaseous Nitrogen Trailer
- (10) Hydro-pneumatic Trailer
- (11) Launching Mount
- (12) RP-1 Storage Tank

b. Supporting the launch emplacement and located remotely, would be a launch control area consisting of:

- (1) Launch Control Trailer
- (2) Power Distribution Trailer
- (3) Electrical Generators
- (4) Diesel Fuel Storage Tank

c. The ground support equipment required to accommodate, check out and launch the missile is standard WS-315A squadron equipment. The only configuration adaptation would be the minor one of adapting to a single launch emplacement supported by one launch control area, instead of the normal three launch emplacements. This equipment will be emplaced on a minimal facility. No change in the standard configuration of the AGE will be required to support the launch, other than the installation of a simple lift-off switch which will be used to signal other supporting events. With regard to missile checkout and other support equipment, these items are also readily available. The missile will be given a final checkout at the launching area, utilizing standard AGE. Initial missile checkout and modification will be performed at the Douglas, Santa Monica Plant. In order to achieve a prompt refire capability certain launch pad hardening provisions will be incorporated to reduce the refurbishment effort necessary after launch. This hardening will be the same as that now employed at VAFB on similar emplacements. The down time between launchings will be about two weeks. The materials required for refurbishment will be stored at the launch site prior to launch to minimize the turn around time if necessary.

d. To provide liquid oxygen and liquid nitrogen a transportable, 5 or 10 ton capacity, generating plant will be emplaced. This will be used to manufacture the checkout and operating fluids including gaseous nitrogen. To store the fluids use can be made of the AGE liquid oxygen storage tanks of which two are to be provided (each has a capacity of 13,250 gallons). Similarly, RP-1 may also be stored in the GSE storage tank which has a capacity of 6,000 gallons.

5. Flight Safety System.

a. An inflight missile destruct system would be provided. A conventional system used on all Thor test operations is proposed. This system consists of dual receivers, relays, safety and arming mechanisms, filter networks, and the destruct harness. The detonating system consists of strands of detonating cord located in both tunnels running the length of the fuel and lox tanks, and around the aft lox bulkhead. Actual incorporation of the destruct equipment and range safety receivers is by means of a kit which is installed at the launch site.

b. A telemetry package including telemetry and range safety batteries will be installed in the missile center section. The transmitter package contains seven subcarrier oscillators, five of which normally monitor one function each. The remaining two are multiplexed.

c. Test instrumentation and telemetry receiving and recording equipment will be required to the degree dictated by the final detailed safety criteria for systems, and integration of associated agency instrumentation to be carried on the Thor. It is proposed to use the standard airborne unit mentioned and a ground telemetry trailer facility such as has been used on previous tests. For range safety positioning purposes two systems could be used. A C-band beacon can be installed in the missile and tracked

by an FPS-16 or equivalent radar set feeding azimuth, elevation, and range information to an IIP computer which supplies a visual display to the range safety officer. The other system is the Azusa system which requires installation of a coherent CW transponder in the missile, one ground transmitting station, and two ground receiving stations separated by several 1000 feet, feeding information to the IIP computer. (S)

6. Support.

a. There is available for immediate use and integration of special test features all technical data required in the form of technical manuals, drawings, specifications, and test results of previous flights. (S)

b. It is estimated that the contractor can install and checkout the proposed system in less than six months. Contractor services and support in planning and achieving the launch capability, the installation and checkout of required equipment, launching of the missile, reduction of data, and preparation of necessary documentation is planned. Douglas Aircraft Company has assisted in the planning and provided the personnel and equipment to install and checkout four squadrons of similar equipment in the U.K., and is presently under contract to launch Thor boosters at both AMR and PMR. (S)

WARHEAD CARRIER COSTS

THOR BOOSTER

Including Guidance, Command Destruct, Beacon (4 systems) \$ 2,400,000

AEC INTEGRATION SERVICES

Including Command to Warhead, TLM, etc. (3 systems) 1,800,000

CONTRACTOR SERVICES

Pod Studies and Fabrication (2 launches) 1,000,000

Vehicle Assembly, Checkout, Launch (3 launches) 2,250,000

Launch Documentation (3 launches) 150,000

Trajectory Analysis (3 launches) 75,000

\$ 7,675,000

GROUND SUPPORT TO THOR (For all Shots)

GSE 4,500,000

PAD 65,000

Sequencer Console Installed 250,000

Vehicle Track and Position

FPS 16 with Building 1,900,000

OR - AZUSA (\$5,000,000)

Checkout Buildings (4 Butler) 240,000

\$ 6,955,000

TOTALS: 3 Launches

\$ 7,675,000

\$ 14,630,000

TABLE 1

~~SECRET~~

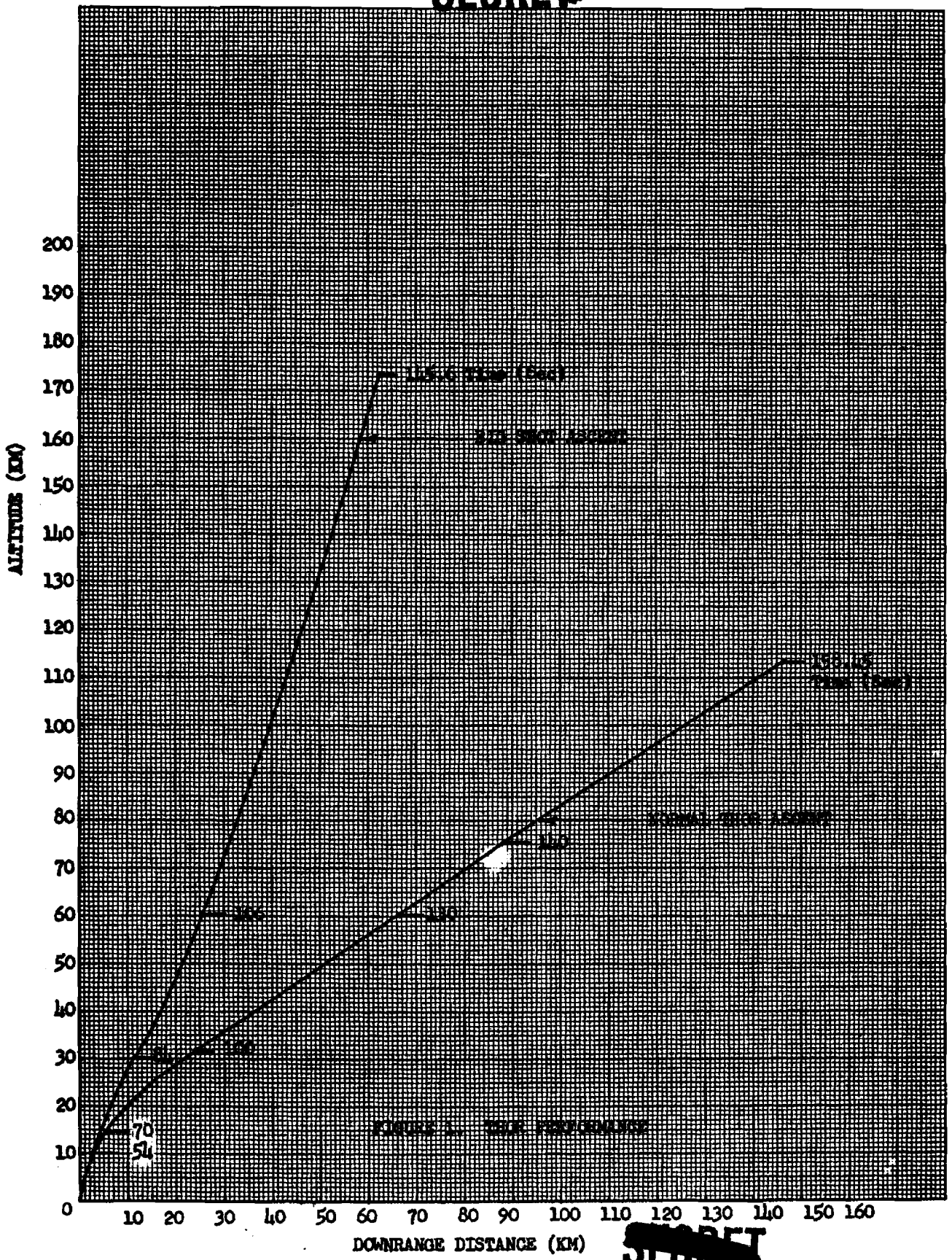

FIGURE 1. TYPICAL PERFORMANCE

~~SECRET~~

~~SECRET~~

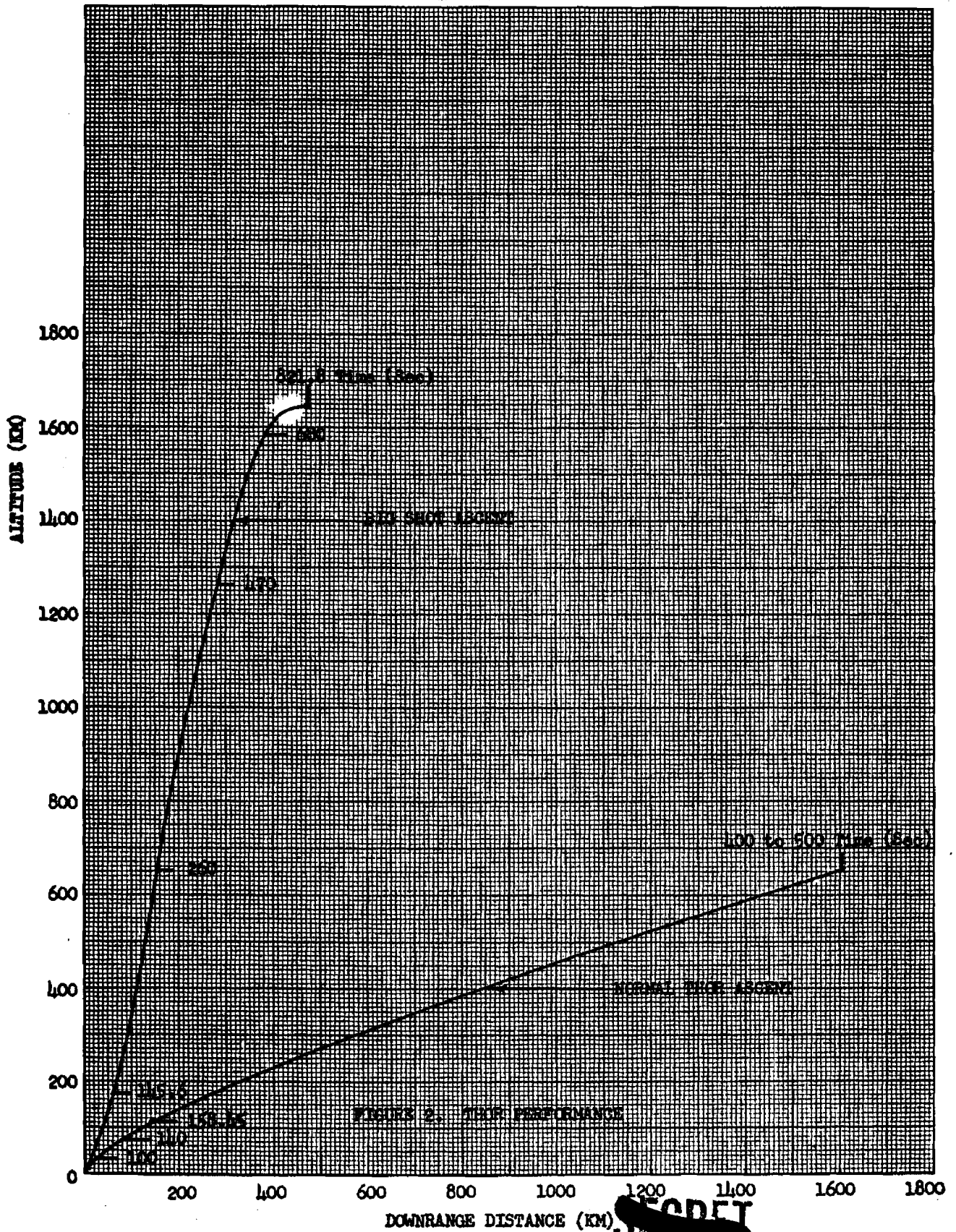

FIGURE 2. TRIP PERFORMANCE

~~SECRET~~

MISSILE PROFILE

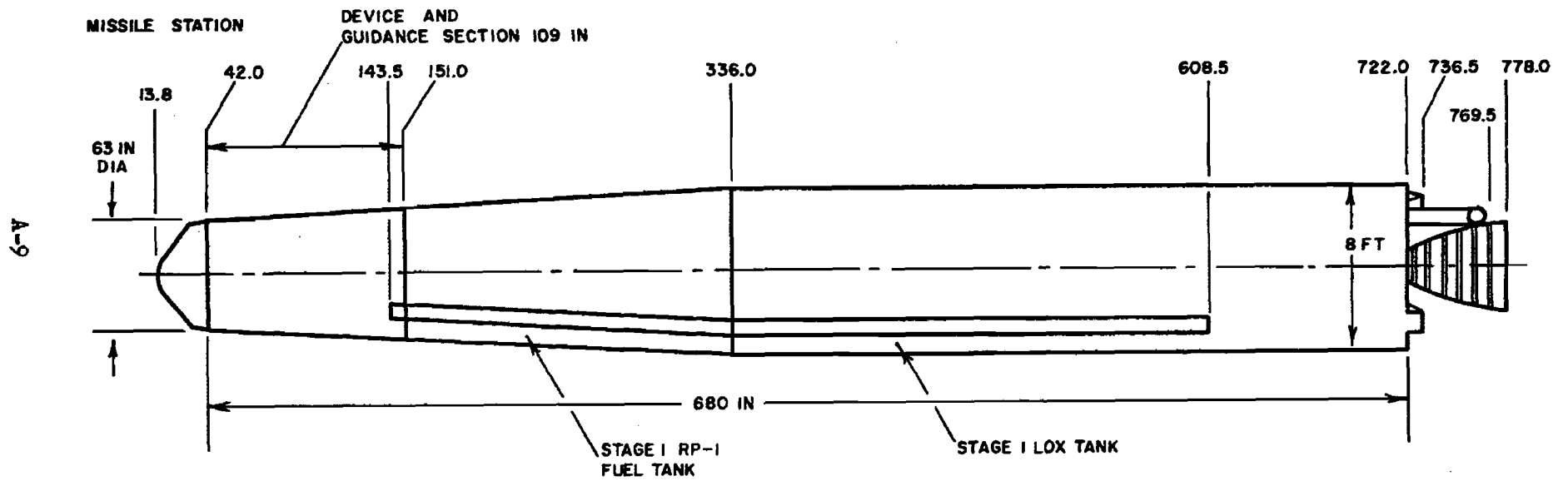

FIGURE 3.

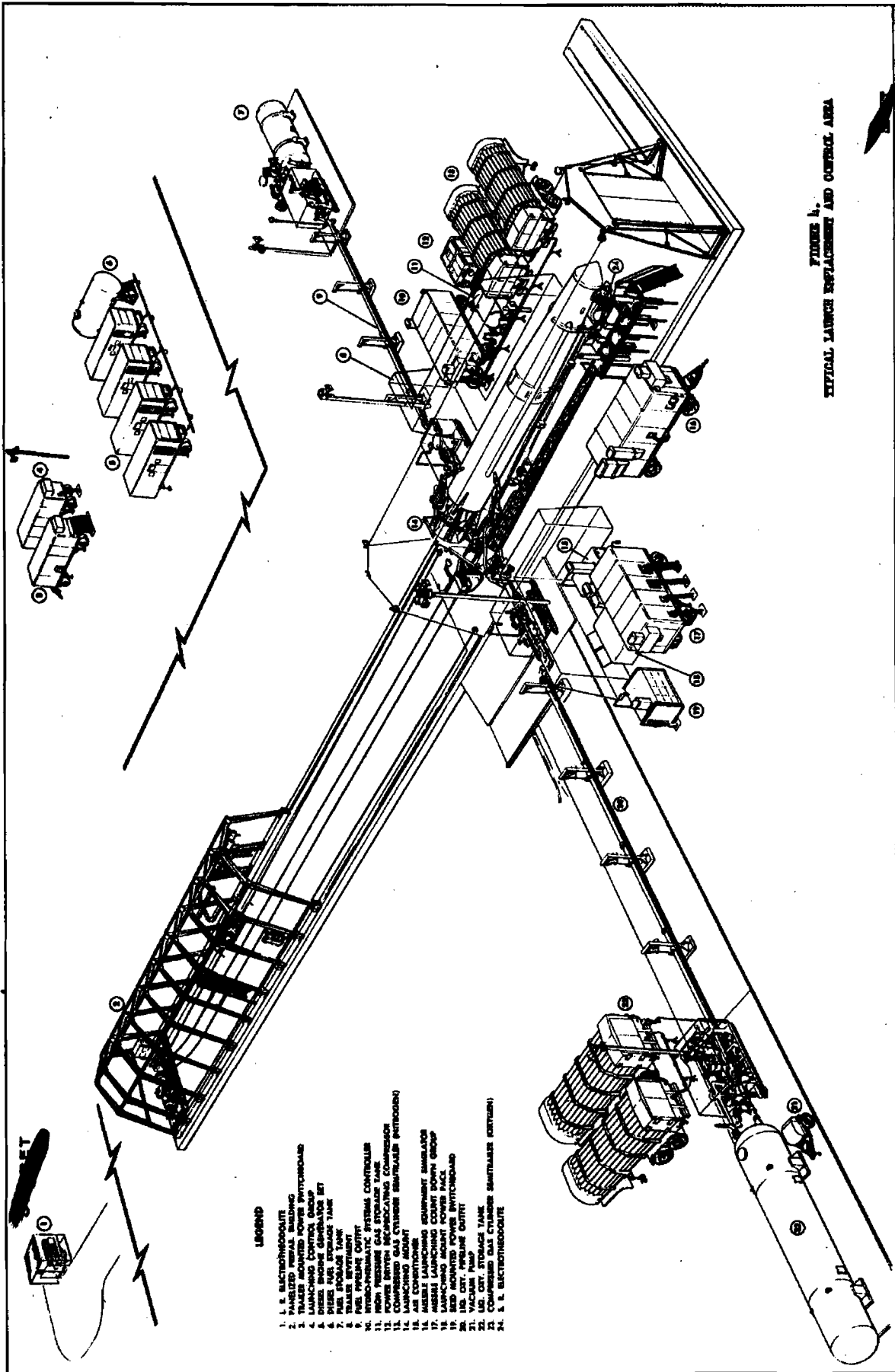

FIGURE 4.
TYPICAL LAUNCHER REPLACEMENT AND CONTROL AREA

LEGEND

1. I. S. ELECTROSCOPE
2. PANELLED REAR BUILDING
3. TRAILER MOUNTED POWER SWITCHBOARD
4. LAUNCHING CONTROL GROUP
5. LAUNCHING CONTROL GROUP
6. MISSILE GAS STORAGE TANK
7. FUEL STORAGE TANK
8. TRAILER EQUIPMENT
9. FUEL PUMP
10. FUEL SYSTEMS CONTROLLER
11. HIGH PRESSURE GAS STORAGE TANK
12. POWER SWITCH RECALIBRATING COMPRESSOR
13. COMPRESSED GAS CYLINDER (MULTIPLE INTERCHANGIBLE)
14. AIR COMPRESSOR
15. MISSILE LAUNCHING EQUIPMENT SIMULATOR
16. MISSILE LAUNCHING COUNT DOWN GROUP
17. MISSILE LAUNCHING COUNT DOWN GROUP
18. MISSILE LAUNCHING COUNT DOWN GROUP
19. MISSILE LAUNCHING COUNT DOWN GROUP
20. MISSILE LAUNCHING COUNT DOWN GROUP
21. VACUUM PUMP
22. MISSILE STORAGE TANK
23. MISSILE STORAGE TANK
24. I. S. ELECTROSCOPE

APPENDIX B
TELEMETRY AND TRACKING

1. General

Considering the short lead time envisioned for this program, one cannot easily do any significant design or development on either telemetry or tracking systems. Therefore, one must select off-the-shelf items which include in the telemetry area FM/FM or the present Digital systems such as Digilock or Telebit and in the tracking area systems which have been designed, developed and proven under operational conditions. Frequencies available in off-the-shelf telemetry equipment would normally be in the 225 to 260 megacycle telemetry band. Equipment for 108 to 175 megacycle band is also available and is particularly useful for PCM or Digital systems. Tracking instrumentation exists in virtually all frequency bands from the old Dovap of 35 to 70 megacycles all the way up to the modern day instrumentation such as Azusa whose frequency is 5 kmc. (UNCL)

A longer lead time, say about 12-18 months, would eliminate the problem of having to utilize off-the-shelf equipment. It is felt, however, that sufficient equipment is available to accomplish the objectives of this plan. Therefore, the time limiting element is the ability to obtain off-the-shelf equipment, which in itself is a sufficient problem. Due to the many unknowns in the data requirements, specific types of telemetry can not be indicated at this time. With the longer lead time, one could develop faster readout techniques and better delay time storage for telemetry data and adapt higher frequency tracking equipment to this application. The higher frequencies in general are less susceptible to the RF blackout attenuation discussed below which is one of the most serious problems for any telemetry or tracking system.

~~(SECRET)~~

2. Problems

a. RF Blackout

(1) RF blackout mentioned above, is probably the most serious telemetry and instrumentation problem in the vicinity of a burst from T-0 to T+100 seconds. The blackout is so great that it is virtually impossible to receive any transmission whatsoever. From 100 to 600 seconds the blackout effects decrease and the attenuation at the telemetry frequencies of 250 Mc amounts to perhaps as much as 30db. For times greater than 600 sec no appreciable blackout effects are anticipated. (SECRET)

(2) From T-0 to T+100 sec real time telemetry readout is unreliable at any propagation range. One must therefore use a data storage system for some type of later readout. This could either be a continuous magnetic tape or digital storage method of some type. From 100 to 600 seconds preliminary calculations show that as much as 4 kilowatts would be necessary for FM/FM transmission over 2200 Km range with 125kc transmitter frequency deviation. Digital systems such as Digilock presently available would operate effectively with 5 watts input power. However, the readout capability of the present system is limited to 67 data bits per second. With a longer lead time, Digilock could further be developed to attain a digital readout of 500 data bits per second. However, this would increase the input power considerably. For

times greater than 600 seconds no serious transmission problems occur. 15 watts of FM/FM telemetry in this time region would be sufficient even at the furthest anticipated ranges. (UNCL)

(3) Tracking systems will also experience RF blackout from T-0 to approximately T+100 seconds depending upon the frequency band used. After 100 seconds data will be attainable and the actual time of acquisition would be dependent both on the frequency used and sensitivity of the receiving equipment. For purposes of this planning effort, it is assumed that data will be received at or shortly after T+100 seconds. (~~SECRET~~)

b. Thermal Effects

The maximum thermal irradiation anticipated will be approximately 10 calories per square centimeter. This will pose no problems in using off-the-shelf items if light thermal shielding is provided. (UNCL)

c. Neutron Irradiation

[Deleted] This poses very serious problems in utilizing transistorized components.]

[Deleted] At points where the instrumentation will definitely see such a high flux care must be taken to properly shield components and to choose components with high neutron tolerances (i.e., the substitution of hard tubes for transistors, etc.) (~~SECRET~~)

3. Vehicle Tracking

a. The problems of selecting a tracking system are similar to those of telemetry. The most serious problems are simultaneous tracking of many vehicles, the high neutron fluxes and the RF blackout effects discussed above. The problem of simultaneously tracking many vehicles can easily be solved; however, high neutron fluxes and RF blackout effects will have to be tolerated. (~~SECRET~~)

b. In selecting a tracking system or systems, one must make a close analysis of the tracking requirements for each vehicle within each mission. The tracking requirements conveniently divide into two groups, one a requirement for altitude only and the other a requirement for coordinate position as a function of time. A close analysis of these two requirements, however, indicates that a similar type tracking system will have to be used for each. To determine altitude one must have a capability of determining a coordinate position relative to the instrumentation site as a function of time. From this information one can compute the position of the vehicle at any time during its trajectory. A few data points after burnout are sufficient to determine the ballistic trajectory and no further tracking is needed. The accuracy requirements are shown in the following table, for each experiment.

<u>Vehicle</u>	<u>Experiment</u>	<u>Tracking Accuracy</u>
THOR	W/H	best possible
NIKE CAJON	Fireball	± 1 km in coordinate position
NIKE CAJON	MF/HF absorption	± 1-5 km in altitude only
NIKE CAJON	HF/VHF attenuation	± 1-5 km in altitude only
TOP SIDE SOUNDER	Electron Density	± 1-5 km in altitude only
NIKE CAJON	Chemistry	± 1-5 km in altitude only
XM-33	Gamma Scanner	± 5 km in altitude only
XM-33	Debris Magnetometer	± 1 km in coordinate position

From the above table one may conclude that with the exception of the THOR Warhead Carrier, the accuracy requirements are not particularly stringent. Therefore, for purposes of selecting an appropriate instrumentation system, the THOR Warhead Carrier is discussed separately. (SECRET)

c. To obtain high accuracy tracking of a THOR Vehicle some type of pulse radar with a single object tracking capability would seem desirable. Many radars were considered and include in order of decreasing accuracies the FPS-16, MPS-26, Trailarized Mod III C-Band Radar, Mod II S-Band Radar (improved SCR 584), the SCR 584 and the Nike-Ajax tracking radar. In view of the desire for high accuracy for the THOR Warhead Carrier the FPS-16 or MPS-26 (trailarized FPS-16) is the logical choice. However, these radars are hard to obtain and procurement of a new unit is out of the question because of the short time scale of this project. Efforts are continuing to locate an FPS-16 or MPS-26 which could be borrowed for the duration of this program. However, at the same time the availability of these other lower accuracy radars is being established in the event it is impossible to obtain a 16 or 26. The SCR 584 and Nike-Ajax trackers are available out of jacket file. Both will require some modifications for this program and neither are as accurate as desired. The Mod III and Mod II Radars are being investigated. The availability of these two units is not presently known. (SECRET)

d. A number of systems have been considered which satisfy the coordinate positioning requirements of all the other experiments. Among the systems considered were pulse radar, Cotar, Agave and various other variations of this equipment. The pulse radar approach was discarded after a cursory examination because of the quantity, cost and complexity of implementing multiple radars for simultaneous track of as many as 11 vehicles. A Cotar system modified for multiple tracking could easily meet the requirements with reasonable cost and complexity. The Agave equipment which consists of a quad helix mounted on a single pedestal is by far the simplest approach to the problem. A detailed

investigation of the Agave indicated that its accuracy in azimuth and elevation is only $\pm .5^\circ$, and while this would meet the requirements for the 50Km experiment, it would not be useful for long range experiments. Therefore, we must consider a Cotar type system as being best adapted to the tracking requirement. (U)

e. "Cotar" stands for "Corolation Tracking and Ranging" and is a base line interferometer system utilizing low gain wide beam antennas (also known as Moptar). The Cotar system measures 2 direction cosines but does not measure range; therefore, Cotar in itself will not satisfy the positioning requirements since one needs in addition two cosines, either a range or an additional cosine from a different source. Since for many of the experiments altitude only is desired, a range only DME system with multiple object tracking capability is recommended to supplement the Cotar equipment and furnish the range information. With this range and the 2 direction cosines one can determine the position as a function of time, and by simple differentiation, velocity is a function of time. As mentioned earlier approximately 10 seconds of data after burnout would be sufficient to compute the complete ballistic trajectory from which one could obtain position or altitude anytime. (UNCL)

f. From experiments conducted on Atlantic Missile Range about 2 years ago, some accuracy information has been compiled on the Cotar system. An accuracy of about 500 parts per million should be obtained with minimum amount of cost and time. Random errors will run approximately 100 parts per million or less while bias errors could run as much as 500 parts per million depending on basic calibration problems including survey accuracies, calibration sources and ground plane inhomogeny. The accuracy of this system then in measuring angles is well within the required accuracy of approximately 1000 parts per million for these experiments. (UNCL)

g. Secor type ranging equipment was chosen to furnish the range component of trajectory since equipment has been developed and tested for tracking multiple objects. "Secor" stands for Sequential Corolation of Range. Its inherent accuracy is approximately ± 10 meters. The ideal configuration would be to use the Secor equipment as a sequential ranging instrument. In this configuration only one transmitter and one receiver would be needed at Johnston to track 11 vehicles. Cubic Corporation however indicates that this system could not be fabricated in 4 months. It would take approximately 9 months to fabricate a Cotar-Secor system using sequential tracking. The alternative which can be delivered on time is a simultaneous ranging system. This system consists of one transmitter and 11 receivers to track 11 vehicles. Likewise, the Cotar system will utilize 22 receivers instead of two. (S)

h. For the Samoa launches, additional instrumentation will be required since there is no line of sight capability from Johnston Island. A single Secor transmitter and dual receivers plus two Agave systems will meet the accuracy requirements. The Agave is satisfactory for this application since tracking ranges are well within the range where Agave can furnish ± 1 km in position accuracy. (S)

i. (Deleted)
A single Secor transmitter and receiver will be needed on the ship which launches the 400 km attenuation payload. (S)

j. To summarize, the following instrumentation is recommended:

- (1) An FPS-16 or MPS-26 at Johnston to track the THOR vehicle.
- (2) A Cotar-Secor complex at Johnston having the capability of tracking 11 targets.
- (3) One Secor transmitter and two Secor receivers plus two Agave systems to track the vehicles launched from Samoa.
- (4) One Secor Transmitter-receiver on the ship which launches the 400km attenuation payload. (~~SECRET~~)

4. Summary

Preliminary calculations have shown that experiments which are close to or above the burst would be difficult or impossible to instrument, at early times, with conventional FM/FM systems. A digital system requiring low power would allow transmission a relatively short time after burst with reasonable transmitter power. For data-gathering times up to 100 seconds after burst, off-the-shelf tape recorders could be utilized to store the information for a later readout. It also seems practical to time share the various experiments which pertain only to specific non-overlapping time intervals. For this test series conventional FM/FM systems will be used. (UNCL)

The tracking systems summarized in paragraph 3j above will satisfy all the vehicle position requirements of this project. (UNCL)

APPENDIX C

NUCLEAR SAFETY FOR FISHBOWL

A. LAUNCH SAFETY

1. Introduction

a. The primary purpose of this nuclear safety assessment is to determine whether the system, as conceived, will provide adequate safeguards to preclude a full-scale nuclear detonation at any point other than within a predetermined safe area. It is assumed that the Arming and Fuzing (A & F) System proposed by the Sandia Corporation will be used in the tests. Some of the components of the A & F System are development items which have not been completely qualified; consequently, the validity of this nuclear safety analysis is contingent on the achievement of the reliability presently forecast for these components. In addition, detailed procedures for transportation, storage, assembly, and checkout of the warhead have not been determined; therefore, it has been assumed that such procedures will not violate established safe practices. At such time as these procedures are definite, they will be evaluated for nuclear safety. (U)

b. There are three possible sources of warhead detonation after it has been fully assembled. These are: (1) fire; (2) shock; and (3) operation of the electrical firing system. This analysis is chiefly concerned with the third source. The warhead will be certified one-point safe by the AEC. Since exposure to fire or shock will result in, at most, a one-point detonation, the nuclear energy released will be negligible. The only significant energy is contributed by the high explosive. Either one-point detonation or burning of the warhead will result in some plutonium scattering, but would be unlikely to cause any hazard. Some decontamination might be required; but, in general, plutonium contamination is a problem rather than a hazard. (S)

2. Safety Analysis

a. The warhead and Arming and Fuzing System will be designed and fabricated by the AEC. The test device will include the following safety characteristics: (U)

(1) The warhead will give no significant nuclear yield in the event of detonation of the H. E. by any means other than the intended firing system (one-point safe). (S)

(2) Safety devices in the Arming and Fuzing System will be fail-safe rather than fail-arm. (U)

(3) At least one independent safety device in the Arming and Fusing System will be designed so that in the event of fire it will prevent warhead arming. (U)

(4) At least one independent safety device will be designed to actuate only after sensing a unique environment associated with the launch of the missile. (U)

(5) A timer destruct capability will be provided. The timer will be started at launch and will initiate warhead destruction at a pre-determined time. The selected time will be sufficient to allow the payload to reach the test area and to allow the normal command firing to take place. (U)

3. Handling Prior to Arrival at Test Site

a. The AEC will assemble the payload prior to its arrival at the test site. This will include mating of the warhead and Mark II Re-entry Vehicle. Although the plans and procedures for this phase of the operation have not been made, they will adhere to AEC procedures and regulations pertaining to safety and security during the handling, storage, and transportation of nuclear weapons. This will assure adequate protection against fire, shock, or sabotage. (U)

b. To prevent accidental detonation through the warhead electrical system, the primary source of electrical power is isolated from the warhead firing set until as late as possible in the arming and fusing sequence. The following elements in the Arming and Fusing System would have to be activated before a nuclear detonation could occur. (U)

(1) The Arming and Fusing Battery: This battery is the only source of electrical power capable of arming the warhead. It is not activated until just prior to launch. (U)

(2) The Integrating Accelerometer in the Warhead: This device will interrupt the arming lines of the warhead until after a specified sustained acceleration is experienced. This provides safety during ground handling. (U)

(3) The Arm-Safe Switch: This device will electrically isolate the only electrical power source in the system until just prior to launch, at which time it will be activated from the Control Officer's Console to provide electrical continuity. This device should be capable of being manually safed but not manually armed. (U)

(4) The Altimeter Switch: This switch will interrupt the electrical circuits from the arming and fusing battery until a pre-determined altitude is reached. (U)

(5) Safe Separation Timer: This timer, which is initiated at launch, will interrupt the electrical circuits from the arming and fuzing battery until a predetermined time after launch. (U)

(6) The Coded Command Arming and Firing System: This system isolates the arming and fuzing battery from the warhead and prevents initiation of the arming and firing sequence until after a coded command signal is received from the ground. In addition, a coded fire signal is sent to detonate the weapon. (U)

Nuclear safety during storage is dependent on the above components. Testing to determine reliability, premature probability, etc., will have to be performed to insure that the design requirements have been accomplished. No difficulty is anticipated in qualifying these components, and it is believed that they will provide an adequate degree of nuclear safety during ground operations.

4. Prelaunch Operations

a. Storage at the Test Site: It is assumed that warhead/Re-entry Vehicle assemblies will not be transported to the test site until just prior to the tests. However, they may be at the site for a few days prior to mating with the missile. Physical security to protect against sabotage, fire, and shock must be provided at the storage site. The several devices in the Arming and Fuzing System listed in 3 above will provide adequate safety during this on-site storage period. (U)

b. Warhead Checkout: Prior to mating of the Re-entry Vehicle to the missile, some continuity testing of the warhead will be required to assure reliability as well as to verify the safe condition of the warhead and the Arming and Fuzing System. Such checkouts will be accomplished by AEC contractor personnel. The test equipment and procedures must not in themselves degrade any of the safety features of the system. In general, the same safety considerations apply to the checkout operations as are listed above for warhead storage. (U)

c. Warhead Missile Mating: After separate checkouts of the missile and warhead, the payload will be mated to the missile on the THOR launcher before the launcher is raised to firing position. Mating will be essentially a mechanical operation. The equipment and procedures for loading or hoisting the payload must be designed to minimize the risk of inflicting physical damage to the warhead. Experience with existing warheads indicates that the impact velocities that would result from dropping the payload probably would not cause detonation of the high explosive. It is probable that normal THOR handling equipment will be used for this operation, and that safety rules for the operational THOR would apply. (U)

d. **Ground Monitoring:** Preliminary information from the AEC indicates that there will be monitoring of the warhead components through a separate umbilical connection. This should provide adequate assurance that the safe condition of the critical components will remain unchanged. (U)

e. **Launch Control:** The two-man concept of launch control will be followed in this operation. This should impose no operational difficulties, since THOR launch equipment is designed to comply with this requirement. While the Test Director will have complete authority to launch, the requirement for two individuals to perform separate key actions before a launch can occur will reduce the possibility of an accidental or unauthorized launch. (U)

f. **Countdown:** During countdown, the safety problem is comparable in many respects with that of an operational ballistic missile system. Significant safety aspects of the countdown are as follows: (U)

(1) Several independent series functions within the warhead Arming and Fuzing System will prevent a nuclear detonation. These include the warhead power supply, which is not activated until just prior to launch; an altitude sensing device, which interrupts the power supply output circuit; an accelerometer, which interrupts the warhead arming circuits; a safe separation timer; and the absence of a coded command arming signal. These elements are capable of providing an adequate level of safety during the countdown. ←

(2) The actual launching function will be closely controlled to prevent inadvertent or unauthorized launch. Any unsafe indication of critical warhead components will be cause for holding or aborting the countdown. In addition to launch area safeguards and procedures normally employed during a conventional missile countdown, USAF radio-logical monitoring and decontamination equipment and personnel will be available at the test site. (U)

5. Launch

In order for an authorized launch to occur, all safety conditions supervised by the Control Officer must be satisfied. As a minimum, these will include verification of the guidance and tracking system readiness; clearance of the launch area and of the range itself; readiness of the destruct system; and the condition of the warhead. Pending a detailed analysis of the launch operation, it may prove advisable to provide an actual interlock in the launch sequence to be controlled by the Control Officer. (U)

6. Launch to Detonation

The most critical phase of the test will occur during the launch period, since most failures of ballistic missiles have occurred at this

time. Three types of missile failures can happen during this phase: (1) explosion and subsequent fire on the launch pad; (2) thrust failure and missile fall; (3) guidance failure which could cause the missile to oscillate, tumble, or veer off course. In any case, when unexpected departure from the normal launch trajectory occurs, destruction must be initiated by the Control Officer. Should the command destruct fail, the system provides a timer destruct which would operate shortly after the missile passed the intended point of test. (U)

a. Nuclear Safety: In the final seconds of the countdown, the arming and fusing battery and the arm-safe switch are activated. However, the following four items would have to fail before a nuclear detonation could take place: (1) integrating accelerometer; (2) altimeter switch; (3) safe separation timer; and (4) coded command arming and firing system. The nuclear safety provided at this point and all other points on the trajectory is a direct function of premature probability and/or reliability of these devices. It is believed that these devices, or comparable mechanisms, can be made sufficiently reliable to meet any reasonable criteria and thus assure nuclear safety. Continuous monitoring of the safe conditions of these devices provide an added degree of safety, since the Control Officer could destruct the system when an unsafe condition is indicated. This statement is true throughout the missile flight. (U)

Shortly after lift-off, prior to attaining the altitude at which the Altimeter Switch is activated, the Integrating Accelerometer will have been activated and can no longer be considered as a safeguard. The warhead monitoring and command destruct systems compensate for the loss of this element, since failure of any other arming and fusing component will be cause for destruction, before a dangerous condition is reached. (U)

[Deleted]
The Safe Separation Timer may also have to be set for operation at the same time as the Altimeter Switch in this case. The probability of a premature detonation is greater at this point than at any other time. Command "ARM" and "FIRE" signals must still be received before a full-scale nuclear detonation is achieved. When the exact point on the trajectory at which the Safe Separation Timer must be activated is determined, the effects of a full-scale detonation on the launch site will have to be calculated. In the event that the probability of premature detonation at this point is found to be unacceptable, and that the distance does not provide sufficient safe separation, it is probable that the trajectory can be reshaped so that one or both of these elements will not be activated until safe separation has been achieved. (U)

L

Deleted



b. Range Safety at the Launch Site.

When safety against a premature nuclear detonation has been assured, the addition of a nuclear warhead to the missile creates no real hazards that are not considered in present range safety programs. Failure or destruct of the missile will, at most, cause one-point detonation of the warhead, resulting in the scatter of some nuclear material. The plutonium scatter problem is of negligible significance. Routine missile launch precautions, supplemented by radiation safety precautions, will suffice in the event of fire, explosion of the missile propellant, and falling debris after destruction at an altitude. Some decontamination will be necessary if the failure occurs on or in the near vicinity of the launch pad. (U)

c. Down-Range Safety.

The possibility exists that the weapon will not detonate after the system is armed and the fire signal has been given. Command and timer destruct systems are provided to destroy the weapon in this event. If these devices also fail to operate, then the possibility exists that a nuclear detonation could occur at some point down range between the test location and the projected impact point of the R/V. These areas should be determined for each shot and be cleared. Determination during the launch that the trajectory will result in a splash point outside these safe areas should be cause for immediate destruct of the warhead. The limits of these areas will have to be determined for each shot and can be made as broad as necessary to optimize the importance of down range safety and the importance of the test. (U)

{

Deleted

This requirement should not prove

to be a limitation on gathering test data. (S-~~RU~~)

Deleted }

7. Conclusions

a. This test program is capable of achieving the same, or a better, degree of nuclear safety as is presently provided for peacetime operations with nuclear weapons. (U)

b. The range and launch safety hazards of this operation, excluding the small but ever present possibility of a full-scale detonation, are no more rigorous than those associated with other missile launches. The major additional requirement will be a decontamination team to take care of plutonium scatter in case of launch failure. (U)

B. EYEBURN

1. Considerations:

- a. Σ Deleted \int
- b. 1.45 MT at 400 km altitude, with burst point 360 N.M. South, 180 N.M. West of Johnston Island. \int
- c. Σ Deleted \int

The other shots are at low enough altitude that straight line distance to horizon is sufficiently short that inhabited areas will not view them directly. The exact burst points may be changed somewhat without severe effects on the eyeburn problem. (U)

2. Phenomena

In the case of a detonation at altitudes of 300 km and greater, visible radiation from air particles excited by the interaction of the explosion with the atmosphere becomes a minor part of the problem, with direct radiation from the bomb debris being paramount. \int

The explosion is described in three phases:

- a. Phase 1, of approximately 1.5 microseconds duration, during which the bomb temperature drops to approximately 180 ev, with emission of approximately 10^{-6} of the total bomb energy as visible radiation, and with the characteristic dimension of the debris going to approximately 3.5 m. \int
- b. Phase 2, of approximately 30 microseconds duration, during which the debris radiates as a black body, emitting approximately 3×10^{-6} of total bomb energy in the visible, going to a radius of approximately 70 m. \int
- c. Phase 3, of duration approximately 100 microseconds, with the bomb debris no longer in equilibrium, and with bremsstrahlung the dominating mechanism. \int

For ease and for safe-side estimation, we will consider that all remaining internal energy in the debris (in Phase 3) is emitted in the visible. \int

[Deleted \int
5 \int

3. Calculations

The following are results of rough calculations which assume a transmission coefficient within the eye of 0.5, the eye to be a perfect lens with $f = 1.7$ cm, pupil radius = 0.4 cm (night adapted), and atmospheric transmission = 1.

$$\text{Using } Q = \frac{\eta (i) Y 2.19 \times 10^{-3}}{R_i^2}, \quad \text{where}$$

$\eta (i)$ = fraction of total bomb energy emitted in visible in i^{th} phase,
 Y = yield in calories (1 MT = 10^{15} cal.), R_i = radius of bomb debris (cm), Q is the energy density (cal/cm²) of image on retina.

This quantity is independent of the distance from the source since the retinal image size decreases at the same rate that total energy decreases.

For

[Deleted]

For 1.45 MT

$$Q_1 = 0.34 \text{ cal/cm}^2$$

$$Q_2 = 0.20 \text{ cal/cm}^2$$

$$Q_3 = 0.040 \text{ cal/cm}^2$$

These figures represent the intensities as determined by simple geometric optics. The minimum size image on the retina is limited, however, by diffraction and chromatic aberration to a diameter of approximately seven microns. Any calculation, therefore, founded on a geometric image size less than 7 microns diameter, must be corrected by a factor of $d^2/(7)^2$ (where d is the geometric image diameter in microns), i.e., by a factor of the areal ratio. (U)

Further, the intensity of visible radiation on the retina begins to decrease with the square of the distance from source for those cases where the retinal image size is limited by diffraction and chromatic aberration. (U)

The assumption of complete transmission through the atmosphere must also be revised. The 400 km shot should be visible at about 10° from Hawaii, at which angle the transmission through the air should be about 33%. Σ

Deleted

~~(SECRET)~~

If we then correct these figures for the larger area over which the total energy is spread (for those cases appropriate), and for atmospheric transmission, we get:

a.]

Deleted

b. For 1.45 MT at a range of 1850 km.

$$Q_1 = 6.0 \times 10^{-6} \text{ cal/cm}^2$$

$$Q_2 = 1.6 \times 10^{-3} \text{ cal/cm}^2$$

$$Q_3 = 2.5 \times 10^{-3} \text{ cal/cm}^2$$

$$\text{Total} = 4.1 \times 10^{-3} \text{ cal/cm}^2$$

The maximum rates for these doses are on the order of 100 cal/cm² sec. ~~(SECRET)~~

4. Conclusions

a. These exposures appear to be within safe tolerances, particularly when one considers the liberal estimates of energy partition to visible light. (U)

b. There is some difficulty stemming from lack of knowledge of eye response to high rates at short times. There is also the possibility of the image falling directly upon the optic nerve; this would probably cause damage at energy levels not otherwise harmful. (U)

c. If, as in the case of the Orange shot, these are publicly announced, one should consider the possibility of sight-seers using binoculars to view the detonation, and take some steps to prevent this. (U)

d.]

Deleted

[Deleted] One should note that Palmyra Island (U.S.), Washington Island (U.K.), and Howland Island (U.S.) and French Frigate Shoals are slightly nearer to these proposed shots than Hawaii, with slightly greater hazard. (S-~~DD~~)

e. To summarize:

(1) [Deleted]

(2) 1.45 MT at 400 km altitude, 360 N.M.S., 180 N.M.W. of Johnston Island,

(3) [Deleted]

These intensities appear to be safe, judging from previous tests performed using rabbits as subjects, barring the chance placement of the image directly on the optic nerve, with unknown results. (S-~~DD~~)

C. GROUND SAFETY FROM WEAPON EFFECTS

1. Blast and thermal effects for a range of burst height and yields are given in figures 1 through 3. (U)

2. Thermal effects on personnel in the open should be negligible. A level of 2 to 3 calories has been shown on figure 1 as the region for first degree burns for the entire range of altitudes and yields considered.

[Deleted] All other yield-altitude combinations proposed will result in even lesser thermal effects on the ground. (U)

3.5 [Deleted]

Thus some consideration must be given to blast protection for sensitive equipment. Personnel in the open will not be directly affected at this level. (U)

4. Time of arrival is shown on figure 3. [Deleted] (U)

5. Initial nuclear radiation dosage should be well below 1 mr. (U)

6. Estimates of blast and thermal effects at points other than ground zero can be made by computing slant range and reading the figures as though the height of burst were slant range. (U)

7. Eye burns are treated in section B of this Appendix. (U)

C-11

*Pages C-22, C-13
and C-14 are deleted*

APPENDIX D

DESCRIPTION OF EXPERIMENTS

1. Fireball Blackout Experiment

The objective of this experiment is to determine the time after burst at which the fireball region becomes transparent to EM signals in the 1 to 10 KMC frequency range. Several transmission paths through the fireball region are planned to give maximum coverage to the rising and expanding region. Two Nike-Cajun rockets are employed. ~~deleted~~

It is presently planned to launch one rocket from Johnston Island and one from a ship as depicted in Figure 2. However, the plan is sufficiently flexible so that both rockets could be launched from Johnston if a ship-board launch is not feasible. (~~CONF~~)

Both rockets will carry three transmitters: one equipped with 1, 5, 10 KMC frequency instruments and the other with 2, 4, 8 KMC frequency instruments. Each frequency transmitted requires one receiver at each of the four receiver stations as pictured in Figure 2 (SECTION II). Thus, the total number of receivers required is twenty-four. Three ships will be required, each deployed as in Figure 2 (SECTION II). (UNCL)

2. Gamma Scanner Experiment

Fission fragments produced by a nuclear detonation decay by beta and gamma emission with a well known time dependence. At high altitudes (above 100 km) gamma rays have mean-free-paths ranging from tens to thousands of kilometers. It is possible to utilize these characteristics to determine the fission debris distribution. To do this the region containing the debris will be scanned from a distance with highly directional gamma-ray counters. Observed counting rates will be used to determine the location of the fission products. (~~CONF~~)

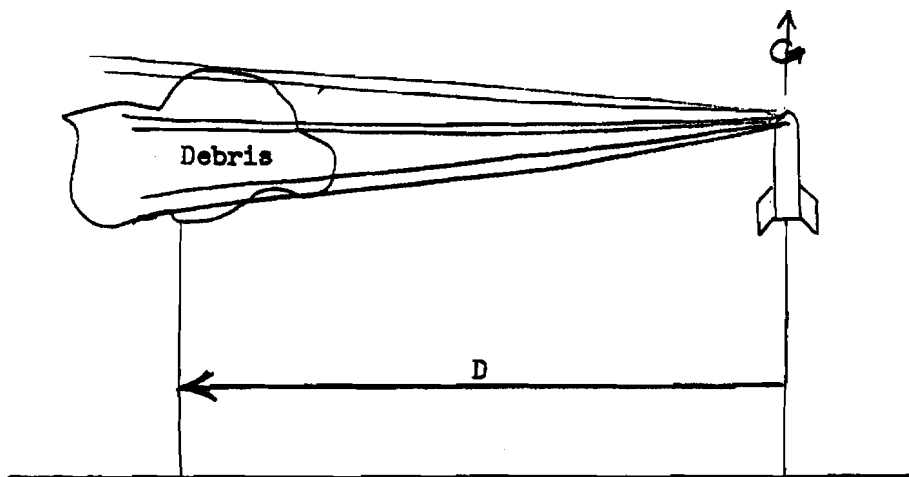

The Gamma scanner is positioned a distance D from the debris region which is a function of the altitude of the burst. The instrument is contained in the nose of a vertically launched rocket which reaches apogee at about

300 km. Data is gathered for a period of between 5 and 10 minutes. As the rocket spins about its longitudinal axis it allows several detection crystals to "look" at different angles to the horizontal plane to give spatial resolution to the determination of debris distribution. Data transmitted will give gamma intensities in a form which can be interpreted to determine the debris distribution. (UNCL)

3. MF-UHF Attenuation Experiment

It is expected that the Major D region blackout effects will occur in the MF-UHF frequency range. The purpose of this experiment is, therefore, to measure the attenuation of these frequencies. A single booster will place one or more payloads in and above the D region. Each payload will contain several transmitters with frequencies in the range from 30 to 1000 mc. Ground stations will observe signal strengths at each frequency as a function of time. In addition to basic attenuation measurements, an attempt will be made to phase lock two frequencies by which phase shift measurements will allow determination of electron densities as a function of altitude. (UNCL)

4. Physical Chemistry Experiments

The major unknowns which preclude direct calculations of ionization as a function of time after the burst are the rates of atomic and molecular reactions which determine electron depletion. Indeed, it is difficult to determine those reactions which are the most important. Measurements of MF-HF frequency attenuation will give electron densities as a function of altitude from which reaction rates can be inferred. A more direct method is to determine atmospheric constituents with rocket borne equipment. Techniques for making such determinations include: mass spectrometer measurements of neutral and ionic species; electron and ion densities; particle energy distributions; and atmospheric pressure, density, and temperature. (UNCL)

5. Debris-Magnetometer Experiment

A major requirement for understanding the phenomenology of the 400 km shot is investigation of the debris-ambient interaction. The theory that predicts a zero geomagnetic field inside the bubble assumes that the debris at the surface of the expanding surface of the bubble is infinitely conducting. A measure of the conductivity of the debris is obtained from observing the field changes since the field lines may diffuse back into the bubble. Initially this magnetic field will be very small and can only be measured with a very sensitive magnetometer. (~~CONF~~)

To make these measurements, a magnetometer is required aloft near the burst point measuring quite accurately the magnitude of the field with a time constant of about 10^{-4} seconds. As the debris expands past the instruments, measurements will be made of the magnetic field changes at the debris-ion loaded field interface. An attempt will be made to include some debris analysis instruments - ion catchers, Faraday cups, etc., in the magnetometer payload. (UNCL)

6. MF-HF Absorption Experiment

This experiment will measure the D-region absorption of MF-HF frequencies by monitoring a signal transmitted from a ground station with a rocket borne receiver. A carrier rocket will be launched through the D region prior to detonation to measure the ambient. After detonation another sounding rocket is fired to measure changes in the ionosphere. The strength of the ground transmitted signal is monitored by the rocket and signal strength is telemetered to the ground. (UNCL)

7. Top Side Sounding Experiment

The objective of this experiment is to determine the electron density profile above the D region after the detonation. It is difficult to measure electron densities above the D layer from below as the increased absorption by the D layer itself does not allow transmission and reflection from higher altitudes. Therefore, HF pulses will be transmitted from a rocket above the D region and the time of the echo returned from the upper D region recorded and telemetered to the ground. (UNCL)

8. Pods

a. Thermal Response Experiment:

This experiment will provide data on the effects and thermal response of structures to fireball thermal radiation. (UNCL)

Two pods carried approximately to burst point by the Thor will be employed for this experiment, one to be positioned within one km of the fireball, the other within 2 km. The pods will contain the following types of instrumentation: impulse and ablation gauges, calorimeters, temperature sensing devices, accelerometers, and a pinhole camera. The measurements to be performed are structural loading, rate and amount of material ablation, incident energy, characteristics of the thermal fireball, G-loading, and early time disassembly of the weapon. (UNCL)

b. Radiation Flux Experiment:

This pod should be positioned approximately 20 km down from the burst point. The experiment will measure the neutron flux and spectrum as a function of time and distance, gamma radiation intensity in various time intervals after the prompt gamma pulse and integrated gamma radiation levels as a function of distance from the burst, gamma energy spectrum as a function of time especially in the time interval from 1 microsecond to 1 millisecond. (UNCL)

c. X-Ray Experiment:

This experiment will be conducted only on shot Kingfish and is designed to measure low and high flux effects via passive instrumentation. The pods should be positioned at approximately 20 and 40 km horizontally from the burst point. (UNCL)

9. Ground, Ship, Airborne Experiments

a. Optical - IR Experiments

These measurements using spectroscopic and photographic techniques will provide badly needed data on the fundamental mechanisms for the production of optical and IR effects following a nuclear explosion. Two instrumented ground stations, one in the burst area and one in the conjugate point area, will be used. Two U-2 aircraft will be equipped with optical measurement equipment - one to observe the burst area and one to observe conjugate point area. One adequately equipped KC-135 (Number 3131) will also be flown in the conjugate area to obtain photographic spectrographic data. (UNCL)

Burst point early time phenomena and the late time sky glow effects will be observed from ground and aircraft stations. Measurements in the conjugate area will concentrate on auroral spectroscopic analysis. In the case of the higher altitude shots, gamma detector observations will also be made to ascertain the presence of bomb debris. (UNCL)

The equipment to be utilized includes scanning spectrometers, calorimeters, interferometer spectrometers, photomultipliers, dispersal units, all-sky cameras, and a broad band infrared sky mapper. Observations will be conducted down to low (auroral type) intensities. Brightness versus radius, atomic and molecular spectra, and fireball rise by optical methods are among the major measurements to be performed. (UNCL)

It should be recognized that adequate optical information does not exist for high altitude tests despite its importance for weapon effects calculations. This experiment in each shot in the test series will be accorded a high priority commensurate with its high importance. These experiments cannot be performed during the daytime and still provide meaningful data. The shots must be during the night, or at least pre-dawn when darkness exists at high altitudes and at the conjugate points. (UNCL)

b. Propagation Experiments

There are several experiments concerning long range radio frequency propagation which are not essential to the fulfillment of the stated objectives of the tests. However, they represent militarily important communications systems problems, without requiring large expenditures of funds and manpower. (UNCL)

The objectives of these experiments are as follows: (1) to determine the nature and the characteristics of VLF-ELF phenomena associated with high altitude nuclear bursts; (2) to determine the VLF phase pattern of a burst at short range; (3) to determine the extent to which VLF signals from a burst can be separated into discrete ground-wave and sky-wave components at ranges where the two components normally overlap (300 - 1500 miles); (4) to perform long range radio interferometer measurements at VLF; and (5) to measure the radio wave propagation effects of high altitude bursts. (UNCL)

c. Surface Based Absorption Experiments

A network of riometers will be employed in the burst area and at the conjugate points to measure the cosmic ray background absorption (which is related to the average electron density in the ionosphere) produced by the burst. A string of several riometers will be positioned Northward from the burst point to observe the rapidly moving "patch" of beta ionization. Other riometers will be positioned around the burst and conjugate areas to observe the more widely spread ionization densities. In addition, ionospheric sounders will be employed to determine the frequency at which radio waves are reflected from the ionosphere as a function of time after burst. These instruments will be used in both the burst and conjugate areas. (~~SECRET~~)

One surface based radar will be used to track the weapon carrier vehicle. This radar plus two others will also be employed in obtaining fireball position as a function of time after burst.

APPENDIX E

CHRONOLOGY

1. General Considerations.

[Deleted]

The important aspects of the sequential order of launch is in determining the impacts of holds on the position accuracies with respect to the burst point of the sounding rocket borne payloads. By virtue of the sounding systems being relatively high acceleration solid propellant vehicles, those payloads required to be at altitude at burst time can be launched substantially later than the low acceleration Thor system. As the solid vehicles have virtually unlimited hold capability, holds in the Thor system, or due to any phase of the operation, have little impact on the sounding rockets launched subsequent to the Thor. Those few payloads determining background information and hence launched well in advance of the Thor, have considerable tolerance on their timing and holds on the order of 10 minutes subsequent to their launch do not detract from their usefulness. As holds for extended periods of time or cancellations can occur, it would appear necessary to have back up vehicles and payloads for those few launches that do fall in this pre-Thor launch category.

2. Operational Considerations.

The launch sequences resulting from the position-time requirements, and the systems used for positioning, are relatively straightforward considering the number of vehicles involved. Hardline central sequencer launch of all Johnston based vehicles is considered, with individual vehicle override capability in the event of last second malfunction negating a useful experiment. Time tolerances on non-Johnston Island launched systems are such that verbal commands appear to suffice. (S)

~~Secret~~

BLUEGILL
LAUNCH SEQUENCE

<u>ORDER OF LAUNCH</u>	<u>VEHICLE</u>	<u>PAYLOAD</u>	<u>EXPT ALT (Sec)</u>	<u>TIME TO EXPT ALT (Sec)</u>	<u>APOGEE (Km)</u>	<u>LAUNCH TIME FROM EVENT (Sec)</u>
1	Nike Cajun (J)	MF/HF				
2	THOR (J)	W/H				
3	Nike Cajun (J)	Fireball				
4	Nike Cajun (E)	Fireball				
5	Nike Cajun (J)	HF/VHF				
6	Top Side Sounder (J) (XM-33)	Electron Density				
7	Nike Cajun (J)	Chemistry				
8	Nike Cajun (J)	Chemistry				
9	Nike Cajun (J)	Chemistry				
10	Nike Cajun (J)	MF/HF				

Deleted

F
12

J - Johnston
S - Ship

Table 1

~~Secret~~

~~SECRET~~

KINGFISH
LAUNCH SEQUENCE

ORDER OF LAUNCH	VEHICLE	PAYLOAD	EXPT ALT (Sec)	TIME TO EXPT ALT (Sec)	APOGEE (Km)	LAUNCH TIME FROM EVENT (Sec)
1	Nike Cajun (Sa)	HF Absorp (S Conj)	2			}
2	Nike Cajun (J)	HF Absorp				
3	THOR (J)	W/H				
4	Nike Cajun (J)	Chemistry				
5	Nike Cajun (Sa)	Chemistry (S Conj)				
6	Nike Cajun (J)	HF Absorp (N Conj)				
7	Nike Cajun (Sa)	HF Absorp (S Conj)				
8	Nike Cajun (J)	HF Absorp (N Conj)				
9	Nike Cajun (J)	Chemistry				
10	XM-33 (J)	Gamma Scanner				
11	Nike Cajun (J)	HF Absorp				
12	Nike Cajun (J)	Chemistry				
13	Top Side Sounder (J) (XM-33)	Electron Density	2			

Deleted

13

J - Johnston
Sa - Samoa

Table 2

~~SECRET~~

~~SECRET~~
**STARFISH
 LAUNCH SEQUENCE**

<u>ORDER OF LAUNCH</u>	<u>VEHICLE</u>	<u>PAYLOAD</u>	<u>EXPT ALT (Sec)</u>	<u>TIME TO EXPT ALT (Sec)</u>	<u>APOGEE (Km)</u>	<u>LAUNCH TIME FROM EVENT (Sec)</u>
1	Nike Cajun (J)	MF/HF Absorp				
2	THOR	W/H				
3	XM-33 (J)	Debris Magnetometer				
4	XM-33 (S)	Attenuation				
5	XM-33 (P)	Gamma Scanner				
6	Nike Cajun (J)	Chemistry				
7	XM-33 (Sa)	Gamma Scanner (Conj)				
8	Top Side Sounder (J) (XM-33)	Electron Density		<i>Deleted</i>		
9	Nike Cajun (J)	Chemistry				
10	Nike Cajun (J)	Chemistry				
11	Nike Cajun (J)	Chemistry				
12	XM-33 (J)	Attenuation				
13	XM-33 (P)	Gamma Scanner				
14	Nike Cajun (J)	MF/HF Absorp				

E-1
7

J - Johnston
 Sa - Samoa
 P - Palmyra
 S - Ship

Table 3

~~SECRET~~

APPENDIX F

SMALL VEHICLES

1. General Considerations.

One of the inherent difficulties of an airburst operation is the large number of diagnostics and effects payloads to be positioned at altitude at or near burst time. Saturation of launch facilities, communications, and track stations can seriously hamper data gathering on all experiments. To alleviate this situation, every effort must be made to simplify the payload positioning operation commensurate with accomplishing their objectives.

In a test plan with longer lead times it would be reasonable to examine very carefully the excess payload capacity of the prime warhead carrier for use with secondary payloads. There are a variety of pod or small rocket boosted payload configurations that could be attached to the main vehicle with a possible resultant reduction in cost and an improvement in experiment positioning relative to the detonation point. In cases where these advantages are most outstanding pods will be considered on short lead times, but only in an unsophisticated "quick fix" configuration.

With the bulk of the payload requirements thus relying on sounding rockets for positioning the vehicle selection criteria stressed the following concepts:

- a. Maximum reliability of accomplishing adequate placement of a particular payload.
- b. Minimize launch facilities by selecting vehicles that can meet payload placement requirements for several events from a single launch site.
- c. Minimize the variety of vehicles, launchers and launch locations to reduce the number of personnel, ground support equipment, and communications problems. (U)

2. Vehicle Requirements.

Requirements for payload positioning are tabulated in tables 2, 3 and 5 in Section II. Two sounding systems and one pod configuration will satisfy these requirements. The sounding systems selected are the Shotput and the Nike Cajun. The Shotput is a NASA developed, unguided solid propellant vehicle consisting of an XM-33 first stage with two inline recruit boosters and an optional second stage consisting of the X-248 motor.

Altitude and payload capability can be varied by use of the optional second stage. The basic system and launcher ~~is~~^{are} described in figures 1 and 3. The Nike Cajun consists of a Nike-Ajax booster as a first stage with a Cajun second stage motor. This simple, unguided, economical system is used for payloads less than 100 pounds at altitudes under 150 km. Performance and configuration are defined in figures 2 and 4. These two sounding systems offer the following advantages: both systems can utilize the standard NASA boom and most Sergeant launchers as shown in figures 3 and 4 although the Cajun can utilize an even simpler system, all ground handling can be accomplished with an Air Log Model 4100 trailer and a 10,000 lb. capacity hoist, both systems have been flown by organizations throughout the country in a variety of applications with resulting universal familiarity with operational concepts, and current contractor capability exists for vehicles, launchers and ground support equipment. Numerous advantages in operational simplicity are obvious. Most important of these is the interchangeability between vehicles of launch crews, launchers components, spares and GSE, permitting maximum utilization of personnel and equipment as requirements change with the progression of the test series. 

Three "piggy-back" pods will be carried externally on the aft section of the THOR (prime carrier). These pods will weigh a total of 1000 lbs. each with an instrumentation payload capability of approximately 650 pounds. No boost capability is anticipated but rather placement is obtained by ejection from the THOR at predetermined times during the boost phase. This will satisfy requirements for accurate positioning below the burst point. Stability and orientation will be accomplished by aerodynamic and gyroscopic means. As recovery is a requirement, each pod will have a complete recovery system, including drag chute system, floatation gear, and a radio beacon system. 

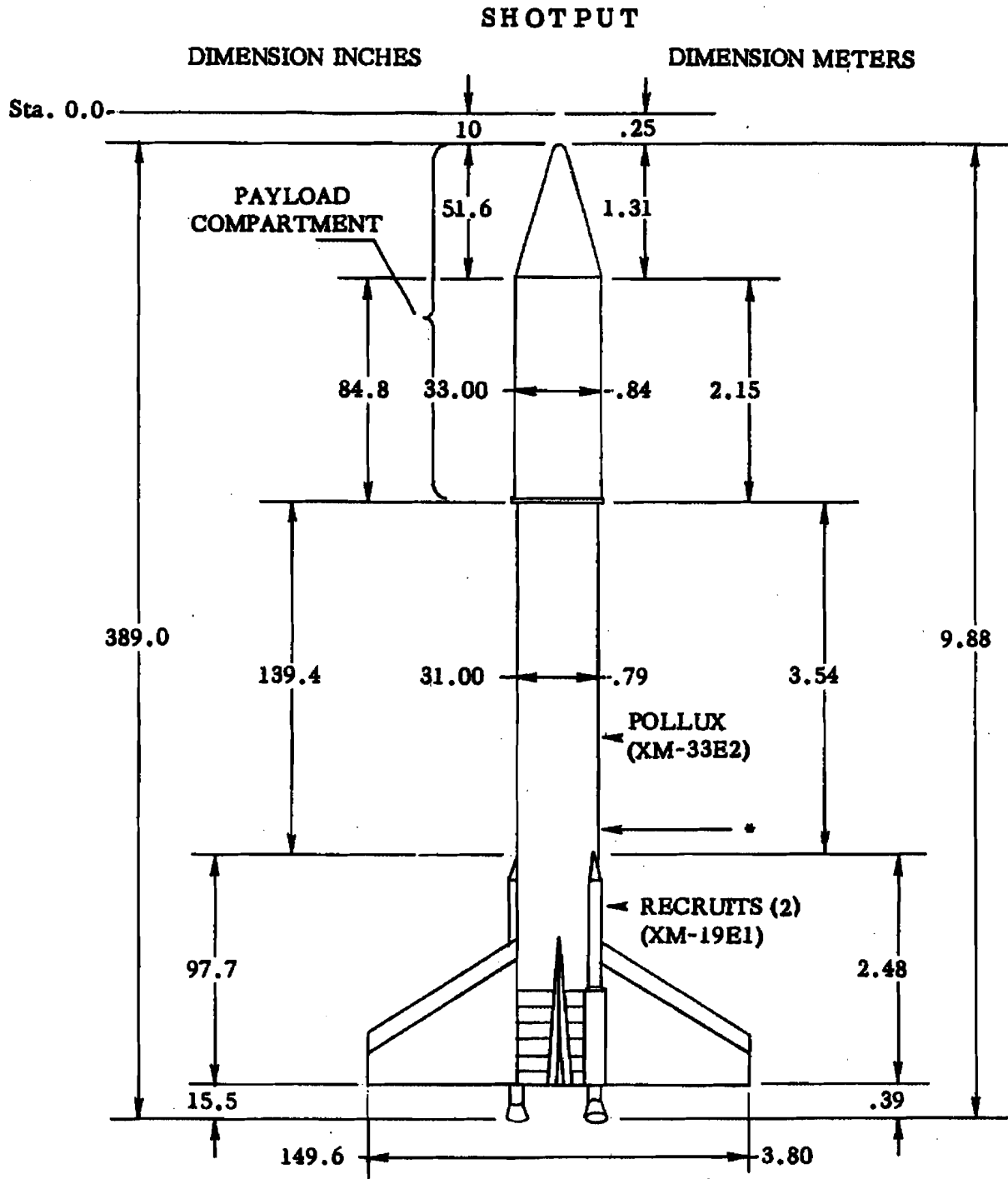

POUNDS	PERFORMANCE WEIGHTS LESS PAYLOAD	KILOGRAMS
10979.9	Launch	4980.4
3357.9	B. O. 1st Stage	1523.1

* Aerodynamic Reference Area = 5.25 ft²

FIGURE 1.

NIKE-CAJUN

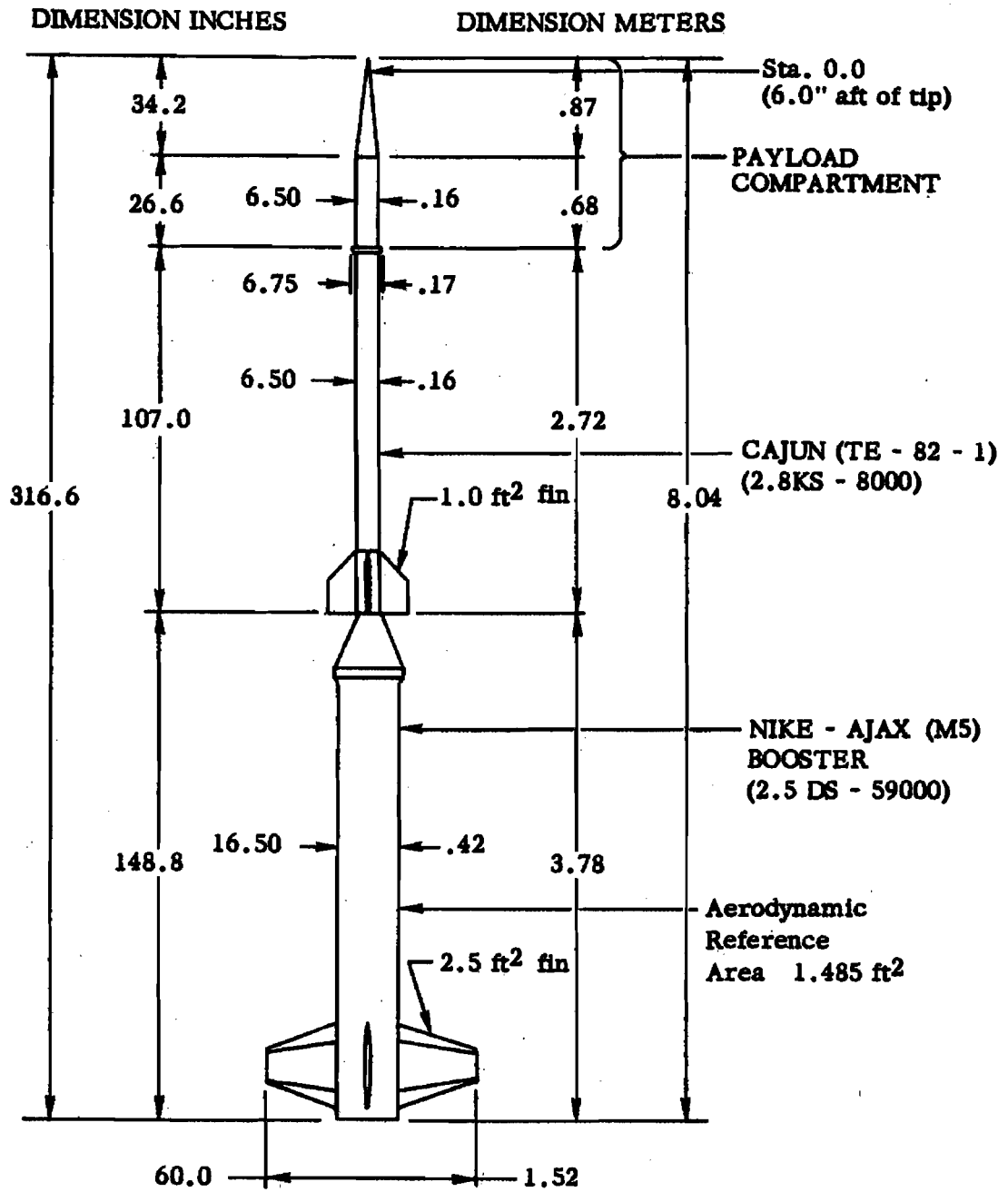

PERFORMANCE WEIGHTS LESS PAYLOAD

POUNDS		KILOGRAMS
1518.9	Launch	689.0
754.9	B. O. 1st Stage	342.4
216.9	Fire 2 Stage	98.4
97.4	B. O. 2 Stage	44.2

FIGURE 2.

SHOTPUT

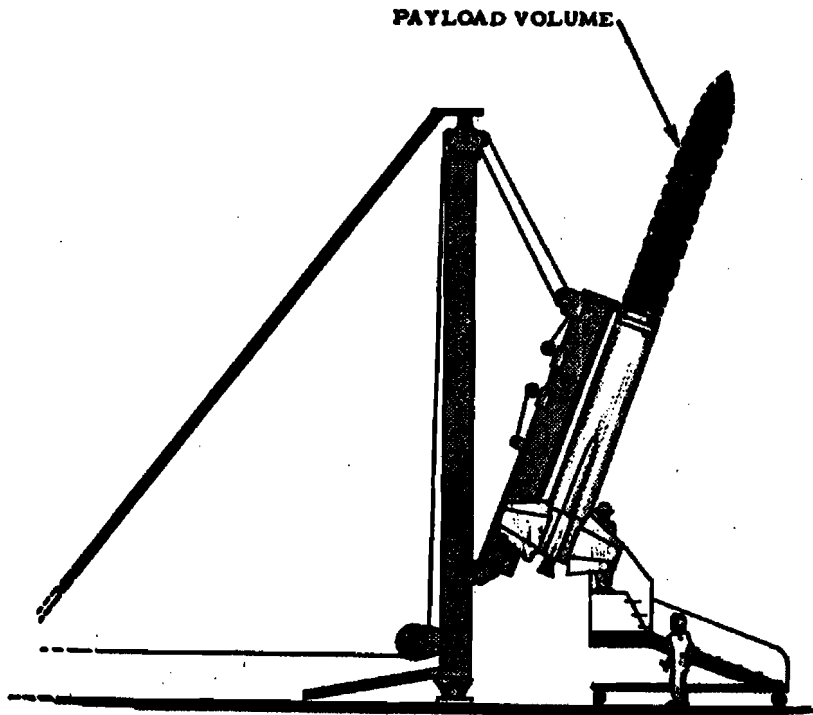
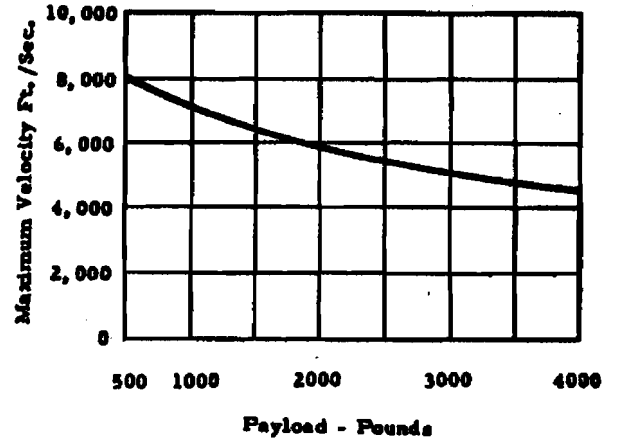
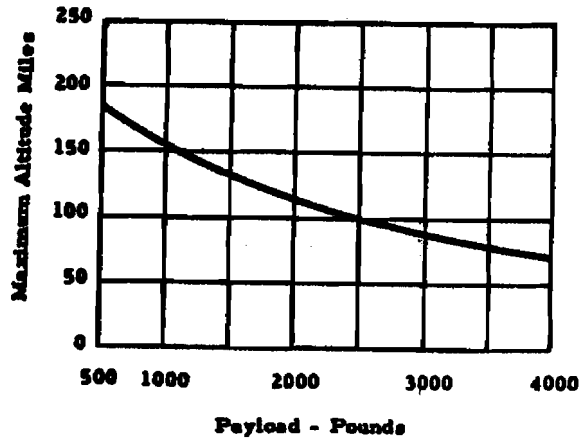

SUMMARY:

One-stage vehicle employing SERGEANT with two auxiliary RECRUITS.

Maximum acceleration with 500# payload is 20 g's.

Payload Volume

May be made as great as desired up to a cylinder 20' long and 31" diameter. (Payload can be increased in diameter and shortened in length at some expense in performance.)

FIGURE 3.

NIKE-CAJUN

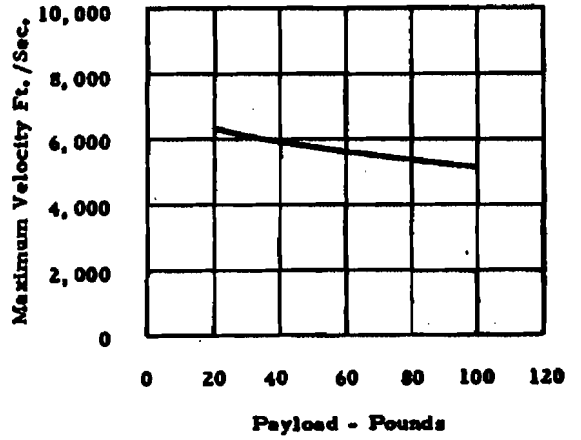
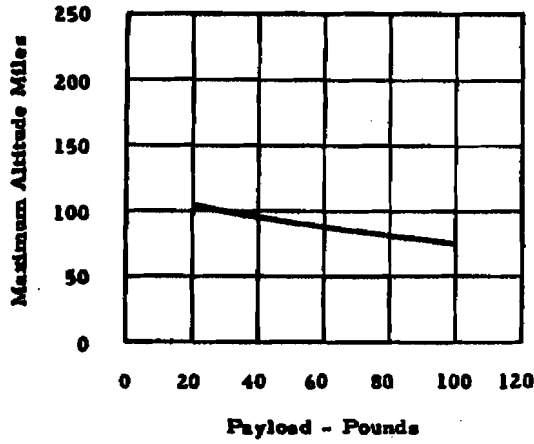

SUMMARY:

Two-stage vehicle employing
NIKE, CAJUN.

Maximum acceleration with 50#
payload is 52 g's.

Payload Volume

6" diameter standard
payload compartment or
equal (see Figure 4).

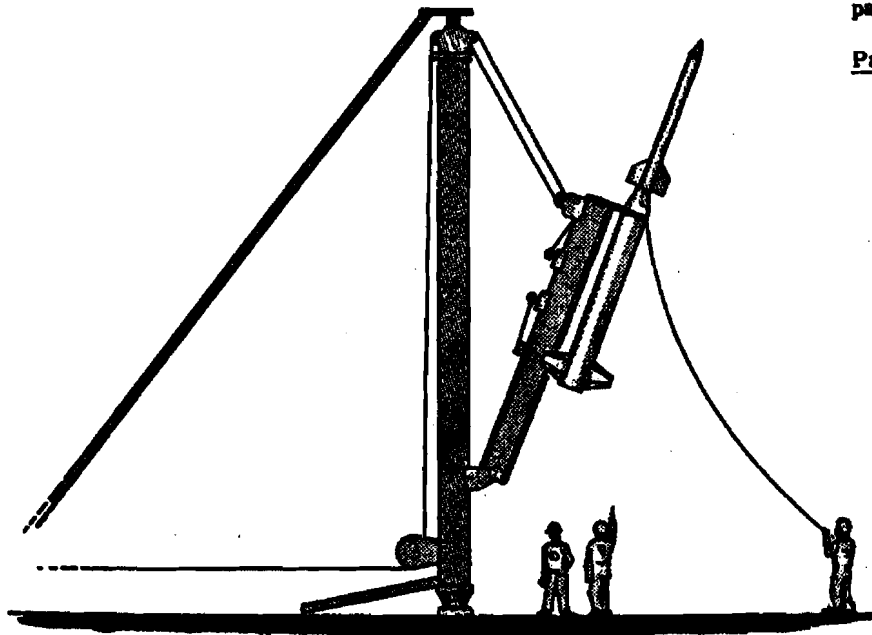

FIGURE 4.

F-6

DISTRIBUTION LIST

COPY NUMBER

1-50 AFSWC (SWOI), Kirtland AFB, NMex

BIBLIOGRAPHY

A few of the major references pertinent to Operation Fishbowl are listed according to three subjects: Motion of Bomb Debris (Phenomenology); Blackout Effects; and Argus Effects. No attempt has been made to include all works, and certainly many others, especially weapon test reports, exist and provide additional valuable information.

Motion of Bomb Debris (Phenomenology)

1. AFSWC TR 57-16: "Early History of High Altitude Nuclear Explosions," H. L. Mayer, 31 May 57 (SRD). Detailed study of the very early time phenomenology of a high altitude nuclear burst.
2. AFSWC TR 59-33: "High Altitude and Free Space Nuclear Explosions," H. H. Johnson, et al, 1 Aug 59 (SRD). Describes beta ionization and non-equilibrium condition of the air following a nuclear burst.
3. AFSWC TN 58-19: "Ultrahigh-Altitude Measurement Feasibility Study," R. E. Meyerott, et al, 15 Aug 58 (SRD). Pre-Hardtack report - describes basic weapon phenomenology, with considerable detail on X-Ray interaction with the atmosphere.
4. AFSWC TN 58-4: "The Effects of Nuclear Weapons in Space," E. B. Giller, et al, Mar 58 (SRD). A test concept and general phenomenology of very high altitude detonations.
5. AFSWC TN 58-6: "Calculations on High Altitude Weapons Effects," J.A. Welch, Jr. Aug 58 (SRD). Pre-Argus Report - Discussion of trapping and magnetic bubble effects.
6. AFSWC TR 59-59: "Physics of Nuclear Explosions in Space," K. A. Bruckner, et al, Oct 59 (SRD). An extensive discussion of space detonations with detailed discussions of bomb debris motion, phenomenology, trapping and some effects.
7. AFSWC TR 60-29: "Research Studies in Nuclear Effects in the Upper Atmosphere," R. W. Hendrick, et al, May 60 (SRD). Describes ionization production with major emphasis upon early time weapon phenomenology. Briefly describes debris produced ionization.
8. RAND RM-2361: "The Pancake Shot," A. L. Latter and R. E. Lelevier, APR 59 (SRD). A description of the phenomenon associated with a 400 km, 2 MT shot.
9. LAMS 2417: "Teak Phenomenology," H. Hoerlin, May 60 (SRD). A summary report of Theoretical and Experimental Studies of TEAK with emphasis on the physics of the major phases of fireball development.

10. AFSWC TR 59-51: "Ultrahigh Altitude Study," LMSD, Oct 59 (SRD). Design for X-ray and debris measurements for Project Willow (includes complete discussion of a gamma scanner experiment).
11. AFSWC TN 60-26: "Fluid Dynamics of a Nuclear Burst," W. Gibson, July 60 (SRD). An analytical study of the hydrodynamics of bomb cloud rise.
12. AFSWC TR 61-1: "Theoretical Studies on the Motion of Bomb Debris," 3 Vols., L. Zadoff, et al, Apr 61 (SRD). Theoretical description of bursts from 400 - 3000 km. Includes some discussion of electron loss from the magnetic bubble.
13. AFSWC TR 61-20: "Theoretical Study of the Motion of Bomb Debris," G. Plass, Apr 61 (SRD). A discussion of bursts at altitudes of 100 and 400 km.
14. AFSWC TR 61-27: "Theoretical Study of the Motion of Bomb Debris," E.A.M. Landshoff, Apr 61 (SRD). A theoretical discussion of the Teak, Orange, and Argus shots. Experimental data and interpretations are given.
15. AFSWC TR 61-54: "Physics of Nuclear Explosions in Space," D. A. Hamlin, et al, Oct 61 (SRD). A theoretical discussion of burst expansions at 1000 and 3000 km.
16. AFSWC (Control #95 35,382): "Proposal for Willow," Oct 59 (SRD). Description of measurements and phenomenology for the Willow high altitude shots.
17. WT 1649: "Growth of Fireball Radii at Very High Altitudes," May 61 (SRD). HARDTACK - Project 8.3. Photographic coverage of Teak, Orange, and Yucca Fireballs.

Blackout Effects

18. RAND RM-2168: "The Effects of Nuclear Explosions on the Propagation of EM Waves," R. Latter and R. Lelevier, May 58 (SRD). Pre-Hardtack discussion of D region blackout.
19. GE TEMPO RM 59 TMP-58: "A Model of Bomb Induced Ionization in the Upper Atmosphere," G. Rohringer, Jun 59 (SRD). Early treatment of the overall problem carried only to electron production rates.
20. WSEG-13: "Conjugate and Local Blackout from High Altitude Nuclear Bursts," B. Tucker, Dec 59 (SRD). Describes conjugate and burst region blackout caused by betas. Develops calculation of effects.

21. AMRAC: Proceedings, Vol. IV, Meeting of 8-10 May 1961 (S) Pages 27-114 contain a general description of blackout. (S)
22. GE TEMPO RM 60 TMP-32: "X-ray Induced Ionization in the Upper Atmosphere," W. F. Dudziak, Jun 60 (S). Machine calculations of X-ray produced ionization for specific bursts. (S)
23. GE TEMPO RM 59 TMP-47: "A Model of Ionization by Fission Fragment Beta Decay," R. W. Hendrick, Aug 59 (SRD). A brief description of beta ionization including the effect of the earth's magnetic field. (S)
24. AFSWC TR 60-27: "Gamma Induced Blackout," S. A. Lukasic, et al, Sep 60 (SRD). A simulation scheme for blackout studies. (U)
25. AFSWC TR 60-40: "A Study of Blackout Phenomena," D. H. Holland, et al, Sep 60 (SRD). Detailed physical interpretations of the Teak and Orange blackout data. (S)
26. RAND RM-2302: "A Survey of the EM Effects of High Altitude Nuclear Detonations," P. Tamarkin, et al, Dec 58 (SRD). A Quick Key report dealing primarily with EM effects observed in Teak and Orange. (S)
27. RAND RM-2392: "Aurora from the Teak Shot," A. L. Latter and W. G. McMillan, Jun 59 (SRD). Correlates Teak observations with beta ionization from a rising and expanding band of fission products. (S)
28. AFGRC TR 60-105: "Operation Hardtack/Newsreel: Radio Attenuation and Reflection Phenomena," L. T. Dolphin and R. B. Dyce, Feb 60 (SRD). SRI report on HF reflection and absorption effects of Teak and Orange. (S)
29. IDA ARPA TR 60-3: "Report on Nuclear Interference" (SRD). Report of the February 1960 RAND conference. Describes the state of the art in atmospheric reaction physics; interprets some Hardtack data. (U)
30. GE TEMPO R60 TMP-1: "Study of the Effect of Space Weapons on Military Electronic Systems," 3 Vols., Jan 61 (SRD). Extensive report on nuclear weapons blackout effects on many classes of radio and radar systems. (S)
31. GE TEMPO RM 61 TMP-9: "Study of the Effects of Space Weapons on Military Electronic Systems," Jan 61 (SRD). This report studies Teak and Orange data and looks at possible uses of blackout as a penetration aid. (S)
32. DASA 1229: "Electromagnetic Blackout Guide," May 61 (SRD). A handbook for calculation of effects of high altitude nuclear bursts on EM waves. (S)
33. RAND RM-2291: "Preliminary Estimates of A Novel Method of Long Range Radio Blackout," B. L. Tucker, Oct 58 (SRD). Discussion of conjugate point blackout. (S)
- 33a. SRI Semi-Annual Report 2: "Analytical Studies on NIKE ZEUS Capability" I. W. Yabroff and J. H. Bryan, Jun 61 (SRD). Complete discussions of capabilities and relations to blackout effects. (S)

34. WT 1645: "HF and VHF Attenuation and Reflection Phenomena," Jun 61 (SRD). Hardtack-Project 6.11. Radar, riometer, satellite, radiometer, and earth-potential measurements. (U)
35. GE TEMPO RM 61 TMP-64: "Penetration Aids - Preliminary Study," L. I. Kopeikin, et al, Sep 61 (SRD). Offensive use of blackout to aid in successful penetration of ICBM's. (U)

Argus Effects

36. IDA ARPA R 59-1: "Report of the Second Argus Working Group at LRL, Feb 59", Apr 59 (SRD). Interpretation of some of the data from the Argus experiments. (U)
37. DASA 1223: "Report of the Third Argus Working Group," R. B. Dyce, Jan 61. (S-FRD). Describes current status of Argus theory and reduction of Argus test data, with recommendations. (U)
38. UCRL 5585: "Synchrotron Radiation from Argus Electrons," P. Nakada, May 59 (SRD). A detailed treatment of Argus noise. (U)
39. WSEG RM 12 & 17: "Noise from an Extended Argus Shell," R. N. Schwartz, Nov 59 (SRD). Noise as a function of frequency, yield, and antenna location. (U)
40. AFSWC TN 61-31: "Argus Noise", J. A. Welch, Jr. and J. F. Ahearne, May 61 (S). Turbulent Argus description. (S)
41. AFSWC TR 61-21: "Lab Simulation of Geomagnetic Trapping of Explosions from Nuclear Explosions," E. L. Chupp, et al, Mar 61 (SRD). A laboratory terrella experiment to study stability of high electron density trapping. (U)
42. AFSWC TR 61-38: "Artificial Injection of Electrons into the Geomagnetic Field," D. E. Elliot, May 61 (U). A description of satellite electron accelerator experiments. (U)
43. AFSWC TR 61-70: "Plasma Cyclotron Radiation," H. R. Rosner, Nov 61 (S). Description of the extent and intensity of Argus shell radiation. (U)
44. WT 1668: "Satellite Measurements", Apr 60 (SRD). Explorer IV Measurements During the Argus Shots. (U)
45. AFSWC TN 60-8: "Tables of Adiabatic Invariance for the Geomagnetic Field 1955.0," J. A. Welch, Jr., et al, Apr 60 (U).

~~SECRET~~

- 46. WT 1669: "Sounding Rocket Measurements," (SRD). Project Jason. Results of the rocket measurements launched from the U.S. during the Argus shots. (S)
- 47. WT 1670: "Surface Measurements," (SRD). Project Midas. World wide surface measurements during the Argus shots. (S)
- 48. J. Geophys Resch, Vol 64, (Aug 59), "A Symposium on the Scientific Effects of Artificially Introduced Radiations at High Altitudes," (U) Includes papers on the theory and experiments of the Argus shots. (S)

Eyeburn

- 49. LAMS 2337: "High Altitude Explosions and Eyeburn Problem," H. Hoerlin, et al, Nov 59, (SRD). Discussion of early fireball phases and emission of visible light. (S)

~~SECRET~~

~~RESTRICTED DATA~~
~~ALONE~~