



WTEC Panel Report on

**ADDITIVE/SUBSTRUCTIVE MANUFACTURING RESEARCH AND
DEVELOPMENT IN EUROPE**

Joseph J. Beaman (Chair)
Clint Atwood
Theodore L. Bergman
David Bourell
Scott Hollister
David Rosen



World Technology Evaluation Center, Inc.

2809 Boston Street, Suite 441
Baltimore, Maryland 21224

Report Documentation Page

*Form Approved
OMB No. 0704-0188*

Public reporting burden for the collection of information is estimated to average 1 hour per response, including the time for reviewing instructions, searching existing data sources, gathering and maintaining the data needed, and completing and reviewing the collection of information. Send comments regarding this burden estimate or any other aspect of this collection of information, including suggestions for reducing this burden, to Washington Headquarters Services, Directorate for Information Operations and Reports, 1215 Jefferson Davis Highway, Suite 1204, Arlington VA 22202-4302. Respondents should be aware that notwithstanding any other provision of law, no person shall be subject to a penalty for failing to comply with a collection of information if it does not display a currently valid OMB control number.

1. REPORT DATE 2007	2. REPORT TYPE	3. DATES COVERED 00-00-2007 to 00-00-2007	
4. TITLE AND SUBTITLE Additive/Subtractive Manufacturing Research and Development in Europe		5a. CONTRACT NUMBER	
		5b. GRANT NUMBER	
		5c. PROGRAM ELEMENT NUMBER	
6. AUTHOR(S)		5d. PROJECT NUMBER	
		5e. TASK NUMBER	
		5f. WORK UNIT NUMBER	
7. PERFORMING ORGANIZATION NAME(S) AND ADDRESS(ES) World Technology Evaluation Center (WTEC) Inc, 2809 Boston Street Suite 441, Baltimore, MD, 21224		8. PERFORMING ORGANIZATION REPORT NUMBER	
9. SPONSORING/MONITORING AGENCY NAME(S) AND ADDRESS(ES)		10. SPONSOR/MONITOR'S ACRONYM(S)	
		11. SPONSOR/MONITOR'S REPORT NUMBER(S)	
12. DISTRIBUTION/AVAILABILITY STATEMENT Approved for public release; distribution unlimited			
13. SUPPLEMENTARY NOTES The original document contains color images.			
14. ABSTRACT			
15. SUBJECT TERMS			
16. SECURITY CLASSIFICATION OF:			17. LIMITATION OF ABSTRACT
a. REPORT unclassified	b. ABSTRACT unclassified	c. THIS PAGE unclassified	
			18. NUMBER OF PAGES 154
			19a. NAME OF RESPONSIBLE PERSON

WTEC PANEL ON ADDITIVE/SUBTRACTIVE MANUFACTURING RESEARCH AND DEVELOPMENT IN EUROPE

Sponsored by the National Science Foundation, the Defense Advanced Research Projects Agency, the Office of Naval Research, and the National Institute of Standards and Technology of the United States Government.

Joseph J. Beaman (Chair)
Department Chair
Mechanical Engineering Dept.
1 University Station C2200
University of Texas at Austin
Austin, TX 78712-0292

David Bourell
Temple Foundation Professor
The Texas Materials Institute
Campus Mail Code C2201
University of Texas at Austin
Austin, Texas 78712-1063

Clint Atwood
Principal Member of Technical Staff
S&T Business Development Department
Sandia National Laboratories
P.O. Box 5800, MS1008
Albuquerque, New Mexico 87185-1008

Scott Hollister
Associate Professor of Biomedical Engineering
The University of Michigan
Rm. 3414 GG Brown Bldg.
2520 Hayward
Ann Arbor, MI 48109-2125

Theodore L. Bergman
Associate Dean of Research and Outreach
School of Engineering
The University of Connecticut
484 United Technologies Building
191 Auditorium Road, Unit-3139
Storrs, CT 06269-3139

David Rosen
Professor, The George W. Woodruff
School of Mechanical Engineering
and Woodruff Faculty Fellow
Georgia Institute of Technology
Atlanta, Georgia 30332-0405

WTEC, Inc.

WTEC provides assessments of international research and development in selected technologies under awards from the National Science Foundation (NSF), the Office of Naval Research (ONR), and other agencies. Formerly part of Loyola College's International Technology Research Institute, WTEC is now a separate non-profit research institute. Michael Reischman, Deputy Assistant Director for Engineering, is NSF Program Director for WTEC. Sponsors interested in international technology assessments and related studies can provide support for the program through NSF or directly through separate grants to WTEC.

WTEC's mission is to inform U.S. scientists, engineers, and policymakers of global trends in science and technology. WTEC assessments cover basic research, advanced development, and applications. Panels of about six technical experts conduct WTEC assessments. Panelists are leading authorities in their field, technically active, and knowledgeable about U.S. and foreign research programs. As part of the assessment process, panels visit and carry out extensive discussions with foreign scientists and engineers in their labs.

The WTEC staff helps select topics, recruits expert panelists, arranges study visits to foreign laboratories, organizes workshop presentations, and finally, edits and disseminates the final reports.

WTEC Panel on

**ADDITIVE/SUBTRACTIVE MANUFACTURING RESEARCH AND DEVELOPMENT
IN EUROPE**

Final Report

December 2004

Joseph J. Beaman (Chair)
Clint Atwood
Theodore L. Bergman
David Bourell
Scott Hollister
David Rosen

This document was sponsored by the National Science Foundation (NSF) and other agencies of the U.S. Government under awards from NSF (ENG-0104476) and the Office of Naval Research (N00014-03-1-809) awarded to the World Technology Evaluation Center, Inc. The Government has certain rights in this material. Any opinions, findings, and conclusions or recommendations expressed in this material are those of the authors and do not necessarily reflect the views of the United States Government, the authors' parent institutions, or WTEC, Inc.

ABSTRACT

This report is a review of additive/subtractive manufacturing techniques in Europe. Otherwise known as Solid Freeform Fabrication (SFF), this approach has resided largely in the prototyping realm, where the methods of producing complex freeform solid objects directly from a computer model without part-specific tooling or knowledge started. But these technologies are evolving steadily and are beginning now to encompass related systems of material addition, subtraction, assembly, and insertion of components made by other processes. Furthermore, these various additive/subtractive processes are starting to evolve into rapid manufacturing techniques for mass-customized products, away from narrowly defined rapid prototyping. Taking this idea far enough down the line, and several years hence, a radical restructuring of manufacturing as we know it could take place. Not only would the time to market be slashed, manufacturing itself would move from a resource base to a knowledge base and from mass production of single use products to mass customized, high value, life cycle products. At the time of the panel's visit, the majority of SFF research and development in Europe was focused on advanced development of existing SFF technologies by improving processing performance, materials, modeling and simulation tools, and design tools to enable the transition from prototyping to manufacturing of end use parts. Specific examples include: laser sintering of powders, direct metal deposition and laser fusion of powders, and ink jet printing techniques. Truly integrated layer-by-layer additive/subtractive processes under development are limited; European emphasis was on creating an entire process chain to create new business models.

World Technology Evaluation Center, Inc.

R. D. Shelton, President
Y.T. Chien, Vice President, Research
Michael DeHaemer, Vice President, Development
Geoffrey M. Holdridge, Vice President, Government Services
Roan E. Horning, Vice President, Operations
Hassan Ali, Project Manager
Thomas Bartolucci, Project Manager
Pat Johnson, Editor
Mike Jasik, Editor
European Advance Work by Erika Feulner

FOREWORD

We have come to know that our ability to survive and grow as a nation to a very large degree depends upon our scientific progress. Moreover, it is not enough simply to keep abreast of the rest of the world in scientific matters. We must maintain our leadership.¹

President Harry Truman spoke those words in 1950, in the aftermath of World War II and in the midst of the Cold War. Indeed, the scientific and engineering leadership of the United States and its allies in the twentieth century played key roles in the successful outcomes of both World War II and the Cold War, sparing the world the twin horrors of fascism and totalitarian communism, and fueling the economic prosperity that followed. Today, as the United States and its allies once again find themselves at war, President Truman's words ring as true as they did a half century ago. The goal set out in the Truman Administration of maintaining leadership in science has remained the policy of the U.S. Government to this day: Dr. John Marburger, the Director of the Office of Science and Technology (OSTP) in the Executive Office of the President made remarks to that effect during his confirmation hearings in October 2001.²

The United States needs metrics for measuring its success in meeting this goal of maintaining leadership in science and technology. That is one of the reasons that the National Science Foundation (NSF) and many other agencies of the U.S. Government have supported the World Technology Evaluation Center (WTEC) and its predecessor programs for the past 20 years. While other programs have attempted to measure the international competitiveness of U.S. research by comparing funding amounts, publication statistics, or patent activity, WTEC has been the most significant public domain effort in the U.S. Government to use peer review to evaluate the status of U.S. efforts in comparison to those abroad. Since 1983, WTEC has conducted over 50 such assessments in a wide variety of fields, from advanced computing, to nanoscience and technology, to biotechnology.

The results have been extremely useful to NSF and other agencies in evaluating ongoing research programs and in setting objectives for the future. WTEC studies also have been important in establishing new lines of communication and identifying opportunities for cooperation between U.S. researchers and their colleagues abroad, thus helping to accelerate the progress of science and technology generally within the international community. WTEC is an excellent example of cooperation and coordination among the many agencies of the U.S. Government that are involved in funding research and development: almost every WTEC study has been supported by a coalition of agencies with interests related to the particular subject at hand.

As President Truman said over 50 years ago, our very survival depends upon continued leadership in science and technology. WTEC plays a key role in determining whether the United States is meeting that challenge, and in promoting that leadership.

Michael Reischman
Deputy Assistant Director for Engineering
National Science Foundation

¹ Remarks by the President on May 10, 1950, on the occasion of the signing of the law that founded the National Science Foundation. *Public Papers of the Presidents* 120: 338.

² http://www.ostp.gov/html/01_1012.html.

TABLE OF CONTENTS

Foreword.....	i
Table of Contents.....	iii
List of Figures.....	v
List of Tables.....	vii
Preface.....	viii
Executive Summary.....	ix
1. Introduction	
<i>Joseph J. Beaman and Clint Atwood</i>	
Scope of Study.....	1
Introduction to the Field.....	2
Methodology.....	3
Panel Members.....	4
Sites Visited.....	4
Report Outline.....	5
Brief Synopsis of the Study.....	5
References.....	5
2. Methodologies and Processes	
<i>David L. Bourell and Joseph J. Beaman</i>	
Introduction.....	7
Review of Commercial Additive Processes.....	7
European Additive/Subtractive Methodologies and Processes.....	9
Computational Advances.....	20
Summary of R&D Issues.....	23
Bibliography.....	23
3. Manufacturing Advances, Applications, and Challenges	
<i>Clint Atwood</i>	
Introduction.....	25
Overview.....	25
Selected Advancements.....	26
Applications.....	30
Challenges.....	32
4. Materials and Materials Processing	
<i>Theodore L. Bergman and David L. Bourell</i>	
Introduction.....	35
Literature Review.....	35
Materials Development.....	36
Summary.....	41
References.....	41
5. Process Control and Metrics	
<i>David W. Rosen</i>	
Introduction.....	43
Controls and Sensors.....	44
CAD and Information Modeling.....	46
Accuracy and Resolution.....	51

	Metrics and Standardization Opportunities	52
	Future and Barriers	53
	References	54
6.	Biomedical Applications of Integrated Additive/Subtractive Manufacturing <i>Scott J. Hollister and Theodore L. Bergman</i>	
	Introduction	55
	Fabrication of External Devices	56
	Fabrication of Permanent Surgical Implants.....	57
	Fabrication of Tissue Engineering Scaffolds	58
	Summary.....	61
	References	62
7.	Energy and Environment <i>David W. Rosen</i>	
	Introduction	63
	Energy-Related A/S Applications.....	63
	Environmentally Benign Manufacturing	67
	Future and Barriers	69
	References	70
8.	Conclusions and Future Requirements <i>Joseph J. Beaman and Clint Atwood</i>	
	European Activity in A/S Manufacturing	71
	Future Requirements and Barriers	74
	Other Observations	75
	References	75
APPENDICES		
A.	Panel Biographies	77
B.	Site Reports — Europe	
	Fraunhofer Institute for Laser Technology (ILT)	80
	Fraunhofer Institute for Manufacturing and Advanced Materials (IFAM).....	82
	Fraunhofer Institute for Production Technology (IPT).....	84
	Helsinki University of Technology (HUT).....	86
	Imperial College, London	92
	IVF Industrial Research and Development Corporation.....	95
	Loughborough University.....	100
	Manchester Materials Science Center (MMSC) and University of Manchester Institute of Science and Technology (UMIST).....	107
	Polytechnic Institute of Leiria (IPL).....	113
	TNO Industrial Technology.....	116
	University of Bremen	118
	Albert Ludwig University of Freiburg.....	120
	University of Leeds.....	124
	University of Liverpool	126
	University of Nottingham	129
C.	Glossary	136

LIST OF FIGURES

1.1. Schematic of stereolithography, a representative SFF photopolymer process	2
1.2. Complex SFF part created in a selective laser sintering process.....	2
1.3. Uses of SFF parts	3
2.1. Schematics of deposition processes	8
2.2. Schematic of a lamination process	8
2.3. Schematics of powder processes.....	9
2.4. Perfactory SLA photopolymer system by Envisiontec	9
2.5. MetalCopy™ at the IVF.....	10
2.6. The 3D Bioplotter™, the current commercial version for layered manufacturing of biomaterials.....	11
2.7. Close-up of contour crafting and sample parts.....	11
2.8. The cubic inkjet machine and a ceramic part.....	12
2.9. Cut and stack production tooling for polyurethane foam molding and thermal profiles.....	13
2.10. Laminated part construction at BIBA Germany by precision milling of thick plates	14
2.11. Rapid powder sintering (mask sinter process) by Speedpart.....	14
2.12. Direct Selective Laser Melting of metallic powder.....	15
2.13. EOS direct metal laser sintered H20 tool steel parts	15
2.14. Arcam electron beam melting (EBM) additive fabricator and a representative part.....	16
2.15. Ceramic laser sintered parts from the Fraunhofer IPT	16
2.16. Schematic of Controlled Metal Build-Up at Fraunhofer IPT	17
2.17. Representative parts produced using Controlled Metal Build-Up.....	18
2.18. (<i>Left</i>) textile representation, and (<i>right</i>) actual fabric	19
2.19. Schematic of the Amino Corporation sheet metal former, a dieless NC forming process	19
2.20. Actual dieless forming process using the Amino Corporation Sheet Metal Former	19
2.21. STL file representation using DeskArtes Oy 3D expert software	21
2.22. University of Leeds physical modeling of the density of (<i>left</i>) polycarbonate and (<i>right</i>) nylon and glass-filled nylon as functions of laser power P, scan speed U, and scan spacings	21
2.23. Typical process map showing the dependence of the metal melt zone morphology upon processing parameters such as laser power and scanning speed	22
3.1. Loughborough's rapid manufacturing lab.....	26
3.2. UNIMAT's diode laser cladding machine	28
3.3. Transformation of material during the ultrasonic consolidation (UC) process	29
3.4. The UC research platform at Loughborough	30
3.5. Rapid manufacturing design: An example of reducing part count from 16 parts to 1 part	31
3.6. Examples of parts and tooling fabricated using the EOS Direct Metal Laser Sintering (DMLS) process.....	31
3.7. High speed sintering process: commercial reality of rapid manufacturing	32
4.1. Water resistance of newly developed glass ionomer cement (<i>bottom</i>) and two commercial materials for 3D printing	36
4.2. Gas-atomized (<i>left</i>) and water-atomized (<i>right</i>) 316L stainless steel powder	37
4.3. Laser-clad layers of 316L using gas-atomized particles (<i>left</i>) and water-atomized particles (<i>right</i>)	38
4.4. Schematic of the Arcam electron beam melting (EBM) system	38
4.5. A fully dense drill bit (H13 tool steel) and the associated microstructure processed with the Arcam electron beam melting system	39
4.6. Ink-jet printed, two-dimensional ZrO ₂ structure with 170 μm resolution	40
4.7. Three-dimensional structures fabricated by direct ceramic ink-jet printing.....	40
5.1. A/S system with inputs and outputs.	43
5.2. Relationships between LC variables and part quality	45
5.3. Example of textile fabricated using SLS.....	47

5.4. Example triangular mesh objects	49
5.5. Typical approaches to determining or improving accuracy	52
6.1. Optimally designed interbody spinal fusion cage created by additive manufacturing.....	58
6.2. Schematic showing the reactive plotting process of the 3D Bioplotter	59
6.3. Processes and associated materials that have been used on the 3D Bioplotter	60
6.4. Viable cells (light dots) printed within agar gel using the 3D Bioplotter	61
7.1. Example PEM fuel cell configuration.....	64
7.2. Example battery fabricated using A/S processes	66
7.3. Mold with conformal cooling channel.....	68
8.1. Rapid manufacturing timeline from Sweden's fcubic	72
8.2. Rapid manufacturing timeline in Finland from Rapid Product Innovations	73

LIST OF TABLES

ES.1 Comparison of European and U.S. R&D in Additive/Subtractive Manufacturing.....	xi
1.1 Sites Visited in Europe.....	4
2.1 European Additive/Subtractive Activity.....	20
4.1 Materials and Materials processing for Additive Manufacturing.....	36
4.2 Mechanical Properties of Alloyed Titanium and Tool Steel.....	39
4.3 Overview of Microfabrication Processes with Ceramic Powders.....	41

PREFACE

This report was prepared by WTEC, which is a non-profit research institute funded by grants from most of the Federal research agencies. Among other studies, WTEC has provided peer reviews by panels of American experts of international R&D in 60 fields since 1989. In early 2003, WTEC was asked by several agencies to assess European R&D in additive/subtractive manufacturing. This report is the final product of that study.

We would like to thank our distinguished panel of experts, who are the authors of this report, for all of their efforts to bring this study to a successful conclusion. We also are very grateful to our European hosts for their generous hospitality to our panel, and to the participants in our workshop on additive/subtractive manufacturing in Europe. Of course, this study would not have been possible without encouragement from our sponsor representatives: George Hazelrigg, Delcie Durham, Michael Reischman, and Deborah Young of NSF; Ralph Wachter and Khershed Cooper of ONR; Joe Bielitzky of DARPA, and Kevin Lyons of NIST (now at NSF).

This report covers a broad spectrum of material on the subject, so it may be useful to give a preview here. The Executive Summary was prepared by the chair, Joseph J. Beaman, with input from all the panelists. The chapters in the body of this report present the panel's findings in an analytical organization by subdiscipline. Appendix A provides the biographies of the panelists. Appendices B contain the panel's individual reports on each site visited in Europe, which form a chronological or geographic organization of much of the material. A glossary is in Appendix C.

All the products of this project are available at <http://www.wtec.org>. The electronic color version of this report is particularly useful for figures that do not reproduce well in black and white. Also posted at this site are the slideshows from the workshop held for this project, which contain considerable additional information on R&D in European additive/subtractive manufacturing. Comments on this report are welcome.

Roan Horning

EXECUTIVE SUMMARY

Joseph J. Beaman

INTRODUCTION

Increasingly sophisticated technologies have been developed over the last 20 years to produce complex, freeform solid objects directly from computer models without part-specific tooling; these are often labeled “solid freeform fabrication” (SFF) technologies. Until recently they have been applied principally to prototype models and have encompassed predominantly *additive* or layered manufacturing techniques. These technologies are evolving steadily and are beginning now to encompass related systems of material addition, subtraction, assembly, and insertion of components made by other processes. Furthermore, these various *additive/subtractive* processes are starting to evolve into rapid *manufacturing* techniques for mass-customized products, away from narrowly defined rapid prototyping.

If additive/subtractive (A/S) techniques can be effectively used for actual manufacturing, they hold the promise of drastically decreasing the time to market for new products and of reducing the life cycle costs of existing products. They can also help to create totally new types of manufacturing jobs in the advanced economies of the world. This will be especially true as manufacturing moves from a resource base to a knowledge base and as important manufacturing segments move from mass-produced, single-use products, to new mass-customized, high-value, life-cycle products. This report of the World Technology Evaluation Center (WTEC) presents the results of a comparative study of integrative additive/subtractive approaches to material synthesis and manufacturing in Europe and the United States in the context of direct manufacture of products. Besides reviewing the state of the art of A/S processes and materials generally, the study reviews application of A/S manufacturing specifically to medicine and tissue engineering, energy systems, and the environment.

This initiative was administered by WTEC and sponsored by four agencies of the U.S. government: the National Science Foundation (NSF), the Defense Advanced Research Projects Agency (DARPA), the Office of Naval Research (ONR), and the Department of Commerce (DOC). It starts from and builds on an earlier WTEC report, *Rapid Prototyping in Europe and Japan* (Prinz et al. 1996-7). The study’s sponsors asked the members of the expert panel to gather and compare information on additive/subtractive manufacturing research and development in Europe and the United States in order to inform and guide U.S. Government planning for research investments, to clarify research opportunities and requirements for advancing the field, and to identify opportunities for international collaboration.

To achieve the sponsors’ goals, the members of the WTEC panel carried out the study in several phases:

- Establish a baseline for the study by conducting a literature review of recent work in the field
- Gather first-hand information concerning state-of-the-art R&D in A/S manufacturing by conducting visits to 15 renowned university and industrial laboratories in 5 European countries
- Report back findings in both a public forum and in writing to the sponsors, the scientific community, and the public

The panelists visited the sites in Europe in October 2003. The Additive/Subtractive Manufacturing Workshop was held at the National Science Foundation on December 2, 2003. This report, the final phase of the study, details and analyzes the WTEC panel’s findings. Both the viewgraphs of the workshop and the files of this report are available to the public on the Web at www.wtec.org/additive/.

MAJOR FINDINGS

Early in the course of this WTEC study, it became evident that SFF manufacturing technology development was a priority at most of the sites visited in Europe and that teaming relationships had been established between university, industry, and government entities within each country visited and in many cases, across Europe. The majority of the additive/subtractive research and development in Europe was focused on advanced development of existing SFF technologies to enable the transition from prototyping to manufacturing of end-use parts by improving processing performance, materials, modeling and simulation tools, and design tools. Additionally, there were several efforts in applications development for limited production parts, and studies were underway to compare SFF techniques with traditional manufacturing processes.

Following are the major conclusions of the WTEC's expert panel concerning the status of A/S manufacturing in Europe compared to the United States:

1. The European Union (EU) has an organized effort to make advances in Solid Freeform Fabrication (SFF) or layered processes, as evident in the EU's completed RAPTIA project and its new NEXTRAMA project. The European community has targeted rapid manufacturing as the primary goal of this project.
2. There is substantial funding for important process development of SFF technologies that were in many cases initiated in the United States (laser sintering of powders, direct metal deposition and laser fusion of powders, and ink-jet printing techniques). European funding is substantially higher than U.S. funding in these established technologies.
3. European research and development infrastructure in SFF technologies is superior to that in the United States.
4. Although the United States is still leading in innovations in this field, there is more innovative and leading-edge R&D going on in Europe now as compared to the 1996-7 timeframe of the earlier WTEC rapid prototyping study.
5. As compared to the United States, there is a much closer tie in Europe between university research and industrial needs.
6. Although less emphasized in Europe than in the United States, basic science is still present in European research in SFF and related technologies.
7. There are very few development programs in Europe that truly integrate both additive and subtractive processes.
8. The emphasis of European researchers is on opportunities in rapid manufacturing using SFF technologies with a variety of other complementary processes. They are interested in the entire process chain to create new business models.
9. The combined work of the University of Freiburg and Envisiontec for tissue scaffolding is as advanced or more advanced than any worldwide. The 3D Bioplotter is the first biospecific fabrication system that can print the entire range of biomaterials *and cells* that will be the future of biofabrication. This *commercial* system is as advanced as research prototypes in the United States.
10. There is no work in fabricating fuel cells with SFF, but the possibility is of interest to the European community.
11. European researchers recognize the need to consider the environmental impact of A/S processes, particularly as more production manufacturing applications emerge. Research underway in this area is limited at present.
12. There is a pervasive acknowledgement by European hosts of the inadequacies of existing CAD capabilities for design of parts to be fabricated by SFF.
13. As in the United States, the number of rapid prototyping service bureaus has declined. Many companies are obtaining concept modelers for rapid prototyping, which is a separate market from rapid manufacturing.
14. Most European researchers would welcome collaboration on international programs/projects with U.S. researchers in additive/subtractive manufacturing.

COMPARISON CHART

Following WTEC tradition, the panel created Table ES.1 to rank the relative strengths and trends in A/S manufacturing in Europe and the United States.

Table ES.1
Comparison of European and U.S. R&D in Additive/Subtractive Manufacturing

Categories	Global Knowledge Base	Europe Compared to the United States	Perceived European Future (5-10 yrs) Relative to U.S.*
Processes	HIGH	Caught Up	↑
Manufacturing	MED	On par, w/ isolated superiority	↑
Materials & Materials Processing	HIGH	Comparable	↔
Biological Applications	LOW	On par, w/ isolated superiority	↔
Controls	HIGH	Lagging	↔
Energy	VERY LOW	Limited	↓
Environment	LOW	Leading	↑
Infrastructure/Equipment	-	Clearly Superior	??
Funding	-	Clearly Superior	??

***Symbols Key**

↑ = better than U.S.

↔ = on par with U.S.

↓ = lower than U.S.

REFERENCES

Prinz, F.B., C.L. Atwood, R.F. Aubin, J.J. Beaman, R.L. Brown, P.S. Fussell, A.J. Lightman, E. Sachs, L.E. Weiss, and M.J. Wozny. 1996-7. WTEC panel report on rapid prototyping in Europe and Japan (Vols. 1 and 2). Baltimore, MD: World Technology Evaluation Center, Inc. Available from National Technical Information Service (NTIS), Springfield, VA (reports #PB97-162564 and #PB96-199583), or on the Web at <http://www.wtec.org>.

CHAPTER 1

INTRODUCTION

Joseph J. Beaman and Clint Atwood

SCOPE OF STUDY

Additive/subtractive manufacturing techniques encompass so-called solid freeform fabrication (SFF) methods. These have been used since the 1980s to produce prototypes of complex freeform solid objects directly from computer models without part-specific tooling or knowledge (Beaman et al. 1997; Venuvinod and Ma 2004). The techniques by now are well established, especially for rapid prototyping of mechanical elements. The SFF community has made great strides in applying two-dimensional design decomposition to the layered deposition of structures with increasing geometric complexity. However, use of layered SFF techniques alone can be restrictive with respect to part quality and material variety. This report uses the term “additive/subtractive manufacturing” to mean those rapid fabrication processes that include more than just layered processes, but also related systems of material addition, subtraction, assembly, and insertion of components made by other processes.

In addition to the emergence of a greater variety and complexity of rapid fabrication processes, materials, and products, it is clear that additive/subtractive processes are starting to emerge as true rapid *manufacturing* techniques for mass-customized products, not just for prototyping. If these techniques can be effectively used for true manufacturing, they hold the promise of transforming the traditional manufacturing paradigm by drastically decreasing the time to market for new products, reducing the life cycle costs of existing products, and creating new manufacturing jobs built on an expanded knowledge base.

This report of the World Technology Evaluation Center (WTEC) expands on a 1996-7 WTEC study entitled *Rapid Prototyping in Europe and Japan* (Prinz et al. 1996-7). This report examines subsequent research and development in additive/subtractive manufacturing technologies *in the context of new, integrative approaches to material synthesis and manufacturing* in Europe and the United States. The study’s sponsors are four agencies of the U.S. Government: the National Science Foundation (NSF), the Defense Advanced Research Projects Agency (DARPA), the Office of Naval Research (ONR), and the Department of Commerce (DOC). The sponsors charged the WTEC panelists with gathering information on additive/subtractive manufacturing research and development programs at home and in Europe, and with critically analyzing and comparing them. The goals are to

- Inform and guide U.S. government planning for its research investments
- Identify good ideas overseas worth exploring in U.S. S&T programs
- Clarify research opportunities and needs for advancing progress in the field generally
- Identify opportunities for international collaboration
- Evaluate the position of European research programs relative to those in the United States

It is in the area of direct manufacturing that the WTEC panel focused this study. In particular, the panel looked at additive/subtractive manufacturing processes appropriate for the custom manufacture of products rather than models. Other areas of particular interest to the panelists and the study's sponsors were the application of additive/subtractive manufacturing to materials synthesis enabled by and developed for these processes; medicine and tissue engineering; energy applications; and environmental impacts and benefits.

INTRODUCTION TO THE FIELD

An example SFF process is the layered photopolymer process, stereolithography, which was introduced by 3D Systems in 1986. As shown in Figure 1.1, the process starts by scanning the surface of a vat of photopolymer with a UV laser that selectively hardens a portion of the top layer of the material in the vat. The platform with the attached portions is then dipped into the vat to create a fresh layer on top of the previous one. This new layer is then scanned with the laser. This process is repeated until a solidified part is fabricated and withdrawn from the vat.

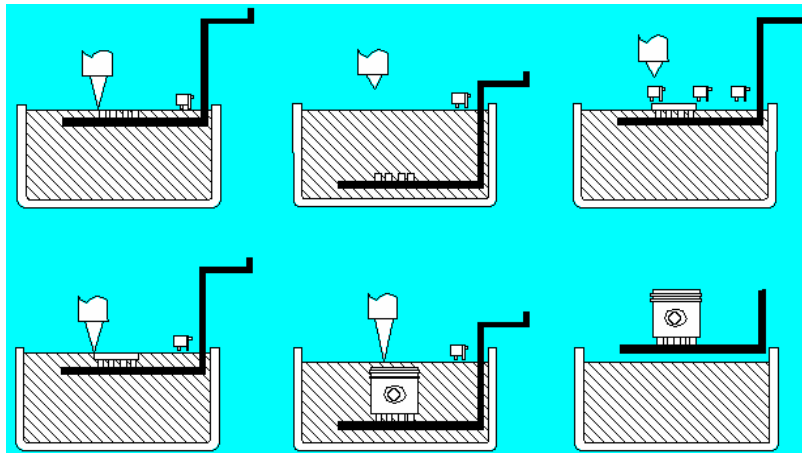

Figure 1.1. Schematic of stereolithography, a representative SFF photopolymer process. Liquid photopolymer is spread on the surface of a platform that is scanned by a light source to initiate gelation. These steps are repeated to build a part. Post processing may be needed to complete solidification.

The complexity that can be obtained from SFF parts is impressive, as demonstrated by Figure 1.2. This complexity comes at a very low cost as compared to other manufacturing processes such as machining.

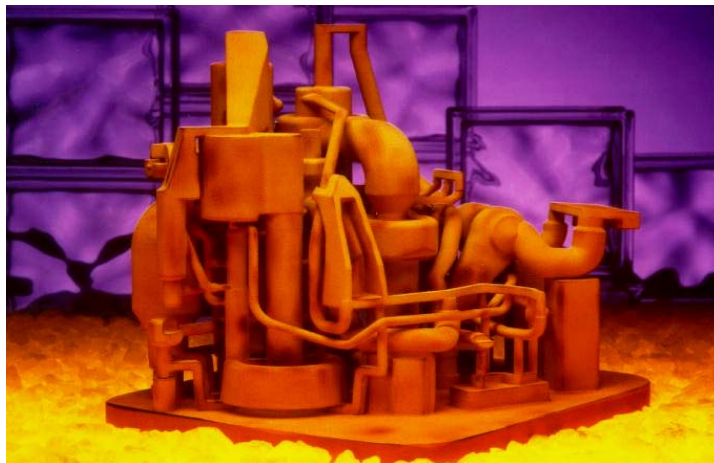

Figure 1.2. Complex SFF part created in a selective laser sintering process. (Courtesy 3D Systems)

The annual worldwide market for SFF systems was approximately \$500 million in 2002; there were approximately 10,000 machines installed worldwide, and the United States had approximately 40% of these systems (Wohlers 2003). A breakdown of the use of these machines is shown in the chart in Figure 1.3. As can be seen in this figure, direct manufacturing only represented 3.9% of utilization in 2003, but this is the area of most potential for growth in the technology.

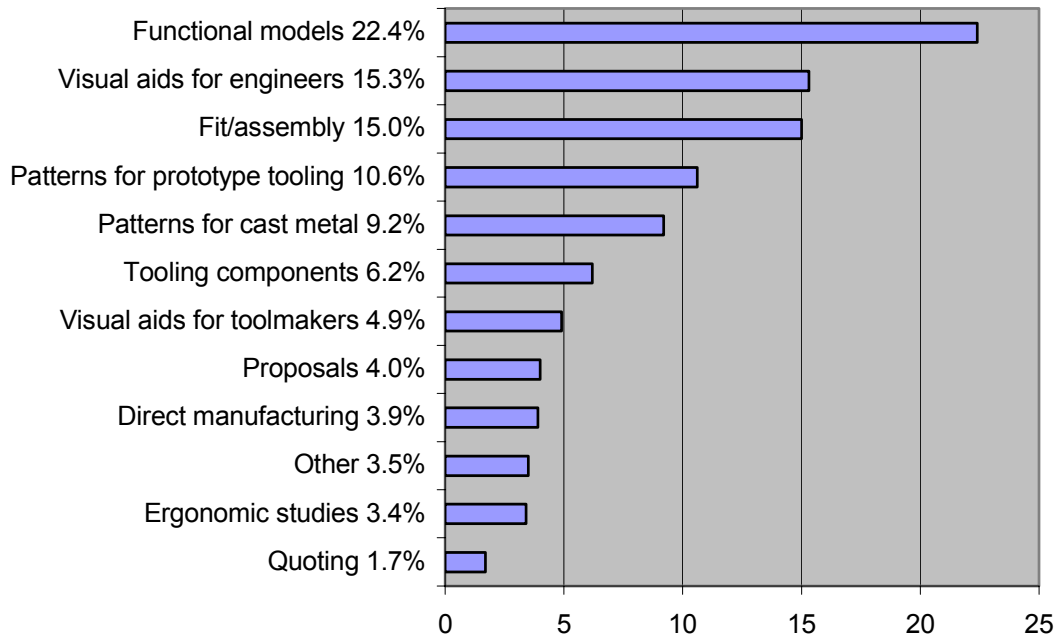

Figure 1.3. Uses of SFF parts. (data, Wohlers 2003)

An example of the potential for additive/subtractive processes in the direct manufacturing of parts is the use that Boeing Corporation is making of the technology. Boeing is making ducting and installing this directly into fighter aircraft. With this procedure, the company can drastically reduce part count (see also Chapter 3). Other examples include hearing aid shells being made by Siemens and the Invisalign® orthodontia system marketed by Invisalign.

METHODOLOGY

A preliminary workshop was held in Washington in the spring of 2003 with the panel chairman, prospective panel members, representatives from the sponsoring agencies, and the WTEC support team in order to finalize the membership of the expert panel (see below) and the scope of the study. During 20-24 October, 2004, the panelists conducted site visits in groups of two to three members to 15 sites in 5 European countries: Germany, Finland, the Netherlands, Sweden, and the United Kingdom (U.K.). The sites visited were primarily academic or research institutes and development companies. Several panelists also contributed observations based on public presentations and private meetings held at the Virtual and Rapid Prototyping (VRAP) international conference in Leiria, Portugal, from 1-4 October 2003. This report is based primarily on observations made by panelists during their site visits, but other input from panelists is included as well. All site visit reports, which were reviewed by the host organizations prior to publication of the report, are included in Appendix B.

The WTEC panel presented its findings concerning the latest additive/subtractive manufacturing research and development in Europe at a public seminar held on 2 December 2003 at the National Science Foundation in Arlington, VA. This report, the final phase of the study, details the final results of the WTEC panel's findings. It is available to the public on the Web at www.wtec.org/additive, as well as in print.

PANEL MEMBERS

The following experts served as panel members for this study:

Joseph J. Beaman (panel chair), University of Texas at Austin
 Clint Atwood, Sandia National Laboratories
 Ted Bergman, University of Connecticut
 Dave Bourell, University of Texas at Austin
 Scott Hollister, University of Michigan
 Dave Rosen, Georgia Institute of Technology

In addition, several sponsor representatives traveled with the panel:

Khershed Cooper, Office of Naval Research
 George Hazelrigg, National Science Foundation
 Kevin Lyons, National Institute of Standards and Technology
 Hassan Ali, WTEC

Finally, Fritz Prinz of Stanford University served as a senior advisor to the study.

SITES VISITED

The WTEC panelists visited sites in Europe from 1–4 October and from 20–24 October 2003. Table 1.1 lists the sites and the dates they were visited.

Table 1.1
Sites Visited in Europe

Site	Panelists	Date
Fraunhofer Institute for Laser Technology (ILT)	Bourell, Hollister, Cooper, Ali	22 October 2003
Fraunhofer Institute for Manufacturing and Advanced Materials (IFAM)	Bourell, Bergman, Cooper, Ali	20 October 2003
Fraunhofer Institute for Production Technology (IPT)	Bourell, Hollister, Cooper, Ali	22 October 2003
Freiburg Materials Research Center	Hollister, Bourell, Bergman, Cooper, Ali	21 October 2003
Helsinki University of Technology	Atwood, Beaman, Hazelrigg	24 October 2004
Imperial College	Hollister, Atwood, Beaman, Rosen, Hazelrigg, Lyons	20 October 2003
IVF Industrial Research and Development Corp.	Beaman, Atwood, Hazelrigg	23 October 2003
Loughborough University	Atwood, Beaman, Rosen, Lyons, Hazelrigg	21 October 2003
Manchester Materials Science Center	Rosen, Atwood, Beaman, Bergman, Hazelrigg, Lyons	22 October 2003
Polytechnic Institute of Leiria	Bourell, Rosen	1-4 October 2003
TNO Industries	Bourell, Hollister, Cooper, Ali	23 October 2003
University of Bremen, BIBA	Bergman, Bourell, Cooper, Ali	20 October 2003
University of Leeds	Bergman, Rosen, Lyons	24 October 2003
University of Liverpool	Bergman, Rosen, Lyons	24 October 2003
University of Nottingham	Rosen, Atwood, Beaman, Hazelrigg, Lyons	21 October 2003

REPORT OUTLINE

Following this chapter that introduces the scope of the study, its importance, and its general methodology, Chapter 2 describes the dominant types of commercial additive/subtractive (A/S) manufacturing methodologies and processes. Chapter 3 focuses on one of the panel's main interests: new advances and challenges in the use of A/S technologies for rapid manufacturing. Chapter 4 connects A/S manufacturing with materials and materials processing advances that are aimed at improving product quality and cost-effectiveness while minimizing environmental impact. Chapter 5 describes the state of development of process controls and metrics essential to effective A/S manufacturing systems. Chapter 6 relates the unique challenges and opportunities presented by important new biomedical applications of integrated A/S manufacturing. Chapter 7 lays out opportunities for A/S manufacturing related to energy systems and environmental considerations. The concluding Chapter 8 presents the panel's overall assessment of European activity in the field, along with its appraisal of future requirements for ongoing R&D in additive/subtractive manufacturing.

BRIEF SYNOPSIS OF THE STUDY

Early in the course of this study it became evident to the WTEC panelists that SFF manufacturing technology development was a priority at most of the sites visited and that teaming relationships were being established between university, industry, and government entities within each European country and, in many cases, across Europe. This paradigm was validated during a review of site reports from each of the site visit teams. The majority of the SFF research and development in Europe is focused on advanced development of existing SFF technologies by improving processing performance, materials, modeling and simulation tools, and design tools; the goal is to enable the transition from prototyping to manufacturing of end use parts. Additionally, there are several European efforts in applications development for limited production parts, and studies are underway to compare SFF techniques with traditional manufacturing processes. It is clear from the panelists' site visits that Europe's economic and political as well as scientific and manufacturing communities have recognized the potential of additive/subtractive technologies for rapid manufacturing. They are backing this up with considerable investment for research and development, infrastructure, and support — investment that challenges U.S. positions in the field.

REFERENCES

- Beaman, J.J., J.W. Barlow, D.L. Bourell, R.H. Crawford, H.L. Marcus, and K.P. McAlea. 1997. *Solid freeform fabrication: A new direction in manufacturing*. Dordrecht, Boston: Kluwer Academic Publishers.
- Prinz, F.B., C.L. Atwood, R.F. Aubin, J.J. Beaman, R.L. Brown, P.S. Fussell, A.J. Lightman, E. Sachs, L.E. Weiss, and M.J. Wozny. 1996-7. *WTEC panel report on rapid prototyping in Europe and Japan* (Vols. 1 and 2). Baltimore, MD: WTEC. Available from National Technical Information Service (NTIS), Springfield, VA (reports #PB97-162564 and #PB96-199583), or on the Web at <http://www.wtec.org>.
- Venuvinod, P.K., and W. Ma. 2004. *Rapid prototyping – Laser-based and other technologies*. Boston: Kluwer.
- Wohlers, T. 2003. *Wohlers Report 2003*. Fort Collins, CO: Wohlers Associates. (2004 update available; see <http://www.wohlersassociates.com/2004info.htm>.)

CHAPTER 2

METHODOLOGIES AND PROCESSES

David L. Bourell and Joseph J. Beaman

INTRODUCTION

Commercial rapid manufacturing processes are primarily additive types that can be broken into four broad categories: (1) photopolymers, (2) deposition (filament and inkjet), (3) lamination, and (4) powders (layered and sprayed). All processes were represented at the European sites visited by the WTEC panelists. Judging by equipment, the most popular commercial process was layered powder; ten of the fifteen sites visited had U.S. or German commercial layered powder machines. Five sites had inkjet deposition equipment. Among the fifteen sites, there was one of each of the following: a commercial machine for photopolymers, sprayed powder, and lamination. However, this distribution of commercial machines is inconsistent with industrial machine sales distributions. This is perhaps due to the sites' research and development emphasis, where equipment requirements include both flexibility and variability to accommodate research needs, as well as the potential to solve problems in visualization and manufacturing.

In terms of additive/subtractive processes and methodologies currently being researched and developed in Europe, advanced work is evident in the same four categories. Discussion in this chapter of rapid fabrication methodologies and processes is completed by a brief overview of computational development, including CAD modeling efforts, computational modeling and development, and application of physical modeling.

REVIEW OF COMMERCIAL ADDITIVE PROCESSES

Photopolymers

The photopolymer approach is characterized by layerwise conversion of a liquid photopolymer selectively to a solid or gel-like state by selective exposure to light (refer to the schematic of the process in Chapter 1, Figure 1.1). Three well-known commercial photopolymer machine vendors are 3D Systems (formerly DTM, United States), EOS (Germany), and CMET (Japan).

Deposition

In deposition processes, a material stream is deposited without point source heating, such that selectivity is governed by motion of the material stream. Figure 2.1a shows the concept for the *filament approach*. Here a polymer-matrix filament is fed into a heated nozzle that melts the polymer and flows it into position on the part. Figure 2.1b shows the concept for the *ink-jet approach*. Here, powder is deposited in layers, generally by rolling prior to selective spray of some form of adhesive using commercial ink-jet technology. The leading commercial vendor of filament machines is Stratasys (United States), and ink-jet machines are marketed by Solidscape (United States and the Netherlands), 3D Systems (ThermoJet™) and Soligen (United States; casting cores/patterns). These machines are the core of a rapidly growing market of concept

modelers, that is, relatively inexpensive machines designed to produce “look-and-feel” objects, in contrast to other high-end processes designed for rapid manufacturing of functional parts.

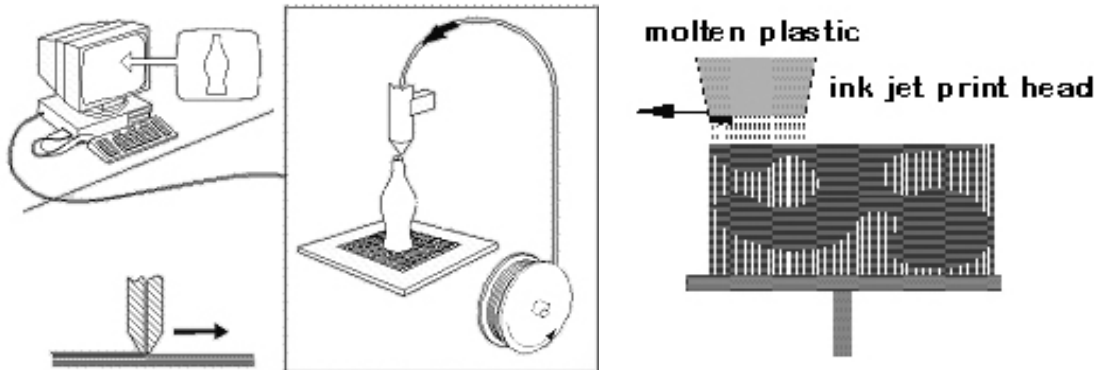

Figure 2.1. Schematics of deposition processes: (left) extrusion of heated filament; (right) inkjet with multiple printheads.

Lamination

In the lamination category of freeform fabrication processes, material is applied in sheet form. Process steps involve cutting of the cross-section in the sheet and attachment of the sheet to the build, not necessarily in this order. Figure 2.2 shows a concept setup for laminated object manufacturing (LOM) (Solidica and Cubic Technologies, formerly Helisys, United States). KIRA in Japan markets a PLT (pocket laser tachometer) stack-and-cut system.

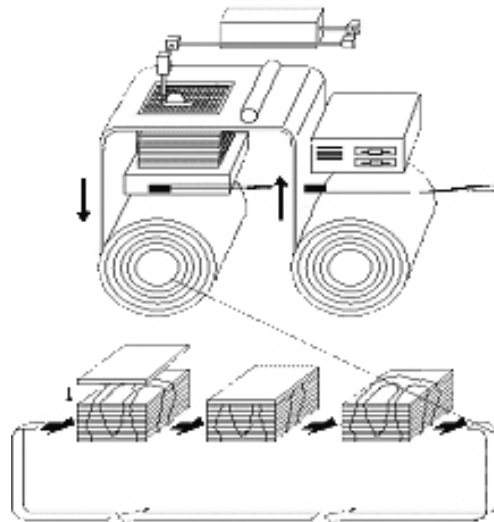

Figure 2.2. Schematic of a lamination process. Here, sheet is rolled into place, attached to the part build with adhesive, followed by cutting of the shape and waste parting lines.

Powder

The powder category of freeform fabrication processes centers around application of material in powder form and selective formation of the part by a localized heat source. Variations, illustrated in Figure 2.3, are *selective laser sintering*, in which powder is spread in a layer followed by selective scanning of a laser, and *powder spray*, in which powder is deposited locally, coupled with a scanning laser beam. Commercial producers of selective laser sintering equipment are 3D Systems and EOS. Powder spray commercial vendors are Optomec (United States, Laser Engineered Net Shaping or LENS™ technology) and AeroMet (United States, laser additive manufacturing or LAM process).

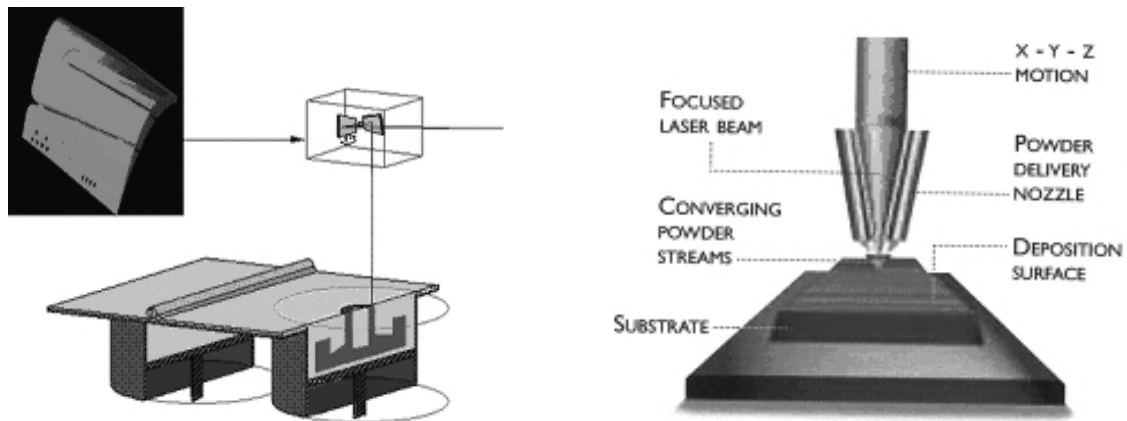

Figure 2.3. Schematics of powder processes: (left) selective laser sintering (3D Systems); (right) powder spray (Optomec's LENS™ process).

EUROPEAN ADDITIVE/SUBTRACTIVE METHODOLOGIES AND PROCESSES

Photopolymers

Perhaps the most advanced technology the WTEC teams encountered in Europe was the Envisiontec Perfactory photopolymer system. Shown in Figure 2.4, the machine had recently entered the stream of commerce at the time of the WTEC visits. The light source for photopolymerization presents to the polymer from the bottom of the build chamber, similar to the Japanese designs by Denken Engineering and Mitsui Zosen. Unique to the Perfactory is formation of the layer image using a 32 μm -resolution micromirror array. The digital mask contains 1280 by 1024 mirrors that are digitally controlled to allow various shades of light to expose the photopolymer.



Figure 2.4. Perfactory SLA photopolymer system by Envisiontec. (Envisiontec GmbH, Marl, Germany; from the Envisiontec website, www.envisiontec.de)

WTEC panelists saw two other photopolymer activities in Europe. *Metal Copy™* at the IVF in Sweden is illustrated in Figure 2.5. In this process — similar to 3D Systems' Keltool® process but using different powder, binder, and infiltrants — a stereolithography part is converted to a rubber mold. A metal slurry is cast and subsequently fired to produce a final metal article. Advantages over other processes are less shrinkage and use of a cheaper furnace.

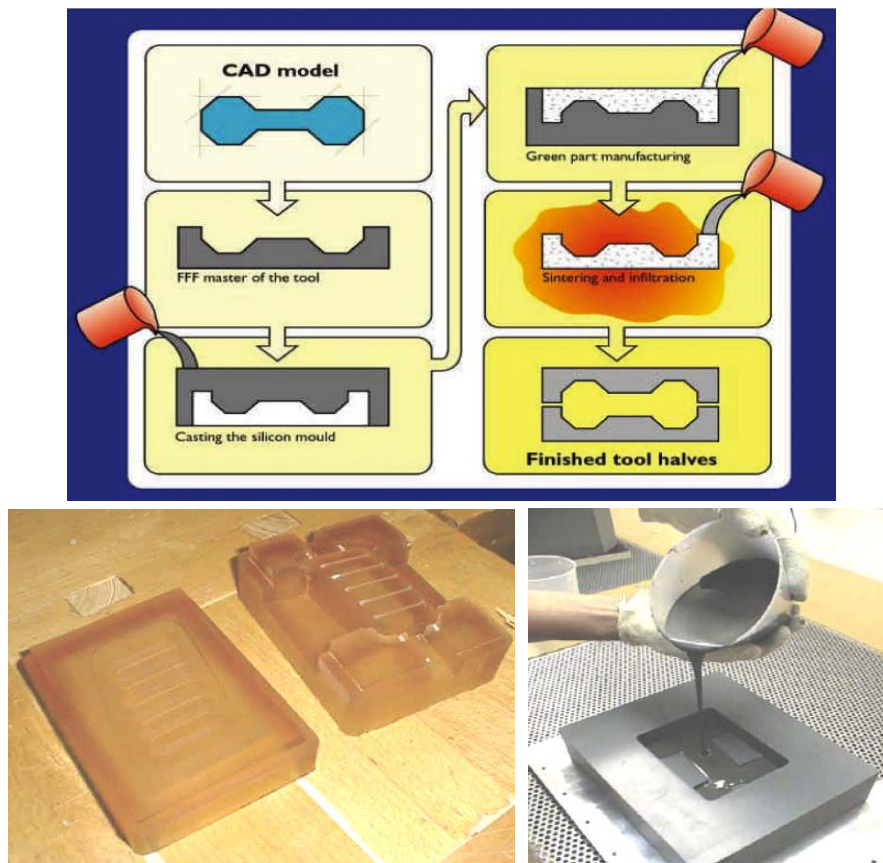

Figure 2.5. MetalCopy™ at the IVF (Sweden). Shown are (top) a summary of the process, (bottom left) stereolithography molds, and (bottom right) the metal slurry casting step.

The Swedish Ceramics Institute uses a Sanders *ModelMaker II* to produce molds used for direct slip casting and gel casting of ceramics. Latex binders have been developed that minimize cracking associated with drying during slip casting.

Deposition

Four European institutions have developed *filament-type* deposition systems. TNO (the Netherlands Organization for Applied Scientific Research) has worked extensively on the development of high-viscosity inks for fused deposition modeling. Details are proprietary, but the inks are about 20 times more viscous than commercially available ink-jetting inks. This opens the possibility for direct printing of liquids with larger solids contents and for direct printing of biological materials.

The University of Freiburg and Envisiontec have partnered in the development and marketing of the first commercially available machine for manufacture using biological materials. The 3D Bioplotter™, shown in Figure 2.6, uses a plotting component that is extruded through a nozzle into a reactive liquid of comparable density (see also Chapter 6, Figure 6.2). On contact, the two media react and form the object. A novel feature of the process is the balance of media densities, which allows parts to be created without the need for an ancillary support structure. The plotting medium may also contain chemicals that can serve to carry on reactions with the plotted material. The 3D Bioplotter™ also has the unique ability among commercial machines to plot live, viable biological cells within a hydrogel. Plotting of both osteoblasts and myoblasts with mitochondrial respiration assays demonstrated that the cells were viable. Freiburg has one 3D Bioplotter™ system, which is used inside a bio sterile hood in the Department of Oral/Maxillofacial Surgery for biomedical research. In summary, the 3D Bioplotter can use ceramics, polymers, and hydrogels.

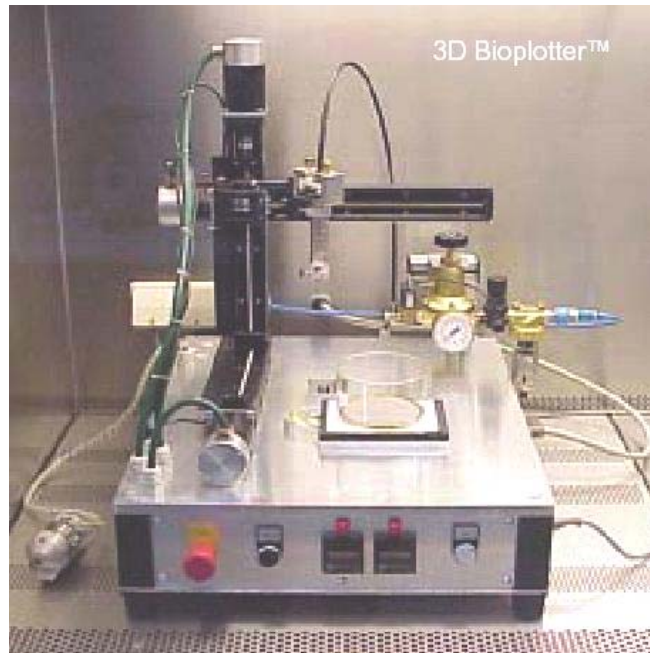

Figure 2.6. The 3D Bioplotter™, the current commercial version for layered manufacturing of biomaterials. (Courtesy Freiburg Materials Research Center)

The Bremen Institute of Industrial Technology and Applied Work Science (BIBA) at the University of Bremen in Germany has partnered with Professor Khoshnevis at the University of Southern California to advance contour crafting. A slurry with high solids content is extruded through a nozzle with a trowel fixture to produce parts with attractive surface finish, Figure 2.7. The principal drawback is geometric limitation in parts due to the need to accommodate the trowel geometry.

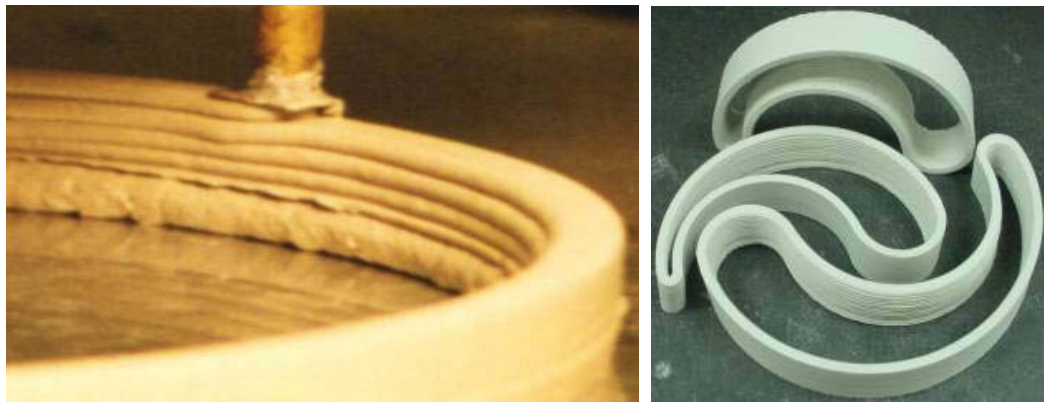

Figure 2.7. Close-up of contour crafting and sample parts. (Courtesy Prof. Koshnevis, BIBA, Germany)

There is significant European activity in the area of ink-jet deposition technology development. Fcubic in Sweden has an aggressive product development and marketing plan for an ink-jet ceramics machine, Figure 2.8. The process involves jetting a catalyst into a ceramic powder bed. Emphasis is on build speed with accuracy. The company goal is to build a 4-inch tall part in 6 minutes by 2012.



Figure 2.8. The fcubic inkjet machine and a ceramic part.

The Manchester Materials Science Center (MMSC, UK) has a sizeable effort in ink-jet additive manufacturing. Much current research is with loaded suspensions to fabricate ceramic parts. For these suspensions, loadings of greater than 40 percent are desired to minimize shrinkage during sintering. Even so, volumetric shrinkage of 20 percent is typical; the highest reported loading was 45 percent. Viscosities under 40 mPa are needed. Typical material compositions included waxes, kerosene oils, and surfactants, plus the loading powder. Ceramic materials being studied included alumina, PZT, and ZrO_2 . Equipment at MMSC to support jetting research includes two experimental printhead machines for fabricating parts, several printing stages with interchangeable heads, and several heads. One of the part-making machines is a Sanders machine modified for interchangeable heads. The other machine is a specially produced machine from Sanders that has a 4-jet head. MMSC has heads from Sanders and MicroFab Technologies (Plano, TX). The MMSC personnel report that they are very pleased with the MicroFab heads and systems. The Sanders printhead produces 100 μ m droplets and has very good repeatability.

TNO in the Netherlands has two research inkjet machines to support its research in high-viscosity (\sim 200 centipoise) ink development. The goals are improved solids loading and direct printing of biomaterials. Work is also ongoing in the area of grading composition.

New ceramic materials have been developed at the Freiburg Materials Research Center (FMF) for use in Z Corporation 3D printers. The system modifications include reduced quantities of material, reduced particle size, and utilization of chemical reactions, as well as physical binding of the ink to the powder. Applications are production of dental work and creation of biodegradable polyurethane scaffolds infiltrated with diisocyanate and catalyst.

The Fraunhofer Institute for Manufacturing and Advanced Materials (IFAM) in Bremen, Germany, is making some advances on specific commercial processes, including heating of powder beds in metal EOSINT SLS (selective laser sintering) systems for stress reduction, cooling of mirrors and lasers, etc. It is using 3DP (three-dimensional printing) for mold inserts incorporating conformal cooling for injection molding tooling and gradient compositions, e.g., adding carbon and carburize for surface hardness. Heating of the powder box and use of MIM powder (MIM Technik, Germany, www.mimtechnik.de/englisch/technologie0302.htm) are modifications to 3DP.

Work on laser-based electrochemical deposition is being pursued at the Laser Processing Research Centre at the University of Manchester (UK) Institute of Science and Technology (UMIST). The electrochemical deposition work is essentially local electroplating, where the laser controls the deposition pattern. A standard acid-copper electrolyte solution is used, in which a copper anode and stainless steel cathode are placed. The steel cathode acts as the deposition substrate. The electrolyte solution is heated to 333K to speed up the reaction rate. A potential of 20 mV, just under the threshold at which electroplating would occur, is applied. The laser scans over the steel substrate, providing enough thermal energy to cause the electroplating reaction

to occur. This work is similar to several other U.S. electrodeposition approaches. Microfabrica, Inc. (formerly MEMGen), developed and commercialized the EFAB® process (electrochemical fabrication), which utilizes multiple steps. Patterned deposits are created using masks and photoresist. Dan Schwartz at the University of Washington has developed an electrochemical deposition process that utilizes small electrodes mounted on XYZ stages to provide patterned deposits. Various compositions of nickel and iron can be deposited, where the iron-rich compositions are used as the part, and the nickel-rich compositions are used as support material.

Two related projects deal with deposition of fine particles. UMIST has successfully used direct-write technologies to deposit 20-nm titania on glass. Laser patterning is followed by heating to diffuse the oxide into the glass. MMSC has used the direct-write of conductors on polymer substrates, using a commercially available organometallic precursor liquid containing silver that is printed onto a polymer substrate and the solvent is allowed to evaporate. A heat treatment converts the precursor compounds and leaves silver traces. Interconnects and circuits have been produced in this manner; the traces were about 200 μm wide.

Lamination

Few methodologies and processes using lamination techniques were evident in the sites the WTEC teams visited. At the University of Nottingham, plates of varying thickness have been laser-cut, stacked, and either brazed or clamped to form molds. The advantage of variable thickness plates is the ability to minimize stair-stepping inaccuracies on low-slope surface features. Researchers at the University of Loughborough have used a cut and stack approach (Figure 2.9) in production of clamped polyurethane foam molding tools with internal conformal cooling channels.

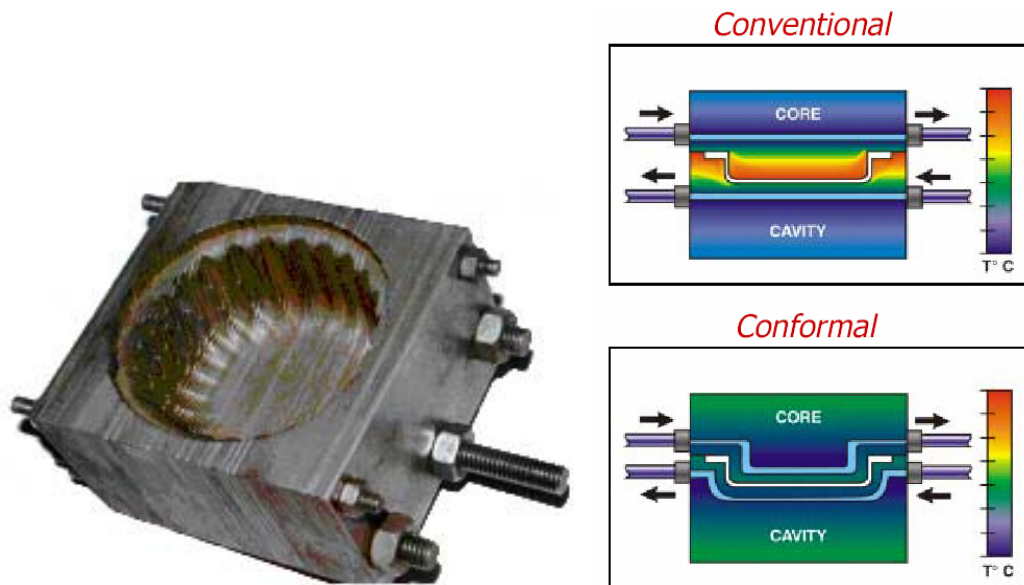

Figure 2.9. Cut and stack production tooling for polyurethane foam molding and thermal profiles, illustrating the benefits of conformal cooling channels. (Courtesy University of Loughborough)

The Bremen Institute of Industrial Technology and Applied Work Science (BIBA) in Germany has developed a physical process within its RAPTEC (Virtual Product Development and Rapid Technologies) project. The process involves die construction for sheet metal forming. Molds are created by clamping together shaped aluminum plates. BIBA has also developed a layered milling approach followed by deep-penetration electron beam welding to generate steel and aluminum articles, as shown in Figure 2.10. Here plates are on the order of 1 inch thick.

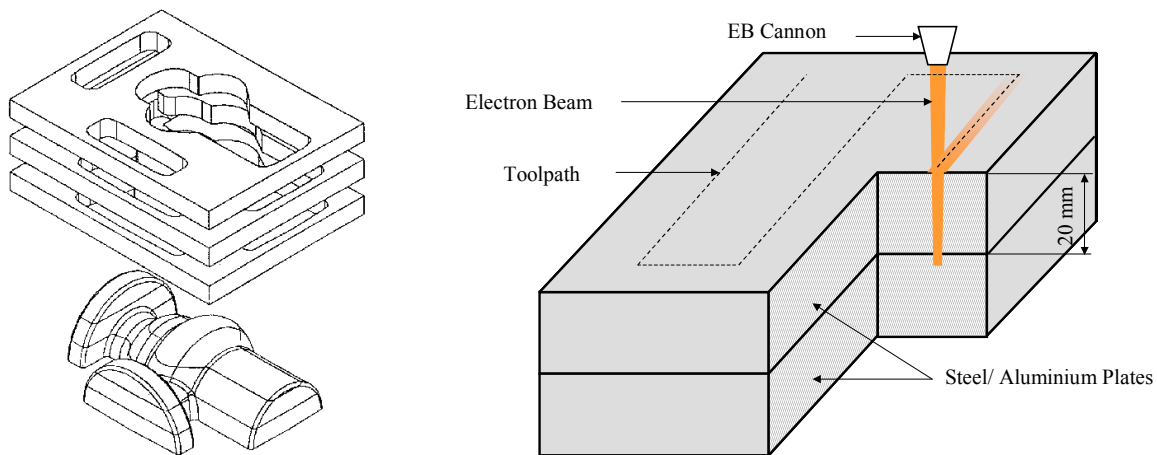

Figure 2.10. Laminated part construction at BIBA Germany by precision milling of thick plates, followed by electron beam welding.

Powder Systems

The two types of powder systems are *layered powders* and *sprayed powders*. The WTEC site visit teams reported on seven European layered powder projects. First is the layer-wise sintering of powder by the Swedish company Speedpart, shown in Figure 2.11. A mask is created using dry toner on glass (the technology is protected by U.S. Patent 6,531,086 B1). The entire layer is sintered using blanket irradiation through the mask. Beta machine production was anticipated in 2004.

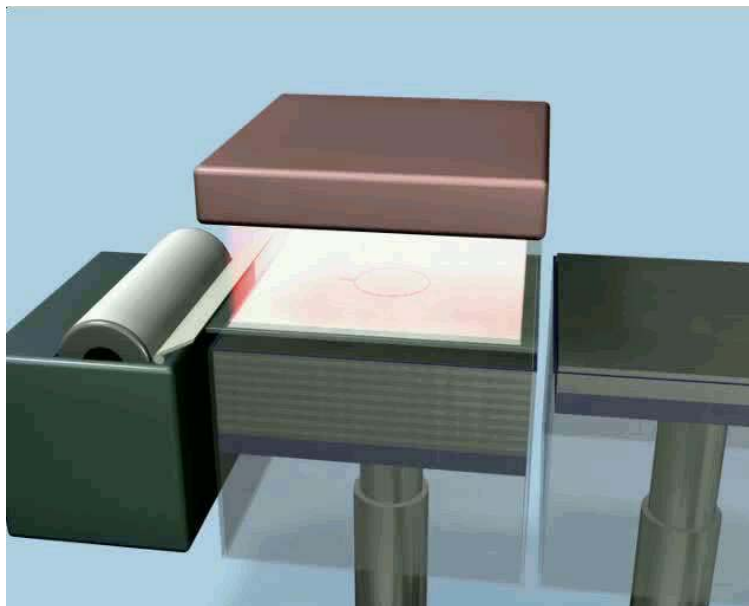

Figure 2.11. Rapid powder sintering (mask sinter process) by Speedpart (Sweden).

In Germany, the Fraunhofer Institute for Laser Technology (ILT) has developed a selective laser melting technique for direct production of metallic parts. Commercialized by TRUMPF (www.trumpf.com) and announced at Euromold 2003, the process, shown in Figure 2.12, is essentially direct selective laser sintering of metallic powder without the use of intermediate binders. Metal systems researched include Ti-6Al-4V, H11 tool steel, 316L stainless steel, and cobalt-chromium alloys for dental restorations. Part resolution is about 100 microns with reported surface finish on the order of 30-50 microns. Applications include functional prototypes, short run parts and molds, medical implants, and tooling inserts.

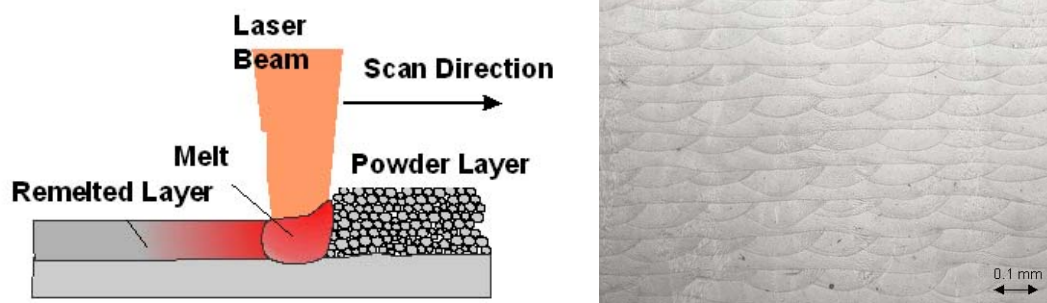

Figure 2.12. Direct selective laser melting of metallic powder at the Fraunhofer ILT, Aachen, Germany. The process is commercialized by TRUMPF.

EOS Finland has developed tool steel H20 for use in commercial EOS SINT M machines. Called direct metal laser sintering (DMLS), H20 parts such as those shown in Figure 2.13 are made with a layer thickness of 20 μm , dimensional accuracy of $\pm 50 \mu\text{m}$, and surface roughness after shot peening of 3-6 μm .

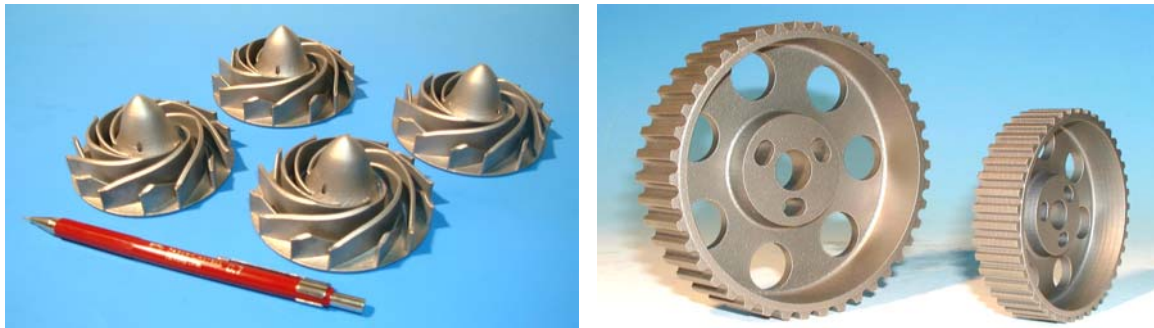

Figure 2.13. EOS direct metal laser sintered H20 tool steel parts: (left) complex helical shaped part; (right) straight-toothed gear.

Incremental improvements to the EOS DMLS process have been undertaken at the Fraunhofer IFAM in Bremen. Process improvements include heating of the powder bed with cooling of the machine optics. Lasertool is a ferrous tool material for DMLS. Applicable for mold inserts, Lasertool parts have 99% density, hardness greater than 320 Hv, and strength in the range of 800-900 MPa.

Arcam in Sweden has commercialized a layered powder additive process, electron beam melting (EBM), based on an electron beam heat source rather than a laser beam. The machine and a representative part are shown in Figure 2.14. Advantages of this process are direct production of fully dense metallic parts, an intrinsic atmosphere control, effective beam coupling to the powder bed without reflection, and use of high-speed magnetic scanners in lieu of mechanical scanners for lasers. To date, parts have been produced from Ti-6Al-4V, commercially pure titanium, low alloy steel, tool steel, and nickel alloys. In process improvements, Arcam has developed electron beam scanning patterns for control of the thermal distribution in a layer with the intent to control residual stress and part distortion.

TNO Industries in the Netherlands has developed materials for “micro-SLS” based on dispersions. The principle is casting or printing of dispersions, fusion after drying, and direct drying and fusion of aqueous dispersions. This can be done in one or two steps (drying followed by fusion or combined drying/fusion).

The Fraunhofer Institute for Production Technology (IPT) has performed extensive research towards ceramic part production via laser sintering; several parts are shown in Figure 2.15. The process involves production of zirconium silicate molds via selective laser sintering, followed by cleaning and casting of heat-resisting steel and nickel parts. Another application of ceramic laser sintering is production of spray metal patterns. A variety of ceramic patterns have been produced, including ZrSiO_4 , SiO_2 , SiC infiltrated with epoxy, Al_2TiO_5 , and Si_3N_4 . Ceramic sintered cores have also been produced by adding a ceramic slurry to laser sintered parts, followed by hand finishing.



Figure 2.14. Arcam electron beam melting (EBM) additive fabricator and a representative part.

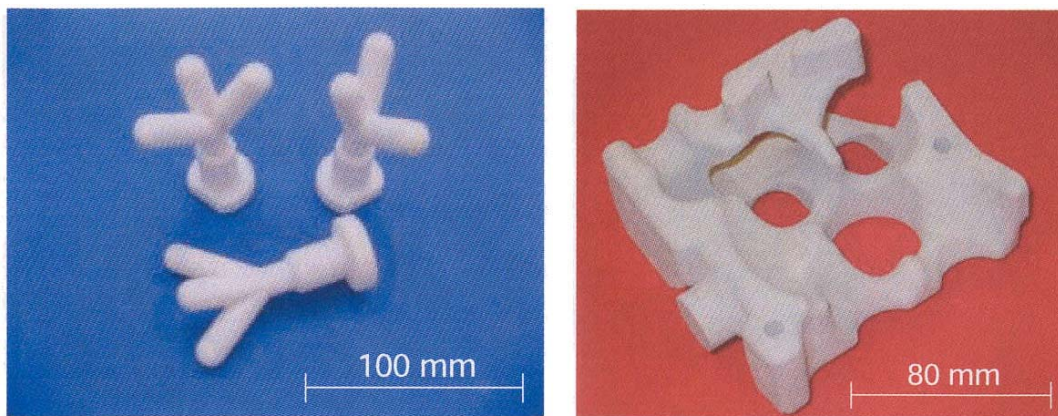

Figure 2.15. Ceramic laser sintered parts from the Fraunhofer IPT.

The WTEC site visit teams are aware of several European sprayed powder approaches to additive/subtractive manufacturing. Common to all is the deposition of powder in non-layerwise fashion followed by laser point heat-source fusion.

Rolls Royce is funding work at several institutions to develop a method for near net shape repair of worn turbine blade tips. The Laser Processing Research Centre at UMIST has determined that water atomized powder couples better to the laser than gas atomized powder, presumably due to the irregularities in the surface presentation to the laser. The group has done microstructural and surface finish analysis as well as modeling and path planning. The Rolls Royce University Technology Center (UTC) at the University of Nottingham is developing a common strategy for additive and subtractive manufacturing processes, with an emphasis on the repair of blades in engines. One project involves the repair of compressor blades using a combination of laser cladding and machining. UTC researchers developed a repair system that includes both manufacturing hardware and a flexible, integrated information software system. They reverse engineer a damaged blade, generate an STL file, and generate plans for depositing material and machining or grinding extra material to the final shape.

Two deposition strategies are being pursued at the Rolls Royce UTC: (1) adding a small amount of material exactly where it is needed, followed by finish machining or grinding as needed, and (2) adding a large amount of material without concern for accuracy, followed by machining to desired shape. The former approach is more efficient but relies on a very careful reverse engineering of the blade. This is challenging, since blades can have extensive local damage. Point clouds generated from scanning methods must be fit to

CAD models of the blade surfaces, which can be challenging for reverse engineering and inspection software. The latter approach is simpler to implement, but can require much more time-consuming finish machining.

Researchers at the University of Nottingham Institute for Materials Technology (UNIMAT) have taken a laser cladding approach to deposit metals and to build features. They use a diode laser from Rofin-Sinar (www.rofin-sinar.com/) that can produce up to 6 kW; they also use a 2.5 kW Nd:YAG laser. At the time of the WTEC visit, they expected soon to acquire a 2 kW CO₂ laser. Diode lasers are particularly suited for laser cladding because they have greater than 30 percent power efficiency, small size, and a rectangular spot (2 x 5 mm) caused by a lack of coherence among beams (multiple beams are produced by several diodes). Deposits are made by depositing powder into the laser spot or by using pre-placed powders. The diode laser has a wavelength in the 800-940 nm range. Cladding is performed in an inert atmosphere to prevent oxidation of the deposited metals. Cladding materials used at UNIMAT included P20 and stainless steels, titanium alloys, and nickel-based alloys. Substrate materials were typically carbon or stainless steel. Linear deposition rates of 175 mm/min were typical.

Three European institutions have developed LENS-type machines for laser welding of powder. The Lairds Laser Engineering Centre at the University of Liverpool has a machine capable of sustaining < 5 ppm of O₂ in an argon atmosphere. The deposited material (Ti-6Al-4V) is fully dense. Graded materials have been processed using this machine. Significant design efforts have been directed to improving the process by controlling the fluid mechanics and thermal aspects of the powder feed nozzles. Greater control over the process has been achieved, at least in part by adding powder feed nozzles, which in turn reduces the gas particle velocities to levels in which otherwise turbulent flow is converted to laminar flow.

The Fraunhofer IPT in Aachen has developed a process called Controlled Metal Build-Up™, shown in Figure 2.16. It is a combination of LENS net shape processing and three-axis high-speed machining. Feedstock may be in either powder or wire form. The process has been demonstrated in construction of injection molding tooling and for mold repair, as shown in Figure 2.17. Controlled Metal Build-Up was being commercialized by Albrecht-Roeders, Germany, but this effort was halted due to technical problems that were reported to include thermal cracking and non-automated machine control for the machining stage.

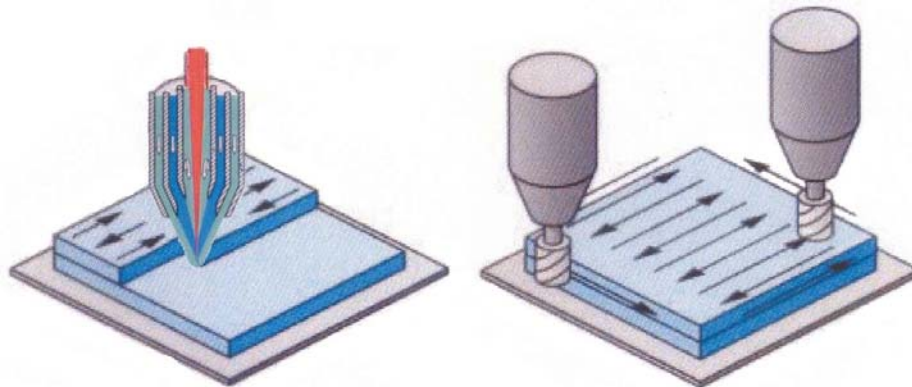

Figure 2.16. Schematic of Controlled Metal Build-Up at Fraunhofer IPT, Aachen, Germany, showing powder deposition followed by high-speed machining.

The Fraunhofer ILT in Aachen has developed a high-deposition laser spray technique called metal powder deposition (MPD). Deposition rates can reach 10 cm³/min. Applications are tools and molds (Co, Ni, ferrous alloys), aerospace applications (Ti, superalloys), and mold repair. Specific work at the ILT includes development of powder nozzles, oxygen control, and teaching software for mold repair. The main advantage of MPD over traditional LENS processes is the ability to create large parts at high speed in a variety of materials. Disadvantages are lack of part precision, limited geometries (including hollow parts), and unacceptable surface finish.

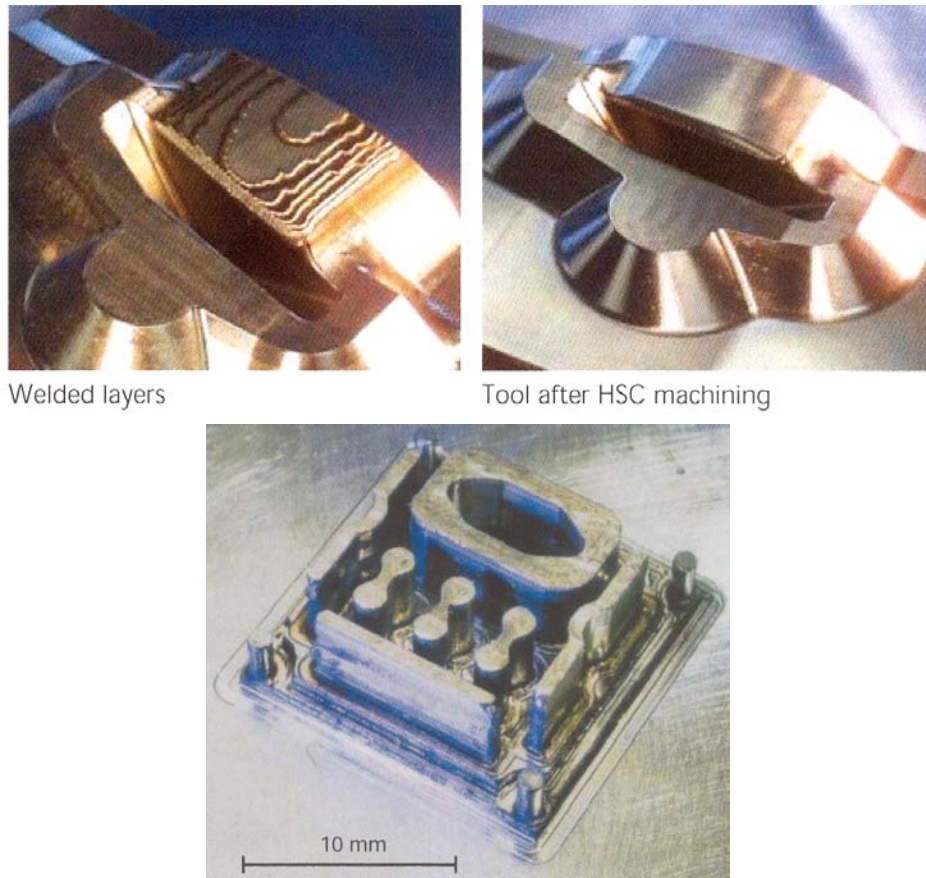

Figure 2.17. Representative parts produced using Controlled Metal Build-Up. Shown are part generation and repair after welding and machining. (Fraunhofer IPT, Aachen)

The University of Liverpool has a cold spray facility used for additive/subtractive manufacturing of aluminum parts. Particles are sprayed at velocities on the order of 1500 m/s without use of a heat source. Deposition rates are high, as much as 1 cm³/s. The kinetic energy is sufficient for welding to occur when particles impact a substrate. Researchers are using lower velocity particle streams to selectively abrade or machine the deposits to refine the geometry.

Other Additive/Subtractive Methodologies

Loughborough University researchers are working with additive manufacturing to create textiles. Figure 2.18 shows a representation of a simple textile design as well as a view of the texture of a finished garment produced using additive manufacturing. Goals of the research are to explore development of smart textiles with built-in functionality, to investigate the optimized design of complex textures and textiles at the elemental level for manufacture by additive techniques, to examine methodologies for blending and mapping of textures to CAD models for subsequent rapid manufacture, and to explore methodologies for the most efficient generation of textile macro assemblies from micro linkages. In addition to the textile work, this project is exploring the potential of fabricating enhanced textures for potential applications such as implants and micro heat exchangers.

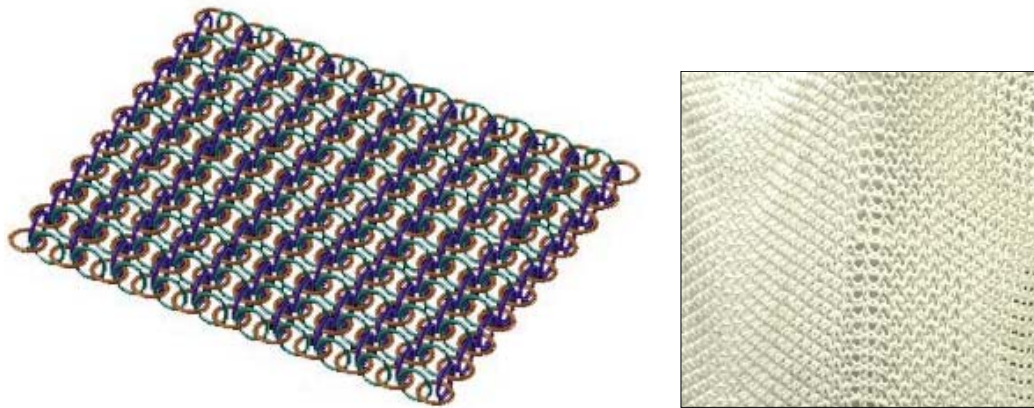

Figure 2.18. (Left) textile representation, and (right) actual fabric. (Courtesy Loughborough University)

Helsinki University of Technology has acquired a commercial machine, manufactured by Amino Corp. in Japan, for fabricating sheet metal parts. In this machine, represented in Figure 2.19, sheet metal is constrained in a fixture. A single point stylus deforms the plate to the desired shape prior to unclamping and trimming. Figure 2.20 shows an actual part production sequence.

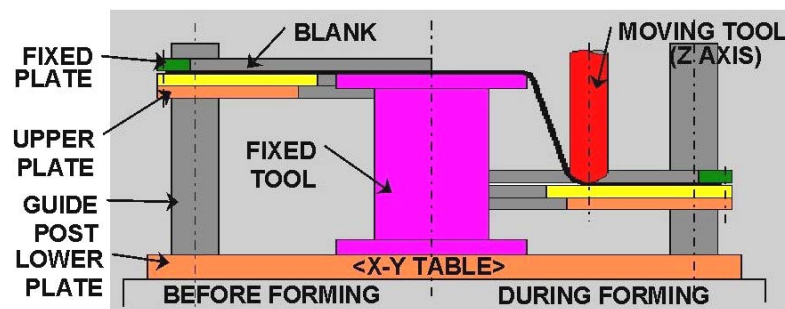

Figure 2.19. Schematic of the Amino Corporation sheet metal former, a dieless NC forming process.

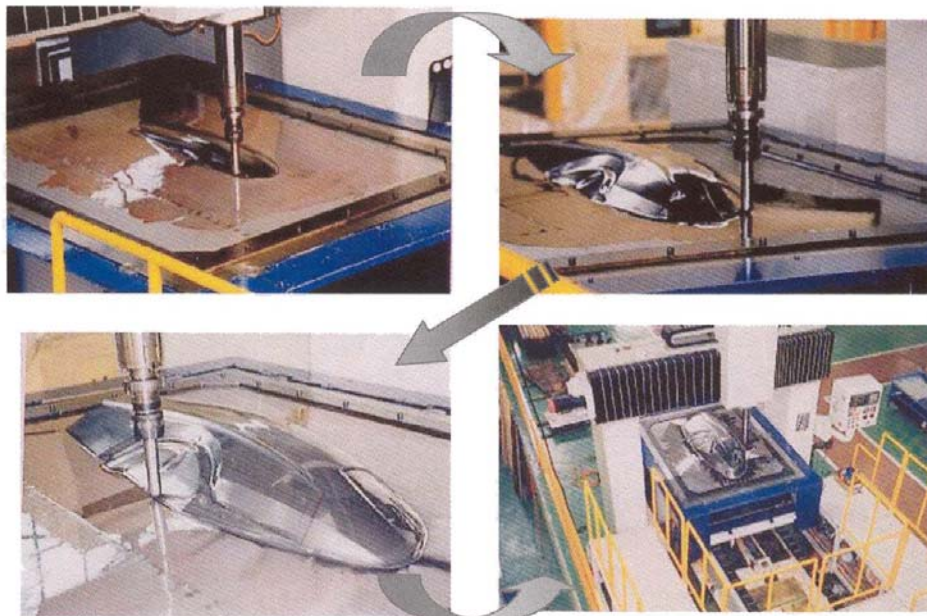

Figure 2.20. Actual dieless forming process using the Amino Corporation Sheet Metal Former.

Additive/Subtractive Manufacturing

Most processes being researched in Europe at the time of the WTEC visit were additive processes. Several discussed in this chapter were truly additive/subtractive. Table 2.1 summarizes these processes. The two principal groups of additive/subtractive processes were those that use some form of cut-and-stack technology and those that involve powder spray of some form with intermediate machining steps.

Table 2.1
European Additive/Subtractive Activity

Institution	Country	Activity
U. Liverpool	UK	Additive/subtractive cold metal spray
U. Nottingham	UK	Laser cut-and-stack of variable thickness plates for tooling; brazed or clamped and finish machined
BIBA	Germany	RAPTEC clamped Al sheet for sheet metal forming dies
BIBA	Germany	Electron beam welded stacked sheet with layer-by-layer milling
U. Loughborough	UK	Laminated production tooling for polyurethane foam molding
UMIST	UK	Laser cladding/machining for turbine blade repair (Rolls Royce)
U. Nottingham	UK	Laser cladding/machining for turbine blade repair (Rolls Royce)
TNO	Netherlands	Micromachining (150 mm), high speed machining, large scale machining
Fraunhofer IPT	Germany	Controlled Metal Build-Up

COMPUTATIONAL ADVANCES

Critical to advancement of additive/subtractive methodologies and processes is continued development of the computational aspects. European work in this area is reviewed in three categories: CAD, computational modeling, and physical modeling.

CAD

The main focus of CAD research in Europe appeared to be centered on stereolithography (STL) file generation, manipulation, and repair. DeskArtes representatives in Finland presented the company's 3D Expert, designed to convert and repair STL files. Specific features include repair of STL models, automatic/interactive operation, facet editing, 3D transformations, dimensioning, and separation/joining of connected components, bad components, faces, and parting lines. The application also can split models into multiple sections, decimate and triangulate, generate supports and slices, and eliminate thin triangles, as illustrated in Figure 2.21.

TNO Industries has developed a number of software tools to assist in various stages of the design and product development cycle. STL Draft Angulator™ is a design tool used to modify STL files to accommodate mold design issues. TNO's Flash TL Engineer™ is a mix of STL tools and 2D drawings. Presented at Euromold 2001, this software has been commercialised by CCIM (www.ccim.nl).

University of Nottingham researchers were pursuing precommercial CAD efforts as part of the Rolls Royce-funded turbine blade repair program. They reverse engineer a damaged blade, generate an STL file, and generate plans for depositing material and machining or grinding excess material to produce a final shape.

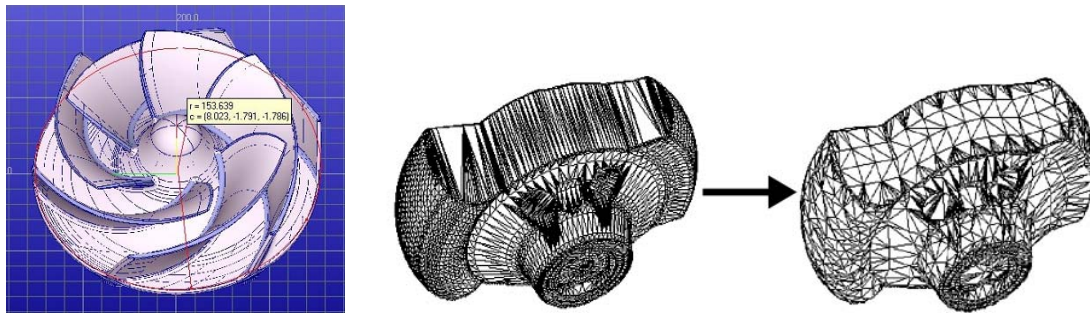

Figure 2.21. STL file representation using DeskArtes Oy 3D expert software, and example of retriangulation of an STL file.

Computational Modeling

BIBA Germany has developed rapid prototyping (RP) software. It is experience-based software for prototype design geared towards young designers. Features include optimization of the prototype strategy, fabrication method, and finishing operations as a function of the desired geometry, functionality, and surface finish. The software is commercialized as VisCAM RP by Marcam Engineering GmbH.

Research at the University of Loughborough includes study of footwear for athletes. Researchers there have developed methods for foot scanning and conversion to CAD models. There is interest in pursuing finite element analysis (FEA) of the scanned objects, computational determination of optimal orthodic design, and computerized placement of cleat studs.

Physical Modeling

Extensive thermo-physical modeling of polymers and some metals has been undertaken at the University of Leeds. Thermal finite element modeling of powder bed heat flows combined with models of (T, t) dependence of powder densification are combined with assumptions and experimental determination of material properties to complete the physical modeling effort, Figure 2.22. Process maps have been developed for stainless and tool steel processing. Figure 2.23 is a typical process map showing the dependence of metal melt zone morphology on processing parameters, laser power, and scanning speed. These results are significant, since they provide fundamental understanding of the issues and of the relationships between various product morphologies such as balling and high-aspect-ratio bead-like flow.

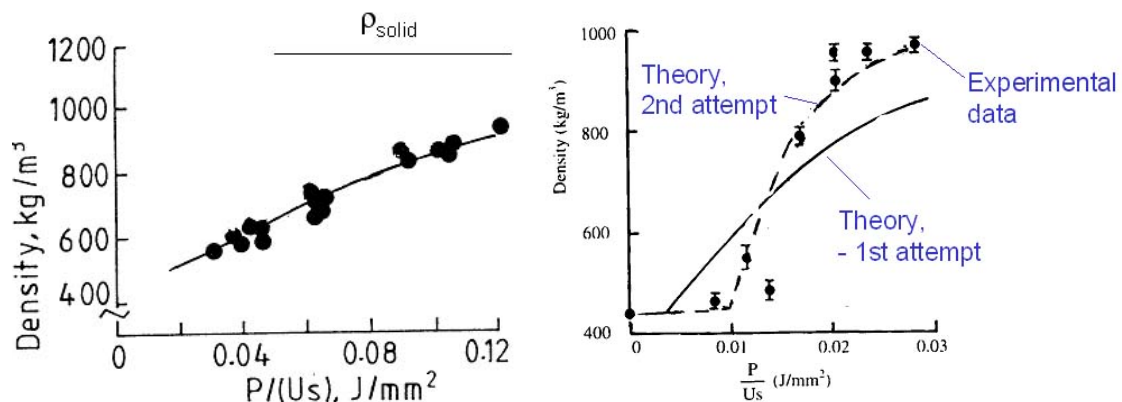

Figure 2.22. University of Leeds physical modeling of the density of (*left*) polycarbonate and (*right*) nylon and glass-filled nylon as functions of laser power P , scan speed U , and scan spacings. (From *Proc. IMechE Pt. B*, 215:1481-95 [2001])

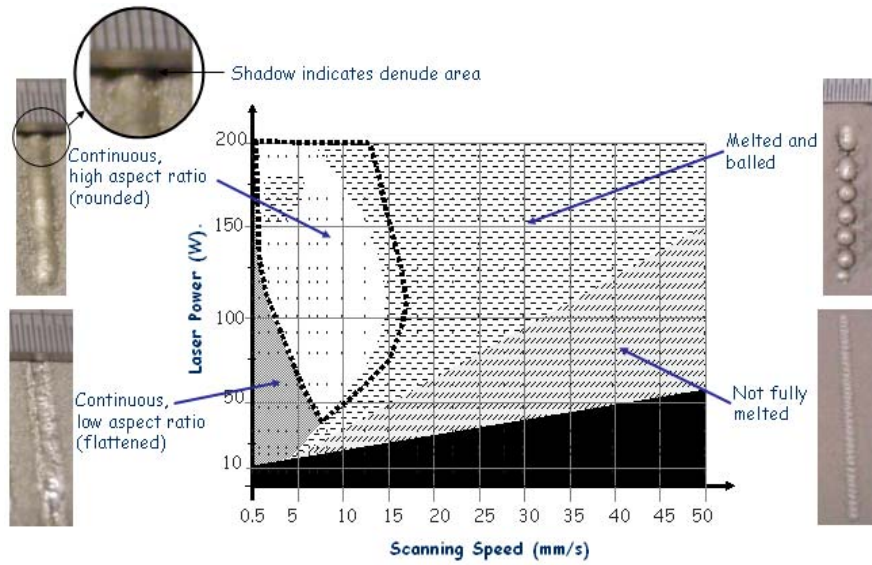

Figure 2.23. Typical process map showing the dependence of the metal melt zone morphology upon processing parameters such as laser power and scanning speed (Hauser, Childs, et al. 2003). The map indicates areas of undesirable melting, non-melting, bead-like flow, and flattened flow. The material is 314 HC stainless steel with a CO₂ laser spot size of 1.1 mm. (Courtesy Professor Childs)

The Fraunhofer IFAM is considering application of physical modeling in the creation of multiple-material graded compositions of carbon steel using Extrudehone's Prometal 3D Printer. The methodology is to use design tools to generate a strength and/or hardness profile in the part. A physical model would then convert the hardness profile into a carbon distribution in the steel. Using traditional binder and carbon-rich printheads, the part would be built with a graded carbon structure. Following heat treatment and sintering, a part with appropriate hardness gradients would be created.

The Manchester Materials Science Center (joint collaboration between the University of Manchester and the University of Manchester Institute of Science and Technology) has done extensive work in advancing understanding of jetted liquid droplets. The research group is pursuing the development of predictive models of ink-jet printing, in part due to the perceived limitations of the ink-jet industry. They believe that industrial technology is based on empirical results and that industry's predictive capability is minimal when deviating from normal operating conditions.

When printing, several phenomena are very important to the quality of the result. The shape of the deposited droplet is critical in forming 3-D structures as it affects resolution, precision, and accuracy. Droplet splash must be avoided. Jetting frequency must be coordinated with the print-head sweep velocity. As a result, there is an upper bound on build rate. Application of fluid mechanics theory has demonstrated that there is an important relationship between the Reynolds number ($\rho_g v d / \mu$) and Weber number ($\rho_l v^2 d / \sigma$) where ρ_g and ρ_l are the densities of the process gas and liquid drop, respectively. The variables v , d , μ and σ are the droplet velocity, droplet diameter, liquid dynamic viscosity and liquid surface tension, respectively. Empirically, it has been observed that these characteristics should satisfy $1 < Re / \sqrt{We} < 10$, which is the normal regime for drop on demand (DOD) printing.

An important limit was identified for jetting liquid materials. The UMIST researchers reported that droplets should not be smaller than 10 μm in diameter (about 1 picoliter), or their behavior after ejection from the printhead was not predictable enough for reliable printing. At sizes smaller than 10 μm , air resistance becomes a problem. If printing in a vacuum, to eliminate air resistance, the droplets tend to evaporate.

SUMMARY OF R&D ISSUES

Additive/subtractive manufacturing represents a robust collection of technologies whose processes and applications are continuously evolving and expanding into new areas. Described above and summarized here are ongoing research and near-term applications in the European research community.

Additive/subtractive manufacturing enjoys specific advantages over conventional manufacturing technologies, such as production of complex internal features, insertion of *in situ* sensors at locations impossible to reach once the part is produced, and minimal design constraints on part geometry. Changes to part geometry are easily affected. This enables mass customization with applications in the medical field such as custom biological scaffolds to assist in regeneration of living matter.

In conventional manufacturing, there is a relatively steep cost dependence on geometric complexity. In freeform fabrication, this is not the case, so utilization is favored by complex geometry coupled to short production runs. Tooling for conventional manufacture has historically been a desire, and a number of equipment manufacturers have developed strategies for creating production tooling.

Several long-term challenges exist in additive/subtractive manufacturing:

- First is the need to improve part surface finish. Current practice involves hand finishing. The trend is towards non-tactile post-processing techniques, but perhaps new processes will be developed that address this critical technological aspect.
- A second challenge is mesoscale and perhaps nanoscale object manufacturing. Examples are printheads and fiberoptic coupling devices, although success in this area would be expected to spill over into microelectromechanical systems and nanostructures.
- A third area of challenge particularly suited to the powder technologies is creation of novel microstructures for advanced engineering applications. Examples include directionally solidified components, parts with compositional gradients, and non-equilibrium microstructure.
- A final challenge is successful commercialization of a multiple materials machine. While some isolated success has been achieved in the research community, significant challenges remain in the area of material delivery and computational representation of compositionally graded structures.

BIBLIOGRAPHY

Wohlers, T. 2002, 2003, and 2004. *Wohler's report*. Fort Collins, Colorado: Wohlers Associates, Inc. (OakRidge Business Park, 1511 River Oak Drive, Fort Collins, Colorado 80525).

Laboratory for Freeform Fabrication. 1990-2003. Proceedings of the Solid Freeform Fabrication Symposium. Mechanical Engineering Department, University of Texas, Austin. (Available online at <https://utwired.engr.utexas.edu/lff/symposium/proceedings.cfm>.)

CHAPTER 3

MANUFACTURING ADVANCES, APPLICATIONS, AND CHALLENGES

Clint Atwood

INTRODUCTION

In Europe as well as the United States, the advanced development of both established and new additive manufacturing technologies aims to make their use pervasive for rapid manufacturing applications, supported by extensive infrastructure improvements. Loughborough University researchers define rapid manufacturing simply as “the use of additive manufacturing techniques to produce end-use parts in any number.” In addition, they underscore the need to manufacture, without tools, end-use parts of any geometry, in a variety of materials (plastic, ceramic, metal), including multiple materials and functionally graded materials. It was evident to WTEC panelists that in Europe, this is the goal of most rapid manufacturing R&D efforts.

OVERVIEW

At the majority of European universities, companies, and government research labs, additive/subtractive research and development is focused on the advanced development of now standard processes like selective laser sintering, stereolithography, fused deposition modeling, inkjet printing, and direct metal cladding. Given this focus, most efforts are in applied research rather than basic research, with a few exceptions. Additive, solid freeform fabrication (SFF) technologies are widely accepted throughout Europe and used primarily for conventional rapid prototyping applications (design verification and review, form, fit, function, patterns for casting processes, and vacuum molding).

Collaborations between universities, government research laboratories, SFF original equipment manufacturers (OEMs), and industry is common within individual European countries, as well as between countries in European Union (EU)-funded projects. An example of a multinational EU project is the NEXTRAMA Project, the European Network of Excellence on Rapid Manufacturing. NEXTRAMA is led by TNO (the Netherlands Organization for Applied Scientific Research) and funded by the European Union’s Sixth Framework Program. Its mission is to drive the growth of rapid manufacturing, based on additive SFF technologies, to an efficient and sustainable state. This is intended to occur through integrating and coordinating the main scientific, technological, industrial, and social elements in Europe by creating a permanent organization in the field of rapid manufacturing (RM). To fulfill this mission, a concerted effort is being planned, executed, and monitored by specific research units. The resulting exploratory work, knowledge, facilities, and experience sharing are expected to provide a clear definition of the primary development themes and the related research teams required to follow specific roadmaps to viable industrial solutions. NEXTRAMA is planned to last seven years. Funding levels of over \$1.68 million per year will provide funds for organization and management of the project. RM activities will receive additional funding or will be funded by other government or industry programs.

Consolidation of rapid prototyping service bureaus has occurred in Europe as it has in the United States. In less populated countries like Sweden and Finland, only a few service bureaus exist. Most European companies outsource their rapid prototyping to service bureaus, with some exceptions where volume, convenience, or proprietary work justifies the need for in-house activity.

Some universities supply rapid prototype parts to industry supporters through consortiums. Companies can leverage investments in technology development, and universities can offset the cost of maintaining functional labs and equipment. Figures 3.1a and 3.1b are good examples of the well-equipped and well-maintained facilities at Loughborough University.



Figure 3.1. Loughborough's rapid manufacturing lab: (left) processing lab; (right) CAD computer room.

SELECTED ADVANCEMENTS

Powder Bed Processes

Typically referred to as selective laser sintering (SLS), powder bed processing research and development is underway at several institutions in Europe.

Arcam

Arcam is developing and commercializing a powder bed process called Arcam EBM® that uses electron beam technology instead of laser-based technologies to melt powder and build up material layer by layer. An electron beam has the advantage over a laser beam of directly coupling into a metal powder bed without reflection and loss of energy. The electron beam can also be controlled without mechanical scanners, which potentially can lead to faster scan speeds. Arcam has fabricated parts from Ti6-4, commercially pure titanium, low alloy steels, tool steel, nickel alloys, and iron.

Fraunhofer Institute for Laser Technology (ILT)

Selective laser melting (SLM) is a powder bed direct metal process. Materials including Ti-6Al-4V, 316L stainless steel, tool steel, and cobalt-chromium alloys have been produced at the Fraunhofer Institute for Laser Technology (ILT). Its researchers believe they can produce materials with full density on their SLM machine. A commercial version of the ILT SLM machine was scheduled to be showcased by TRUMPF at the Euromold Conference in December 2003. Potential applications for this process include short-run parts, functional prototypes, and tooling. Specific research includes medical implants, dental restorations, complex hollow structures, tooling inserts, and tooling dies with conformal cooling channels. In addition to SLM, ILT is developing metal powder deposition (MPD) for high-volume-rate deposition, up to 10 cm³/min., five times faster than SLM. The advantage of MPD is fabrication of large parts from several different materials. Parts fabricated using MPD have coarser surface roughness and are less accurate than parts fabricated using SLM.

Helsinki University of Technology (HUT)

Rapid prototyping and manufacturing continues to evolve in Finland, focused primarily on applied research and applications development. HUT works with Electrical Optical Systems (EOS) and industry partners to develop applications for EOS' powder bed processing machines (see Applications, this chapter).

University of Leeds

University of Leeds researchers are working on several biomechanical applications using the SLS process. Project areas include bioactive glass ceramics topics such as infiltration with biopolymers, presurgical planning, and bone replacement materials. Other areas of development include materials research in ceramics, multiple materials, functionally graded materials, and thermal controls (powder bed heating, etc.)

Liquid Curing Processes*Envisiontec Perfactory System*

The Perfactory system (see also Chapter 2) uses a photopolymerization process based on successive layers of masking and curing.

Polytechnic Institute of Leiria (IPL)

Researchers at the Polytechnic Institute of Leiria (IPL) in Portugal are working on a process called stereo thermal lithography. Similar to stereolithography, it uses two-photon photopolymerization rather than the single-photon polymerization used in stereolithography. For this process, two lasers are used: an ultraviolet laser (UV) activates a photoinitiator, while an infrared laser locally heats the resin inducing thermal initiation. Applications for this process include making parts from polyester.

Injected Powder Processes*Fraunhofer Institute for Production Technology (IPT)*

Controlled metal build-up (CMB) at the Fraunhofer IPT is an injected powder process with a machining step after each layer to control accuracy and surface roughness. The CMB process also has an optional wire feed system that can be used instead of powder feed. CMB also uses high powered diode lasers as the energy source for creating the molten pool. High speed three-axis milling is performed after each built-up layer. Work continues to automate the CNC machining process and improve the translation from CAD solid model files. Fraunhofer IPT is working on the CAD interface issues. (The German company Rödgers initially commercialized the process, but it is reported that it no longer makes this machine.)

Fraunhofer ILT

The Fraunhofer ILT has developed an injected powder direct metal machine and has fabricated a variety of parts for tooling from materials such as Co, Ni, Fe-based, and tool steel. Its researchers have also fabricated parts for aerospace applications from titanium and other superalloys. This process uses a 2 kW, Nd:YAG laser as the power source, along with a powder feed mechanism and an x-y-z table to move the part. Additionally, they have developed teaching software for the process and have performed thermal modeling of the process for process optimization.

University of Nottingham Institute for Materials Technology (UNIMAT)

Researchers at UNIMAT are using a diode laser for direct metal fabrication of difficult-to-process materials (see Figure 3.2). This process is similar to processes developed and commercialized in the United States, such as Laser Engineered Net Shaping (LENS™) and others. The unique aspect of the UNIMAT effort is that it uses a diode laser instead of a CO₂ or Nd:YAG laser. Diode lasers are reported to potentially be more cost-effective and efficient than other laser systems.



Figure 3.2. UNIMAT's diode laser cladding machine.

University of Manchester Institute of Science and Technology (UMIST)

Researchers at UMIST are comparing the use of gas atomized powder to use of water atomized powder for metal cladding. Gas atomized particles tend to have spherical, smooth surfaces. Water atomized powders are elongated, with rough, dimpled surfaces. Due to these characteristics, water atomized powders appear to be less reflective and absorb more laser energy than those that are gas atomized. Parts fabricated using water atomized powders appear to have less layer thickness and finer surface roughness, by a factor of two.

Printing Processes

Manchester Material Science Center (MMSC)

Approximately 15 researchers are involved in jetting research within the MMSC, led by Brian Derby. Their primary focus is drop-on-demand (DOD) methods rather than continuous jetting. They have explored a wide range of polymer, composite, and filled materials. In addition to materials and processing research, the group is developing predictive models to determine limitations of ink-jet printing processes.

Extrusion Processes

TNO Industries

Researchers at TNO in the Netherlands are using fused deposition modeling (FDM) technology to create biological scaffolds for growing heart tissue, spinal discs, and orthotics.

Spray Metal Processes

UNIMAT

UNIMAT has a project to develop a technology known as Cold Spray. Briefly stated, this technology involves spraying solid particles at high velocity onto a substrate. The impact of the particles on the substrate causes plastic deformation. UNIMAT reported depositions of aluminum and titanium. This research is similar to technology developed in the former Soviet Union and at Sandia National Laboratories in the United States. Ktech Corporation is commercializing the Sandia-developed technology.

In addition to Cold Spray, UNIMAT is developing a high velocity oxy-fuel (HVOF) thermal spray process. This is a novel method for applying high performance coatings. This process is typically used to apply abrasion- and wear-resistant coatings, such as tungsten-carbon-cobalt and aluminum-tin materials. A primary application for this technology is applying a lubrication and fatigue-resistant coating on journal bearings (e.g., for the main rotor axes of helicopters).

Selected New Research and Development Processes

Loughborough University

Ultrasonic consolidation (UC) is a new process under development at Loughborough University. This research combines ultrasonic seam welding and layered manufacturing processes using Solidica's Formation 2436 process. Advantages of UC processing compared to fusion processes are that the welds are produced at half the fusion temperature of most metals. The process can use materials considered hazardous in powder form, such as aluminum, magnesium, and titanium. The process requires no special environment for processing, like shield gas or vacuum, and there is no special preparation for foils prior to welding. During the UC process, localized shear forces break-up of oxides, and pressure creates internal stresses at the interfaces to set up elastic/plastic deformation and diffusion. Weld strength is dependant on amplitude of oscillation, weld speed, and contact pressure. At the time of the WTEC team's visit, the primary application for this process was tooling, but in the future it could be smart structures. The basic functions of the process and an illustration of the research platform are shown in Figures 3.3 and 3.4.

Laminated production tooling development and process characterization is another project at Loughborough. It is a cut and stack process for fabricating tooling with conformal channels. Researchers are investigating the performance characteristics of laminated production tools, including effects of tool temperature on part properties and eliminating the need for release agents in injection mold tools. Initial results indicate that laminated tooling with conformal cooling channels can be fabricated in less time and at lower cost than using conventional cast methods.

Bremen Institute of Industrial Technology (BIBA PPC)

BIBA PPC has developed a process called "RAPTEC" for making dies for sheet metal forming. The dies are formed by clamping together individually shaped aluminum sheets. The laminated die is then used to stamp functional parts.

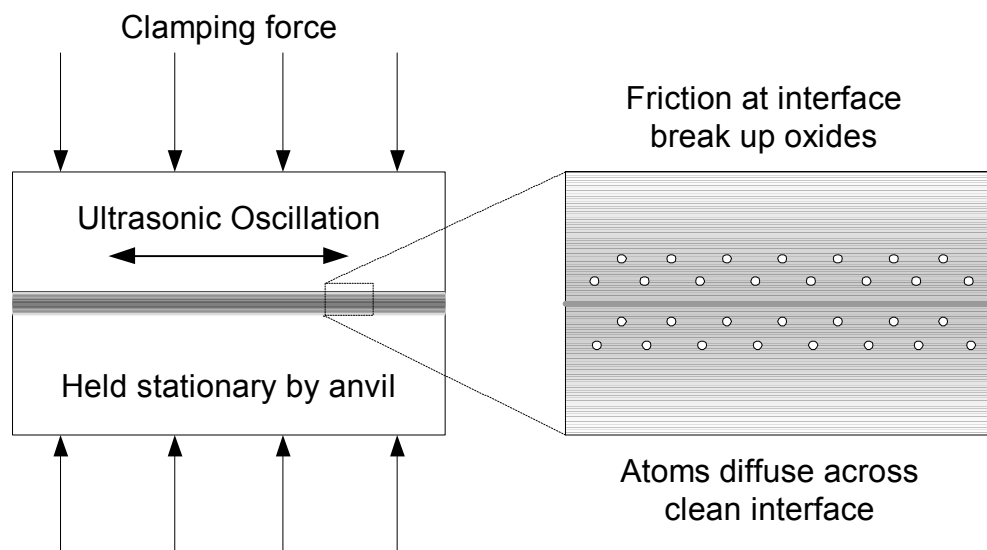

Figure 3.3. Transformation of material during the ultrasonic consolidation (UC) process.

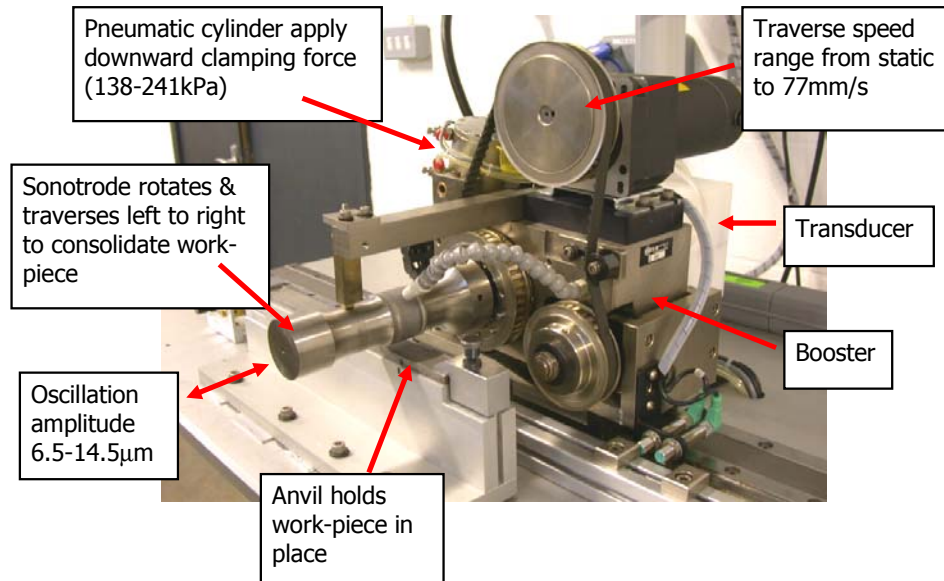

Figure 3.4. The UC research platform at Loughborough.

Summary of New Commercial Additive Technologies

- *Arcam EBM®* (Sweden) – the first commercial electron beam process; Arcam sold first-generation machines for ~\$550 thousand
- *Envisiontec Perfactory System* (Germany) – uses microscale stereolithography
- *Envisiontec 3D Bioplotter* – developed at Freiburg Materials Research Center (FMF)
- *Controlled Metal Build-Up (CMB)* – initially commercialized by Röders, although it no longer makes the machine
- *Selective Laser Melting (SLM)* – commercial version showcased at Euromold 2003 by TRUMPF
- *Speedpart* – toner on glass mask process; beta machines expected in 2004 (Sweden)
- *Amino Corporation* – sheet metal forming process (Japan)
- *MetalCopy™* – indirect production tooling (similar to KelTool™), developed by IVF (Sweden)
- Various third-party software packages, including
 - *VisCAM RP* optimization software (Marcam Engineering GmbH)
 - *DeskArtes* - View Expert and 3D Data Expert visualization software

APPLICATIONS

Conventional applications using rapid prototyping processes are commonplace in Europe, including patterns for investment casting; form, fit, and function; metal prototype parts; sand casting molds; and bridge tooling. New materials and processing techniques have facilitated new applications, including textiles (clothing); turbine blade repair; dental implants; custom hearing aid shells; ceramic patterns for thermal spray buildup; parts with functionally graded materials; parts consolidation; and free form fabrication of sheet metal parts. Figures 3.5 and 3.6 (see also Figure 2.14) show several excellent examples of parts fabricated using additive fabrication processes and illustrations of designs that exploit the manufacturing versatility of these processes.

(A) Conventional Duct fabricated from Vac Formed plastic
Part Count = 16 (plus glue)

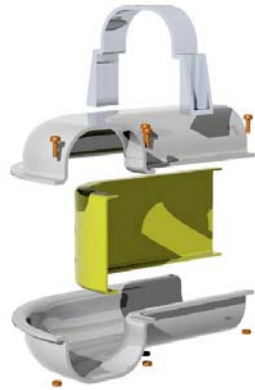

(B) Component modified and consolidated for fabrication via Additive Rapid Direct Manufacture
Part Count = 1



Figure 3.5. Rapid manufacturing design: An example of reducing part count from 16 parts to 1 part. (Courtesy, Loughborough University Rapid Manufacturing Research Group)

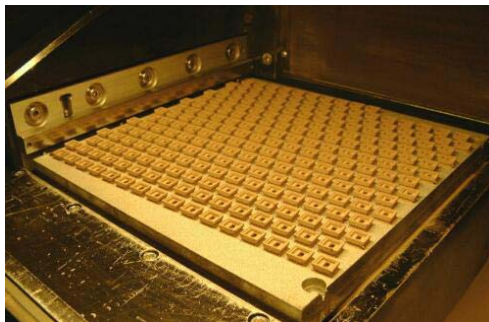

(left) Computer lock parts in production quantity, (right) Complex metal part

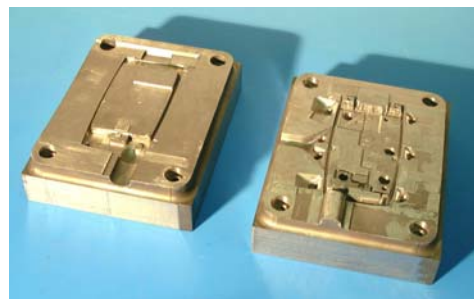
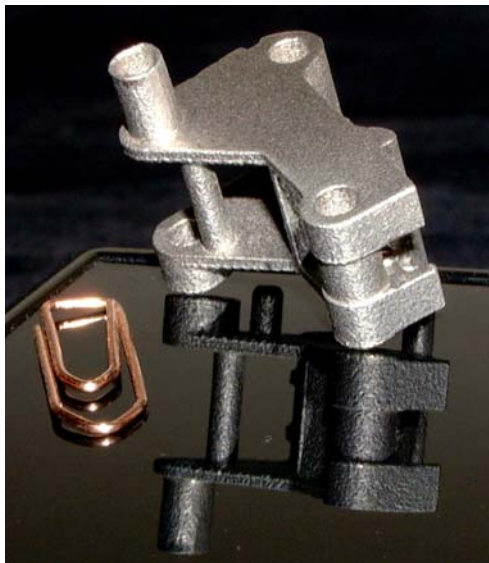

(left) Power hand tool part, (right) Core and cavity of pressure die-cast tool

Figure 3.6. Examples of parts and tooling fabricated using the EOS Direct Metal Laser Sintering (DMLS) process. (Courtesy EOS and Helsinki University of Technology)

Micro-level Design: Textiles

One of the unique applications for RM/RP processes is the fabrication of textiles from various materials and of various repetitive geometries (see Figure 5.3). The arduous process of designing the CAD model and the machine commands to produce the textile exemplifies the difficulty of using existing CAD modeling tools for complex geometries. RM processes have the potential for changing how textiles are manufactured, especially for custom one-of-a-kind garments made from nontraditional materials. The potential advantages of using RM processes in textile fabrication are that they are fully automated and can create smart textures that have added functionality.

High Speed Sintering for Production Quantities

The Rapid Manufacturing Research Group at Loughborough has a project looking at the commercial reality of fabricating production quantity parts using commercial-off-the-shelf RP processes and comparing them to traditional manufacturing techniques like plastic injection molding. The chart in Figure 3.7 illustrates the results of the study and compares quantities and cost for various RP technologies and a CNC machined tool. The example in Figure 3.7 is for the part depicted in the inset of the figure.

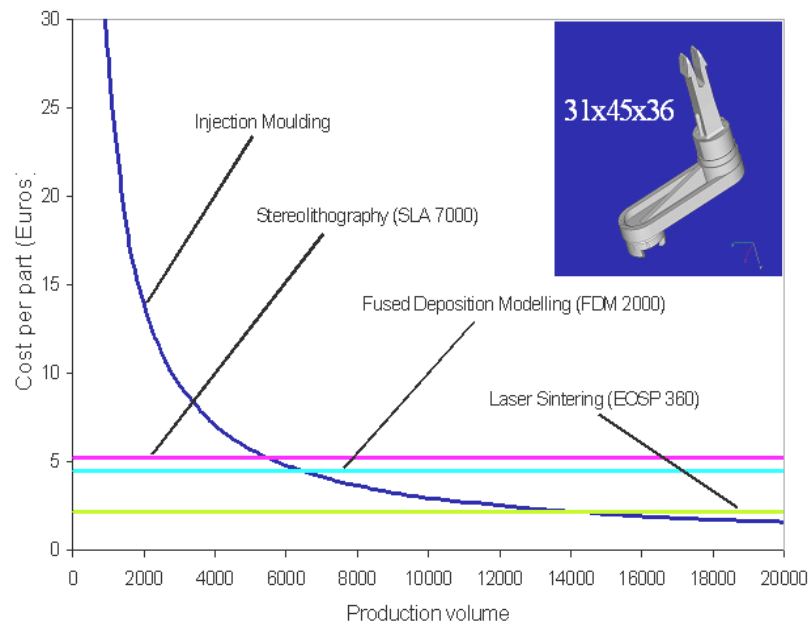

Figure 3.7. High speed sintering process: commercial reality of rapid manufacturing. (Loughborough University 2000)

CHALLENGES

Some of the challenges to the growth of additive technologies in manufacturing, identified during the WTEC panel's European site visits, could be classified in three distinct areas: culture, technology, and business.

Culture

- Most designers develop products based on traditional manufacturing methods.
- Manufacturing/production engineers are reluctant to implement new technologies.

Technology

- CAD tools are limited by the current feature-based, solid model approaches that have difficulty modeling the complex shapes and material structures that SFF technologies can fabricate.

- There continues to be an overwhelming need for new materials development and validation of existing materials for fabricating production quality parts.
- Speed of processing multiple parts is still not comparable to traditional manufacturing processes, with few exceptions for very small parts.
- Processing envelopes are limited to small- and medium-sized parts.
- True multi-axis capability for injected powder systems is elusive.

Business

- “Niche” applications must leverage the unique strengths of SFF technologies, rather than chase broad market applications.
- New additive processes and capabilities require creative and knowledgeable marketing.

CHAPTER 4

MATERIALS AND MATERIALS PROCESSING

Theodore L. Bergman and David L. Bourell

INTRODUCTION

Development of new materials for use in additive manufacturing is being pursued continuously in Europe as well as in the United States. Many of the materials that were used commonly prior to the 1996 WTEC study on rapid prototyping (Prinz et al. 1996-7) have been improved or replaced by alternatives that offer enhanced performance. Use of the ideal material will result in final geometries that have high definition and surface finish; have excellent mechanical, electrical, electromagnetic, chemical, or thermal properties that meet or exceed those of conventionally processed materials; are cost effective; and are environmentally benign.

Advances in the development of structural materials continues at a steady pace; this aspect of additive manufacturing is more mature than evolving areas such as additive fabrication of devices that are composed of or include biological matter. Biological materials are covered in Chapter 6.

LITERATURE REVIEW

A relatively large number of reviews of nonbiological materials used in additive manufacturing have been published since the 1996 WTEC rapid prototyping report; several of these reviews are listed in Table 4.1 and are also included in the References list for this chapter. The reviews in Table 4.1 are broadly categorized in terms of the *type of material* of primary interest (polymer, metal, ceramic, other) and the *particular manufacturing method* (stereolithography, selective laser sintering, fused deposition modeling, ink-jet or 3D printing, or other). In general, these materials reviews

- focus on specific materials that are relevant to a variety of additive manufacturing methods, corresponding to columns in Table 4.1
- deal primarily with specific manufacturing methods, along with an overview of various materials used in conjunction with these methods, corresponding to rows in Table 4.1
- provide in-depth expositions of specific manufacturing methods using specific types of materials, corresponding to single entries in Table 4.1, and/or
- present overviews of the physical behavior of various types of materials that may be relevant to an array of manufacturing methods, including additive manufacturing

It is impossible to cover all the recent advances in materials development relevant to additive manufacturing in detail here. This chapter will feature several contemporary developments that are representative of advances in the field since 1996. Most examples are from the WTEC panel's visits to the sites in Europe.

Table 4.1
Materials and Materials processing for Additive Manufacturing, Review Articles, 1996-2003

Technology	Metals	Polymers	Ceramics	Other
Stereolithography (STL)		Calvert 1998	Sigmund 2000	
Selective Laser Sintering (SLS)	Beaman 1997	Beaman 1997	Beaman 1997	
	Das 2003	Calvert 1998	Sigmund 2000	
	Kumar 2003	Kumar 2003		
Fused Deposition Modeling (FDM)		Calvert 1998	Sigmund 2000	
Ink-Jet or 3D Printing	Calvert 2001	Calvert 2001	Calvert 2001	Calvert 2001
			Heule 2003	
			Sigmund 2000	
Other	Poulikakos 1996	Calvert 2001	Beaman 1997	Sachs 201
	Armster 2002		Calvert 2001	Hague 2001
	Magee 1998		Heule 2003	
	Duty 2001		Tari 2003	
			Poulikakos 1996	
			Armster 2002	
			Duty 2001	
			Sigmund 2000	

MATERIALS DEVELOPMENT

Cements for Printing

Commercially available materials for use in 3D printing are prone to poor water resistance, which is problematic for applications including biomedical processing. To overcome this, the Freiburg Materials Research Center (FMF) is developing several interesting materials, such as the cement shown in Figure 4.1.

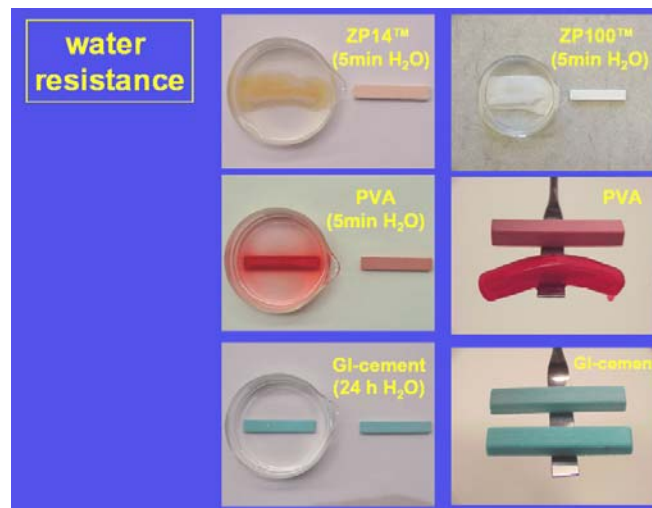

Figure 4.1. Water resistance of newly developed glass ionomer cement (*bottom*) and two commercial materials for 3D printing. Dissolution of the materials in water is shown on the left, while the pre- and post-submersion sagging behavior is shown on the right. Note the water resistance and retained geometrical and structural integrity of the new GI cement material. (Pfister and Mülhaupt 2001).

This GI (glass ionomer) cement is chemically rather than physically bonded during processing; its water resistance is shown qualitatively in the bottom row of Figure 4.1. Comparison is made to several conventional materials (ZP14 starch, ZP100 plaster, and PVA). As evident from the illustration, the GI cement retains its structural definition, even after significant time submersed in liquid water. This particular cement powder consists of three reactants (84.64% Ca-Al-silicate-glass, 14.5% polyacrylic acid, and 0.86% tartaric acid), while the ink is 85% water, 10% I-propyl alcohol that acts as a flow enhancer, a humectant (5% glycerol), plus a retarder and surfactants. A comparison of the post-processed modulus also indicates improved properties associated with the GI cement (2000 MPa) relative to the PVA (59 MPa), ZP14 (330 MPa) and ZP100 (1400 MPa) samples. Additional water-resistant materials, including zinc cements, are being developed at FMF (Pfister and Mülhaupt 2001).

Metal Powder

An example of new metal powders is taken from the University of Manchester Institute for Science and Technology Laser Processing Research Center. Here, the material is 316L stainless steel, and a comparison of the performance of two powders, synthesized by two different techniques, has been reported (Pinkerton and Li 2003). Specifically, conventional gas-atomized 316L particles are shown on the left of Figure 4.2, while water-atomized particles of the same material are shown on the right of the figure. The mean diameters of both types of particles are approximately 100–200 μm , but the water-atomized particles consist of fundamentally different topology. More important, the residual chemical species of the two materials is slightly different due to the different atomization media. The cost of synthesizing the gas-atomized powder is reported to be four times that of the water-atomized material.

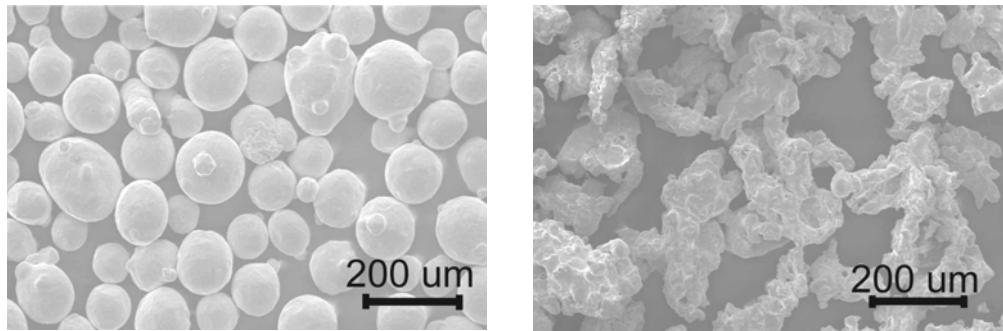

Figure 4.2. Gas-atomized (*left*) and water-atomized (*right*) 316L stainless steel powder. (Pinkerton and Li 2003)

Side views of test specimen formed by laser heating and sintering (melting) using the two different types of particles are shown in Figure 4.3. The processing conditions and initial powder layer thicknesses, as well as the number of powder layers for both cases, are identical. Clearly, the specimen associated with use of gas-atomized particles is of relatively high porosity and has a vertical surface roughness approximately twice that of the water-atomized particle object.

While the nonspherical shape of the powder has an effect on the laser-material coupling and sintering dynamics, the dramatically different behavior of the two powders is attributed primarily to the difference in trace species induced by the two atomization methods. Specifically, the dependence of the liquid metal's surface tension upon temperature is reversed for the water-atomized powder, leading to convection currents within the melt that are in the opposite direction relative to those in the melt pool for the air-atomized material. The flow reversal leads to deeper penetration of the liquid into the underlying solid structure for the water-atomized powder, and superior layer-to-layer bonding relative to that of the more expensive gas-atomized matter.

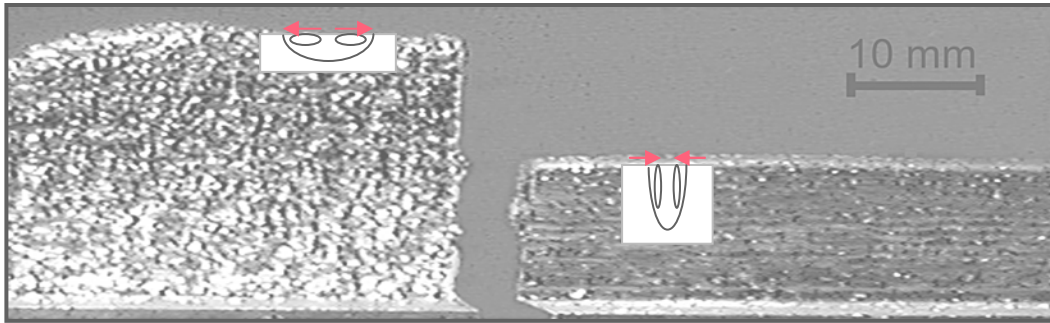

Figure 4.3. Laser-clad layers of 316L using gas-atomized particles (*left*) and water-atomized particles (*right*). The higher density structure (*right*) is attributed to reversal of Marangoni convection in the melt pool due to slightly different chemistry of the powder associated with the atomization method. The surface tension-driven convection is shown qualitatively in the inserts. (Courtesy Professor L. Li)

Metal Processing

Important and recent developments in metals processing are being made at Arcam AB, Sweden, in which fully dense parts are built from metal powder. The technology is based on electron beam melting (EBM), and the parts are built by melting the metal in a layer-by-layer manner. Advantages of using an electron beam as the energy source, as opposed to laser processing, include very small spot sizes ($\sim 100 \mu\text{m}$); very high beam-material coupling efficiencies, high scanning speeds (up to $\sim 1 \text{ m/s}$); and achievement of beam deflection without the use of moving mirrors. Although the material must be processed in a vacuum, which increases system cost, use of extremely low processing pressures minimize the adverse effects of impurities such as oxides and nitrides and allows for processing of refractory materials. A schematic of the Arcam system is shown in Figure 4.4.

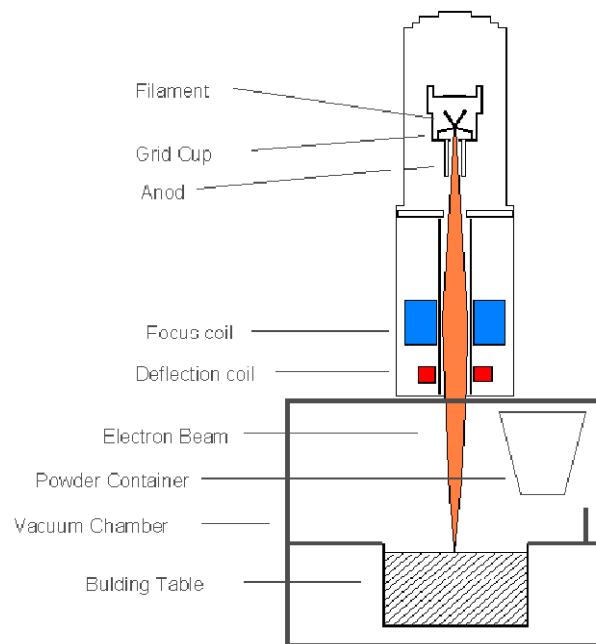

Figure 4.4. Schematic of the Arcam electron beam melting (EBM) system. The electron beam is generated in an EB gun, and the beam is deflected to the top of the powder layer by two magnetic fields. The first acts as a magnetic lens and focuses the beam to the desired diameter. The second deflects the focused beam to the desired location. (www.arcam.com)

The maximum build size of the Arcam EBM system measures $200 \times 200 \times 160 \text{ mm}$, with a reported accuracy of $\pm 0.3 \text{ mm}$. According to company literature (www.arcam.com) the company is developing and

refining various metal powders in collaboration with several academic, governmental, and private organizations. The process has been verified for tool steel, low alloy steel, alloyed titanium, commercially pure titanium, and nickel alloys. Mechanical properties of samples fabricated of the two materials, Ti6Al4V and H13, are shown in Table 4.2.

Table 4.2
Mechanical Properties of Alloyed Titanium and Tool Steel (www.arcam.com)

	Ti6Al4V	H13
Hardness	30-35 HRc	48-52 HRc
Tensile Strength (Rm)	930 MPa/135 ksi	1300 MPa/190 ksi ~1500 MPa/220 ksi after heat treatment
Yield Strength (Rp0.2)	880 MPa/ 125 ksi	1000 MPa/ 144 ksi
Modulus	128,000 MPa	210,000 MPa
Elongation	> 10 percent	N.A.

A large drill bit fabricated of H13 tool steel and its associated microstructure are shown in Figure 4.5. The H13 has a fully martensitic structure with a typical grain size of 10-30 μm .

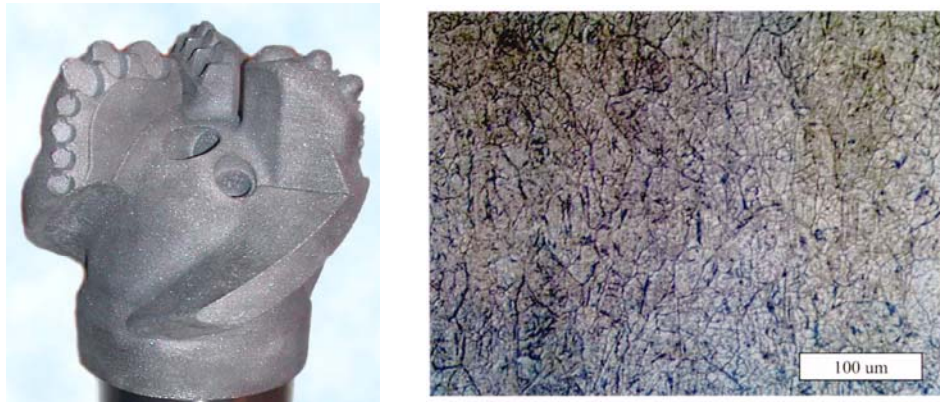

Figure 4.5. A fully dense drill bit (H13 tool steel) and the associated microstructure processed with the Arcam electron beam melting system. (www.arcam.com)

As of June 2003, eight Arcam EBM units had been built. Four machines were at the company in Sweden, two were at other companies in that country, one was in Italy, and one was at North Carolina State University, where it was being used to fabricate metal orthopedic implants (Harrysson et al. 2003). In mid-December 2003, the company announced the sale of a unit to an unidentified automotive manufacturer for delivery in 2004 (www.arcam.com).

Ceramics

Notable advances in ceramics processing have been made in the past decade or so. An excellent and timely review of additive manufacturing of small scale devices using ceramic powders is Heule et al. (2003). “Top down” approaches such as direct writing methods, ink-jet printing, microextrusion, and lithography-based methods are discussed, along with more fundamental “bottom up” methods such as self-assembly for synthesis of micro- and nanoscale ceramic materials.

Figure 4.6 shows a two-dimensional structure fabricated of ZrO_2 by ink-jet printing with a $170 \mu\text{m} \pm 10 \mu\text{m}$ resolution (Zhao et al. 2002). The inks, with a solid loading of 14 volume percent, possess unusual

rheological properties, leading to new challenges in process design. This particular ink was dispensed using a Xaar XJ500 printhead.

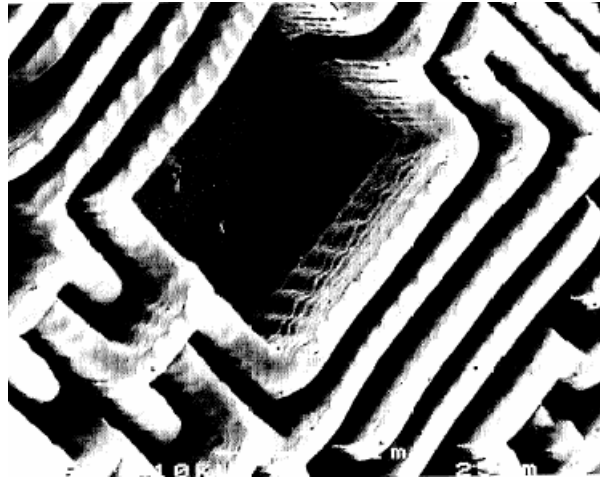

Figure 4.6. Ink-jet printed, two-dimensional ZrO_2 structure with $170\ \mu m$ resolution. The distance between the outer vertical surfaces of adjacent walls is approximately 1 mm. (Zhao et al. 2002)

Smay et al. (2002) have used a microextrusion technique to fabricate three-dimensional structures consisting of layers of stacked gratings formed from various colloidal suspensions including, for example, polyethyleneimine-coated silica microspheres, as shown in Figure 4.7.

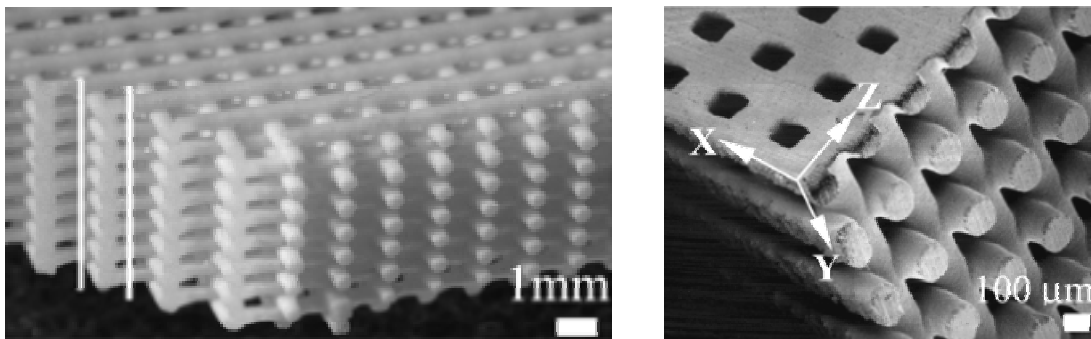

Figure 4.7. Three-dimensional structures fabricated by direct ceramic ink-jet printing. The optical image is shown on the left; the SEM scan showing details is shown on the right. (Smay et al. 2002)

The design of these ink delivery systems is challenging, due in large part to the unusual rheologies of the working fluids and the small length scales associated with the processing (see, for example, Grida and Evans 2003). Several reviews of the fundamental fluid mechanics and heat transfer aspects associated with similar technologies are available (Poulikakos and Waldvogel 1996; Armster et al. 2002).

Several of the meso- and microscale powder-based ceramic processes reviewed by Heule et al. (2003) are highlighted in Table 4.3.

Table 4.3
Overview of Microfabrication Processes with Ceramic Powders (Heule et al. 2003)

Method	Resolution (μm)	2D/3D structures
Microstereolithography	2	3D
Co-extrusion	5-16	3D
Ink-jet printing of suspensions	70	2D
3D printing (binder solution into powder)	200	3D
Microopen writing	250	3D

SUMMARY

Recent developments of new materials, as indicated by numerous reviews in the scientific literature, apply to use of a variety of additive manufacturing methods. Several novel metal and ceramic materials are being explored and commercialized in Europe as well as in the United States. It is worth noting that the development of new polymeric materials is not as robust as that of new metals and ceramics. This is probably due to the relative maturity of the use of additive methods for rapid prototyping, as opposed to methods for rapid manufacturing. It is impossible to include all of the exciting recent advances in materials development in additive manufacturing. The interested reader is encouraged to consult the hundreds of interesting references contained within the reviews included in this chapter.

REFERENCES

- Armster, S.Q., J.P. Delplanque, M. Rein, and E.J. Lavernia. 2002. Thermo-fluid mechanisms controlling droplet based materials processes. *International Materials Reviews* 47:265-301.
- Beaman, J.J., J.W. Barlow, D.L. Bourell, K.L. Wood, R.H. Crawford, H.L. Marcus, and K.P. McAlea. 1997. *Solid Freeform fabrication: A new direction in manufacturing*. Norwell, MA: Kluwer.
- Calvert, P. 1998. Freeforming of polymers. *Current Opinion in Solid State and Materials Science* 3:585-588.
- Calvert, P. 2001. Inkjet printing for materials and devices. *Chemical Materials* 13:3299-3305.
- Cawley, J.D. 2003. Solid freeform fabrication of ceramics. *Current Opinion in Solid State and Materials Science* 4:701-711.
- Conley, J.G., and H.L. Marcus. 1997. Rapid prototyping and solid free form fabrication. *Journal of Manufacturing Science and Engineering* 119:811-816.
- Das, S. 2003. Physical aspects of process control in selective laser sintering of metals. *Advanced Engineering Materials* 5:701-711.
- Duty, C., D. Jean, and W.J. Lackey. 2001. Laser chemical vapour deposition: Materials, modelling, and process control. *International Materials Reviews* 46:271-287.
- Grida, I., and J.R.G. Evans. 2003. Extrusion freeforming of ceramics through fine nozzles. *Journal of the European Ceramic Society* 23:629-635.
- Hague, R., I. Campbell, P. Dickens, and P. Reeves. 2001. Integration of solid freeform fabrication in design. In *Solid Freeform Fabrication Symposium Proceedings*, ed. D.L. Bourell, J.J. Beaman, K.L. Wood, R.H. Crawford, H.L. Marcus, and J.W. Barlow, 619-627. University of Texas at Austin: Mechanical Engineering Department.
- Harrison, O.L.A., D.R. Cormier, D.J. Marcelling-Little, and K.R. Jajal. 2003. Direct fabrication of metal orthopedic implants using electron beam melting technology. In *Solid Freeform Fabrication Symposium Proceedings*, ed. D.L. Bourell, R.H. Crawford, J.J. Beaman, K.L. Wood, and H.L. Marcus, 439-446. University of Texas at Austin: Mechanical Engineering Department.
- Heule, M., S. Vuillemin, and L.J. Gauckler. 2003. Powder-based ceramic meso- and microscale fabrication processes. *Advanced Materials* 15:1237-1245.
- Kumar, S. 2003. Selective laser sintering: A qualitative and objective approach. *Journal of Manufacturing* 55:43-47.
- Magee, J., K.G. Watkins, and W.M. Steen. 1998. Advances in laser forming. *Journal of Laser Applications* 10:235-246.

- Pfister A., and R. Mülhaupt. 2001. New type of powder materials for inkjet printing. In *Electroactive polymers and rapid prototyping*, MRS Symposia Proceedings, ed. Y. Bar-Cohen, Vol. 698. Warrendale PA: Materials Research Society.
- Pinkerton, A.J. and L. Li. 2003. Rapid prototyping using direct laser deposition: The effect of powder atomisation type and flow rate. *Journal of Engineering Manufacture* 217:741-752.
- Poulikakos, D., and J.M. Waldvogel. 1996. Heat transfer and fluid dynamics in the process of spray deposition. *Advances in Heat Transfer* 28:1-74.
- Prinz, F.B., C.L. Atwood, R.F. Aubin, J.J. Beaman, R.L. Brown, P.S. Fussell, A.J. Lightman, E. Sachs, L.E. Weiss, and M.J. Wozny. 1996-7. *WTEC panel report on rapid prototyping in Europe and Japan* (Vols. 1 and 2). Baltimore, MD: World Technology Evaluation Center, Inc. Available from National Technical Information Service (NTIS), Springfield, VA (reports #PB97-162564 and #PB96-199583), or on the Web at <http://www.wtec.org>.
- Sachs, E. 2001. Manufacturing by solid freeform fabrication. In *Solid Freeform Fabrication Symposium Proceedings*, ed. D.L. Bourell, J.J. Beaman, K.L. Wood, R.H. Crawford, H.L. Marcus, and J.W. Barlow, 596-608. University of Texas at Austin: Mechanical Engineering Department.
- Sigmund, W.M., N.S. Bell, and L. Bergstrom. 2000. Novel powder-based-processing methods for advanced ceramics. *Journal of the American Ceramic Society* 83:1557-1574.
- Smay, J.E., J. Cesarano, III, and J.A. Lewis. 2002. Colloidal inks for directed assembly of 3-D periodic structures. *Langmuir* 18:5429-5437.
- Tari, G. 2003. Gelcasting ceramics: A review. *American Ceramic Society Bulletin* 84:43-46.
- Zhao, X., J.R.G. Evans, M.J. Edirisinghe, and J.H. Song. 2002. Direct ink-jet printing of vertical walls. *Journal of the American Ceramic Society* 85:2113-2115.

CHAPTER 5

PROCESS CONTROL AND METRICS

David W. Rosen

INTRODUCTION

Even more than for traditional manufacturing, rapid manufacturing based on additive/subtractive (A/S) processes depends on a complex series of steps to control for accuracy, cost-effectiveness, repeatability, and ultimately, product quality. As additive/subtractive processes move steadily from prototyping on a small scale into the realm of routine rapid manufacturing of customized final products, European as well as U.S. A/S research and development efforts are focusing increasingly on process control.

Process control spans many topics that influence an A/S machine's capability to fabricate a quality part or product, as illustrated in Figure 5.1. All machines have a controller to drive the various operations of the machine in the correct sequence. In many systems, the inputs to the controller are determined strictly during process planning; i.e., the machines employ *open-loop control*. In other technologies, real-time sensing is utilized, along with *feedback control* to enable the machine to adapt to variations in processing conditions.

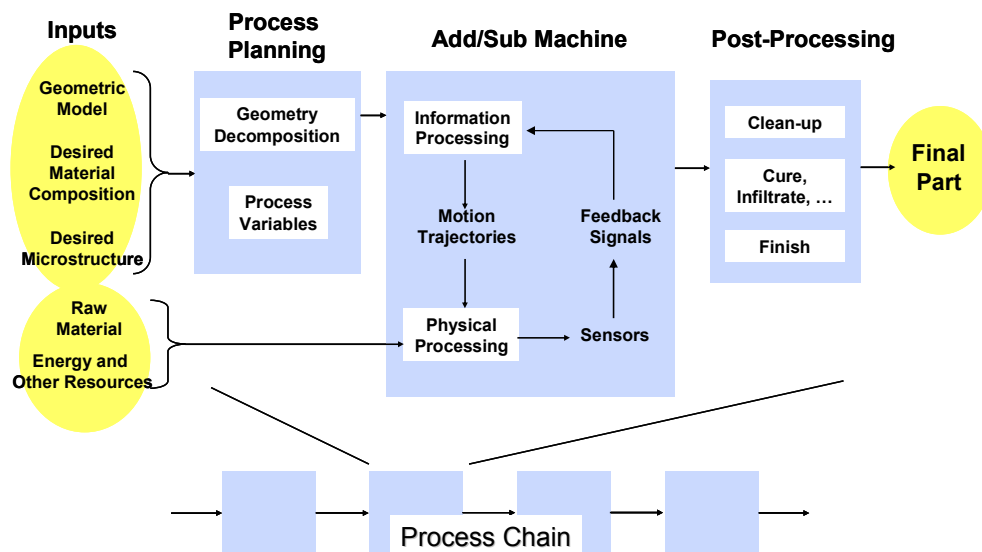

Figure 5.1. A/S system with inputs and outputs.

Inputs to the process planning step include a geometric CAD model of the design and various specifications. Not all specifications are considered during process planning, due to limitations in technology and tools. For example, only a few advanced research systems can incorporate material composition and microstructure

specifications and compute machine operations to achieve the desired composition and microstructure. On the other end of the process, fast, dependable methods are needed to measure, characterize, and qualify the *final parts* that are fabricated by A/S machines. Taking a broad perspective, the operations of one machine can be viewed in the context of an entire process chain for the production of individual parts and/or a product.

In the continuum between inputs and product outputs, the intervening process controls fall into the following major categories, which are discussed in the following sections of this chapter:

- process controls and sensors in A/S machines
- CAD and information processing methods and requirements
- accuracy, surface finish, and process resolution issues

The subject of process control inevitably raises questions about standardization opportunities and future prospects and barriers to progress. These topics round off this chapter's discussion of additive/subtractive manufacturing process control in Europe and the United States.

CONTROLS AND SENSORS

Most commercial A/S machines use open-loop controls, where the control strategy is built into the process planner and encoded into the machine code that drives the A/S machine. The notable exceptions to this are the Arcam electron beam melting (EBM) machines and the class of direct metal machines that are based on laser cladding (LC), all of which successfully use real-time sensing and feedback control, to various degrees.

Need for Real-Time Sensing and Control

In some A/S processes, a significant lag exists between energy application and material processing. For example, in the stereolithography process, the laser scans at speeds of 250 to 5000 mm/sec, while resin reaction times can exceed one minute for nearly full cures. Real-time sensing and control become problematic unless good model-based approaches are available. In ink-jetting systems, electric fields have been used to deflect droplets, which provide some degree of control, but they are not used for real-time feedback control. During the WTEC panel's site visits in Europe, several hosts expressed the need for accurate sensing of build heights in ink-jet systems. Considerable research on laser sintering processes has resulted in good analytical models of laser-particle interactions and particle sintering. However, relatively little work has focused on real-time control of selective laser sintering (SLS). Researchers at some European sites expressed interest in using their models for model-based control.

The successful usage of feedback control in the Arcam EBM process bodes well for the adoption of similar control systems for SLS processes, since these processes are very similar. In the Arcam process, temperatures are sensed in regions to be scanned so that electron-beam power and scan speeds can be corrected. Slight variations of powder density can cause variations in thermal conductivity in different regions of the powder bed. By measuring temperatures in near real time, more uniform sintering can be achieved that compensates for variations in factors that cannot be predicted.

Real-time sensing and feedback control are utilized extensively in laser cladding processes due to their high temperature sensitivity. The LC class of machines includes the commercial Laser Engineered Net Shaping (LENS™) machines by Optomec and the DMD™ (Direct Metal Deposition) machines by POM Group in the United States. It also includes the research machines from the Fraunhofer Institutes for Laser Technology (ILT) and Production Technology (IPT) in Germany, and from the University of Manchester Institute of Science and Technology (UMIST), the University of Nottingham, and the University of Liverpool in the U.K.

Laser Cladding

The relationships between the key laser cladding process variables serve as an example of the complexities and opportunities for real-time sensing and control in A/S technologies. In LC, particles are completely melted and form a melt pool. To produce deposits with desired height and width, the process must be carefully controlled. Powder delivery rate and scan speed are critical, since they determine the amount of material delivered per unit of time, deposition temperature, melt pool size, and the size of the heat affected zone (HAZ) for a given laser power density and powder composition.

Final part properties are determined by the characteristics of the clad (solidified melt pool), including clad profile, dilution of the cladding metal, bonding between layers, homogeneity of layers, surface finish, defects such as porosity, cracking due to thermal stresses, etc. (Boddu et al. 2001). Dilution of the cladding metal by the substrate or workpiece material controls layer thickness and interlayer bonding and can contribute to defects. Dilution can be caused by melt pool temperatures that are too high, leading to melt pools that are too large. High temperatures can cause defects, thermal distortion, and high residual stresses upon cooling that may cause cracking. Hence, controlling the temperature of the melt pool is critical. This is related to the temperature of the powder particles as they encroach onto the substrate or workpiece. If they are too cold, inadequate fusion with the workpiece or cooling of the melt pool will occur. If they are too hot, the powder stream could ionize, forming a plasma.

When building a part, scans of the laser relative to the substrate form a scan pattern with overlapping passes. The amount of overlap affects layer thickness but also has thermal effects. The HAZ can affect distortion and residual stress, so it is important to control its size and characteristics. On the positive side, previously deposited beads can be tempered by subsequent passes, reducing residual stresses. Typically, the desired size of the HAZ determines ranges of other process variables. Figure 5.2 summarizes the relationships between process variables and part quality.

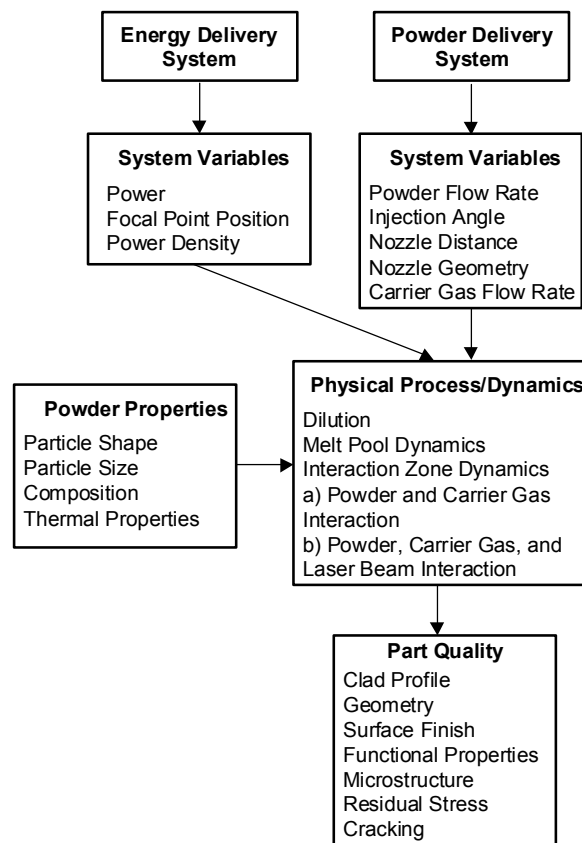

Figure 5.2. Relationships between LC variables and part quality.

In the development of LC machines and machines, it has been demonstrated repeatedly that feedback control is necessary in order to ensure good part quality, starting with the original development of the LC concept in the mid-1980s (Li and Steen 1993) in the U.K. However many different control schemes have been developed that focused on different measurable quantities, different sensors, and different controllers. Boddu et al. (2001) provide a detailed overview of these control schemes. A summary is provided here.

During part fabrication, it is common for powder flow rate, beam position and output power, and substrate velocity to fluctuate. Compensating for these fluctuations is an important element of a control system. Dimensional accuracy is largely a function of clad height and width. Related approaches to height control involve changing laser power, including shutting it off, controlling the amount of powder being deposited, or regulating the shielding gas flowrate to blow excess powder from the workpiece (Mazumder, Schifferer, and Choi 1999). Perhaps a more direct way to control clad height is to regulate powder flowrate directly, since it has been shown that small changes in flowrate significantly impact part geometry and microstructure. Several groups have implemented this (Li and Steen 1993; Carvalho et al. 1995).

Since temperature is such an important factor in deposition and part quality, it is natural for researchers to implement temperature control systems. One method for temperature control has utilized adjustments to the laser focus height relative to the workpiece (Morgan et al. 1997). Others have controlled the deposition process with additional sensors. For example, one group estimated melt pool depth by measuring melt pool width and temperature, then adjusted laser power and scanning velocity to maintain a constant pool depth. More recently, Landers (2003) developed at the University of Missouri-Rolla a nonlinear, multivariable control method to regulate the bead width and melt pool temperature in the process.

CAD AND INFORMATION MODELING

Generally, inputs to the A/S machine process planning software include a CAD model (or STL file or similar) and other specifications for part properties. In some cases, material specifications are also involved. The CAD and information inputs to the A/S machine are critical to the quality of parts the machine creates.

Challenges

A common theme expressed at many of the sites visited was that CAD is becoming a bottleneck in creating novel shapes and structures, in describing desired part properties, and in specifying material compositions. These representational problems imply difficulties in driving process planning and other analysis activities. Many site hosts believed that this bottleneck problem would become worse over time. This problem will slow the adoption of A/S technologies for use in production manufacture. These issues and others have been addressed in earlier literature (Marsan et al. 1998). More specifically, the challenges can be stated as

- *geometric complexity*: it is necessary to support models with tens and hundreds of thousands of features
- *physically-based material representations*: material compositions and distributions must be represented and must be physically meaningful
- *physically-based property representations*: desired distributions of physical and mechanical properties must be represented and tested for their physical basis

One example of the geometric complexity issue is illustrated by the prototype textile application from Dr. Richard Hague at Loughborough University, shown in Figure 5.3. The Loughborough researchers had great difficulty modeling the collection of thousands of rings that comprise the garment in a commercial solid modeling CAD system. Assuming that the CAD model could be constructed, the researchers then desired to fold up the CAD model so that it would occupy a very small region in the SLS machine's vat in order to maximize the throughput of the SLS machine for production purposes. After preparing the CAD model, it then had to be sliced and processed into SLS machine commands. It was only through developing a garment-specific CAD system and other manual processing that the garment model could be fabricated. This kind of situation does not facilitate production application of novel designs using A/S technology.

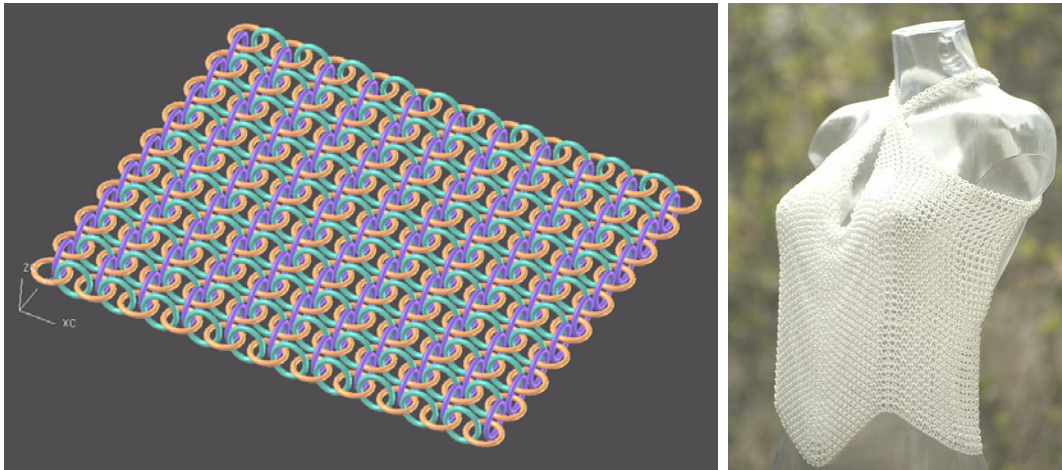

Figure 5.3. Example of textile fabricated using SLS: (*left*) a CAD model, a “chain mail”-like configuration of many small rings; (*right*) a completed garment displayed on a mannequin; the garment was fabricated on a SLS machine in a Duraform material. (Courtesy Loughborough University)

The challenges of physical representation of materials and properties are illustrated well by an application from the Fraunhofer Institute for Manufacturing and Advanced Materials (IFAM) in Bremen, Germany. Researchers there are developing a two-binder system for 3D Printing (3DP) technology, where one binder is traditional and one is carbon-laden. They intend to produce gradient-strength steel parts by depositing the carbon according to a desired distribution of hardness. The model of hardness will be converted into a representation of carbon distribution, which will be converted into carbon-laden binder deposition commands for the 3DP system. After building, the part will be heat-treated to diffuse the carbon into the steel. As a result, this application illustrates the need to represent distributions of material composition (carbon, steel) and mechanical properties (hardness), and relate these to processing conditions. The IFAM researchers are developing a software system for this application.

Solid Modeling CAD Systems and Issues

Parametric, solid modeling CAD systems are used throughout Europe for mechanical product development and in university education and research. Systems such as ProEngineer, Unigraphics, SolidEdge, CATIA, and SolidWorks are very good for representing shapes of most engineered parts. Their feature-based modeling approaches enable fast design of parts with many types of typical-shape elements. Assembly modeling capabilities provide means for automatically positioning parts within assemblies and for enforcing assembly relationships when part sizes are changed.

Commercial CAD systems typically have a hybrid CSG-BRep (constructive solid geometry - boundary representation) internal representation of part geometry and topology. With the CSG part of the representation, part construction history is maintained as the sequence of feature creation, operation, and modification processes. With the BRep part of the representation, part surfaces are represented directly and exactly. Adjacencies among all points, curves, surfaces, and solids are maintained. A tremendous amount of information is represented, all of which has its purposes for providing design interactions, fast graphics, mass properties, and interfaces to other computer-assisted design, manufacturing, and engineering tools (CAD/CAM/CAE).

For parts with dozens or hundreds of surfaces, the commercial CAD systems run with interactive speeds, for most types of design operations, on typical personal computers. However, one drawback of CAD systems is that when more than 1000 surfaces or parts are modeled, the CAD systems tend to run very slowly and use hundreds of megabytes or several gigabytes of memory. For the textile part, Figure 5.5 above, thousands of rings comprise the garment. However, they all have the same simple shape, that of a torus. A different type of application is that of hierarchical structures, where feature sizes span several orders of magnitude. An example is that of a mold with conformal cooling channels, where the cooling channels have small fins or

other protrusions to enhance heat transfer. The fins or protrusions may have sizes of 0.01 mm, while the channels may be 10 mm in diameter, and the mold may be 400 mm long. As a result, the mold model may have hundreds or thousands of small features. Also, the range of size scales may cause problems in managing internal tolerances in the CAD system.

In summary, two main geometry-related capabilities are needed to support many emerging design applications, particularly when A/S manufacturing processes will be utilized:

- the capability to represent tens or hundreds of thousands of features, surfaces, and parts
- the capability to manage features, surfaces, and parts across size ranges of four to six orders of magnitude

The International Organization for Standardization Standard for the Exchange of Product (ISO STEP) standard provides a data exchange representation for solid geometry, material composition, and some other properties. However, it is intended for exchanging product information among CAD, CAM, and CAE systems, not for product development and manufacturing purposes. That is, the STEP representation was not developed for use within modeling and processing applications. A good assessment of its usefulness in representing parts with heterogeneous materials for A/S manufacturing is given by Patil et al. (2000).

As mentioned above, the first challenge for CAD systems is geometric complexity. The second challenge for CAD systems is to directly represent materials, so that designers can specify directly a part's material composition. As a result, CAD models cannot be used to represent parts with multiple materials or composite materials. Material composition representations are needed for parts with graded interfaces, functionally graded materials, and even simpler cases of particle or fiber filler materials. Furthermore, CAD models can only provide geometric information for other applications, such as manufacturing or analysis, not complex multiple material information, which limits their usefulness. The WTEC site visit teams saw this need from several groups, including at IFAM and at UMIST, where researchers are developing multimaterial ink-jet printing technologies. In the IFAM case, addition of carbon to steel deals with the relatively well understood area of carbon steels. In other applications, novel material combinations (or at least less well understood combinations) may be of interest. Two main issues arise:

- representing desired material compositions at appropriate size scales
- determining the extent to which desired material compositions are achievable

Without a high fidelity representation of materials, it will not be possible to directly fabricate parts using emerging A/S processes. Furthermore, design-for-manufacturing practices will be difficult to support. Together, these limitations may prevent the adoption of A/S processes for applications where fast response to orders is needed.

The third challenge for CAD systems, that of representing physically-based property distributions, is perhaps the most difficult. The IFAM example of relating desired hardness to carbon content is a relatively simple case. More generally, the geometry, materials, processing, and property information for a design must be represented and integrated. Without such integrated CAD models, it will be very difficult to design parts with desired properties. Analysis and manufacturing applications will not be enabled. The capability of utilizing A/S processes to their fullest extent will not be realized. In summary, two main issues are evident:

- Process-structure-property relationships for materials must be integrated into geometric representations of CAD models.
- CAD system capabilities must be developed that enable designers to synthesize a part, its material composition, and its manufacturing methods to meet specifications.

IFAM researchers are developing a CAD and process planning system for their carbon 3DP system since no commercial tools are available.

Polygon Mesh CAD Systems

Rather than utilize the overhead of a solid modeling technology, a group of geometric modeling systems is emerging that utilizes triangle or polygon meshes to represent part boundaries. The genesis of these systems is two-fold:

- STL files are triangle meshes, so triangle meshes have a natural interface to manufacturing systems
- triangle meshes arise in reverse engineering and inspection, particularly from laser scanners and interferometers

Most commercial CAD systems output STL files for rapid prototyping purposes. STL files are tessellations (triangulations) of CAD model boundaries. From the rapid prototyping and manufacturing side, some software systems have emerged for inspecting STL files, repairing them, and performing some basic modeling operations on triangle meshes. Examples include the suite of tools from DeskArtes (www.deskartes.com), a Finnish company; Magics from Materialise NV (www.materialise.com/magics-rp/main_ENG.html), a Belgian company; SolidView from Solid Concepts (www.solidview.com/); and Paraform from Metris (www.paraform.com). Most of these systems have the capability of preparing support structures and performing process planning for selected RP systems. Figure 5.4 shows two triangle mesh objects.

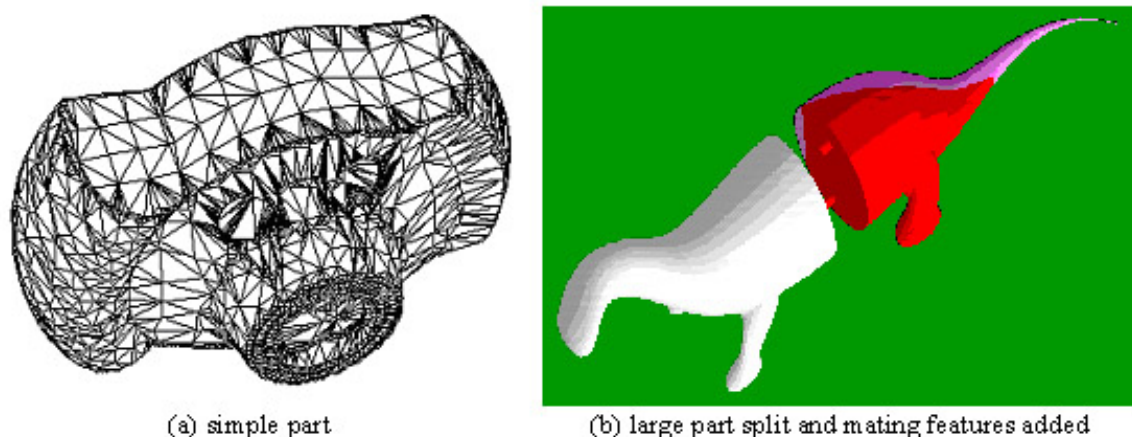

Figure 5.4. Example triangular mesh objects. Part (a) shows an example triangle mesh that was probably produced from a CAD system as an STL file. Part (b) illustrates one of the typical system capabilities for modifying meshes. If the dinosaur model is too large to build on a RP machine, it can be split into several pieces, such that each piece fits within the machine. To facilitate assembly of the pieces after they are built, mating features such as the pegs and holes shown are automatically added by the system. (Source: DeskArtes)

From the reverse engineering perspective, other systems have been developed for processing the “point clouds” that are generated from laser scanners and white-light interferometers. To inspect a part, it is scanned, the point cloud is registered to a CAD model or surface, then deviations of points from CAD model surfaces are measured. These deviations indicate manufacturing errors. It is sometimes convenient to process point clouds before the registration and inspection steps. This processing could include triangulating the point clouds or may include recognizing edges or other features within the point clouds. To support reverse engineering of a physical part (i.e., generating a CAD model from a physical model), point clouds must be converted to triangle meshes or, further, may be converted to CAD model surfaces. Example systems include *Studio*, from U.S.-based Raindrop Geomagic, Inc. (www.geomagic.com/products/studio/); *Imageware* (www.ugs.com/products/nx/imageware/), from EDS Corporation in partnership with UGS, both headquartered in Plano, Texas; and *Paraform* from Metris, headquartered in Belgium.

Some systems, such as Magics, Paraform, and Studio, are incorporating functionality that resembles many CAD system capabilities. Creating, analyzing, and modifying sculpted surfaces are possible with Studio and

Paraform. Creating new features and performing Boolean operations (e.g., join, cut) are possible with some of these packages. As such, a trend is emerging: the mesh-based systems are becoming more suitable as CAD systems for many purposes. Over time, this trend has continued. In a few years, we may see fully capable CAD/CAM/CAE systems all based on polygon meshes.

If mesh-based systems seem so promising, why have they not replaced solid modeling CAD systems already? Solid modeling has some advantages over mesh-based modeling. First, model resolution is limited to the triangle/polygon size in a mesh model, whereas with a solid model, the mathematical surfaces provide higher resolution. Second, meshed models can become very large as more polygons are added to improve resolution. It may be much more efficient to represent a few large surfaces with their mathematical definitions, rather than to represent thousands of small triangles. Third, meshed models are approximations to the actual part geometry, which likely consists of smoothly curving surfaces. For many applications, the exact curved surface representation is needed or desired. For the issues of material composition and property representation, mesh-based systems do not have particular advantages or disadvantages compared to solid modeling systems. It is likely that the same types of material and property representations could be used for either mesh or solid models.

Other Information Technology Support

The most extensive software development efforts among the sites the WTEC panel visited were at BIBA, the Bremen Institute of Industrial Technology and Applied Work Science at the University of Bremen. Researchers there had developed a system called the RP Workbench and had applied the developed technology in several other projects in rapid prototyping and tooling. Their focus seemed to be on enabling organizations to better utilize A/S technology, rather than to improve on fundamental algorithm and representation technology of RP and CAD software.

Within the RP Workbench system, three new rapid tooling modules have been added:

- *Tooling Designer*, CAD functionality for tool design: With a CAD model of the part as input, the Designer module supports the development of parting planes and mold sections and the detection of undercuts.
- *Tooling Instructor*, information and decision support for tool designers: Given a description of the project requirements, the system tries to find a best-match example case and helps the designer understand the various steps involved in designing and fabricating the tool.
- *Tooling Selector*, decision support for manufacturing process planners: This includes selection of suitable process chains, given a description of project requirements. Administration of all process data (materials, machines, processes, service providers and process chains) is supported through a database application.

Marcam Engineering GmbH in Bremen is a spin-off company from BIBA that has commercialized some aspects of the RP Workbench in a product called VisCAM RP. This is an experience-based software tool that allows service bureaus to determine the optimal prototyping strategy, optimal fabrication method, and optimal finishing operations for prototypes as a function of the desired geometry, functionality, and surface finish. The software appears to have special value to small companies or to younger designers with limited experience in prototyping. It includes the tooling modules described above.

The BIBA group was also involved in development of process software for the Selective Laser Melting (SLM) technology that was developed by the Fraunhofer ILT and commercialized by F&S Stereolithographietechnik GmbH (www.fockeleundschwarze.de/english/fsproducts.html).

Process Planning

In process planning, a part's CAD model and manufacturer expertise are used to develop the operation sequence and machine code necessary to fabricate the part on a specific machine tool and in a specific material. As noted in the Controls and Sensors section, many A/S processes utilize offline control methods

embedded in process planners, rather than real-time control methods. Hence, process planning is critical in achieving good part quality.

In commercial systems, the approach to achieving good repeatable results is to develop build styles that are applied to a part model, leaving relatively few process variable decisions to the user. Typically, remarkably good results are achieved, especially considering that the geometry input to these systems is typically an STL file, rather than a CAD model with exact geometry. In research systems, the approach to process planning varies widely. Relatively little work on process planning was observed at the sites the WTEC teams visited. Emphasis was on developing process-structure-property relationships that could be used to set process variables. These relationships were developed both empirically and analytically. This work focused on laser cladding and/or laser sintering processes and was evident at UMIST, University of Nottingham, Fraunhofer ILT, and Fraunhofer IPT.

One example conveys the essence of the typical approaches. The WTEC panel team learned that much of the effort at the University of Nottingham Institute for Materials Technology (UNIMAT) was focused on materials processing methods, with some efforts on information integration for its shaped metal deposition (SMD) process. In SMD, researchers were concerned with developing a database of materials-processing information that could be used for process planning and optimization purposes. Their intention was to perform design-of-experiments to develop empirical models of process-structure-property relationships for a given material. In parallel, they saw the need to develop mechanistic models to explain their observed relationships and to enable prediction of processing conditions for process planning and optimization.

With the integrated information systems at UNIMAT, materials processing databases can provide process variable values for the simulation software packages that they have. This enables users to process a CAD model of a part, simulate its manufacture, and generate code to drive robotic welding equipment. In the future, UNIMAT researchers will also develop the capability to evaluate their processes in terms of microstructure and mechanical properties.

ACCURACY AND RESOLUTION

With commercial A/S machines, accuracy is typically quoted using a percentage of part length, such as x.y cm per cm. In many processes, part accuracy can be approximated as scaling linearly with part length. This is consistent with processes where volumetric shrinkage of material occurs or where inaccuracies are additive. During the WTEC site visits, panelists did not see much of an emphasis on accuracy measurement, characterization, or improvement methods. Several hosts discussed methods for improving surface finish, and several discussed the factors that determine process resolution, but there did not seem to be an emphasis on improving resolution.

Process accuracy and precision have received considerable attention among practitioners, particularly in the early days of A/S technology. In the stereolithography and laser sintering communities, standard test parts were developed to enable users to determine, for example, the X-Y scale factors to use when building parts. The “Christmas Tree” part was used for many years with stereolithography machines (see Figure 5.5a) to enable users to set the scale factors for their machines. So-called “user parts” were also developed as de facto standards to enable users to characterize the dimensional tolerance capabilities of their machines across the build area. To some extent, the tolerance capability in the Z direction could be determined as well. The stereolithography “user part” is shown in Figure 5.5b. Neither type of part receives much attention at present, since the commercial machines and materials have improved.

Process resolution is an informal characteristic that researchers find useful, because it quantifies, to some extent, the smallest feature sizes that a process can build and is related to typical surface finishes achievable by a process. The WTEC team’s hosts often quoted resolution as a function of machine or process parameters, such as laser beam spot size, layer thickness, or particle sizes for powder-based systems.

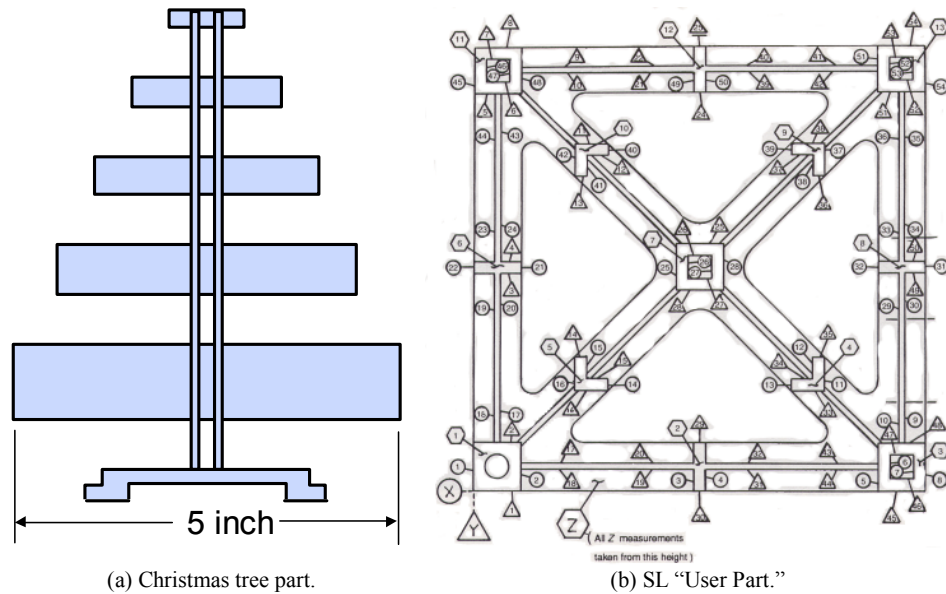

(a) Christmas tree part.

(b) SL "User Part."

Figure 5.5. Typical approaches to determining or improving accuracy.

In the course of the WTEC site visits, surface finish was acknowledged to be significant shortcoming in many A/S processes, particularly those that are powder-based. At several sites, process chains were utilized to achieve desired levels of finish. A common procedure is to improve surface finish using secondary operations. For example, at Fraunhofer IPT, shot peening of steel parts was used to achieve 3–4 μm finish. Laser surface melting at Fraunhofer ILT used high power lasers (100–500 W; CW then pulsed modes) to achieve finishes of 1.7–0.24 μm ; this process is faster than manual polishing.

METRICS AND STANDARDIZATION OPPORTUNITIES

Opportunities for standards and metrics in the A/S area include the following:

1. part representations
2. materials and properties
3. accuracy
4. qualification of materials and processes for an application
5. machine architectures

In the area of part representations, the ISO STEP standard provides a good starting point and basis for comparison. As discussed earlier, new CAD representations and technologies are needed for representing thousands of geometric features, material distributions, and other property distributions. Although the STEP standard provides a good representation of geometry and some properties, it is intended for exchanging product information, not for product development and manufacturing purposes. Furthermore, the representations are not rich enough to represent material and property distributions that are suitable for A/S processes.

In the area of materials and properties, American Society for Testing and Materials (ASTM), ISO, and many other organizations provide numerous standards for testing and specifying many properties of materials (mechanical, thermal, electrical, etc.). These standards have been developed over many years and are widely used. However, in many cases, they have limited applicability to A/S processes and materials. New materials and structures are being developed that cannot be characterized by simple mechanical properties, such as tensile strength, elastic modulus, etc. Rather, the material compositions vary, so properties vary throughout the geometry of a part and also may vary across size scales. In general, it must be possible to

characterize and communicate material properties that vary spatially, across size scales, and across time periods.

In the area of accuracy, A/S technologies share the limitations of most manufacturing processes in that standards organizations still struggle to develop mathematically rigorous, computationally efficient, practically applicable definitions of geometric tolerances. Of the five opportunity areas identified in this section, accuracy has developed furthest. It is not clear if A/S technologies require special considerations in this area, or if developments will benefit A/S technologies and conventional manufacturing processes alike.

The need for process and material qualification was raised at several European sites during discussions of production manufacture with A/S technologies. Manufacturers must be able to guarantee a certain level of part quality before committing to a process and material. Process reliability and material composition and properties must be good enough. Manufacturers need methods for qualifying their processes and materials, but such methods do not exist for A/S technologies. If new materials, material compositions, or graded material regions are used in parts, the problem becomes more difficult, as noted earlier. Standard methods for testing, characterizing, and communicating material properties are critical to enabling material and process qualification.

The final topic, machine architectures, highlights an issue that prevented faster progress in the machine tool industry and may have a similar impact on the A/S field. For several decades, numerical control (NC) and computer numerical control (CNC) machine tools were designed with proprietary architectures, modules, and interfaces. It was only after many years of organization in which machine tool users were finally able to convince the tool manufacturers to adopt open architectures that significant progress was made in interfacing machine tools into integrated manufacturing environments. The adoption of open architecture machine tools had many benefits that have propelled the industry to make significant gains in the past 20 years.

Given the similarities of many additive processes, considerable opportunities exist to develop standard modules, interfaces, controllers, and software systems so that these elements can be shared among the different A/S technologies. Most subtractive technologies are available in open architecture form already. By surveying the industry worldwide and visiting the European sites, it is clear that each type of machine was developed (more or less) from scratch. Controllers and process planning software were developed specially for the new machine, even though many machine operations and process planning steps are shared among many A/S systems. The industry does not have modules available for others to utilize. In part, this is due to the relative immaturity of the technology and a lack of system developers who are actively looking to share technology. As production manufacturing with A/S technologies becomes more prevalent, it is likely that demand will increase for

- open architecture A/S machines that can be integrated readily into manufacturing systems
- standard machine modules and interfaces that can be “plugged into” open architecture machines to enhance their capabilities
- software systems or modules that can be used to develop controllers and process planning systems

FUTURE AND BARRIERS

The future will include production manufacturing using additive/subtractive technologies. To achieve production manufacturing, a number of process control, metrics, and material barriers need to be overcome:

- Design methods and CAD systems must be achieved that support development of new applications, customized products, and so forth.
- Processes must be developed that are capable of predictable operation and can achieve desired levels of quality. This necessitates the use of sensors to monitor the process, control methods in some cases, and qualification procedures so that manufacturers have confidence in their processes and materials.
- Process chains must be designed to achieve desired properties and characteristics. Manufacturers need tools for creating, selecting, operating, and reconfiguring process chains so they can respond quickly to new product demands or changing requirements.

- Standards are needed to provide manufacturers a solid foundation for developing manufacturing infrastructures that include A/S technologies. Standards are needed to facilitate
 - communication and collaboration in product development
 - process and material qualification
 - modular and reusable systems and subsystems

REFERENCES

- Boddu, M.R., R.G. Landers, and F.W. Liou. 2001. Control of laser cladding for rapid prototyping — A review. In *Solid freeform fabrication symposium Proceedings*, ed. D.L. Bourell, J.J. Beaman, K.L. Wood, R.H. Crawford, H.L. Marcus, and J.W. Barlow, Austin, TX, Aug. 6–8, 460–467. University of Texas at Austin: Mechanical Engineering Department.
- Carvalho, P.A., N. Braz, M.M. Pontinha, M.G.S. Ferreria, W.M. Steen, R. Vilar, and K.G. Watkin. 1995. Automated workstation for variable composition laser cladding — Its use for rapid alloy scanning. *Surface and Coatings Technology* 72:62-70.
- Landers, R., 2003, Process control of laser metal deposition manufacturing – A simulation study. In *Solid Freeform Fabrication Symposium Proceedings*, ed. D.L. Bourell, R.H. Crawford, J.J. Beaman, K.L. Wood, and H.L. Marcus, 246–253. University of Texas at Austin: Mechanical Engineering Department.
- Li, L., and W.M. Steen. 1993. Sensing, modeling and closed loop control of powder feeder for laser surface modification. *Laser Materials Processing* 77 (Oct.):965–974.
- Marsan, A.L., V. Kumar, D. Dutta, and M.J. Pratt. 1998. An assessment of data requirements and data transfer formats for layered manufacturing. NIST Internal Report, NISTIR 6216. Gaithersburg, MD: National Institute of Standards and Technology.
- Mazumder, J., A. Schifferer, and J. Choi. 1999. Direct materials deposition: Designed macro and microstructure. *Materials Research Innovations* 3:118–131.
- Morgan, S.A., M.D.T. Fox, M.A. McLean, D.P. Hand, F.M. Haran, D. Su, W.M. Steen, and J.C. Jones. 1997. Real-time process control in CO₂ laser welding and direct casting: Focus and temperature. In *Proceedings of ICALEO*, Sec. F, 290-299. Orlando, FL: Laser Institute of America.
- Patil, L., D. Dutta, A.D., Bhatt, K. Lyons, K. Jurens, M.J. Pratt, and R.D. Sriram. 2000. Representation of heterogeneous objects in ISO 10303 (STEP). In *Proceedings of the ASME International Mechanical Engineering Congress and Exposition*, Mechanical Engineering Division Orlando, FL, November, 355–364.

CHAPTER 6

BIOMEDICAL APPLICATIONS OF INTEGRATED ADDITIVE/SUBSTRUCTIVE MANUFACTURING

Scott J. Hollister and Theodore L. Bergman

INTRODUCTION

Biomedical applications present unique challenges that both draw on the strengths of current fabrication technologies and will push innovation in future fabrication technologies. These challenges include the need to

1. build complex shapes matching human anatomy
2. build complex, porous microstructures from biocompatible materials
3. build with living cells, genes, and proteins
4. build multiple, biocompatible materials and cells/genes/proteins together and separately on the same platform
5. build at resolutions below 10 microns over structures greater than 1cm in size

Current fabrication systems can readily achieve goals 1 and 2, and indeed are being used for biomedical applications in U.S., European, and Asian research facilities. Custom-built fabrication systems are currently being built to address goal 3. Systems have been developed for microstereolithography of ceramics with a feature size of 2 microns (Heule, Vuillemin, and Gauckler 2003), but these have not been utilized to build large scale structures or with bioceramics. Goals 4 and 5 remain research targets for the future, and indeed combining goals 3-5 with current fabrication technology will yield the ultimate biomedical fabrication system.

The requirements that drive the five goals range from external devices that contact the human body, to permanent surgical implants, to degradable tissue engineering scaffolds that deliver cells, genes, and proteins to regenerate tissues. Two examples of external devices include hearing aid shells and dental bridges. These devices present markets for existing additive/subtractive manufacturing technologies. Permanent surgical implants, most noticeably the joint-implant orthopaedic market and the pacemaker cardiovascular market, represent markets that are well served by current manufacturing technologies, but that could benefit from application of integrated additive/subtractive manufacturing technologies. Finally, tissue engineering represents the most risky but potentially the most lucrative market for integrated additive/subtractive manufacturing technologies. Although recent funding for tissue engineering technologies dropped during the economic downswing that saw the bankruptcy of the companies Advanced Tissue Sciences and Organogenesis, it is clear that a large potential market, first forecast to reach \$80 billion in a July 1998 *BusinessWeek* article (Arnst and Carey 1998), still exists for tissue engineering products for the aging baby boomer population. Integrated additive/subtractive manufacturing technologies are clearly the primary candidate for fabricating tissue engineering scaffold cell delivery systems, since these systems must have complex shapes and porous microstructures to support tissue regeneration.

Existing additive/subtractive fabrication technologies can certainly address the first two goals of (1) building complex external shapes to match human anatomy, and (2) building complex porous microstructures. All widely used commercial solid free-form fabrication (SFF) systems can build complex 3D shapes that mimic human anatomy; these systems include stereolithography (SLA) from 3D Systems, selective laser sintering (SLS) from 3D systems, fused deposition modeling (FDM) from Stratasys, 3D Printing from ZCorp, and 3D ink jet wax printing from Solidscape. Indeed, a niche industry has grown up making models of human anatomy for surgical planning (for a review, see Webb 2000). In addition, these commercial systems have been utilized to fabricate complex porous microstructures. Therics, Inc., in collaboration with the Massachusetts Institute of Technology (Sherwood et al. 2002) has used 3D printing to build porous microstructures from a polylactic-polyglycolic acid copolymer (PLGA), a biodegradable polymer. Hutmacher and colleagues (Zein et al. 2002) have used the FDM system to build porous microstructures for bone reconstruction using polycaprolactone, another biodegradable polymer. In addition, Taboas et al. (2003) have used the Solidscape ink jet printer to build inverse molds for casting porous microstructures from both calcium phosphate ceramics and biodegradable polymers.

This chapter summarizes some of the significant advances already made in biomedical applications of integrated additive/subtractive manufacturing. Special note is made of research progress in the European sites visited by the WTEC panel. Finally, the chapter assesses new progress in the field and makes suggestions for future research.

FABRICATION OF EXTERNAL DEVICES

There are two active biomedical application markets for integrated additive/subtractive manufacturing, primarily additive manufacturing, of external devices: those for hearing aid shells and for dental fixtures, including bridges. Envisiontec, working closely with the Freiburg Materials Research Center (FMF) that the WTEC panel visited in Germany, has actively pursued both the hearing aid and dental fixture markets using its Perfactory fabrication system (see photograph in Chapter 2, Figure 2.5).

The Perfactory system uses photopolymerization to build structures. Instead of using a laser, however, the Perfactory system uses a light source that is masked using a grid of digital mirrors. The light source is underneath and shines up on the polymer. A system of digital mirrors in a 1280 x 1024 grid is used to mask the light shining on the polymer. If a mirror grid is open, the material underneath this mirror is completely polymerized and becomes part of the structure. If a mirror grid is closed, no light shines on the material and this grid area becomes a void. If the mirror is partway open, the material is partially polymerized and becomes a support. The theoretical feature resolution of the Perfactory system is 32 microns, the length of one digital mirror. The Perfactory system builds at 15 mm/hour at a 50-micron layer thickness and 25 mm/hour at a 100-micron layer thickness. The 32-micron feature size places the Perfactory system as the fabrication system with the highest feature resolution.

The high resolution combined with rapid manufacturing speed make Envisiontec's Perfactory system well suited for making dental fixtures, including crowns, caps, and bridges. For these applications, the Perfactory system has been used to make molds. Material is then cast into the mold to create the final application. The molds are built at a layer thickness of 30 microns, with in-plane resolution of 32 microns. This again demonstrates the use of a finer resolution fabrication system for this biomedical application.

The other European site visited by the WTEC panel that was pursuing dental manufacturing applications is TNO Industrial Technology in the Netherlands.

Among the most successful biomedical dental applications are the Invisalign orthodontic custom braces by Align Technology, Inc., headquartered in Santa Clara, California. In this process, a dentist makes an impression, which is sent to Align Technologies. The impression is then scanned and the orthodontic appliances are made on a stereolithography system. As a prime example of mass customization, over 100,000 patients have been treated with the Invisalign system. This clearly demonstrates the advantages of integrated additive/subtractive manufacturing to create custom, patient-specific anatomic products.

The other external biomedical device application for integrated additive/subtractive manufacturing is hearing aids. There is currently a 25% return rate due to improper fitting of hearing aid shells. To address these issues, Materialise in Belgium is collaborating with Phonak and Siemens to directly create STL files by scanning impressions of the inner ear. This project, entitled the Rapid Shell Modeling project, will not only save labor in creating a patient-specific hearing aid, but will also provide a digital archive of that patient's hearing aid shell in case the original shell is lost. Envisiontec is also targeting the hearing aid shell market with the Perfactory system. In fact, Envisiontec estimates a market for 25 to 50 systems in Europe, a total of up to €2 million. Envisiontec has demonstrated the capability to build 20 hearing aid shells in 90 minutes.

Both hearing aid shells and dental fixtures are maturing markets that demonstrate the clear advantage of integrated additive/subtractive manufacturing to create mass-customized anatomic devices.

FABRICATION OF PERMANENT SURGICAL IMPLANTS

Just as the external anatomic device fabrication markets take advantage of integrated additive/subtractive manufacturing's capabilities for matching anatomic shapes, permanent surgical implants are a second market that can take advantage of custom shape fabrication. This market includes orthopedic and craniofacial joint replacements, fracture fixation devices, and spine reconstruction devices. However, rather than create designs from impressions made on the body, this market must rely on the capability to design directly from medical images. This design capability currently exists commercially in the Materialise software as well as in research software efforts (Zein et al. 2002; Taboas et al. 2003). In addition to matching anatomic shapes, orthopedic surgical implants also need porous structures for attachment to host bone through bone ingrowth. Webb (2000) provides a review of early additive manufacturing applications for orthopedic implants along with surgical planning applications.

The material of choice for fabricating permanent orthopedic/craniofacial implants is titanium alloy, Ti-6Al-4V. This alloy is used in fabricating a wide variety of joint replacements, interbody spinal fusion cages, and fracture fixation devices. Two recently available commercial systems from European laboratories have a potential to impact the orthopedic/craniofacial implant market due to capability for additive metal fabrication. The first is the selective laser melting (SLM) process developed at the Fraunhofer Institute for Laser Technology (ILT) in Aachen, Germany. This technique can create fully dense titanium alloy parts. SLM utilizes a powdered metal that is spread as a layer in a powder bin. The powdered metal is then sintered using a laser, with the unsintered powder serving as a support. The SLM process will be commercialized by Trumpf. The second system is the electron beam fabrication system by ARCAM, which uses electron beams to weld powdered metal. Details of the ARCAM system are presented in Chapter 4, "Materials and Materials Processing," by Drs. Bergman and Bourell.

Both the Fraunhofer ILT's SLM process and the ARCAM electron beam system have the capability to build fully dense titanium parts to mimic human anatomy. ILT has demonstrated fabrication of prosthetic hip stem. ARCAM has built distal femoral condyles for total knee replacement. Harryson et al. (2003) described the use of the ARCAM electron beam sintering system to build orthopedic implants. When used as articulating surfaces for total joint replacement, additive fabricated metal parts will need to have very smooth surface finishes. In this case, post-processing of fabricated metal parts will be necessary.

Fabricating fully dense implants is routinely done using traditional subtractive manufacturing processes. Therefore, integrated additive/subtractive techniques may have little competitive advantage. However, since many permanent surgical implants are attached by bone ingrowth into implant pores, the capability to fabricate porous microstructures within anatomic shapes will provide a competitive advantage for orthopedic/craniofacial implants. An example of a fabricated titanium interbody fusion cage with optimally designed microstructure is shown in Fig. 6.1. This cage resulted from collaboration between the University of Michigan Skeletal Engineering Group, which created the design, and the Fraunhofer ILT, which fabricated the cage using SLM.

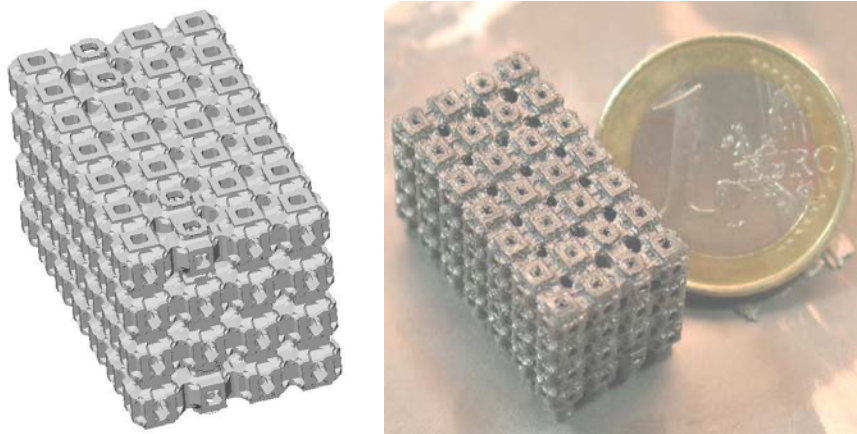

Figure 6.1. Optimally designed interbody spinal fusion cage created by additive manufacturing (*left*) STL file created using image-based topology optimization; (*right*) titanium cage fabricated using SLM.

FABRICATION OF TISSUE ENGINEERING SCAFFOLDS

Tissue engineering scaffolds represent the most risky, but at the same time most exciting, venture with the largest potential payoff for biomedical integrated additive/subtractive manufacturing applications over the next 10 to 30 years. Although a great deal of progress is currently being made fabricating tissue engineering scaffolds, the ultimate fabrication technology will reach goals 3-5 noted in the introduction to this chapter, that is, be able to fabricate hybrid biomaterial and cell/gene/protein structures over a range of size scales. Integrated additive/subtractive manufacturing will be the conduit through which biomaterial, biomechanical, and design engineering technologies are brought together with biological technologies of stem cell therapy, gene therapy, and protein therapy. As such, there will not be a separate scaffold seeded with cells or genes, but rather a hybrid scaffold/cell/gene structure fabricated by an integrated additive/subtractive manufacturing system.

Around the world, there are now significant amounts of work fabricating tissue engineering scaffolds using SFF. By and large, these efforts have used modified off the shelf biomaterials for use on commercially available SFF systems. Using this approach, a wide range of materials have been fabricated, including calcium phosphate ceramics and degradable biopolymers. These scaffolds have typically been built from a single material when directly built on a commercial system. For example, polypropylene fumarate/tri-calcium phosphate (PPF/TCP) has been directly built on a stereolithography system taking advantage of its photopolymerization properties (Cooke et al. 2002). Hutmacher and colleagues (Zein et al. 2002) have been able to directly build polycaprolactone using a Stratasys fused deposition modeling (FDM™) system.

In addition to direct biomaterial processing, many groups have also used SFF systems to create molds and then cast biomaterials directly into the molds. Taboas et al. (2003) were able to use this technique to create scaffolds from both ceramic and polymer scaffolds, as well as to create discrete composite ceramic and polymer scaffolds. They were also able to create scaffolds with multiple pore scales and features down to five microns in size by combining SFF casting techniques with more traditional biopolymer processing techniques. Of the European sites the WTEC panel visited, three were fabricating calcium phosphate ceramic scaffolds using SFF. Isotis, a biomaterials company, has also created calcium phosphate ceramics using SFF molds created using the Envisiontec Perfactory system. The University of Loughborough has created hydroxyapatite (HA) ceramic scaffolds using SLS. The University of Leeds has directly fabricated bioglass scaffolds. Thus, current tissue engineering scaffold fabrication has accomplished the first and second goals (build complex shapes matching human anatomy and build complex, porous microstructures from biocompatible materials), and it has partially accomplished the goals of creating multimaterial scaffolds.

There has been some research progress pursuing the elusive goal of printing biological factors, including cells, genes, and proteins, with materials. At Clemson University, Boland and colleagues (2003) have been able to print cells in hydrogels. They found that the cell aggregates could fuse, which is critical for creating complex organs.

One of the most advanced biomaterial/cell hybrid fabrication efforts is ongoing at the Freiburg Materials Research Center (FMF) under the direction of Professor Rolf Mülhaupt. Freiburg has developed a machine with Envisiontec that can fabricate a wide range of biomaterials, including calcium phosphate ceramics, degradable polylactic/polyglycolic acid polymers, and hydrogels such as alginate, agarose, fibrin, and collagen. This machine, named the 3D Bioplotter™, has now been commercialized and is sold by Envisiontec (see also Chapter 2 and Figure 2.7).

The Bioplotter is based on a nozzle system that can print solutions within temperatures ranging from -50°C to 150°C . The nozzle itself is located on a three-dimensional axis system that is positioned using NC (numerical control) code derived from a DXF (or .dxf) contour file. Another unique feature of the Bioplotter is that material can be printed into a reactive support medium (Figure 6.2).

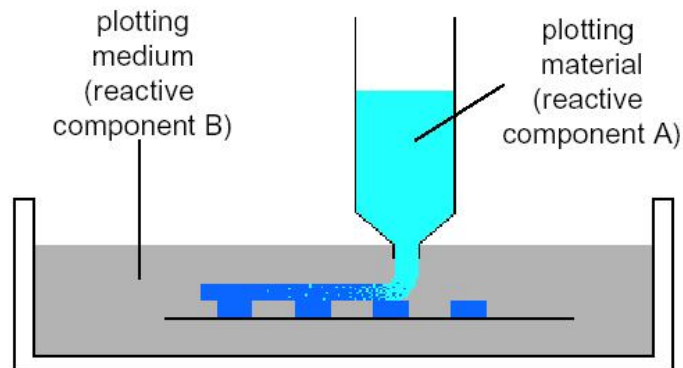

Figure 6.2. Schematic showing the reactive plotting process of the 3D Bioplotter. Material (component A) is printed from the nozzle into the reactive medium (component B). The reactive medium also provides support for the plotted material using buoyancy forces.

The purpose of the medium is twofold. First, the medium serves to support overhanging structures through buoyancy forces. Second, for some materials the medium can contain chemicals that will react with the printed material, making it a reactive support medium. More detailed descriptions of scaffold fabricated using the Bioplotter may be found in the work of Landers and colleagues (2002a and 2002b).

Of the machines currently on the market, the 3D Bioplotter is perhaps the fabrication machine that comes closest to attaining at least goals one through four. The Freiburg research group demonstrated the capability to fabricate with a wide range of materials. The biomaterials fabricated using the Bioplotter include calcium phosphate ceramics, degradable biopolymers including the polylactic and polyglycolic copolymers, polycaprolactone, and hydrogels, including collagen I gel, fibrin, alginate, and agarose. Thus, the Bioplotter provides the capability to build a broader range of biomaterials than any currently available commercial fabrication system. This is not surprising, given the fact that it is perhaps the first commercial machine designed specifically for biomedical applications. This is possible because the Bioplotter combines different material processing techniques within the same nozzle system, including melt processing, solvent processing, and reactive chemical plotting. These different material processing techniques give the Bioplotter the capability to build a wide range of biomaterials. For example, calcium phosphate ceramics are printed through the nozzle as a slurry that may be sintered post-printing to create a dense ceramic. Biopolymers may be printed using solvents such as chloroform. Thermoreversible hydrogels such as agar may be printed by heating the hydrogel above the solid-liquid transition temperature to create a liquid that then solidifies after printing due to cooling. Finally, hydrogels like alginate and fibrin may be created by plotting one component through the nozzle into a second reactive component to produce the final gel. For example, fibrin gel is

created by plotting fibrinogen into thrombin. The range of material processes and the applicable biomaterials of the 3D Bioplotter is shown in Figure 6.3.

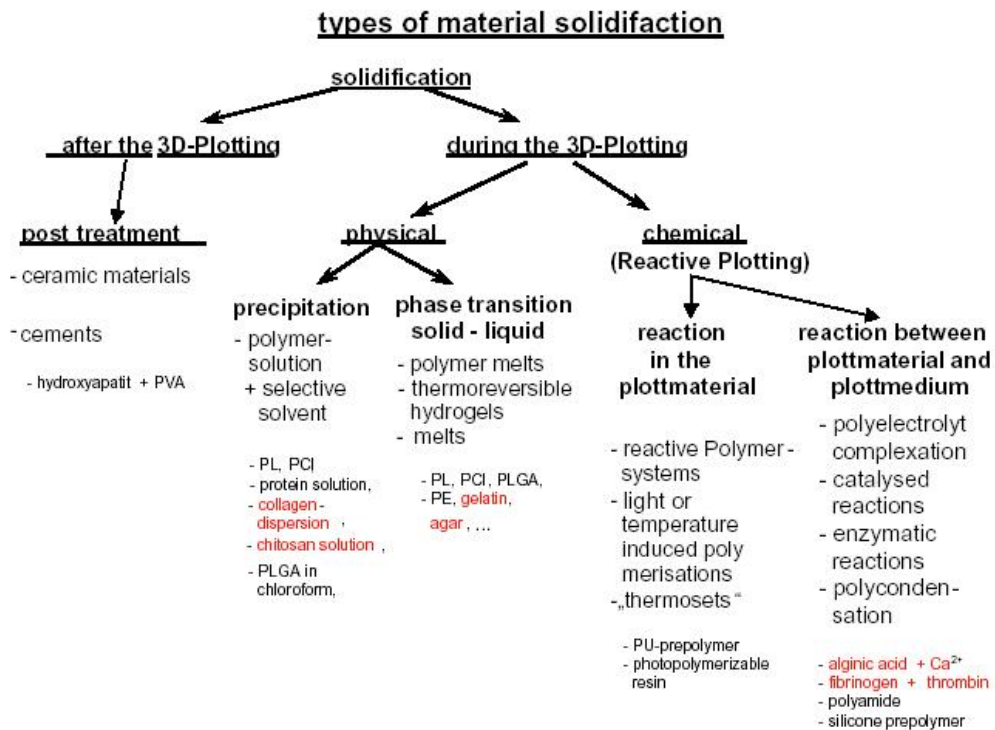

Figure 6.3. Processes and associated materials that have been used on the 3D Bioplotter. (Courtesy Freiburg Materials Research Center)

Beyond processing a range of biomaterials, the Bioplotter can also print biological cells within hydrogels. The research group at Freiburg demonstrated the capability to print viable cells within agar gels. Cell viability was determined using MTT cell respiration tests. Light microscopy also showed viable cells that were printed within the agar gel (Figure 6.4).

The ability to print cells is a significant advance, demonstrated currently by only a few research groups worldwide. The ability to print cells using a commercial machine will enable research advances by both tissue engineering and cell biology research groups. The Bioplotter indeed represents a commercial system equivalent to cell/organ printing systems that are currently under research and development. Directly printing cell/scaffold constructs will, of course, have applications for implantable tissue regeneration systems. However, another exciting prospect for this system is the ability to create *ex vivo* tissue systems by printing cells in 3D structural configurations. For example, fully differentiated cells could be printed in different layers and grown into integrated multiple tissue systems. These *ex vivo* systems could then be used to test pharmaceuticals against disease states, viral agents, or bacterial agents.

In addition to Freiburg, the University of Manchester Institute of Technology and Science is also pursuing direct cell printing capability. Its researchers will pursue printing of cells using an ink-jet printing system, as opposed to the nozzle deposition system used by the Bioplotter. The goal will be to print one cell per droplet in the ink-jet system.

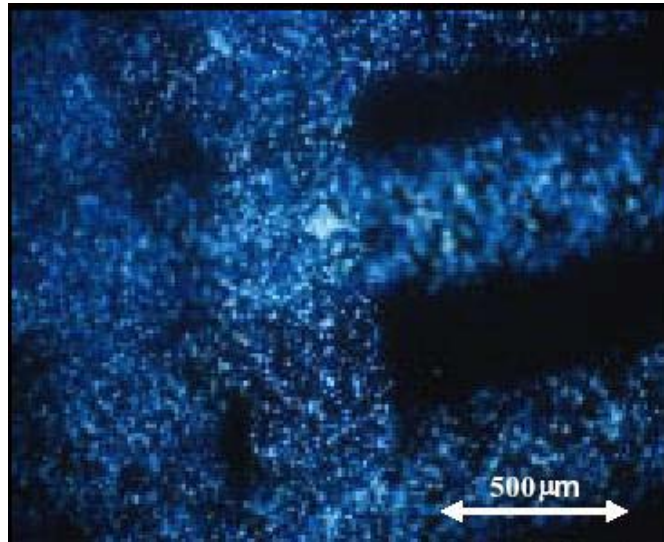

Figure 6.4. Viable cells (light dots) printed within agar gel using the 3D Bioplotter. (Courtesy Freiburg Materials Research Center)

SUMMARY

In summary, there are five goals for integrated additive/subtractive manufacturing the need to be addressed to create the ultimate fabrication system for all biomedical applications:

1. build complex shapes matching human anatomy
2. build complex, porous microstructures from biocompatible materials
3. build with living cells, genes, and proteins
4. build multiple, biocompatible materials and cells/genes/proteins together and separately on the same platform
5. build at resolutions below 10 microns over structures greater than 1cm in size

A number of research groups worldwide are pursuing and have achieved the first two goals for biomedical fabrication. This chapter is not meant to summarize all current research, so only a few examples are cited. Within Europe, the Freiburg Materials Research Center, Envisiontec, and the Fraunhofer ILT in Germany; the University of Manchester Institute for Science and Technology, the University of Loughborough, and the University of Leeds in the UK; and TNO and Isotis in the Netherlands are all utilizing additive manufacturing technology for biomedical applications. The work in Europe has covered the complete range from viable commercial applications of hearing aid shells and dental fixtures, to cutting edge technology of printing cells within materials. The 3D Bioplotter machine from Freiburg and Envisiontec is especially noteworthy for its capability to fabricate from a wide range of biomaterials and its capability to print viable cell/material constructs.

A number of research issues still remain to be studied and resolved. These include the capability to build multiple biomaterials at once, and to build with increasing resolution down to the 10-micron level. Furthermore, the capability for printing cells will need to be expanded from printing cells only in hydrogels to printing cells in hydrogels within other material constructs that include bioceramics and biopolymers. In addition, there are also scaffold design questions that remain to be answered, such as how to most efficiently design from medical image data, what are the most important design considerations for tissue engineering scaffolds, and how to balance and incorporate functional and biological requirements in scaffold design. These issues are beyond the scope of this chapter but are reviewed by Sun et al. (2004). A great deal of progress in biomedical fabrication has been made by the European research groups, which is at least on a par with efforts worldwide. The ability to push current research fabrication efforts to commercial application

will depend on the capability to meet the five goals outlined in this chapter in an economically feasible manner.

REFERENCES

- Arnst, C., and Carey, J. 1998. Biotech bodies. *BusinessWeek* July 27 cover story.
- Boland, T., V. Mironov, A. Gutowska, E.A. Roth, and R.R. Markwald. 2003. Cell and organ printing 2: fusion of cell aggregates in three-dimensional gels. *Anat Rec.* 272A:497-502.
- Cooke, M.N., J.P. Fisher, D. Dean, C. Rimnac, and A.G.Mikos. 2002. Use of stereolithography to manufacture critical-sized 3D biodegradable scaffolds for bone ingrowth. *J. Biomed. Mater. Res. Part B: Appl. Biomater.* 64B:65-69.
- Harryson, O.L.A., D.R. Cormier, D.J. Marcelling-Little, and K.R. Jajal. 2003. Direct fabrication of metal orthopedic implants using electron beam melting technology. *Solid Freeform Fabrication Symposium Proceedings*, ed. D.L. Bourell, R.H. Crawford, J.J. Beaman, K.L. Wood and H.L. Marcus, 439-446.
- Heule, M., S. Vuillemin, and L.J. Gauckler. 2003. Powder-based ceramic meso- and microscale fabrication processes, *Advanced Materials* 15:1237-1245.
- Hollister, S.J., R.A. Levy, T.M.G. Chu, J.W. Halloran, and S.E. Feinberg. 2000. An image based approach to design and manufacture craniofacial scaffolds. *Int. J. of Oral/Maxillofacial Surgery* 29:67-71.
- Landers, R., U. Hubner, R. Schmelzeisen, and R. Mülhaupt. 2002a. Rapid prototyping of hydrogel structures – Scaffolds for artificial organs. *Int. J. Artificial Organs* 25:622-623.
- . 2002b. Rapid prototyping of scaffolds from thermo-reversible hydrogels for tissue engineering applications. *Biomaterials* 23:4437-4447.
- Sherwood, J.K., S.L. Riley, R. Palazzolo, S.C. Brown, D.C. Monkhouse, M. Coates, L.G. Griffith, L.K. Landeen, and A. Ratcliffe. 2002. A three-dimensional osteochondral composite scaffold for articular cartilage repair. *Biomaterials* 23:4739-4751.
- Sun, W., A. Darling, B. Starly, and J. Nam. 2004. Computer-aided tissue engineering: Overview, scope and challenges. *Biotechnol. Appl. Biochem.* 39:29-47.
- Taboas, J.M., R.D. Maddox, P.H., Krebsbach, and S.J. Hollister. 2003. Indirect solid free form fabrication of local and global porous, biomimetic and composite 3D polymer-ceramic scaffolds. *Biomaterials* 24:181-194.
- Webb, P.A. 2000. A review of rapid prototyping (RP) techniques in the medical and biomedical sector. *Journal of Medical Engineering & Technology* 24:149-153.
- Zein, I., D.W. Hutmacher, K.C. Tan, and S.H. Teoh. 2002. Fused deposition modeling of novel scaffold architectures for tissue engineering applications. *Biomaterials* 23:1169-1185.

CHAPTER 7

ENERGY AND ENVIRONMENT

David W. Rosen

INTRODUCTION

At the outset of this WTEC study, the panelists and sponsors hypothesized that research was beginning to address the additive/subtractive (A/S) manufacture of components for energy systems and that the potential environmental benefits of A/S technologies would be of particular interest in Europe, given its leadership in environmentally benign manufacturing. What the panel found was that while these areas were of considerable interest, little research was ongoing. However, many of the panel's site hosts thought that these areas would receive significant attention in the near term.

In this chapter, the topic of A/S applications in energy systems emphasizes the work being done in the U.K. on fuel cells and batteries. Related to environmental considerations, the chapter describes several European projects focused on improving process efficiency in A/S manufacturing. Interesting discussions are also underway in Europe to consider entirely new projects that might take advantage of the flexible geometries and materials possible with freeform A/S techniques, with potentially sweeping impacts. Several references to U.S. research are presented for comparison.

ENERGY-RELATED A/S APPLICATIONS

The most prominent uses of additive/subtractive technologies in energy applications are those that apply to fuel cells and batteries. Both fuel cells and batteries are electrochemical devices that convert the chemical energy of a fuel (methanol, hydrogen, natural gas, gasoline, etc.) and an oxidant (air or oxygen) into electricity. Both have a positively charged anode, a negatively charged cathode, ion-conducting electrolyte material, and current collectors. These electrochemical devices generate electricity without combustion of the fuel and oxidizer, unlike traditional methods of electrical energy generation. As a result, they generate significantly fewer airborne pollutants such as nitrogen and sulfur and have potentially lower maintenance costs. However, much work needs to be done to achieve the potential of these systems.

Two primary barriers to increased commercial acceptance of fuel cells and batteries are their cost, size, and efficiency. Fuel cells are not used to power cars since they are much more expensive and much larger than conventional engines. For portable electronics, users demand longer life from the batteries that power them. A/S technologies have the potential for significantly improving the cost and size efficiency of fuel cells and batteries.

Fuel cells and batteries are essentially layered systems that have complex material compositions and that require many interacting physical and chemical processes to function properly. A/S technologies enable materials to be processed on a layer-by-layer, or even point-to-point, basis, which potentially enables complex material compositions and geometric structures to be fabricated. The research challenge is to

develop improved A/S manufacturing and materials technologies that result in less costly and smaller energy producing devices.

Fuel Cells

Fuel cells are often classified into two broad categories: solid-oxide and proton exchange membrane (PEM). *Solid oxide cells* operate at high temperatures and are typically used for stationary, power-plant-like applications. *PEM cells* operate at lower temperatures and are typically used for small, portable applications. Commercial laptop power supplies based on PEM fuel cells are now available from some Japanese companies. A notable exception to this classification division is the use of solid oxide cells for cars.

Regardless of their type, fuel cells have similar structures (Larminie and Dicks 2000). Fuel in the form of a liquid or gas flows into the anode where hydrogen ions (protons) and electrons are produced. The electrons are collected and flow through an external circuit. This is where the power is drawn from the cell. The hydrogen ions flow through the central membrane or electrolyte to the cathode, where they are oxidized to produce water. In other operating mechanism, oxygen ions flow from the cathode to the anode to react with the fuel. Either way, catalysts are necessary in order to drive these chemical reactions.

An example PEM fuel cell design is shown in Figure 7.1, in which methanol is used as the fuel. At the anode, a series of reactions occur, eventually producing CO_2 , protons, electrons, and possibly, simple hydrocarbons. Platinum-ruthenium films are typically used, where platinum acts as the catalyst and ruthenium is present in small amounts to control carbon monoxide production, which could negatively impact fuel cell performance. A substantial amount of CO_2 is produced in methanol-fueled cells, so CO_2 extraction is also of concern. Metal mesh current collectors collect the electrons and route them externally across a load to another metal mesh at the cathode. Protons react with the electrons and oxygen, typically from the air, to produce water. In this design, the gas diffusion layer acts to diffuse fuel from its reservoir to coat the anode and simultaneously to enable the CO_2 to diffuse across to the CO_2 removal channels. A design such as this is meant to have an operating temperature of $50\text{--}70^\circ\text{C}$ and to produce 1 to 50 W.

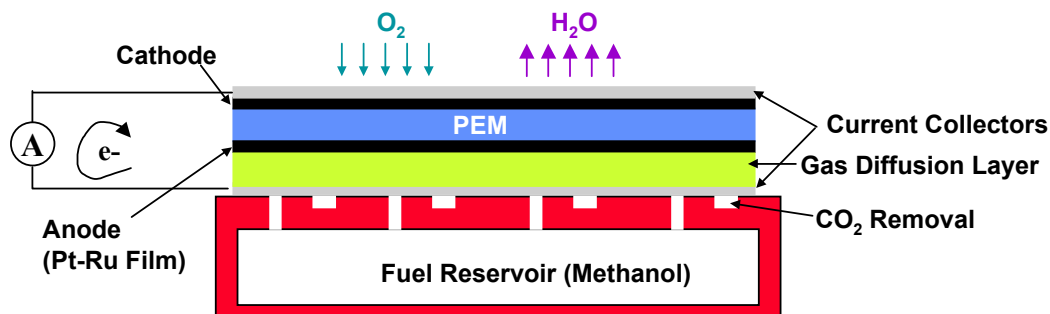

Figure 7.1. Example PEM fuel cell configuration.

In solid oxide fuel cells, catalysis is favorable only at high temperatures (greater than 500°C , usually). Higher efficiencies can be achieved at these higher temperatures, but the temperatures cause durability and reliability problems. Many metals used as conductors and electrodes in other applications lose their integrity at the $600\text{--}800^\circ\text{C}$ operating temperatures. As a result, ceramic materials are typically used instead of metals. Although the ceramics are functional, they are not very durable, due to thermal expansion mismatches and thermal fatigue, resulting in shorter operating lives and more maintenance issues.

Imperial College Fuel Cell Research

Although considerable fuel cell research is underway in Europe, the only site with a significant fuel cell research that WTEC panelists visited was Imperial College. Some comments about work at other sites will be given at the end of this section. The panelists did not see A/S related research on fuel cells or batteries at any of the sites visited.

At Imperial College, the major fuel cell research programs are within the Materials Science Department. The Center for Ion Conducting Membranes, comprising some 50 researchers and staff, is the largest research center in the U.K. on fuel cells and has been in existence longer than any other major center. It is notably multidisciplinary, drawing participation from the chemical engineering, electrical engineering, and mechanical engineering departments, and partnership with industry (Rolls-Royce, Johnson-Matthey, and Morgans) as well as collaborations with U.S. universities and research institutions (Georgia Institute of Technology and Oak Ridge National Laboratories).

Most of the research is focused on solid oxide fuel cells, although there is significant research on PEM cells as well. Activities vary from fundamental catalysis and electrochemistry to components, stack, and systems. The work also considers energy policy, economics, and environmental science. The Imperial researchers see advances in fuel cells contributing to high-end consumer electronics and also to power generation in remote areas in the near term (3–5 years); to high-load commercial or industrial power generation in the medium term (5–10 years); and to power generation for automobiles in the longer term (15–20 years).

From the materials and catalysis viewpoints, the primary research issues involve solid oxide electrodes (anode and cathode) and the electrolyte that separates the electrodes. Researchers at Imperial College are focusing on cerium oxide as an electrode material and are investigating doping agents, including gallium. Hydrogen reduction reactions that form protons and electrons occur at sites where hydrogen fuel, the catalyst, and the electrolyte all come together. More such sites can be available if the electrode has large surface area; hydrogen gas can reach more areas if small pores are available for it to diffuse throughout the electrode. As a result, it is desirable for the electrodes to have about 30 percent porosity. Furthermore, the electrode-electrolyte-electrode layered structure must support multiple functions. Electrodes must be good electrical conductors and must allow gas diffusion. The electrolyte must be a good ionic conductor (for protons). It is in these areas that A/S manufacturing might have a beneficial role. However, the electrode-electrolyte interface is typically about 10 μm thick, meaning that materials must be graded across this thickness, necessitating fabrication features of about 1 μm in size; this would challenge the capabilities of A/S manufacturing systems.

Electrophoretic deposition and patterning have been used at Imperial College to fabricate electrodes and other fuel cell components. Other manufacturing processes for fabricating fuel cell components include extrusion, plasma spray, and vapor deposition. The researchers have not attempted to create either graded structures or patterned deposits. They identified additive manufacturing of fuel cell components to be of considerable interest.

Other U.K. Research Programs

Other U.K. research into fuel cell materials and fabrication was reported to be at Queen Mary College, University of London, where Dr. Julian Evans' research group has focused on the additive manufacture of ceramics. His group had successfully ink-jet-printed microdots of ceramics. Active research was being pursued in the combinatorial design and materials synthesis of ceramics, which may have application to fuel cell manufacture.

Commercialization Barriers

As the researchers at Imperial College noted, barriers to more commercial penetration of solid oxide fuel cells include their high cost-performance ratio. Their mechanical and chemical durability and reliability need significant improvement. Lower operating temperatures are needed to improve reliability, since metals then could be used for electrodes. Similarly, better catalysts are needed at those lower temperatures. The researchers noted that A/S processes might provide improved methods for fabricating electrodes and electrolytes with desired material compositions and porosities.

Regarding PEM fuel cells, the critical barrier is generally regarded as the power density (power per unit volume), since PEM applications are usually size-critical. Improved membrane materials and designs are needed that improve ion conductivity while reducing fuel crossover (leakage of fuel through the membrane). Many fuel cell developers are focusing on hydrogen as a fuel, rather than on hydrocarbons such as methanol

or formic acid, since the extraction of hydrogen from these fuels requires significant energy and can cause pollution. However, use of hydrogen as a fuel for small fuel cells raises other issues, including safety and size (fuel tanks for gaseous hydrogen will be large). Another limitation is that electrodes tend to be expensive, since they are typically platinum or platinum-ruthenium combinations; more efficient electrodes are desirable to lower the platinum content and cost. Again, A/S processes may enable cost and size improvements to PEM fuel cells if membrane and electrode manufacturing processes can be improved.

Batteries

Although the WTEC panel did not observe any A/S-related research on batteries, considerable interest in battery technology is evident worldwide. In the U.K., research groups are working on new materials that have application to batteries. In the United States, hundreds of millions of dollars have been spent in the past few years to improve batteries, with an emphasis on automotive applications. Batteries have structures basically similar to fuel cells, although batteries can supply only a fixed amount of energy, while fuel cells rely on external energy sources (fuel). Recent research has pursued the additive manufacture of batteries.

In the School of Chemistry at the University of Nottingham, a research group is investigating the synthesis and processing of new materials. One project utilizes self-assembly to produce nanostructured materials with controlled pores and channel sizes. These are used for transport, separation, and storage applications, such as hydrogen storage. Other materials could be used for environmental cleanup, since their structures enabled them to absorb and store other materials, such as oil. Nanotubes and nanoribbons in LiN and BN have also been synthesized, which have application to batteries.

In the United States, additive manufacturing of batteries has been pursued since the 1990s. The Oak Ridge National Labs (ORNL) have had many years of successfully applying microelectronics fabrication technology and have achieved layered battery manufacturing processes with the materials that they have developed. The Thin-Film Battery group within the Condensed Matter Sciences Division of ORNL (www.ssd.ornl.gov) has developed novel lithium and lithium-ion batteries (Bates et al. 2000). Its researchers use standard sputtering and evaporation processes to fabricate their thin-film, layered battery structures.

At the Naval Research Laboratories (NRL), Doug Chrisey's group has fabricated working primary and secondary (non-rechargeable and chargeable) microbatteries using its patented matrix-assisted pulsed-laser deposition direct-write (MAPLE DW) process (Pique et al. 2000). The researchers demonstrated a battery that could power a digital watch, shown in Figure 7.2. The MAPLE DW process enables the patterned deposition of many types of metal, ceramic, and polymer materials. The batteries will be designed to recharge via energy harvesting of solar and radio-frequency waves to power microelectronic systems requiring minimal maintenance.

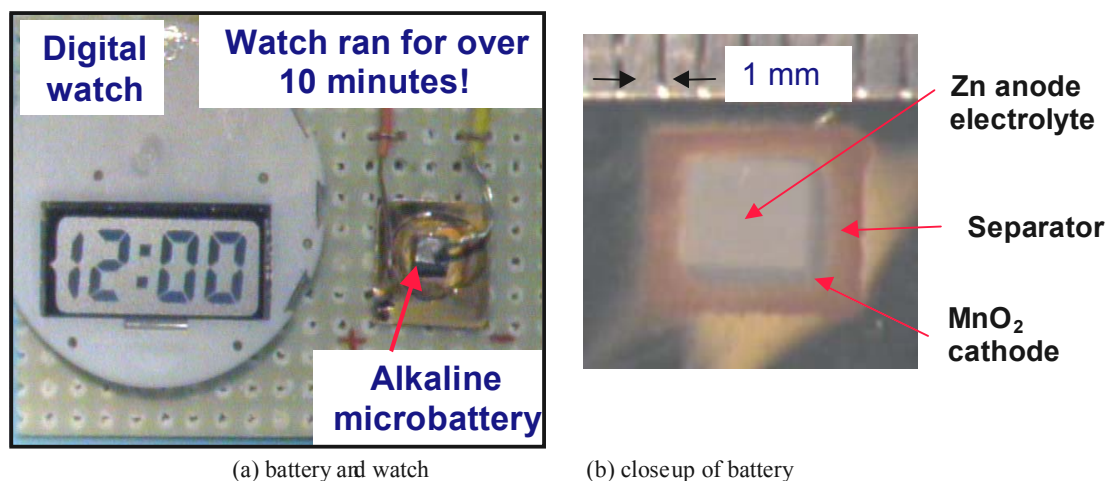

Figure 7.2. Example battery fabricated using A/S processes. (Courtesy Doug Chrisey, NRL)

At Cornell University, Dr. Hod Lipson's group has demonstrated a working battery with zinc-air chemistry that was fabricated by extruding battery components in a layered manner (Malone 2003). The group built its own automated three-axis extrusion system. A slurry of zinc and KOH solution was used to deposit the anode and cathode. Catalyst and separator layers were also fabricated. Conductive pastes were deposited for use as wires. The group demonstrated the battery by driving a small electric motor.

ENVIRONMENTALLY BENIGN MANUFACTURING

The WTEC panel saw comparatively little research ongoing in Europe in the area of environmentally benign manufacturing as related to A/S technologies. However, many site visit hosts expressed interest in the area and anticipated that much more activity will focus on this, particularly as more production manufacturing applications emerge.

Based on a cursory examination of many A/S technologies, the following observations can be made about their likely environmental characteristics:

- Since additive technologies only deposit or process material that will comprise the part (ignoring support structures), they are inherently efficient in their use of materials, particularly as compared to subtractive processes.
- Parts made using A/S processes can be manufactured in shapes that result in lighter, more material-efficient designs since A/S processes enable designers to put material where it will be used most efficiently.
- Such lightweight designs will result in lower life-cycle operating costs for many types of products. For example, cars could be lighter and more energy efficient if their materials could be utilized more efficiently.
- It is likely that many other environmentally related characteristics of A/S technologies will emerge as more attention is devoted to these technologies.

Research is needed to investigate the issues related to these observations. The panelists saw some work in Europe that addresses the energy efficiency of designs fabricated using A/S technologies, including three projects that will be presented in this section. The first addresses the recycling of powder material used in SLS (selective laser sintering) machines. The second concerns energy-efficient tooling for injection molding. Both of these are compared with similar U.S. projects. The third project is on the topic of structural homeostasis, wherein buildings may be regarded as biomimetic structures.

Powder Recycling

In the Freiburg Materials Research Center (FMF), a project addressed the recycling of polyamide materials for SLS machines. These are the nylon materials marketed as DuraForm® materials by 3D Systems. Since time did not allow further discussion during the FMF site visit, not much is known about the project or the results; however, it appeared this involves the re-use of powder from one build to another. In SLS machines, polymer powders degrade during a build since the entire vat of powder is heated to just under the powder's melting temperature.

A similar project was completed at the University of Louisville (Gornet, Davis, and Richardson 2003). Researchers there showed that both DuraForm® polyamide (PA) and the glass-filled DuraForm® (GF) materials retained good properties for a small number of builds, but started degrading significantly after that. Duraform GF degraded faster than Duraform PA. They proposed a "melt index" for relating material tensile strength, elongation, and surface finish. After a target melt index is selected for a particular application, a blending schedule can be determined for mixing new powder with previously used powder. Using the Louisville approach, machine operators can monitor and control material quality and the quality of manufactured parts for the SLS process.

Energy Efficient Tooling

In injection molding, conformal cooling channels in the mold follow (conform to) the contours of the part cavity. If designed properly, conformal channels can cool newly injected parts up to 40 percent faster than straight cooling channels. It can be very difficult to cut conformal channels in molds; straight holes can be drilled easily, but channels that curve in multiple directions can be very difficult to fabricate. A/S technologies provide opportunities to fabricate molds with conformal channels without the need for post-fabrication cutting of channels. Researchers at BIBA in Germany developed software to design and analyze molds with conformal cooling channels. An example is shown in Figure 7.3. Many other researcher groups around the world, and some companies, have investigated the design, analysis, and manufacture of molds with conformal cooling.

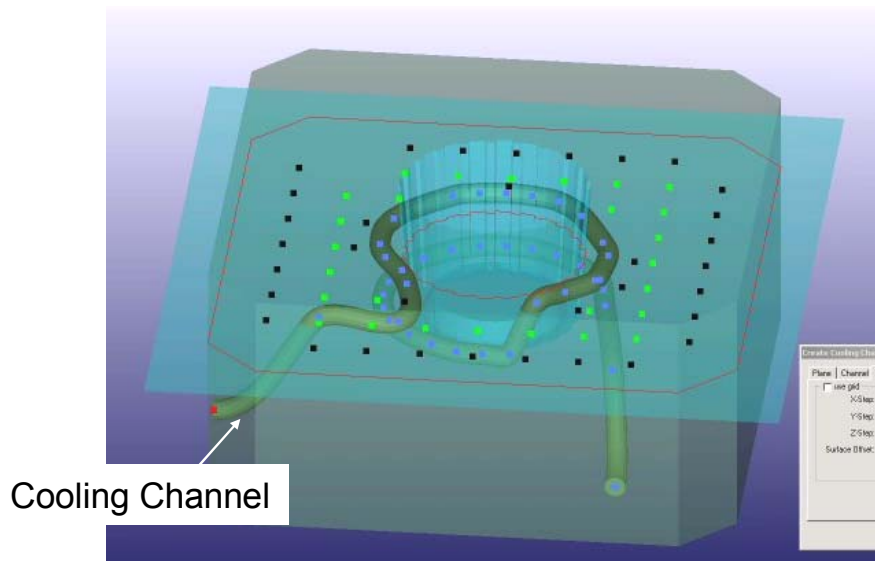

Figure 7.3. Mold with conformal cooling channel. (Courtesy BIBA)

At the University of Leeds, a project started in fall 2003 to investigate the energy efficiency of conformal cooling in injection molds. The Leeds group will investigate molds produced on SLS machines in LaserForm™ materials from 3D Systems. The objective of the project is to quantify the benefits, including energy and cost savings that can be achieved using conformal cooling channels in SLS-fabricated molds. The most obvious benefit is reduced cooling time, with a commensurate decrease in cycle time. Decreased cooling implies a reduction in the energy required for cooling, reducing the environmental impact of injection molding.

A second area of environmental impact reduction is the reduced need over the long term for injection molding machines and molds, due to an increase in molding machine productivity (reduced molding cycle time). Relationships among part characteristics and conformal cooling channel designs will be developed to help quantify and generalize the environmental, productivity, and cost impacts of SLS-fabricated molds with conformal channels.

A project with similar objectives is underway at the University of Michigan, supervised by Drs. J. Mazumder and S. Skerlos (Morrow et al. 2004). Presently, the project is funded through the NSF PREMISE program. The overall objective of this project is to “develop supporting technology and knowledge to facilitate the diffusion of Closed Loop Direct Metal Deposition (DMD) technology as an energy, cost, performance, and environmentally improved alternative to traditional manufacturing processes.” Its focus is on the use of the DMD technology to fabricate injection molds with two types of features for thermal control: integrated mixed alloy heat sinks, and conformal cooling channels.

A shorter-term objective of the Michigan/NSF PREMISE program is to develop decision methods for designers to use when designing molds to achieve the least life cycle emissions, energy, and cost relative to traditional mold and die design and manufacturing pathways. Early results demonstrate the conditions under which DMD technology can be used advantageously over conventional manufacturing processes. Benefits achieved by DMD are typically a strong function of molded part complexity and geometry. The researchers have identified the raw material used in DMD (i.e., metal powders) as an important consideration in the environmental impact, due to the energy required to produce some types of powders.

Structural Homeostasis

Homeostasis denotes the tendency toward equilibrium among the various elements of an organism. The ability to maintain one's body temperature within a narrow range is a typical example. Researchers at Loughborough University developed the concept of structural homeostasis to refer to a building's or structure's capability to maintain a stable environment. By taking a biomimetic approach, they hope to learn from nature's ability to achieve homeostasis in living organisms.

The Loughborough researchers consider that buildings can be seen as hierarchical structures, composed of increasingly smaller open spaces and physical separators (e.g., walls), beginning with the entire building, moving down the hierarchy to a room, a wall, an electrical outlet, etc. Living organisms also have a hierarchical organization, which enables them to maintain near-equilibrium states. They are collaborating with Dr. Berokh Khoshnevis at the University of Southern California who has developed an additive manufacturing process called contour crafting and shown how it could scale up to fabricate buildings. As a result, the Loughborough University researchers believe that they have considerable leeway in designing buildings that may exhibit homeostasis.

As part of their investigation, the Loughborough University researchers want to investigate the large termite mounds that are found in parts of Africa. Some mounds can be several feet high. The cavities within the mound are built such that the internal temperature of the mound is maintained within a very narrow range, on the order 0.5°C, regardless of the outside temperature. They are exploring the possibility of a field trip to Africa to excavate a mound, digitize the internal structure, and develop a geometric model of it in order to investigate its heat transfer properties.

This project is an excellent example of the design freedom that is enabled by the use of A/S technologies. Until the capability of fabricating hierarchical structures with complex geometries was developed, such an investigation could not have been pursued with much manufacturing realism. That is, the investigation would not have been much more than an intellectual exercise. If successful, the project could lead to buildings that are much more energy efficient, and potentially, have better environments that can be achieved using conventional building technologies.

FUTURE AND BARRIERS

Relatively few energy and environment related activities were observed during the WTEC site visits. However, many of the panel's hosts thought that both energy and environment related issues would see significant increased interest, particularly as more A/S production manufacturing applications emerge. Based on conversations during the visits and observations of other activities throughout the world, the following are the likely future and barriers regarding energy applications and the environmental impact of A/S technologies:

- Fuel Cells
 - New materials and/or processing methods are needed to enhance catalysis and lower costs to maximize their performance-cost ratio, particularly for solid-oxide fuel cells.
 - Complex microstructure is of interest, not part geometry. New materials and processing methods are needed to create electrodes and electrolyte layers with desired microstructure and graded compositions at very small size scales.

- For PEM cells, maximizing power density is key. Improved membrane materials, in addition to electrodes, are needed.
- A/S technologies offer the potential for processing fuel cell materials in a manner that achieves the desired properties.
- Batteries
 - A/S technologies have been used to fabricate batteries. Improvements are needed to achieve desired power density and performance-cost ratio.
- Environmental Issues
 - The environment is emerging as a critical issue for A/S technologies to some in Europe and is starting to receive some attention in the United States.
 - A/S technologies have some environmental advantages, based on their capabilities to process only the material that comprises a part and their capability to utilize material and energy efficiently. Research to investigate and quantify the A/S environmental impact has only just started.
 - Biomimetics, that is, improved capability to mimic biological systems, may lead to insights that enable new methods for solving problems and take advantage of the unique capabilities of A/S technologies.

REFERENCES

- Bates, J.B., N.J. Dudney, B. Neudecker, A. Ueda, and C.D. Evans. 2000. Thin-film lithium and lithium-ion batteries. *Solid State Ionics*, 135:33-45.
- Gornet, T.J., K.R. Davis, and K.M. Richardson. 2003. Material testing method for process control of direct manufacturing in the SLS process. *Proceedings VR@P International Conference on Advanced Research in Virtual and Rapid Prototyping*, 491-496. Leiria, Portugal: Leiria Polytechnic Institute.
- Larminie, J., and A. Dicks. 2000. *Fuel cell systems explained*. Chichester, U.K.: John Wiley & Sons.
- Malone, E., K. Rasa, D. Cohen, T. Isaacson, H. Lashley, and H. Lipson. 2003. Freeform fabrication of 3D zinc-air batteries and functional electromechanical assemblies. *Proceedings Solid Freeform Fabrication Symposium*, ed. D.L. Bourell, R.H. Crawford, J.J. Beaman, K.L. Wood, and H.L. Marcus, 363-374. Austin, TX: University of Texas at Austin, Mechanical Engineering Department.
- Morrow, W.M., H. Qi., I. Kim, J. Mazumder, and S.J. Skerlos. (In press). Laser-based and conventional tool and die manufacturing: Comparison of environmental aspects. In *Proceedings of the Global Conference on Sustainable Product Design and Life Cycle Engineering*, September 29–October 1, Berlin 2004.
- Pique, A., D.B. Chrisey, J.M. Fitz-Gerald, R.A. McGill, R.C.Y. Auyeung, H.D. Wu, S. Lakeou, V. Nguyen, R. Chung, and M. Duignan. 2000. Direct writing of electronic and sensor materials using a laser transfer technique. *J. Mater. Res.* 15 (9):1872-1875.

CHAPTER 8

CONCLUSIONS AND FUTURE REQUIREMENTS

Joseph J. Beaman and Clint Atwood

This chapter gives an assessment of Europe's current activities and future requirements in the research and development of additive/subtractive (A/S) manufacturing technologies, based on the WTEC panel's visits to 15 European sites and on its review of the scientific literature. Since this report is an extension of the WTEC study completed in 1997 entitled *Rapid Prototyping in Europe and Japan* (Prinz et al. 1997), it highlights only European activity and advancement occurring after 1996-7.

EUROPEAN ACTIVITY IN A/S MANUFACTURING

European Union Efforts to Advance Solid Freeform Fabrication or Layered Processes

At the time of the WTEC site visits in late 2003, the European countries had recently finished a coordinated program entitled RAPTIA. This was a European thematic network of research organizations, universities, and industries working with rapid tooling. The network was funded by the European Commission starting in 1999; the project organizer was the Netherlands Organization for Applied Scientific Research, TNO. The project was to be followed by a new seven-year program, NEXTRAMA, the Network of Excellence in Rapid Manufacturing, funded by the European Union's Sixth Framework Program (FP6). NEXTRAMA's mission is to achieve efficient and sustainable rapid manufacturing industrial processes through a broadly coordinated effort to create a permanent support organization. Shared work, knowledge, experience, and facilities are expected to facilitate definition of the primary development themes and related research. Annual funding levels of over \$1.68 million per year will provide funds for organization and management of the project. Individual research activities will receive additional EU funding or will be funded by other government or industry programs.

Individual National Efforts

All individual European countries that the WTEC panel visited are investing in solid freeform fabrication (SFF) technology. The combined level of activity and infrastructure is superior to that in the United States. In the United Kingdom, the Engineering and Physical Sciences Research Council and industry are providing funding for programs. In Sweden, there is government and industrial support for SFF technology development through semipublic research institutes. In Finland, the National Technology Agency, TEKES, is providing support for universities, sometimes in cooperation with industry. In Germany, the Fraunhofer institutes, industry, and government are supporting numerous programs. TNO is providing support to additive/subtractive programs there.

Major Initiatives for Rapid Manufacturing Development

Besides the coordinated European effort evident in the European Union's NEXTRAMA program, European countries are individually setting up government-academic-industrial centers and programs to support

development of rapid manufacturing capabilities. In the United Kingdom, the University of Loughborough's Innovative Manufacturing Research Center (IMRC) has a budget of \$24 million over five years. Its Rapid Manufacturing Research Group has a budget of \$1.25 million per year, guaranteed for 5 years, that covers 35 staff and Ph.D. students. There are also major research efforts at the University of Manchester Institute of Science and Technology's Laser Processing Research Center; the University of Liverpool's Foresight Center, and the University of Nottingham's Rolls Royce University Technology Center.

In Germany, the Fraunhofer laboratories and the University of Freiburg have major SFF manufacturing initiatives. At the Fraunhofer Institute for Laser Technology (ILT), there is work in direct metal laser fabrication, and at the Institute for Production Technology (IPT) there is ongoing work on combining layered manufacturing with subtractive machining. At the University of Freiburg, there is materials and process development for SFF processes.

Sweden has at least three separate companies involved in the commercialization of rapid manufacturing: ARCAM, fcubic, and SpeedPart. There are also at least three research institutes investigating this technology: IVF, IUC, and SCI. Finland's Helsinki University of Technology is studying direct metal selective laser sintering for rapid manufacturing. The coordinator of both the RAPTIA and NEXTRAMA projects is TNO in the Netherlands, which has a very active program in rapid manufacturing.

European Rapid Manufacturing Timelines

An insight into the European view of SFF and rapid manufacturing can be found in the following two figures. Figure 8.1 shows the anticipated rapid prototyping and manufacturing market development timeline of the Swedish company fcubic. This depicts generation 1 as prototyping, which developed from 1986 to 2002; generation 2 as short-run manufacturing of 1 to 10,000 small complex parts, developing from 2000 to 2008; and generation 3 as medium-run manufacturing of 1 to 1,000,000 parts, developing from 2006 to 2012. For generations 1, 2, and 3, respectively, the layer thicknesses required are reported to be .2 mm, .05 mm, and .025 mm; the speeds required in the 3 generations are 100, 2, and .2 seconds per layer; and the times to manufacture a 100-mm-high part in the 3 generations are 16.7, .5, and .1 hours. Figure 8.2 shows a similarly aggressive view of introducing layer-based manufacturing, from Finland's RPI (Rapid Product Innovations).

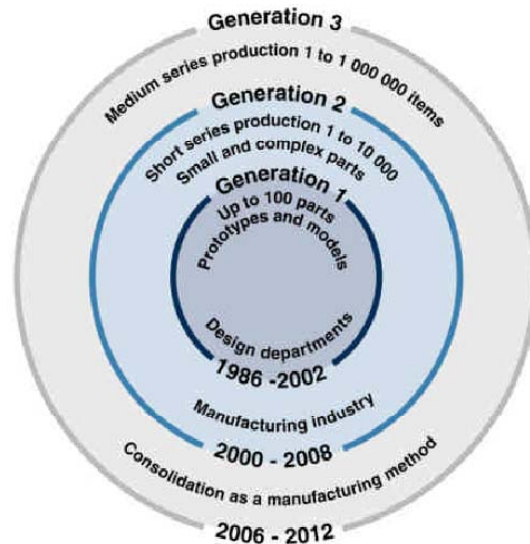

Figure 8.1. Rapid manufacturing timeline from Sweden's fcubic.

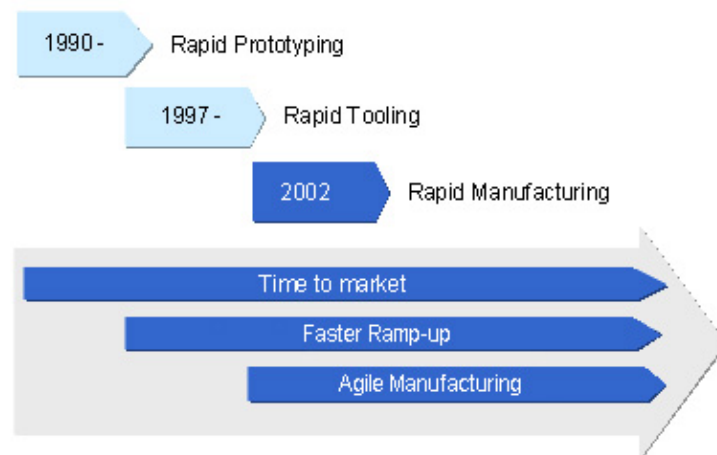

Figure 8.2. Rapid manufacturing timeline in Finland from Rapid Product Innovations.

Broad Research and Development Themes in Europe

There are several points to be made concerning the status of research and development of rapid manufacturing in Europe overall.

1. There is substantial funding in Europe for important process development of SFF technologies that were in many cases initiated in the United States, such as laser sintering of powders, direct metal deposition and laser fusion of powders, and ink-jet printing techniques.
2. As compared to the situation at the time of the 1996-7 WTEC study, there is more innovative and leading-edge R&D going on in Europe. Examples of this are the ARCAM e-beam development and the Envisiontec Bioplotter.
3. As compared to the United States, there are much closer ties in Europe between university research and industrial needs, but basic science is still present in the research.
4. Total R&D activity in SFF is presently higher in Europe than in the United States.
5. The number of truly integrated layer-by-layer additive/subtractive processes under development is limited. There is work in Germany at the Fraunhofer IPT on Control Metal Buildup that combines laser deposition with machining, and at Concept Laser GmbH on combining laser sintering, laser marking, and laser machining. In contrast to U.S. practice, European emphasis is on opportunities in rapid manufacturing generally, not on any one specific process. European researchers are interested in the entire process chain to create new business models. European customers want function, and new SFF capabilities have led to new applications such as dental implants and hearing aid shells.
6. The combined work of the University of Freiburg and Envisiontec for tissue scaffolding is as or more advanced than any other similar work anywhere. The 3D Bioplotter is the first biospecific fabrication system that can print the entire range of biomaterials and cells that will be the future of biofabrication. This commercial system is as advanced as research prototypes in the United States.
7. There is no work in fabricating fuel cells with SFF, but European considerations of various design and application possibilities are innovative, and the general concept is of interest.
8. There is a pervasive acknowledgement by the WTEC panel's European hosts of inadequacies in existing CAD programming for design of parts to be fabricated by SFF. There is a keen recognition for the need for more user-friendly software.
9. As in the United States, the number of rapid prototyping service bureaus has declined in Europe. Many companies are obtaining concept modelers for rapid prototyping, which is a separate market from rapid manufacturing.

10. All European sites that the WTEC panel visited would encourage collaboration on international programs/projects with U.S. collaborators.

FUTURE REQUIREMENTS AND BARRIERS

There are unique sets of prerequisites for successful rapid manufacturing of parts and products, for biological prototyping and manufacture, and for fuel cell prototyping and manufacture.

Requirements for Rapid Manufacture of Parts

Design Tools for SFF

Present computer solid modeling design tools focus on features (holes, slots, etc., that are to be machined) that have little or no significance to SFF processes. Entirely new CAD design tools need to be developed that aid the designer to exploit the capabilities of SFF.

Speed

The fastest SFF systems cannot compete with high volume production processes like injection molding or die casting once molds are made. But even with today's SFF systems, there are applications that make economic sense. Examples are Invisalign's orthodontic products, Siemen's hearing aid shells, and On Demand Manufacturing's aerospace parts for Boeing. These applications are relatively low-volume, complex, customizable parts. Speed needs improvement to broaden production opportunities.

Post Processing and Finishing

Presently, most SFF parts require hand finishing in order to meet product specifications, especially for surface finish. Hand-finishing is not a good option for production applications because of cycle time and product variability. The process chain needs to be automated and integrated to eliminate hand processing.

Accuracy and Repeatability

Present systems cannot achieve the standards of performance required for many production applications. Systems need to reliably produce +/- .125 mm accuracy.

Standards

With the exception of the STL file format, the SFF industry is far from being standardized. The lack of standards inhibits growth, especially in production applications. Market-driven standards need to emerge.

Cost and Size

Along with cycle time, production costs and size of the working envelope are critical when choosing a manufacturing process. Cost will naturally come down based on installed base of systems, but further improvement is needed. System costs and working envelope need to be comparable to machining equipment.

Green Manufacturing

As production becomes more prevalent, environmental issues will become increasingly important. These issues include material usage (recycling unused powders), energy costs, and total life cycle product costs. Systems need to be designed in response to environmental concerns and considerations of total life cycle product costs.

Materials

New materials enable new manufacturing applications. The choice of materials in the present systems is limited. SFF-specific materials need to be developed for systems and applications.

Requirements for Biological Prototyping and Manufacturing

Requirements for biological prototyping and manufacturing include the following:

- Multiple material systems ranging from ceramics and polymers to hydrogels
- Processing of human body-like environments to enable printing living cells, genes, and proteins
- Features on the order of microns and control of nanoscale structure for diffusion barriers
- Information technology for handling of biological and communication data

Requirements for Fuel Cell Prototyping and Manufacturing

Requirements for fuel cell prototyping and manufacturing include the following:

- The ability to fabricate complex microstructure as well as complex geometry
- Precision multiple material processes on the scale of a micron
- The ability to control porosity
- The ability to design and build pathways for efficient material and energy flows in the cell
- The integration of multiple process steps for efficient manufacturing

OTHER OBSERVATIONS**University-Industry Joint SFF R&D in China**

Although the panel did not visit China for this report, there was repeated mention of the significant effort that is being initiated in China. Two sites in China appear to be of significance. Tsinghua University has a large research group in SFF under the direction of Professor Yan. This group is associated with Beijing Yinhua company. The group is developing an extrusion-based system, a laminated object system, a sand system, and a tissue scaffold system. The China National Machinery Import and Export Corporation is the sales agent. The second site is Huazhong University of Science and Technology, which has 120 Researchers in SFF. They comprise the largest single SFF R&D group in the world at one site. The group is associated with Wuhan Binhu Corporation and is developing selective laser sintering, laminated object manufacturing, and stereolithography.

REFERENCES

Prinz, F.B., C.L. Atwood, R.F. Aubin, J.J. Beaman, R.L. Brown, P.S. Fussell, A.J. Lightman, E. Sachs, L.E. Weiss, and M.J. Wozny. 1996-7. WTEC panel report on rapid prototyping in Europe and Japan (Vols. 1 and 2). Baltimore, MD: World Technology Evaluation Center, Inc. Available from National Technical Information Service (NTIS), Springfield, VA (reports #PB97-162564 and #PB96-199583), or on the Web at <http://www.wtec.org>.

APPENDIX A. PANEL BIOGRAPHIES

Joseph J. Beaman

Joseph Beaman joined the faculty of the University of Texas (UT) at Austin in 1979. He is Department Chair of the Mechanical Engineering Department and Ernest F. Gloyna Regents Chair in Engineering. His specific manufacturing interest is in solid freeform fabrication. Dr. Beaman has also chaired the Rapid Prototyping Association of the Society of Manufacturing Engineers (RPA/SME), and he has an extensive industrial background with such companies as IBM, General Motors, and McDonnell Douglas.

Dr. Beaman received the National Science Foundation Presidential Young Investigator Award in 1984, its inaugural year. Other awards include UT's Faculty Excellence Award, the DuPont Young Faculty Award, the Engineering Foundation Award, the Andersen Consulting Endowed Professorship in Manufacturing Systems Engineering, and the Best Paper award for the *Journal of Dynamic Systems, Measurement and Control*. He also served as Associate Editor for this Journal for four years. He was awarded fellow status by the American Society of Mechanical Engineers (ASME) in August 1996.

Dr. Beaman's current research projects include

- Development of a Multimaterial SLS Process, National Science Foundation
- Solid Freeforming of Metallic Components, Allison Engine Company/U.S. Air Force
- Low Cost Metal Processing Using SLS/HIP, Lockheed Martin/Vought Systems/Office of Naval Research

Dr. Beaman received his B.S. from the University of Texas at Austin, his M.S. from the University of Texas at Austin, and his Sc.D. from Massachusetts Institute of Technology.

Clinton L. Atwood

Clint Atwood is a principal member of the technical staff at Sandia National Laboratories, where he has worked for 28 years. For the past three years, Clint has worked as a technical business development specialist in Sandia's Science and Technology Business Development Department. From 1990 to 2000, he worked to integrate and develop laser-assisted rapid prototyping (RP) and direct metal fabrication technologies at Sandia. Clint was Sandia's project leader for the development of the Laser Engineered Net Shaping (LENS™) technology. In addition, he developed and managed the 12-company LENS Cooperative Research and Development Agreement (CRADA). He helped pioneer the use of RP for investment casting through Sandia's FASTCAST Program.

Along with participating as expert reviewer for the National Center for Manufacturing Sciences (NCMS)-sponsored Rapid Prototyping Roadmap; peer reviewer for NSF, DARPA, and NASA-funded projects, and expert panelist for the 1996-7 World Technology Evaluation Center (WTEC) worldwide assessment of rapid prototyping technologies, Clint's contributions to the rapid prototyping industry include the following:

- Past Member, Board of Directors of the Laser Institute of America (LIA)
- Chairman (2 terms), Rapid Prototyping Association/Society of Manufacturing Engineers Board of Advisors
- Past Member, Board of Advisors of Rapid Prototyping Association of SME
- Past President, North American Stereolithography Users Group
- Past President, DTM Selective Laser Sintering Users Group
- Past Member, Advisory Committee of University of Texas Solid Freeform Fabrication Symposium
- Past Member, Ohio Rapid Prototype Process Development Consortium
- Charter Member, University Rapid Prototyping Consortium
- Long-time Member, SME Rapid Prototyping and Manufacturing Conference Committee
- Member, SME Computer Technologies Solution (Autofact) Conference Committee

Theodore L. Bergman

Theodore Bergman is Associate Dean of Research and Outreach in the School of Engineering at the University of Connecticut. He served as head of the Mechanical Engineering Department at the University of Connecticut from 1998 to 2004. From 1985 to 1996, he was with the Department of Mechanical Engineering at the University of Texas at Austin. Dr. Bergman's research centers on heat transfer and fluid mechanics as applied to thermal processing and manufacturing of materials and products. Recent investigations include measurement and simulation of solid shape evolution during non-isothermal laser-induced sintering of polymer powders for net shape manufacturing; simulation of thermal plasma spray processing of nanostructured materials; heat transfer in electromagnetic systems; and thermal design of low temperature fuel cells.

Dr. Bergman has served as Associate Technical Editor of the ASME *Journal of Heat Transfer* and has received a number of research awards, including the National Science Foundation Presidential Young Investigator Award (1986), the ASME Heat Transfer Division Best Paper Award (1986) and the ASME Melville Medal (1988). He was elected a Fellow of ASME in 1995.

Professor Bergman earned his B.S. from the University of Kansas in 1978, his M.S. from Purdue University in 1981, and his Ph.D. from Purdue in 1985.

David L. Bourell

David Bourell is Temple Foundation Professor at the Texas Materials Institute at the University of Texas at Austin. He is internationally recognized in the field of solid freeform fabrication (SFF) and is the executive organizer of the annual SFF Symposium, the leading research conference in the world on this subject. Dr. Bourell is also recognized in the area of processing of nanocrystalline powder, materials selection, and mechanical metallurgy. He is a member of TMS-AIME (The Minerals, Metals and Materials Society/American Institute of Mining, Metallurgical and Petroleum Engineers), is a past chair, vice-chair, and secretary, and now serves on several technical committees of TMS, including the Shaping and Forming Committee, the Powder Metallurgy Committee, and the Materials Processing and Manufacturing Division Committee. Dr. Bourell is also a member of ASM International (American Society for Metals), the American Powder Metallurgy Institute, and the American Ceramic Society.

Dr. Bourell's areas of research include materials selection, mechanical behavior of materials, and particulate processing. For the latter, Dr. Bourell is doing research with emphasis on sintering kinetics and materials issues associated with selective laser sintering (SLS). He holds 14 patents dealing with materials innovations in SLS. He has published over 120 books, book chapters, journal articles, and conference proceedings.

Dr. Bourell won the ASM International Bradley Stoughton Award for Outstanding Young Teachers of Metallurgy in 1986. In 1991, he was the recipient of a prestigious Alexander von Humboldt Research Fellowship to the Max Planck Institute Powder Metallurgy Research Lab in Stuttgart, Germany. He was elected a fellow of ASM International in 1997.

Dr. Bourell earned his B.S. in Mechanical Engineering from Texas A&M University and his M.S. and Ph.D. degrees in Management Science and Engineering (MS&E) from Stanford University.

Scott J. Hollister

Scott Hollister is Associate Professor of Biomedical Engineering at the University of Michigan, Ann Arbor. His primary research interests are

- Biomaterial scaffold engineering, including optimal scaffold design and fabrication
- Tissue engineering, especially for musculoskeletal tissues
- Hierarchical modeling of biological tissues
- Image-based computational modeling and design, using image data as the basis for designing and simulating engineering systems

Dr. Hollister views his work in these four areas as synergistic. He uses image data to model hierarchical tissue behavior; he then uses this information to optimally design biomaterial scaffolds that match natural tissue function. Finally, working together with many collaborators, he seeks to deliver biofactors such as cells, genes, and growth factors to regenerate tissue. His ultimate goal, together with his collaborators, is to create a linked design, biomaterial fabrication, and biofactor generation platform so that they can design any anatomic structure with optimized microstructure, build that scaffold from materials ranging from metals to ceramics to polymers and composites thereof, and deliver cells, genes, proteins, or a combination thereof to regenerate tissue.

Dr. Hollister earned his B.S.E. in Aerospace Engineering in 1984; his M.S.E. in Applied Mechanics in 1986; his M.S. in Bioengineering in 1986; and his Ph.D. in Bioengineering in 1991, all from the University of Michigan, Ann Arbor.

David Rosen

David Rosen is a Professor at the George W. Woodruff School of Mechanical Engineering, Georgia Institute of Technology. He has been named a Woodruff Faculty Fellow for the period 2002-2007. In August 1995, Dr. Rosen was appointed the Director of the Georgia Tech Rapid Prototyping and Manufacturing Institute, where he has responsibility for developing educational and research programs in rapid prototyping and manufacturing.

Dr. Rosen's research focuses on advancing the technology and practice of product realization. His work is in four areas: engineering design, including configuration design and design-for-manufacturing; virtual prototyping as a methodology for DFM (Design for Manufacturability); and rapid prototyping and manufacturing. Recent projects emphasize the development of new design, process planning, and material processing technologies to enable production manufacturing applications of rapid prototyping technologies. His research is funded by the National Science Foundation, a rapid prototyping industry consortium, and contracts with individual companies.

Dr. Rosen's work has been recognized by the American Society of Mechanical Engineers (ASME), where he received the Computers in Engineering Conference (Artificial Intelligence and Expert Systems Section) Best Paper Award in 1992 and the Design Theory and Methodology Conference Distinguished Paper Award in 1996. He was named to the Computers and Information in Engineering Division Executive Committee (1996-2001), and he was elected a Fellow by the ASME in 2003. Dr. Rosen was named Co-Chair of the Fourth Association for Computing Machinery Siggraph Symposium on Solid Modeling and Applications in 1997. He has received several other best paper awards. In addition to service to ASME, Dr. Rosen is also active in the Society of Manufacturing Engineers (SME), and he is serving on Tech Groups within its Rapid Technologies and Additive Manufacturing Community.

Dr. Rosen earned his B.M.E. and M.S. from the University of Minnesota in 1985 and 1987, respectively, and his Ph.D. from the University of Massachusetts in 1992.

APPENDIX B: SITE REPORTS — EUROPE

Site: **Fraunhofer Institute for Laser Technology (ILT)**
Steinbachstrasse 15
52074 Aachen, Germany
<http://www.ilt.fraunhofer.de/>

Date visited: 22 October 2003

WTEC Attendees: D. Bourell (report author), S. Hollister, K. Cooper (observer), H. Ali

Hosts: Dr. Peter Loosen, Vice Director, Tel.: +49 (0)-241/89 06 162;
 Fax: +49 (0)-241/89 06 121; Email: loosen@ilt.fraunhofer.de
 Mr. Tobias Wirtz, +49 (0)-241/89 06 360; Fax: +49 (0)-241/89 06 121;
 Email: wirtz@ilt.fraunhofer.de

BACKGROUND**Fraunhofer Institutes**

There are about 56 Fraunhofer Institutes (including subsidiaries in Delaware and in Nagoya, Japan), each with a separate disciplinary mission. All do applied research. There is a rapid prototyping alliance of Fraunhofer Institutes, with rapid prototyping applied to many areas. The Fraunhofer headquarters are in Munich, Germany. In total, the Fraunhofer Institutes have about 12,000 employees and a budget of €910 million; 75% of their funding comes from contract research (50% for Germany, 50% for Japan plus the rest of Europe), and 25% comes from government.

ILT

The Fraunhofer Institute for Laser Technology (ILT) is next door to the Fraunhofer Institute for Production Technology, directed by Dr. R. Poprawe. It has a €18 million budget, 132 full-time employees, and 97 students, mostly from the University of Aachen. The focus of the ILT is laser science and technology. Its researchers work on development of new lasers: solid state and high power diode and next-generation chips using plasma-EUV lithography. Their emphases are on laser measurement, system technologies, microtechnology, surface treatment, and cutting and welding.

Direct Metal Rapid Manufacturing

The Fraunhofer ILT has developed a Laser Engineered Net Shaping-type (LENS™) direct metal machine and has produced a variety of objects for tools and molds (Co, Ni, and Fe-based, including tool steel 1.2343) as well as industrial parts for aerospace applications (Ti and superalloys). Projects include development of powder nozzles with concentration on oxygen control and other process issues. This additive technique has been used for mold repair in a project funded by Braun. A 2 kW YAG laser with powder-feed mechanism was used in conjunction with an x-y-z table. A particular advance was the development of teaching software for this process. Research has been performed to model thermal fields during laser processing for process optimization.

Selective Laser Melting

Selective laser melting (SLM) is a powder-bed direct metal process. Materials including Ti-6Al-4V, 316L SS, tool steel, and Co-Cr alloys have been produced. Full density is possible. A commercial version of the machine was showcased by TRUMPF at the Euromold Conference in December 2003. The process is

selective laser melting of metals. For titanium, tensile strength went up, surface roughness was about 20-50 μm with feature resolution of < 0.1 mm. The applications include short-run parts, functional prototypes, and molds. Specific research includes medical implants (for facial accident victims), dental restorations (Co-Cr caps), complex hollow structures and tooling inserts, and conformal cooling dies (tool steel).

Metal Powder Deposition

Metal powder deposition (MPD) is a high-volume-rate deposition technique. Up to 10 cm^3/min . can be deposited, five times faster than SLM. The advantages of MPD are production of large parts and a wide materials spectrum. It is less precise and the surface finish is rough; resolution is 0.2-0.3 mm, and roughness is about 80 μm . MPD is limited to solid parts, unlike SLM.

Surface Finish

Another major ILT project centers on improving surface finish in milled injection molding dies, although the extension to additive techniques is obvious. The approach is to laser remelt the surface (5-80 μm) using a CW laser (100-500 W) to smooth the macro features, followed by laser ablation/blowing using the same laser in the Q-switched (pulsed) mode. The shorter the pulse width, the better the results: 480 ns pulse width has been reduced to 16 ns, with future work pushing the pulse width to 5 ns. For Ti-6Al-4V, stainless steel, and tool steel, machined surfaces may be improved from approximately 1.7 μm to 0.24 μm . This is faster than manual polishing. Laser surface melting of porous parts such as those of Ti-6Al-4V is also done to close surface pores.

Other

ILT is investigating laser welding of car bodies using high-power diode lasers.

FUTURE

Planned future projects include process layout and machine development, life cycle time of machine development, materials and composites development, and advanced cladding and polishing.

Site: Fraunhofer Institute for Manufacturing and Advanced Materials (IFAM)
 Wiener Strasse 12
 28359 Bremen, Germany
<http://www.ifam.fhg.de>

Date visited: 20 October 2003

WTEC Attendees: D. Bourell (report author), T. Bergman, K. Cooper (observer), H. Ali

Hosts: Dr. Dirk Hennigs (RP/RM), Tel.: +49 (0)421/22 46 231; Fax: +49 (0)421/22 46 300;
 Email: dh@ifam.fhg.de
 Mr. Phillip Imgrund (PM), Tel.: +49 (0)421/22 46 216; Fax: +49 (0)421/22 46 300;
 Email: im@ifam.fraunhofer.de
 Dr. Natalie Salk (Nanotechnology), Tel.: +49-(0)421-2246-175;
 Fax: +49-(0)421-2246-300; Email: sal@ifam.fraunhofer.de

BACKGROUND

See the Fraunhofer Institute for Laser Technology (ILT) site report for a brief overview of the Fraunhofer Institutes.

IFAM

Two hundred employees of the Fraunhofer Institute for Manufacturing and Advanced Materials (IFAM) work in a five-year old building, of which about 100 employees support the net shape effort. The IFAM casting group is moving to a new facility soon. There are 40-50 additional employees in Dresden in a sister lab.

IFAM's emphases are on (1) rapid product development, (2) process development, i.e., improving machines, not developing new machines, and (3) computer simulation of mechanical behavior.

RAPID PROTOTYPING AND MANUFACTURING (RP/RM)

IFAM has five machines:

1. EOS SLS machine (M 250 Extended)
2. EOS SLS machine (M 160) for direct metal processing
3. Extrudehone Prometal 3DP machine (the only one in Germany/Europe)
4. EOS SLA machine (Desktop 180)
5. in-house-developed MJS machine

IFAM is making some advances on specific commercial processes, including heating of powder beds in metal EOSINT SLS for stress reduction, cooling of mirrors and lasers, etc. Its researchers are using 3DP for mold inserts and conformal cooling for injection molding tooling and gradient compositions, e.g., adding carbon and carburize for surface hardness. Heating of the powder box and use of MIM powder are IFAM modifications to 3DP.

Materials Development

The Fraunhofer IFAM develops materials for EOS and Prometal. These materials are heat-treatable. Efforts are focused on elimination of post-processing of metal parts by creation of nominally fully dense articles. Lasertool, a mold tool material, has 99% density, >320 Hv 800-900 MPa strength, and Ra = 30-40 μm. This is better than the EOS commercial material, which reaches 95% density. Direct Steel/Direct Tools are not heat-treatable. It was mentioned that post processing can be used to close the pores. IFAM scientists have

used marble powder coupled with reverse engineering technology to create art objects (busts) using the ProMetal 3D-Printing machine.

CAD

The IFAM researchers were starting work on a two-binder system for 3DP, where one binder is traditional and one is carbon laden. They intended to produce gradient strength steel parts by depositing the carbon according to a physical model. The computer model would contain strength information that would be converted to carbon content. After build, the part would be heat-treated to diffuse the carbon into the steel.

Biomedical

No specific mention was made by the WTEC team's hosts of biomedical applications of additive manufacturing processes, although Dr. Natalie Salk, a nanotechnology researcher, made a reference to microinjection molding stainless steel structures with bio-applications.

Fuel Cells

Mention was made by Dr. Salk of control of catalyst distribution in fuel cell materials in the context of microinjection molding.

Microinjection Molding

This process uses very fine ($<1 \mu\text{m}$) metal powder (silicon, gold), with applications in microfluidics, chemical reactions, heat sink, and catalysis. Also, the process has been developed for Si molds and inserts. The WTEC team's hosts at IFAM discussed the challenges of using scanning laser treatment, similar to laser glazing, to smooth surfaces of small parts, without destroying small features inherent to these small parts.

Other

Unrelated technologies at IFAM include creation of metal foams using P/M with foaming agents for auto applications and various bonding technologies.

Future

IFAM sees its future in gradient materials, multiple materials, and improved speed and size of parts. Dr. Hennigs predicted that the number of companies with RP technology would decrease in the next five years.

Barrier

A barrier to continued progress of the field is integration of RP/RM into the late design cycle. There are too many small companies, fewer as time goes on, and only a few large ones who can accommodate RP/RM technology.

Site: Fraunhofer Institute for Production Technology (IPT)
 Steinbachstrasse 17
 52074 Aachen, Germany
<http://www.ipt.fraunhofer.de/>

Date visited: 22 October 2003

WTEC Attendees: D. Bourell (report author), S. Hollister, K. Cooper (observer), H. Ali

Host: Mr. Christoph Ader (IPT), Tel. +49 (0) 2 41/89 04-4 03; Fax: +49 (0) 2 41/89 04-64 03;
 Email: christoph.ader@ipt.fraunhofer.de

BACKGROUND

See the Fraunhofer Institute for Laser Technology (ILT) site report for a brief overview of the Fraunhofer Institutes.

IPT

The Fraunhofer Institute for Production Technology (IPT) is next door to the Fraunhofer Institute for Laser Technology. It has a €14.2 million budget, 36% of which comes from industry grants, 33% from public funding, and 31% from basic funding. There are five divisions within IPT; RP/RM efforts are in the Production Technology Division, headed by Prof. Klocke.

IPT's emphases are on

- process techniques (to develop new methods for new applications using lasers, ultrasonics, micromachining, and laser machining of ceramics)
- production machines (precision technology and machines)
- metrology and quality management (optical metrology)
- technical management (monitoring, strategizing, planning, and control)

RAPID PROTOTYPING AND MANUFACTURING (RP/RM)

IPT has three machines: an EOS SLS machine (EOSINT M 250 Xtended) for direct metal processing; an old EOS 100 W metal machine (EOSINT M 160); and a very old EOSint 350/40 plastic machine. Metal laser sintering and ceramic laser sintering are two processes being developed.

IPT makes metal parts and mold inserts with V50 DirectSteel™ using metal laser sintering. Surface finishing of metal parts is done by shot peening with 400 μm steel balls. The finish is 20–50 μm initially (Fe/Ni/CuP EOS direct metal powder) and can be reduced to 3–4 μm. Shrinkage allowances and accuracy have been developed and are applied to the solid model.

Ceramic laser sintering is used to make investment casting shells or cores. The mechanism is transient liquid phase sintering using a low melting binder. A “lost-lost wax” process is under development to create investment casting molds. Casting shells are made with considerable time savings. Zirconium silicate with a sintering aid is used and is SLSed directly to produce a mold. After SLS, the molds are cleaned and cast. Metals cast using this process include heat resisting alloys, In100, and hot work tool steels. For inconel turbine blade, alumina is used. The shell has 40% porosity to remove gases during casting. Surface finish is about 50 μm. For cores, a slurry is applied followed by hand finishing to improve surface finish. In this case, surface finish as low as 4 μm is achieved.

The ceramic SLS parts are also used as patterns or mandrels for metal spray forming. A large number of materials have been used for patterns, including zirconium silicate (25 μm), silica (11 μm), silicon carbide

infiltrated with epoxy ($<10\ \mu\text{m}$; epoxy makes metal removal difficult), aluminum titanate, and silicon nitride. SiC gives the best surface finish but is difficult to remove. With SiO_2 delamination problems occur and accuracy is lost. Silicon nitride is difficult to process, and aluminum titanate is very fragile. Zirconium silicate appears to be the best.

Controlled metal build-up (CMB) is a LENS/LAM-type process with a machining step after each layer build. Both powder and wire feeds are used. High power diode lasers are used. High speed three-axis milling is performed after each build step. The machine has a library of milling tools. The parts are metal injection molding dies, e.g., for mobile phone holders (use of which is becoming a law in Europe). Mold repair can be done on machined molds. Röders commercialized the process, but it no longer makes this machine. Thermal cracking is a problem, and porous interior and dense surface will be tried. The CAD process for the machining step is not entirely adequate, resulting in a non-automatic contour following of the tool. Work is ongoing to improve translation of NC data files from CAD. The Fraunhofer IPT is working on this CAD issue.

Two new proposals pending are production of dental ceramic prostheses (bridges and crowns) and laser sintering of Co-WC.

FUTURE

Metal FF will be important as the technology matures. Also, 3DP and SLS have possibilities as processes that will have particular impact. Currently, molds and tooling are the focus. In the future parts, multi-material and multiple wire feed will be considered.

- Site:** Helsinki University of Technology (HUT)
BIT (Business Innovation Technology) Research Centre
P.O. Box 5500
Fin-02015 HUT, Finland
<http://www.hut.fi/>
<http://www.bit.hut.fi/>
- Date Visited:** 24 October 2003
- WTEC Attendees:** C. Atwood (report author), J. Beaman, G. Hazelrigg (observer)
- Principal Host:** Jukka Tuomi, Research Director, BIT (formerly TAI) Research Center, HUT,
 Tel.: +358-9-451 5700; Fax: +358-9-451 5002; Email: Jukka.tuomi@hut.fi
- Participants:** Lotta Lamminen, Research, M.Sc. (Mech. Eng.), Integrated Design and
 Manufacturing, TAI Research Center, Tel.: +358 9 451-2108;
 Email: lotta.lamminen@hut.fi
 Kalevi Edvard Ekman, Professor, HUT, P.O. Box 4100, Fin-02015 HUT, Finland,
 Tel.: +358 9 451 3566; Email: kalevi.ekman@hut.fi
 Martti Huolila, Senior Technology Adviser, Product and Production Technology,
 Tekes, the National Technology Agency, P.O. Box 69, Fin-00101 Helsinki,
 Finland, Tel.: +358 10 521 5904; Email: Martti.Huolila@tekes.fi
 Seppo Syrjala, Project Manager, Rapid Product Innovations (service bureau),
 Tel.: +358 2 436 5605; Email: seppo.syrjala@rapid-product-innovations.fi
 Juha Kotila, Rapid Manufacturing Development Group, Direct Metal Laser Sintering,
 EOS Finland, Aholantie 17 FIN-Rusko, Finland; Tel.: +358 2 4365 630;
 Email: juha.kotila@eos-finland.com

BACKGROUND

The Helsinki University of Technology (HUT) has approximately 15,000 students, 17 degree programs, and 3000 staff, including 300 professors. HUT has four major programs related to advanced manufacturing development. They include Rapid Prototyping and Manufacturing (RP&M) Applications Development; Product Development for Rapid Manufacturing; Rapid Manufacturing Logistics and Business Concepts Research; and Sheet Metal Rapid Manufacturing Research. The TAI Research Centre (which after the WTEC visit became the BIT Research Centre) is an independent research center at HUT with expertise in information technology, industrial management, development of organizations, rapid product development, and development of manufacturing systems.

Major industries in Finland, supported by HUT and TAI, are electronics (primarily Nokia), paper products, and large industrial and agriculture equipment. According to information provided during the visit, Finland invests 3+% of its Gross National Product in research and development, second to Sweden and above Japan and the United States. This number has risen consistently since 1990. Nokia provides approximately 50% of the national R&D funding, about U.S. \$2 billion.

HUT has been involved in research, development, and applications of rapid prototyping technologies since the early 1990s. Through its leadership of HUT and with industrial support from major companies like Nokia, Finland has developed a national approach to the development and implementation of new advanced manufacturing technologies. Basically, two service bureaus support most of the manufacturers who need prototype models and rapid tooling. A few companies have RP machines in-house. This accounts for the fact that there are approximately 20 RP machines in the country.

Current Status of RP&M

RP&M continues to evolve in Finland, focused primarily on applied research and applications development. Service bureaus continue to provide applications and product development and to provide parts to industry. Electrical Optical Systems (EOS), a major selective laser sintering machine manufacturer, continues to develop new materials for its Direct Metal Laser Sintering machines. Oulu Institute of Technology is developing medical applications. Joensuu Science Park is developing microinjection molding and advanced optics. The University of Turku is working in biomaterials, and HUT has a project in layer forming of sheet metal. DeskArtes is a software development company that provides third party software for manufacturing processes including rapid prototyping. Figures B.1-B.2 illustrate near-term and long-term trends and a potential vision of the future, reported by HUT.

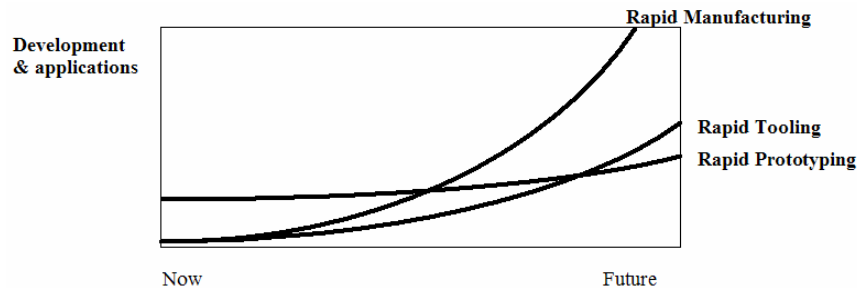

Figure B.1. RP&M trends. (Courtesy HUT)

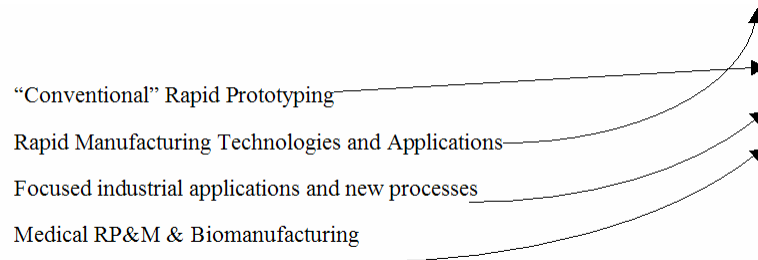

Figure B.2. RP&M foresight. (Courtesy HUT)

Finnish Government Support for Research & Development

Tekes is Finland's National Technology Agency and is the main public financing organization for R&D in Finland, with an annual budget of €380 million. Tekes finances industrial projects as well as projects at research institutions, both basic and applied research, and it is a strong supporter of risk-intensive projects with potential for high payoff. Tekes also supports collaboration with other countries where each entity provides its own financing. Of the 300 employees at Tekes, 200 are technical staff and decisionmakers. Tekes does not have R&D facilities in-house. A primary role of Tekes is to build competence in Finnish industrial companies, and it promotes collaboration between universities, large companies, and SMEs. Tekes can fund Finnish scientists working in foreign research institutes as part of Finnish R&D projects. Likewise, work by foreign scientists in Finnish research institutes can be included in a Tekes-funded R&D project.

Over the years, Tekes has developed strong and trusting relationships and strategic partnerships between government, universities, and industry. Through independent analysis by the United Nations and other agencies, Finland is recognized as a leader in innovation, productivity, and investment in R&D. Figure B.3 is a chart that illustrates the range of R&D that Tekes funds.

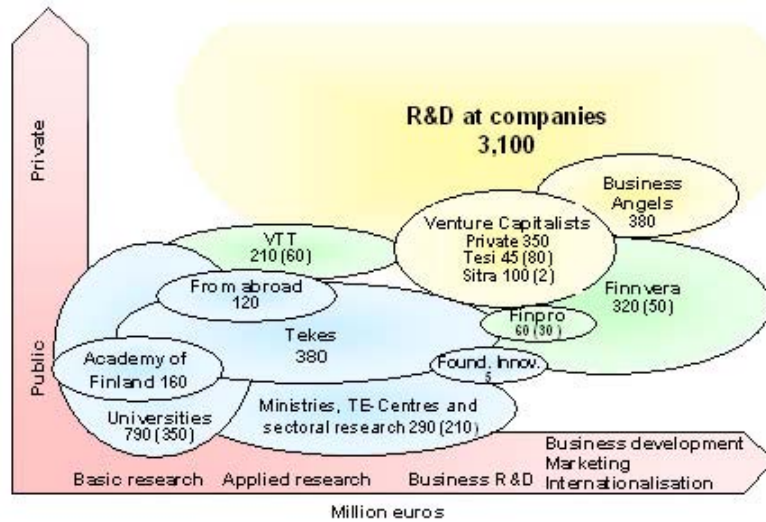

Figure B.3. Finnish innovation environment; resources and funding in 2000. (Courtesy Martti Huolila, Senior Technology Advisor, Tekes)

Direct Laser Sintering

EOS is the manufacturer of laser sintering machines with various applications, including investment casting patterns, plastic prototypes, metal tooling, metal parts, and sand molds and cores for metal casting. Specifically, the EOSINT P fabricates patterns and plastic prototypes, the EOSINT M fabricates metal tooling and parts, and the EOSINT S fabricates sand structures for metal casting. The Direct Metal Laser Sintering (DMLS) process fabricates net shape metal parts directly from pure metal powders. As no additive materials such as polymers are used in the DMLS process, metal parts can be fabricated directly to final density without any subsequent heat treatment and/or infiltration stages required. This allows parts to be fully fabricated in the DMLS machine with only minimal post processing. Figures B.4–B.7 illustrate the DMLS process, material properties from several alloys, and micrographs of the EOS material “DirectSteel H20” tool steel structure and tool insert.

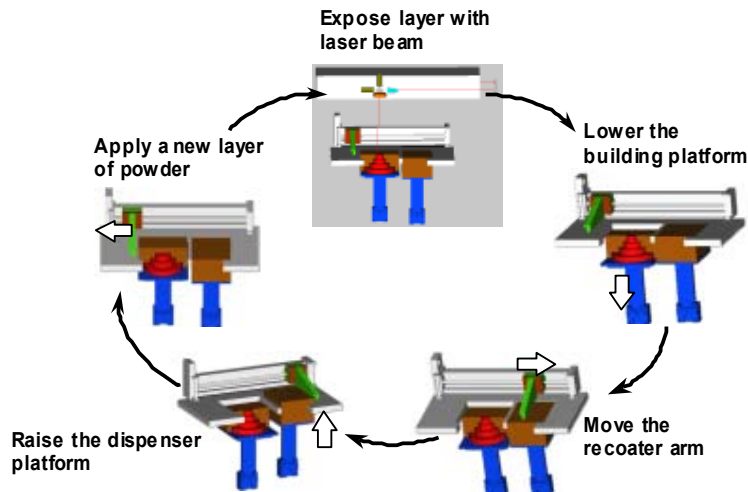

Figure B.4. DMLS operation sequence. (Courtesy EOS)

	DirectSteel H20	DirectMetal 50	DirectMetal 20	DirectSteel 50	DirectSteel 20
Layer thickness	20 μm	50 μm	20 μm, (40 / 60 μm opt.)	50 μm	20 μm, (40 / 60 μm opt.)
Main constituent	Steel	Bronze	Bronze	Steel	Steel
UTS	≤ 1100 N/mm ²	≤ 200 N/mm ²	≤ 500 N/mm ²	≤ 500 N/mm ²	≤ 600 N/mm ²
Hardness	35 - 42 HRC	90-120 HB	100-120 HB	150-220 HB	180-230 HB
Minimum porosity	0 %	20 %	7 %	5 %	2 %
Max operating temperature	1000°C	400°C	400°C	800°C	800°C

Typical dimensional accuracy: ± 0.05 mm; surface roughness after shot peening: 3–6 μm R_a

Figure B.5. Properties of laser-sintered DMLS materials.

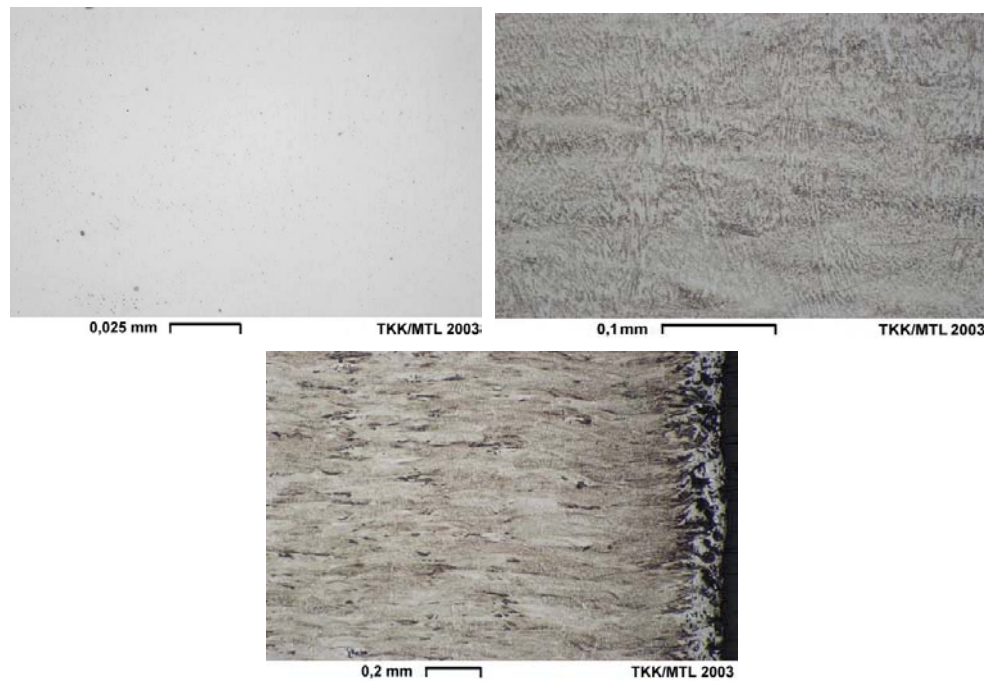

Figure B.6. Micrographs of DirectSteel H20 structure

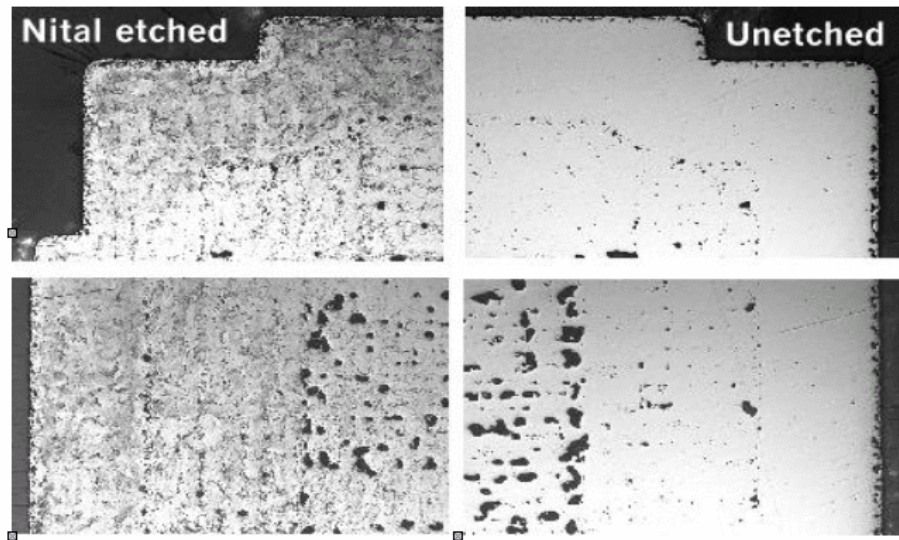

Figure B.7. Micrograph of DirectSteel H2O tool insert.

See Figure 2.14 in Chapter 2 and Figure 3.6 in Chapter 3 for examples of parts and tooling fabricated using the EOS DMLS process.

Rapid Prototyping Service Bureaus in Finland

Rapid Product Innovations (RPI) is one of two service bureaus in Finland. It is owned by the Alphaform Group and has locations in Rusko and Pori, Finland. RPI has 52 employees with sales in 2002 of €6 million. RPI works closely with EOS GmbH on the development of DMLS technology and applications development. During the 1980s, RPI worked to develop soft tooling; at the time of the WTEC visit, it worked on product development processes. Its mission is to provide innovative solutions to improve its customers' product development process to gain a competitive advantage. RPI has many major customers, including Saab, Electrolux Home Products, Husqvarna, and several Nokia business units. The industry segments it serves are automotive, electronics, home appliances, and others. Beyond its role in traditional rapid prototyping, RPI also has several initiatives focused on rapid manufacturing. It has a research project performing analysis of technology needs of the manufacturing industry. It has one project funded by Tekes that ends in 2005. RPI has identified several customer needs, including components or products for rapid manufacturing; single item manufacturing; mass customizing; manufacture before and after tools; and spare parts manufacture. Its resources include 17 SLA machines, 7 SLS machines, 2 DMLS machines, CAD tools, and other support equipment.

Foundry Technology Using Freeform Fabrication Technologies

Several departments at HUT have worked together to develop an integrated approach to improving foundry- and casting-related manufacturing needs. The departments involved are the Department of Mechanical Engineering Laboratory, Laboratory of Foundry Technology, Laboratory of Machine Design, and Laboratory of Production Engineering. The focus of the Laboratory for Foundry Research is to develop an advanced (Master's level) curriculum for design, simulation, methodologies, and techniques for improving metal castings and the metal casting process. The use of SFF technologies is part of the curriculum. Facilities and equipment include a Thermojet Solid Object Printer, equipment for making lost-wax investment casting molds, vacuum casting equipment for special materials, and three induction furnaces. RP (SFF) related objectives and activities include serving industry in difficult RP cases and providing RP patterns and castings to industry partners; training RP service providers and other others in advanced foundry technology; and developing environmentally friendly mold and core materials. Industry sponsors for this and other M.Sc. projects include Metso Paper, ABB Industry, Nokia Research Center, Nokia Mobile Phones, and others.

Freeform Forming of Sheet Metal Parts

A unique development project at HUT is the use and characterization of an off-the-shelf machine for fabricating prototype sheet metal parts. Amino Corporation in Japan manufactures the machine. Briefly stated, a sheet metal blank is held in a fixture with single point static contact support from below the blank. Single point contact is made with a round stylus and indexed in the negative z or vertically downward direction. The deformation occurs when the stylus is driven in the desired geometry for the given layer. The process continues by repeated downward stepping and forming of individual layers until the shape or deformation of the sheet metal part is complete. The part is unclamped from the holding fixture and the edges are trimmed to the final shape (see Chapter 2, Figures 2.20 and 2.21, for illustrations).

Computer Aided Design Software

DeskArtes (www.deskartes.com/) is a Finnish company that develops and markets 3D industrial design software products; visualization and communications tools; and value-adding software technology for RP, simulation, data verification and healing. DeskArtes was established in 1991. It employs five people and has distributors in over 20 countries. Customers include Daimler Chrysler, BMW, SAAB, Honda, Volvo, and others. The company's *View Expert* software is used for viewing and checking CAD data files from STL, IGES, Step, ProE, UG, Catia, and DXF data formats. *3DATA Expert* is used for STL conversion and surface repair of poor quality CAD models. *Design Expert* is used for modeling, visualization, and data transfer. *Wireless CAD Viewer* is used in conjunction with a Personal Data Assistant (PDA) device to view CAD files.

Site: Imperial College, London
 Department of Materials
 Department of Bioengineering
 Department of Electrical and Electronic Engineering
 South Kensington
 London SW7 2AZ, United Kingdom
<http://www.ic.ac.uk/>

Date visited: 20 October 2003

WTEC Attendees: S. Hollister (report author), C. Atwood, J. Beaman, D. Rosen, G. Hazelrigg (observer), K. Lyons (observer)

Hosts: Professor John Kilner, Department Head, Department of Materials,
 Tel: +44 (0) 20 7594 6733; Email: j.kilner@imperial.ac.uk
 Dr. Nigel Brandon, Senior Lecturer in Electrochemical Engineering, Department of
 Chemical Engineering, Tel: +44 (0) 20 7594 5704;
 Email: n.brandon@imperial.ac.uk
 Professor Richard Syms, Department Head, Department of Electrical and Electronic
 Engineering, Tel: +44 (0) 20 7823 8125; Email: r.syms@imperial.ac.uk
 Professor Chris Toumazou, Head of Bioengineering Department,
 Tel: +44 (0) 20 7581 4419; Email: c.toumazou@imperial.ac.uk
 Professor David Ewins, Pro Rector (International Relations), Professor of Vibration
 Engineering, Tel: +44 (0) 20 7594 7277; Email: d.ewins@imperial.ac.uk
 Dr. Julian Jones, Tissue Engineering Laboratory, Department of Materials

BACKGROUND

Imperial College is one of the largest and highest ranked universities within the U.K.. The two largest schools within Imperial are the Medical School and the Engineering School. The Medical School encompasses several hospitals, including Chelsea & Westminster Hospital and Guy's Hospital.

Rapid Manufacturing/Rapid Prototyping

At the time of the WTEC group's visit, there was no rapid manufacturing/rapid prototyping research among the Imperial College research groups. There was some activity on MEMS fabrication using additive/subtractive manufacturing processes demonstrated by Professor Syms. Although not traditional RP/RM work, it is noteworthy if future work in RP/RM moves to integrate with this level. Within the tissue engineering group, Dr. Julian Jones had plans to begin RP/RM work for bioglass scaffolds in collaboration with the University of Northumbria.

Materials Development

There was no materials development for RP/RM among the research groups.

CAD

There was no discussion of new CAD work for the research groups we met.

Biomedical

The tissue engineering research laboratory in the Department of Materials at Imperial is focusing on the development of bioglass for bone tissue engineering scaffolds, cartilage tissue engineering scaffolds, and as a biosensor. For the biosensor work, bioglass would be seeded with lung cells, and cell viability would be monitored using Raman spectroscopy. Since cells are sensitive to toxins, the presence of an airborne toxin

would kill the cells, and as monitored by Raman, this would alert occupants of a building to the presence of an airborne toxin. This work at Imperial is funded by the U.S. Defense Advanced Research Projects Agency.

The major focus of the tissue engineering group is the development and application of bioglass as a scaffolding for tissue engineering work. The bioglass is made using a sol-gel process, whereby a surfactant is introduced to create macroscopic porosity. Typical pore sizes for the sol-gel range from 300-600 microns, with interconnections between pores averaging 100 microns. In addition, bioglass has a micro-level porosity that can be reduced if the material is sintered to create a stronger material. The micro-level porosity has a size on the order of 20 nanometers, and it is the micro-level porosity that influences resorbability. If sintered, the material has a compressive strength of 2.5 MPa due to the consolidation of the micro-level pores. Sintering therefore increases the compressive strength and lengthens the resorption time. The material, whether sintered or not, is heated to 600°C to burn out any organic material. There is a concern about material cracking due to capillary pressure.

At the time of the WTEC visit, Dr. Jones' group had not used additive/subtractive manufacturing techniques to fabricate bioglass scaffolds. However, they were very interested in applying Solid Free-Form Fabrication (SFF) techniques to manufacture bioglass scaffolds. The motivation for using SFF was to have greater control over pore structure than was possible with current manufacturing techniques. Dr. Jones mentioned that they were beginning collaboration with the University of Northumbria to investigate SFF with bioglass.

Fuel Cells

Imperial has a large collaborative center on fuel cell research. Inside Imperial, the materials, chemical engineering, electrical engineering, and mechanical engineering departments are involved; the effort encompasses 50 people, including primary faculty, post-doctoral fellows, graduate students, and research support staff. The center also works with industrial partners, including Rolls Royce, Johnson-Matthey, and Morgans. Other collaborations include those with U.S. universities and research institutions, including the Georgia Institute of Technology and Oak Ridge National Laboratory.

The major research effort at Imperial focuses on solid oxide fuel cells, although research is also done on polymer PEM fuel cells. The research in the Department of Materials ranges from fundamental catalysis to material synthesis. The entire research effort within the center covers modeling and economics/policy issues in addition to research work performed in the Department of Materials. Material synthesis for solid oxide fuel cells involves electrophoretic deposition and patterning, which includes sintering. Other manufacturing processes for fabricating fuel cell components include extrusion, plasma spray, and vapor deposition. This work has been spun out of the department into a company called CERESpower, founded by Dr. Brandon and Professor Kilner.

Dr. Brandon foresaw three major timelines for fuel cell research. In the next 3–5 years, he believed that the industry would see advances in high-end consumer electronics with high costs per kilowatt. In addition, fuel cells might be applicable for remote power generation via generators where it is difficult to extend the current electrical grid. In the 5–10 year span, Dr. Brandon foresaw that fuel cells could be applicable for high load commercial or industrial power generation. Finally, in the 15–20 year time span, Dr. Brandon believed that fuel cells would see applications in power generation for automobiles.

Although his group is not currently pursuing any layer or free-form fabrication work for fuel cells, Dr. Brandon did believe that there could be a role for SFF or additive/subtractive manufacturing for fuel cells, especially for electrodes. Electrodes are typically 30% porous and could benefit from better control over 3D microstructure, including the introduction of graded materials. However, the significant challenge is that these microstructures must be created over a distance of 10 microns, requiring a feature size of 1 micron or less. This will be quite a challenge for additive/subtractive manufacturing in fuel cells.

MEMS

Dr. Syms presented an overview of the work in the MEMS area. The Department of Electrical and Electronic Engineering has considerable work in microoptics systems. Focus areas include methods for

microassembly (micromirrors using surface tension effects to rotate components); low cost LIGA-like processes for fabricating high-aspect-ratio devices; and methods for patterning masks using unique materials and processes (e.g., CsCl and water to form dots, columns, cones).

Bionics and Low-Power Electronics

Dr. Toumazou is the head of the relatively new, fast-growing Department of Bioengineering. He presented the department's research program in bionics (sensors + electronics) that takes advantage of some novel low-power effects in electronic circuits. For many applications, the high precision of digital computation is not needed, and analog computations suffice. Analog computation can be performed using leakage currents in CMOS devices, enabling very low power consumptions. Applications included cochlear implants, hydrophones in the ocean, retinal implants, realtime solid state DNA sequencing, and bio-FET to sense stem cell changes.

FUTURE

Future work at Imperial for RP/RM was mentioned most specifically for production of bioglass scaffolds, where a specific research project was in the works. Application of RP/RM for fuel cell production was mentioned as a possibility, but there were no plans at that time to begin such work.

BARRIER

Dr. Brandon mentioned that fabrication of electrodes for fuel cells could be an area for additive/subtractive manufacturing, especially with the capability to produce graded materials. However, graded materials would have to be produced over a length scale of 10 microns, which is far below what any RP/RM process can currently achieve. Directly fabricating with bioglass for tissue engineering scaffolds will also be a challenge.

ASSESSMENT

Although there was certainly very interesting research work in the area of fuel cells, tissue engineering, MEMS, and bioengineering, there was no ongoing activity in additive/subtractive manufacturing in general or in any of the applications areas. There were plans in the tissue engineering group to begin work on RM of bioglass scaffolds, but no work had commenced at the time of the WTEC visit.

- Site:** **IVF Industrial Research and Development Corporation**
Argongatan 30
SE-431 53 Mölndal, Sweden
<http://www.ivf.se>
- Date visited:** 23 October 2003
- WTEC Attendees:** J. Beaman (report author), C. Atwood, G. Hazelrigg (observer)
- Hosts:** Mr. Berndt Holmer (IVF), Tel.: +46 (0) 8-21 3174; Fax: +46 (0) 8-20 2227;
 Email: berndt.holmer@ivf.se
 Mr. Richard Berglund (IVF), Tel.: +46 (0) 31-706 6047; Fax: +46 (0) 31-27 6130;
 Email: Richard.Berglund@ivf.se
 Dr. Elis Carlström (Swedish Ceramic Institute), Tel.: +46 31 772 0500;
 Fax: +46 31 18 5380; Email: ec@sci.se
 Mr. Urban Harrysson (fcubic), Tel.: +46 31 93 3433;
 Email: urban.harrysson@fcubic.com
 Mr. Morgan Larsson (Arcam), Tel.: +46 31-710 3236; Fax: +46 708-18 3877;
 Email: morgan.larsson@arcam.com
 Mr. Ralf Larson (CEO, Speed Part AB), Tel.: +46 (0) 31-338 3990;
 Fax: +46 (0)31-88 6838; Email: ralf.larson@speedpart.se; Website:
 www.speedpart.se
 Mr. Ulf Lindhe (Arcam), Tel.: +46 31-710 3200; Fax: +46 31-710 3201;
 Email: ulf.lindhe@arcam.com
 Ms. Lena Thorsson (IUC Karlskoga AB), Tel.: +46 (0) 586 814 74;
 Fax: +46 (0) 586 819 55; Email: lena.thorsson@iuc.karlskoga.se;
 Web site: www.iuc.karlskoga.se

BACKGROUND

IVF Industrial Research and Development Corporation assists companies with research and development by means of direct custom projects, joint R&D projects with other companies operating in the same or similar fields, and links through various sector networks. Its core areas are founded on the experience of approximately 40 years of industry-related research activities. IVF has a staff of about 124 scientists, engineers, and support personnel, with a high proportion of graduate engineers and scientists. It works with leading edge companies, universities, industry organizations, and other industrial research institutes. It also works closely with the Swedish manufacturing industry in product, process, and production development. Sixty percent of IVF's funding comes from private industry, 40% from government. Its annual budget is approximately €14 million. IVF graciously invited representatives from three Swedish private companies, fcubic, SpeedPart, and Arcam AB, and from two institutes, the Swedish Ceramics Institute, and IUC Karlskoga AB. The companies and the institutes are developing solid freeform fabrication (SFF) processes.

Sweden has approximately 90 SFF machines. The technical mix of these machines is broad, with 17% SLA, 24% Laser Sintering, 36% FDM, 7% 3D Printing, and 15% miscellaneous (LOM, ink-jet, etc). These machines come from the United States (82%), Germany (17%), and Sweden (1%). Applications for these machines are similar to those in the United States, with the exception of medical applications, which is a small but growing area. Of these machines, 62% are in service bureaus, 24% are with end-users, and 14% are in universities and institutions of higher education. Materials used in these machines are 8% metal, 1% sand, and 91% plastic and other materials. In general, there are many uses of these machines for rapid prototyping, a fair number of uses for rapid tooling, and several unique uses for rapid manufacturing, notably a dental application by Nobel Biocare AB.

Indirect Metal Tooling

MetalCopy™ is an indirect method for making injection mold inserts for small series, bridge tools, and pre-series that was developed by IVF. This process features 1-2 weeks lead time and five hours of operator time with an investment cost of €90 thousand. The inserts can be used with all standard polymers, up to 100,000 parts, with accuracy of .2%, surface finish $R_a = 2 \mu\text{m}$, and good machinability. The general process flow is shown in Figure 2.5 in Chapter 2.

The MetalCopy™ SFF master is made with an SLA pattern. This process is similar to the KelTool™ process but uses different powder, binder, and infiltrants. This leads to lower shrinkage and a less costly furnace for sintering and infiltration. An example of the detail and surface and an example of an insert are shown in Figures B.9 and B.10 below.



Figure B.8. Example of surface and detail from MetalCopy™.



Figure B.9. Example of insert from MetalCopy™.

The limitations of the MetalCopy™ process are the size of a single insert piece, which must be less than 120 x 120 x 70 mm, and the fact it is only competitive to standard milling methods for complex geometries with deep grooves and slots. A barrier to the introduction of this process is the lack of knowledge by designers of its capabilities, notably, of its ability to create conformal cooling channels.

Direct Production

IVF is working with a spin-off company, fcubic (free form fast, www.fcubic.com), which is developing an SFF system for direct production, based on an aggressive development timeline (shown graphically in chapter 8, Figure 8.1). A demonstrator direct production system has been constructed at fcubic. This is an ink jet process that prints a catalyst into a ceramic bed, which is subsequently fired to low density and then infiltrated. This research machine has a 50 x 50 x 150 mm envelope. The jets can deposit 20 million points each second with a resolution of .04 mm. Layer thickness is approximately 0.05–0.07 mm. Parts that are recommended for this process should be small, complex, and relatively expensive.

High Speed Production

Speed Part is a Swedish company that is developing an SFF process with the potential to make parts very quickly. This process uses a mask to irradiate an entire layer and melt the unmasked portions of a powder bed. (A schematic of this process is shown in Chapter 2, Figure 2.2.)

In the Speed Part process, placing dry toner on glass generates the mask. This technology is protected by U.S. patent 6,531,086 B1. Speed Part is performing tests with a prototype and expected to deliver beta test machines in 2004. One application that was highlighted for this process was tools for vacuum forming machines. A part generated by the prototype system is shown in Figure B.11.



Figure B.10. Part produced in prototype Speed Part machine.

Direct Metal Production

Arcam is a Swedish company that is developing an SFF process for direct metal fabrication. This company and Speed Part were both founded by Ralf Larson (he also founded Sparx, one of the early SFF companies). Arcam uses an electron beam rather than a laser to selectively melt portions of a powder bed layer. A schematic of the process is shown in Figure 4.4 (Chapter 4). In the Arcam system, high-speed electrons are generated in the filament and anode. A deflection coil then controls these electrons. A powder container and a scraper blade deliver the powder layers. Figure B.12 depicts the scanning.

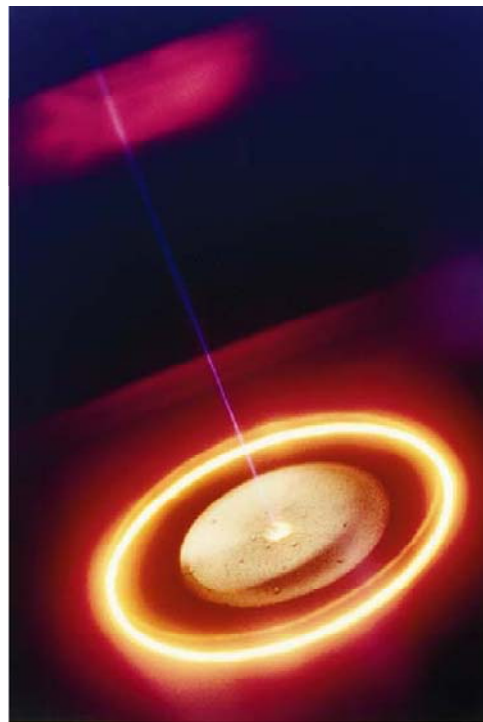

Figure B.11. Picture of electron beam melting.

Arcam has developed electron-scanning patterns to control thermal distributions in the bed. This is done by building squares and stitching these together. A typical melt pattern is shown in Figure B.13.

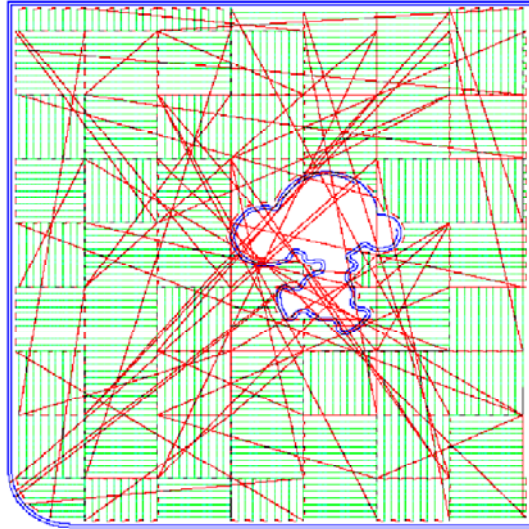

Figure B.12. Typical melt pattern in electron beam melting.

The electron beam has the advantage over a laser beam of directly coupling into a metal powder bed without reflection. The electron beam can also be controlled without mechanical scanners, which can lead to higher scan speeds. Arcam has made parts out of Ti6-4, commercially pure Ti, low alloy steels, tool steel, nickel alloys, and iron. Electron beam melting has to be done in a vacuum — with its inherent costs — but vacuum also allows processing of refractory metals. The Arcam EBM® commercial system is shown in Figure B.14.



Figure B.13. Arcam EBM® system

The parts produced from this system are impressive. Right out of the machine they are fully dense.

Indirect SFF of Ceramics

The Swedish Ceramic Institute (SCI) is an industrial research institute that works with ceramic and related materials. It is owned by an industry association and by the Swedish government (IRECO). The Institute serves industrial producers and users of ceramic materials. Funding for the indirect SFF of ceramics is provided by the Swedish Association for Industrial Ceramic Research, Vinnova, NEDO (Japan), and Nobel Biocare AB. The indirect SFF of ceramics process consists of freeform fabrication of a polymer mold, filling

this mold with a ceramic suspension, consolidating the suspension, removing the mold, and finally sintering to full density in an oven. SCI has used both SLA and Sanders ModelMaker II to make molds. One application that SCI is studying is making an implant for drug administration. This application requires evenly spaced cylindrical pore channels of 500 μm size.

One of the key issues with indirect SFF of ceramics is shrinkage during consolidation. Methods that can be used for consolidation are slip casting, gel casting, and direct coagulation casting. All of these methods exhibit shrinkage on consolidation, and this shrinkage can create cracks if the mold has internal structures that hinder shrinkage. SCI has developed latex binders with slip casting to reduce this cracking problem.

Materials for Direct Metal Laser Sintering

The IUC Karlskoga AB belongs to a national network of regional industrial development centers in Sweden. It has 2 EOSINT M250 xTended systems and its researchers work on new metal material systems for these machines. Specifications for powder mixtures for direct metal laser sintering include good packing density, powder mixture with a high-melting-base material with a low melting binder, no volatile elements, and similar coefficients of thermal expansion for the components of the mixture. In order to create strong materials that process well in the laser sintering machine, IUC is studying precipitation hardened materials. Precipitation hardened materials can be laser sintered in their soft condition and then aged to improve mechanical properties. The aging is a low temperature heat treatment that does not cause distortion. This concept has been applied to bronze, Cu15Ni8Sn, and maraging steel 18Ni250. IUC is developing the following metal materials for laser sintering: copper, bronze, steels, stainless steels, precious metals, high temperature metal matrix composites, and light metal matrix composites.

GENERAL DISCUSSION

After the presentations, the WTEC team had a general discussion with our hosts about the industry and research directions. The points that were made by our hosts included the following:

- There is no real combination of additive and subtractive research or commercialization in Sweden.
- New processing capabilities are leading to new business models. An example is the customized dental bridges being marketed by Nobel Biocare as the Procera® implant bridge.
- Customers want more functional parts.
- There is need for improved CAD for rapid manufacturing.
- Dental applications have a lower barrier to market entry than medical ones.
- Medical regulations appear to be a little easier to deal with in Europe compared to the United States.
- Fuel cell applications would be interesting, but no one is presently making fuel cells with these techniques. Technical issues include additive platinum layers, the combination of tape casting and SFF for fuel cell production, and the production of small channels by SFF.
- Marketing of the new capabilities of SFF needs to be improved.
- Speed needs to go up and price needs to go down to penetrate production applications.

- Site:** **Loughborough University**
School of Mechanical and Manufacturing Engineering
Rapid Manufacturing Research Group
Leicestershire, LE11 3TU, U.K.
<http://www.lboro.ac.uk/departments/mm/research/rapid-manufacturing>
- Date Visited:** 21 October 2003
- WTEC Attendees:** C. Atwood (report author), J. Beaman, D. Rosen, K. Lyons (observer), G. Hazelrigg (observer)
- Principle Host:** Professor Dr. Phill Dickens, Professor of Manufacturing Technology,
Tel.: +44 (0) 1509 227530; Email: P.Dickens@lboro.ac.uk
- Participants:** Dr. Russell Harris, Research Fellow, Tel.: +44 (0) 1509 227567;
Email: R.A.Harris@lboro.ac.uk
Dr. Richard Hague, Lecturer, Tel.: +44 (0) 1509 227619;
Email: R.Hague@lboro.ac.uk
Dr. Rupert Soar, Lecturer, Tel.: +44 (0) 1509 227637; Email: R.C.Soar@lboro.ac.uk
Dr. Neil Hopkinson, Lecturer, Tel.: +44 (0) 1509 227529;
Email: N.Hopkinson@lboro.ac.uk
Mr. Graham Tromans, Manager, Rapid Manufacturing Consortium,
Tel.: +44 (0) 1509 227548; Email: G.P.Tromans@lboro.ac.uk

BACKGROUND

Loughborough University is internationally recognized in several fields, including engineering, science, social sciences, and humanities. Grant income for 2001/2002 was \$47.5 million. The university has approximately 1,000 Ph.D. students. Special engineering focus areas are aeronautical and automotive; chemical; civil and building; electronic and electrical; systems; and mechanical and manufacturing. Within the School of Mechanical and Manufacturing Engineering there are 12 focus areas of research, including rapid manufacturing. The Innovative Manufacturing Research Center (IMRC) is the largest of 12 research centers in the U.K., with an annual budget of \$24 million over five years. The IMRC funding is from the Engineering and Physical Sciences Research Council (EPSRC). This covers approximately one-half of the mechanical and manufacturing engineering staff.

In the Loughborough IMRC, the Rapid Manufacturing Research Group is in the top 25% for the most funding. The Rapid Manufacturing Research Group has 35 staff and Ph.D. students and a \$1.25 million annual research budget that is guaranteed for five years. The funding guarantee is based on past performance and merit. Resources include a variety of RP processes, including a Stereolithography SLA 7000 and a ThermoJet Concept Modeler (see Figure B.15), as well as a laser sintering machine, and fused deposition modeler. Other support processes are high-pressure die casting, injection molding, investment casting, and reverse engineering capabilities. The group also has a full service computer aided design (CAD) lab with several design software tools.

The Rapid Manufacturing Research Group is focused on the transition from rapid prototyping to rapid manufacturing using traditional and new rapid prototyping processes. Their definition of rapid manufacturing is the use of additive manufacturing techniques to produce end-use parts in any number. They believe there is a need to manufacture end-use parts without tools, in a variety of materials (plastic, ceramic, metal), including multiple materials and graded materials, of any geometry.

The Rapid Manufacturing Research Group has several research projects in progress, all related to advanced/rapid manufacturing:

- Design for rapid manufacturing
- Rapid manufacturing of textures and smart textiles
- Materials analysis and design optimization of RM
- High viscosity jetting
- Direct fabrication of functionally graded structures
- High-speed sintering of powders
- Ultrasonic consolidation (UC)
- Management, organization, and implementation of RM
- IMS RPD 2001

In addition to its own research efforts, the Rapid Manufacturing Research Group has been selected to be the primary U.K. center for the European Network of Excellence on Rapid Manufacturing, called the NEXTRAMA project (see also Chapter 3).



Figure B.14. Loughborough's Rapid Manufacturing Lab machines: (*left*) Stereolithography SLA 7000; (*right*) ThermoJet Concept Modeler.

Selected Research Projects

Conformal Heating Channels for Polyurethane (PU) Foam Molding

The conformal heating/cooling channel project is an Engineering and Physical Sciences Research Council (EPSRC)-funded (3 years, \$700,000) project that began in October 2001. There are three primary areas of research: the performance of laminated production tools, effects of tool temperature on part properties, and eliminating the need for release agents in injection mold tools. Initial results indicated that laminate tooling with conformal cooling channels could be fabricated in less time and at less cost than using conventional cast methods. Final results will be released at the end of the project in 2004.

Design and Manufacture of Bespoke Soccer Boots/Cleats

It is estimated that footwear-related injuries of footballers cost \$125 million a year. The Rapid Manufacturing Research Group has a small project to investigate an economical method for manufacturing custom soles for football boots. Relative to the manufacture of injection mold tools for soles, the Group has determined that conventional computer numerical controlled (CNC) machining of aluminum cores and cavities is the most efficient method to customize one-of-a-kind soles. The Group is looking at follow-up projects, potentially including scanning of the foot by a podiatrist to optimize size and shape of the sole; FEA and physical test of orthotic design; FEA and physical test of stud position; and use of rapid manufacturing of outsoles and studs (see photos, Figure B.16).

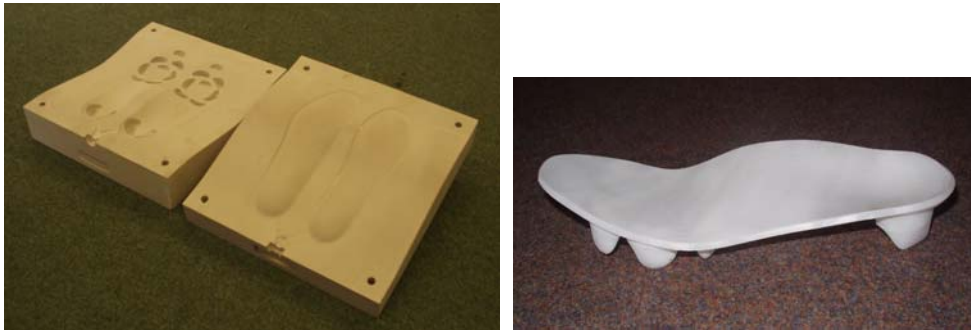

Figure B.15. (left) CNC machined injection mold core and cavity, and (right) a cleated outsole fabricated using RP technology.

High Speed Sintering for Production Quantities

The Rapid Manufacturing Research Group has a project looking at economics of fabricating production quantity parts using commercial-off-the-shelf RP processes and is comparing them to traditional manufacturing techniques like plastic injection molding.

Ultrasonic Consolidation for Embedded and Adaptive Structures

Ultrasonic Consolidation (UC) research combines ultrasonic seam welding and layered manufacturing processes using Solidica's Formation 2436 process. At the time of the WTEC team's visit, the primary application for this process was tooling, but in the future it could be applied to smart structures.

Loughborough researchers are presently performing a series of exploratory experiments to assess the viability of the process. Figures B-17 and B-18 show a series of micrographs from test specimens fabricated using the UC process. Another potential example of an embedded layer fabricated component is illustrated in Figure B.19.

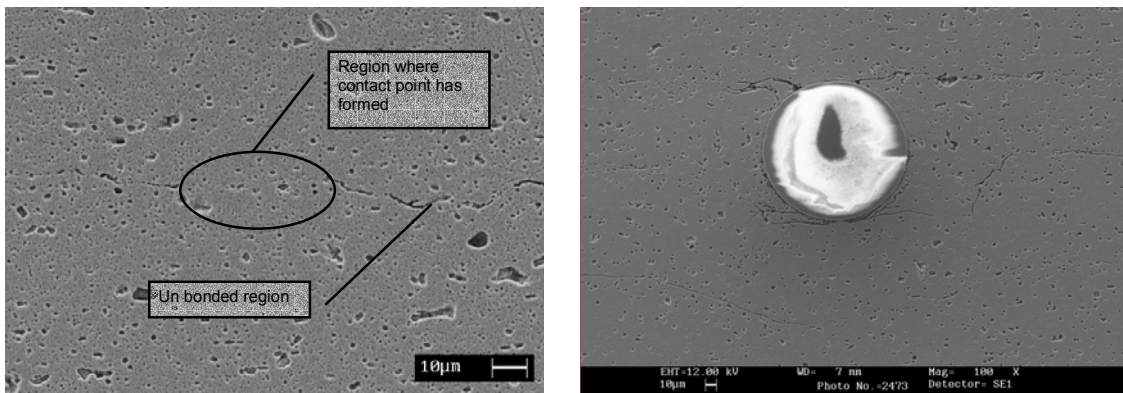

Figure B.16. Test specimens fabricated using the UC process: (left) bonded and unbonded regions; (right) embedded fiber optic for sensor application.

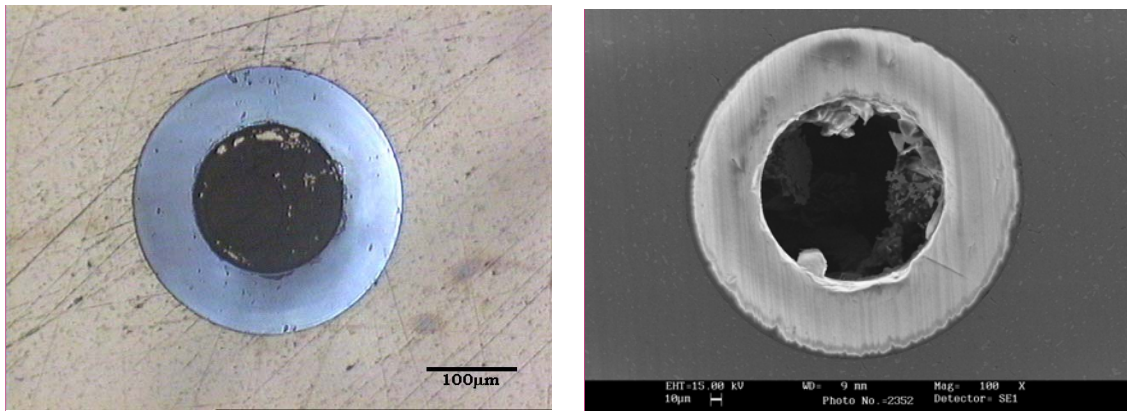

Figure B.17. Test specimens fabricated using the UC process: (left) filled embedded light wave guide; (right) unfilled embedded light wave guide.

- Embedded piezo devices.
- Wing de-icing.
- Vibration control with SMA and LWGs.
- Self-repairing structures with embedded SMAs.

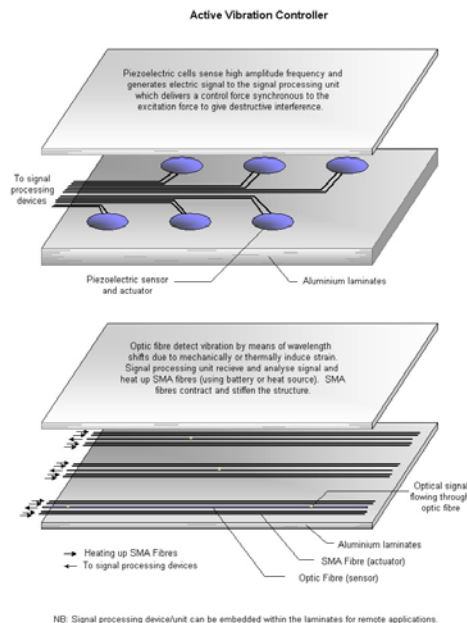

Figure B.18. Potential vibration control applications of UC.

Design for Rapid Manufacture of Parts

Assuming that RM exists and that issues of accuracy, surface finish, speed, CAD limitations, etc., are resolved, the main objectives of this project are to determine how the design of products and product development processes would change given the flexibility of RM processes. At present, designers are taught to design for manufacture, assembly, and serviceability, and that conventional manufacturing costs are related to complexity of parts and assemblies. With layer additive manufacturing processes, complexity is not normally an issue. Costs are linked to volume of parts and build direction. Therefore, RM is potentially cost effective for complex, low volume parts. This flexibility could change the paradigm from design for manufacture to manufacture for design. This research project is looking at issues and challenges that need to be addressed before RM processes can be exploited fully. Partners for this project are Delphi, Jaguar, Rover, MG, Custom Design Technologies, Rim-Cast, 3D Systems, and Huntsman.

Other examples comparing RM manufactured parts with traditional methods of manufacture can be found in Richard Hague's presentation to the WTEC group. Additionally, this project is supporting materials testing of several RM materials currently available off the shelf.

Materials Analysis and Design Optimization for RM

The EPSRC-IMRC funded the project Materials Analysis and Design Optimization for RM for 2 years and leveraged its funding (\$480,000) with \$520,000 from industry partners 3D Systems, Delphi, Huntsman, JCB, MG Rover, and Solid Concepts. The objectives of this project were to determine the bulk material properties for state-of-the-art RM materials and to correlate them by DSC analysis; investigate the variation of mechanical properties for differing cross-sections of RM parts by depth sensing indentation; and determine how an individual product designer's method of working will change by optimizing weight, performance, functionality, reduced assembly, and aesthetic considerations.

Problems of Computer Aided Design (CAD) Tools for Rapid Manufacturing

Generally speaking, CAD has become a recognized bottleneck in the RM process. Some of the pervasive problems with present CAD software tools that the WTEC group heard over and over from site hosts were

- difficulty of designing complex parts
- topologically "incorrect" models
- designing parts using functionally graded materials
- designing textures
- interpreting design intent
- user unfriendly for customer-led design
- file transfer types

Figure B.20 illustrates a CAD model that is topologically incorrect but easy for RM processes.

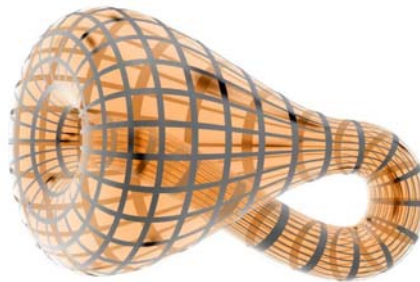

Figure B.19. RM processes can fabricate complex shaped parts that are difficult to model using existing CAD tools

Microlevel Design: Textiles

One unique application of RP/RM processes is the fabrication of textiles from various materials and of various repetitive geometries. The objectives of the Microlevel Design/Textile project are to determine the scope for RM textures and textiles; investigate the optimized design of complex textures and textiles at the elemental level for manufacture by additive techniques; examine methodologies for blending and mapping of textures to CAD models for subsequent rapid manufacture; and explore methodologies for the most efficient generation of textile macro assemblies from micro linkages. In addition to the textile work, this project is exploring the potential of fabricating enhanced textures for potential applications such as implants and microscale heat exchangers, etc. The photos in Figure B.21 illustrate microscale fabrication.

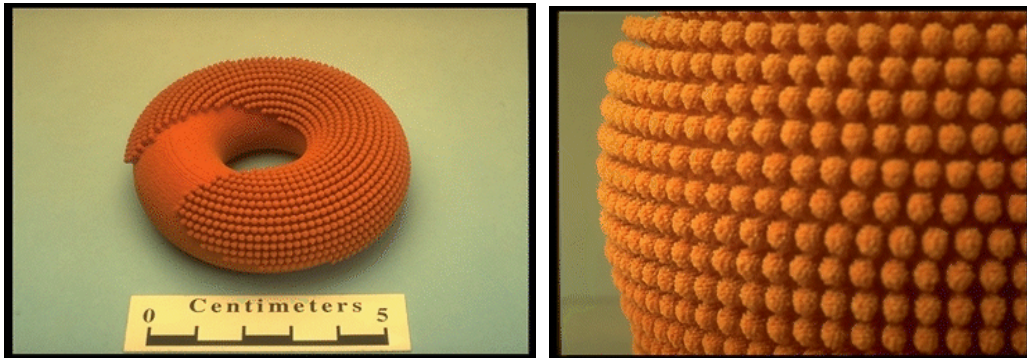

Figure B.20. Texture photos provided to the University of Loughborough from the Massachusetts Institute of Technology.

Rapid Manufacturing for Medical Implants

The Loughborough project on RM for medical implants is investigating the use of selective laser sintering for fabricating implantable devices from materials such as hydroxyapatite (HA) polymer. Hydroxyapatite is a man-made bioactive substance that can be combined with a polymer to produce a bioactive/biocompatible structure for implantation within the body. Processing HA powder using the selective laser sintering (SLS) process could be more efficient for implants requiring custom-shaped geometry. It would also allow for reverse engineering and rapid fabrication of bone implants and tissue scaffolds. Additionally, selective placement of different materials with unique healing properties could be done using the SLS process. Figure B.22 shows examples of HA/polymer parts; Figure B.23 is a micrograph of a laser sintered HA material.

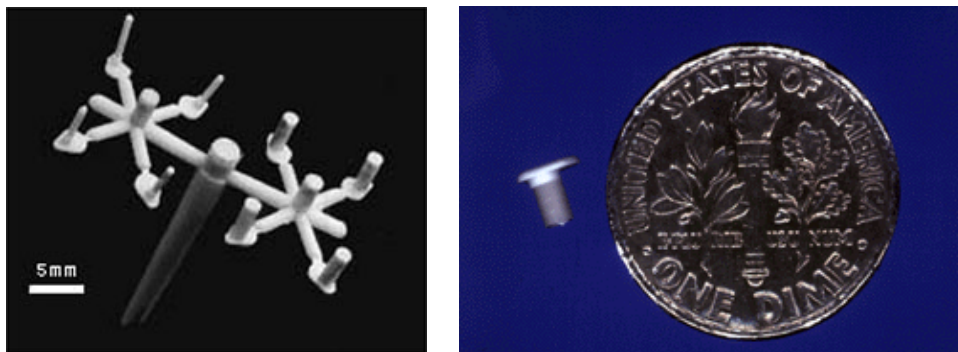

Figure B.21. (Left) Injection molded HA/polymer parts; (right) HA/polymer ear implant.

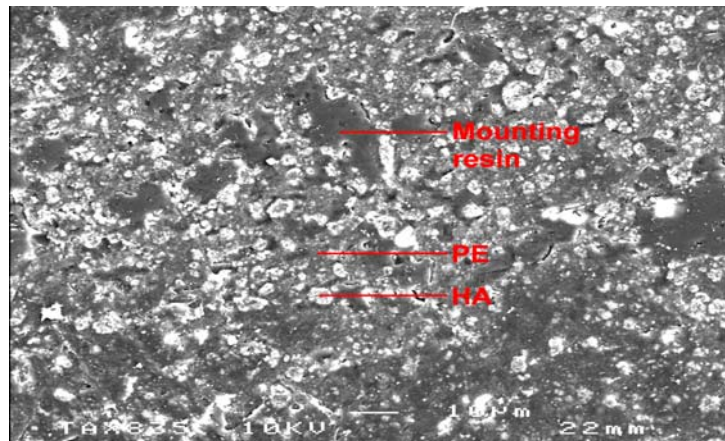

Figure B.22. SEM image of laser sintered HAPEX™.

Partners for this project are Loughborough, Queen Mary University of London, and Interdisciplinary Research Center in Biomedical Materials. The potential unique capabilities of implants fabricated by SLS are control of internal features during build, unlimited internal/external complexity, and controlled porosity leading to potential new applications.

Intelligent Manufacturing Systems Rapid Product Development Project (IMS RPD)

This is a European Union funded project concerned with speeding up the product development cycle for low volume (~500) production of metal and plastic parts. A primary focus of this project is to evaluate the MetalCopy process for use in high pressure aluminum die casting. This is an ongoing project with results to be published at a later date. Partners for this IMS project are Loughborough University, Danish Technological Institute, Ensinger, Materialise, ARRK, Fraunhofer IPA, IVF, Daimler Chrysler, Bombardier, and Prototal.

- Site:** **Manchester Materials Science Center (MMSC) and
University of Manchester Institute of Science and Technology (UMIST)
Sackville Street
Manchester, M1 7HS, U.K.
<http://www.umist.ac.uk>**
- Date Visited:** 22 October 2003
- WTEC Attendees:** D. Rosen (report author), C. Atwood, J. Beaman, Dr. Ted Bergman, G. Hazelrigg (observer), K. Lyons (observer)
- Hosts:** Dr. Brian Derby, Tel.: +44-161-200-3569; Fax: +44-161-200-8877;
Email: brian.derby@umist.ac.uk
Dr. Robert Freer, Tel.: +44-161-200-3564; Fax: +44-161-200-8877;
Email: Robert.freer@umist.ac.uk
Dr. John Hatfield, Tel.: +44-161-200-4724; Fax: +44-161-200-4770;
Email: j.hatfield@umist.ac.uk
Dr. Julie Gough, Tel.: +44-161-200-8958; Fax: +44-161-200-8877;
Email: j.gough@umist.ac.uk
Dr. Lin Li, Tel.: +44-161-200-3816; Fax: +44-161-200-3803; Email: lin.li@umist.ac.uk
Dr. Mohamed Missous, Tel.: +44-161-200-4797; Fax: +44-161-200-4770;
Email: missous@umist.ac.uk
Dr. Anthony Peaker, Tel.: +44-161-200-4752; Fax: +44-161-200-4770;
Email: peaker@umist.ac.uk
Dr. Robert Young, Tel.: +44-161-200-3551; Fax: +44-161-200-8877;
Email: Robert.young@umist.ac.uk

BACKGROUND

The WTEC panel visited two sites during this visit, the University of Manchester Institute of Science and Technology (UMIST), and the Manchester Materials Science Center (MMSC), which is an organization that is a joint collaboration between UMIST and the University of Manchester (UM). In 2002, it was announced that UMIST and the University of Manchester would merge to create the largest university in the U.K., with approximately 38,000 students. They are very close to one another geographically.

The MMSC has 25 academic faculty members, 100 undergraduate students, about 110 post-graduate students, 38 post-docs, and almost 40 other staff associated with it. At the time of the WTEC visit, funding levels for materials-related research at MMSC, UMIST, and UM totaled approximately £11.6 million, of which £4.6 million was through UM and £7 million was through UMIST. About half of this funding came from the EPSRC, one-quarter from industry, and the remaining from foundations, the European Union, and similar organizations.

OVERVIEW OF VISIT

The WTEC panelists met with representatives from three groups at the MMSC and UMIST:

- A group in the MMSC that focused on ink-jet printing and other additive manufacturing methods
- The Center for Electronic Materials (UMIST)
- The Laser Processing Research Center in Mechanical Engineering (UMIST)

INKJET PRINTING RESEARCH

About 15 researchers are involved in jetting research within the MMSC, led by Brian Derby. The primary focus of their jetting research is drop-on-demand (DOD) methods, rather than continuous jetting. They have explored a wide range of polymer, composite, and filled materials. Rapid drop formation is typically in the 5-6 kHz range. Research has shown that the hydrostatic head between the reservoir and the printhead is critical in achieving predictable DOD performance.

Much research at the time of the WTEC visit was with loaded suspensions to fabricate ceramic parts. For these suspensions, loadings of greater than 40 percent are desired to minimize shrinkage during sintering. Even then, volumetric shrinkage of 20 percent is typical. The highest reported loading was 45 percent. Viscosities under 40 mPa are needed. Typical material compositions included waxes, kerosene oils, and surfactants, plus the loading powder. Ceramic materials being studied, included alumina, PZT, and ZrO₂.

The inkjet research group is pursuing the development of predictive models of ink-jet printing, in part due to the perceived limitations of the inkjet industry. They believed that industrial technology is based on empirical results, and industry's predictive capability is minimal when deviating from normal operating conditions.

When printing, several phenomena are very important to the quality of the result:

- The shape of the deposited droplet is critical in forming 3D structures as it affects resolution, precision, and accuracy.
- Droplet splash must be avoided.
- Jetting frequency must be coordinated with the printhead sweep velocity.

As a consequence, there is an upper limit on build rate. Application of fluid mechanics theory has demonstrated that there is an important relationship between the Reynolds number ($\rho_g v d / \mu$) and Weber number ($\rho_l v^2 d / \sigma$), where ρ_g and ρ_l are the densities of the process gas and liquid drop, respectively. The variables v , d , μ and σ are the droplet velocity, droplet diameter, liquid dynamic viscosity and liquid surface tension, respectively. Empirically, it has been observed that these characteristics should satisfy $1 < Re / \sqrt{We} < 10$, which is the normal regime for DOD printing.

One application that was highlighted was the fabrication of ceramic resonators, including tunable resonators, for the communications industry. It was noted that Michael Cima from MIT was also working on this application with their 3D Printing technology.

A different application was the direct-write of conductors on polymer substrates. The example that was presented utilized a commercially available organometallic precursor liquid (containing silver). The precursor was printed onto a polymer substrate and the solvent was allowed to evaporate. A heat treatment converted the precursor compounds and left silver traces. Interconnects and circuits have been produced in this manner. The traces were about 200 μm wide.

An important limit was identified for jetting liquid materials. The UMIST researchers reported that droplets should not be smaller than 10 μm in diameter (about 1 picoliter) or their behavior after ejection from the printhead was not predictable enough for reliable printing. At sizes smaller than 10 μm , air resistance becomes a problem. If printing in a vacuum, to eliminate air resistance, the droplets tend to evaporate.

Julie Gough works in the bioengineering area. She has interests in printing tissue scaffolds and cells. One idea is to prepare collagen scaffolds by printing a mold, casting collagen precursors into the mold for subsequent processing. In another application area, she wants to print cells on bioglass for making tissue scaffolds. Ideally, one cell would be in each droplet. The group may investigate sensors to count the number of cells in a droplet as part of this work.

Equipment to support jetting research includes two experimental machines for fabricating parts, several printing stages with interchangeable heads, and several heads. One of the part-making machines is a

modified Sanders machine (modified for interchangeable heads). The other machine is a specially produced machine from Sanders that has a 4-jet head. The machines have heads from Sanders and MicroFab Technologies (Plano, TX). The MMSC personnel report that they are very pleased with the MicroFab heads and systems. The Sanders printhead produces 100 nm droplets and has very good repeatability.

To convert designs into machine code, the researchers are using standard CAD packages for modeling, converting the CAD models to STL format, and using the standard Sanders preprocessing software to drive their machines. The MMSC personnel noted that CAD will become a bottleneck in the very near future since CAD models and the STL format do not support multiple materials or graded materials. This will cause a problem in driving their new 4-jethead machine.

They also noted that height sensing would be a valuable addition to their printing machines. This is important when printing on non-planar substrates, or printing one material on top of other features. They were not working on sensors at the time of the WTEC visit.

The funding in the jetting area was described as robust in the U.K. A U.K. Department of Trade and Industry (DTI) study, due soon after the WTEC visit, was expected to conclude that the pharmaceuticals and electronics industries are likely to have significant needs for printing technologies. These applications are largely 2.5D, rather than general 3D, but the work will advance the entire jetting state of the art.

CENTRE FOR ELECTRONIC MATERIALS

The Centre for Electronic Materials is organized within the Department of Electrical Engineering and Electronics at UMIST and has a strong relationship with the University of Manchester. Professor Peaker runs the center, which has a total of 10 academic faculty and 55 students, post-docs, and research staff. Their research program has three major themes:

- Nanostructures and defects in semiconductors
- Quantum manufacture for optical and high speed devices
- Intelligent sensors and integrated systems

Profs. Peaker and Missous stressed the systems approach taken in the Centre. Their approach to research projects is to consider the entire range, including atoms, electronic devices, circuits, and systems. They illustrated their approach with examples that will be summarized here.

In the nanostructures and defects area, their main objective is to develop room-temperature nanodevices. They are studying defects in semiconductors for two reasons: (1) they want to utilize the behavior of defects as part of a device's behavior (defects are one type of nanostructure); (2) they want to minimize the number of defects or at least control them. Their research projects include the following. First, they are developing Laplace deep level transient spectroscopy to probe the local environment of impurities. The Centre invented this technique and has been pioneering applications in semiconductor materials, which include investigating hydrogen in silicon, characteristics of silicon-germanium, a Si/SiGe:Er laser, and defects in diamond. Second, they are developing electronic nanodevices and circuits created by writing or nano-imprinting. As one example, they have demonstrated a MOS gate for transistors that is 16 nm across. Third, they are investigating electrons as waves, rather than as particles, which should be useful in scaling electronic devices to tens of nanometers, rather than the hundreds of nanometers possible at present. Fourth, they are investigating nanostructured semiconductors in 2D and 3D. For example, they are exploring self-organizing 3D arrays of ErAs quantum dots in a GaAs matrix. They are also fabricating SiGe and other III-V semiconductor quantum dots, which have potential in memory devices.

The Centre for Quantum Manufacturing, run by Professor Missous, is part of the Centre for Electronic Materials. Its emphasis is on nonsilicon semiconductor materials, photonics, and magnetic materials.

Within the Electronic Materials and Quantum Manufacturing Centres, there is a molecular beam epitaxy (MBE) machine that is capable of growing films and features on 8-inch wafers. The machine has very good

layer control, capable of depositing atoms at rates from 1/100 layer/sec to 1 layer/sec. During processing, it the researchers can perform *in situ* measurement and can even perform e-beam lithography.

Two classes of projects were presented to the WTEC team. First, the fabrication of quantum dot arrays was discussed. Quantum dots are essentially 0D structures, since electrons are confined to move only within a dot. Quantum dots enable the replacement of other materials and features at much larger size scales. One application was in fabricating gates and other devices, where gate components (essentially plates) are laid on top of 20–30 dots. Since the dots are at a known X-Y distribution, on average, device components will contact a suitable number of dots to enable them to function properly. The second type of project was in metal semiconductor systems. The Centre researchers are interested in medical imaging systems in the terahertz range, roughly from 100 GHz to 10 THz. Using the MBE methods, they have demonstrated emitters and receivers fabricated in III-V materials that respond at appropriate frequencies.

Dr. Missous provided a good example of the Centre's systems approach to research and development with respect to medical imaging applications. Typically in the semiconductor industry, a black-box approach to product design is prevalent. That is, designers design around what is available, whether it is materials, devices, or circuits. Terahertz devices were needed, but it was difficult to fabricate them in standard materials. As a result, the researchers assembled a team of systems, technology, and materials people. They thought that they could develop new materials for this application. The team established performance targets for these materials. Then, the materials researchers focused on developing materials to achieve those targets, while the circuits and systems developers designed assuming that the materials performed according to the targets. In reality, there is always some uncertainty associated with the materials' capabilities to achieve desired performance. This uncertainty typically is not considered in the Centre's approach.

In the intelligent sensors area, Professor John Hatfield presented some of the Centre's work on artificial noses, including some of the materials and processing considerations. The WTEC group saw the systems approach applied to artificial nose development. New materials (conducting polymers), methods of processing those materials, and algorithm development are necessary for an integrating sensing and processing system, such as an artificial nose.

LASER PROCESSING RESEARCH CENTRE

Professor Lin Li directs the Laser Processing Research Centre at UMIST's Department of Mechanical, Aerospace, and Manufacturing. The Centre's 8 staff and 12 Ph.D. students collaborated with 16 companies and 6 academic departments. Their research facilities were extensive, consisting of more than 4000 ft², and housing 9 high power laser systems and a variety of other research and manufacturing equipment.

The research focus of the Laser Centre is laser-material interactions. Projects include laser cutting, drilling, welding, micro-machining, rapid prototyping and manufacturing, and surface engineering. In the area of subtractive manufacturing, Prof. Li presented results from concrete cutting with lasers and abrasive laser machining. He also presented work on laser drilling, where several new techniques have been developed, including spatter prevention, heat affected zone control, and taper control methods. Research on laser micromachining was also presented, with a focus on under-surface laser processing. In this application, an absorbent material (absorbs laser radiation) is sandwiched between transparent materials and a laser selectively ablates the absorbent material.

In the additive manufacturing area, Prof. Li presented work on laser-based electrochemical deposition, laser cladding, and a diffusion-based direct write process. The electrochemical deposition work is essentially local electroplating, where the laser controls the deposition pattern. A standard acid-copper electrolyte solution is used, in which a copper anode and stainless steel cathode are placed. The steel cathode acts as the deposition substrate. The electrolyte solution is heated to 333K to speed up the reaction rate. A potential of 20 mV, just under the threshold at which electroplating would occur, is applied. The laser scans over the steel substrate, providing enough thermal energy to cause the electroplating reaction to occur. Results of copper line deposition were presented. Additional results and analytical model development have been presented (Wee and Li 2003).

This work is similar to other electrodeposition approaches in the United States. Microfabrica (www.microfabrica.com, formerly called MEMGen) is a company that developed and commercialized the EFAB process (electrochemical fabrication). This process utilizes multiple steps. Patterned deposits are created using masks and photoresist. Dan Schwartz at the University of Washington has developed an electrochemical deposition process that utilizes small electrodes, mounted on XYZ stages, to provide patterned deposits (Wang, Holl, and Schwartz 2003). Various compositions of nickel and iron can be deposited, where the iron-rich compositions are used as the part, while the nickel-rich compositions are used as support material.

In laser cladding, Prof. Li had several projects. He presented work comparing the use of gas atomized powder and water atomized powder for metal laser cladding. Gas atomized particles tended to be spherical and have smooth surfaces, while water atomized particles were elongated and had rough, dimpled surface texture. Water atomized powders provided much better results, presumably due to their more effective absorption of the laser radiation relative to the highly reflective gas atomized spherical particles. The microstructure had a fine grain structure with strong texturing. Surface finishes of parts were better by a factor of two. For similar cladding process conditions, parts fabricated with water atomized powders were shorter (smaller layer thickness), which presumably was caused by more complete melting of particles and a higher density. Extensive modeling work had been performed to enable a better understanding of these phenomena.

An important application of the laser cladding work is in turbine blade repair, similar to the program at the University of Nottingham. Rolls Royce wants to maximize repair rate by minimizing the amount of material deposited and the amount to be machined (not more than 1 mm). The UMIST group has performed some modeling and path planning research to add value to the Rolls Royce process.

The final project that was presented was on diffusion-based direct write process for metals and ceramics on glass substrates. An example was presented that showed 20 nm thick titanium oxide lines in a glass slide. The oxide was patterned using a laser, then the glass slide was heated to 500°C to enable the oxide to diffuse into the glass. It was reported that a 1 μm thick, 1 cm \times 1 cm pattern takes about 1 minute to image. Also, it was reported that the process works for a variety of metals and ceramics.

DISCUSSION

The panel had a wrap-up discussion with Profs. Peaker and Li. We discussed several topics, including project funding mechanisms and the influence of regional development programs. Research funding in the U.K. is heavily influenced by policies that emphasize industry involvement and economic development, rather than basic research towards scientific fundamentals. As a result, many projects involve large, multidisciplinary groups, sometimes across multiple universities, with one or more companies. It seems that European Union research programs have a similar structure. Much of the research we saw was industry driven, but at UMIST, it was clear that basic research was not being ignored, but was being performed in addition to the more applied, industry-oriented work.

In the U.K., the Department of Trade and Industry has a regional development initiative that is targeted at the economic competitiveness of underdeveloped regions in the U.K. Manchester falls within one of these underdeveloped regions and has received considerable funding from this initiative. This funding can be used to support research and educational laboratories and enables the development of short courses, modular degree programs, and other educational programs. As one example, Prof. Peaker reported on a modular Master's degree program that is offered by 6 participating U.K. universities to train practicing engineers in the electronics industry. Engineers in the Manchester area, across the U.K., and throughout parts of Europe have participated in this program. Prof. Li is participating in the establishment of a mold/die center with the University of Wolverhampton, among others, that would be similar in nature.

REFERENCES

- Wee, L.M., and L. Li, 2003. Laser micro-prototyping by selective thin layer metal deposition within fluid environment. *Proceedings Int'l Conference on Advanced Research in Virtual and Rapid Prototyping* Leiria, Portugal, Oct. 1-4.
- Wang, W., M.R. Holl, and D.T. Schwartz, 2001. Rapid prototyping of masks for through-mask electrodeposition of thick metallic components. *J. Electrochem. Soc.* 148(5):C363-C368.

Site: Polytechnic Institute of Leiria (IPL)
School of Technology and Management (ESTG)
Virtual and Rapid Prototyping (VRAP) Conference
2411 - 901 Leiria, Portugal
<http://www.ipleiria.pt/>

Date Visited: 1–4 October 2003

WTEC Attendees: D. Bourell, D. Rosen

Hosts: Dr. Paulo Bartolo, Virtual and Rapid Prototyping (VRAP) Conference

Two WTEC panelists attended the Virtual and Rapid Prototyping Conference (VRAP), held at the Polytechnic Institute of Leiria, known by its Portuguese acronym, IPL. This site visit report focuses on A/S research activities at IPL, the Technical University of Lisbon, Oporto University, as well as some industry efforts in the Leiria region.

POLYTECHNIC INSTITUTE OF LEIRIA

When IPL was founded in 1987 it consisted of only the School of Education. Since then, IPL has grown to include 5 Schools; it employs about 600 faculty members and has about 9000 students. In 1989, the School of Technology and Management (Portuguese acronym, ESTG) was formed. This is now the largest school in IPL, with about 4600 students. ESTG offers Bachelor's degrees only, but is on track to offer Master's degrees in a couple of years. In 1995, ESTG moved to new facilities.

Dr. Paulo Bartolo, the head of Mechanical Engineering in ESTG, organized the VRAP Conference (www.estg.ipleiria.pt/dem/vrap2003/index1.php). At ESTG he has aggressively pursued a research and education agenda in product development, with a focus on rapid prototyping and related A/S technologies. In support of this agenda, the department has assembled several laboratories with a good collection of modern equipment. A partial list of equipment includes a ThermoJet from 3D Systems, machining centers, injection molding machines, and silicone molding machines. It also has metrology equipment including a laser scanner, CMMs, and access to a CT scanner.

The research agenda related to A/S appears to fall into four categories: stereo-thermal-lithography, rapid tooling, reverse engineering, and tissue engineering; each effort is summarized below.

Stereo-thermal Lithography

This research area was started by Paulo Bartolo and his Ph.D. advisor, Geoffrey Mitchell, at the University of Reading in the U.K. The basic idea is a generalization of stereolithography that enables much finer resolution. Two-photon photopolymerization is used rather than the typical 1-photon approach in stereolithography. For the 2-photon approach, two lasers at different wavelengths are used to initiate polymerization. A UV laser activates a photoinitiator, while an infrared laser locally heats the resin, inducing thermal initiation. Both lasers must be active in a small region of the monomer resin in order for polymerization to occur. This means that the reaction pathways of the photo and thermal initiators must be carefully selected to interact properly to induce polymerization.

It appeared from the presentation that Bartolo had demonstrated stereo-thermal lithography in the laboratory, but the WTEC panelists did not see the equipment. The polymerization of polyesters to make parts is the intended application.

Rapid Tooling

The Leiria area has many toolmakers and injection molders, and ESTG provides many of the technicians and engineers for this industry. Researchers at ESTG are investigating a wide range of rapid tooling methods and materials. They are involving local industry representatives in their work in order to help modernize practices. At present, Portugal can compete favorably with many mold makers and molders on a global basis, but its industry leaders are starting to realize that they must improve their practices to remain competitive.

High speed machining and silicone molding equipment is used to perform the rapid tooling research. Collaborations with Roland Corp., in particular, have resulted in the installation of high speed, easy-to-use machining centers in ESTG. One direction of its research is to investigate mechanical and material property differences in parts molded in rapid tools versus conventional steel tools. Its scientists have integrated their work in reverse engineering with rapid tooling and molding to replicate physical parts, including artwork.

Reverse Engineering

The ESTG researchers have pursued a biomimetic approach in much of their research. Their work in reverse engineering takes a biologically inspired approach to acquiring and interpreting images and point clouds, seeking to mimic the human vision system. They have developed reverse engineering software called BioCAD (biologically based CAD) that combines photogrammetry and human vision techniques. Using this approach, they have demonstrated how to correct certain distortions that are present in photographs.

ESTG scientists have demonstrated BioCAD and their reverse engineering methods on a wide range of applications, including a cathedral, sculptures, and hands (for fitting prostheses).

Tissue Engineering

Applying their biomimetic approach, the ESTG researchers are investigating cellular scaffolds for soft tissue engineering applications. They have selected a natural material, alginate, since it is biocompatible, non-toxic, biodegradable, and has other favorable properties. Alginate is a hydrogel found in some plants, such as brown algae, and has a block copolymer structure. It can be produced by mixing sodium alginate and calcium chloride. To date, they have investigated the cure kinetics of various concentrations of sodium alginate and CaCl_2 and demonstrated that desired shapes and sizes of the hydrogel could be produced. Future work will be needed to develop a manufacturing process for this material.

TECHNICAL UNIVERSITY OF LISBON

The WTEC team did not visit the Technical University of Lisbon but learned about some of its activities at the VRAP Conference. The two faculty members that participated at the conference were Rui Vilar and Jose Ferreira. Our comments on their research will be limited to what we gained from the Conference.

Dr. Rui Vilar

Dr. Vilar is a materials scientist and leader of the Laser Materials Processing Group. His area of expertise is in alloy development and prediction of microstructures of laser clad metal alloys. Two papers presented at the VRAP Conference dealt with extension of these principles into rapid manufacturing of metallic components and composites. Dr. Vilar's group has also extended previous work on laser cladding of tool steel to multilayer freeform processing of martensitic steel, including the role of alloying on martensite formation and the effects of multilayer processing on tempering of martensitic structures.

Dr. Jose Ferreira

Dr. Ferreira collaborates with Paulo Bartolo at ESTG in the areas of reverse engineering, BioCAD, and rapid tooling.

OPORTO UNIVERSITY

A research group from Oporto University in Oporto, Portugal, presented a paper at the VRAP Conference on an indirect rapid tooling method for the fabrication of metallic tools. A ceramic mold is prepared, then metal is cast into that mold to form the rapid tool. The group demonstrated the fabrication of tools in aluminum and copper alloys.

INDUSTRY ACTIVITIES

The injection molding industry has a large presence in the Leiria region of Portugal. It primarily serves the automotive, aerospace, and consumer products markets. Companies are competitive throughout Europe and on a global scale, but are increasingly pressured by countries with lower cost structures (e.g., China). In response, the industry has taken some dramatic steps to increase its competitiveness.

One notable step is to form a consortium of over 50 companies and to develop meeting, office, and laboratory facilities to support interactions among member companies. The consortium is called CENTIFME. In its facilities are meeting spaces where some university courses are offered, as well as machining, rapid prototyping, and molding equipment. It has a new Sinterstation 2500 to support its efforts in prototyping and rapid tooling.

CENTIFME members are involved in research activities. An employee of one of the member companies authored one paper at the VRAP conference. The paper was on the generation of finite element meshes from STL files of parts. This work represents the sophistication of engineering and molding practice that is becoming common in the Leiria region.

Site: **TNO Industrial Technology**
P.O. Box 6235
5600 HE Eindhoven
The Netherlands
<http://www.ind.tno.nl/en/index.html>

Date visited: 23 October 2003

WTEC Attendees: D. Bourell (report author), S. Hollister, K. Cooper (observer), H. Ali.

Hosts: Mr. Johan de Kievit, Business Development Mgr., Dept. Ind. Proto. & Polymer Tech.,
Tel.: +31 (0) 40/265 04 13; Fax: +31 (0) 40/265 03 02; Email: j.dekievit@ind.tno.nl
Mr. Rik Knoppers, Tech. Dept. Manager for Dept. of Ind. Proto.,
Tel.: +31 (0)40-26 50 127; Fax: +31 (0) 40-26 50 769;
Email: g.knoppers@ind.tno.nl
Mr. Frank Vercauteren, Polymer Specialist., Tel.: +31 (0) 40/265 04 65;
Fax: +31 (0) 40/265 03 02; Email: f.vercauteren@ind.tno.nl
Dr. Alois H.A. Tennemans, Manager, Dept. Polymer Tech.,
Tel.: +31 (0) 40/265 04 00; Fax: +31 (0) 40/265 03 02;
Email: a.tinnemans@ind.tno.nl

BACKGROUND

TNO (the Netherlands Organization for Applied Scientific Research) operates about 15 applied research and development labs in the Netherlands that have topic-specific interests. The TNO labs are nonprofit, non-government entities with a combined budget of €524 million and a total of 5500 employees. Due to the nature of their funding, the TNO labs tend to work more closely with each other than do the Fraunhofers. TNO is an interface between university basic research and business applications and commercialization.

TNO Industrial Technology in Eindhoven specializes in industrial technology and goes by that name. There are seven Industrial Technology divisions, including industrial prototyping and polymer technology. TNO Industrial Technology has 500 employees and a budget of €50 million (2002). Of this, 15% is block funding from the national government and 85% comes from contract research. Clients are innovative organizations. The Industrial Technology vision is to increase competitive strength and combine its own know-how with the expertise of its clients and of other TNOs. Its emphases are on product development; mechatronics and embedded systems; manufacturing development; industrial prototyping; polymer technology; surface engineering and metals technology; and textile technology.

Equipment

TNO Industrial Technology has an EOS SLS machine, a Stratasys FDM machine, two home-built inkjet machines, a home-built FDM machine, and a recently purchased Envisiontec Perfactory machine. This uses a micromirror array to create a mask for SLA.

Additive Manufacturing

The WTEC team's hosts at TNO Industrial Technology reported eight projects in additive manufacturing:

1. creation of buffer parts in nylon (SLS) for aerospace applications, which spotlighted short-run manufacturing such as grinder housings
2. a mass customization demonstration based on a custom-fit hand fixture such as a handball grip
3. use of FDM to create biological scaffolds for growing heart tissue, backbone discs, and orthotics
4. development of a high-viscosity inkjet system and multimaterials and graded materials; the details are proprietary, but an inkjet system has been developed that can print using 200 centipoise liquids, about 20

times more viscous than commercial inkjet systems. This opens the possibility for direct printing of liquids with larger solids content and for direct printing of biological materials

5. creation of benchmark Mg die casting dies, with Ericsson, for cell phone covers
6. an €8 million project that was just starting to advance development of conformal cooling channels
7. systematic development of design rules for rapid manufacturing
8. development of a “micro-SLS” process based on selective drying and fusing of various dispersions; the drying and fusing steps may be done sequentially or simultaneously

Subtractive Manufacturing

Five projects in subtractive manufacturing were described as under development:

1. a massive chainsaw apparatus for cutting a damaged submarine (the Russian nuclear sub *Kursk*) in half
2. small cutting tools for micromachining; here, a milling tool with a 150 μm diameter was shown
3. high speed machining based on STL (low intelligence, easy to communicate)
4. product realization process involving product design, mold design, CAM, mold fab, and part production
5. high-speed automatic machining software called “FlashMILL”; it is designed to use STL data of a mold file to create automatic tool paths for milling.

A final project was development of a knowledge-based system called “Flash TL Mold,” used to make injection and die casting molds from STL files of parts. This will be software for dummies; just push the “GO” button. It will create mold geometry from part geometry.

Materials Development

Industrial Technology’s materials developments center around polymers and polymer binders. In addition to working on high-viscosity inkjet polymers, TNO researchers are working to improve materials properties of existing polymers. Other projects entail development of polymer-filled ceramics, glass-filled ceramics, ceramic-filled biopolymers, radiation-curing low-shrinkage polymers, nanocomposites, electroactive materials, and multiple materials. Other materials areas are organic coatings, electronic polymers, functional polymers, biomaterials, antifouling and self-repairing coatings, biodegradable polymers, starch and nanoclay-based nanocomposites.

Biomedical

Rapid manufacturing of dental elements/crowns and other implants are among Industrial Technology’s biomedical foci. These use 3DP process and ceramic composites.

Other

Other applications and projects include wafer-steppers, micropositioning for MEMS, protective equipment for firefighters, and composite bridge lightweight structure.

Future

There is a TNO philosophy that manufacturing processes must have high-tech background operating procedures that make them more user-friendly. An example was the camera that 100 years ago demanded of the user knowledge and skill in optics, science, and chemistry, but which now is a simple “point and shoot” approach for users. The WTEC team’s hosts felt that this was possible for RP/RM technologies but that it would be much more difficult to incorporate into high-speed machining. This will give RP/RM technologies an edge in the future. Also, high-speed machining cannot produce all possible geometries without re-fixturing the part, since all parts must be clamped, and the clamped region of the part cannot be machined.

Site: University of Bremen
Bremen Institute of Industrial Technology and Applied Work Science (BIBA)
Product Development, Process Planning and Computer Aided Engineering (PPC)
Hochschulring 20
D-28359 Bremen, Germany
<http://www.biba.uni-bremen.de>

Date Visited: 20 October 2003

WTEC Attendees: T. Bergman (report author), D. Bourell, K. Cooper (observer), H. Ali

Hosts: Prof. Dieter H. Müller, Tel: +49 (0) 421/218-5531; Fax: +49 (0) 421/218-5551;
Email: ml@biba.uni-bremen.de
Claus Aumund-Kopp, Department Head, Virtual Product Development and Rapid
Technologies, Tel: +49 (0) 421/218-5584; Fax: +49 (0) 421/218-5551;
Email: ak@biba.uni-bremen.de
Eckhard Wellbrock, Tel: +49 (0) 421/218-5528; Fax: +49 (0) 421/218-5551;
Email: wel@biba.uni-bremen.de

BACKGROUND

The Bremen Institute of Industrial Technology and Applied Work Science (BIBA) at the University of Bremen is a production engineering-oriented academic institution. The Product Development, Process Planning and Computer Aided Engineering (PPC) research division explores solutions for transforming geometrical models into physical products. It develops software systems for the support of one-of-a-kind and prototype production and offers degrees in production engineering, industrial engineering, professional pedagogy, and systems engineering. The BIBA PPC has 110 employees (42 percent scientists). BIBA is involved in service jobs, and funding is through research centers, with Europe funding 80 percent of the total. There are about 180 ongoing projects, and some spin-out companies have been formed.

Rapid Tooling

The focus of BIBA PPC is information technology and computer aided systems design as applied to the manufacture of functional models.

Software for Tooling

An interesting example that was featured during the WTEC visit is “VisCAM” which is an experience-based software tool that allows service bureaus to preprocess geometric data before export to Rapid Prototyping machines. Additional modules allow researchers to determine the optimal prototyping strategy, optimal fabrication method, and optimal finishing operations for prototypes as a function of the desired geometry, functionality, and surface finish. The software appears to have special value to small companies or to younger designers with limited experience in prototyping and includes a tooling design component, a tooling instructor component, and a tooling selector. The software has been commercialized by Marcam Engineering GmbH in Bremen, and is distributed under the name VisCAM RP.

Physical Tooling

One physical process that had been developed and is completed is the formation of physical prototypes using “RAPTEC.” This process involves making dies for sheet metal forming (Müller and Sladojevic 2001). The molds are formed of individual sheets of shaped metal (aluminum) plates that are then clamped together to form a die for sheet metal forming. The process allows for quick prototyping of functional parts.

Two physical processes that are currently being investigated are:

- a) layered fabrication of tooling using electron beam-welded stacked sheets with layer-by-layer milling

- b) contour crafting in conjunction with activities at the University of Southern California.

Finally, BIBA PPC is exploring how physical rapid prototyping may be combined with three-dimensional visualization of CAD data for purposes of design.

Future Directions

Future challenges facing the overall rapid prototyping/manufacturing community noted in discussion include:

- a) the need for new materials development,
- b) the need to identify niches rather than broad market application (pattern making),
- c) the need to have rapid manufacturing compete head-to-head with material removal methods that have fast cutting speeds and superior finishes.

Challenges specific to BIBA include the fact that most large manufacturing companies are located in the southern part of that country and the location of decision makers in the South is cause for a potential bottleneck.

REFERENCES

Müller, H., and J. Sladojevic, 2001. Rapid tooling approaches for small lot production of sheet-metal parts. *Journal of Materials Processing Technology* 115:97-103.

- Site:** **Albert Ludwig University of Freiburg**
Freiburg Materials Research Center (FMF)
Stefan-Meier-Strasse 21
D-79104 Freiburg, Germany
- Date visited:** 21 October 2003
- WTEC Attendees:** S. Hollister (report author), D. Bourell, Dr. Theodore Bergman, K. Cooper (observer), H. Ali.
- Hosts:** Prof. Dr. Rolf Mulhaupt, Head, Materials and Technology Div.;
Tel.: +49/761 203 6270; Email: mulhaupt@fmf.uni-freiburg.de
Mr. Andreas Pfister, PhD student; Tel: +49/761 203 4729;
Email: andreas.pfister@fmf.uni-freiburg.de
Mr. Rudiger Landers, PhD student; Tel: +49/761 203 4729;
Email: landers@fmf.uni-freiburg.de
Mr. Hendrik John, General Manager, Envisiontec; Envisiontec GmbH, D-45768 Marl,
Germany; Tel: +49(0)2365 915-460; Email: info@envisiontec.de

BACKGROUND

Professor Mulhaupt heads the Materials and Technology division of the Freiburg Materials Research Center (Freiburger Materialforschungszentrum [FMF]). The interests of the Materials and Technology division are:

- 1) polymer design
- 2) design of hybrid materials
- 3) reactive processing
- 4) nanotechnology
- 5) characterization
- 6) tissue engineering
- 7) dental materials
- 8) rapid manufacturing

The philosophy for rapid manufacturing comes from FMF scientists who believe that smaller, more user-friendly systems are becoming more prominent. Mulhaupt likened the new direction of rapid manufacturing to desktop publishing, with the initial stages being very expensive but in later stages coming to the point where anybody that wanted one could afford a system. With regards to rapid manufacturing, the Freiburg Materials Research Center has worked on developing new materials for existing systems and on developing new, flexible systems. Finally, the Freiburg Materials Research Center was involved in the Freiburg Materials and Medical Platform, a collaboration with the Medical School at Freiburg to develop materials and rapid manufacturing processes for biomedical applications. Envisiontec is owned by a group of shareholders, the main one being in the United States. Its main product is the Perfactory, which is used for RP/Concept Modeling. Its owners were looking for partners for biomedical applications.

RAPID MANUFACTURING/RAPID PROTOTYPING

A new rapid manufacturing technology known as the 3D Bioplotter™ was developed initially by the Freiburg Materials Research Center, and a commercial version was later developed by Envisiontec (www.envisiontec.de) in conjunction with FMF. (An example of the Bioplotter is shown in Figure 2.7, Chapter 2).

This technology is based on dispensing material (or plotting material) into a liquid (or plotting medium). The plotting medium performs two major functions. First, it uses buoyancy forces to support the plotted medium.

Second, the plotting medium may also contain chemicals that can serve to carry on reactions with the plotted material. The 3D Bioplotter also has the unique ability among commercial machines to plot live, viable biological cells within a hydrogel. Plotting of both osteoblasts and myoblasts was demonstrated with mitochondrial respiration assays demonstrating that the cells were viable. Freiburg has one 3D Plotter system, which is used inside a bio-sterile hood in the Department of Oral/Maxillofacial Surgery in Freiburg for biomedical research. In summary, the 3D Bioplotter can use ceramics, polymers, and hydrogels.

The second rapid manufacturing technology called Perfactory, was developed solely by Envisiontec. (An example is shown in Chapter 2, Figure 2.5.)

The Perfactory SLA machine is a micro stereolithography machine using photocurable polymers. The unique aspect of this technology is its use of digital masks to build the layers. The digital masks contain 1,280 x 1,024 mirrors with a resolution of 32 μm . These mirrors are controlled digitally to allow various shades of light to expose the photopolymer. Use of this technology allows rapid curing of each layer with one light exposure. Furthermore, depending on magnification, very fine feature sizes can be built, down to 32 μm . Digital light is projected from the bottom up. In the future, UV light will be used. Surface quality is a problem.

In addition to the 3D Bioplotter system from Envisiontec, Freiburg had two other RP/RM systems that they used to test new materials. One was a ZCorp Z402 3D Printing machine. It was modified to accept a reduced quantity of materials and chemical-reactive instead of physical-binding systems. The second was a 3D printing machine built by BMT (DeskModelerTM). (BMT was then in bankruptcy.) Finally, our hosts at FMF also mentioned they worked with service companies to test new materials on a Selective Laser Sintering (SLS) machine.

MATERIALS DEVELOPMENT

In connection with the 3D Bioplotter, Freiburg has tested a number of materials ranging from ceramics to polymers to hydrogels. With regards to ceramics, Freiburg has used a paste consisting of hydroxyapatite (HA) ceramic, polyvinyl alcohol (PVA), and water. This paste is printed in the Bioplotter. The resulting ceramic may be sintered in a post-processing step to improve mechanical properties. Polymers that may be processed with the Bioplotter include polylactic/polyglycolic acid co-polymer (PLGA), poly ϵ -caprolactone (PCL), chitosan, and polyurethane. These polymers may be processed either using melt processing or by printing the polymer within a solvent. In addition, a printed polymer may be either thermal- or photo-cured within the plotting medium. Finally, hydrogels may be printed either using melt processing if they are thermoreversible gels like gelatin or agar, or may be produced using chemical reactive plotting where one material component is printed and the other reactive material component resides in the plotting medium. This is used for hydrogels where, for example, alginate is printed and Ca is in the plotting medium or fibrin where fibrinogen is plotted and thrombin is in the plotting medium. The complete range of materials, including processes that have been used on the Bioplotter, are shown in Chapter 6, Figure 6.3.

In connection with commercially available RP/RM systems, Freiburg has developed new materials for the ZCorp Z400 3D printing system. For this system, Freiburg has developed new ceramic-based powders that may be used on the ZCorp system. These ceramic-based powders include glass ionomer (dental) cement consisting of polycarboxylic acid and an ion leachable glass, and a zinc polycarboxylic cement consisting of polycarboxylic acid and zinc oxide. These materials were tested in a ZCorp machine and the resulting parts showed increased mechanical stiffness and strength compared to existing powders. In addition, 3D objects printed with the new powders are not water-soluble.

Finally, Freiburg is also working on new materials for the SLS systems, including a high thermal conductive polyamide.

CAD

There was no specific new development in CAD systems for RP/RM applications at Freiburg. Both the Envisiontec 3D Bioplotter and the Perfactory system have their own software suites, which accept DXF or CLI contour files as input. Although neither machine currently accepts STL format data, there are plans to accept this format as input.

BIOMEDICAL

Freiburg demonstrated numerous biomedical applications, probably the most of any site that WTEC panelists visited. With the 3D Bioplotter, tissue engineering scaffolds were made with a number of materials. Hydroxyapatite scaffolds were made by printing a paste made of hydroxyapatite, polyvinyl alcohol and water. An orthogonal pore design was made with 600 μm pores. This scaffold was then sintered to consolidate the material and improve strength. In addition, polylactic/polyglycolic acid co-polymer scaffolds were fabricated with the 3D Bioplotter. The third class of scaffolding materials were hydrogels, of which alginate, fibrin, agar, and collagen gel scaffolds were fabricated. All fabricated scaffolds were seeded with cells, and cell proliferation assays were performed to demonstrate cell viability on the fabricated scaffolds.

Most interestingly, the Freiburg group demonstrated that live biological cells could directly be printed using the Bioplotter. Both osteoblasts and myoblasts were directly printed in both agar and fibrin hydrogels (see Chapter 6, Figure 6.4).

Results indicated that the cells were viable as printed within the gels. This is a very significant achievement, especially given that the Bioplotter is a commercial machine. In the United States, there have been advanced funding efforts to develop such machines, but the Bioplotter is a cell-printing machine that can be directly purchased off the shelf and used for research and commercial products.

Finally, Hendrik John from Envisiontec demonstrated three biomedical applications for Perfactory-built objects. The first was the production of shells for hearing aid components. Mr. John projected that hearing aid shell manufacturers could be a viable market for 25-50 systems, or €1-2 million. The second application was for the production of dental crowns and other dental fixtures. In this application, molds are built on the Perfactory system and ceramics are cast into the molds. Finally, the third application of the Perfactory system was making molds for tissue engineering scaffolds. In this effort, Envisiontec has worked with the Technical University of Vienna to make photocurable resins for the Perfactory system. They have demonstrated fabrication of calcium phosphate ceramic scaffolds via casting into the resins. In addition, Isotis, a biomaterials company in the Netherlands, has also used the Perfactory system to cast calcium phosphate ceramic scaffolds.

FUEL CELLS/ENERGY/ENVIRONMENT

Professor Mulhaupt briefly mentioned fuel cell research at the beginning of the WTEC site visit. However, the site visit was focused on biomedical applications, materials development, and the Envisiontec system, and no further descriptions were given of the fuel cell research.

In terms of environmental concerns, Freiburg is also working on polyamide recyclability for SLS systems.

FUTURE

Future work prominently mentioned was upgrading the 3D Bioplotter to utilize multiple nozzle systems in order to directly build multiple material parts or to deposit multiple cell types in the same scaffold. For the Perfactory system, work is underway to adapt more photocurable materials for use with the system. Other goals are to improve surface finish, improve stability of fibrins, use different cell types, and design for applications such as implants and biosensors. Laser sintering of various composite, reinforced (with

nanoparticles), and highly filled polymer powders based on polyamide and polyacrylates will be new efforts for which the Freiburg researchers are looking for feasibility, applications, and suitable machines.

BARRIERS

Freiburg researchers believed that one of the greatest barriers to advancing RP/RM work was the choice of materials available for use with current commercial machines and the size and cost of current commercial machines. The materials issue is especially relevant to biomedical applications, since few commercial machines can handle the wide range of materials necessary. In addition, it was mentioned that commercial systems like SLA and SLS should have adaptors to create smaller bin sizes, in order to allow for more efficient testing of new materials. It is often difficult to synthesize new materials in kilogram batches to test on commercial systems. With regards to availability of machines, producing smaller RP/RM machines that can essentially be used in any office would be one goal. Other challenges are time to market, competition from pharmacies, market acceptance, accreditation, clinical tests, and approval.

ASSESSMENT

Without a doubt, Freiburg was the most prolific and advanced research center for biomedical applications among the WTEC team's site visits.

The development of the 3D Bioplotter, in conjunction with the wide range of biomaterials that it can process, including ceramics, polymers and hydrogels, is a major step forward in scaffold fabrication. In addition, the ability to directly print live, viable cells makes this site one of the leading sites in the world for the embryonic technology of cell/organ printing. What is extremely attractive is that the machine is commercially available, making it possible for any interested tissue engineering/biomaterials researcher to begin work in this area. This means that a commercially available machine from Envisiontec is equivalent to or ahead of current research in the United States that has specifically funded development of such machines. *Furthermore, given the philosophy of Envisiontec of looking for partners to develop the Bioplotter technology, this is an excellent opportunity for collaboration between the United States and Freiburg/Envisiontec for advancements in biomedical applications of RP/RM.*

Another prominent aspect of the Freiburg work is the integration of materials development with RP/RM technology. The development of new powders and new materials is currently underway for the 3D printing and SLS technology, in addition to the Perfactory stereolithography system and the Bioplotter system. This type of integrative research will be necessary to move systems from rapid prototyping to rapid manufacturing.

REFERENCES

- Landers, R., A. Pfister, U. Hubner, H. John, R. Schmelzeisen, and R. Mulhaupt, 2002. Fabrication of soft tissue engineering scaffolds by using rapid prototyping techniques. *Journal of Materials Science* 37:1-10,
- Landers, R., U. Hubner, R. Schmelzeisen, and R. Mulhaupt, 2002. Rapid prototyping of hydrogel structures – Scaffolds for artificial organs. *International Journal of Artificial Organs* 25:622-623.
- , 2002. Rapid prototyping of scaffolds from therm-reversible gels for tissue engineering applications. *Biomaterials* 23:4437-4447.

- Site:** University of Leeds
School of Mechanical Engineering
Design and Manufacture Research Group
Leeds LS2 9JT, United Kingdom
<http://www.mech-eng.leeds.ac.uk/>
- Date Visited:** 24 October 2003
- WTEC Attendees:** T. Bergman (report author), D. Rosen, K. Lyons (observer)
- Hosts:** Prof. T.H.C. Childs, Director of Research, Design and Manufacture Research Group,
Tel.: 0113 34 32165; Fax: 0113 343 2150; Email: T.H.C.Childs@leeds.ac.uk
Dr. K.W. Dalgarno, Deputy Director, Keyworth Institute, Tel.: 0113 34 32234,
Fax: 0113 343 2150; Email: K.W.Dalgarno@leeds.ac.uk
Dr. Alison McKay, Design and Manufacture Research Group, Tel.: 0113 34 32217;
Fax: 0113 242 4611; Email: A.McKay@leeds.ac.uk
Andrew Marsden, RP&T Facilities Manager, Keyworth Institute,
Tel.: +44 (0)113 343 2213; Fax: +44 (0)113 343 2167;
Email: A.J.Marsden@leeds.ac.uk
Michele Chen, Ph.D. student
Carl Houser, Ph.D. student

BACKGROUND

The Department of Mechanical Engineering at the University of Leeds consists of the core mechanical engineering sciences (combustion, fluid mechanics including tribology, as well as solids/dynamics and intelligent systems); the Design and Manufacture Research Group; and Interdisciplinary Outreach. The Design and Manufacture Group that the WTEC team visited includes an industrial outreach entity, the Keyworth Institute (www.keyworth.leeds.ac.uk/).

Equipment

The additive manufacturing efforts at Leeds include SLS of polymers and metals. Equipment includes a first generation prototype of an SLS 2000 machine, and a Vanguard HS si2 machine. An experimental facility for SLS of metals is available mainly for research purposes. The stated research goal in direct metal SLS is “to build parts from standard alloy powders without the need for substrates and other supports.”

Physical Modeling

A distinguishing feature at Leeds is the extensive physical modeling and experimentation directed to the understanding and prediction of the thermo-mechanical response of various materials to laser irradiation. Computational models have been developed for the laser-induced densification of amorphous polymers (polycarbonate) (Childs et al. 1999), crystalline polymers (nylon and glass-filled nylon) (Childs and Tontowi 2001) and metals (Hauser et al. 2003). Process maps (see Chapter 2, Figure 2.24) have been developed.

Biomedical Applications

Several biomechanical applications were discussed. Dr. Dalgarno is addressing SLS of bioactive glass ceramics including infiltration with biopolymers, utilization of SLS for presurgical planning, SLS of bone replacement materials, and mass customization of orthoses for sufferers of arthritis. In the case of SLS bone replacement materials, possible coupling between the bioactivity of the material, its geometric structure, and the processing of the material is not being investigated. The Design and Manufacture Group are interested in creating structural components with good fracture toughness and mechanical strength. Discussed also was the control of porosity and bioactivity in various applications.

Environmental Research

Dr. Dalgarno also presented work on energy efficient tooling for injection molding. The objective of this research is to demonstrate that conformal cooling in injection molds not only reduces cycle time, which increases productivity, but also reduces energy consumption. With these reductions, fewer injection molding machines should be needed in the long term. This is two-year project that had just started, involving Leeds, a tool maker, several molders, and a professional association.

Service

As presented by Andrew Marsden, the Keyworth Institute is an affiliated service center. The mission of the institute is to provide support for teaching and service activities, as well as to be involved in small scale commercial projects.

FUTURE

An interesting presentation was made by Dr. Alison McKay. Her research centers on product information modeling. She presented a series of example projects that she has participated in, and focused on the flow of information in an overall manufacturing process chain. In her work, she considered the entire extended enterprise (supply chain), which could be geographically distributed. As rapid manufacturing evolves, it will become more important to understand, control, and optimize information flow.

Extensive efforts are underway to develop a program in the area of "Affective Engineering." This is being done in conjunction with the Faraday Packaging Partnership at the University of Leeds. This program examines the interface between consumer selection (as well as preference of products based upon their packaging) and the design and engineering of consumer packaging and products. Rapid prototyping may play an important role in enhancing our understanding of consumer response to various packaging designs, and in bringing new packaging designs to market in a timely manner.

Michele Chen, a Ph.D. student in the Affective Engineering program, gave a presentation on her research applying parametric shape grammars to the design of consumer products with sculpted shapes. She presented the specific example of Coca-Cola bottles. With parametric shape grammars, it is possible to generate designs with a consistent style and to make explicit the design history of product shapes. This work has potential application in reducing design time, in a manner consistent with "rapid manufacturing."

REFERENCES

- Childs, T.H.C., M. Berzins, G.R. Ryder and A. Tontowi, 1999. Selective laser sintering of an amorphous polymer - Simulations and experiments. *Proceedings of the Institution of Mechanical Engineers Part B - Journal of Engineering Manufacture* 213:333-349.
- Childs, T.H.C., and A.E. Tontowi, 2001. Selective laser sintering of a crystalline and glass-filled crystalline polymer: Experiments and simulations. *Proceedings of the Institution of Mechanical Engineers Part B - Journal of Engineering Manufacture* 215:1481-1495.
- Hauser, C., T.H.C. Childs et al., 2003. Direct selective laser sintering of tool steel powders to high density, Part A: Effects of laser beam width and scan strategy. In *Proceedings of the 2003 Solid Freeform Fabrication Symposium*. Austin, TX: University of Texas at Austin.

- Site:** **University of Liverpool**
Department of Engineering
Brownlow Street
Liverpool L69 3GH, U.K.
<http://dbweb.liv.ac.uk/engdept/>
- Lairdside Laser Engineering Centre**
Campbletown Road
Birkenhead
Merseyside CH41 9HP, U.K.
<http://www.lasers.org.uk/llec/>
- Date Visited:** 20 October 2003
- WTEC Attendees:** T. Bergman (report author), D. Rosen, K. Lyons (observer)
- Hosts:** Prof. Ieuan Owen, Dean, Faculty of Engineering, Tel: +44 (0) 151 794 4826;
 Fax: +44 (0) 151 794 4848; Email: i.owen@liverpool.ac.uk
 Prof. Ken G. Watkins, Director, Lairdside Laser Engineering Centre,
 Tel: +44 (0) 151 794 4820; Fax: +44 (0) 151 794 4585;
 Email: k.watkins@liv.ac.uk
 Dr. Christopher Sutcliffe, Manufacturing Science & Engineering Research Ctr.,
 Tel: +44 (0) 151 794 4316; Fax: +44 (0) 151 794 4703;
 Email: c.sutcliffe@liverpool.ac.uk
 Dr. Geoffrey Dearden, Deputy Director, Lairdside Laser Engineering Centre,
 Tel.: +44 (0) 151 794 4584; Fax: +44 (0) 151 794 4585;
 Email: g.dearden@liverpool.ac.uk
 Dr. Martin C. Sharp, General Mgr., Lairdside Laser Engineering Centre,
 Tel: +44 (0) 151 650 2305; Fax: +44 (0) 151 650 2304;
 Email: martinsharp@btconnect.com
 Prof. K.K.B. Hon, Leader, Manufacturing Research Group, Tel: +44 (0) 151 794 4680;
 Fax: +44 (0) 151 794 4693; Email: hon@liv.ac.uk
 Prof. David J. Schiffrin, Head, Electrochemistry and Nanochemistry Group; Director,
 Centre for Nanoscale Science, Tel: +44 151 794 3493; Fax: +44 151 794 3588;
 Email: schiffrn@liv.ac.uk
 Dr. Mathias Brust, Centre for Nanoscale Science (Dept. of Chemistry)
 Dr. David Fernig, Centre for Nanoscale Science (School of Biological Sciences)
 Dr. Simon Higgins, Centre for Nanoscale Science (Dept. of Chemistry)
 Dr. Richard Nichols, Centre for Nanoscale Science (Dept. of Chemistry)
 Prof. Paul Chalker, Leader, Functional Materials Research Group,
 Tel.: +44 (0) 0151 794 4313; Fax: +44 (0) 151 794 4675;
 Email: pchalker@liverpool.ac.uk
 Dr. Timothy Bullough, Functional Materials Research Group,
 Tel: +44 (0) 151 794 5399; Fax: +44 (0) 151 794 4667;
 Email: timbull@liverpool.ac.uk
 Prof. Peter Weightman, Dept. of Physics, Surface Science, Tel: +44 (0) 151 794 3871;
 Fax: +44 (0) 151 708 0662; Email: peterw@liv.ac.uk

BACKGROUND

Dean Ieuan Owen provided an overview of the University and the Faculty of Engineering. The University of Liverpool is composed of about 14,000 students overall, with 1400 in engineering. Of the 1400 students, 75 percent are undergraduates and 25% are postgraduates. Liverpool has outstanding personnel and facilities for additive and subtractive manufacturing and, in particular, laser-based manufacturing and materials processing.

The WTEC team first met with our hosts in Liverpool University's Foresight Centre (www.foresightcentre.co.uk/), which was established to promote interactions with industry. The desired result is to see universities play a role in "wealth creation." For the U.K., the U.S. universities serve as a role model regarding spin-off companies. The Business Development Office assists academics in getting work out into small companies. They also support "spin-ins" that allow small companies to work directly with faculty and use university resources. This is particularly used in the biosciences.

ADDITIVE AND SUBTRACTIVE MANUFACTURING

Of great interest was the unveiling of a very interesting part by Dr. Sutcliffe that included very fine and complex geometrical features (length scales of the features estimated to be on the order of 30 to 100 microns). The object was fabricated of 316 stainless steel on a SLS machine that had been developed recently by the German company Fockele and Schwarze (www.fockeleundschwarze.de/). This represents spin-off work from Fraunhofer ILT in Aachen. The WTEC team understood that the machine will be marketed by MCP Group (www.mcp-group.com/rpt/). The size of particles used to fabricate the part is around 20 micron diameter, while the laser spot size is approximately 60 microns in diameter with standard optics and 30 microns diameter with small spot optics. Forthcoming parts will have features that are further reduced by a factor of about two.

One application that is driving the need to develop fine-featured metal parts at Liverpool is the fabrication of micro heat exchangers. Other materials might be used for this application, but a tradeoff exists in that (a) *low* thermal conductivity metals such as stainless steel are easier to process to net shape due to the localization of high temperatures during manufacture, but (b) *high* thermal conductivity metals are desired for use in the application (heat exchangers) to increase the heat exchanger effectiveness. Other applications are biomedical implants, copper micro heat exchangers, and aluminum and titanium aircraft parts. Dr. Sutcliffe's group is working with Stryker Implants to develop new implant patterns, sustainable energy systems to develop heat exchanger technology, and various aerospace consortia for the development of ultralight aero structures

Also observed during the WTEC tour of the laboratory complex was an additive-subtractive cold spray facility. Similar to other cold spray techniques, a nozzle is used to accelerate particles to exit velocities on the order of 1500 m/s with deposition rates estimated to be approximately 1 cm³/s. The material that is deposited on a substrate with the scanning cold spray nozzle forms a continuous, ridge-type structure along the trajectory path. A sample was shown in which the ridge was subsequently sculpted to shape using a high speed machining spindle mounted adjacent to the deposition nozzle. It is also possible to use the deposition nozzle to machine the surface by using the same equipment operating under reduced processing velocities. At lower particle velocities, the sprayed aluminum particles selectively abraded away the previously deposited material. The cold spray facility has multimaterial capability. Cold spraying of ceramic powder has not been attempted on the current system. Ceramic materials lack the ductility required for this type of deposition. Recent advances reported in the literature had shown that ceramic deposition via cold spray was possible, and therefore steps were being made to modify the existing apparatus.

LASER GROUP AND LAIRDSIDE LASER ENGINEERING CENTRE

The university's Lairdside Laser Engineering Centre is located off-campus and includes a remarkable array of laser-based manufacturing equipment. The Centre complements the fundamental work done in the university's Laser Group, and is funded by the United Kingdom, the European Union (EU), and industry. Interest on the part of the EU is due to the fact that the Merseyside region has been identified as a geographical area in need of economic development and assistance. The Centre also participates in Aerolaser ATU (Agile Technology Unit) that is a network of Northwest Universities to support the aerospace industry. We were told that over 700 companies in the Northwest Region of the U.K. are involved in aerospace-related activity.

The Lairdside Centre includes laser-based machines and processes ranging from laser bending of sheet material to shape, to laser cutting and drilling, to laser marking, to layered manufacturing. The Centre

includes industrial CO₂ lasers with up to 3.5 kW beam powers and 6-axes manipulation, as well as industrial Nd:YAG lasers from 500 W to 4 kW beam power and 7-axes manipulation. The WTEC team observed the layered deposition of metal powder in a machine capable of sustaining < 5 ppm of O₂ in an argon atmosphere. The deposited material (NTi64) is fully dense. Graded materials have been processed using this machine. Significant design efforts have been directed to improving the process by controlling the fluid mechanics and thermal aspects of the powder feed nozzles. Greater control over the process was achieved at least in part by adding powder feed nozzles, which, in turn, reduced the gas particle velocities to levels in which otherwise turbulent flow was converted to laminar flow.

Microsystems Packaging

Professor Hon presented the National Microsystems Packaging Centre, a new research center funded at the £30 million level over five years. A new facility had been designed and construction was to begin soon about 1 mile from the University of Liverpool campus. The research focus will be on a broad range of electronics packaging issues covering a wide range of length scales. An integrated set of work packages has been developed, including Design for Micro-Manufacturing, Design for Test and Robustness, Packaging and Assembly Technology, and Modeling and Simulation. Applications include environmental sensors, radiation monitoring, and radio frequency ID (RFID).

NANOSCALE SCIENCE

Professor Schiffrin and colleagues at the Centre for Nanoscale Science are working in the areas of *nano-bio*, *nano-opto*, and *nano-electro* chemistry and physics. The main focus is directed to nanoparticle research. One fuel cell project was briefly discussed. Specifically, new catalysts had been developed with participation of Johnson Matthey and the University of Helsinki to produce a fuel cell membrane that would have as its end products both energy and hydrogen peroxide (H₂O₂), rather than water. Presumably, this electrochemical reaction would occur in a somewhat standard hydrogen-oxygen (air)-powered fuel cell. The motivation for this fuel cell project was to identify a new way to produce hydrogen peroxide, with the production of electrical energy an added bonus.

A second major initiative was on the study of redox switching for nanoscale electronic gates and switches. The idea is to attach a gold nanoparticle to a redox gate (molecule) that undergoes reduction and oxidation reactions. When the molecule is oxidized, it has a different conductivity than when it is reduced. Switches can be fabricated potentially that make use of this difference in conductivity. The preparation of a solution of gold nanoparticles is itself a significant project. Similar work was presented that demonstrated the usage of functionalized gold nanoparticles as biosensors using several different methods.

Nanoscale Materials Manufacturing

Professor Chalker runs a research program that includes projects on next-generation gate dielectric materials for ultra-large-scale-integrated circuits, GaInNAs laser materials for fiberoptic communication, III-nitride materials for MEMS devices, nanometer-scale characterization of device materials, and femtosecond laser processing. His Functional Materials Research Group makes use of a variety of CVD processes, molecular beam epitaxy processes, and a novel chemical beam epitaxy process. Femtosecond laser machining of internal passages in glass was discussed, and the WTEC team toured the experimental facility.

FUTURE DIRECTIONS

Discussions for future directions centered on the ability to fabricate objects from the nanoscale up.

- Site:** University of Nottingham
UNIMAT (Univ. of Nottingham Institute for Materials Technology)
University Park
Nottingham NG7 2RD, U.K.
<http://www.nottingham.ac.uk/schoolm3>
<http://www.nottingham.ac.uk/unimat>
- Date Visited:** 21 October 2003
- WTEC Attendees:** D. Rosen (report author), C. Atwood, J. Beaman, G. Hazelrigg (observer), K. Lyons (observer)
- Hosts:** Dr. Mark Bennett, Business Development Executive, Nottingham Technology Ventures,
Tel.: +44 (0) 115-951-5682; Fax: -3722; Email: mark.bennett@nottingham.ac.uk;
Website: <http://www.nottinghamtechnologyventures.com>
Dr. Trevor Farren, Business Development Manager, School of Chemistry
Prof. Nabil Gindy, Head, Advanced Manufacturing Technology Research Group,
School of Mechanical, Materials & Manufacturing Engineering & Management
(www.nottingham.ac.uk/schoolm3/research/amt/), Tel.: +44 (0) 115-951-4069;
Fax: +44 (0) 115-951-4140; Email: nabil@nottingham.ac.uk
Prof. Graham McCartney, Advanced Materials Group, Tel.: +44 (0) 115-951-3740;
Fax: +44 (0) 115-951-3800; Email: graham.mccartney@nottingham.ac.uk
Prof. Ian Pashby, Advanced Manufacturing Technology Research Group,
Tel.: +44 (0) 115-951-4012; Fax: +44 (0) 115-951-4000;
Email: ian.pashby@nottingham.ac.uk

BACKGROUND

UNIMAT (University of Nottingham Institute for Materials Technology) is a virtual center for materials research that involves about 120 academics from 14 schools at the University of Nottingham. It is set up to promote collaborative, multidisciplinary research in response to industry needs.

To enable better responsiveness to industry, UNIMAT has a full-time business development person (Mark Bennett). The group has taken advantage of the U.K.'s Third Stream Funding mechanism, wherein the government provides seed core funds for business development activity and increased industry interactions. Business development is meant to increase industrial sponsorship of research and enhance the exploitation of intellectual property to gain further royalties, licensing income, and the number of patents, while enhancing entrepreneurship.

The University of Nottingham has approximately 25,000 students.

One of those associated with UNIMAT, Prof. Nabil Gindy, runs the Rolls Royce University Technology Center (UTC) in Advanced Manufacturing Technology.

OVERVIEW OF VISIT

The WTEC team met with professors and business development personnel from the School of Mechanical, Materials, and Manufacturing Engineering, and Management (4M) and the School of Chemistry.

Mark Bennett, Business Development Executive for Nottingham Technology Ventures, presented the background on University of Nottingham and UNIMAT. He explained the role of various UK funding sources, including EPSRC, the Department of Trade and Industry (DTI), and regional funding initiatives.

Professor Nabil Gindy presented an overview of the Rolls Royce UTC, which he heads, and its work in developing a common strategy for additive and subtractive processes for the repair of turbine blades.

Professor Ian Pashby of the School of Mechanical, Materials, and Manufacturing Engineering and Management spoke about laser-based direct fabrication, including laser cutting and laser cladding.

Professor Graham McCartney of the School of Mechanical, Materials, and Manufacturing Engineering and Management spoke about three areas related to additive fabrication using particle deposition processes: (1) cold gas dynamic spray, (2) high velocity oxy-fuel thermal spray, and (3) shaped metal deposition.

Trevor Farren, Business Development Manager at Nottingham's School of Chemistry, presented on chemical methods for production of novel materials.

ROLLS ROYCE UNIVERSITY TECHNOLOGY CENTER (UTC)

Organizationally separate from UNIMAT but with overlapping technology foci, the Rolls Royce University Technology Center (UTC) is directed by Nabil Gindy. Rolls Royce has an aircraft engine manufacturing facility near Nottingham and started investing in a manufacturing technology center several years ago; it provides core funding for the UTC.

The UTC researchers are developing a common strategy for additive and subtractive manufacturing processes, with an emphasis on the repair of blades in engines. One project involves the repair of compressor blades using a combination of laser cladding and machining. The UTC researchers developed a repair system that includes both manufacturing hardware and a flexible, integrated information software system. They reverse engineer a damaged blade, generate an STL file, and generate plans for depositing material and machining or grinding extra material to the final shape. Two deposition strategies are being pursued:

1. Add a small amount of material exactly where needed and perform finish machining or grinding as required
2. Add a large amount of material without concern for accuracy and machine to desired shape

The former approach is more efficient but relies on a very careful reverse engineering of the blade. This is challenging, since blades can have extensive local damage. Point clouds generated from scanning methods must be fit to CAD models of the blade surfaces, which can be challenging for reverse engineering and inspection software. The latter approach is simpler to implement, but can require much more time in the finish machining. Three turbine blades with material deposited along different edges are shown in Figure B.24. Working on this project are 1.5 post-docs and 1 Ph.D. student.



Figure B.23. Turbine blades with laser cladding build-up.

LASER-BASED DIRECT FABRICATION

Ian Pashby reported on his research program in laser-based direct fabrication. His group's focus was on two activities, powder deposition and laminated tooling. He noted that his research theme was the processing of difficult-to-process materials.

In the powder deposition area, researchers were taking a laser cladding approach to deposit metals and to build features. The WTEC team's hosts showed us their diode laser from Rofin-Sinar that can produce up to 6 kW. They also use a 2.5 kW Nd:YAG laser and expected to be acquiring a 2 kW CO₂ laser in the near future. The diode laser was mounted on an X-Y-Z table, which also carried a powder feeding system, as shown in Figure B.25. Deposits were made by depositing powder into the laser spot or by using pre-placed powders. The laser had a wavelength in the 800-940 nm range. We spent some time discussing the characteristics of diode lasers. Of relevance to laser cladding were the following: greater than 30 percent power efficiency, small size, and a rectangular spot (2 x 5 mm) caused by a lack of coherence among beams (multiple beams are produced by several diodes).



Figure B.24. Diode laser cladding equipment.

Cladding is performed in an inert atmosphere to prevent oxidation of the deposited metals. Cladding materials included P20 and stainless steels, titanium alloys, and nickel-based alloys. Substrate materials were typically carbon or stainless steels. Linear deposition rates of 175 mm/minute were typical. Example deposits are shown from the side and the top in Figure B.26.

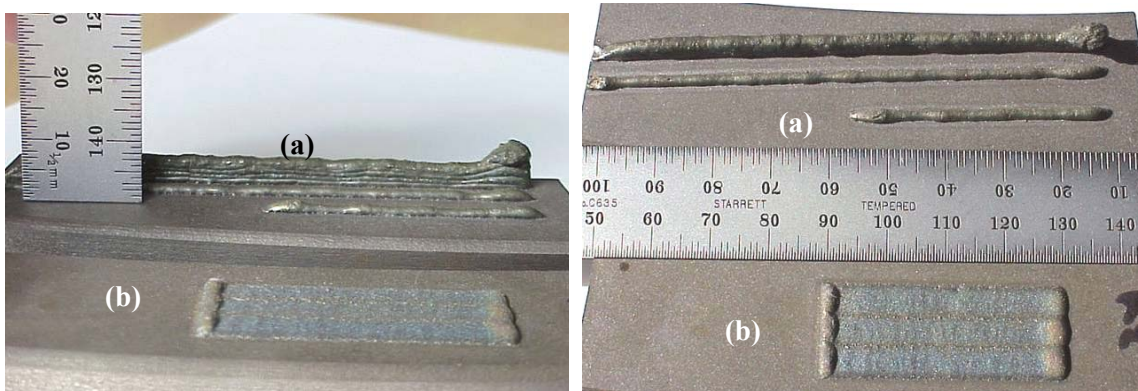

Figure B.25. Nickel-based alloy deposits in (a) fast and (b) slow directions.

Prof. Pashby presented a very nice comparison of CO₂, Nd:YAG, and diode lasers in terms of their energy, cost, size, efficiency, and other characteristics.

The other aspect of this research program was laminated tooling for injection molding, composite forming, and superplastic forming. Laser cutting methods were employed for cutting plates. Typically, the strategy was to increase the accuracy of the tool by using plates of different thicknesses, using thin plates in regions with high surface curvature, or other features. Plates are brazed or clamped together to form the final tool, which is finish-machined. Conformal cooling channels can be cut into the plates to enhance the tool's performance. Figure B.27 shows an example of a laminated tool. For the purposes of the photo, the plates are not shown clamped or brazed so that the construction of the tool is evident. Conformal cooling channels can be seen along the cavity region.

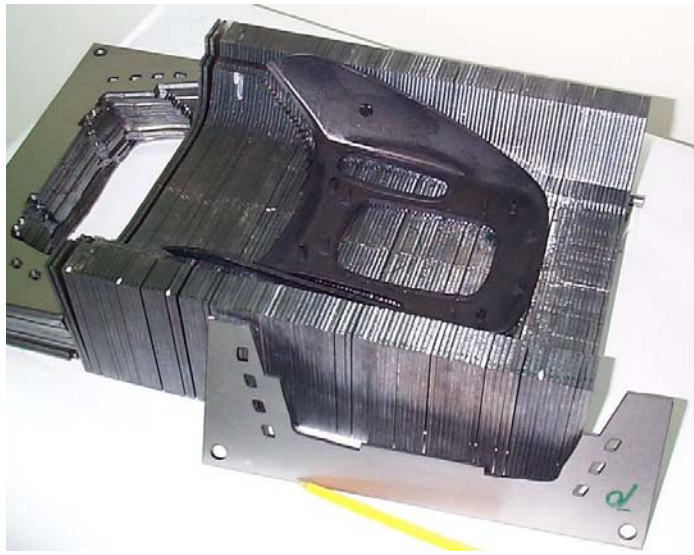

Figure B.26. Example of a laminated tool shown in a partially assembled state.

PARTICLE DEPOSITION PROCESSES

Graham McCartney of the Advanced Materials Group presented his work on particle deposition processes. The challenge, as he saw it, was the rapid production of low volume parts and differentiated products. His work focuses on three areas: (1) cold gas dynamic spraying; (2) high velocity oxy-fuel thermal spraying; and (3) shaped metal deposition.

Cold Spray

In cold gas dynamic spraying, solid powder particles impinge at a high speed on a substrate, undergoing severe plastic deformation upon impact. In cold spray methods, particles are injected into a high velocity gas stream, then accelerated through a specially designed nozzle to reach speeds of mach 1 or faster. After reaching a critical speed, deposition efficiency increases significantly. Since the particles and gas stream are at room temperature, or heated to 200°C, no heat affected zone is created, eliminating many of the problems associated with thermal processing of metals. The group used gas spray to create coatings and to fabricate features.

Deposition with aluminum and titanium was reported. Example deposits are shown in Figure B.28. Helium was the carrier gas that the group typically used for research purposes. Nitrogen could also be used and is preferred for production work since it is less expensive, but it should be heated to 200°C. Very good material densities were reported. They noted that for titanium, the powder choice is critical in order to obtain good results. Typical deposition speeds were 25 mm/sec for aluminum and 50 mm/sec for titanium.

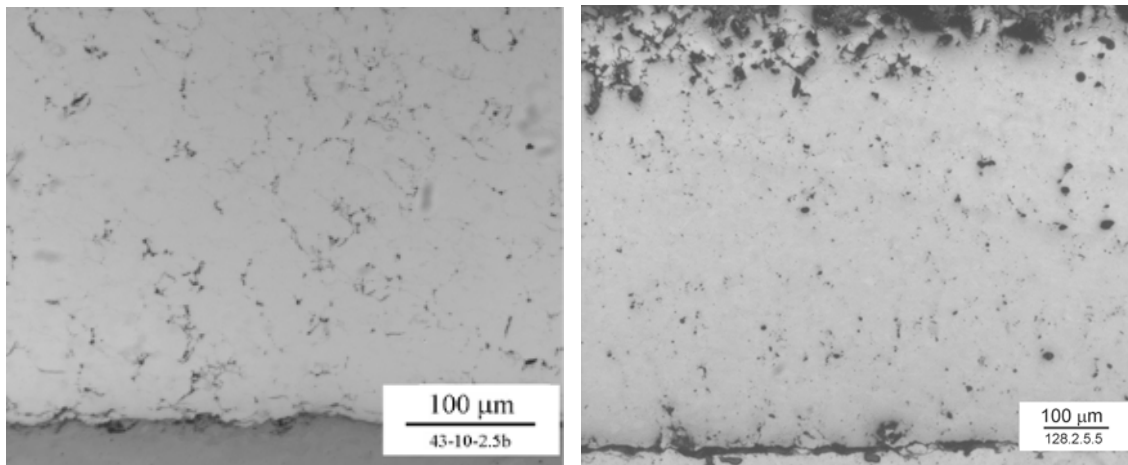

Figure B.27. Examples of (*left*) cold sprayed aluminum and (*right*) titanium.

The challenges remaining to be overcome before cold spray technology will be widely adopted include high cost, material selection, and residual stresses.

Thermal Spraying

The high velocity oxy-fuel (HVOF) thermal spray method was referred to as a novel method for applying high performance coatings. It is typically used to apply abrasion and wear resistant coatings, such as tungsten-carbon-cobalt and aluminum-tin materials. Hydrogen is typically used as the carrier gas and is at a temperature high enough to melt the metal particles.

The main application presented was for applying a lubrication and fatigue resistant coating on journal bearings. Al-Sn was sprayed onto the bearing surface and generated nanoscale tin particles (~50 nm in size) to provide lubrication. The rapid cooling rate allows Al matrix to be highly strengthened. An example journal bearing surface with the sprayed coating is shown on the top in Figure B.29. The bottom image in Figure B.29 shows a high resolution micrograph of the Al-Sn microstructure.

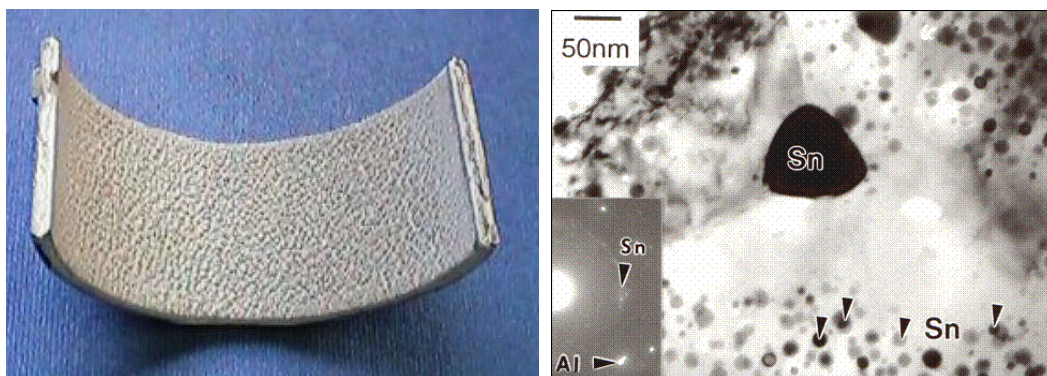

Figure B.28. Thermal spraying example.

Shaped Metal Deposition

This is a robotic welding method for building metallic features. Nottingham personnel acquired a hardware and software system from Rolls Royce to perform shaped metal deposition. From a CAD model of a part (or an STL model), they could generate simulations of robot motions and generate code to drive the robot. Much of the Rolls Royce effort went into developing this integrated software system. Nottingham's emphasis was on extending the technology for non-aerospace applications. A computer model of Nottingham's SMD workcell is shown in Figure B.30.

In order to improve the system, Nottingham personnel were developing a database of processing conditions for a variety of materials. This database would be used for process planning and optimization. Their intent was to perform design of experiments to develop empirical models of process-structure-property relationships for a given material. In parallel, they saw the need to development mechanistic models to explain their observed relationships and to enable prediction of processing conditions for process planning and optimization.

With their integrated information system, materials processing databases could provide process variable values for Nottingham simulation software packages. This enabled Nottingham personnel to process a CAD model of a part, simulate its manufacture, and generate code to drive the robotic welding equipment. Presumably, they will also development the capability to evaluate their processes in terms of microstructure and mechanical properties.

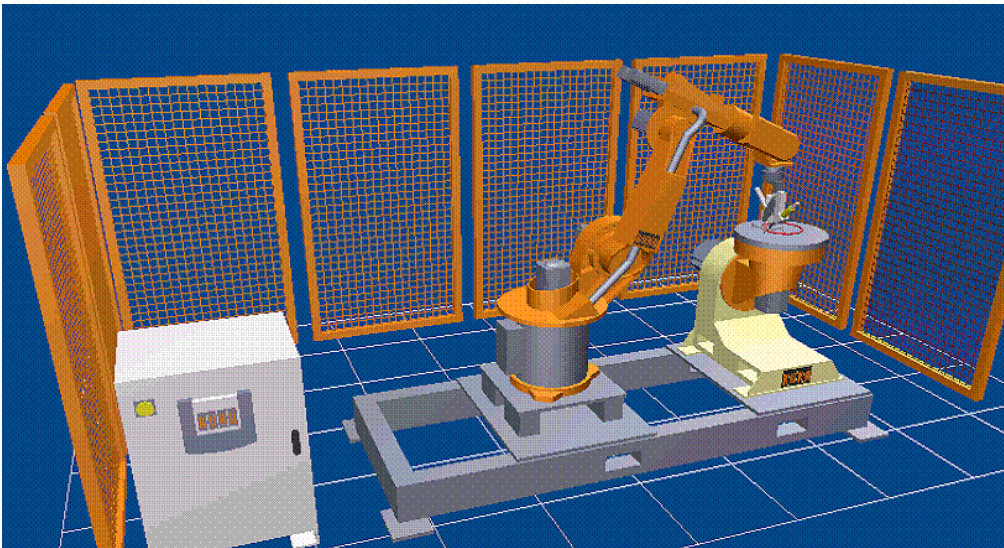

Figure B.29. Shaped metal deposition cell at the University of Nottingham.

RESEARCH AND EDUCATION FACILITIES

A unique aspect of these facilities was the Giddings and Lewis Hexapod machine. The machine had a Stewart platform configuration. It was housed in a 15-meter diameter area and had a 700 mm³ work envelope. (This illustrates one of the disadvantages of hexapod machines, that of poor volume efficiency.) A laser positioning system provided feedback control during cutting.

Overall, the UNIMAT and UTC facilities were extensive and impressive.

CHEMICAL METHODS FOR PRODUCTION OF NOVEL MATERIALS

Trevor Farren presented four projects in the area of novel material production using chemical methods. Three of the projects dealt with novel applications of supercritical fluids, while the third was on self-assembly for production of nanostructured materials.

Supercritical fluids are highly compressed gases with densities similar to those of liquids. Above a critical temperature, gases will not condense to form liquids, regardless of the pressure applied.

One application of supercritical fluids utilized CO₂. When CO₂ is a supercritical fluid, it behaves like a solvent. As a result, environmentally hazardous solvents can be replaced with a benign solvent that simply evaporates (or can be recycled) after removing whatever material is dissolved.

A second application was to transport species, such as drugs, into polymers, so that drug delivery rates can be controlled. Other biological compounds could be used, such as growth factor, hormones, etc. Metal particles can also be used. Dr. Farren presented one application where silver particles were transported into catheters as a method of preventing microbial growth in catheters (bacteria will not grow on silver).

A third application of supercritical fluids was for the production of mixed metal-oxide particles. When water becomes supercritical, it becomes very reactive. This is used to synthesize mixed metal oxides such as CeO₂, Ce:Zr, ZrO₂, and Pr:Ce and produce them in nanoparticle form.

The fourth project that was presented utilized self-assembly to produce nanostructured materials with pores and channels of controlled dimensions and chemical functionality. These were used for storage, transport, and separation applications, such as hydrogen storage. Other materials could be used for environmental cleanup since their structures enabled them to absorb and store other materials (such as oil). Nanotubes and nanoribbons in LiN and BN have also been synthesized, which have several potential applications, including batteries.

APPENDIX C. GLOSSARY

3DP	three-dimensional printing
A/S	Additive/subtractive
ASTM	American Society for Testing and Materials
bio-FET	biologically sensitive field effect transistor
CAD	computer assisted design
CAE	computer assisted engineering
CAM	computer assisted manufacturing
CBE	chemical beam epitaxy
CMB	controlled metal build-up
CMM	coordinate measuring machine
CMOS	complementary metal oxide semiconductor
CNC	computer numerical control
CSG-BRep	constructive solid geometry - boundary representation
CT	computerized tomography
CVD	chemical vapor deposition
CW	continuous-wave (laser)
DFM	Design for Manufacturability
DMD	Direct Metal Deposition
DMLS	Direct Metal Laser Sintering
DOD	drop-on-demand (ink jet process)
DSC	differential scanning calorimetry
DXF (or .dxf)	CAD files that define contour lines, i.e., points, polylines and polygons
EBM	electron beam melting
EFAB	electrochemical fabrication
EOS	Electrical Optical Systems, a major selective laser sintering machine manufacturer
EPSRC	Engineering and Physical Sciences Research Council (U.K.)
EUV	extreme ultraviolet
FDM	fused deposition modeling

FEA	finite element analysis
FF	free form
GI	glass ionomer
HA	hydroxyapatite
HAZ	heat affected zone (in laser cladding processes)
HIP	hot isostatic processing
HSC machining	high-speed cutting
HVOF	high velocity oxy-fuel
ISO	International Standards Organization
LAM	laser additive manufacturing
LENS	Laser Engineered Net Shaping (Trademark, Sandia National Laboratories and Sandia Corporation)
LIGA	deep reactive ion etching (a German term, Lithographie, Galvanoformung, und Abformung, that is, X-ray lithography with electrodeposition of metal and sometimes injection molding)
LOM	laminated object manufacturing
LWG	leaky waveguide (laser diode)
MAPLE DW	matrix-assisted pulsed-laser deposition direct-write (process used to rapidly fabricate various non-rechargeable and chargeable batteries)
MBE	molecular beam epitaxy
FF	freeform fabrication
MIM powder	Metal Injection Molding powder
MJS	multiphase jet solidification
MOS	metal oxide semiconductor
MPD	metal powder deposition
MTT test	standard using MTT (a tetrazolium salt), which is only active in metabolically intact cells, to measure cell proliferation and viability
NC	numerical control
P/M	powder metallurgy
PDA	personal data assistant
PEM	proton exchange membrane
PLGA	polylactic-polyglycolic acid copolymer

PLT	pocket laser tachometer
RFID	radio-frequency identity
RM	rapid manufacturing
RP	rapid prototyping
RP&M	rapid prototyping and manufacturing
SFF	solid free-form fabrication
SLA	stereolithography
SMA	shape-memory alloy
SLM	selective laser melting
SLS	selective laser sintering
SMD	shaped metal deposition
SMEs	small and medium enterprises
STEP	STandard for the Exchange of Product model data
STL files	stereolithography computer files
Tekes	Finland's National Technology Agency
UC	ultrasonic consolidation
YAG laser	yttrium aluminum garnet