

Aptima[®]
Human - Centered Engineering

www.aptime.com

A New Methodology for Design and Evaluation of Heterarchical Structures

Georgiy M. Levchuk¹

Feili Yu²

Yuri Levchuk¹

Krishna R. Pattipati²

¹Aptima, Inc.

²University of Connecticut

9-th CCRTS

San Diego, CA, June, 2004

Track 1: C2 Modeling and Simulation

© 2004, Aptima, Inc.

A UNIQUE FOCUS ON HUMAN-CENTERED ENGINEERING

Report Documentation Page

Form Approved
OMB No. 0704-0188

Public reporting burden for the collection of information is estimated to average 1 hour per response, including the time for reviewing instructions, searching existing data sources, gathering and maintaining the data needed, and completing and reviewing the collection of information. Send comments regarding this burden estimate or any other aspect of this collection of information, including suggestions for reducing this burden, to Washington Headquarters Services, Directorate for Information Operations and Reports, 1215 Jefferson Davis Highway, Suite 1204, Arlington VA 22202-4302. Respondents should be aware that notwithstanding any other provision of law, no person shall be subject to a penalty for failing to comply with a collection of information if it does not display a currently valid OMB control number.

1. REPORT DATE JUN 2004		2. REPORT TYPE		3. DATES COVERED 00-00-2004 to 00-00-2004	
4. TITLE AND SUBTITLE A New Methodology for Design and Evaluation of Heterarchical Structures (Briefing Charts)				5a. CONTRACT NUMBER	
				5b. GRANT NUMBER	
				5c. PROGRAM ELEMENT NUMBER	
6. AUTHOR(S)				5d. PROJECT NUMBER	
				5e. TASK NUMBER	
				5f. WORK UNIT NUMBER	
7. PERFORMING ORGANIZATION NAME(S) AND ADDRESS(ES) Aptima Inc,12 Gill Street,Woburn,MA,01801				8. PERFORMING ORGANIZATION REPORT NUMBER	
9. SPONSORING/MONITORING AGENCY NAME(S) AND ADDRESS(ES)				10. SPONSOR/MONITOR'S ACRONYM(S)	
				11. SPONSOR/MONITOR'S REPORT NUMBER(S)	
12. DISTRIBUTION/AVAILABILITY STATEMENT Approved for public release; distribution unlimited					
13. SUPPLEMENTARY NOTES The original document contains color images.					
14. ABSTRACT					
15. SUBJECT TERMS					
16. SECURITY CLASSIFICATION OF:			17. LIMITATION OF ABSTRACT	18. NUMBER OF PAGES 26	19a. NAME OF RESPONSIBLE PERSON
a. REPORT unclassified	b. ABSTRACT unclassified	c. THIS PAGE unclassified			

Basic Notions

- Mission
 - Events, activities, tasks to be executed
- Organization
 - Agents
 - ◆ Limited workload capacity
 - ◆ Heterogeneity in effectiveness of observation, command, information fusion, task execution
 - Structure
 - ◆ Access to and *transfer* of **resources**
 - ◆ Access to and *transfer* of **information**
 - ◆ *Generation* and *transfer* of **command**
 - ◆ Structures have **capacity** constraints
 - Strategy
 - ◆ Observation (who sees what)
 - ◆ Information routing and fusion (who communicates to whom)
 - ◆ Command execution and transfer (who commands whom)
 - ◆ Task allocation and execution (who executes what)
 - Resources

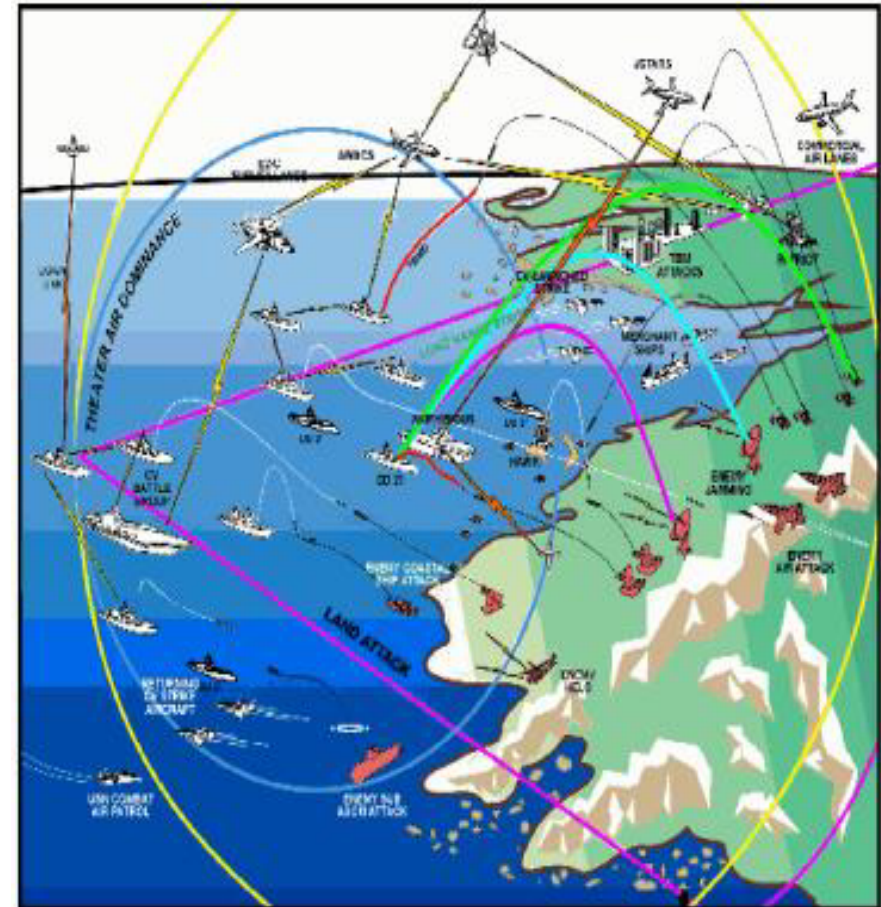

Formalization

- What problem are we addressing?
 - Design of organizational structures / networks and strategies
- What is the **structure/network** in our context?
 - Collection of items and rules/constraints of their interactions
 - Collection of nodes, links, channels
- What is the **strategy**?
 - Policy/procedures/rules/guidance to execute a mission
- What is an **issue**?
 - Interactions between mission, structure, and strategy

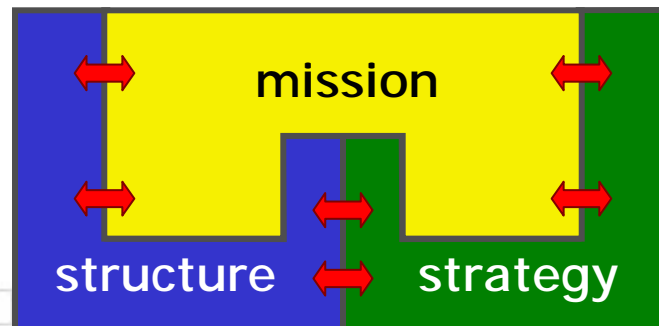
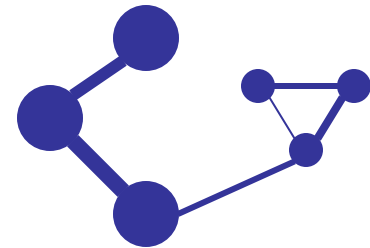
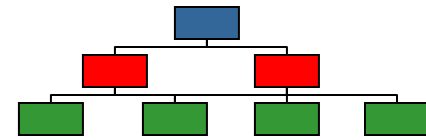

- Why study heterarchies?
- Types of Structures and Design Challenges
- Research evolution
- Problem identification & constraints
- Process chain
- Agent process graph
- Multi-layer network structure
- Solution approach
- Simulation examples

Why Study Heterarchies?

- New technologies – additional **friendly** flexibility to exploit (FORCEnet concept)
- Need to study the **enemy** (e.g., **terrorist networks**)
- Need to study the **environment** (e.g., customer networks, social interactive environments, supply-demand chains, “informal” relationships within hierarchies)
- Heterarchical relationships are “**richer**”, and contain principles and mechanisms that have potential to render *superior performance*
- Thus need to study these relationships in order to:
 - determine how to **influence** other organizations
 - see if concomitant design principles can be **imbedded** into control structures of organizations to *enhance performance*

Types of Structures

Command

Execution ordering

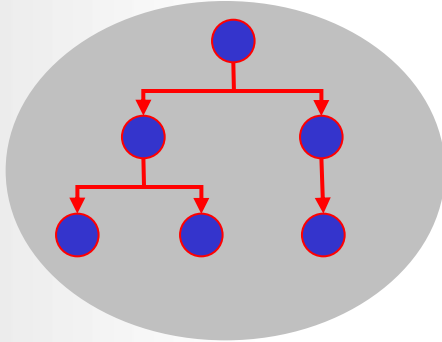

send
commands

Control

Execution capabilities

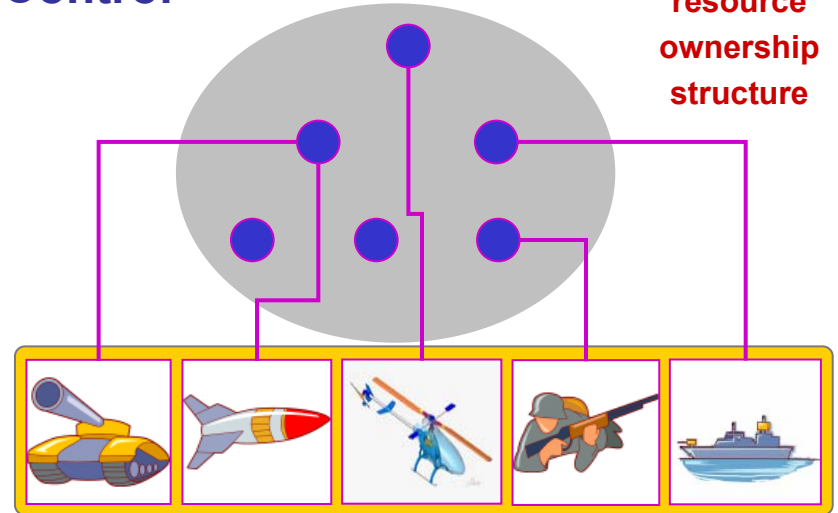

resource
ownership
structure

Communication

Info propagation

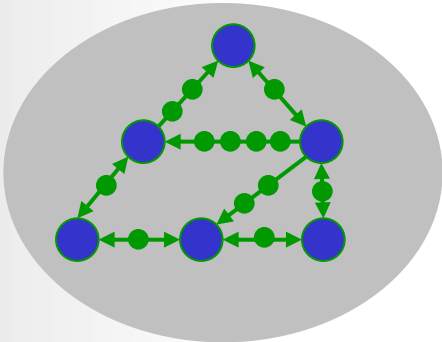

send
information

Information

Knowledge/SA

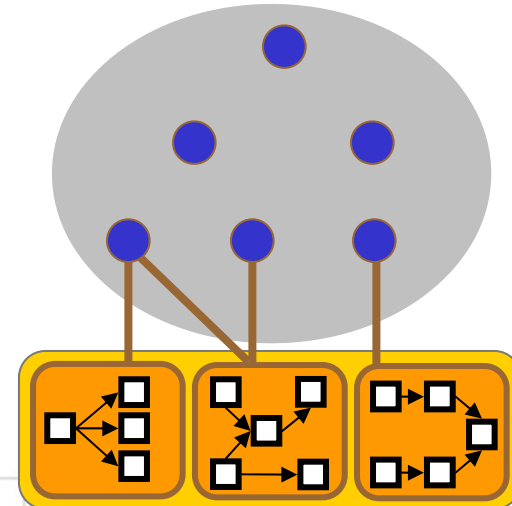

info/event
access
structure

Design Challenges

Challenge 1: Identification of interactions between agents

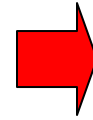

- Use template interaction message library
- Use rule-based reasoning in synthetic environment

Challenge 2: Interaction constraints and agent effectiveness

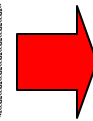

- Study restrictions in information access and flow, workload capacity, processing speed, command flow, etc.
- Study feasibility of structures in military domain

Challenge 3: Complexity & influence of (sub)structures and strategies on each other

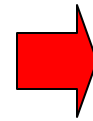

- Model how flow is treated in the organization (transfer, consumption, generation, etc.)
- Inter- and intra-agent networks

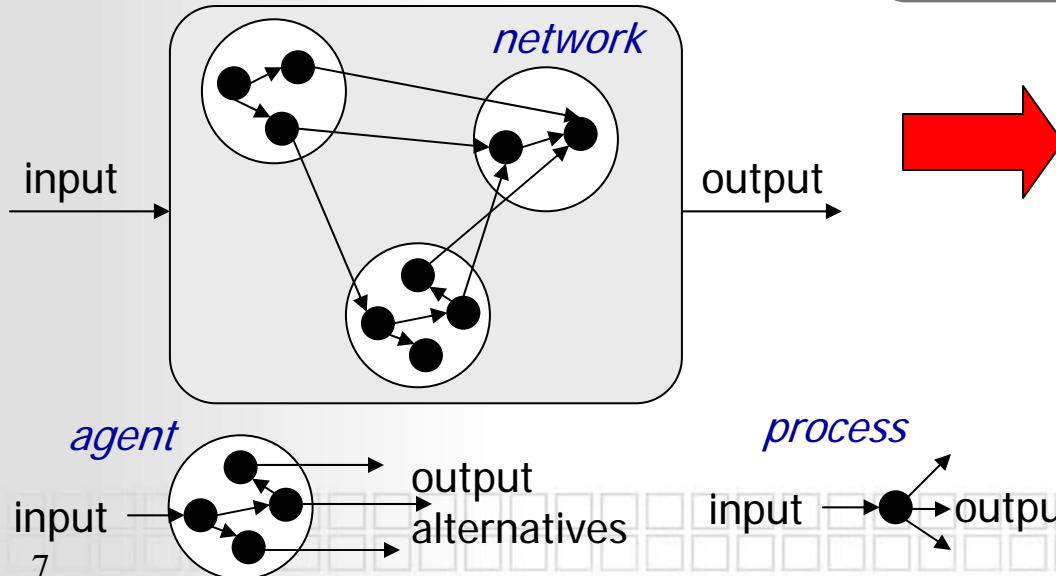

Modeling approaches:

- Use flow model: cost and capacity constraints
- Non-linear function of cost for flow transfer links
- Multi-commodity & non-splittable flow modeling
- Heuristic algorithms to maintain network robustness
- Local / distributed decision making

Research Evolution

Overhead-based design

- Given: **communication requirements**
- Find: a **hierarchy**
- Objective: minimize **communication overhead**
 - Based on exceptions to process, decision-making workload, and load of information transfer

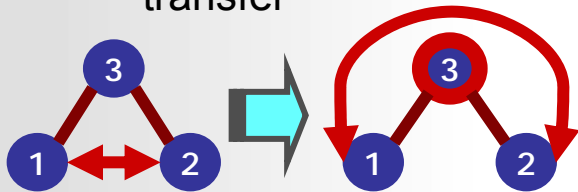

Cons:

- No **effect** of overhead
- No network constraints

Schedule-based design

- Given: **agent network**
- Find: a **task assignment** and **schedule**
- Objective: minimize **mission time**
 - Based task information flow and inter-agent communication

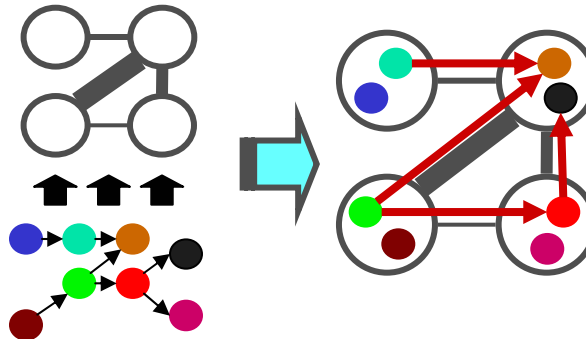

Cons:

- Global controller
- No network design
- Limited routing; no info split

Routing-based design

- Given: **communication requirements**
- Find: a **network** and **info routing**
- Objective: minimize **average delay**
 - Based on information routing & queuing model

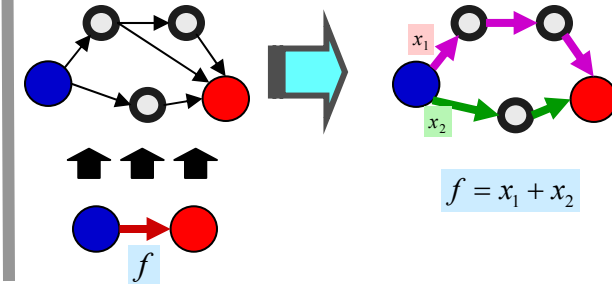

Cons:

- No strategy (assignment)-structure allocation
- No multi-structure design

Design Evolution

What is Missing?

- Strategy-structure-mission interaction/influence
- **Strategy:** how and what is done
- **Structure:** by what means a strategy is accomplished
- **Mission:** what needs to be accomplished

Problem Identification

- Agents
 - Observe events
 - Receive/transfer/fuse info
 - Generate/receive/transfer command
 - Receive/transfer/process tasks
- Links/Channels
 - Transfer information
 - Direct command
 - Access observations
- Model agent operations as flow processing
 - Flow of information, command orders, resources, requests for synchronization, exceptions, etc.

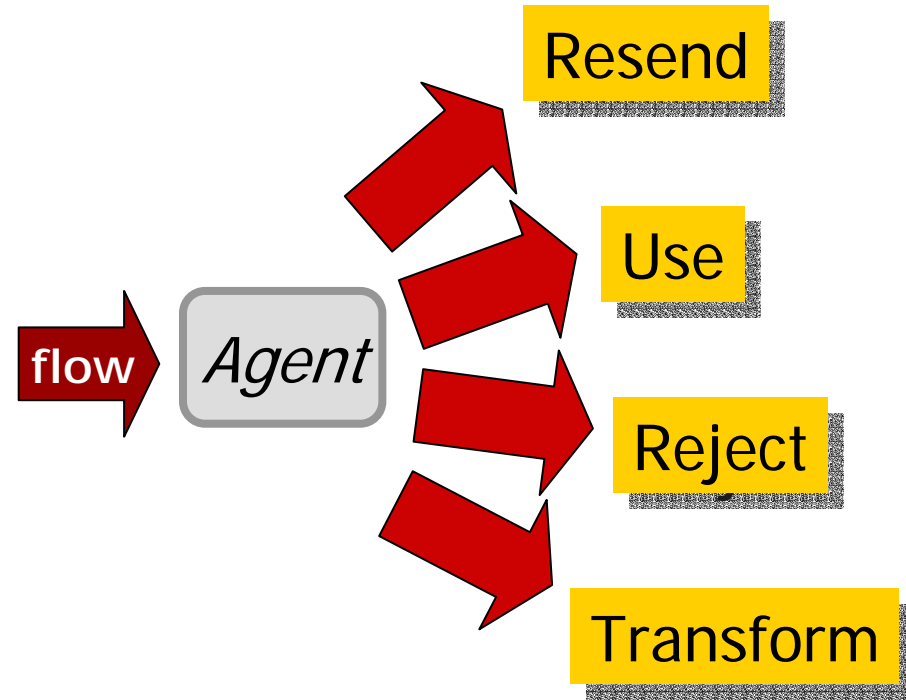

What Are We Doing?

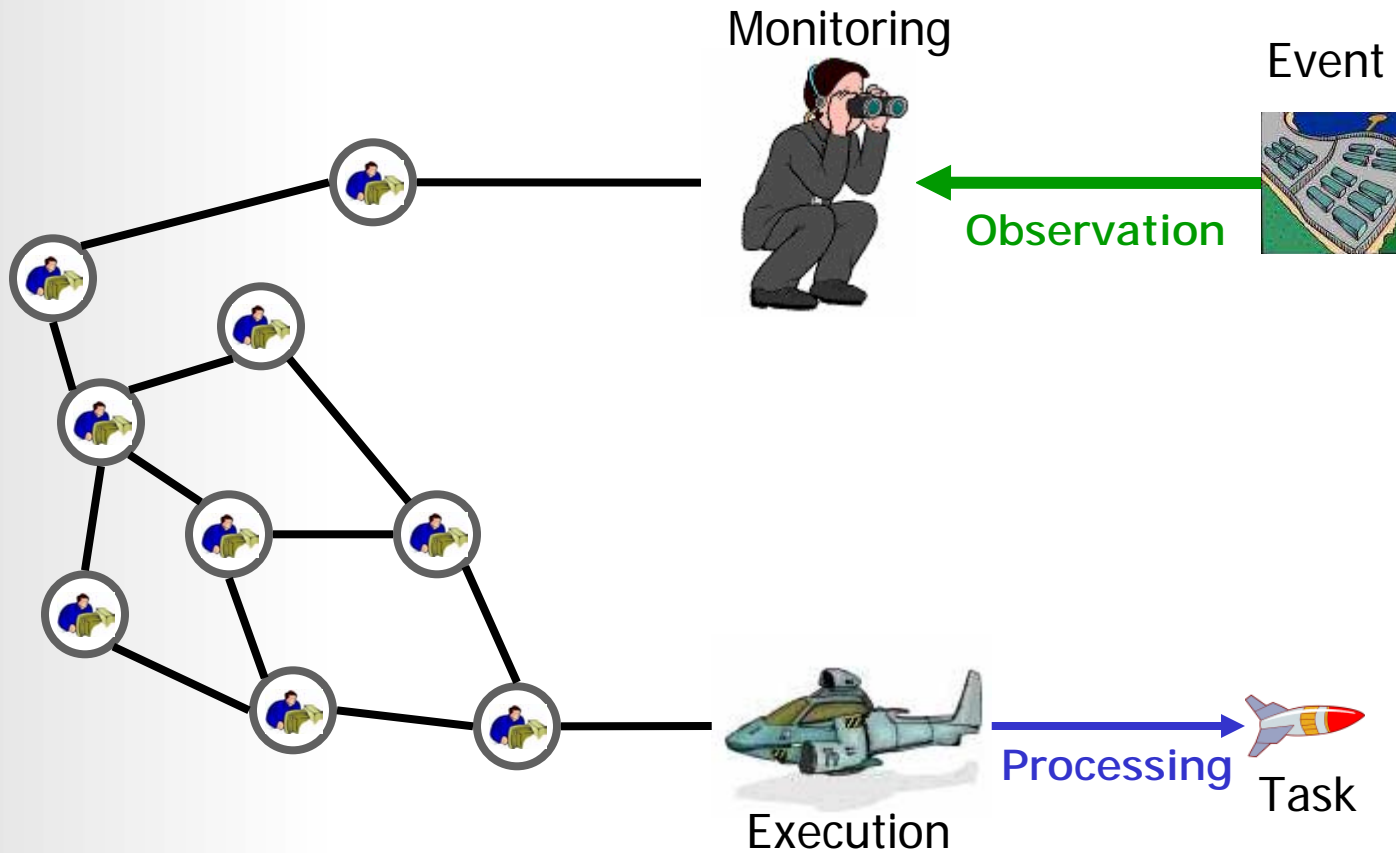

Getting the Right Info to Right People

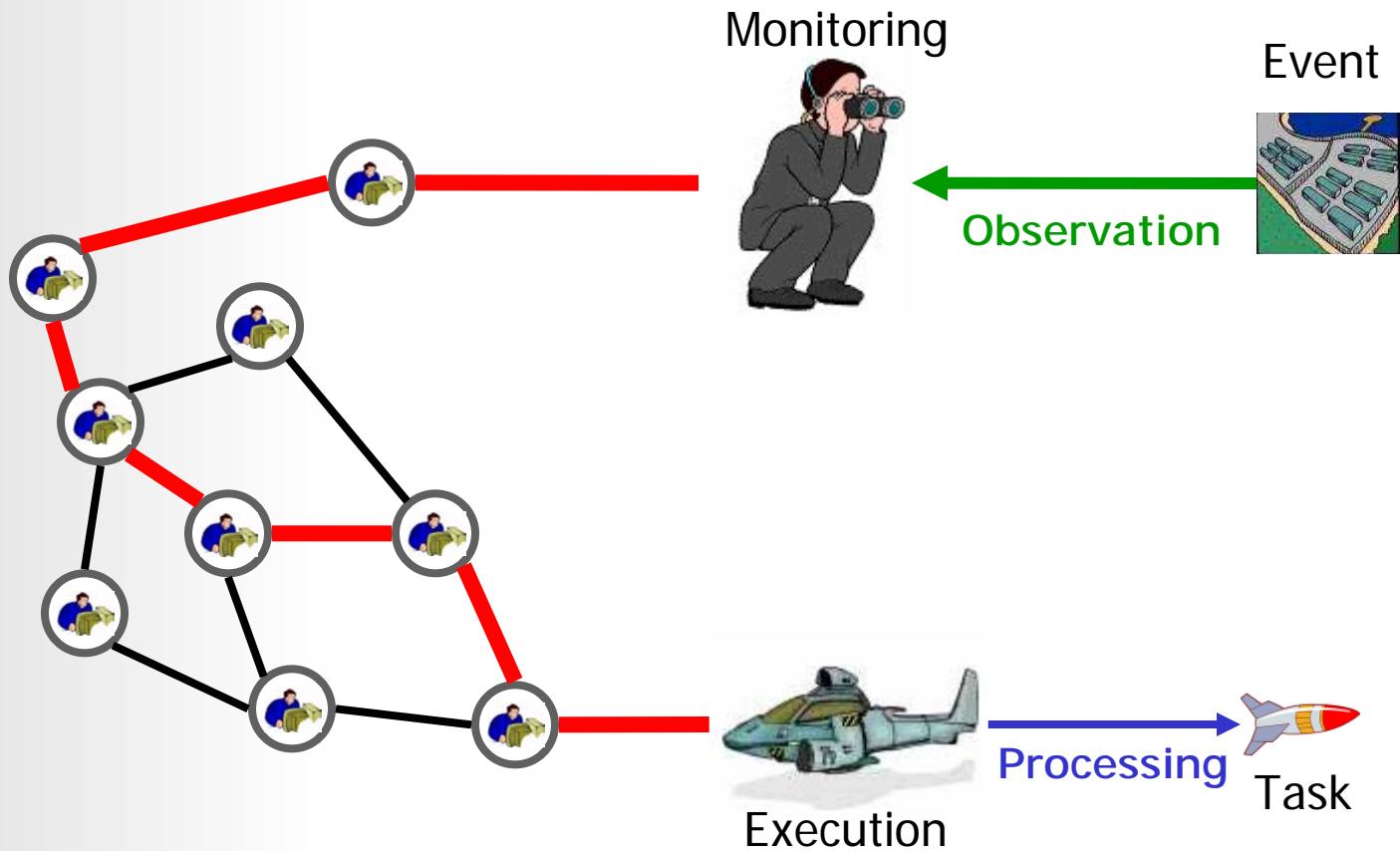

Direct Info Access

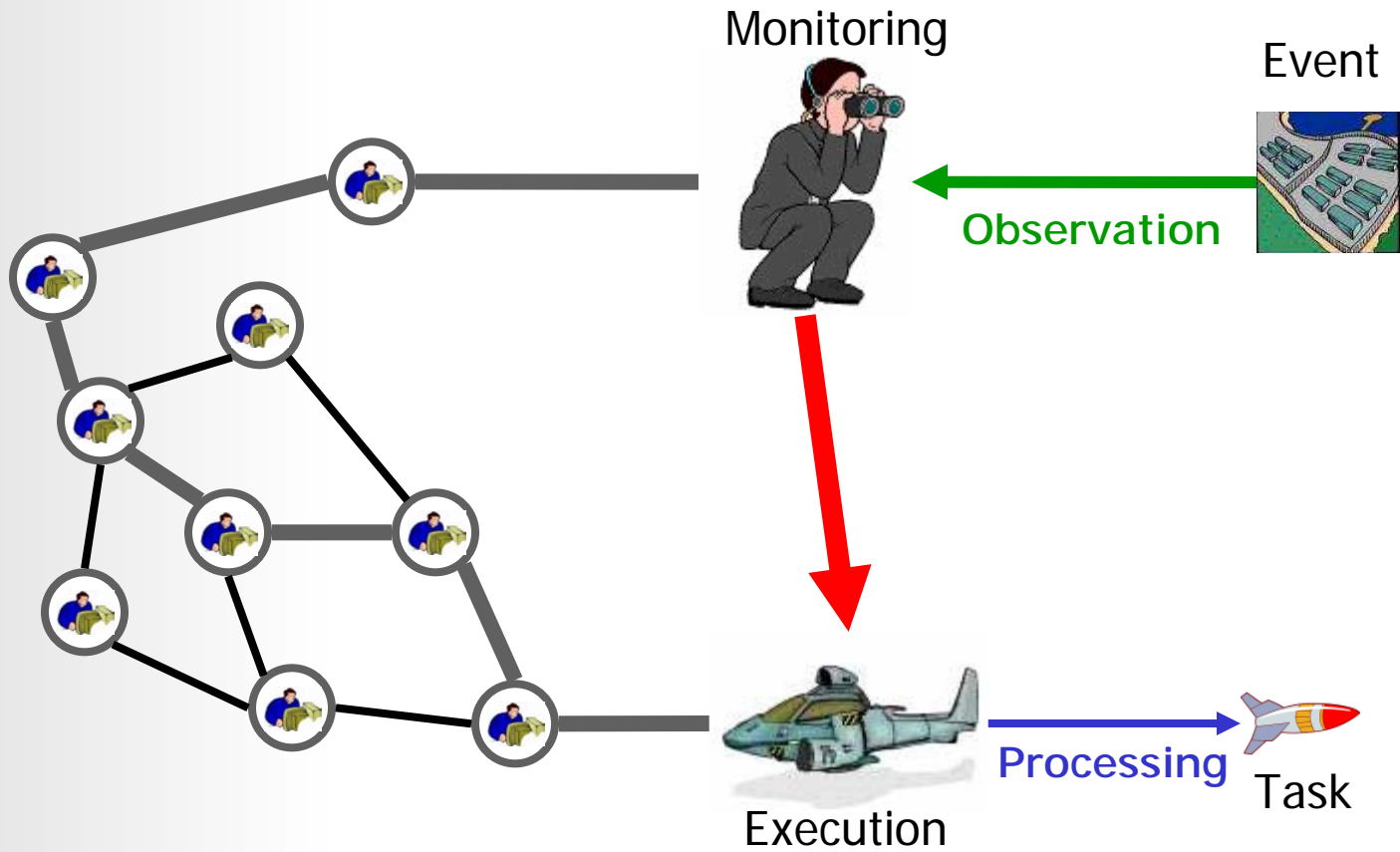

Info Conflict

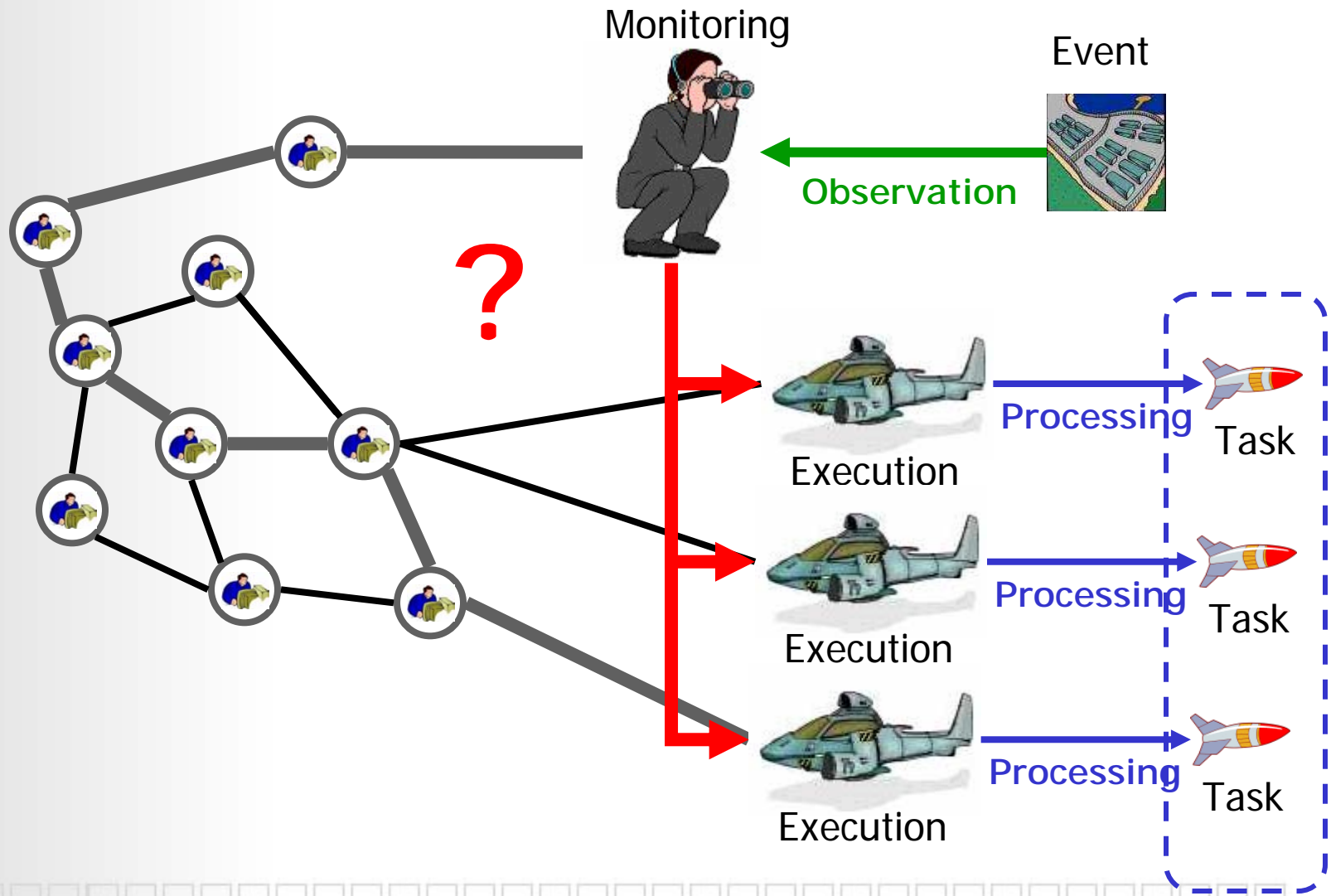

Command as a Resolution

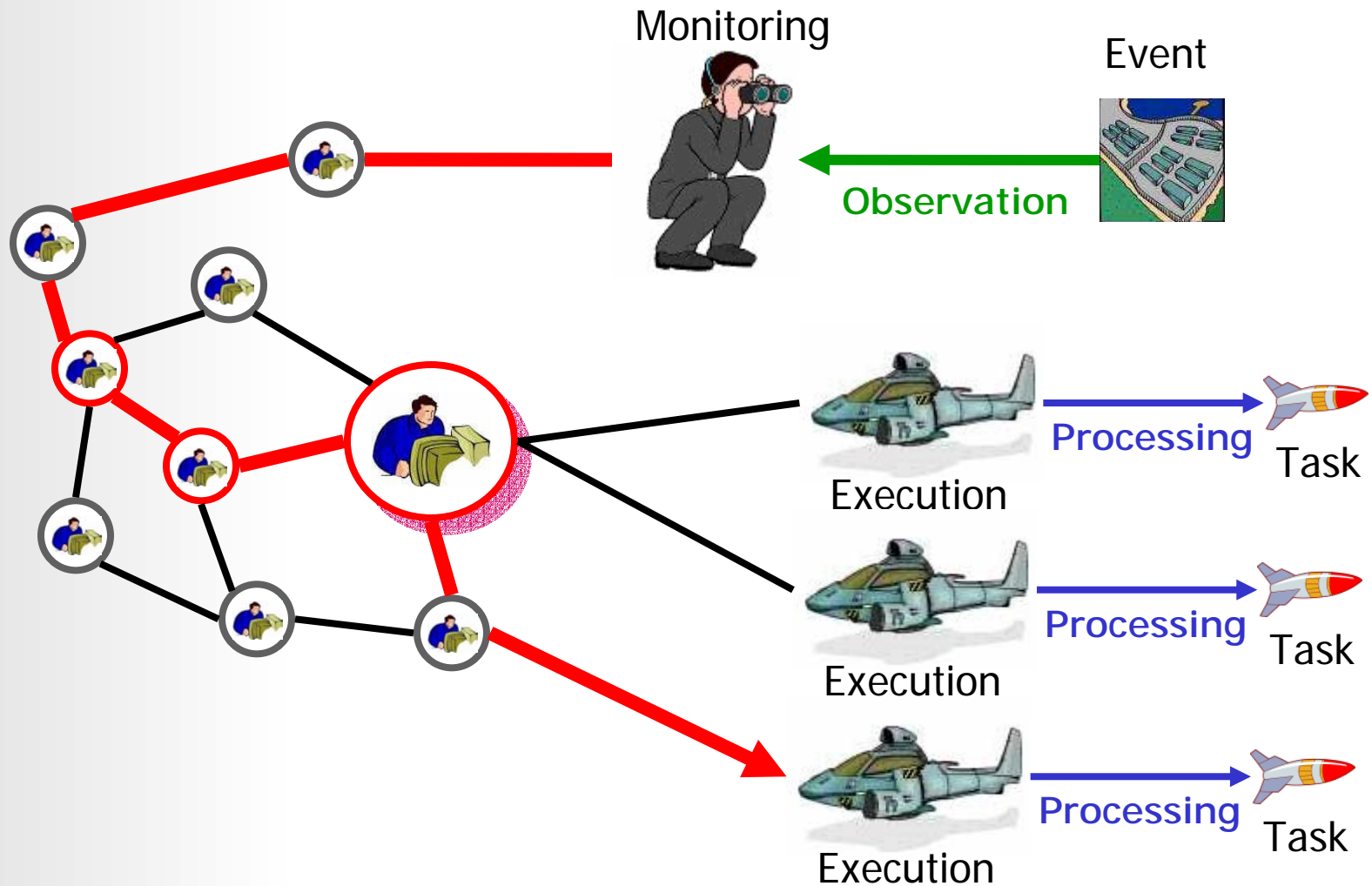

- Agents:
 - Workload capacity
 - ◆ Limit amount of operational and cognitive load
 - ◆ Include load of observations, communication, decision-making, task execution
 - Operation efficiency
 - ◆ Different expertise for observation, command, task processing, transfer
 - ◆ Based on agent expertise
 - Multiple types of expertise assessed; grading each
 - Multi-type expertise capability ⇒ generalists
 - Single-type expertise capability ⇒ specialists
- Links/channels:
 - Cost of maintenance
 - Use simple linear function of flow amount

Problem Specifics

Flow chain:



splitting allowed

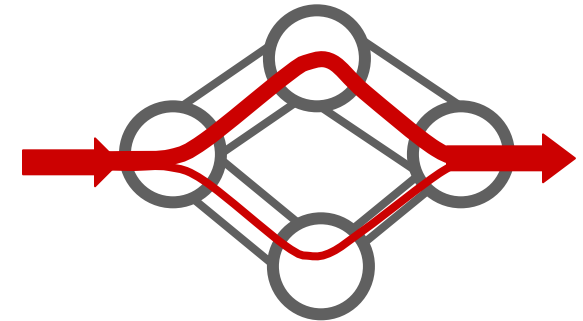

Agent process graph:

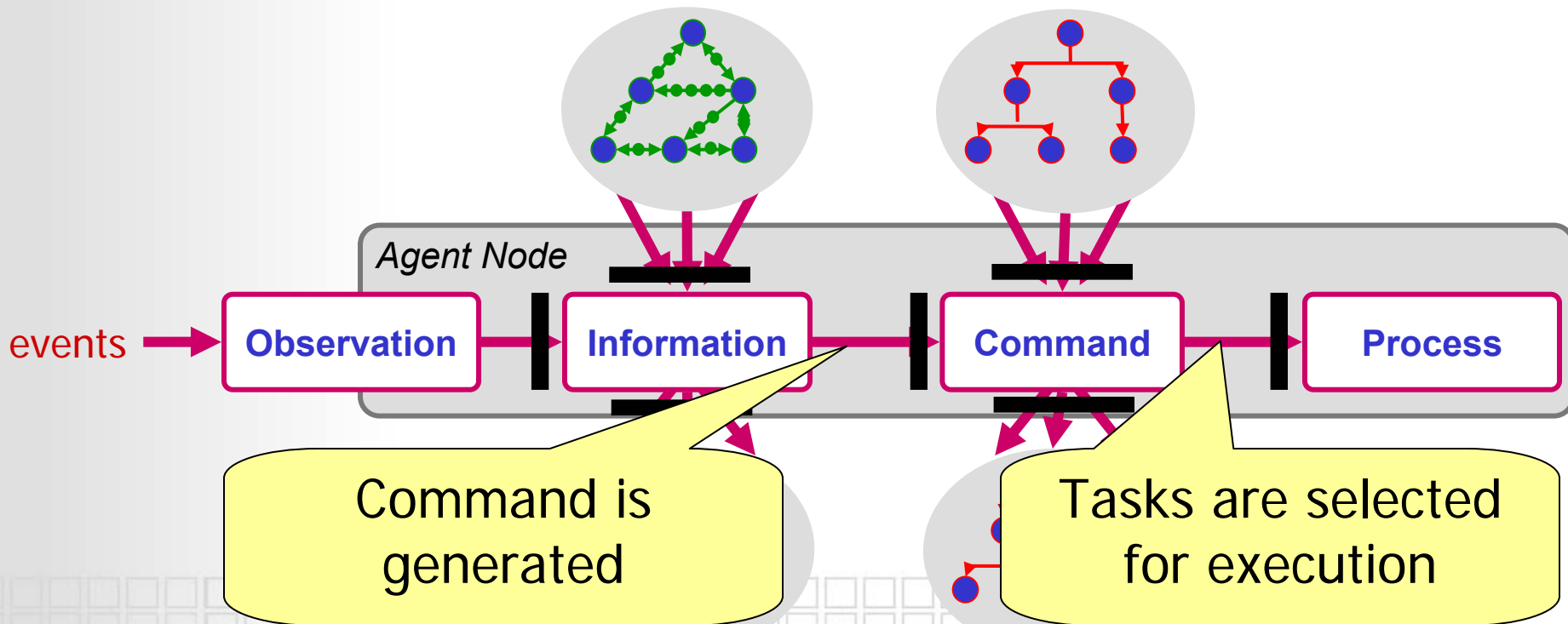

■ Capacity

- Identifies the threshold of volume
- At agent process nodes & links: agents constraints
- At links/channels: structure constraints

■ Mission Gain

- **Positive – task execution gain:** from the efficiency/accuracy of agents to observe, conduct decision making, execute tasks, communicate
- **Negative – transfer cost:** info/tasking through network
 - ◆ Network maintenance
 - ◆ Information loss
 - ◆ Interpretation loss
 - ◆ Noisy transmission

Joint Graph

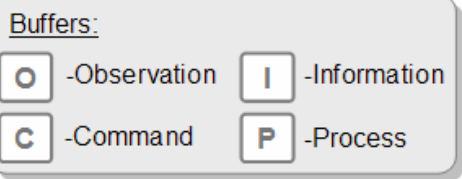
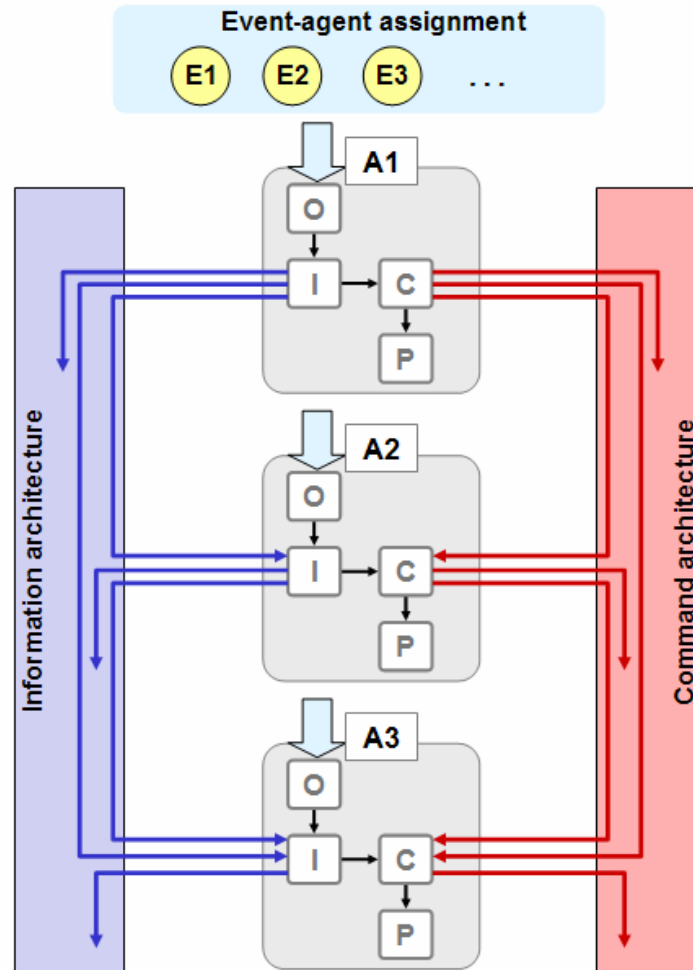

Example of Hybrid Structure

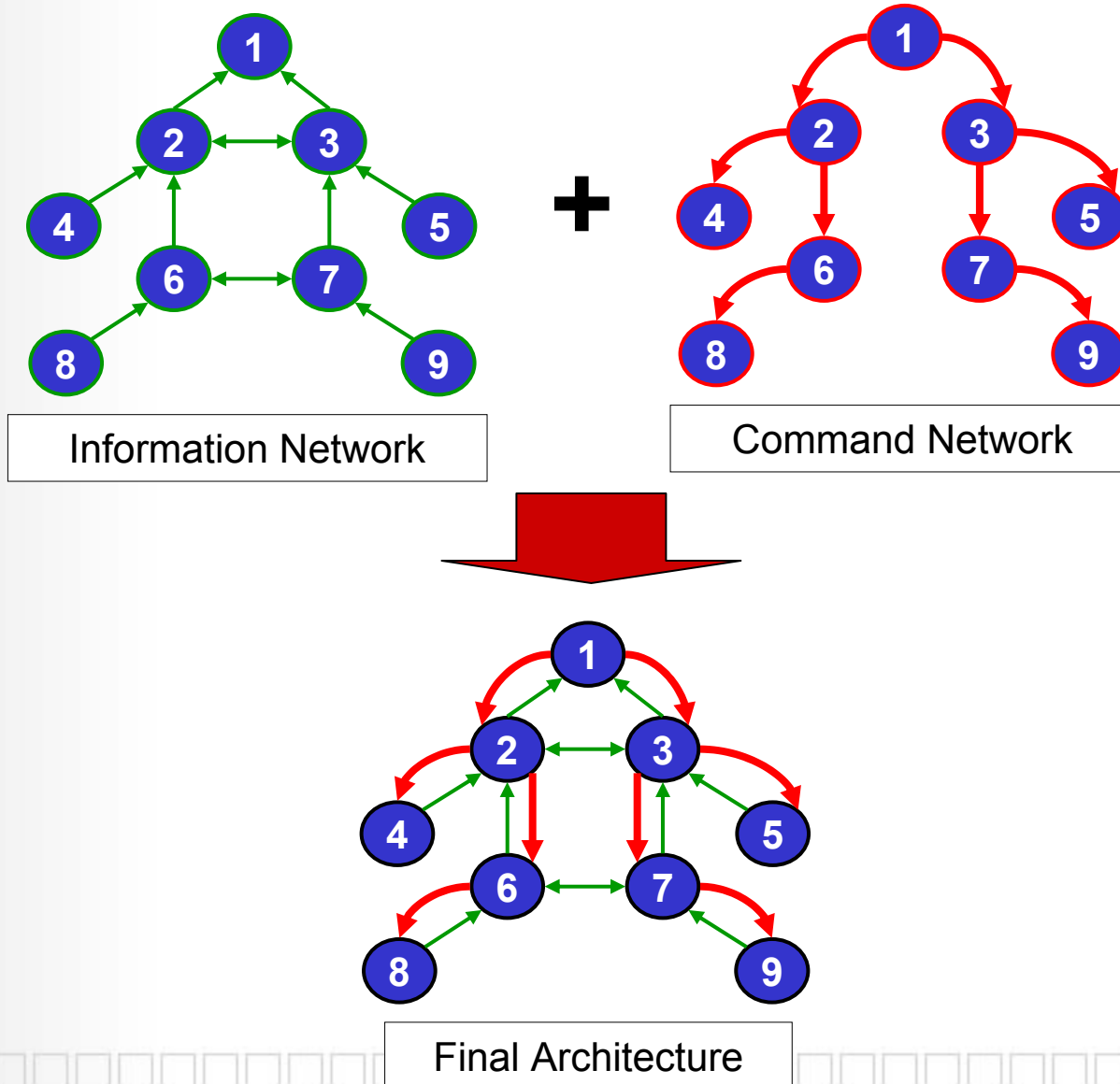

Multi-Layer Organization

Event is observed

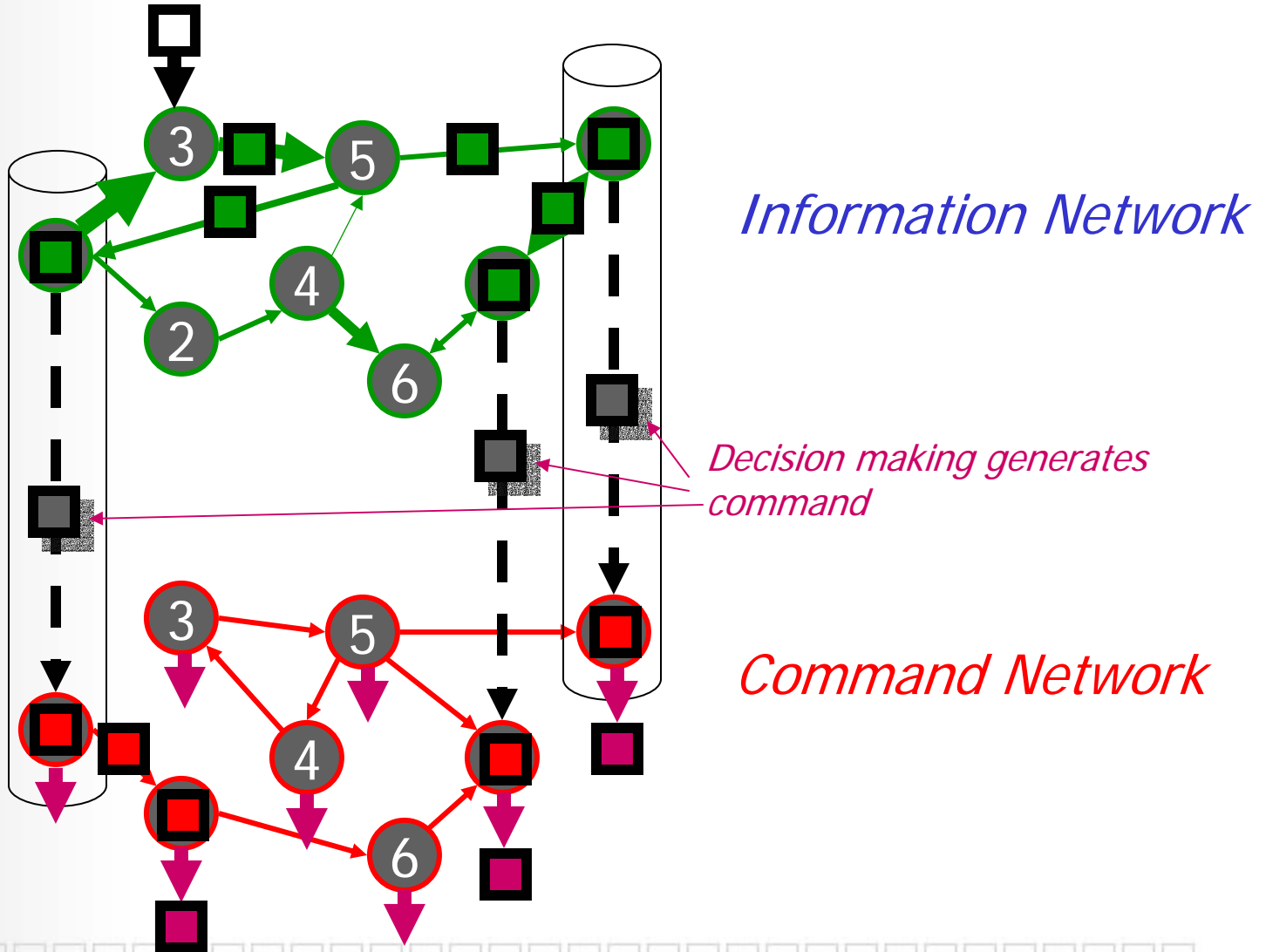

Solution Approach

- **Step 1:** Define mission
 - Events volume and expertise requirements
- **Step 2:** Define organization
 - Agent expertise
- **Step 3:** Define agents' process graphs
 - Agent capacities, processing gain
- **Step 4:** Define structure constraints
 - Link/channel capacities for different-type networks
- **Step 5:** Expand the aggregate network
 - Replace node capacity and gain constraints with link capacities and cost
- **Step 6:** Apply minimum cost maximum flow algorithm

- **Structure:** specification of load for sub-networks
 - Can use to design network bandwidth and architecture
- **Strategy:** specification of who does what
 - Observation, fusion, communication, transfer, execution

Sample Results

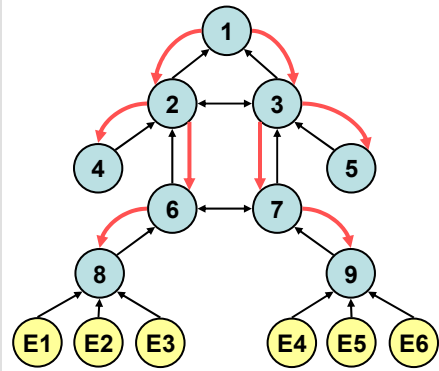

Structure A

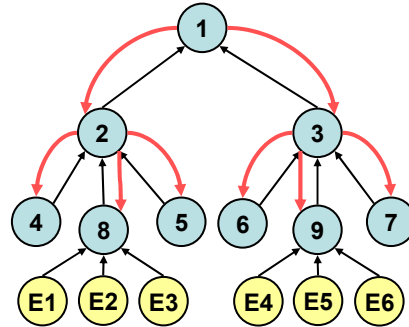

Structure B

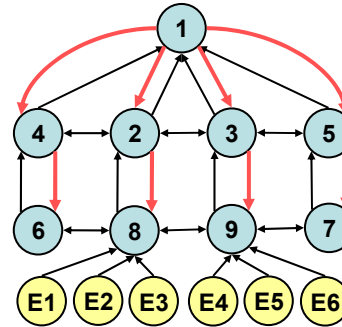

Structure C

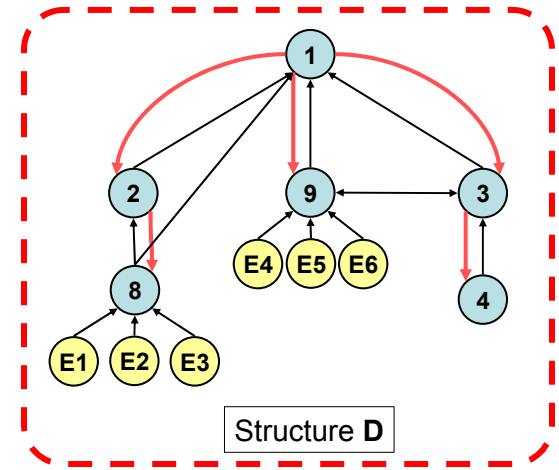

Structure D

● - Agent node
● - Event/observation node
→ - Command network
→ - Information network

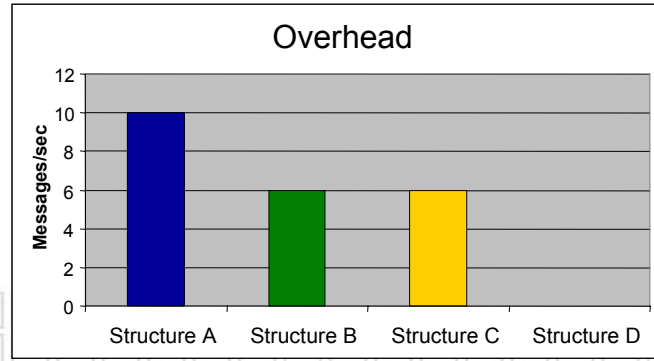
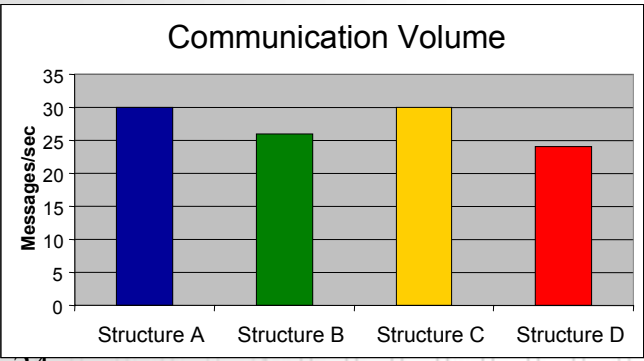
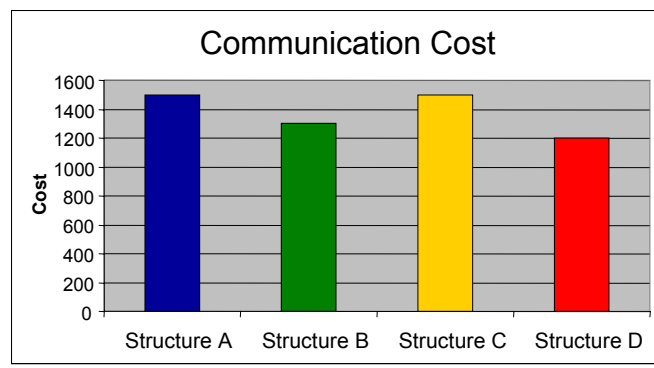
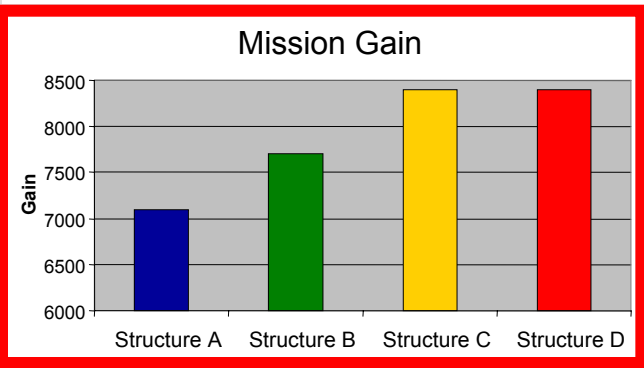

- Increase the accumulated mission execution effectiveness (gain) while decreasing the communication overhead, cost and volume
- **Optimal network allows better access to efficient nodes**

Future Directions

- Consider network robustness constraints
- Implement **multi-commodity** problem formulation
 - Currently we implemented single-type events
- Consider problem of **unsplittable** or partially splittable flows
 - An item can only be transferred through **single path**, without splitting
- Consider flow **transfer** and generation
 - Flow volume change
- Consider error propagation
- Consider local autonomous agent strategy based on partial information

Accomplishments:

- Developed methodology to design inter-dependent organizational sub-structures (command, observation, communication, information)
- Utilize the benefits and constraints of hierarchical, heterarchical, and hybrid structures
- Integrated structure-strategy optimization

Applications:

- Will provide innovative strategy and structure solutions for various levels and nodes of the FORCEnet