

**10th International Command and Control Research and Technology Symposium
The Future of C2
Human Factors Engineering Track**

**MANPOWER AND PERSONNEL SUPPORT FOR THE C4ISR IN THE
TRANSFORMED DIVISION**

**B. Wayne Anderson
U.S. Army Research Laboratory**

**POC:
B. Wayne Anderson
U.S. Army Research Laboratory
Human Research and Engineering Directorate
CECOM Field Element
ATTN: AMSRD-ARL-HR-ML
Fort Monmouth, New Jersey 07703
732-532-0028
FAX: 732-427-3184
E-mail: wanders@arl.army.mil**

Report Documentation Page

*Form Approved
OMB No. 0704-0188*

Public reporting burden for the collection of information is estimated to average 1 hour per response, including the time for reviewing instructions, searching existing data sources, gathering and maintaining the data needed, and completing and reviewing the collection of information. Send comments regarding this burden estimate or any other aspect of this collection of information, including suggestions for reducing this burden, to Washington Headquarters Services, Directorate for Information Operations and Reports, 1215 Jefferson Davis Highway, Suite 1204, Arlington VA 22202-4302. Respondents should be aware that notwithstanding any other provision of law, no person shall be subject to a penalty for failing to comply with a collection of information if it does not display a currently valid OMB control number.

1. REPORT DATE JUN 2005	2. REPORT TYPE	3. DATES COVERED 00-00-2005 to 00-00-2005			
4. TITLE AND SUBTITLE Manpower and Personnel Support for the C4ISR in the Transformed Division		5a. CONTRACT NUMBER			
		5b. GRANT NUMBER			
		5c. PROGRAM ELEMENT NUMBER			
6. AUTHOR(S)		5d. PROJECT NUMBER			
		5e. TASK NUMBER			
		5f. WORK UNIT NUMBER			
7. PERFORMING ORGANIZATION NAME(S) AND ADDRESS(ES) Army Research Laboratory, Human Research and Engineering Directorate, ATTN: AMSRD-ARL-HR-ML, Fort Monmouth, NJ, 07703		8. PERFORMING ORGANIZATION REPORT NUMBER			
9. SPONSORING/MONITORING AGENCY NAME(S) AND ADDRESS(ES)		10. SPONSOR/MONITOR'S ACRONYM(S)			
		11. SPONSOR/MONITOR'S REPORT NUMBER(S)			
12. DISTRIBUTION/AVAILABILITY STATEMENT Approved for public release; distribution unlimited					
13. SUPPLEMENTARY NOTES The original document contains color images.					
14. ABSTRACT					
15. SUBJECT TERMS					
16. SECURITY CLASSIFICATION OF:			17. LIMITATION OF ABSTRACT	18. NUMBER OF PAGES 30	19a. NAME OF RESPONSIBLE PERSON
a. REPORT unclassified	b. ABSTRACT unclassified	c. THIS PAGE unclassified			

MANPOWER AND PERSONNEL SUPPORT FOR THE C4ISR IN THE TRANSFORMED DIVISION

B. Wayne Anderson

U.S. Army Research Laboratory
Human Research and Engineering Directorate
CECOM Field Element
ATTN: AMSRD-ARL-HR-ML
Fort Monmouth, New Jersey 07703

Abstract

The U.S. Army has created three interrelated initiatives that together impact support for Command, Control, Communications, Computers, Intelligence, Surveillance, and Reconnaissance (C4ISR). First is Digitization—the process of increasing the combat multiplier effect by a more capable C4ISR network. Second is Modularization—the Army’s transformation of its warfighting organization from brigade and division into a Unit of Action and Unit of Employment structure to increase fielding flexibility and effectiveness. Third is the Army’s “tail to tooth” reduction program, which has effectively decreased Signal Corps personnel. These initiatives induced the Signal Corps to change its C4ISR support, thus making it necessary to evaluate the new Signal Corps supporting warfighting operations. When the Army fielded the Stryker Brigade Combat Team (SBCT), the Army Research Laboratory (ARL) conducted an analysis to determine if adequate signal personnel were in place. Those results indicated additional personnel were required in the SBCT. ARL reexamined this issue in light of the current transformation of the Third Infantry Division (3rd ID). The findings show that the 3rd ID has increased or shifted signal personnel levels that were of concern in the SBCT. Although some C4ISR support issues remain, the 3rd ID’s new signal personnel levels appear to be appropriate.

INTRODUCTION

In recent years, the U.S. Army began transforming its warfighting capabilities from the older brigade and division forces into the Unit of Action (UA) and Unit of Employment (UE) structure. The purpose of this modularization was for the Army to be more strategically responsive and to be better able to meet the full spectrum of operations

encountered in current world affairs (Shinseki, 1999). The Third Infantry Division (3rd ID) was the first Army division to be restructured into a “modular” division. The reorganization took the 3rd ID from seven brigades, three for maneuver and four support brigades—aviation, engineering, artillery and logistics—to a new structure consisting of four maneuver brigade combat teams (BCTs) UAs and an aviation UA. The artillery, engineers, and logistics subordinate units were reorganized into battalions integrated within the BCTs (Mazzucchi & Rider, 2004).

At the same time, the Army continued its digitization to field an increasingly electronic Command, Control, Communications, Computers, Intelligence, Surveillance, and Reconnaissance (C4ISR) to enhance the fighting capability of the force. This C4ISR system is a network of communications, computer, sensor, and surveillance systems designed to provide needed battlefield information more quickly to the leadership at each echelon (Mazzucchi, 2003). The architecture includes satellite and airborne communication networks, as well as more traditional ground radio networks (Klynsma & Scott, 2001). The Fourth Infantry Division (4th ID) led the way with increased C4ISR capabilities, followed by the Stryker Brigade Combat Team (SBCT). The 3rd ID followed suit at the time of its reorganization with an electronic C4ISR suite called the Joint Network Transport Capability (JNTC) whose major focus was the delivery of the Joint Network Node (JNN), an intermediate system to the Army’s objective system, the Warfighter Information Network-Tactical (WIN-T).

These two initiatives, that is, the Army organizational modularization transformation and digitization, have altered C4ISR maintenance requirements. Increasing reliance upon an electronic architecture requires increasing maintenance support by organic signal personnel for the continued functioning of the C4ISR. In addition, these effects are at odds with the Army's attempt to reduce the number of support personnel and their associated costs which cut Signal Corps personnel by more than half (Enlisted Notes, 1998). As a result, the structure of the Signal Corps support to the division has substantially changed.

When the Army fielded the SBCT, the Army Research Laboratory (ARL) conducted an analysis requested by the Army Test and Evaluation Command (ATEC) to determine if the types (Military Occupational Specialties, MOSs) and numbers of support personnel were adequate to maintain the C4ISR. Those results, based on data from the SBCT-1 (3rd Brigade/2nd ID [3/2 ID]), indicated that additional personnel were required in the support structure (Anderson & Garfinkel, 2004). Specifically, the manpower needed to be increased for Information Systems Operator-Analysts (MOS 74B) predominantly located at the Brigade Headquarters (main) and the Brigade Support Battalion (rear). The study also concluded that manpower levels for electronics repair personnel and communications security (COMSEC) personnel (MOS 74C) needed to be increased for brigade operations and that consideration should be given to assigning repair personnel within the Combat Repair Teams. Field reports from the Signal Company of the SBCT-1 in Iraq confirmed some of those findings, with specific mention of the need for additional personnel in the COMSEC cell (Fischer, 2004).

With the restructure to UA/UE, the problem of support to the C4ISR for warfighting operations in the new organizational structure have resurfaced. Therefore, in conjunction with its JNTC evaluation, ATEC requested that ARL update its Stryker

C4ISR support study to evaluate the required Signal Corps personnel levels resulting from the transformation of the 3rd ID.

EVALUATING THE C4ISR SUPPORT PERSONNEL FOR THE 3RD ID

This evaluation was conducted by comparing the Signal Corp personnel strengths of the 3rd ID with that of two other combat units, the SBCT and the 4th ID. These organizations were chosen for comparison because of the similarities in the architecture of their C4ISR. The 3rd ID migrated to its electronic C4ISR during the fielding of the JNTC which occurred in conjunction with its restructure to the UA/UE concept late in 2004. Although the organizations chosen show similarities, there were also limitations in the evaluation based on the differences in the organizations. The 4th ID is the Army's First Digital Division, and it is a heavy infantry unit, division sized, in that sense similar to the 3rd ID. One limitation of the comparison to the 4th ID is that at the time it became a digital division, many of the older legacy communications systems were still required and had to be utilized, so signal manpower levels were affected based on a combination of the older and newer systems. The SBCT, with a newer C4ISR system made extensive use of the latest systems available at the time it was fielded, but it is only a brigade-sized medium-weight force, and does not have the support requirements of a division.

		MOSs		ANALYSES		
		MOSs in Each Category	New MOS Designations* and New MOSs	Overall MTOE signal personnel comparison	SBCT/UA signal personnel comparison	Electronic equipment/repairer analysis
CATEGORIES OF SIGNAL PERSONNEL	Officers/WOs/NCOs	25A, 53A, 250N, 251A, 254A, 31W, 31Z, 74Z	25A, 53A, 250N, 251A, 254A, 948B, 25W, 25X, 25Y, 94W	X	X	
	Information Systems and Networking	74B	25B	X	X	
	Plans and Communications Security	74C	25D	X	X	
	Signal Support	31U	25U	X	X	
	Signal Communications Systems	31C, 31F, 31L, 31R, 31S	25F, 25L, 25P, 25Q, 25S	X	X	
	Communications and Electronics Repair	35E, 35F, 35J, 31F, 31P	94E, 94F	X	X	X

* The new MOS designations are a result of the Army's realignment of MOS codes which for the MOS 31- and 74-series occurred as of FY 05 and for the MOS 35-series will occur in FY 06.

Table 1. Categories of signal personnel evaluated with the old and new MOS designations and the analyses used for each category in this evaluation. The X's indicate the type of analysis used to evaluate each of the categories of personnel.

The C4ISR support and maintenance activities are conducted predominantly by signal personnel organic to the organization. The signal personnel manpower strengths and personnel types were evaluated within the organizations to determine if sufficient personnel had been assigned to the 3rd ID to maintain its C4ISR networks and equipment. The evaluation was conducted by comparing the personnel and equipment as listed in the Modification Tables of Organization and Equipment (MTOE) structure (DOA, 2004; DOA, 2000; FORSCOM, 2001).

For the purpose of this evaluation, the signal personnel were separated into six categories: (1) signal officers, warrant officers (WOs), and non-commissioned officers (NCOs); (2) information systems and networking personnel who maintain computing systems and networks; (3) communications security (COMSEC) and planning personnel; (4) communication support personnel; (5) signal communications systems operators and maintainers for the major systems such as the Joint Network Node (JNN), Enhanced Position Location Reporting System (EPLRS) Net Control Station, and various tactical satellite systems; and (6) communications-electronics repair personnel. Table 1 shows the categories of the signal personnel and the MOSs represented within each category.

Three comparative analyses were used to evaluate the manpower and personnel levels in support of the C4ISR function: (1) a comparison of the C4ISR signal support personnel of the 3rd ID in its new UA/UE configuration with that of the 4th ID, yet to be restructured, and with the SBCT; (2) a comparison of the 3rd ID UA signal personnel directly with the signal personnel of an SBCT; and (3) a comparison of electronic equipment per repairer in the 3rd ID and the other two organizations. These various analyses are also shown in Table 1.

ANALYSIS RESULTS

Comparison of the 3rd ID Signal Personnel with the 4th ID and the SBCT

In order to compare the signal personnel strengths of the 3rd ID with that of the 4th ID and the SBCT, the assigned strengths obtained from the MTOEs had to be normalized. The three organizations compared in this evaluation were very different in overall manpower strength so the data were normalized to one standard. Since the 3rd ID was the organization being evaluated, it was used as the standard, and the manpower strengths of the 4th ID and the SBCT were calculated based on the size of the 3rd ID.

Signal personnel serve in a support capacity to the rest of the organization, therefore the number of personnel to be served by each signal corps individual was calculated for each organization and that number was divided into the total number of serviced personnel from the 3rd ID. This calculation yielded the number of signal personnel needed to support an organization the size of the 3rd ID based on the signal personnel staffing levels of the other two organizations.

The 3rd ID was the largest of the three organizations with 20,503 personnel, followed by the 4th ID with 13,719 personnel. (This analysis included only the combat organization and excluded the ceremonial companies, the unit bands.) The SBCT was the smallest, since it was a brigade sized unit, with 3,154 personnel, using a two infantry battalion brigade. Overall the percentage of signal personnel to supported personnel was 8.8% for the 4th ID, 5.7% for the SBCT, and 6.1% for the 3rd ID. Figure 1 shows the

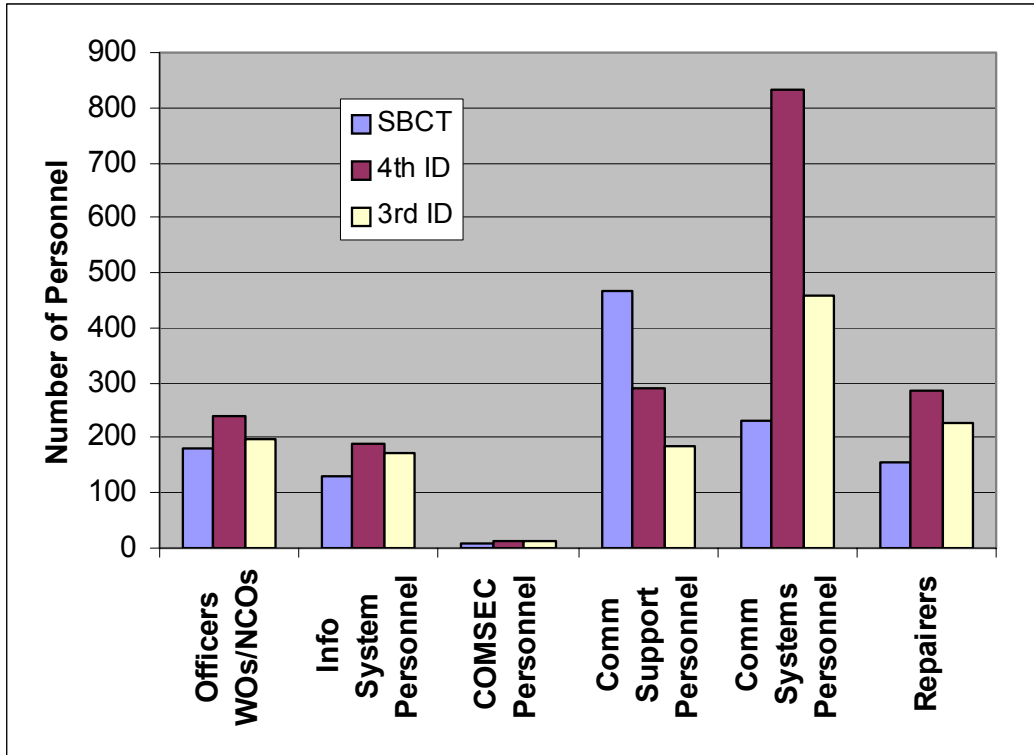

Figure 1. Signal personnel by categories for the SBCT, the 4th ID and the 3rd ID. (The numbers of personnel are normalized for the total personnel strength of the 3rd ID.)

number of personnel for each of the categories of signal support. It should be noted that because of normalization to the 3rd ID sized unit the numbers of personnel in the 4th ID and SBCT were not actual signal personnel strengths. As can be seen for the overall UE, that is, the 3rd ID, the number of personnel was smaller for every category of signal personnel in the 4th ID except the planning/COMSEC personnel which was about same. The biggest difference in personnel was the communications systems personnel with a reduction of 45%. The other reductions in personnel were smaller ranging from 8% to 37% reduction. On the other hand the 3rd ID, when compared to the SBCT, had an increase in numbers for all categories, except one, namely the communications support

PERCENTAGE DIFFERENCES						
	Officers WOs/NCOs	Info System Personnel	COMSEC Personnel	Comm Support Personnel	Comm Systems Personnel	Repairers
SBCT	10%	33%	101%	-61%	97%	45%
4ID	-18%	-8%	6%	-37%	-45%	-21%

Table 2. Percentage differences between the signal personnel by each category of personnel type for the 3rd ID compared to the other organizations.

personnel (MOS 31/25U) with a reduction of 61%. Table 2 shows the percentage differences in the 3rd ID from the other organizations.

Comparison of 3rd ID UA with the SBCT

A comparison of the brigade sized organization was done to identify the signal support differences between the 3rd ID at the UA echelon and the SBCT. For this portion of the analysis, the UA-4 was compared to an SBCT with two infantry battalions. These units, although not equal in size, were approximately equivalent in unit structure. Each had a Headquarters (HQ); a Signal Company, which in the UA was within the Brigade Troop Battalion (BTB); a Reconnaissance Surveillance Target Acquisition (RSTA)/Cavalry Squadron (SQDN); two maneuver battalions each; a Field Artillery (FA)/Strike Battalion; and a Brigade Support Battalion (BSB)/UA Support Battalion. The SBCT had 3,154 personnel overall while the UA-4 had 3,818 personnel. The difference in personnel strength is accounted for in the support battalion, which in the UA, had a total of 1,055 personnel compared to the 382 in the BSB of the SBCT. Taking this difference into account, the UA and the SBCT would be approximately equal in size, so these units were compared directly.

Comparing the two brigade sized units described above, the total signal personnel for the UA was 182 to 181 for the SBCT. As can be seen from Figure 2, the tendency was to increase the signal personnel in four of the personnel categories. These were within the information systems personnel, the planning-COMSEC personnel, signal systems personnel, and the repairers. Decreases occurred for the staff personnel, the officers,

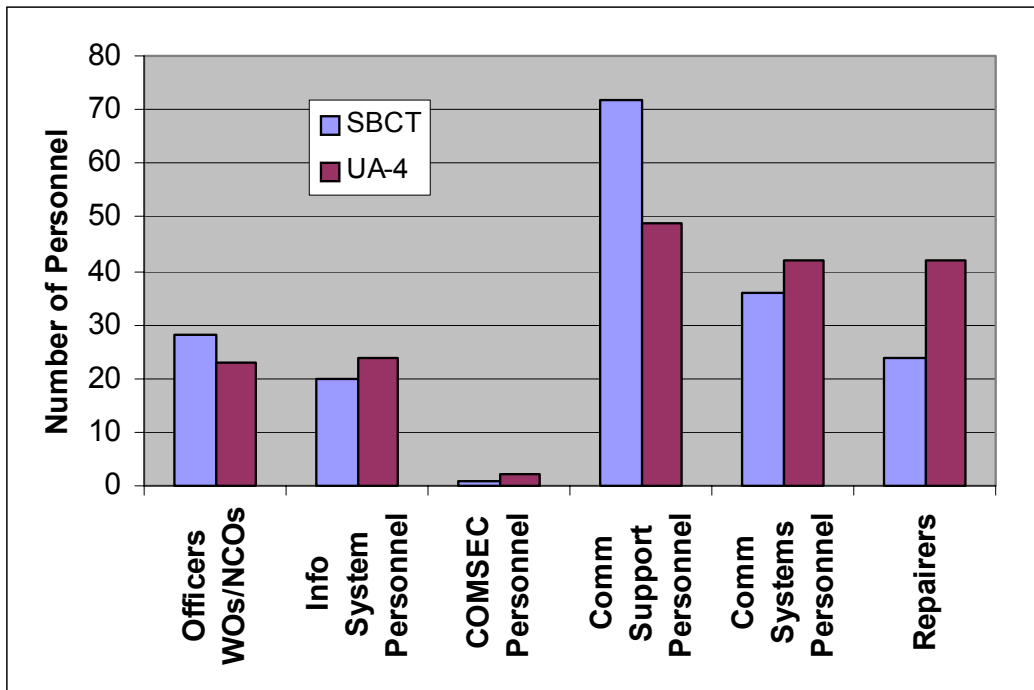

Figure 2. Signal personnel by categories for the SBCT and the 3rd ID UA-4. This comparison shows approximately equivalent sized brigade/UA sized organizations with two maneuver battalions.

SBCT/UA Subunits	Info System Personnel	
	SBCT	UA
HQ (main)	0	4
Signal Co/BTB	6	7
RSTA/Cavalry SQDN	3	3
Maneuver BN	3	2
Maneuver BN	3	2
FA/Strike BN	3	2
BSB/Support BN (rear)	2	4

Table 3. The number of information system personnel assigned to each of the subunits of a SBCT with two Maneuver Battalions (BN) and the 3rd ID UA-4. Column 1 shows the approximately equivalent subunit for each organization.

WOs, and NCOs category, and among the communications support personnel. For these communications support personnel (MOS 31/25U) there was a significant decrease reducing these personnel by 32%, that is, 23 people. Almost half of that difference was the retransmission team which dropped from the SBCT's 30 personnel to 19 for the UA. Also a larger number of personnel in MOS 31/25U were designated as repair personnel for the UA than were designated as repair personnel in the SBCT, an increase from 12 in the SBCT to 22 in the UA. Overall, repair personnel increased to 42 repairers in the UA compared to 24 in the SBCT.

The number of information systems personnel (MOS 74/25B) increased slightly in the UA. These were redistributed from the maneuver battalions to support the headquarters (brigade main) and the Support Battalion (brigade rear). Table 3 shows the distribution of these personnel by subunit for the SBCT and the UA. As can be seen, the headquarters and support battalion had gains. Brigade Headquarters went from zero to four personnel and the Support Battalion went from two to four personnel. This change though was not without a loss for this MOS at the maneuver and strike battalions which lost one information systems person each.

Comparison of Electronic Equipment per Repairer

For this analysis, a calculation was made of the numbers of electronic equipment for which each repairer was responsible. The numbers of electronic equipment identified in the MTOEs was divided by the number of repairers available to repair that equipment. This provided a measure of the potential workload of the repairers. Among the signal personnel, there tends to be considerable overlap between maintainers and repairers, but for the purpose of this analysis, the C4ISR equipment repairers included information systems personnel (MOS 74/25B) and communications support personnel (MOS 31/25U) specifically designated as repairers by the MTOE in addition to the personnel in the electronic repairers series (MOS 35/94). It did not include operators/maintainers who were designated to repair their own systems.

As was seen from the overall personnel analysis of the MTOE, the number of electronics repairers in the 3rd ID increased by 81% over the assignments to the SBCT.

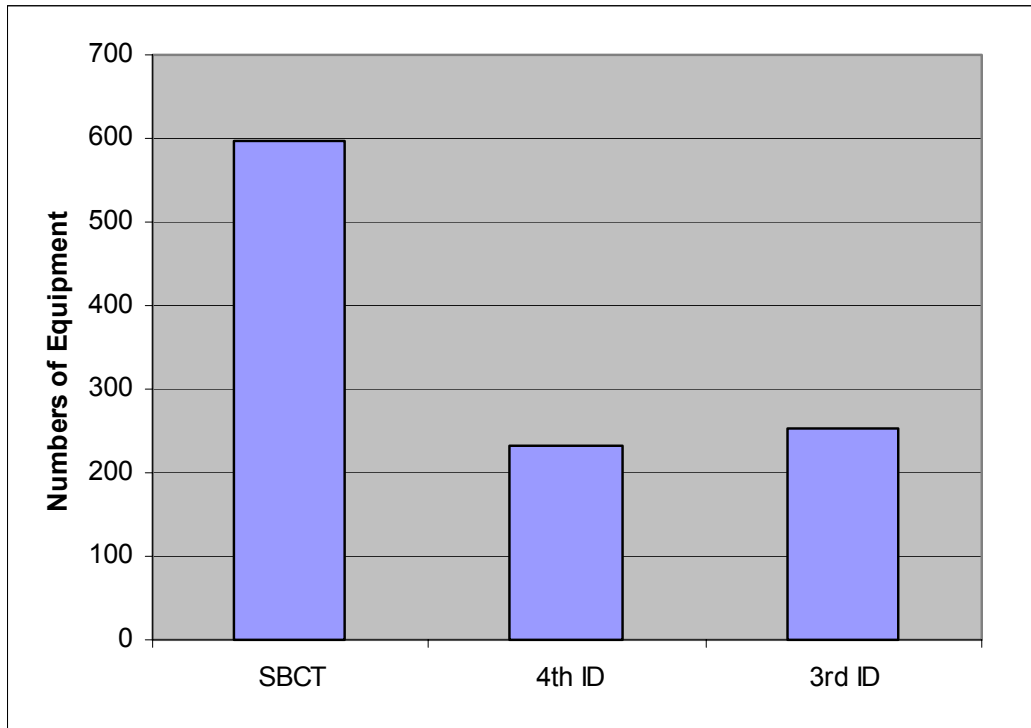

Figure 3. Quantity of C4ISR equipment per repairer for the SBCT, the 4th ID, and the 3rd ID.

This was true for the division as a whole as well at the UA/brigade level where repairers increased by 75%. When compared to the 4th ID though, the 3rd ID shows a decrease of 45% in the number of the repairers.

The analysis of the electronic equipment per repairer shows that the 3rd ID ratio was much closer to that of the 4th ID (see Figure 3). The ratio of equipment per repairer for the Stryker was almost 600:1 whereas for the 3rd ID, the ratio was about 250:1 which brings it more in line with the 4th ID at a ratio of about 230:1.

DISCUSSION

This evaluation was primarily conducted to determine if the numbers and types of signal personnel were adequate to support the overall C4ISR system for the restructured 3rd ID. Since performance data were not available on the 3rd ID C4ISR support, the MTOE was compared to the MTOEs of the 4th ID and the SBCT, combat units that had previously demonstrated levels of support for a C4ISR. The overall comparison between the 3rd ID, the 4th ID and the SBCT showed the differences in signal personnel numbers. It showed that for the 3rd ID, the number of personnel was smaller for every category of signal personnel when compared to the 4th ID except for the planning/COMSEC personnel (MOS 74C/25D). The largest difference, a reduction of 45%, was found for the communications systems personnel (MOS 31/25[F, P, S, etc]) who operate and maintain the major communications systems, such as the EPLRS Net Control Station, the Brigade

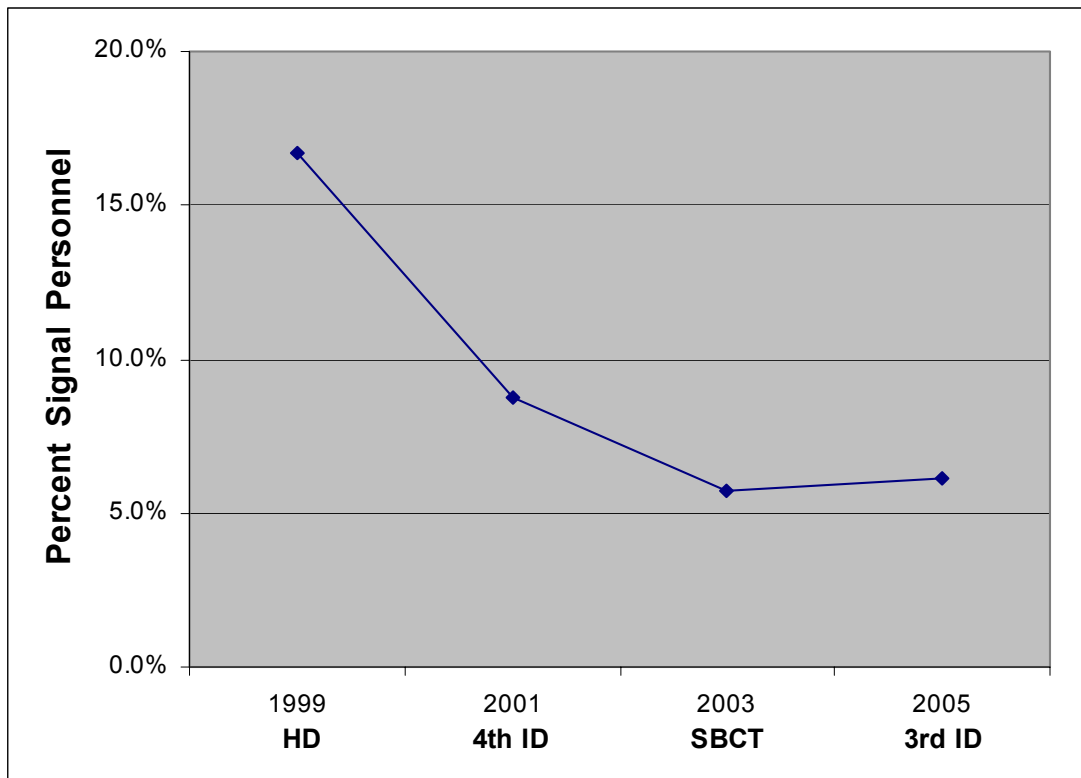

Figure 4. Signal personnel trends from the late 1990's to 2005. Data are the percent of signal personnel to overall unit strength for a Heavy Division (HD), the 4th ID, the SBCT, and the 3rd ID.

Subscriber Node (BSN), and the Joint Network Node (JNN). The new major systems tend to require fewer personnel for operations and maintenance. This would explain the significant drop in these personnel from levels required for the 4th ID to those of the 3rd ID. When comparing the overall communications systems personnel, the analysis also shows an increase of these personnel in the 3rd ID at UE headquarters positioned there for communication to higher headquarters and for connection into the Global Information Grid (GIG).

The overall data plotted across time highlights the trend in signal personnel assignments. The percentages of signal personnel to overall unit strengths are shown in Figure 4. These data are placed in time based on the C4ISR installations. The 4th ID received the bulk of its digitized C4ISR by the beginning of the year 2001 (Leins, 1999), while the SBCT was first fielded with its C4ISR in 2003, and the 3rd ID was reorganized late in 2004 and has only recently begun to utilize its C4ISR. A generic heavy division from the late 1990's is included for historic purposes, but, even there, a minimal electronic C4ISR was in use. The graph also shows a significant drop in signal personnel to the level of the SBCT with a slight increase upward for the 3rd ID. The overall percentages of signal personnel to overall manpower strengths was 16.7% for the older heavy division dropping to 6.1% for the 3rd ID. It appears then that the decrease in signal

personnel to support the C4ISR may have leveled out between the SBCT and the 3rd ID. The slightly larger percentage for the 3rd ID over the SBCT may be a result of the greater need for communications in a division sized organization over that required to support a brigade. The drop from 8.8% for the 4th ID to 6.1%, probably reflects the shift to newer C4ISR systems for the 3rd ID.

Regarding specific differences, the 4th ID consistently was shown to have more signal personnel than the 3rd ID in all categories, except COMSEC personnel. Much of the difference can be accounted for in the communications systems personnel (see Figure 1) where, in the 4th ID, many of the older wire systems were still in use. These older systems required more wire systems network personnel than are required for the digital networks, and so a decrease in communications systems personnel in the 3rd ID is not unexpected. When compared to the SBCT (Figure 1), the 3rd ID showed an increase in numbers for all categories, except the communications support personnel (MOS 31/25U) which were reduced by 61%. The reason for these latter results will be discussed in more detail with the analysis of the comparison between the SBCT and the UA.

The results of the SBCT evaluation, referred to earlier, indicated specific areas of concern for the manpower and personnel levels in support of the C4ISR of the brigade combat team (Anderson & Garfinkel, 2004). That evaluation showed a large number of trouble reports that could not be resolved within 24 hours. This result indicated that additional personnel were required to maintain the C4ISR system. Suggestions made for the SBCT were that signal manpower needed to be increased for specific MOSs and at specific locations. The number of information systems operator-analysts (MOS 74B) required increases and these were predominantly at the Brigade Headquarters (brigade main) and in the Brigade Support Battalion (brigade rear). Additional COMSEC personnel (MOS 74C) were thought to be required for brigade operations since only one was assigned to the brigade. That latter concern was verified in the field during actual operations in Iraq (Fischer, 2004). Manpower levels for electronics repair personnel were identified as needing increases, and maintenance/repair personnel (MOS 31/25U) needed to be included in the Combat Repair Teams. These specific areas of concern were evaluated since they might also be anticipated areas of concern for the brigade combat teams of the division/UE.

The comparison between the SBCT and the 3rd ID UA-4 demonstrates that some important changes have indeed occurred at that echelon. The 3rd ID levels were consistently greater in four of the six categories compared to the SBCT. Decreases occurred for staff personnel (officers, WOs, and NCOs) and communications support personnel (MOS 31/25U). As mentioned earlier, the communications support personnel (MOS 31/25U) for the 3rd ID decreased by 61% when compared to the SBCT. Part of the explanation may be that the greater independence of the SBCT required these additional personnel since a number of them serve double duty as forward repair personnel as well as communications forward support. It is interesting to note that at the battalion echelon of the UA, a number of these personnel went to the Support Battalion of the UA and are designated to go forward with the vehicle repairers of the Forward Support Company. These personnel were not available to the Combat Repair Team, the forward vehicle repair organization in the SBCT. This development can be thought of as an improvement in communications repair in the forward areas.

A closer look at the specific jobs of these personnel shows that a number of the

communications support personnel (MOS 31/25U) from the SBCT were retransmission system operators/maintainers. In the UA these personnel numbers decreased from 30 assigned to an SBCT to 19 for the UA. In the 3rd ID, the trend is to increase the number of satellite systems and thereby decrease the use of line-of-sight systems that require retransmission to maintain communications. This might explain a decreased need for the retransmission operators.

A major change that occurred in the 3rd ID C4ISR support to the UA compared to that of the SBCT was the increase in the number of the information system personnel (MOS 74/25B) at locations where the analysis of the SBCT indicated problems, that is, at brigade main and rear. The distribution of these personnel by subunit for the SBCT and the UA was shown in Table 3. The headquarters and support battalion had gains. The addition of these information system personnel is expected to help reduce the backlog of trouble reports experienced by the SBCT-1. On the other hand, the maneuver and field artillery battalions were reduced by one information systems soldier each. Although problems were not identified in the maneuver/field artillery battalions in the earlier SBCT evaluation, the reduction in information system personnel may result in an increase in C4ISR maintenance problems at these locations.

Another area of concern identified in the SBCT evaluation was that of having too few personnel assigned to the planning and COMSEC cell. The current analysis of these personnel (MOS 74C/25D) showed that additional personnel were available within the UA compared to the SBCT. Increasing the COMSEC personnel from one in the SBCT to two in the UA is expected to reduce the workload level and availability of these personnel.

Regarding the repair personnel at the UA echelon, the comparison of the SBCT/UA indicated that repair personnel almost doubled going from 24 in the SBCT to 42 in the UA. This increase would be expected to remove much of the equipment repair backlog experienced by the SBCT-1. For the UE as a whole, this reduced the ratio of electronic equipment to repairer to a ratio close to that of the 4th ID improving the ratio significantly from that calculated for the SBCT (see Figure 3).

A major concern in recent years has been the availability of signal personnel to support the electronic C4ISR. The acquisition of new systems has resulted in increasing the number of electronic systems being fielded to the force as the numbers of signal personnel have been reduced. From 1987 to 1998, the number of signal soldiers has declined from an overall Army wide strength of 67,000 to 31,000 soldiers (Enlisted Notes, 1998). In spite of the decline in signal personnel, program offices identify signal and electronic maintainers to replace and repair the new electronic systems. Since much of this equipment forms the architecture of the C4ISR system, signal personnel continue to be in high demand as maintainers and repairers.

Overall, this evaluation has shown the Army's commitment to reducing the "tail to tooth" ratio while providing for a C4ISR system. An overall reduction in signal personnel was demonstrated from the 4th ID with its comparatively heavy C4ISR support to the leaner 3rd ID. It also appears that the transformed 3rd ID implemented an improved signal support structure based on lessons learned from the SBCT-1. The 3rd ID's increases of signal personnel at strategic locations within the UA/UE structure are expected to reduce the problems identified by the earlier analysis of the SBCT. The increase in information systems personnel at brigade main and rear should reduce the backlog of problems

experienced by the SBCT-1. Also the increases in repairers and planning and COMSEC personnel are considered an improvement. These changes are expected to improve the overall wellbeing of the C4ISR system. However with the reduction of the information systems personnel (MOS 74/25B) at the maneuver and strike battalions and the loss of some communications support personnel (MOS 31/25U), new problems may occur. It remains to be seen if these problems will affect the stability of the C4ISR for the 3rd ID.

REFERENCES

- Anderson, B. W. and Garfinkel, G. S. (2004) Maintaining the information flow: Signal corps manpower and personnel requirements for the battlefield [CD-ROM]. *9th International Command and Control Research and Technology Symposium, Copenhagen, Denmark (Track 8.2:144)*. Washington, DC: Department of Defense Command & Control Research Program.
- Enlisted Notes. (1998) Mos restructuring study. *Army Communicator*, 23 (1).
- Fischer, P. (2004) Digitally deployed: Signal transformation in combat: 3/2 Stryker Brigade Combat Team in OIF. *Army Communicator*, 29 (3).
- Klynsma, S. & Scott, T. (2001). C4ISR architectures. *Army AL&T*, November-December: PB 70-01-6, 17–19.
- Leins, C. (1999) Adapting information-age technology for the first digitized division. *Army RD&A*, November-December: PB-70-99-6, 6–8.
- Mazzucchi, M. R. (2003). How the network supports the objective force. *Army AL&T*, March-April: PB 70-03-2, 9-11.
- Mazzucchi, M. R. & Rider, T. L. (2004). The life-cycle management approach—Team C4ISR delivers new equipment and the Joint Network Node to the 3rd Infantry Division. *Army AL&T*, November-December: PB 70-04-06, 8–12.
- Shinseki, E. K. (1999) Army Chief of Staff speech launching Army Transformation, October 1999. Washington, DC.
- U.S. Department of the Army (DOA). (2000). *Table of organization and equipment: Brigade Combat Team (BCT)*. Washington, DC: Headquarters, U.S. Department of the Army.
- U.S. Department of the Army (DOA). (2004). *Modification table of organization and equipment: Third Infantry Division*. Washington, DC: Headquarters, U.S. Department of the Army.
- U.S. Forces Command (FORSCOM). (2001). *Modification table of organization and equipment: Fourth Infantry Division*. Fort McPherson, GA: Headquarters, U.S. Forces Command.



Human Research and Engineering Directorate

MANPOWER AND PERSONNEL SUPPORT FOR THE C4ISR IN THE TRANSFORMED DIVISION

B. Wayne Anderson
U.S. Army Research Laboratory



Army Transformation

Human Research and Engineering Directorate

- US Army transforming warfighting capabilities
- Moving from brigade/division structure toward Unit of Action/Unit of Employment
- More strategically responsive
- At the same time C4ISR becoming increasingly electronic
- Increasing reliance of C4ISR information system
- C4ISR Concern
 - Can it be maintained?

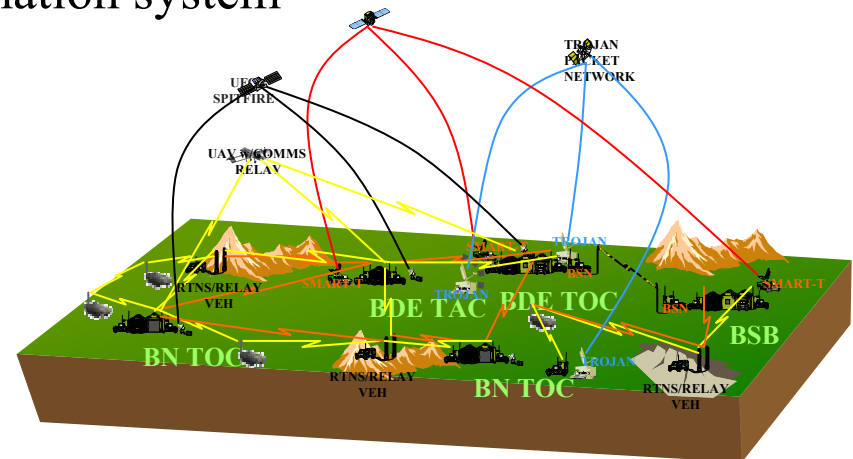



Changing Signal Corps Personnel

Human Research and Engineering Directorate

- Maintenance of the C4ISR falls to the signal corps personnel
- Reduction in the number of signal corps personnel 1988 to 1998
- From 61,000 to 37,000 signal soldiers
- Support requires increased skills
- Evaluate the signal corps personnel as the 3rd ID goes through its transformation

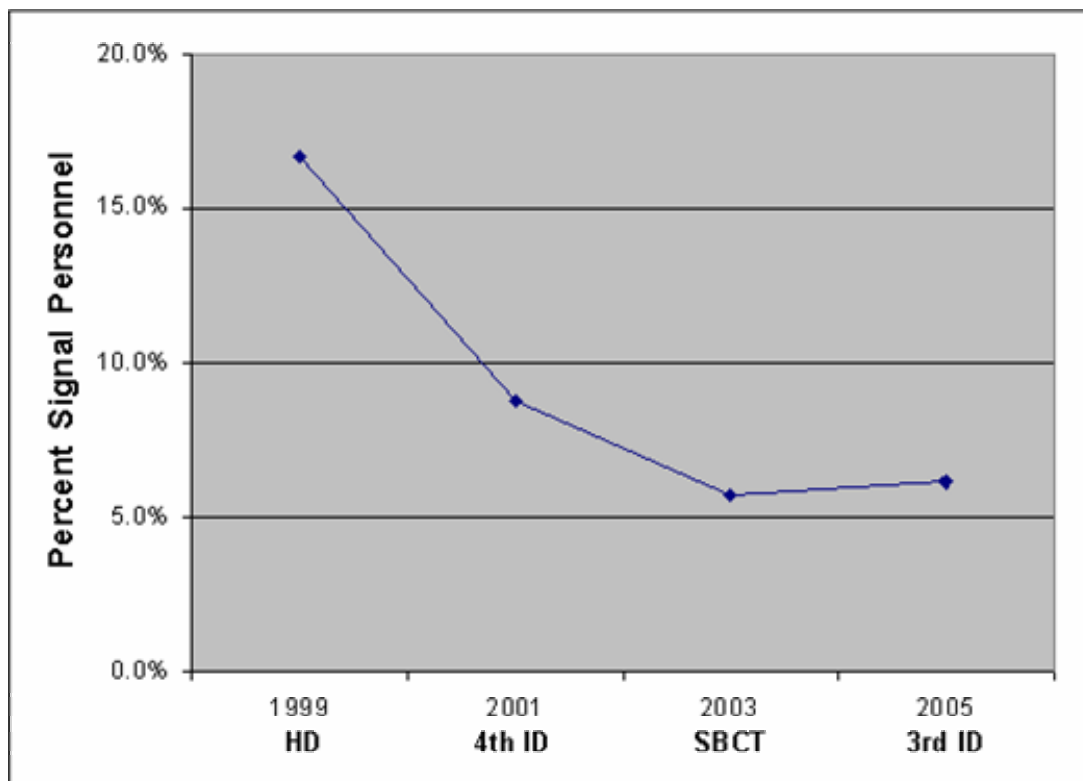



Objectives of Evaluation

Human Research and Engineering Directorate

- Evaluate problem of support to C4ISR for warfighting operations in new organization
- Evaluate the signal corps personnel as the 3rd ID goes through its transformation
 - Determine if numbers are sufficient to support C4ISR requirements for the transformed 3rd ID
 - Determine if MOSs are appropriate
 - Determine if organizational locations are appropriate



Categories of Signal Personnel and Analyses

Human Research and Engineering Directorate

		MOSs		ANALYSES		
		MOSs in Each Category	New MOS Designations* and New MOSs	Overall MTOE signal personnel comparison	SBCT/UA signal personnel comparison	Electronic equipment/repairer analysis
CATEGORIES OF SIGNAL PERSONNEL	Officers/WOs/NCOs	25A, 53A, 250N, 251A, 254A, 31W, 31Z, 74Z	25A, 53A, 250N, 251A, 254A, 948B, 25W, 25X, 25Y, 94W	X	X	
	Information Systems and Networking	74B	25B	X	X	
	Plans and Communications Security	74C	25D	X	X	
	Signal Support	31U	25U	X	X	
	Signal Communications Systems	31C, 31F, 31L, 31R, 31S	25F, 25L, 25P, 25Q, 25S	X	X	
	Communications and Electronics Repair	35E, 35F, 35J, 31F, 31P	94E, 94F	X	X	X

* The new MOS designations are a result of the Army's realignment of MOS codes which for the MOS 31- and 74-series occurred as of FY 05 and for the MOS 35-series will occur in FY 06.



Organizations for Comparison

Human Research and Engineering Directorate

- Comparison of MTOEs for 3rd ID, 4th ID, and Stryker Brigade
- 4th ID - Army's First Digitized Division
 - C4ISR electronic equipment
 - Older wire systems
- Stryker
 - Newer C4ISR electronic equipment
 - Brigade Combat Team (BCT)
- For comparison normalized personnel based on size of 3rd ID



3rd ID/4th ID Comparison

Human Research and Engineering Directorate

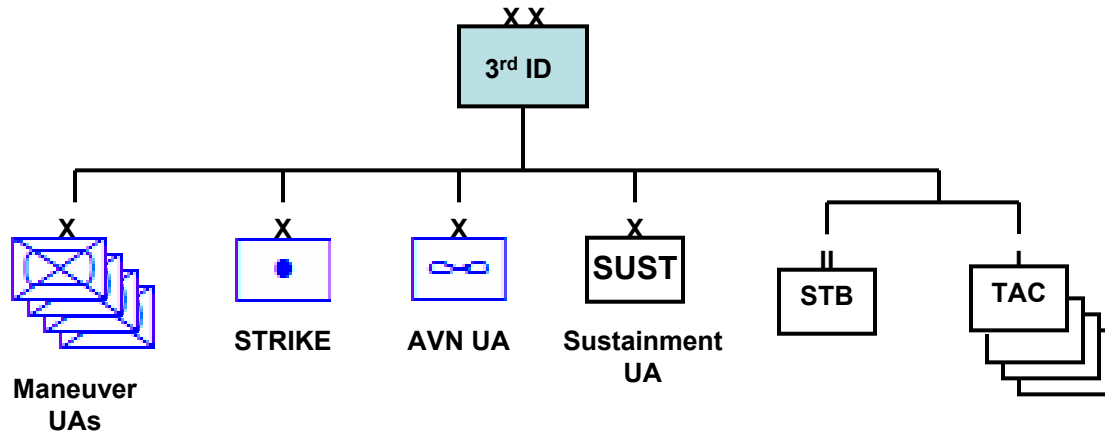
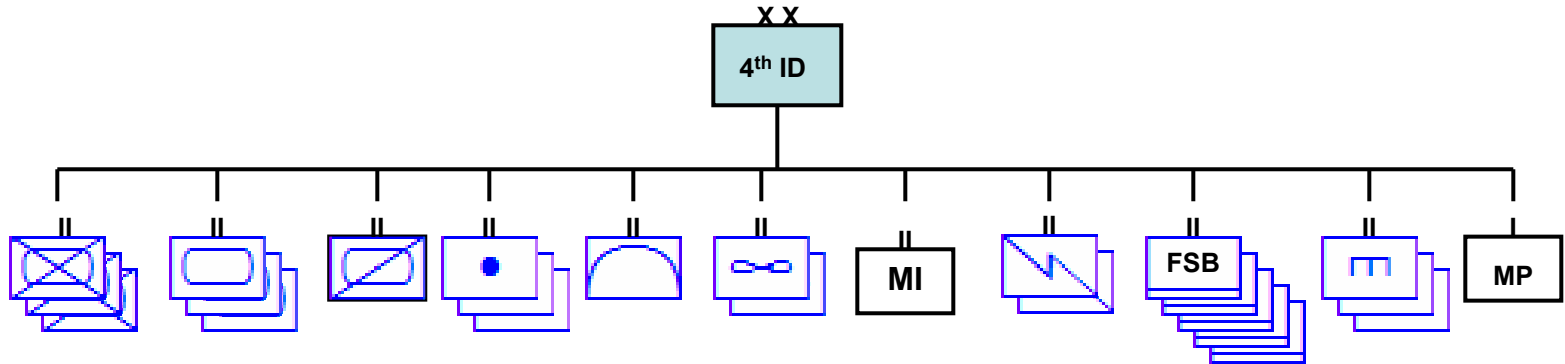



Normalization

- For comparison normalized personnel based on size of 3rd ID
- Predicted is 3rd ID level of support if staffed at the same level as 4th ID or Stryker Brigade

$$P = (T_{P3} - S_{P3}) / ((T_{PX} - S_{PX}) / S_{PX})$$

where P = predicted number of support personnel

T_{P3} = total personnel 3rd ID

S_{P3} = signal personnel 3rd ID

T_{PX} = total personnel in comparison unit

S_{PX} = signal personnel in comparison unit

	Total Number of Personnel	Signal Personnel	Predicted No. Personnel to Support 3rd ID
3rd ID	20503	1254	1254
4th ID	13719	1203	1850
SBCT	3154	181	1172



4th ID to 3rd ID Comparison

Human Research and Engineering Directorate

- Decreases in signal personnel in all categories except COMSEC Personnel compared to the 4th ID
- Significant drop in Communication System Personnel
- Reduction due to reduction in older wire systems being used for C4ISR

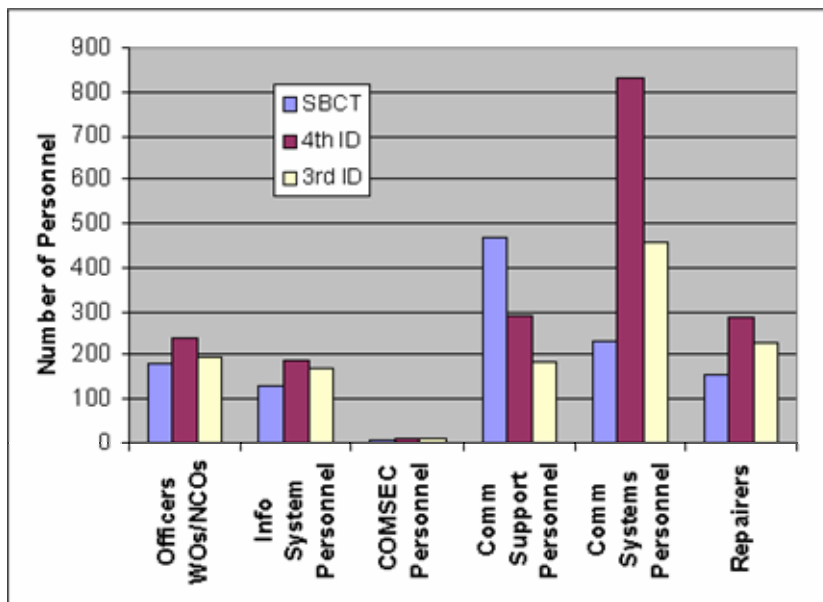

PERCENTAGE DIFFERENCES						
	Officers WOs/NCOs	Info System Personnel	COMSEC Personnel	Comm Support Personnel	Comm Systems Personnel	Repairers
4ID	-18%	-8%	6%	-37%	-45%	-21%



Stryker to 3rd ID Comparison

Human Research and Engineering Directorate

- Increases in all personnel types except Communication Support Personnel
- Significant decrease in Communication Support Personnel
- Decrease due to reduced reliance on retransmission services

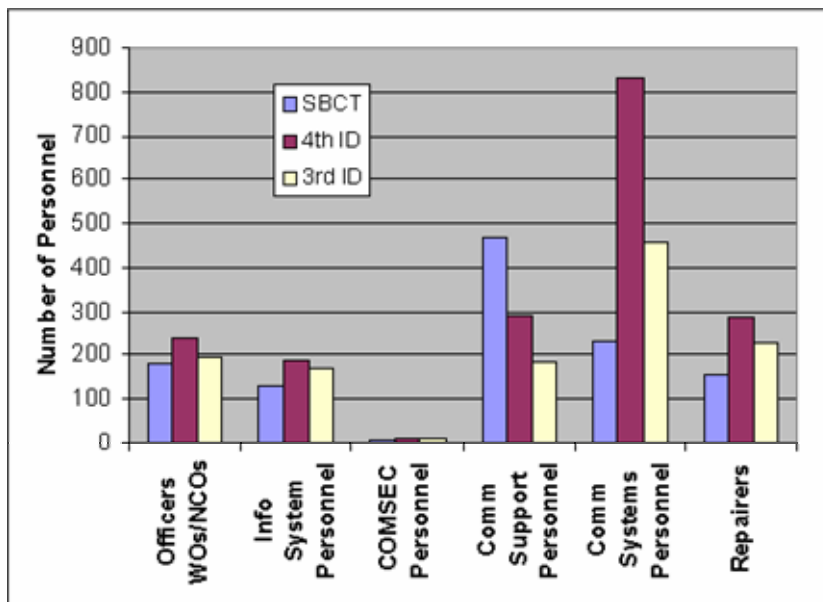

PERCENTAGE DIFFERENCES						
	Officers WOs/NCOs	Info System Personnel	COMSEC Personnel	Comm Support Personnel	Comm Systems Personnel	Repairers
SBCT	10%	33%	101%	-61%	97%	45%



SBCT and 3rd ID Unit of Action Comparison

Human Research and Engineering Directorate

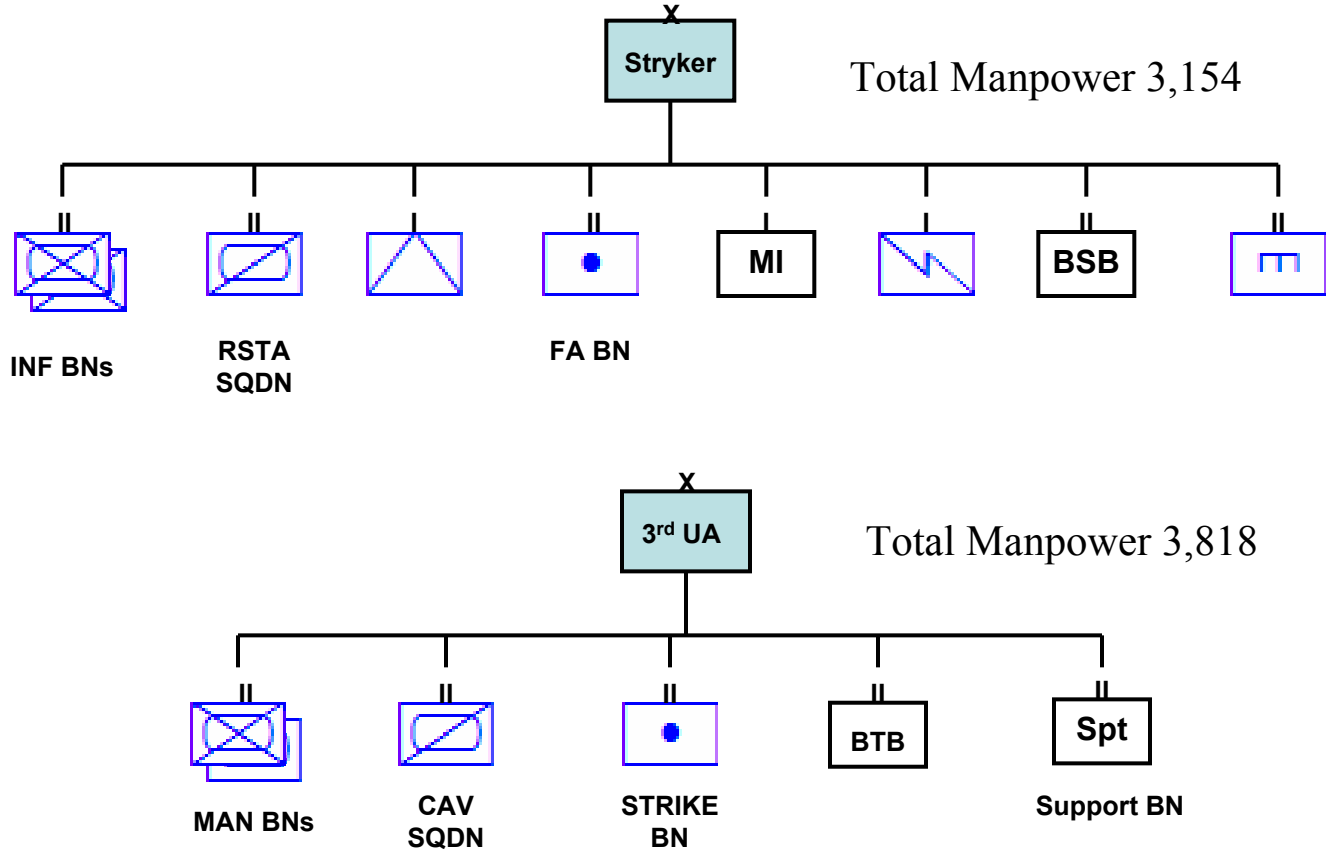



Comparison of Signal Personnel by Types

Human Research and Engineering Directorate

- Increases except for staff personnel and communications support personnel
- Significant decrease in Communication Support Personnel
- Significant increase in repairers

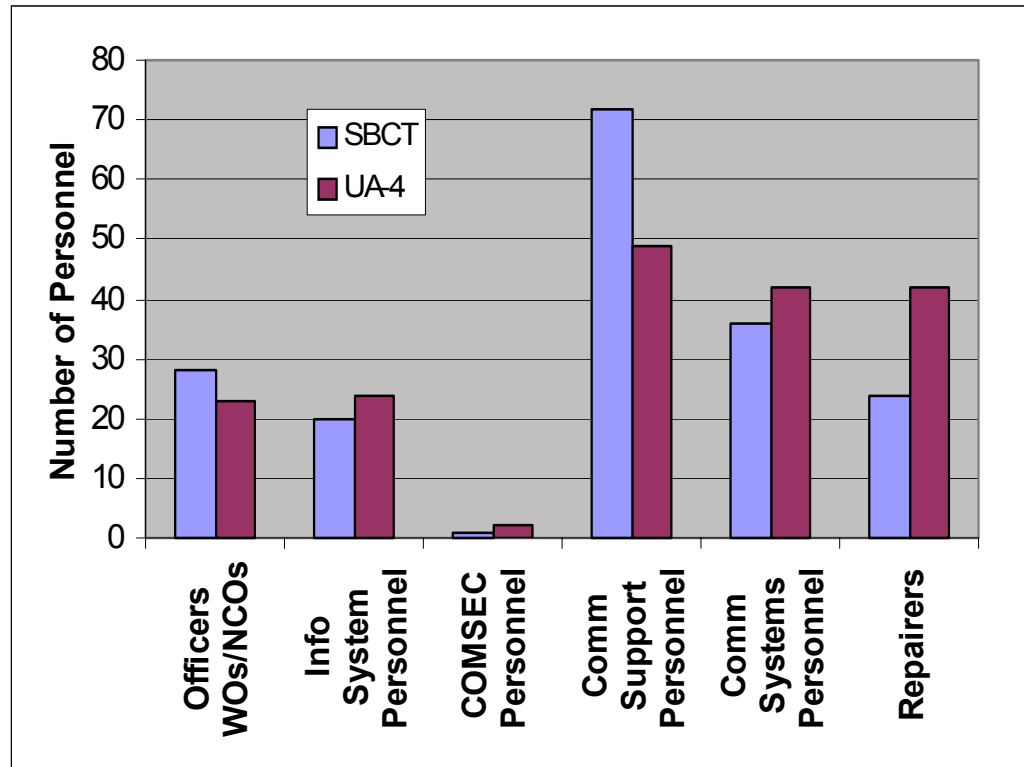



Findings From Earlier Evaluation of SBCT

Human Research and Engineering Directorate

- Analyzed Trouble Reports from an Stryker Brigade operational exercise
- Study showed need for additional information system personnel
- Need for additional repairers
- Need for additional COMSEC personnel
- Need for 31U in the Combat Repair Teams



Distribution of Info Systems Personnel

- Trouble reports showed information systems personnel (74B) needed at specific locations:
 - Brigade Main
 - Brigade Rear

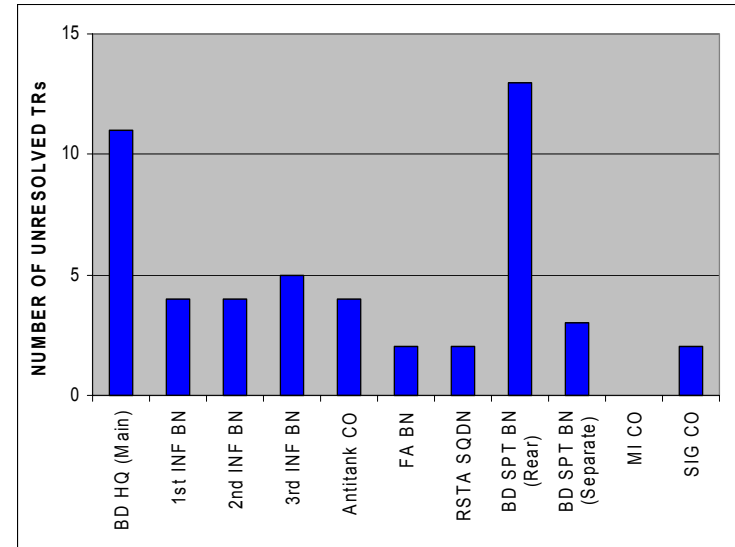

- Manpower levels for information system personnel increased in organizations that showed the greatest need
- Lost 1 each in maneuver battalions and field artillery battalion

SBCT/UA Subunits	Info System Personnel	
	SBCT	UA
HQ (main)	0	4
Signal Co/BTB	6	7
RSTA/Cavalry SQDN	3	3
Maneuver BN	3	2
Maneuver BN	3	2
FA/Strike BN	3	2
BSB/Support BN (rear)	2	4



C4ISR Equipment per Repairer

Human Research and Engineering Directorate

- Repair personnel were increased in 3rd ID compared to SBCT levels
- C4ISR equipment per repairer used as measure of workload
- Comparison of equipment per repairer more in line with that of the 4th ID

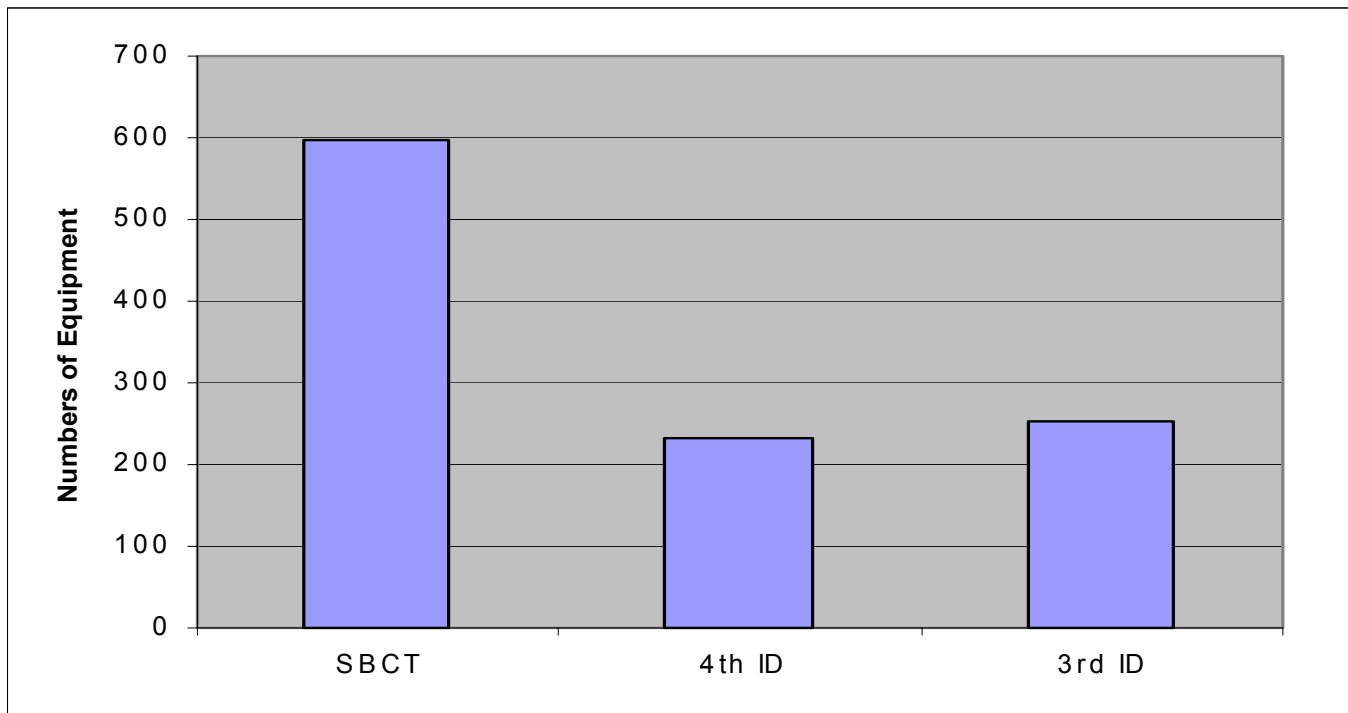



Additional Observations

Human Research and Engineering Directorate

- Increased COMSEC personnel from 1 in the Stryker BCT to 2 in the 3rd ID BCT
 - Concern expressed in earlier evaluation confirmed by Stryker signal personnel in Iraq
- Identified issue of no 31U available to go forward in the Combat Repair Teams
 - 3rd ID included 31U in Forward Repair Teams with the vehicle repairers



Conclusions

Human Research and Engineering Directorate

- Army has followed its plan to reduce the support tail
- In the process it has effectively reduced the number of signal personnel
- Placed 3rd ID signal personnel in strategic locations to support C4ISR
- Some remaining concerns
 - Reduction in Information Systems Personnel (74B) in the maneuver battalions
 - Reduction in Communication Support Personnel (31U)
- 3rd ID appears to have better support for C4ISR system