

**Cover Sheet**

**NetSTAR: Methodology to Identify Enemy  
Network Structure, Tasks, Activities, and Roles**

**Paper:** 133

**Names of Authors:** Georgiy Levchuk<sup>1\*</sup>, Kari Chopra<sup>1</sup>, and Krishna Pattipati<sup>2</sup>

<sup>1</sup>Aptima<sup>®</sup>, Inc.  
12 Gill St, Suite 1400  
Woburn, MA 01801  
(781) 935-3966

[georgiy@aptima.com](mailto:georgiy@aptima.com); [kchopra@aptima.com](mailto:kchopra@aptima.com)

<sup>2</sup>University of Connecticut  
Electrical & Computer Engineering  
371 Fairfield Road, Unit 2157  
Storrs, CT 06269-2157 USA  
(860) 486-2890

[krishna@engr.uconn.edu](mailto:krishna@engr.uconn.edu)

\*Denotes author to contact.

**Track Topic:** Modeling and Simulation

10<sup>TH</sup> INTERNATIONAL COMMAND AND CONTROL RESEARCH AND TECHNOLOGY SYMPOSIUM  
THE FUTURE OF C2  
McLean, Virginia, June 13-16, 2005

# Report Documentation Page

Form Approved  
OMB No. 0704-0188

Public reporting burden for the collection of information is estimated to average 1 hour per response, including the time for reviewing instructions, searching existing data sources, gathering and maintaining the data needed, and completing and reviewing the collection of information. Send comments regarding this burden estimate or any other aspect of this collection of information, including suggestions for reducing this burden, to Washington Headquarters Services, Directorate for Information Operations and Reports, 1215 Jefferson Davis Highway, Suite 1204, Arlington VA 22202-4302. Respondents should be aware that notwithstanding any other provision of law, no person shall be subject to a penalty for failing to comply with a collection of information if it does not display a currently valid OMB control number.

1. REPORT DATE <b>JUN 2005</b>		2. REPORT TYPE		3. DATES COVERED <b>00-00-2005 to 00-00-2005</b>	
4. TITLE AND SUBTITLE <b>NetSTAR: Methodology to Identify Enemy Network Structure, Tasks, Activities, and Roles</b>				5a. CONTRACT NUMBER	
				5b. GRANT NUMBER	
				5c. PROGRAM ELEMENT NUMBER	
6. AUTHOR(S)				5d. PROJECT NUMBER	
				5e. TASK NUMBER	
				5f. WORK UNIT NUMBER	
7. PERFORMING ORGANIZATION NAME(S) AND ADDRESS(ES) <b>Aptima Inc,12 Gill Street Suite 1400,Woburn,MA,01801</b>				8. PERFORMING ORGANIZATION REPORT NUMBER	
9. SPONSORING/MONITORING AGENCY NAME(S) AND ADDRESS(ES)				10. SPONSOR/MONITOR'S ACRONYM(S)	
				11. SPONSOR/MONITOR'S REPORT NUMBER(S)	
12. DISTRIBUTION/AVAILABILITY STATEMENT <b>Approved for public release; distribution unlimited</b>					
13. SUPPLEMENTARY NOTES <b>The original document contains color images.</b>					
14. ABSTRACT					
15. SUBJECT TERMS					
16. SECURITY CLASSIFICATION OF:			17. LIMITATION OF ABSTRACT	18. NUMBER OF PAGES <b>44</b>	19a. NAME OF RESPONSIBLE PERSON
a. REPORT <b>unclassified</b>	b. ABSTRACT <b>unclassified</b>	c. THIS PAGE <b>unclassified</b>			

# NetSTAR: Methodology to Identify Enemy Network Structure, Tasks, Activities, and Roles

Georgiy Levchuk<sup>1</sup>, Kari Chopra<sup>1</sup>, and Krishna Pattipati<sup>2</sup>

<sup>1</sup>Aptima, Inc. 12 Gill Street, Suite 1400, Woburn, MA 01801

<sup>2</sup>University of Connecticut, Storrs, CT 06269

## ABSTRACT

To counteract the enemy organization, knowledge of the principles under which this organization operates is required. This knowledge provides the ability to detect and predict the activities of the enemy and to select the appropriate counter-actions. Certain counter-actions require additional knowledge about enemy organization and processes – ranging from the specifics of organizational command, control, communication and information distribution (C3I) structures to the responsibility delegation and goals at the most important enemy nodes. Our paper proposes to solve the problem of identifying the enemy organization and activities via the NetSTAR system employing a hybrid multi-phase model-based structure and process identification approach. The basis for NetSTAR is an innovative methodology that integrates a social network model of coordination, a meta-task model of enemy goals, and a Hidden-Markov Model (HMM) of enemy activities to detect subgroups engaged in coordinated activities. This model enables the computation of the likelihood of the hypothesized organizational structure and processes given the observed behavior, and allows designing effective dynamic counter-action strategies via Partially Observable Markov Decision Processes (POMDP) modeling.

## 1. Introduction

Analysis of the behavior of organizations, ranging from the more structured command systems of a conventional military to the decentralized and elusive insurgent and terrorist groups, suggest that the strong relationship exists between the structure, resources, and objectives of those organizations and the resulting actions. The organizations act in their missions by accomplishing tasks which may leave detectable events in the information space. The dynamic evolution of these events creates patterns of the potential realization of organizational activities and may be related, linked, and tracked over time (Pattipati *et al.*, 2004). The observational data, however, is very sparse, creating a challenge to connect relatively few enabling events embedded within massive amounts of data flowing into the government's intelligence and counter-terrorism agencies (Popp *et al.*, 2004).

To counteract the enemy organization, knowledge of the principles and goals under which this organization operates is required. This knowledge provides the ability to detect and predict the activities of the enemy and to select the appropriate counter-actions. However, certain counter-actions require additional knowledge of the specifics of organizational structure and responsibility distribution to be successfully directed at the most important enemy nodes. Our paper proposes to solve the problem of identifying the enemy command organization and activities via the NetSTAR system, a hybrid model-based structure and process identification methodology.

This paper is organized as follows. Section 2 outlines the context of the problem we are addressing. Section 3 provides a detailed description of the proposed hybrid NetSTAR system, including definition and workflow of the phases of the methodology and resulting system components.

## 2. Problem Context

Given the set of events and transactions observations, friendly (BLUE) forces need to identify the command structure and action process flow of the enemy (RED) organization. The command structure of the organization is represented as the set of organizational nodes (which may include individuals, cells, sub-structures, resources, etc.) and their role distribution. The role of a node is defined through its rules of engagement, and materializes in node tasking and inter-node information flow. The same RED organization can be engaged in different operational modes (also termed "missions") at different times. We assume that two types of observations can be received:

- (a) **Communication Transactions**, also termed "*chatter*", – are instances of communication between nodes of the RED team, with time, duration, and possibly (partial) content of communication specified (e.g., "members of militant wing engaged in a meeting with weapons suppliers at 11:35 am for 35 min to procure explosives"); and
- (b) **Events** – network interventions that identify the ongoing activities of RED agents/cells, with specified time, agents and resources (e.g., "BLUE team discovered a safehouse and apprehended arms dealers and RED operatives attempting to procure weapons").

### 3. Proposed Solution: NetSTAR

NetSTAR is a hybrid model-based structure and process identification methodology employing a Social Network Model to identify collaborating subgroups of RED nodes within the larger organization, a hierarchical meta-task graph model to represent enemy goals, a Hidden Markov Model to define the evolution of organizational processes and activities (including communication, individual and team tasking, information dissemination, resource employment, etc.), and a Partially Observable Hidden Markov Model to develop effective counter-action policies. NetSTAR is designed to have the following capabilities:

- (i) *Identify the organizational structure and predict the operational processes of the enemy:* NetSTAR employs an innovative methodology that integrates a social network model of coordination, a meta-task model of enemy goals, and a Hidden-Markov Model of enemy activities to detect subgroups engaged in coordinated activities. This model enables the computation of the likelihood of the hypothesized organizational structure and processes given the observed behavior;
- (ii) *Track and identify enemy nodes and members:* NetSTAR employs probabilistic role association to determine the roles and responsibilities of observed enemy team members, nodes, cells, etc.;
- (iii) *Identify and assess potential threats:* NetSTAR represents the current activities of the enemy in the form of a transition graph generated from mission templates; the matched (i.e., the most likely) model is employed to forecast the dynamic evolution of future enemy actions;
- (iv) *Generate effective counter-actions:* NetSTAR employs Partially Observable Markov Decision Process formalisms to identify the best counter-action policy in a stochastic mission environment.

#### 3.1 NetSTAR Phases and Workflow

To achieve above capabilities, NetSTAR is composed of the following 5 interacting modeling phases (see Figure 1). **Phase 1** employs a Social Network Model to identify collaborating subgroups of RED nodes within a larger organization. **Phase 2** simulates the behavior of enemy organization executing given mission. **Phase 3** defines the evolution of organizational processes and activities (including communication, individual and team tasking, information dissemination, resource employment, etc.) using Markov Transition Diagram and Hidden Markov Model representations. **Phase 4** identifies currently active organizations and missions from observations via tracking events, activities and processes using a Hidden Markov Model. Finally, **phase 5** develops effective counter-action policies by formulating the problem as a Partially Observable Markov Decision Problem (POMDP).

##### A. Knowledge Base

To address the enemy organization identification problem, we first design the *knowledge base* (KB) of RED organizational structures, models of operation, and processes. The KB consists of two main components: (i) organization library; and (ii) mission library. The *organization library* contains various structures of enemy organizations, which are constructed from well understood enemy formations that have been met in the past, as well as hypothesized novel organizational forms. The *enemy organization* is represented in the organization library as the set of nodes with specified roles, responsibilities, and relationships between them (e.g., command topology,

communication network, information access structure, resource ownership, etc.). The nodes in the organization might represent terrorist cells, individual team members, resources, etc. The roles and responsibilities of the nodes identify the action selection, operational policy, and information flow in the enemy network. The organizational library defines the basis from which the most likely organization is identified using sparse, uncertain observations.

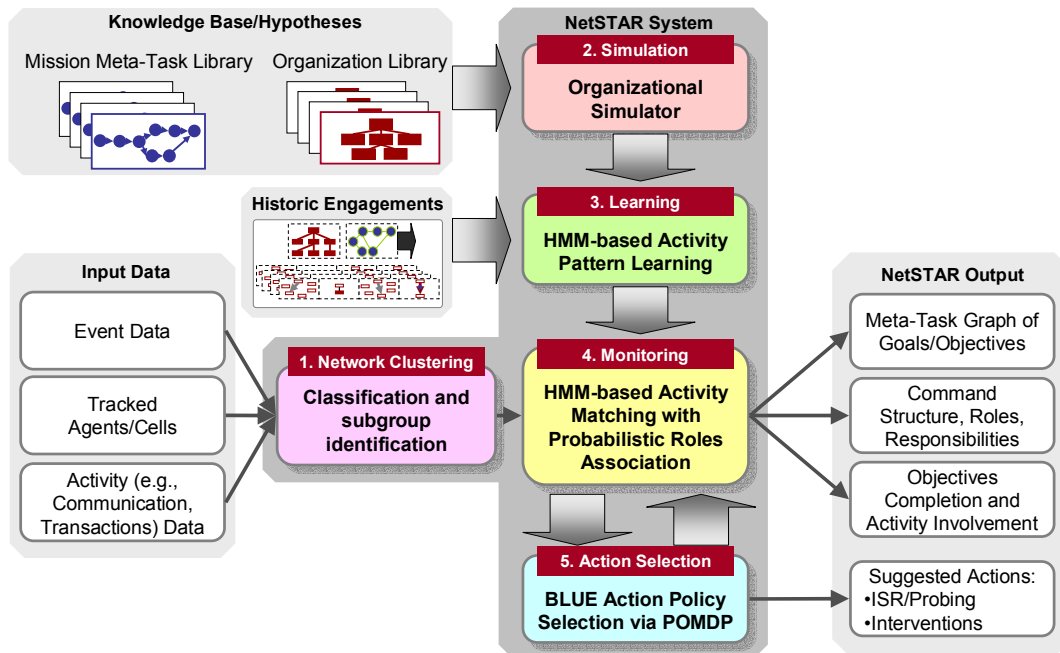

**Figure 1:** NetSTAR hierarchical structure and data flow

While the organizational forms are static constructs, their dynamic operations are defined through the environment, mission, and organizational goals. These variables are specified in the *mission library*, which contains *meta-task graphs* corresponding to specific missions and objectives that enemy organization might perform. Each task in a meta-task graph represents the intermediate goal or a collection of goals of the enemy organization. The precedence constraints among meta-task graph nodes limit the feasible sequencing of goals achieved by mission execution policies.

### B. Meta-Task Representation: Process-Action Graph

Each individual meta-task execution involves the *pattern of processes/activities* that the enemy might employ to achieve the corresponding goal. Various methodologies may be utilized to model these constructs, including Applied Cognitive Task Analysis, Bayesian Networks, Transition Graphs, Markov Decision Processes, etc. Therefore, each meta-task will be decomposed into a substructure that defines the processes, communication, and actions of RED team members that trigger the observations obtained by BLUE organization. This *process-action graph* substructure and its contents (specific RED process decomposition parameters and BLUE counter-actions) are obtained separately for each organization-mission pair from the Knowledge Base based on well-understood or hypothesized enemy doctrine gleaned from analysis of past events, exercises, maneuvers and war-games.

In NetSTAR, we propose to model the process-action graph substructure of the meta-task graph as a Markov Decision Process (MDP) (Meirina *et al.* 2002). MDP addresses the issues of uncertainty of action outcomes and consists of state nodes, action (control) nodes, utility/reward

function associated with applying actions and reaching state nodes, and links associated with transition probabilities. In our modeling paradigm, state nodes indicate the processes (action, communication, or operation, and associated participating nodes of RED team) that the enemy organization must execute in order to achieve the goal associated with the corresponding meta-task, and the actions specifying what the BLUE organization can do to influence the activities of the enemy. When the BLUE organization does not perform any actions, the MDP converts into *probabilistic Markov state transition model*. As a result, each organization-mission pair from the Knowledge Base results in an *expanded probabilistic process transition graph*.

In the enemy identification problem, the observations obtained by BLUE are very often unclear. The uncertainty occurs when the observation cannot be classified to belong to only a single process from all feasible meta-task substructures. In this situation, a Partially Observable Markov Decision Problem (POMDP) can be successfully applied. However, the difficulty arises when the correct MDP defining the workflow processes of the RED team is not known. In this case, the action policies determined for one fixed MDP or POMDP might not reflect the real operations of RED team, and therefore will not achieve the desirable result.

### **3.2 Identification of Mission Teams: Network Clustering and Social Network Analysis**

Equipped with a knowledge base describing hypothesized organizational structures and mission activities, the first step in the NetSTAR algorithm is to identify the subgroups within the total set of RED nodes under surveillance that are actively collaborating toward a mission. Our approach is based on constructing a *proximity network* on the communications transactions and events, where the proximity between two transactions is computed as a function of their temporal proximity and the identities of the nodes involved in the transaction. The Social Network Analysis technique of *LS-Sets* is then applied to partition the proximity network into distinct subsets. Each LS-Set captures a stream of transactions that comprise a coordinated set of activities toward a common mission. The set of nodes attached to these transactions thus define the membership of a specific mission team within the RED organization. Each of these subgroups is then fed into the subsequent stages of the algorithm to identify the mission under execution as well as the structure of roles and responsibilities within group.

### **3.3 Organizational Simulator**

Organizational simulation phase models enemy behavior given enemy organization and objectives to generate multiple activity patterns, which will be organized into efficient template structures via Hidden Markov Models (HMMs) in the **Activity pattern learning phase**. These templates/models can later be used to efficiently compare against the stream of activity observations.

The simulation phase utilizes Aptima's Team Optimal Design (TOD) simulation system (MacMillan *et al.*, 2002), (Levchuk *et al.*, 2005). The simulator requires the knowledge of enemy organization (capabilities, ROE, roles and responsibilities of nodes/cells/agents), mission objectives, characteristics of the mission environment, and organizational processes. Our premise is that, for a specific mission objective, the meta-tasks that the enemy will be performing are fixed, while the specific activities to be performed to accomplish those tasks ("how" tasks are accomplished) can change. Thus, an agent (member, node, or cell of organization) will act according to its own process model.

TOD model was developed under several programs, including the Navy’s Adaptive Architecture for Command & Control, the Navy’s Manning Affordability Initiative, and Air Force programs. TOD software accurately modeled existing AEGIS AAW operations and was used to develop concepts for reducing manning. TOD was applied to DD-21, design of teams for AWACS (U.S.A.F.), Future Combat Systems (U.S. Army), Joint Forces and Joint Experimentation programs, and used to define the optimal team structure for the E-10 Multi-sensor Command and Control Aircraft (MC2A) and to evaluate alternative architectures for C2 (e.g., ForceNET).

The central thesis of prior applications of the TOD model was that a set of interdependent, interrelated tasks that must be completed under time constraints has an underlying quantitative structure that can be exploited to design the “best” team structure and strategy for accomplishing those tasks. This approach is based on a multi-phase allocation model that consists of three pieces (Figure 2a): (i) the *tasks* that must be accomplished and their interrelationships (i.e., the “mission”); (ii) the external *resources* needed to accomplish those tasks (e.g., information, raw materials, or equipment), and (iii) the human *agents* (decision makers) who will constitute the team. TOD takes data representing a mission, tasks, and operators, and applies optimization algorithms to assign tasks to team members, schedule team tasks, and measure team performance. A simple set of parameters enables the user to perform analyses of workload, coordination, and mission execution tempo in support of manning and trade-space analyses. In the proposed work, we will utilize a scheduling phase of TOD with hierarchical task allocation architecture (see superior-subordinate operator model in Figure 2.b) to generate activity sequences.

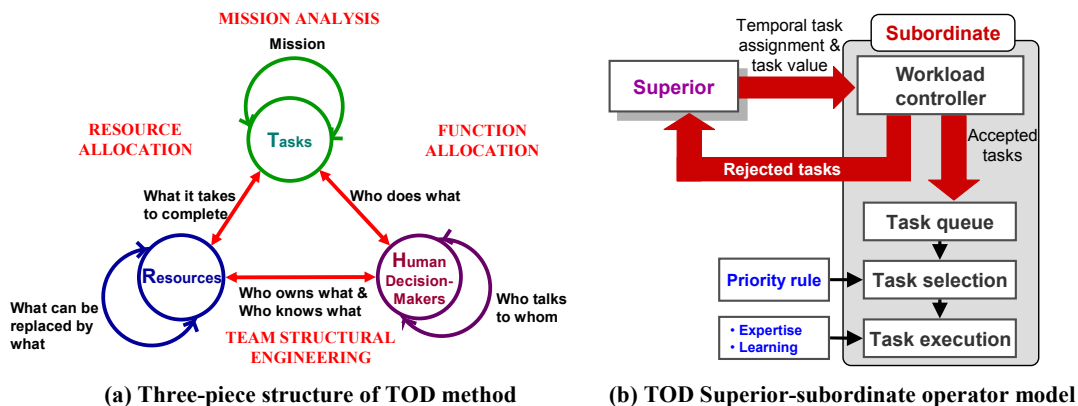

Figure 2: Team Optimal Design model

One of the key components of the NetSTAR model is the conversion of organizational parameters (structure, responsibilities, resources, etc.) into a process workflow and process-action graph. Our approach is based on learning the probabilistic transition (workflow process) graphs and decision (process-action) graphs from the predicted process-action sequences generated via the Team Optimal Design (TOD) model developed by Aptima to design optimized organizational structures, task execution and team workflow processes (McMillan *et al.* 2002).

### 3.4 Learning Phase

This phase defines the evolution of organizational processes and activities (including communication, individual and team tasking, information dissemination, resource employment, etc.) using Markov Transition Diagram representation, and its extension for the case of uncertain observations – Hidden Markov Model (HMM). The model learns HMM patterns of enemy



activity using Baum-Welch algorithm from either historic data or outputs from an Organizational Simulator. The methodology employs supervised and unsupervised learning, extending the methodology to address the issues of missing observations, task structure, dependencies and parallelism. We will use multi-layered HMMs for structure representation, and factorial and coupled HMMs for modeling task dependencies and task parallelism.

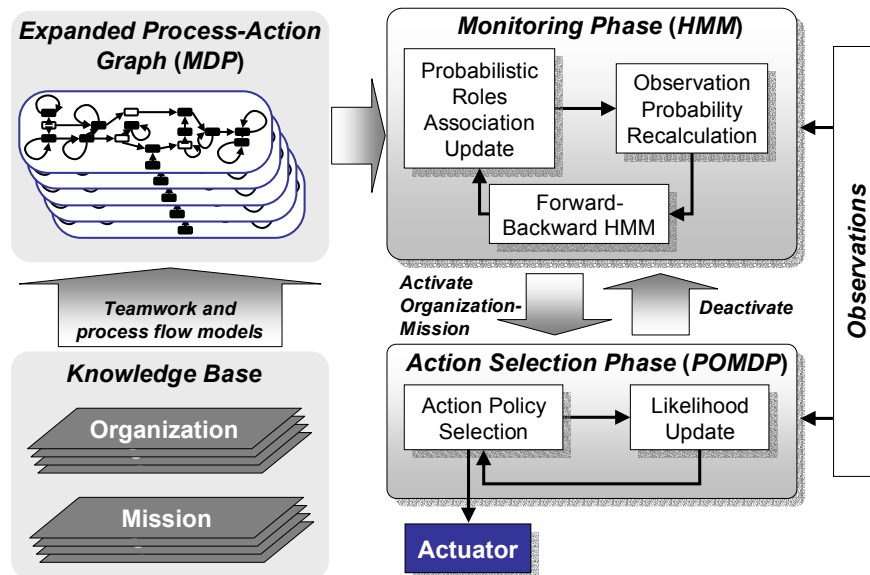

Figure 3: NetSTAR Monitoring and Action Selection phases

### 3.5 Monitoring and Action Selection Phases

A first problem that arises in structure identification is to establish the true process workflow performed by the enemy. Unless this is attained, the BLUE team cannot conduct its operations, else it risks achieving no effects (or even undesirable effects) while wasting its resources. Note that throughout the mission, an enemy organization might evolve its command, resource, and roles distribution. Therefore, constantly tracking the enemy structure is essential to BLUE's success. The same relates to the goal model (meta-graph) of the enemy organization, the actual goals currently being performed (meta-tasks), and the individual processes. To resolve this, NetSTAR proposes to utilize an iterative procedure consisting of two phases (Figure 3): (1) monitoring phase; and (2) action selection phase. The *monitoring phase* identifies the most probable organizational structure and processes generating the observed behavior (event data, tracked agents/cells and activity data), while *action selection phase* suggests counteracting measures to be applied to collect more information (ISR probes) and/or disrupt enemy activities (interventions). These two phases correspond, respectively, to the situation assessment and shaping phases; they will be implemented sequentially, with the monitoring phase preceding the action selection phase and (re)initiating the monitoring phase with the arrival of new data, interventions and deliberate probing. The action selection phase will be initiated when:

- The pattern of enemy activity is deemed dangerous with a high probability; in this case, confidence is high that the assessed enemy organizational structure, and the concomitant operational processes are active; in this case, interventions are needed to disrupt the enemy;

- Confidence in the assessed enemy organizational structure and the processes is low; in this case, probes are needed to obtain additional information to increase the confidence in situation assessment.

#### *A. Monitoring Phase via HMM Solution*

In NetSTAR’s monitoring phase, the BLUE tracks and determines the structure and processes that are most likely to generate the observed enemy behavior. We model the enemy activities (process-action graph substructure of the objectives/meta-task graph) as a Markov Decision Process (MDP), where actions correspond to friendly probes and intervention activities. The meta-task substructures of the enemy correspond to Markov transition graphs (this part of the process-action graph is also called process workflow of RED team) in the absence of BLUE actions. Consequently, we apply HMM modeling techniques to establish the most probable RED structure and processes (correspondingly, organization-mission pairs) that caused the observations. The forward HMM algorithm is modified to include the iterative update of the probability that a specific agent/node is observed conditioned on the role of the actual active agent, update of the observation (emission) probability, and subsequent forward-backward recalculations. The method adjusts the role probabilities to maximize the likelihood of the HMM structure and parameters, and is terminated when no improvement is possible. When the likelihood of the best HMM is above a user-specified threshold, we declare the corresponding HMM to be active, and proceed to the “action” phase.

#### *B. Action Phase via POMDP Solution*

In the action selection phase, knowledge about the RED organization and workflow process is assumed to be given (certainty equivalence assumption). NetSTAR calculates the action policy using the POMDP formulation, where the basic state model is the MDP corresponding to the organization, mission, and the meta-task decomposition selected in the “monitoring” phase. Based on the current estimate of the state, the POMDP-based control policy identifies the actions that the BLUE team must perform (probing, intervention) in order to counteract the RED team. The policy is represented in the form of a AND/OR decision tree or graph, where the OR nodes are the states, and AND (decision) nodes are the BLUE actions. Note that some of the actions of the BLUE organization might involve activities to gather more information about the RED to establish more certainty about the currently active RED structure and processes. The policy obtained using the solution for a specific POMDP formulation is propagated to the feasible POMDPs that correspond to other structure/mission pairs. As a result, we again obtain the Markov transition graphs and can track the likelihood of those HMMs compared to the HMM corresponding to the current organization/mission pair. When the current model becomes inactive (probability goes below a user-specified threshold) or another HMM is more likely, we stop the action phase and return to the “monitoring” phase.

### **4. Example of Methodology Application to Identify JTF Organization**

In this section, we illustrate the NetSTAR modeling approach on the example related to Adaptive Architectures for Command and Control (A2C2) Experiment 8 conducted at Naval Postgraduate School using Distributed Dynamic Decision-making (DDD) simulator (Kleinman *et al.*, 2003). Without loss of generality, we apply our process to identify the friendly (JTF) organization. During human-in-the-loop experiments, we experimented with multiple organizational configurations and different missions, and collected the communication data from commander interactions (asset request, information request/communication, acknowledgement,

synchronization request, etc.) and events data (what tasks are done, when, by what decision makers, what resources/assets used, etc.) (see (Diedrich *et al.*, 2003) for more info about data collection). In this section, we describe what organizations and missions were used in the experiment, and how the NetSTAR process can be applied to identify what organization and mission are currently active given a streaming set of observations (events and transactions data) from the collected communication data and events. In the following, we make multiple simplifications from the original Experiment 8 to avoid unnecessary complexity.

In the Experiment 8, we conducted multiple runs for two distinct types of the organizations – Divisional (with assets uniformly distributed among commanders) and Functional (with assets distributed to create unique functional commanders). The runs utilized two distinct mission types – “**d**” and “**f**”, where the former was “matched to” (congruent with) Divisional organization and “mismatched with” (incongruent to) Functional organization. Reverse was true for “**f**” mission scenario (see (Kleinman *et al.*, 2003) for more details). The difference between “**d**” and “**f**” is only in the resources that are required to execute the tasks. This means that while the goals (meta-tasks) are geographically the same for each mission, their meaning is different (methods to achieve these goals are different). In our human-in-the-loop simulations, we used multiple human teams to effects of individual biases. Since rarely any two human organizations perform alike, we might need to consider adding each such instance to the KB. However, considering abstract organizations would be enough to illustrate the proposed concepts.

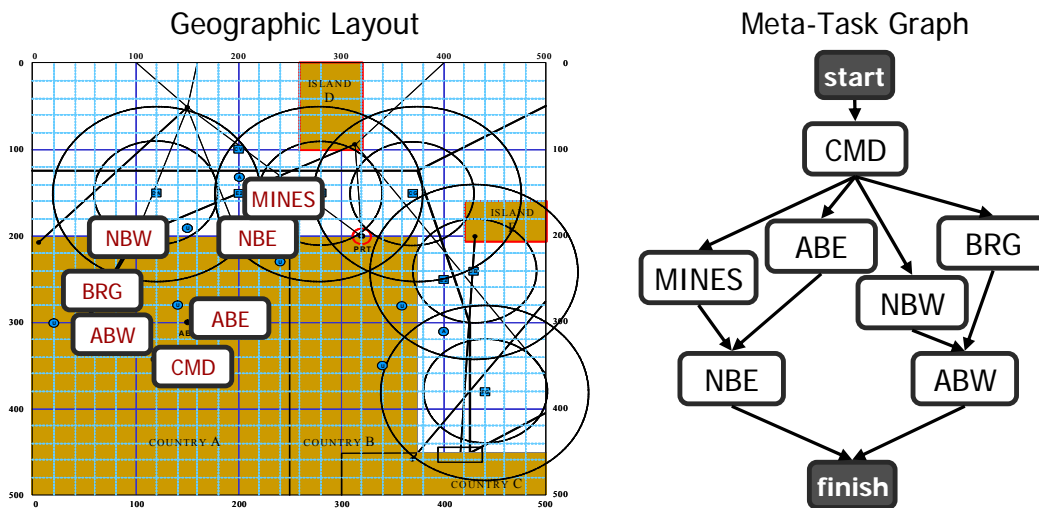

**Figure 4:** Mission geographic layout and meta-task graph (same for “**d**” and “**f**”)

Mission consists of 7 meta-tasks: CMD (eliminate Command Center), BRG (blow bridge), NBE (take Naval Base-East), NBW (eliminate Naval Base-West), ABE (take Air Base-East), ABW (eliminate Air Base-East), and MINE (clear Mines in port)

*Step 1: Creating Knowledge Base.* We start by hypothesizing that the knowledge base consists of two missions – “**d**” and “**f**” (parameters of simplified missions are depicted in Figures 4-5) and two organizations – “Divisional” and “Functional” (simplified organizations are depicted in Figure 6).

f scenario					d scenario						
Name	Description	Mines	ASuW	Strike	SOF	Name	Description	Mines	ASuW	Strike	SOF
CMD	Command Center	0	0	0	2	CMD	Command Center	0	0	1	1
BRG	Blow Bridge	0	0	1	0	BRG	Blow Bridge	0	0	1	1
NBE	Naval Base-East	0	2	0	2	NBE	Naval Base-East	0	1	1	0
NBW	Naval Base-West	0	0	6	0	NBW	Naval Base-West	1	0	3	1
ABE	Air Base-East	0	0	0	3	ABE	Air Base-East	0	0	0	3
ABW	Air Base-West	0	0	6	0	ABW	Air Base-West	0	0	2	1
MINE	Clear Mines	2	0	0	0	MINE	Clear Mines	1	1	0	0

Figure 5: Task resource requirements for “d” and “f” missions

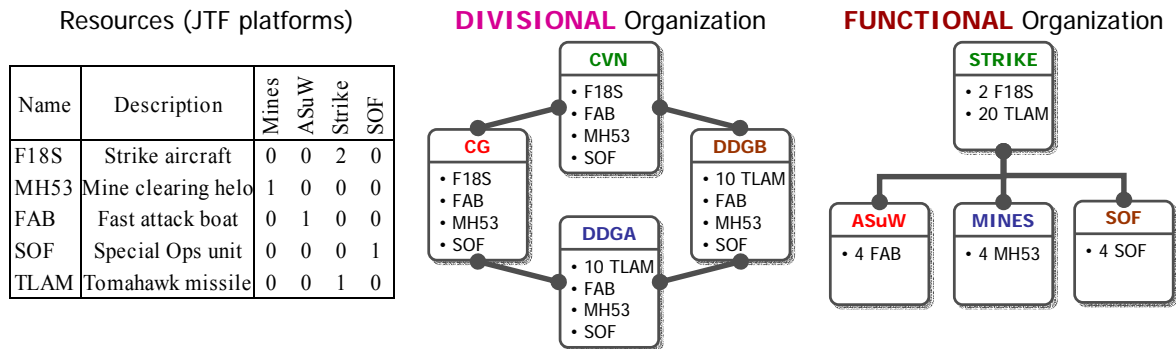

Figure 6: Divisional and Functional organizations

There are 5 assets in the organization. 4 functional capability areas are modeled: Mines (mine clearing), ASuW (anti-surface warfare), Strike (ground strike), and SOF (special operations forces)

*Step 2: Simulating Organizational Behavior.* In this phase, we run our TOD simulation process to generate activity/communication transactions and events data for each organization and mission pair from the Knowledge Base. In this example, our approach is based on decomposing meta-tasks into actions based on decision-action-assessment process loop depicted in Figure 7. Accordingly, the simulator generates multiple action and communication transaction sequences (e.g., see Figure 8) for each organization-mission pair. The diversity is due to alternatives in executing actions due to overlap in resource capabilities, responsibilities of organizational nodes, and uncertainty in preferences of the team members, and is captured by the TOD simulator.

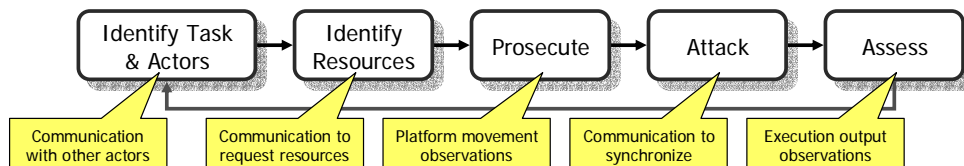
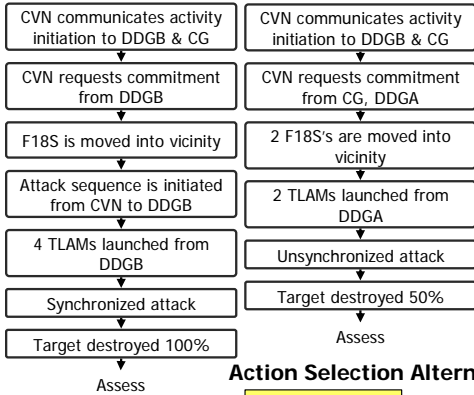

Figure 7: Decision-Action-Assessment process loop

## DIVISIONAL Organization

Primary Commander: **CVN**  
Secondary Commander(s): **DDGB or CG & DDGA**



## FUNCTIONAL Organization

Primary Commander: **STRIKE**  
Secondary Commander(s): none

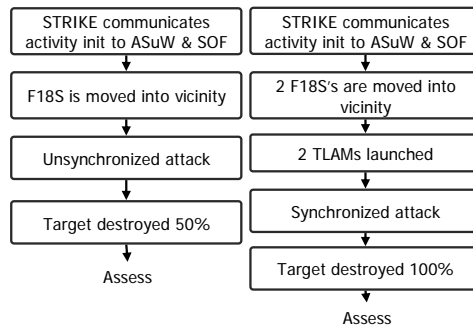

### Action Selection Alternatives: Activity Generation Reasoning

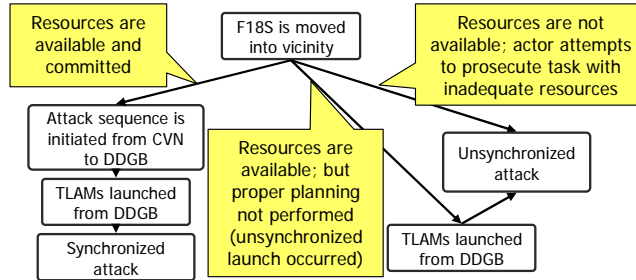

**Figure 8:** Example of action-communication and event transactions sequences generated by TOD for meta-task NBW (eliminate Naval Base-West) of scenario “f”

*Step 3: Learning Behavior Patterns.* In this step, we utilize the learning phase of NetSTAR process to learn the Markov transition graphs or HMM patterns of activities from the transaction sequences generated in the previous step. This phase is essential in creating the compact representation of activity patterns to identify the active organization-mission pair via matching these activity patterns against real-time observations in the monitoring phase. Figure 9 shows the example of learned Markov Chain pattern of Divisional organization activity for a single meta-task of scenario “f”. The full pattern for the whole mission (full meta-task graph) will be generated by merging individual meta-task activity patterns.

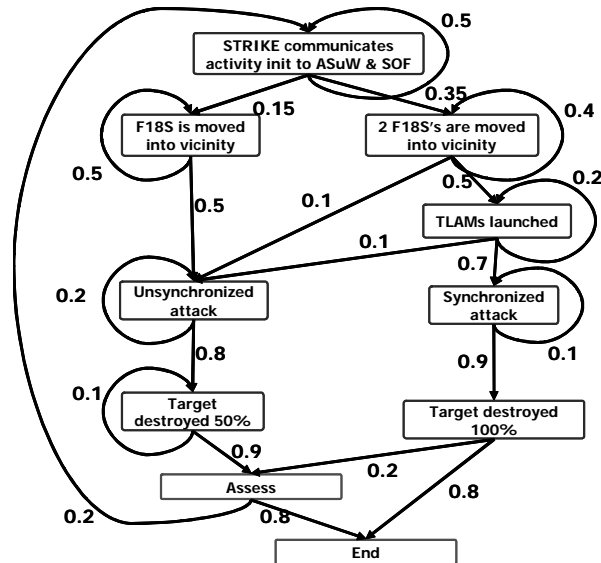

**Figure 9:** Example of learned Markov Chain pattern of Divisional organization activity for a single meta-task of scenario “f”

*Step 4: Group Identification.* This step identifies the subgroups within the total set of RED nodes under surveillance that are actively collaborating toward a mission. The essence of this step is to match the

observations to a single organization. In the example presented in this section, we assume that the observations correspond to a single organization, and the identities of the agents and/or cells are known (while their true roles/places in the organization are not).

*Step 5: Identifying Active Organization-Mission.* In this step, we utilize the monitoring phase of NetSTAR process to match the observation stream with learned activity patterns. As the result, we can calculate the likelihood that organization is acting on specific mission for each pair from the knowledge base. First, we identify the probability of observations conditioned on true actions. Feasible observation classes are listed in Table I. A sequence of received observations and the matching (true) activities of Divisional organization that could have generated these observations are shown in Figure 10.

TABLE I: Example of observation classes

Class	Parameters	Remarks
Communication between actors	Initiators, Content (asset request; activity initiation; report; asset transfer), Duration	Roles/identities are not known
Launch and/or movement of platforms	Duration	
Engagement	Initiation; Resource discrepancies; Duration	
Task execution success	Success rate	
NULL		No observations

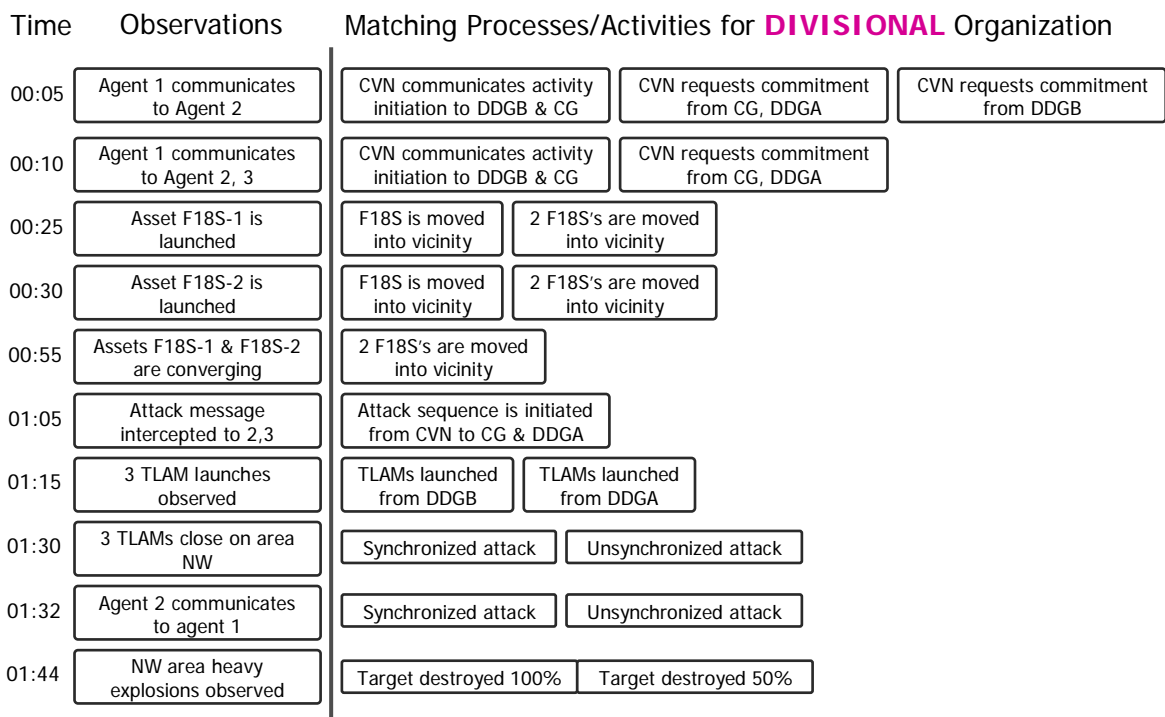

**Figure 10:** Sequence of observations received by NetSTAR system, and the matching (true) activities of Divisional organization

We apply the forward HMM algorithm to calculate the likelihood of observed sequence given the model (an activity pattern for organization-mission pair). Figure 11 shows the dynamic

graph of the conditional observation probabilities for 4 organization-mission activity models. The likelihood of the observation sequence is a quantitative measure of the confidence of the match between the observed events and transactions and the template models. The HMM determines whether the monitored activity exists. If the activity is consistent with the model derived in the step 3, then it is called detected. Note that a conflict of the activity patterns can result in multiple activities being active at the same time. This could also be modeled using multiple hypothesis tracking (Singh *et al.*, 2004).

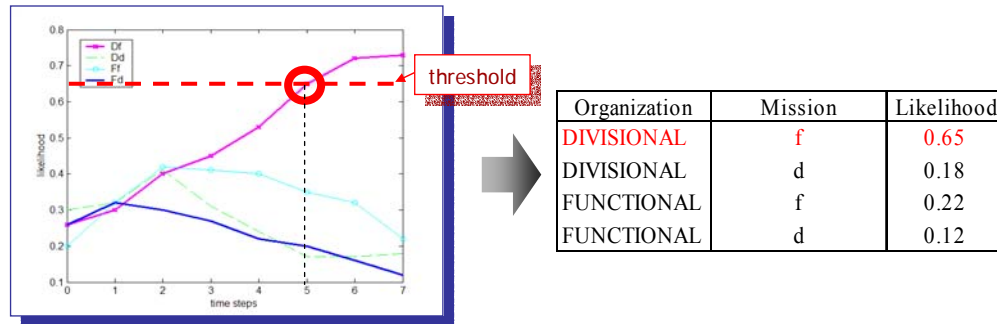

Figure 11: Example pattern matching in monitoring phase

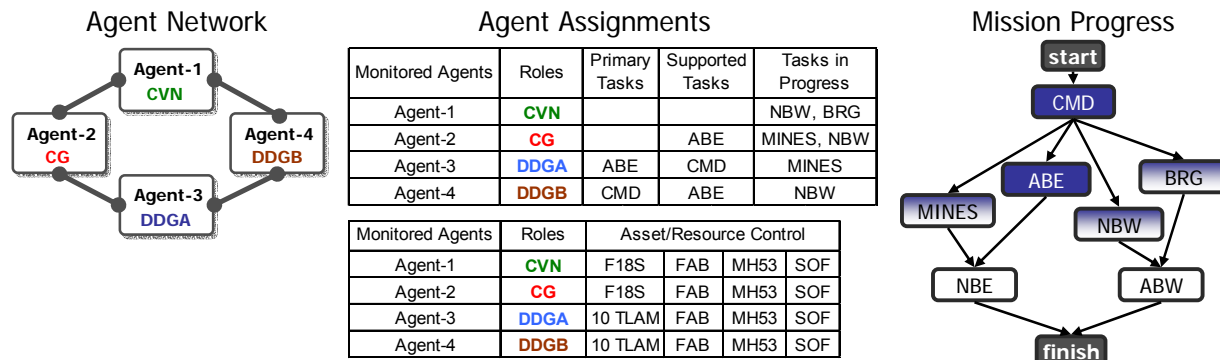

Figure 12: Example of outcome of monitoring phase: Divisional organization and its mission (in mission progress graph, blue color indicates the percentage of completion of a meta-task)

The organization-mission pair is selected to maximize the observation likelihood, for which the resource assignment, agent roles, task assignment, and mission progress is obtained (Figure 12). Task assignment and mission progress can be obtained by identifying the highest-probable activity sequence that generated the observation sequence.

## 5. Conclusions and Future Validation Mechanisms

This paper presents a novel methodology that utilizes the historic operational knowledge and dynamically observed events and communications data to identify the processes and structure of the opposing organization, its objectives, mode of operation, and execution policy. Proposed approach requires empirical validation of the NetSTAR model, which we propose to proceed in three successive rigorous stages: *laboratory*, *historical*, and *operational*. The **laboratory validation** will leverage experimental data obtained through the Advanced Architectures for Command and Control (A2C2) program sponsored by the Office of Naval Research (McMillan *et al.* 2002). This research generated a set of human-in-the-loop experiments (see for example (Diedrich *et al.*, 2003), (Entin *et al.*, 2003), (Kleinman *et al.*, 2003)) in which cadets at the Naval

Postgraduate School participated in a joint military operations using the *Distributed Dynamic Decision-making* simulation platform (Kleinman *et al.*, 1996). During each experimental trial, complete data were recorded as to the roles and resources of the team members, communications between decision makers, and the actions carried out by the team. From this data we can extract the chatter levels and isolated events within the team, which will then be input into the NetSTAR algorithm to test its ability to reconstruct the true mission and structure of the team. The **historical validation** will focus on testing the ability of NetSTAR to accurately identify the structure and activities of a known RED organization whose true (current) structure and activities are now known. Finally, the **operational validation** will evaluate NetSTAR against a current RED organization whose structure and activities are unknown. This form of validation will entail a longitudinal study in which the accuracy of NetSTAR is continuously re-evaluated as new information becomes available.

## References

- Diedrich, F., E. Entin, S. Hutchins, S. Hocevar, B. Rubineau, and J. MacMillan, "When Do Organizations Need to Change – Part I: Coping with Organizational Incongruence", *International Command and Control Research and Technology Symposium*, Washington, DC, June, 2003.
- Entin, E., F. Diedrich, D. Kleinman, B. Kemple, S. Hocevar, B. Rubineau, and D. Serfaty, "When Do Organizations Need to Change – Part II: Incongruence in Action", *International Command and Control Research and Technology Symposium*, Washington, DC, June, 2003.
- Kleinman, D. L., P. Young, and G. S. Higgins, "The DDD-III: A Tool For Empirical research in Adaptive Organizations", *Proceedings of the 1996 Command and Control Research and Technology Symposium*, Monterey, CA, June, 1996.
- Kleinman, D.L., G.M. Levchuk, S.G. Hutchins, and W.G. Kemple, "Scenario Design for the Empirical Testing of Organizational Congruence", to appear in *International Command and Control Research and Technology Symposium*, Washington, DC, June, 2003.
- Levchuk, G.M., Chopra, K., Levchuk, Y. and Paley, M. (2005). "Model-based Organization Manning, Strategy, and Structure Design via Team Optimal Design (TOD) Methodology". To appear in *Proceedings of the 10th International Command and Control Research and Technology Symposium*, McLean, VA, June, 2005.
- MacMillan, J., Paley, M.J., Levchuk, Y.N., Entin, E.E., Serfaty, D., and Freeman, J.T. (2002). "Designing the Best Team for the Task: Optimal Organizational Structures for Military Missions", In Mike McNeese, Ed Salas, and Mica Endsley (editors), *New Trends in Cooperative Activities: System Dynamics in Complex Settings*. San Diego, CA: Human Factors and Ergonomics Society Press.
- Meirina, C., Y.N. Levchuk, G.M. Levchuk, K.R. Pattipati and D.L. Kleinman (2002), "Goal Management in Organizations: A Markov Decision Process (MDP) Approach," submitted to *IEEE Trans. On Systems, Man and Cybernetics: Part A - Systems and Humans*, September.
- Pattipati, K., Willett, P., Allanach, J., Tu, H., and Singh, S. "Hidden Markov Models and Bayesian Networks for Counter-Terrorism", in "21st Century Enabling Technologies and Policies for Counter-Terrorism", Robert Popp and John Yen eds. (in press).
- Popp, R., K. Pattipati, P. Willett, H. Tu, J. Allanach, S. Singh, W. Stacy, D. Serfaty, K. Carley (2004). "Collaboration and Modeling tools for Counter-Terrorism analysis," *CIHSPS*, July 2004.
- Singh, S., Allanach, J., Tu, H., Pattipati, K., and Willett, P. (2004) "Stochastic Modeling of a Terrorist Event via the ASAM system", *IEEE Conference on Systems, Man and Cybernetics*, The Hague, The Netherlands. Oct 10-13.





## **NetSTAR: Identification of Network Structure, Tasks, Activities, and Roles from Communications**

Georgiy Levchuk<sup>(1)</sup>, [georgiy@aptima.com](mailto:georgiy@aptima.com)  
Kari Chopra<sup>(1)</sup>, [kchopra@aptima.com](mailto:kchopra@aptima.com)  
Krishna Pattipati<sup>(2)</sup>, [krishna@engr.uconn.edu](mailto:krishna@engr.uconn.edu)

**(1)Aptima, Inc.**

**(2)University of Connecticut**

- The problem: notional scenario
- The need: design problem
- NetSTAR system process
- HMM-based activity modeling
- Previous work
- Next steps
- Example

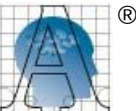

# Notional Scenario

- **Mission:** US SOF assist the army of Urbanistan (AOU) in their spring offensive against the territories held by the militant rebel coalition called True Sons of Urbanistan (TSU).
- **Situation:** TSU irregulars are well concealed in towns and mountains of their Liberated Zone. Extensive system of tunnels and caves. Porous borders with neighboring countries.
- **Friendly intel capabilities:** US multi-INT capabilities plus Urbani Intelligence Service's extensive HUMINT.
- **Enemy Command and Control:** TSU is led by a network of several disparate organizations, ranging from informal cells to military structure.
- **Plan of the offensive:** AOU forces penetrate the Liberated Zone along 4 avenues of approach. NLT H+72 seal the borders. Defeat larger units of TSU with the help of US air assets and AOU armor. NLT H+240 force TSU fighters into several base towns. Isolate and conduct clean-up operations.

## ■ Current info on Enemy C2:

- #136: .....
- #137: Abbadirov – commander of the Lions Brigade. Former Soviet Spetsnaz officer. Style of command decision-making: influenced by traditional Soviet.
- #138: Lions Brigade Staff: 10-12 people, some with FSU military training.
- #139: Commander, Mountain Martyrs Detachment (name unknown). Uses cell system. Supported by an influential deputy and 2-3 senior advisers.
- #140: Bobbimov: manages a logistics cell of 5-10 “brain” people in Gosh across the Ruralstan border. Supplies the Lion Brigade and sometimes the Mountain Martyrs.
- #141: Qashcow Tribal Council: 10-15 people, control up to 200 local fighters. Report to Abbadirov but often stays neutral.
- #142: Gollyadov: Field Commander of semi-independent formation. Staff of 4-7 competent personnel. Coordinates with Mountain Martyrs.
- #143: .....

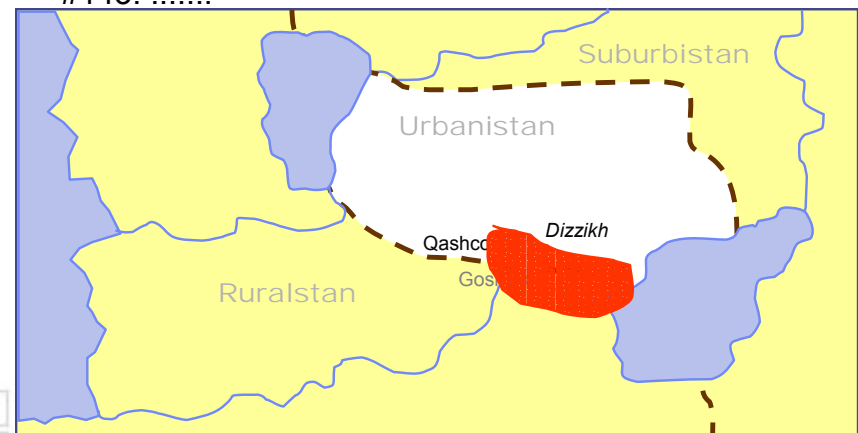

# Notional Scenario: Threats and Opportunities

---

## Threats to the AOU Offensive Plan:

- Massive exfiltration of TSU into the Dizzikh region
- Rapid concentration in well-defended town of Eddiren
- Cross-border instigation of uprising in Ruralstan's town of Gosh
- .....

## Feasible AOU Actions to Impact TSU C2:

- Feint advance toward the Qashcow tribal center.
- Precision elimination of Abdykadirov's Deputy
- Temporary disruption of comms between Gollyadov and Qashcow
- Disinformation about defection of Bobbimov to Government
- .... And about 50 other possibilities

## Questions:

1. What combination and timing of actions would yield best observables to improve our knowledge of the TSU C2 structure?
2. What combination and timing of actions will best reduce the effectiveness of TSU C2 and minimize the threats to AOU plans?

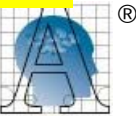

- Need to **disrupt activities of the enemy**
- Consider enemy military with **significant** Command and Control (C2) organization
- TO **act** against enemy effectively, need to know:
  - What the enemy **IS**?
    - → Enemy C2 **structure**, roles, actors, resources
  - What the enemy **WANTS TO DO**?
    - → Enemy **goals/objectives**
  - What the enemy **DOES**?
    - → Enemy **actions**
- Need: **System Identification-like Models**
  - Focus on **what organization is** rather than *how it can be changed*

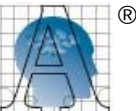

# How it is done today?

- What is available:
  - Manual procedures for analyzing enemy C2 decision-makers, processes, impacts
  - Commercial tools for data collection and visualization
  - Static networks topology metrics tools
  - Targeting heuristics (centrality, in-between-ness, etc.)

Remarks	Decision Reform Party (good guys)	Society for the preservation of our rights (wingnuts)	Farmer's alliance (not peasant group)	People's Democratic Society (peaceful moderate)	Insurgent Company	New Liberation Movement (political front for N.M.E.)	N.M.E.	Name of individual
Warrant Outstanding Leader in the insurgent co. Possible pit cdr. or co cdr.					●	●	●	Johnston, S.D. alias "The Red"
Possibly linked to death squad activities.	●	●						Garra, N.A.
Mayor, ineffective due to war-torn town.	●							Mulvihill, P.
Possible pit leader.	○		●	●	○	○		Daniels, P.
Regional governor.	●	○	●	●				Jenkins, T.L.
Warrant Outstanding Tactical genius, principal trainer of insurgent co.			○		●	●	●	Cormier, J.
					●	●	●	Webb, C.
					○	○	○	Seipel, B.
Leader in the insurgent co. Pit leader or XO.			○		●	●	●	Trollinger, L.

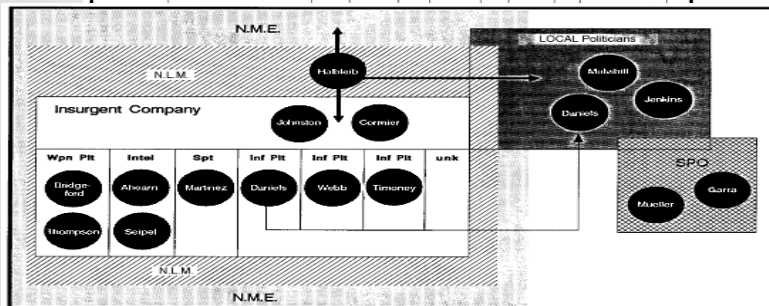

Figure 3-3-10. Link diagram.  
Army FM34-130

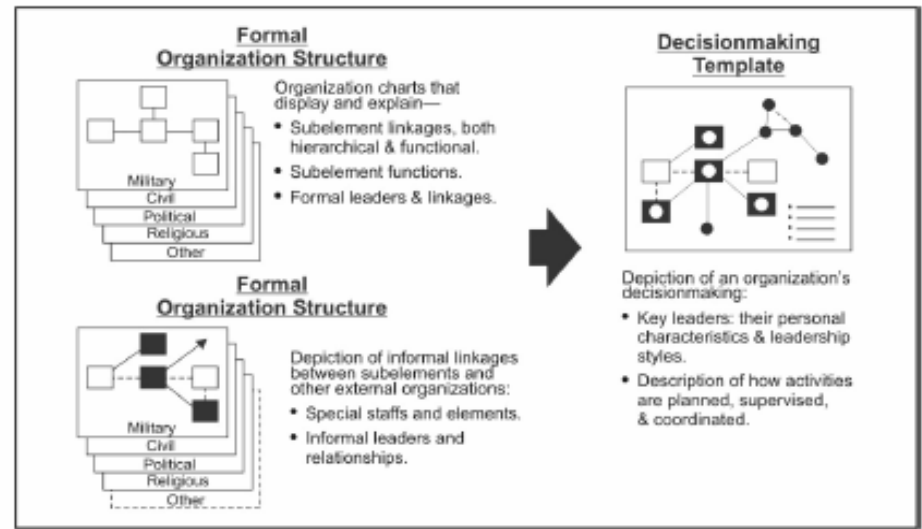
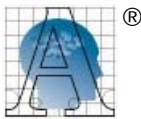
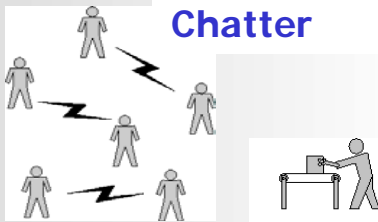

Figure 5-3. Sample Information Operations Doctrinal Template

Army FM 3-13, Information Ops



# Problem Identification



**Chatter**



**Events**

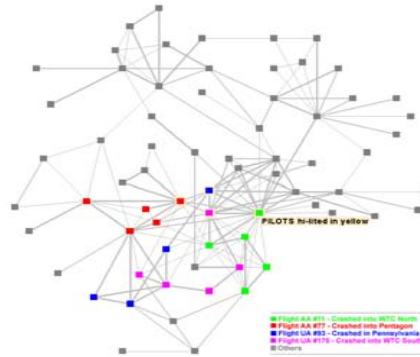
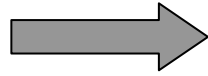

**Question:**

Given what we can observe about an enemy, can we determine its underlying structure and activities?

**Answer:**

**NetStar** system for identification of **Network Structure, Activity and Roles**  
Leverages models, algorithms, and test data from A2C2 program

**Basis: A2C2 Experiments**

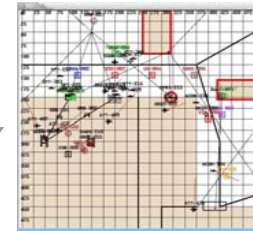
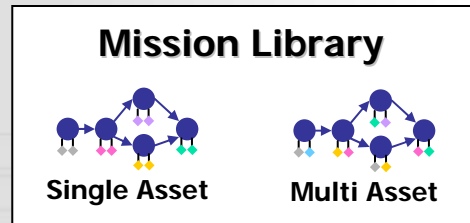
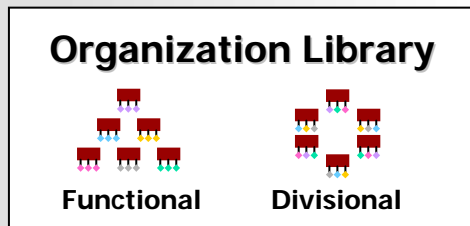

Human-in-the-loop simulations: Distributed Dynamic Decision-making (DDD) Simulator

**Activity Log**

Agent	Start	End	Action
PARK	1401.10	1410.43	Clear mines
GARCIA	1405.07	1412.32	Blow bridge

**Communications Transcript**

Sender	Receiver	Start	End	Content
KLEIN	PARK	1400.03	1400.07	"Can you clear out those mines?"
PARK	KLEIN	1400.10	1400.12	"I'm on it."



## Mission

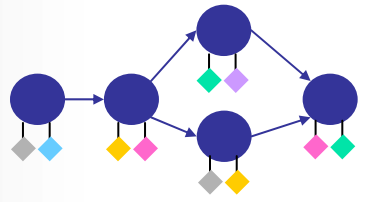

**X**

**=**

## Activity Pattern

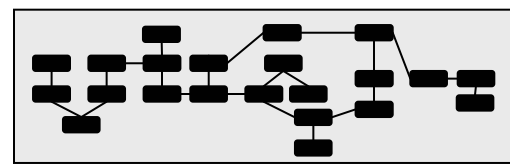

## C2 Organization

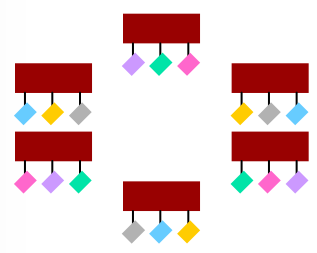



# NetSTAR Workflow

Previous A2C2 Research

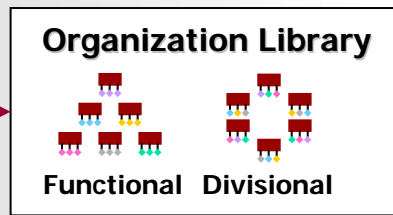

**RED Military Team:  
Process/Activity  
Models**

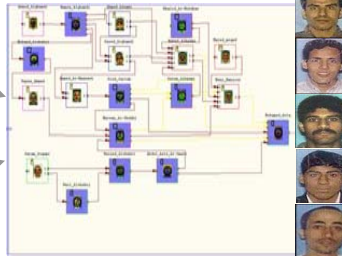

- Khalid Almihdhar
- Majed Moqed
- Nawaf Alhazmi
- Salem Alhazmi
- Hani Hanjour

**Human-in-the-loop simulations:  
Distributed Dynamic Decision-  
making (DDD) Simulator**

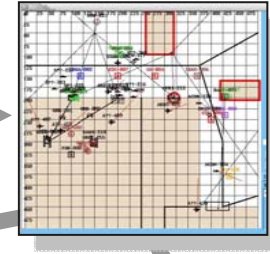

**Activity Log**

Agent	Start	End	Action
Khalid	1401.10	1410.43	Explosives Acquisition
Majed	1405.07	1412.32	VBIED Attack

**Communications Transcript**

Sender	Receiver	Start	End	Content
Khalid	Majed	1400.03	1400.07	"Prepare Explosives"
Majed	Khalid	1400.10	1400.12	"I'm on it."

**Proposed NetSTAR Research:  
Reverse Engineering**



**Observed Events**

Agent	Start	End	Action
Khalid	1401.10	1410.43	Explosives Acquisition
---	---	---	---

**Chatter Levels**

Sender	Receiver	Start	End	Content
Khalid	Majed	1400.03	1400.07	... "explosives" ...
Majed	Khalid	1400.10	1400.12	---

**Message Decoding**

**Activity Involvement**

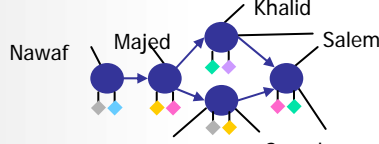

**C2 Organization**

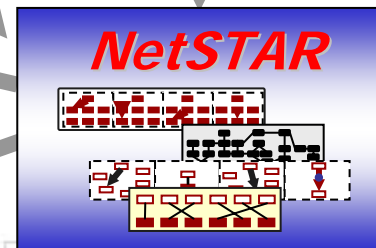
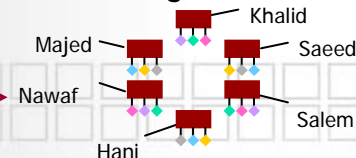

**Reconstruct the mission,  
organization and roles**

COMPARE

COMPARE

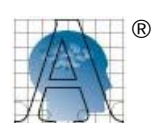

# NetSTAR Process

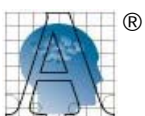
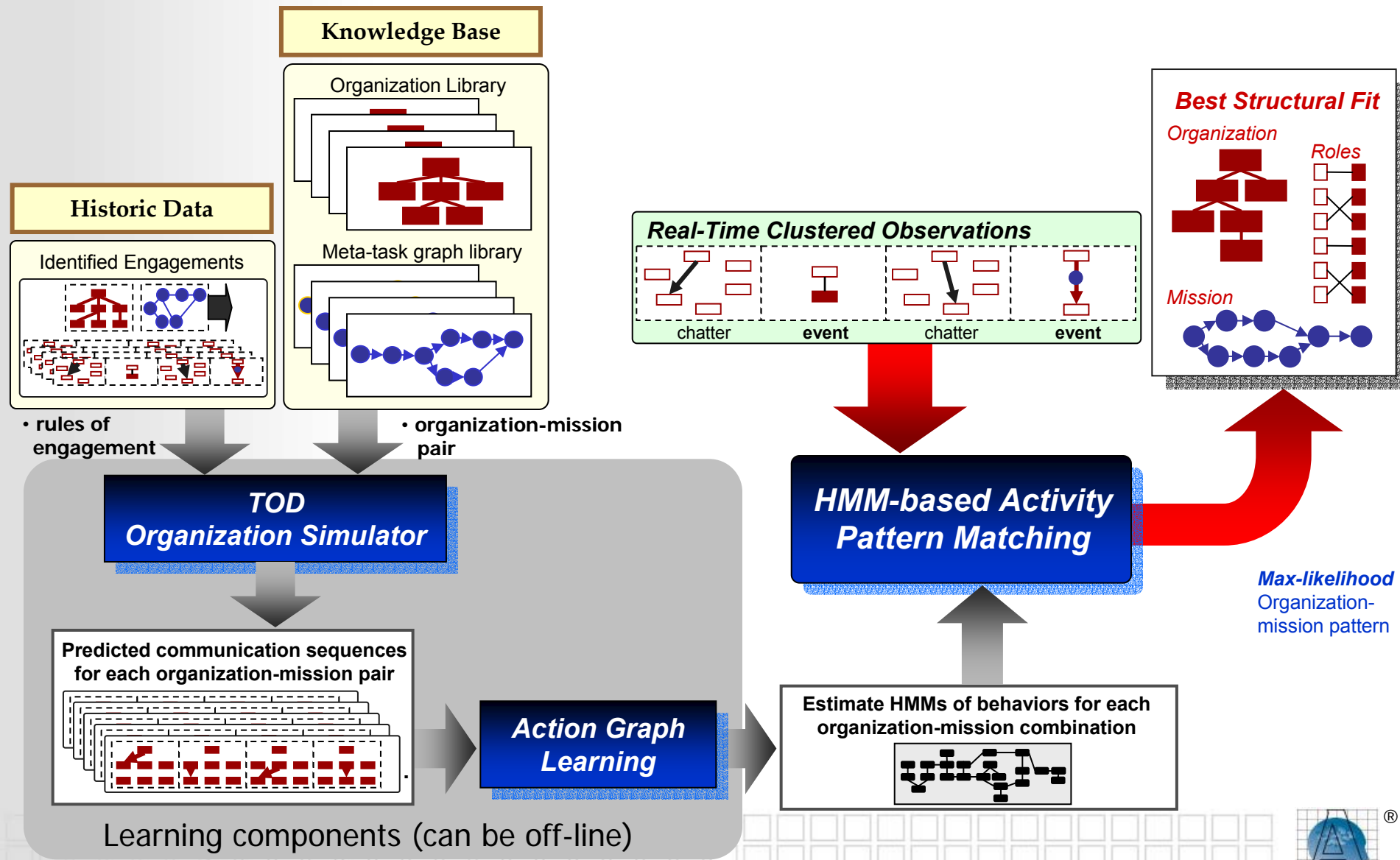

# Can Activities be Modeled?

## Are there Distinguishable Patterns?

- Yes!!!
- Why?:
  - Patterns/templates of “how to achieve a purpose”
  - Sub-activities depend on one another
    - Precedence
    - Parallelism
    - Geo-dependence
    - Timed dependence
    - Input-output (influence)
    - ...
  - People follow patterns in their daily routines
  - C2 organization **MUST FOLLOW PATTERNS** due to its design – constraints on
    - Who can do what
    - Who communicates to whom
    - Who owns what
    - Who supports whom
    - Who has authority over whom

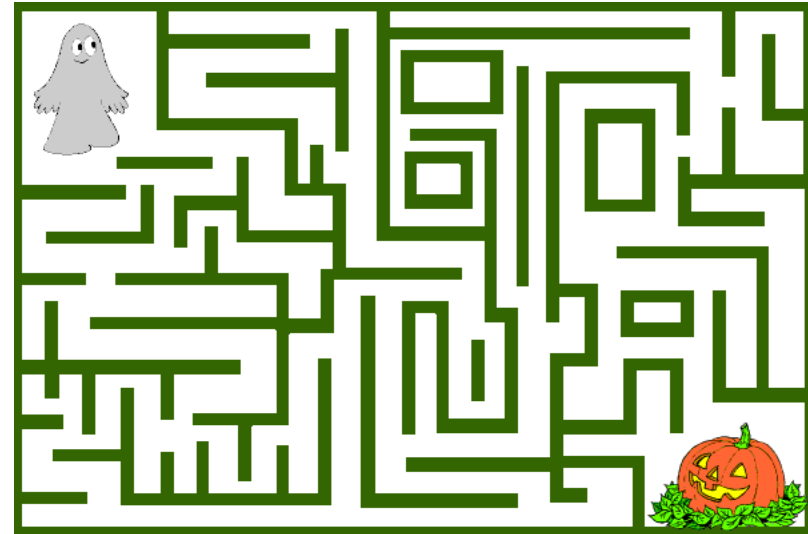

# Activity Structure Modeling

## Global Intention & Behavior Matching

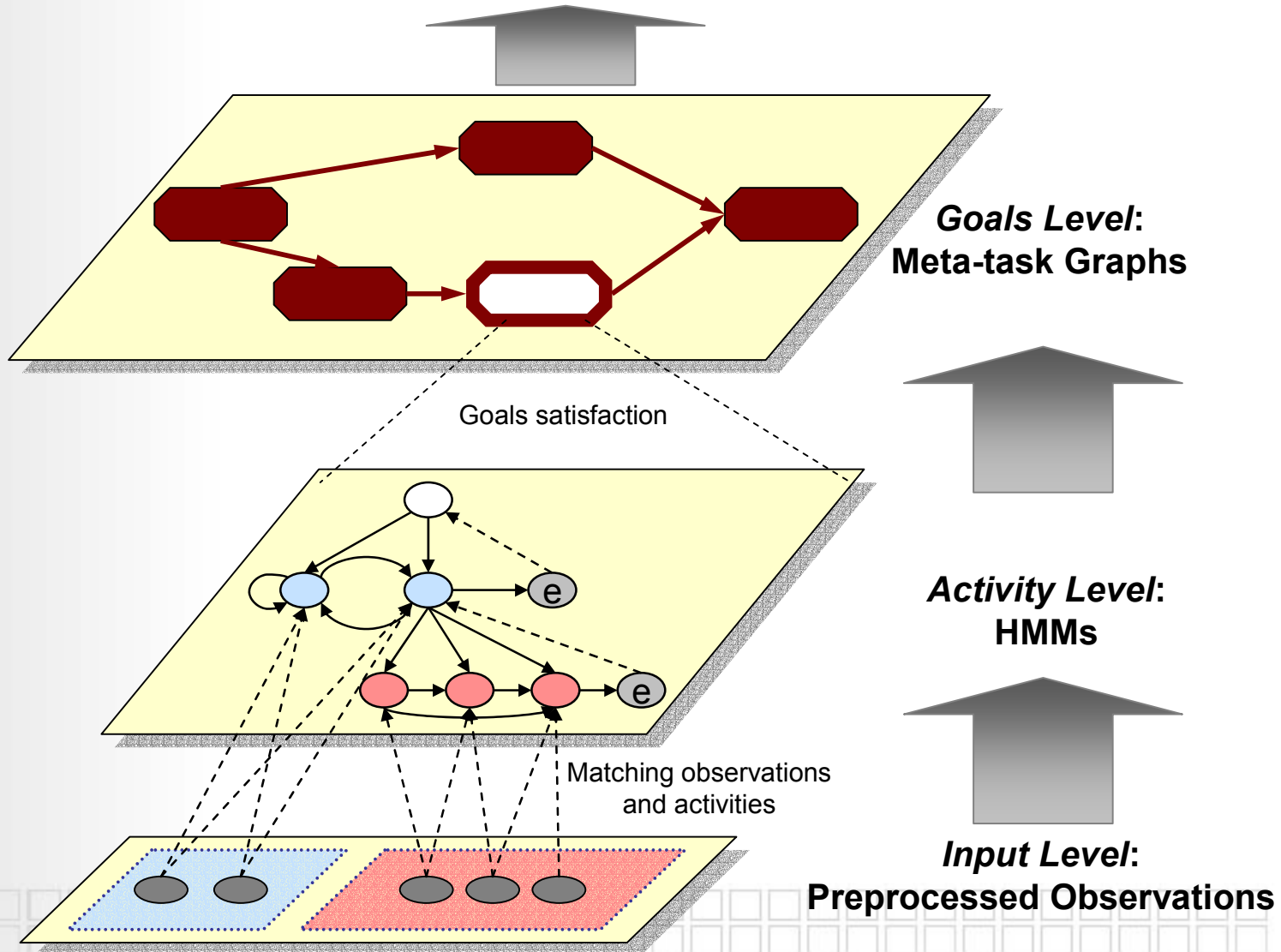

# Why Hidden Markov Models?

- Model relationships between
  - **Hidden events**
  - **Hidden true patterns** of events (event structure)
  - **Observations** which are uncertain representations of true events

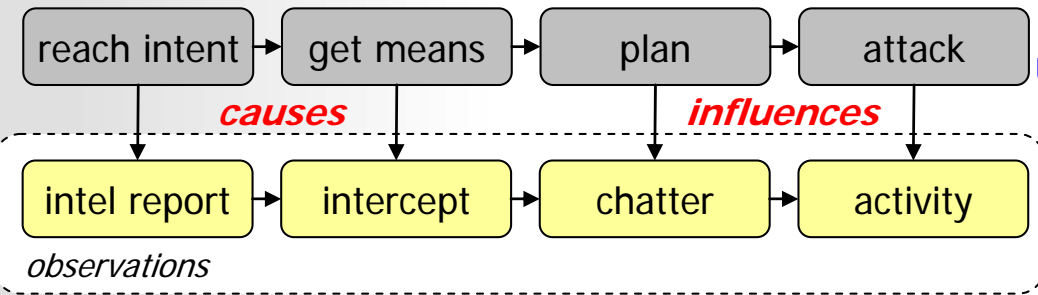

- Question:
  - Can I know what is true from what I see?
- Rephrase:
  - What model explains my observations better?
  - What actually happened in that model?

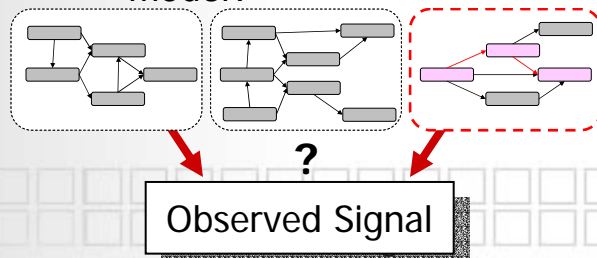

- HMMs can
  - Identify most likely **event pattern that produced observations**
  - Identify the most likely set of **true (hidden) events that occurred**
  - **Learn the pattern** structure and parameters given multiple realizations (event/observation sequences)

## Specific Uses

- Voice/speech recognition
- Image (e.g. handwriting, faces, etc.) recognition
- Signal detection
- Activity detection, environment evolution
- Control systems
- Segmentation of DNA sequences and gene recognition
- Stock data analysis

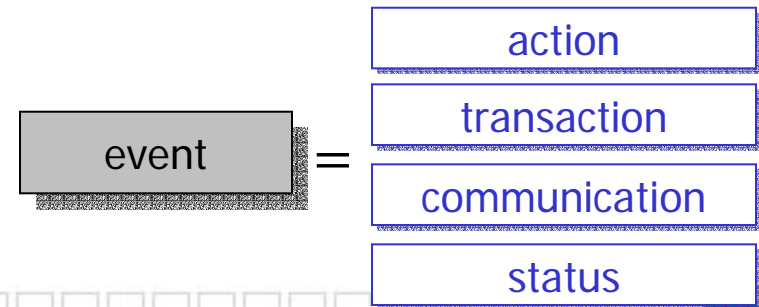

# Issues in Activity Modeling (continued)

## ■ HMMs can model

- Time dependence (duration)
- Absence of observations
- Multiple observations
- Observation from possibly multiple sources
- Influence between events
- Alternative events
- Parallel, sequential events
- Constraints in time, geography, etc. resulting in changed sequencing of events

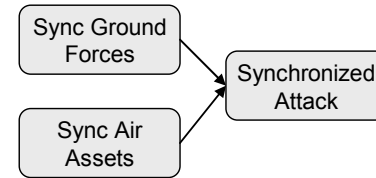

(a) Temporal constraints

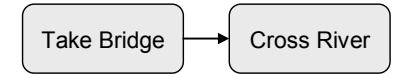

(b) Sequential implementation

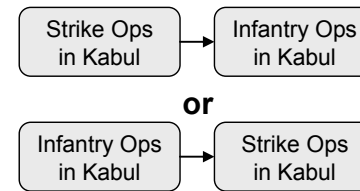

(c) Spatial constraints

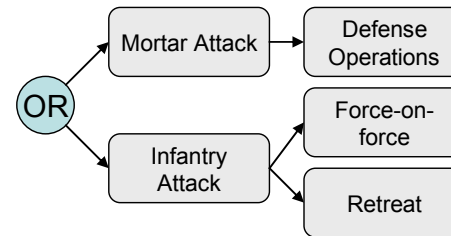
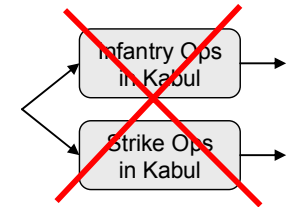

(d) Influence & alternatives

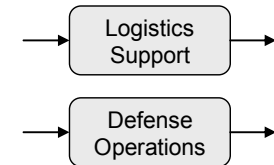

(e) Parallel

# Modeling Methodology: Coupled, Hierarchical & Layered HMMs

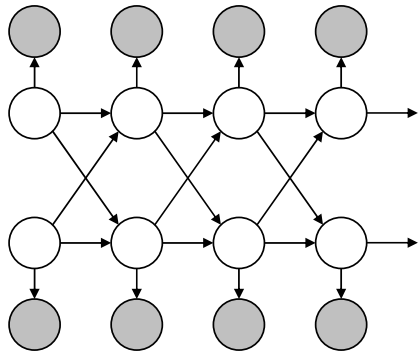

(a) Fully-coupled HMM

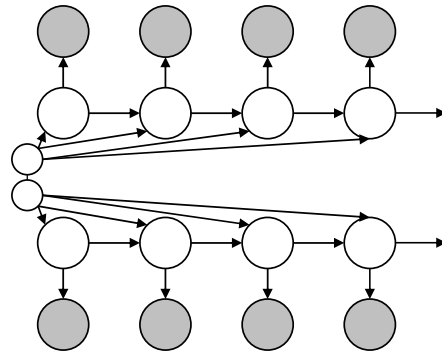

(b) Event-coupled HMM

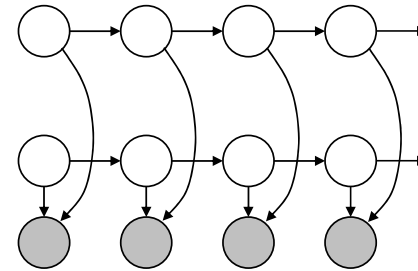

(c) Factorial HMM

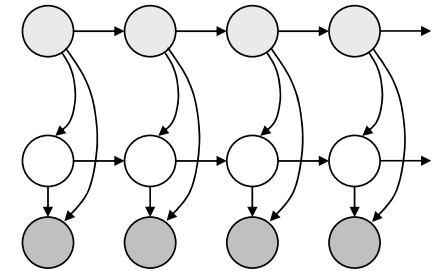

(d) Input-output HMM

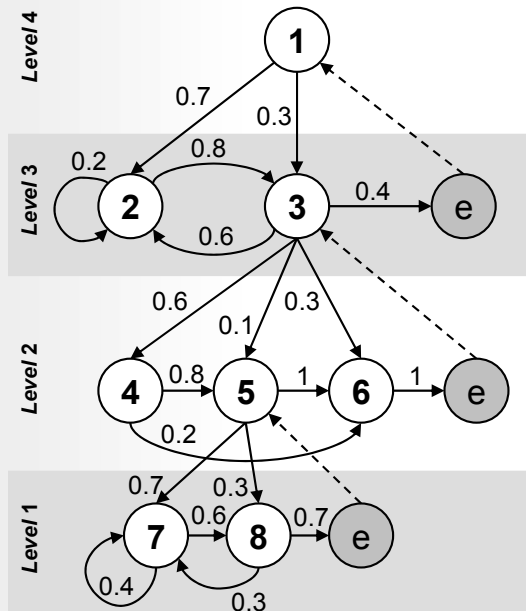

(a) Hierarchical HMM

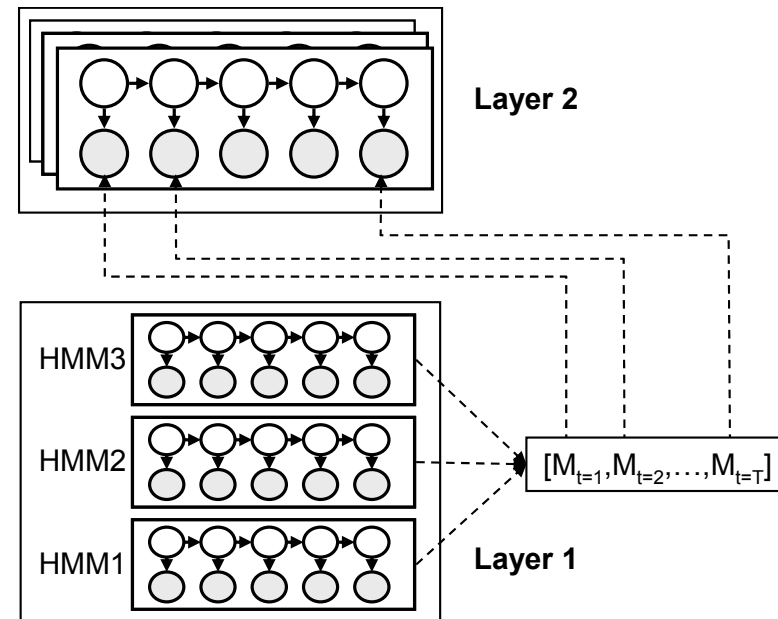

(b) Layered HMM

# Previous Work (Aptima/UConn)

## A2C2 Experiments

- Reverse-engineered missions and organizations to test congruence concepts
- Conducted multiple human-in-the-loop experiments
- Simulated models predicted the patterns of human performance

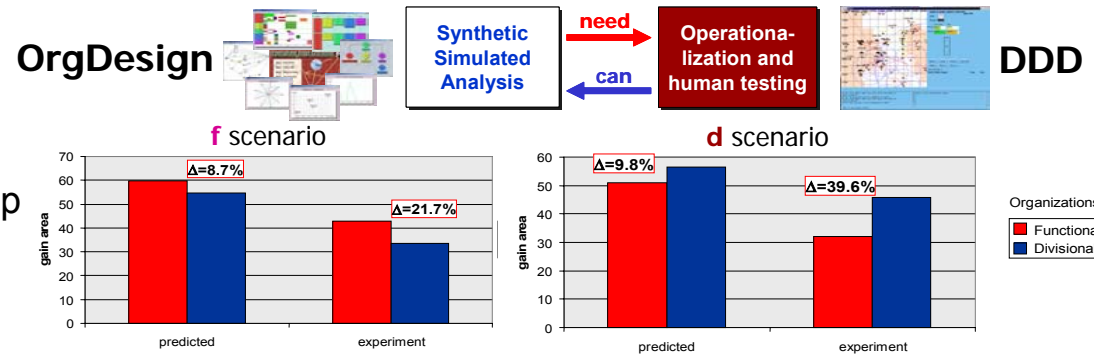

## Synthetic agent development & calibration

- Integrated OrgDesign synthetic agent with DDD
- Obtained comparable results for human-in-the-loop and agent runs

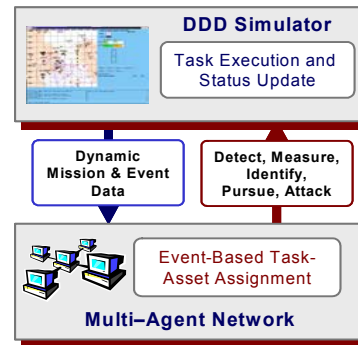

## Comparison between Human and Agent Performance

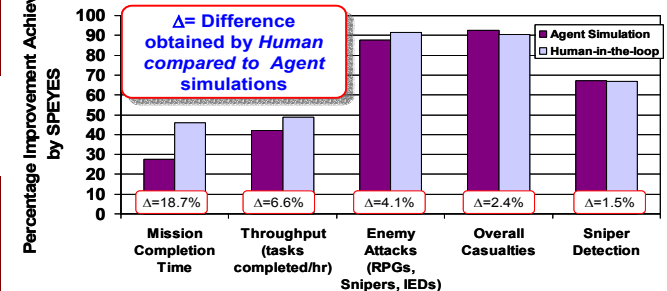

## NEMESIS-ASAM (Adaptive Safety Analysis and Monitoring)

- Predict possible existence & evolution of the terrorist activities from noisy transactions data
- Identify threats (via ASAM detection schema) & suspicious persons (via feature-aided tracking)
- Develop models based on real world events or open source information

- Indian Airlines Hijacking Model
- Greece Olympics Threat Model

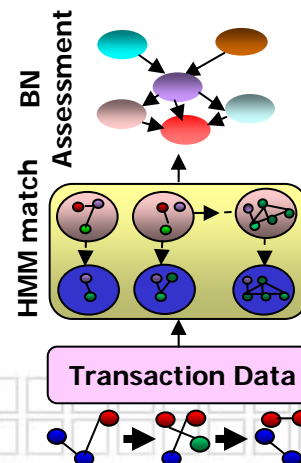



# NetSTAR Monitoring-Action Integration

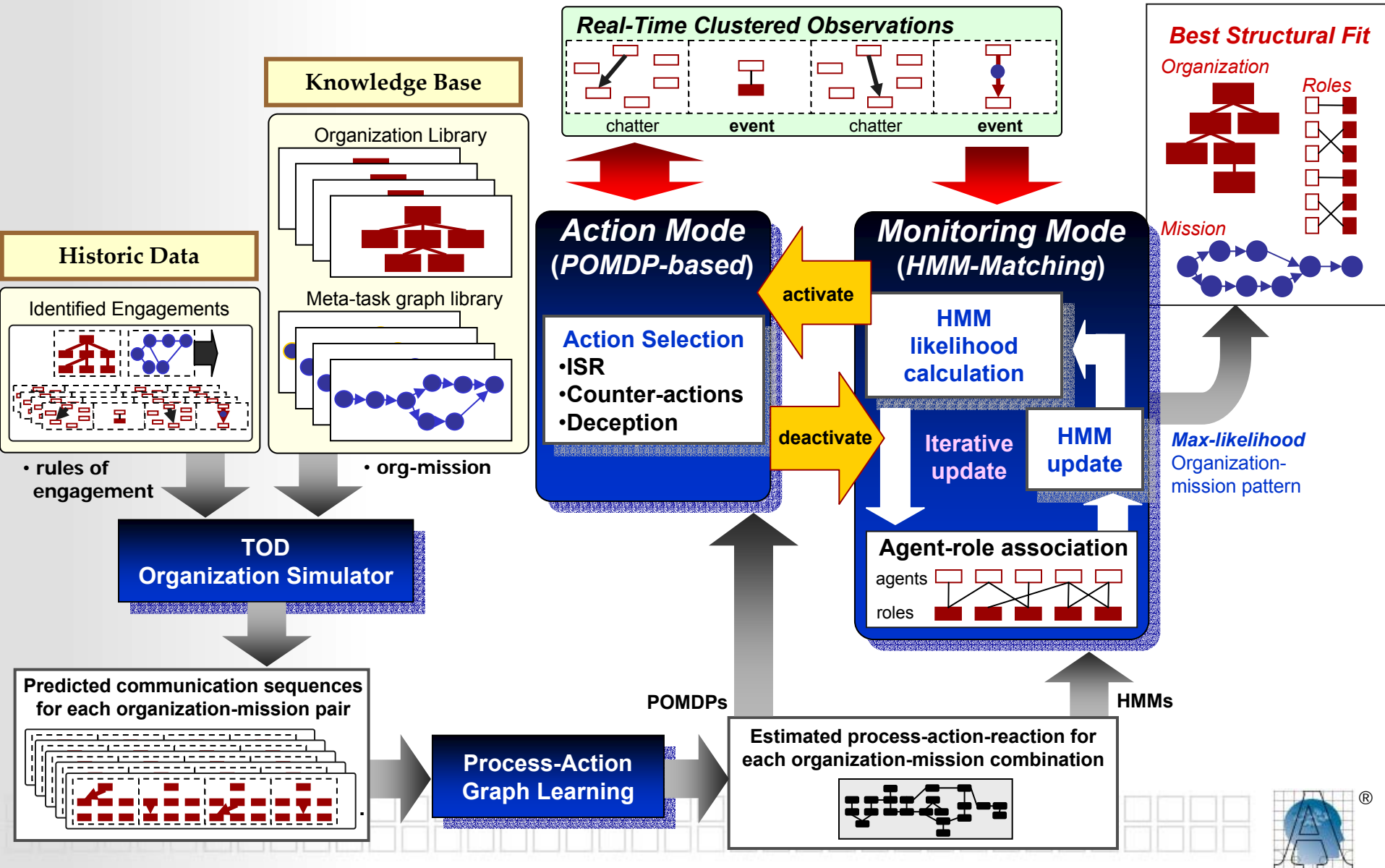

# Example: Problem Setup

## Two Organizations

Command Network and Resource Control Structure

Resources (JTF platforms)

**DIVISIONAL** Organization

**FUNCTIONAL** Organization

Name	Description	Mines	ASuW	Strike	SOF
F18S	Strike aircraft	0	0	2	0
MH53	Mine clearing helo	1	0	0	0
FAB	Fast attack boat	0	1	0	0
SOF	Special Ops unit	0	0	0	1
TLAM	Tomahawk missile	0	0	1	0

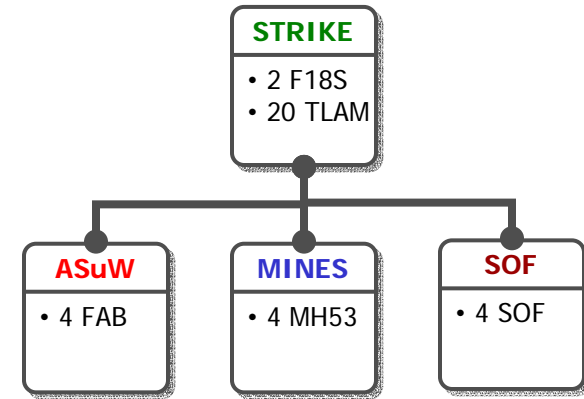
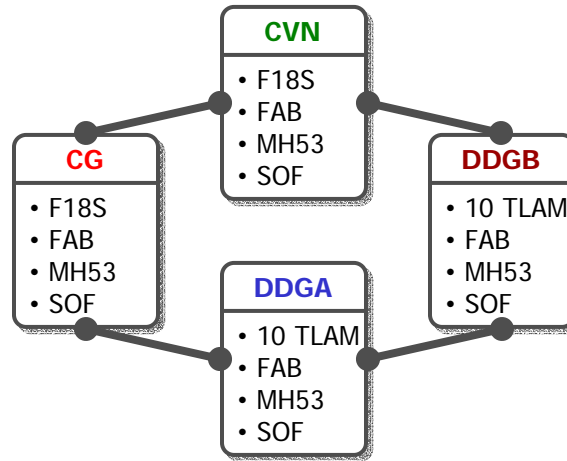

## Two Missions

Task Decomposition

Task Resource Requirements

Geographic Layout

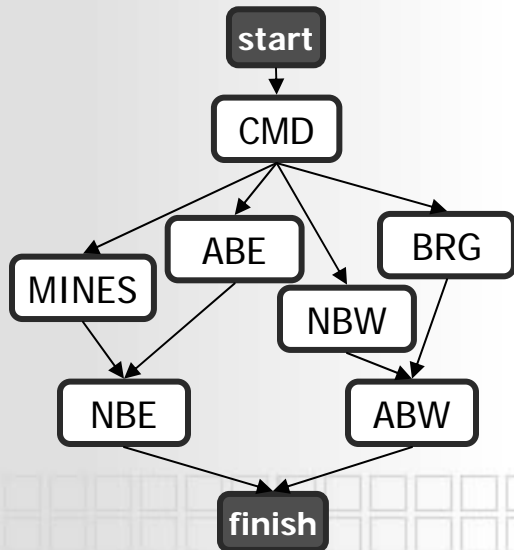

**d** scenario

Name	Description	Mines	ASuW	Strike	SOF
CMD	Command Center	0	0	1	1
BRG	Blow Bridge	0	0	1	1
NBE	Naval Base-East	0	1	1	0
NBW	Naval Base-West	1	0	3	1
ABE	Air Base-East	0	0	0	3
ABW	Air Base-West	0	0	2	1
MINE	Clear Mines	1	1	0	0

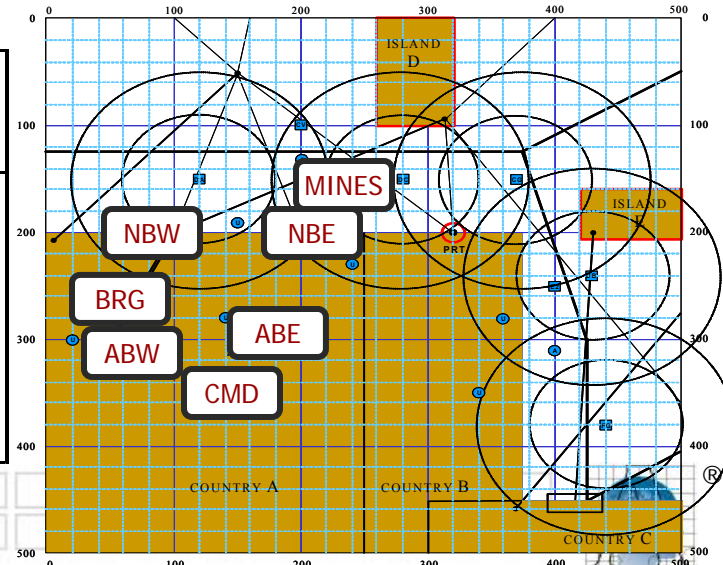

## Task-Activity Generated for "NBW" task

Bases: Decision-Action-Assessment Process Loop of C2 Organization

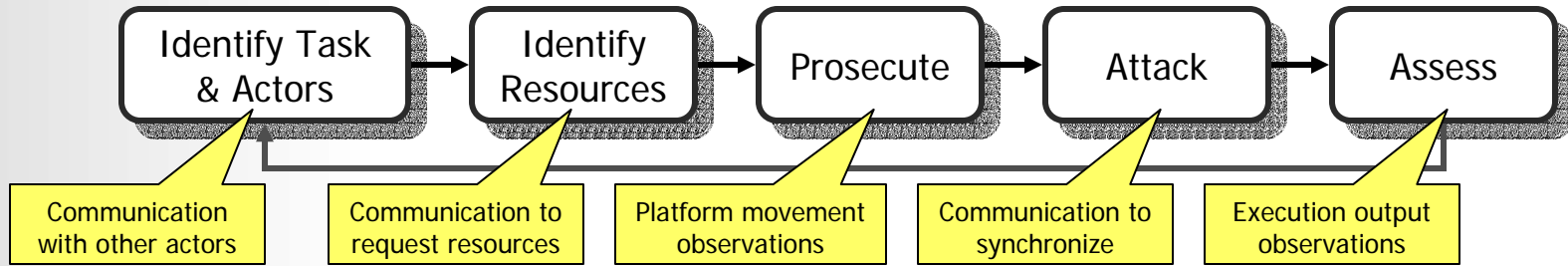

### DIVISIONAL Organization

Primary Commander: **CVN**  
Secondary Commander(s): **DDGB** or **CG & DDGA**

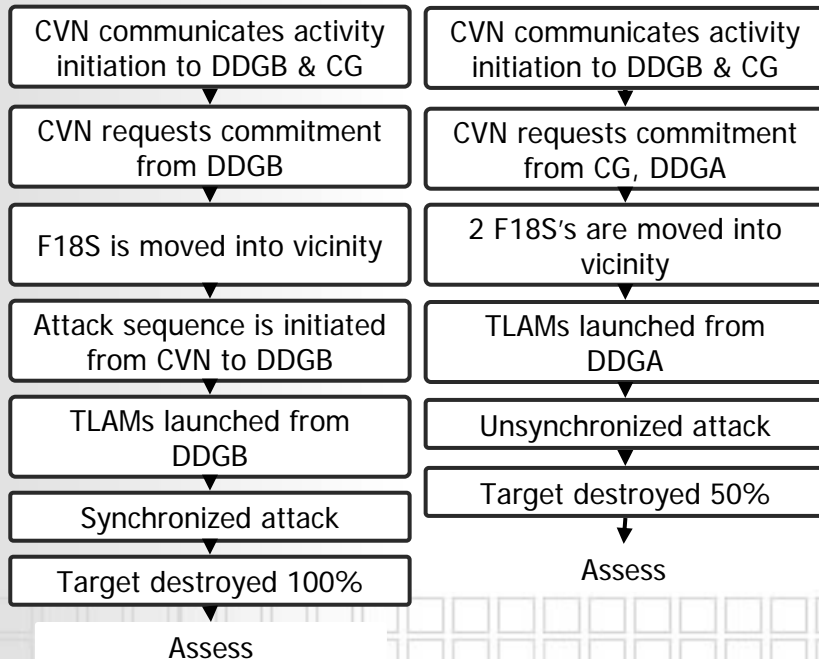

### FUNCTIONAL Organization

Primary Commander: **STRIKE**  
Secondary Commander(s): none

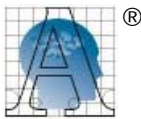
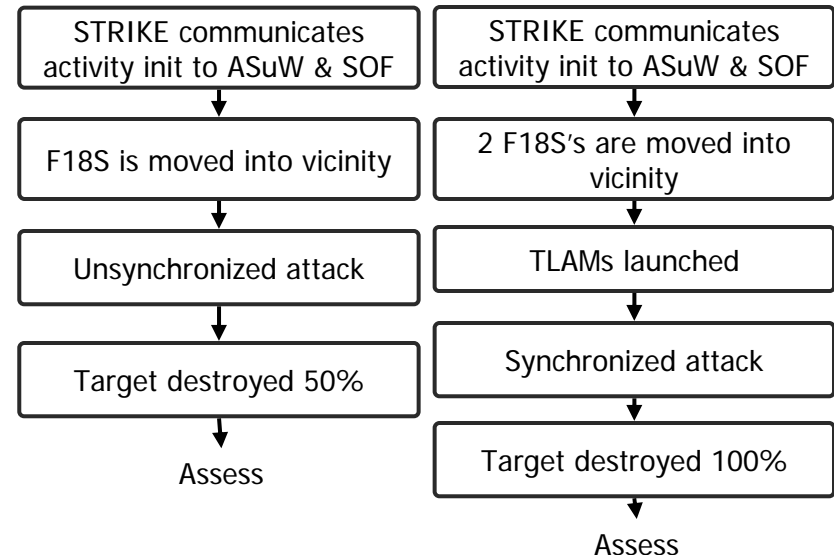

## NBW Task Activity Planning Modeling

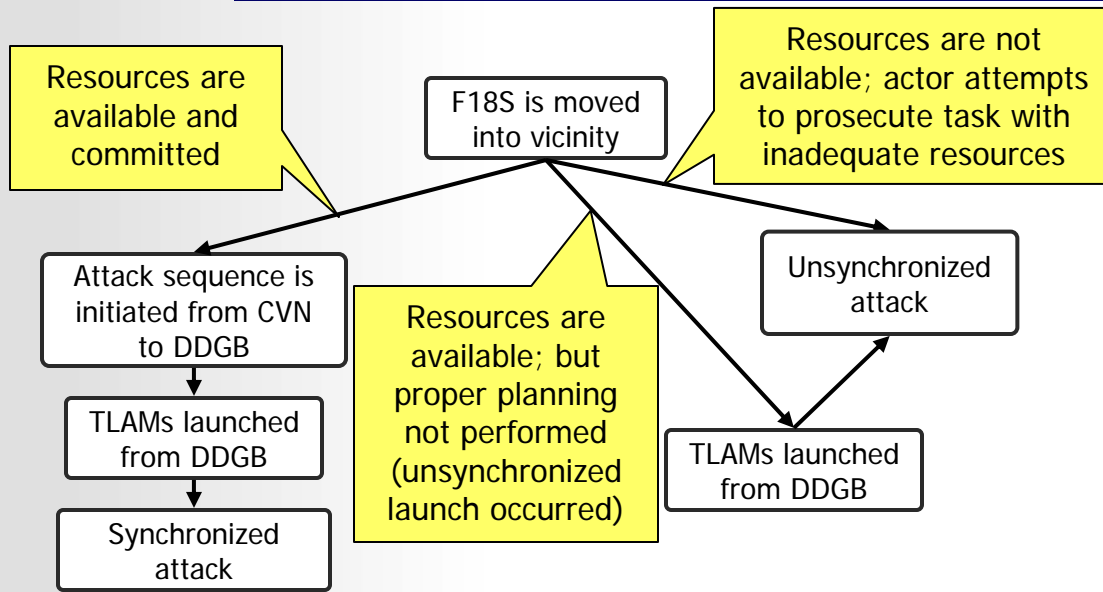

### Single-Level HMM Modeling

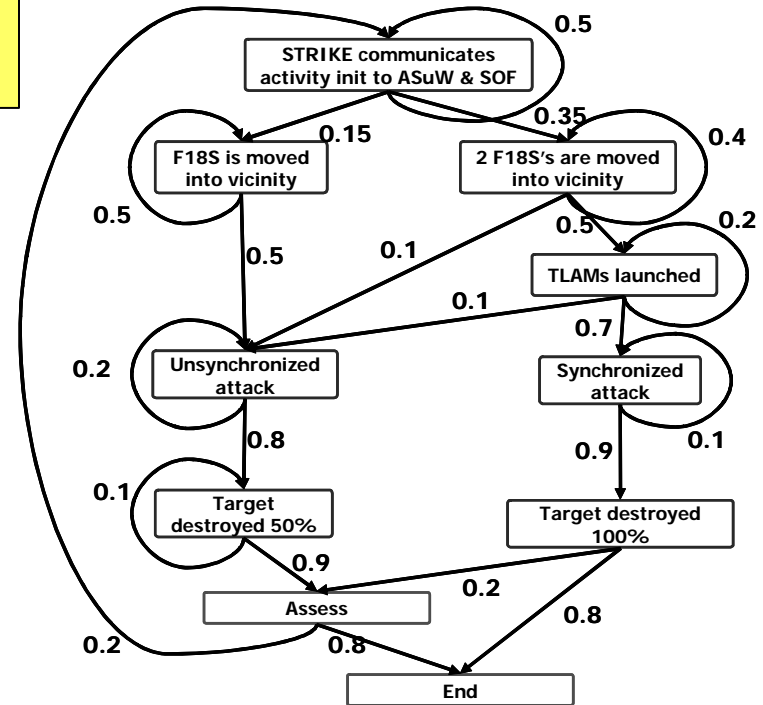

## Modeling to Explore Structure and Dependencies among Meta-Tasks

### Hierarchical (Layered) HMM Modeling

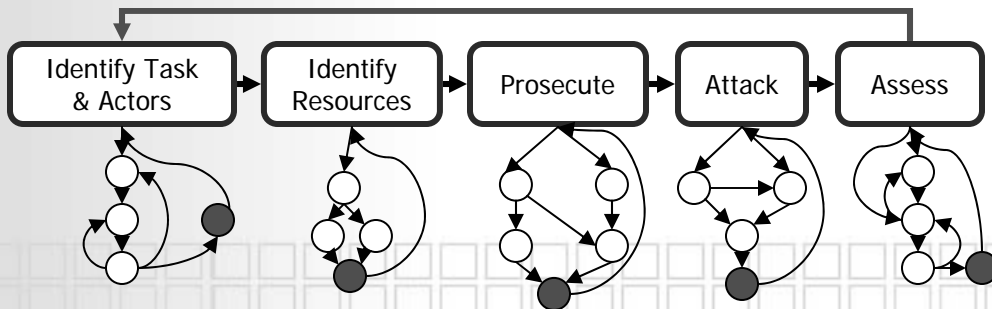

### Factorial HMM Modeling

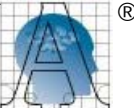
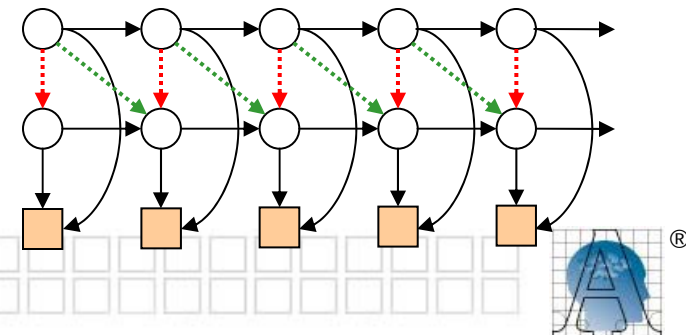

# Example: Observations

Time	Observations	Matching Processes/Activities for <b>DIVISIONAL</b> Organization	
00:05	Agent 1 communicates to Agent 2	CVN communicates activity initiation to DDGB & CG	CVN requests commitment from CG, DDGA
			CVN requests commitment from DDGB
00:10	Agent 1 communicates to Agent 2, 3	CVN communicates activity initiation to DDGB & CG	CVN requests commitment from CG, DDGA
00:25	Asset F18S-1 is launched	F18S is moved into vicinity	2 F18S's are moved into vicinity
00:30	Asset F18S-2 is launched	F18S is moved into vicinity	2 F18S's are moved into vicinity
00:55	Assets F18S-1 & F18S-2 are converging	2 F18S's are moved into vicinity	
01:05	Attack message intercepted to 2,3	Attack sequence is initiated from CVN to CG & DDGA	
01:15	3 TLAM launches observed	TLAMs launched from DDGB	TLAMs launched from DDGA
01:30	3 TLAMs close on area NW	Synchronized attack	Unsynchronized attack
01:32	Agent 2 communicates to agent 1	Synchronized attack	Unsynchronized attack
01:44	NW area heavy explosions observed	Target destroyed 100%	Target destroyed 50%

**Observations:**

- Communication between actors
  - Initiators
  - Content (asset request; activity initiation; report; asset transfer)
  - Duration
  - Roles/identities are not known
- Launch and/or movement of platforms
  - Duration
- Engagement
  - Initiation
  - Resource discrepancies
  - Duration
- Task execution success
- Null (no observations)

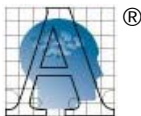

# Example: Results

## Active Monitoring

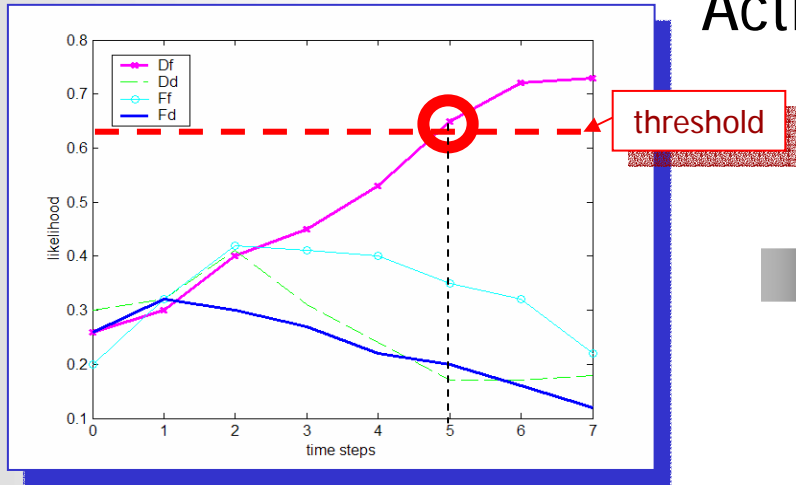

Organization	Mission	Likelihood
<b>DIVISIONAL</b>	<b>f</b>	<b>0.65</b>
DIVISIONAL	d	0.18
FUNCTIONAL	f	0.22
FUNCTIONAL	d	0.12

### Agent Network

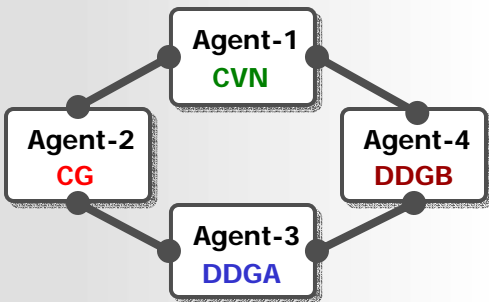

### Agent Assignments

Monitored Agents	Roles	Primary Tasks	Supported Tasks	Tasks in Progress
Agent-1	<b>CVN</b>			NBW, BRG
Agent-2	<b>CG</b>		ABE	MINES, NBW
Agent-3	<b>DDGA</b>	ABE	CMD	MINES
Agent-4	<b>DDGB</b>	CMD	ABE	NBW

Monitored Agents	Roles	Asset/Resource Control			
Agent-1	<b>CVN</b>	F18S	FAB	MH53	SOF
Agent-2	<b>CG</b>	F18S	FAB	MH53	SOF
Agent-3	<b>DDGA</b>	10 TLAM	FAB	MH53	SOF
Agent-4	<b>DDGB</b>	10 TLAM	FAB	MH53	SOF

### Mission Progress

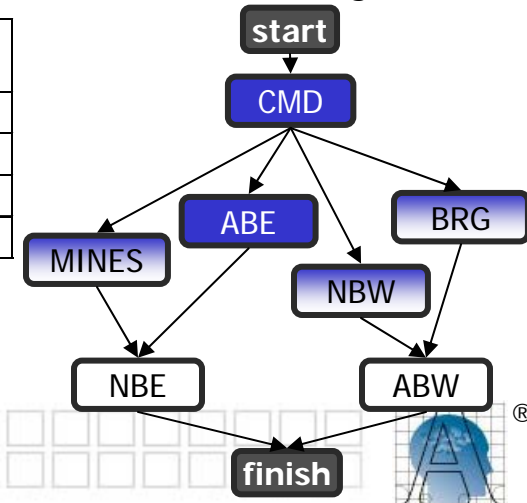

# Conclusions

---

- Proposed methodology to identify the organization structure and mission
- Based on activity matching
- Activities are modeled using Hidden Markov Models
- Future steps: integration with action component using Partially Observable Markov Decision Problem representation

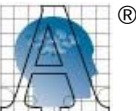

**THANK YOU!**

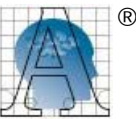
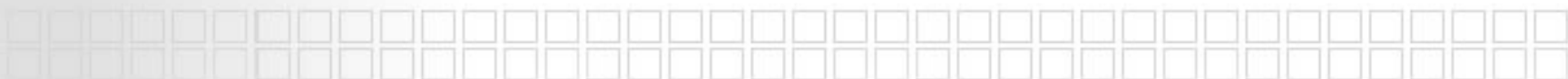



# Backups

---

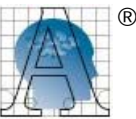
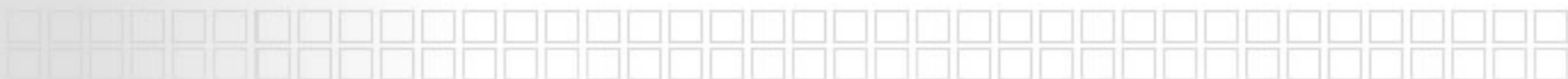

## ■ Inter-disciplinary Small R&D Business

- 80+ staff members (>80% advanced degrees)
- Among the leading Human Engineering firms in the US
- Supported by 100+ corporate and academic partners
- Wide range of repeat clients in government and industry

## Focus: **Human Centered Engineering**

### Areas of Expertise

Human Factors  
Organizational Psychology  
Cognitive Science  
C2 Operations  
Mathematical Modeling  
Software Engineering

### Domains of Application

Military Command and Control  
Intelligence Analysis  
Aerospace Systems  
Medical Systems  
Business & Consumer Software Products

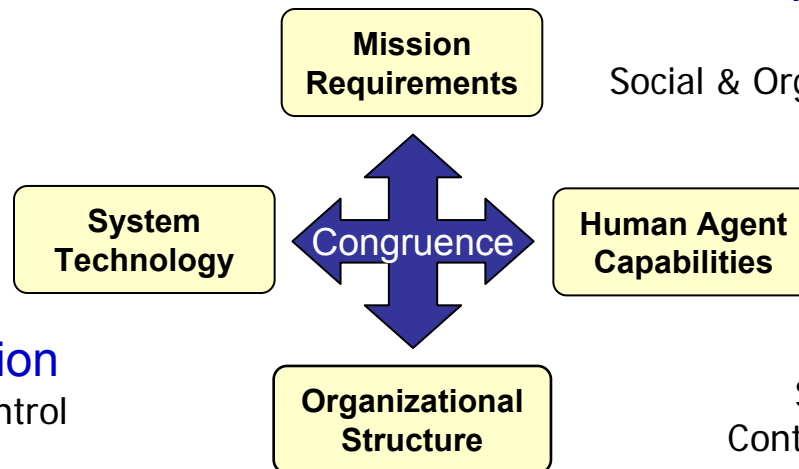

### Products and Services

Organizational Design Tools  
Social & Organizational Behavior Models  
HSI Design and Evaluation  
Cognitive Analysis  
Training Systems  
Performance Assessment  
Competency Analysis  
Intelligent Agents  
Synthetic Task Environments  
Controlled and Field Experiments  
Decision Support Systems

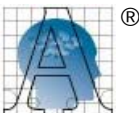

# Next Steps:

- From **Identification** to **Action**
- $\Rightarrow$  from **HMM** to **POMDP**
- Action policies in POMDP create different HMMs

HMM Pattern/Model:

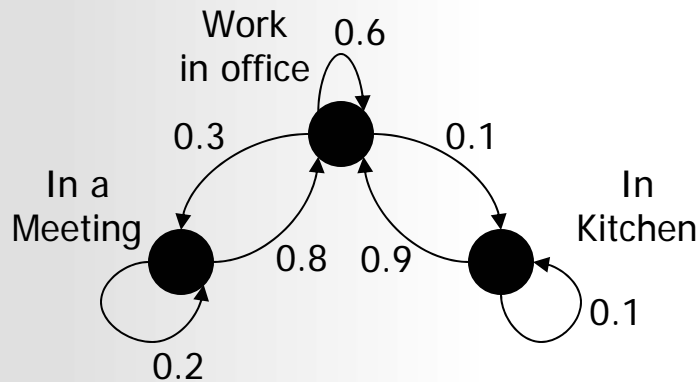

POMDP: effect of actions/decisions

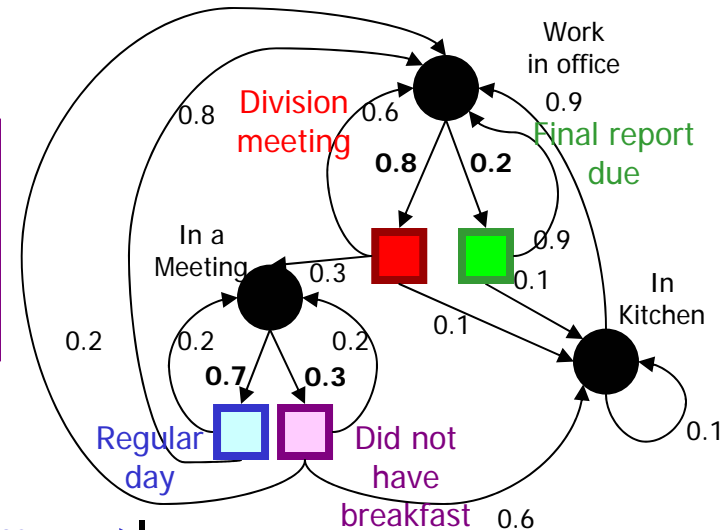

Regular day & SPEYES meeting

True activity sequence:

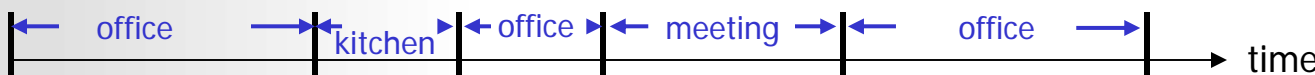

Observations:

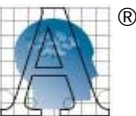

# Transition from POMDP to HMM

POMDP

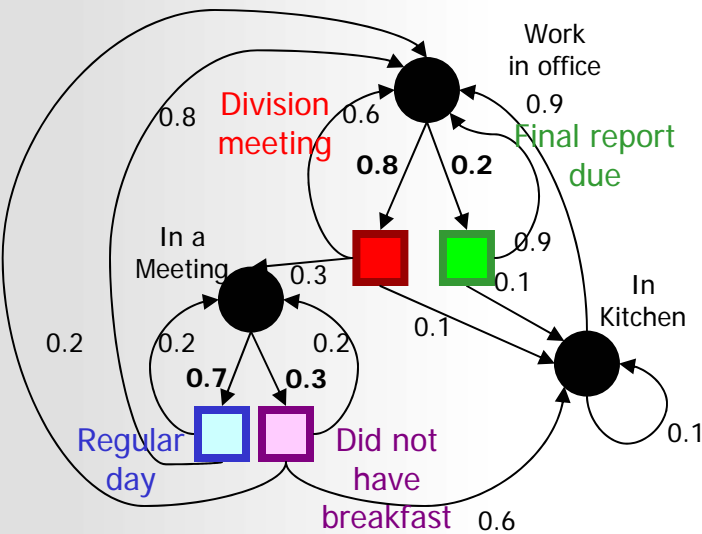

Division meeting + Regular day

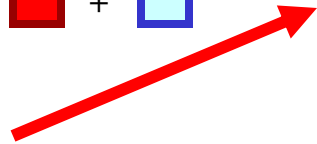
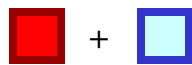

HMM-1

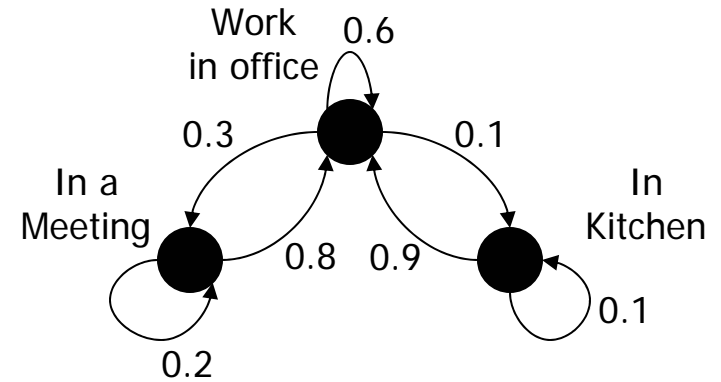

Final report due



HMM-2

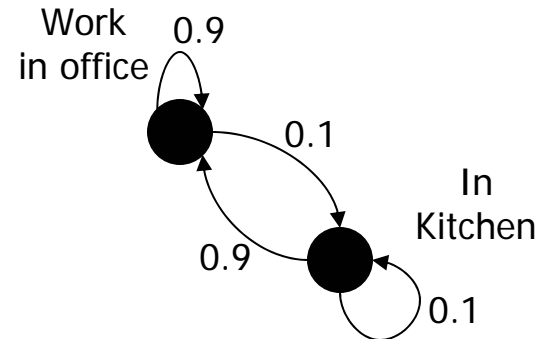

- If specific action policy is predicted/specified, POMDP is transformed to HMM
  - Different (possibly) for each action policy
  - Differ in pattern/structure
  - Differ in transition/observation probabilities

