

# AMRDEC's HWIL Synthetic Environment Development Efforts for LADAR sensors

Hajin J. Kim <sup>\*a</sup>, Michael C. Cornell <sup>\*\*b</sup>, Charles B. Naumann <sup>\*\*b</sup>

<sup>a</sup>U.S. Army Aviation & Missile Command, Aviation & Missile RDEC, AMSAM-RD-SS-HW Bldg.  
5400, Redstone Arsenal, AL 35898-5000

<sup>b</sup>Optical Sciences Corporation, P.O. Box 8291, Huntsville, AL 35808

## ABSTRACT

Hardware-in-the-loop (HWIL) testing has been an integral part of the modeling and simulation efforts at the U.S. Army Aviation and Missile Command's (AMCOM) Aviation and Missile Research, Engineering, and Development Center (AMRDEC). AMCOM's history includes the development and implementation of several unique technologies for producing synthetic environments in the visible, infrared, MMW and RF regions. With the emerging sensor/electronics technology, LADAR sensors are becoming more viable option as an integral part of weapon systems, and AMCOM has been expending efforts to develop the capabilities for testing LADAR sensors in a HWIL environment. There are several areas of challenges in LADAR HWIL testing, since the simulation requirements for the electronics and computation are stressing combinations of the passive image and active sensor HWIL testing. There have been several key areas where advancements have been made to address the challenges in developing a synthetic environment for the LADAR sensor testing. In this paper, we will present the latest results from the LADAR projector development and test efforts at AMCOM's Advanced Simulation Center (ASC).

**Keywords:** Hardware-in-the-loop, LADAR, seeker, simulation, projection

## 1. INTRODUCTION

AMCOM RDEC has been developing the tools to address the needs of testing LADAR sensors in an HWIL simulation environment.<sup>1</sup> A critical component in the LADAR HWIL simulation environment is the LADAR scene projector. Its function is to produce a temporally and radiometrically correct representation of the simulated LADAR return scene based on data provided from the scene generation computer, which is part of the simulation environment. Consequently, near-term development has focused on producing LADAR scene projection hardware. In particular, hardware that can be used to test imaging LADAR sensors, which operate in a direct detection mode at the 1064nm wavelength and employ a scanning linear detector array in their receiver. This paper will discuss the results of the hardware development. In addition, the hardware was configured into a single-channel projector system and tested against commercial LADAR receiver hardware. The results of the testing are presented and discussed.

## 2. LADAR SCENE PROJECTION HARDWARE

A modular approach to developing the LADAR scene projection hardware has been chosen by AMCOM RDEC. Consequently, the functionality of the LADAR scene projection hardware can be divided into two parts, temporal characterization and optical signal generation. Under temporal characterization, the hardware (or module) is responsible for the temporal characteristics (e.g., range to target) contained within a LADAR return signal. Under optical signal generation, the module is responsible for generating the optical signal (or waveform) representing the simulated LADAR return signal based on amplitude (intensity) input and input from the temporal module. By separating these functions, it will minimize the required changes in the projection hardware when the LADAR operating wavelength changes.

---

\* (256) 876-5088 x347; hajin.kim@rdec.redstone.army.mil

\*\* M.C.C.: (256) 922-1500 x206; cornell@opticalsciences.com

C.B.N.: (256) 955-6527; cnaumann@opticalsciences.com

# Report Documentation Page

*Form Approved  
OMB No. 0704-0188*

Public reporting burden for the collection of information is estimated to average 1 hour per response, including the time for reviewing instructions, searching existing data sources, gathering and maintaining the data needed, and completing and reviewing the collection of information. Send comments regarding this burden estimate or any other aspect of this collection of information, including suggestions for reducing this burden, to Washington Headquarters Services, Directorate for Information Operations and Reports, 1215 Jefferson Davis Highway, Suite 1204, Arlington VA 22202-4302. Respondents should be aware that notwithstanding any other provision of law, no person shall be subject to a penalty for failing to comply with a collection of information if it does not display a currently valid OMB control number.

1. REPORT DATE <b>2004</b>	2. REPORT TYPE	3. DATES COVERED <b>00-00-2004 to 00-00-2004</b>			
4. TITLE AND SUBTITLE <b>AMRDEC's HWIL Synthetic Environment Development Efforts for LADAR sensors</b>		5a. CONTRACT NUMBER			
		5b. GRANT NUMBER			
		5c. PROGRAM ELEMENT NUMBER			
6. AUTHOR(S)		5d. PROJECT NUMBER			
		5e. TASK NUMBER			
		5f. WORK UNIT NUMBER			
7. PERFORMING ORGANIZATION NAME(S) AND ADDRESS(ES) <b>Optical Sciences Corporation, PO Box 8291, Huntsville, AL, 35808</b>		8. PERFORMING ORGANIZATION REPORT NUMBER			
9. SPONSORING/MONITORING AGENCY NAME(S) AND ADDRESS(ES)		10. SPONSOR/MONITOR'S ACRONYM(S)			
		11. SPONSOR/MONITOR'S REPORT NUMBER(S)			
12. DISTRIBUTION/AVAILABILITY STATEMENT <b>Approved for public release; distribution unlimited</b>					
13. SUPPLEMENTARY NOTES <b>The original document contains color images.</b>					
14. ABSTRACT					
15. SUBJECT TERMS					
16. SECURITY CLASSIFICATION OF:			17. LIMITATION OF ABSTRACT	18. NUMBER OF PAGES <b>12</b>	19a. NAME OF RESPONSIBLE PERSON
a. REPORT <b>unclassified</b>	b. ABSTRACT <b>unclassified</b>	c. THIS PAGE <b>unclassified</b>			

Presently, commercial programmable digital delay generators (DDGs) from Highland Technology (Model V850) are filling the role as temporal modules. The DDGs are programmed with the time delays required to represent range and define the waveform of the simulated LADAR return signals. The operation of the DDGs (or temporal modules) is initiated by an external trigger signal representative of the triggering of the LADAR transmitter (laser). The output from the temporal modules initiates the operation of the optical signal generation modules.

The optical signal generation modules have been developed in-house. Each module or Optical Signal Generator (OSG) is a 6U size VME board that contains two optical channels (or pixels) for use in LADAR scene projection. Each optical channel is capable of simulating first and last LADAR return signals based on timing and amplitude data supplied to the board. The simulated return signals are nominally optical square pulses whose amplitude and pulse width can vary based on data from a scene generation computer and input from the temporal module.

Figure 1 shows a block diagram of the Optical Signal Generator design. Data for forming the simulated return signals is provided through the VME bus (amplitude) and the  $T_1$  and  $T_2$  Start/Stop inputs (define the pulse width and when the optical signals are generated) located on the front panel of each board. The  $T_0$  signal is used to latch the amplitude data received over the VME bus. The latched amplitude data is parsed out to the DAC Control Logic for each optical channel by the VME Interface. Each DAC Control Logic unit directs the appropriate amplitude and timing data to the DACs that form the drive signal sent to the laser driver. The laser driver produces the current waveform that operates the 1065nm fiber coupled diode laser. The output from the laser is conveyed out an optical fiber for projection at the unit under test.

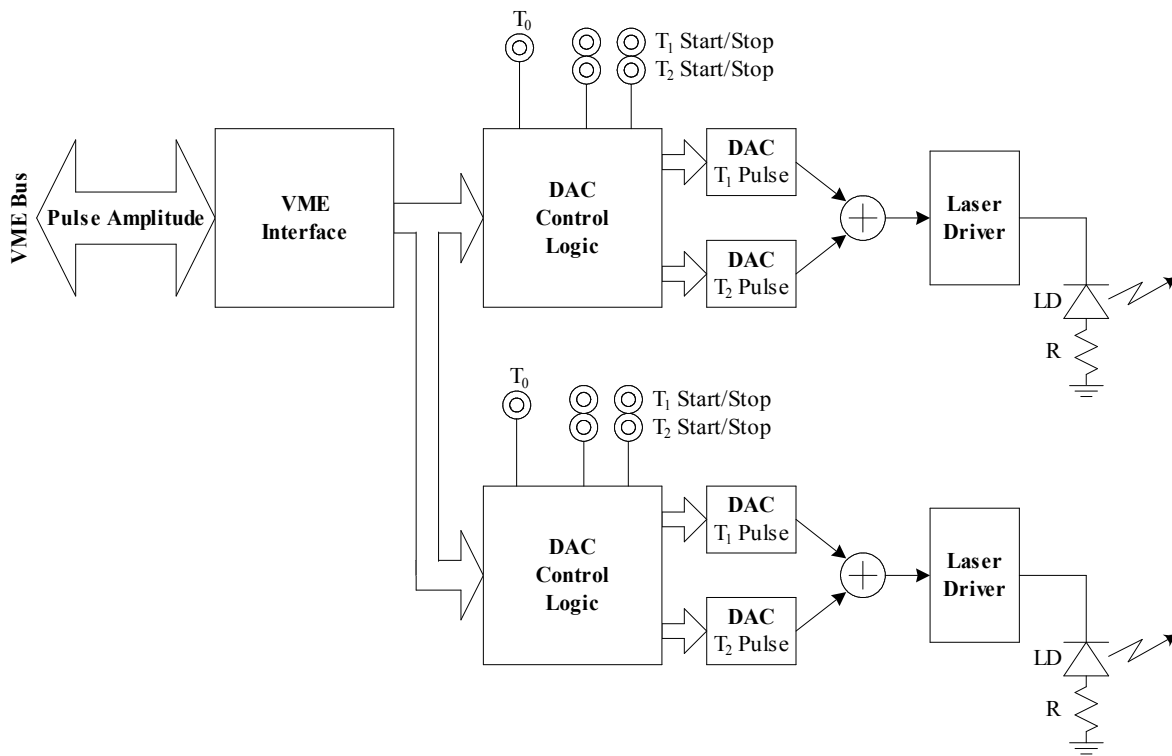

Figure 1. Block diagram of an Optical Signal Generator Board

Each diode laser package mounted on the board contains a thermo-electric cooler (TEC) and a thermistor. Therefore, additional circuitry is included on each OSG Board (but not depicted in Figure X) to operate the TECs.

Table 1 presents the operational performance of each optical channel when the temporal and optical signal generation modules are in operation together.

Table 1. Operational performance of the individual optical channels

<b>Range Simulation Modes:</b>		Single-Pulse, Dual-Pulse
<b>Time Delay (Range)</b>		
<b>Resolution:</b>	0.5ns (0.075m)	
<b>Maximum:</b>	>>33.3 $\mu$ s (>>5000m)	
<b>Minimum:</b>	<100ns (15m)	
<b>Pulse Width</b>		
<b>Resolution:</b>	<0.5ns	
<b>Maximum:</b>	Equivalent to Maximum Delay	
<b>Minimum:</b>	4ns	
<b>Modulation Rate:</b>		
>20kHz (Max)		
<b>Operating Wavelength:</b>		
1065 $\pm$ 10nm		
<b>Optical Intensity</b>		
<b>Maximum Peak Power:</b>	10mW (at the fiber end)	
<b>Dynamic Range:</b>	30dB	
<b>Control Range:</b>	8-bits	

### 3. TESTING AGAINST LADAR RECEIVER HARDWARE

Upon completion of the LADAR scene projection hardware, the goal was to test the hardware against a real LADAR sensor or at least against LADAR receiver hardware. The test had two goals. The first goal was to verify timing and intensity control of the projection hardware against real LADAR hardware. The second goal was to play “real” LADAR return scenes and Test Patterns through the projector and subsequently, capture and visualize the projection data. Unfortunately, no LADAR sensor (or receiver) employing a scanning linear detector array was available for use in this test. What was available was LADAR receiver hardware typically employed in a raster scanned single element detector configuration, which was produced by H. N. Burns (HNB) Engineering Corporation for their LADAR sensors and is commercially available from them. Consequently, the LADAR scene projection hardware was tested against the HNB hardware.

#### 3.1. Test Setup

Before describing the test setup, the elements of the HNB LADAR receiver hardware must be briefly discussed. The hardware consisted of two fiber coupled receivers, a Multi-hit Digital Range Counter (MDRC), and a PC computer containing a digital I/O card and running a proprietary software product called B3D. Each receiver contained an InGaAs PIN photodiode in a ST receptacle connected to a 70MHz transimpedance amplifier, which produced a differential output. The sensing threshold voltage of a receiver was controllable through a serial port. In addition, a monitoring port allowed the user to observe the optical signal after the amplifier. The MDRC captures the LADAR return data measuring the range and relative intensity of each pixel.<sup>1,2</sup> It has three input ports for receivers. One port (T0) starts the range counters and the other two (STOP1 and STOP2) stop the counters. The stop ports can also react to multiple stop signals. In addition, it generates a fixed frequency (50kHz max) trigger signal for controlling a LADAR transmitter. Communication to the MDRC occurs through a serial port and a digital I/O port through which the LADAR return data can be sent to a computer and simultaneously control the operation of an x-y scanner. The windows based B3D software collects the data from the MDRC, displays it in real-time, and then store the raw pixel data. It also allows the user to conduct further processing of the data.

<sup>1</sup> After completing the testing, it was learned that due to a fabrication error the maximum range the MDRC could measure had been limited to 985m. The counters in the MDRC wrap around when the range was greater than the maximum value.

<sup>2</sup> The MDRC measures the intensity using a technique called “Time Over Threshold,” which is just a relative measure of the optical intensity.

The experimental setup for the test is shown in Figure 2. The AMCOM RDEC projection hardware was configured to operate as a single optical channel projector. A second optical channel (with the time delay set to zero) was used to represent the LADAR transmitter firing. The scene generation computer in this setup was a PC computer, which had been used to operate the projection hardware at AMCOM RDEC. A Stanford Research Systems DG535 Pulse/Delay generator was used to convert the external trigger signal to the projector to the correct signal format.

The HNB equipment formed a non-scanning LADAR receiver. It consisted of two fiber coupled receiver units connected to a MDRC, which was interfaced to a computer system running the B3D software. The sensing threshold level in each receiver was set to its maximum level for the testing. This was equivalent to a 99.9% detection level (i.e., 1 in 1000 false detection ratio). The MDRC provided a trigger signal to the projector hardware, which results in the generation of optical signals from the projector.

With the receiver photodiode packaged in an ST receptacle, the FC terminated fibers of the projector optical channels could not be directly connected together. Therefore, to couple the optical channels to the receivers, optical fibers with ST connectors were attached to the receivers.<sup>3</sup> The end of each optical channel fiber was positioned close (but not butting up) to the end of the corresponding fiber from a receiver.<sup>4</sup> This air gap along with the inefficient coupling between the fibers helped provided some needed attenuation, because the maximum output from an optical channel could damage the receiver. The fibers were secured to prevent their movement.

The B3D software controlled the testing. The data to be projected was cued up on the scene generation computer. The B3D software was configured for the frame size (i.e., number of pixels in the horizontal and vertical direction) and the rep rate of the LADAR transmitter (i.e., the rate of the MDRC trigger signal output). Once these were accomplished, the MDRC was commanded through B3D to generate the trigger signal. The projector generated optical signals until the external trigger signal stopped. The data captured by the MDRC was read into the computer and displayed in real-time by the B3D software. Once data was collected for the last pixel in the designated frame size, the MDRC was commanded to stop generating the trigger signal.

## **3.2. Testing Results**

The tests were conducted in two parts. The first part consisted of generating constant pixel values and observing the measurements made by the LADAR receiver hardware. The second part of the testing consisted of projecting entire frames of data, which are either a test pattern where range or intensity is held constant or based on “real” LADAR data previously captured by a LADAR sensor.

### **3.2.1. Timing and Intensity Control**

Initial time control testing consisted of programming the projector to generate a train of pulses with a fixed delay (range) and a constant intensity, and then using the HNB equipment to measure the range (delay). The measurements reflected the programmed delay values with a jitter of approximately 350ps, which is the jitter limit of the HNB hardware. This jitter limit is about a factor of ten larger than the limit for the Stanford Research Systems SR620 Time Interval Counter, which is used to test the LADAR scene projection hardware at AMCOM. Consequently, nothing new could be learned from continuing the delay tests since testing at AMCOM had shown that the jitter of the projection hardware was under a few hundred picoseconds.

Since the HNB LADAR receiver hardware only measured a “relative” intensity, any testing of the intensity control was limited. Instead, a relative intensity calibration of the projector was performed with respect to the receiver hardware. Due to a combination of the optical coupling scheme between the optical channel and the receiver and the “time over threshold” scheme employed by the receiver hardware to measure intensity, the projector intensity control could only cover 60% of the intensity range that the receiver hardware could sense. Time constraints prevented trying to improve this control. Therefore, this was the level of control available for projecting the test patterns and the “real” LADAR scenes.

---

<sup>3</sup> The optical fiber was multi-mode and had a core diameter of 100 $\mu$ m. The optical channel fiber was single-mode and had a core diameter of 8.3 $\mu$ m.

<sup>4</sup> The gap between fiber ends was on the order of 5mm.

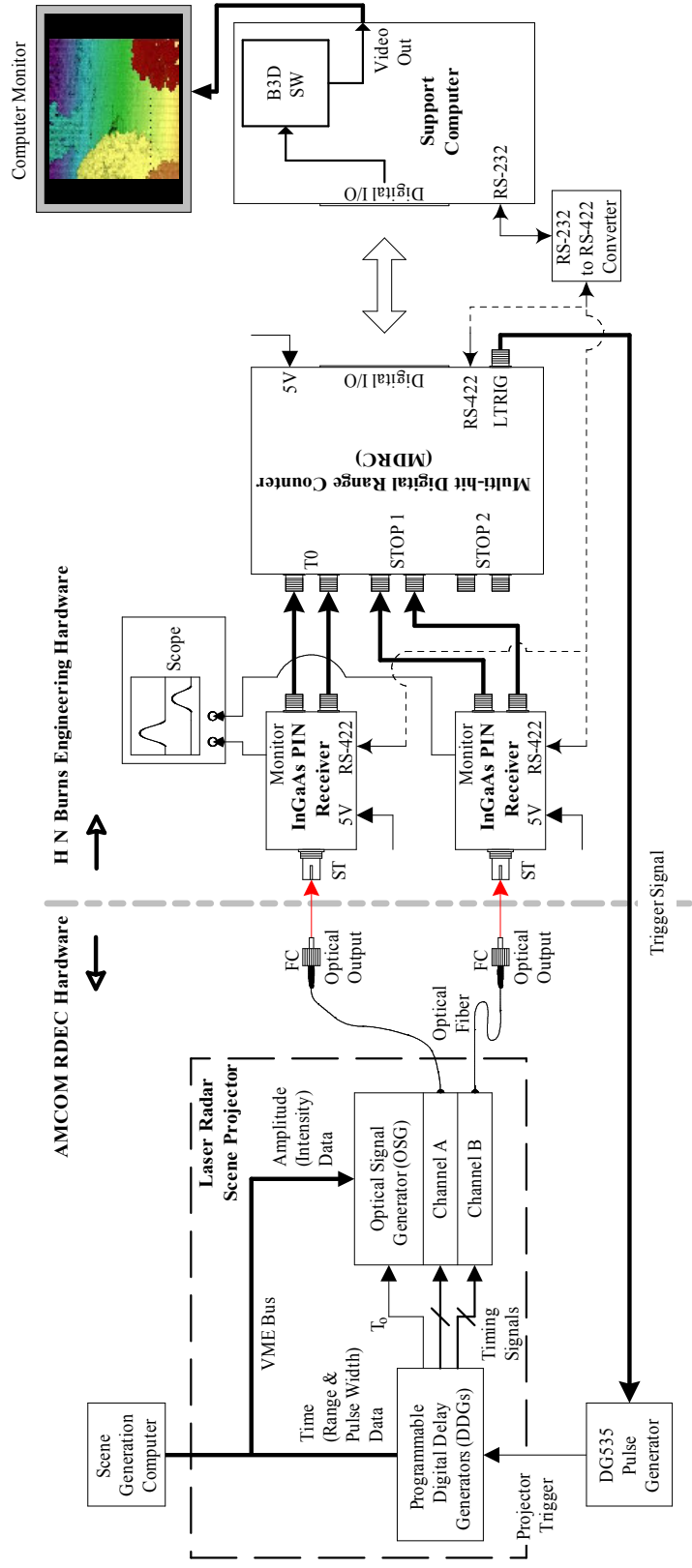

Figure 2. Experimental setup used in testing the single channel projector system

### 3.2.2. Projection of test patterns and LADAR return scenes

Several varieties of test pattern data files were generated, and then projected at the HNB LADAR receiver. Figure 3 shows a view of a projected range checkerboard pattern (intensity kept constant). In this instance, the background of the pattern was kept at a constant range with each square of the pattern progressively increasing in range over the background in two meter steps.

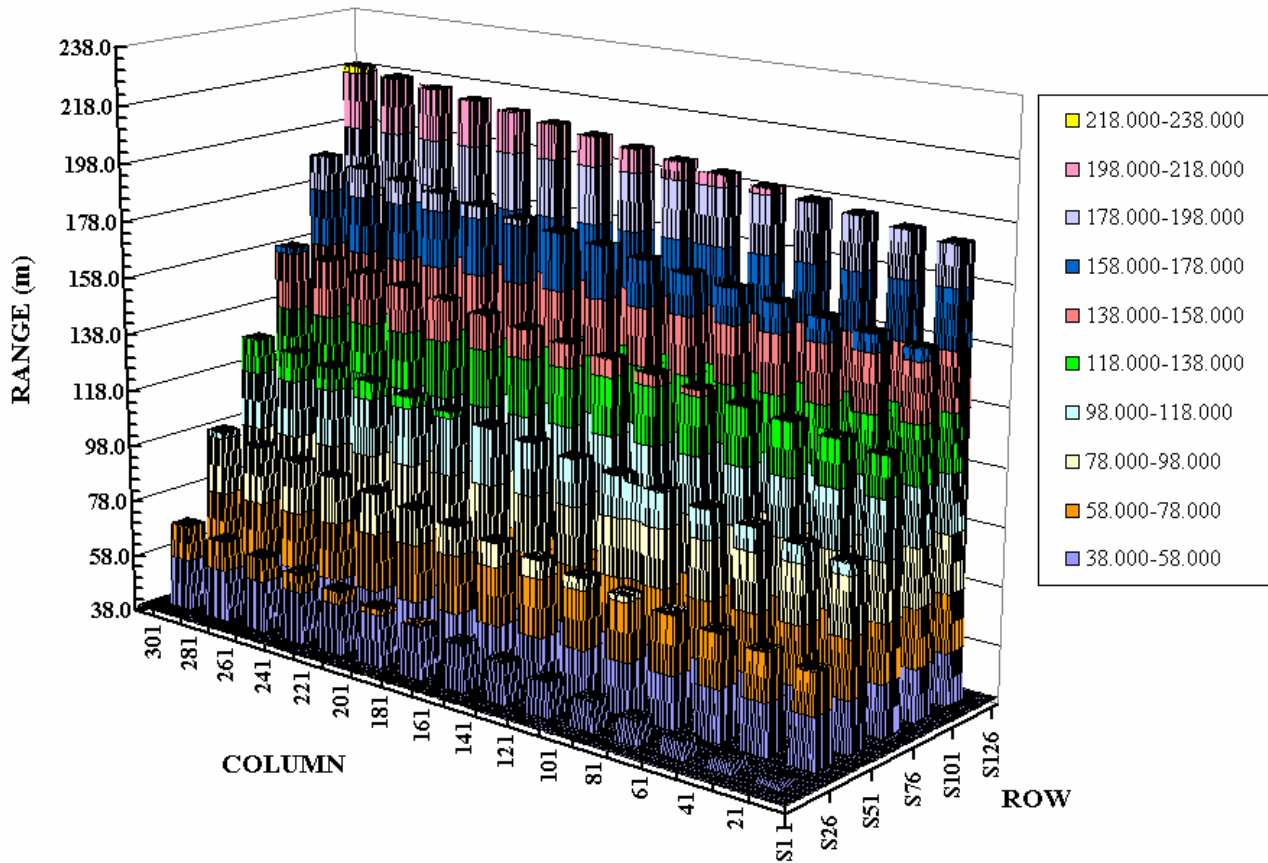

Figure 3. 3D view of a projected range checkerboard pattern

Figure 4 shows a top down view of the same range checkerboard pattern. Of particular importance in this image is the evidence of pixel data drop outs (i.e., no update of the pixel data), which had previously been observed during the development of the LADAR scene projection hardware. These phenomena are caused by the Windows 2000 operating system used on the scene generation computer. The Windows based computer cannot update the pixel data to the projection hardware continuously above a 100Hz rate. Above this rate, inherent processes in Windows begin to prevent pixel data updates from occurring. At a 2kHz trigger rate, there are instances of the pixel data not being updated for periods of up to 10 cycles of the trigger. These periods get longer and longer (in terms of trigger cycles) as the trigger rate to the projector increases. Therefore, a Windows platform for the scene generation computer is unsuitable, if the projection hardware has to operate above 100Hz or has no capability for data buffering, which the current hardware does not.

Figure 5 shows the projection of a constantly varying intensity pattern with the range fixed. As it can be clearly seen, the range measured by the receiver varies across the scene with the lower intensity pixels appearing further away. As shown in Figure 6, LADAR return signals from a fixed range but with varying intensity will cross the sensing threshold of the receiver at different points in time even though the centroid of each signal coincides. This results in the variation in the range measurements. Therefore, unless the LADAR can compensate for the “Time Walk” effect, there can be

significant errors (on the order of a meter) in the range measurements. HNB has developed a technique to compensate for this effect. However, due to time limitations, the compensation technique was not applied to the results shown in this paper.

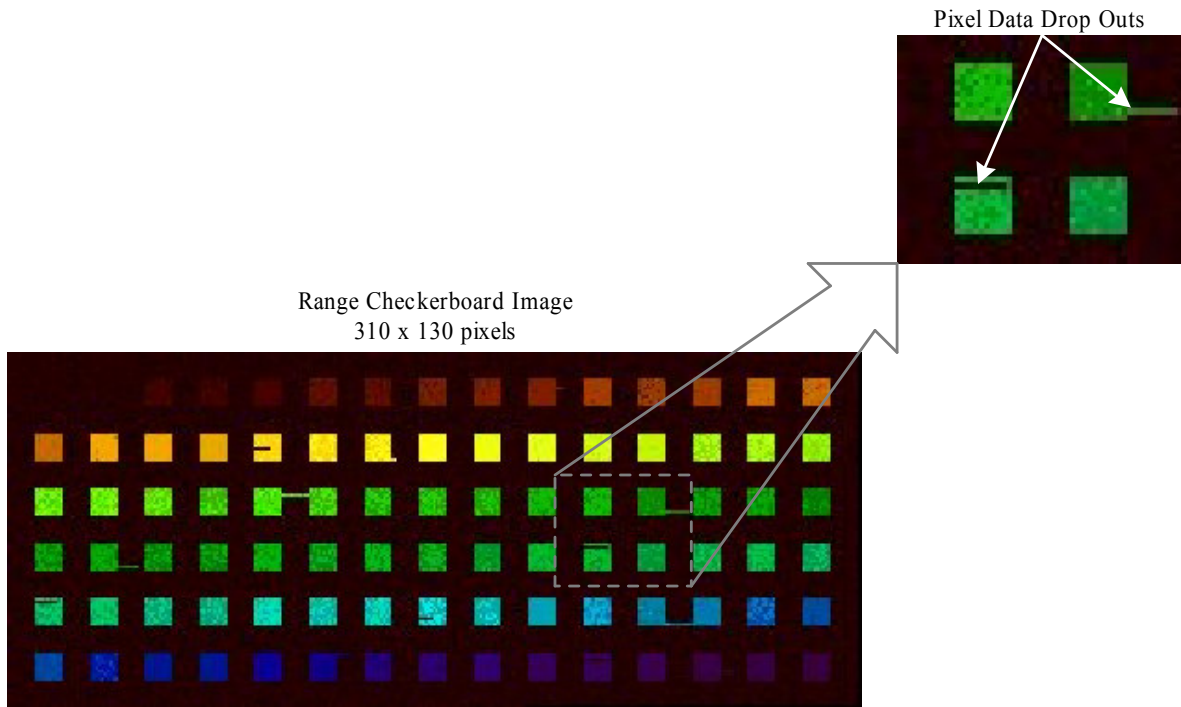

Figure 4. Range checkerboard image with pixel data drop out evident

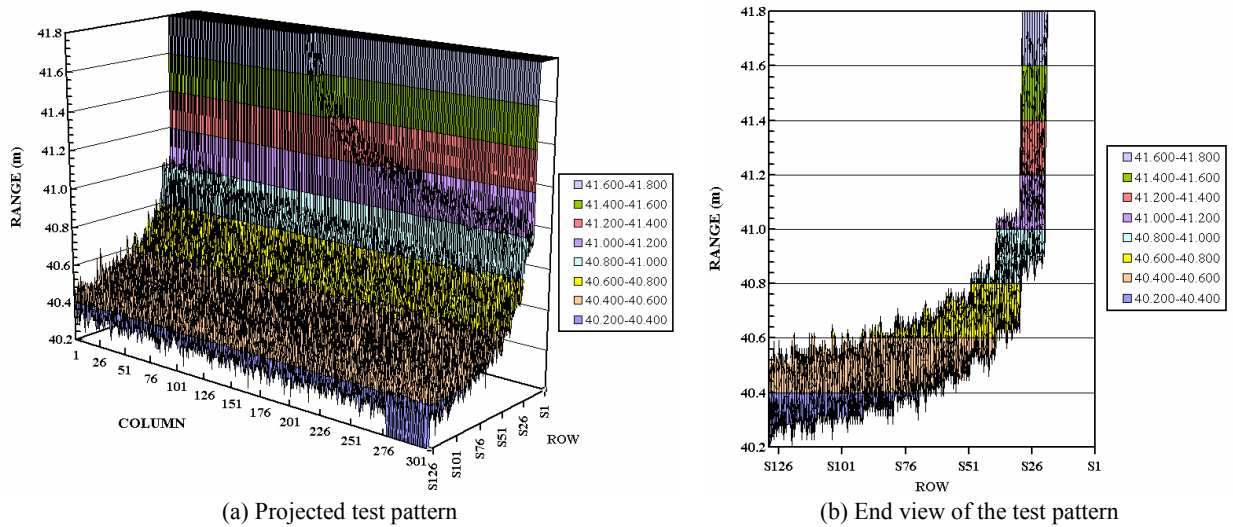

Figure 5. Varying intensity with fixed range test pattern



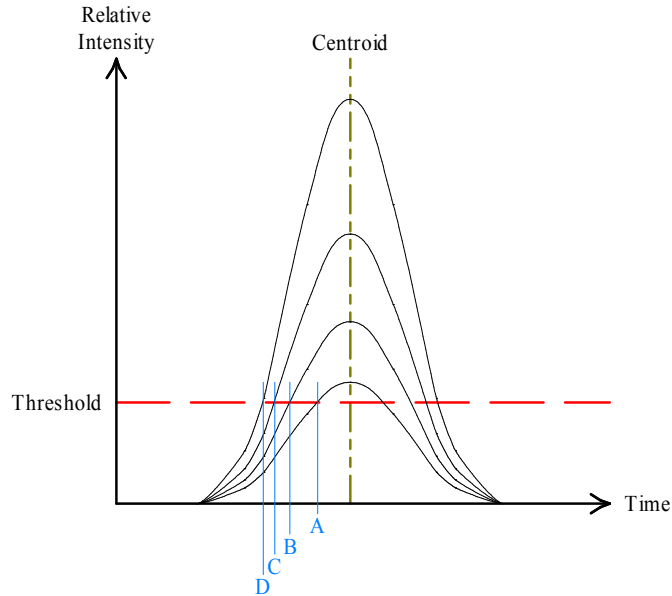
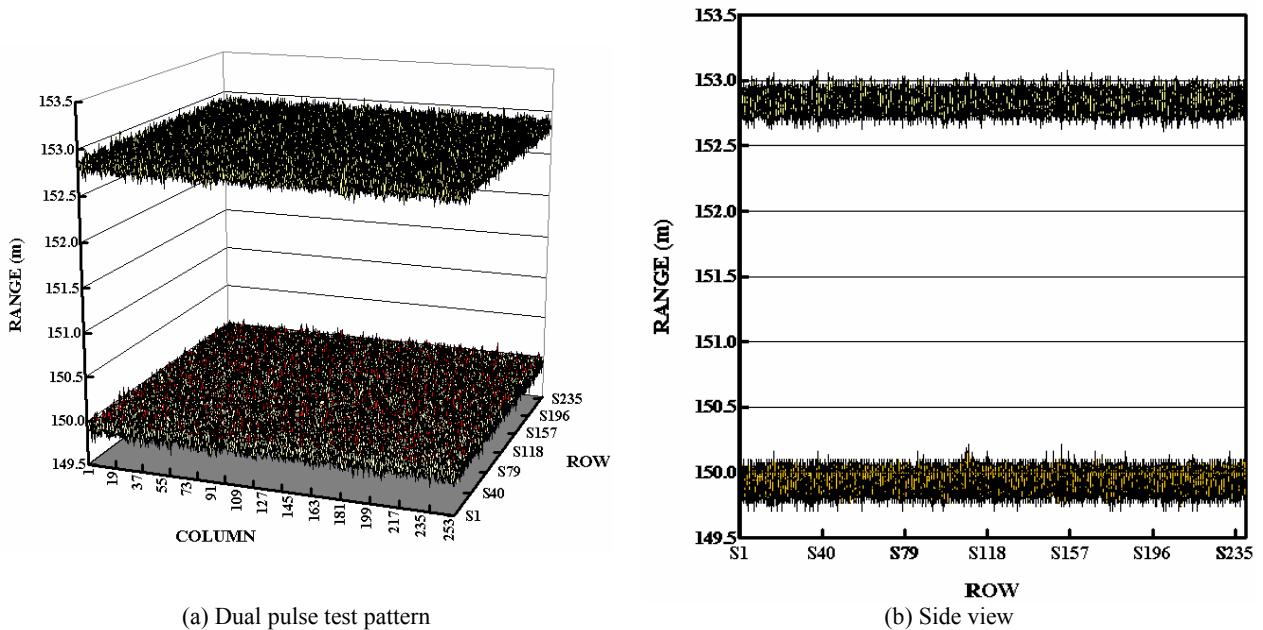

Figure 6. Illustration of LADAR return signals from a fixed range but with varying intensity

For completeness, the dual pulse operation capability of the LADAR scene projection hardware was checked using the HNB hardware. An example of the dual pulse operation is shown in Figure 7. The nominal separation between the pulses in Figure 7 was commanded to be 15ns (or 2.25m range separation). However, the measured separation was on the order of 2.9m (or approximately 19ns between pulses). The average increase in separation between programmed separation and measured separation for all the dual pulse data sets was approximately 3.5ns (or ~0.5m). The cause of the observed systematic error was not determined. Further study would be necessary to determine if the cause was in the projector hardware or the receiver hardware. Unfortunately, additionally time with the receiver hardware was not available. It is planned to re-visit this issue in the future.



(a) Dual pulse test pattern

(b) Side view

Figure 7. Demonstration of dual pulse operation

After completing the test patterns, the next set of projections were those based on the “real” LADAR scenes. Figures 8 and 9 show examples of these projections captured by the HNB LADAR receiver hardware compared with the original scene data. In general, the captured projection images compared quite well with the original scenes to the extent that the scanning artifacts of the original LADAR sensor are replicated. The images might have been improved if the projections could have used the entire intensity sensitivity range rather than only 60% of the range. An even better test would be to project scenes based on real data captured by the same LADAR system that collects the projection.

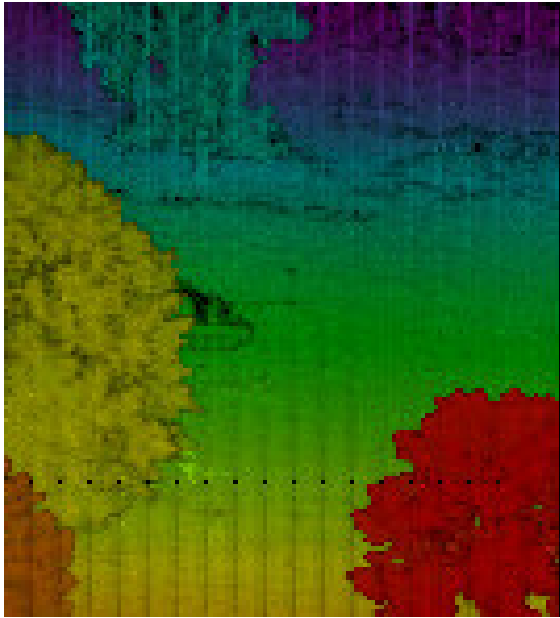

(a) Original Range & Intensity Image

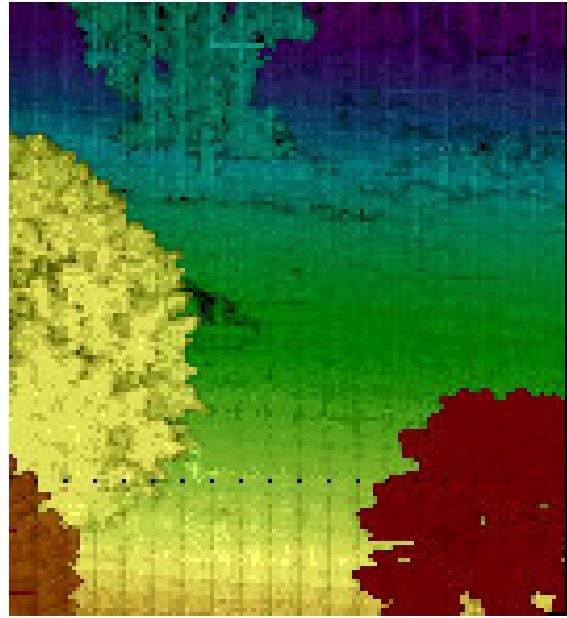

(b) Projected Range & Intensity Image

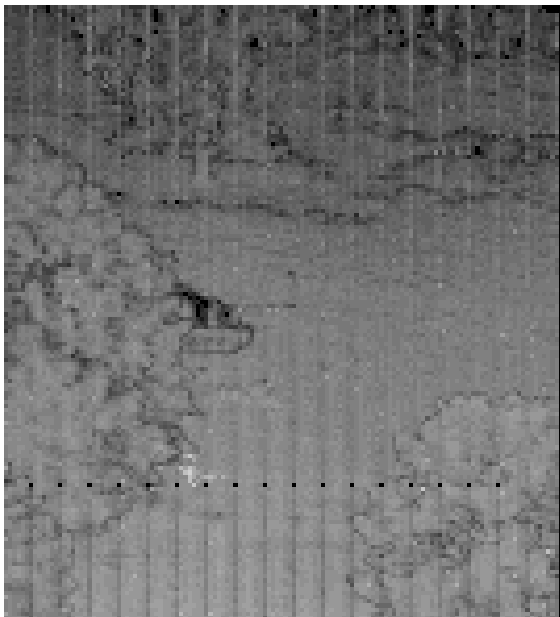

(c) Original Intensity Only Image

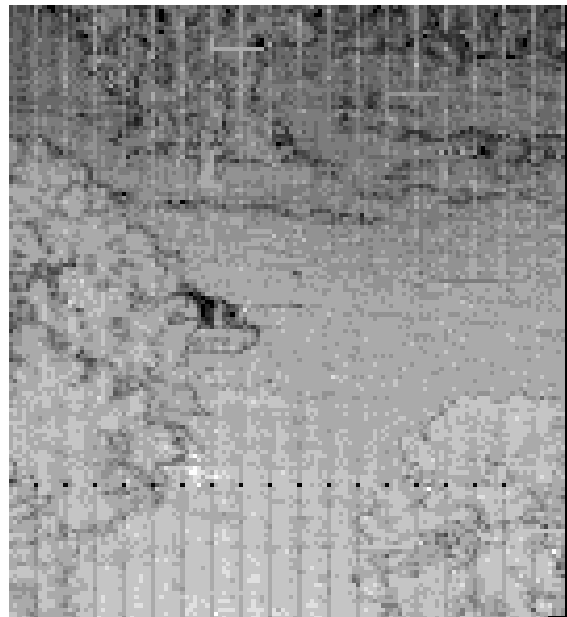

(d) Projected Intensity Only Image

Figure 8. Comparison of original and projected 133x148 pixel image

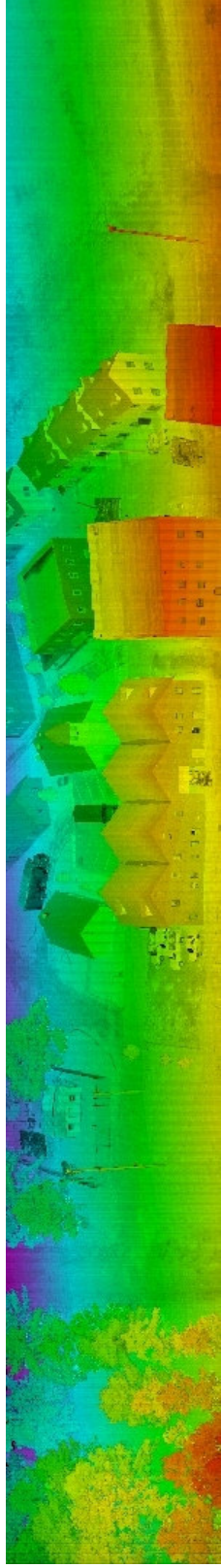

(a) Original Range & Intensity Image

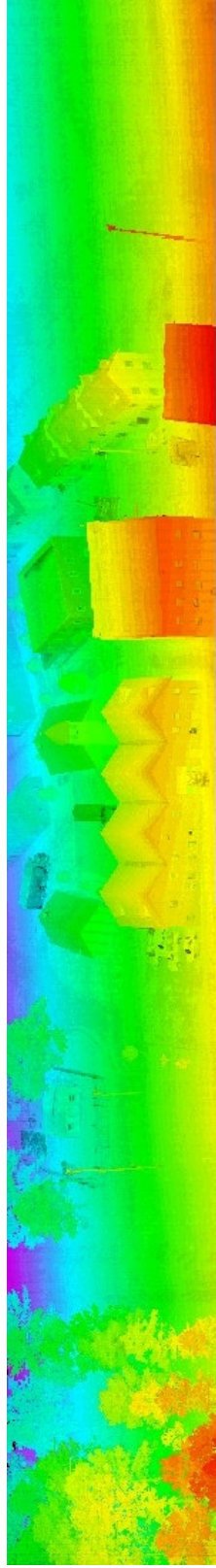

(b) Projected Range & Intensity Image



(c) Original Intensity Only Image



(d) Projected Intensity Only Image

Figure 9. Comparison of original and projected 1092x148 pixel image

#### 4. CURRENT EFFORT

AMCOM RDEC has expanded the single channel system into a multi-channel system consisting of eight optical channels. One of the main goals with this system is achieving high uniformity of the laser outputs in order to achieve high quality, high dynamic range scene projection. There are several challenges in producing repeatable and uniform outputs from a set of lasers. As shown in Figure 10, there are significant variations in the performance of the individual lasers. Furthermore, temperature change and vibration affects the output level as well. Having worked through some of these issues, initial tests are planned with the multi-channel system against a LADAR sensor employing a linear detector array later this year. Since several optical interface options are being considered at this point to support true line of sight and synthetic line of sight testing, the upcoming test will provide valuable data in assessing the most feasible near term interface options.

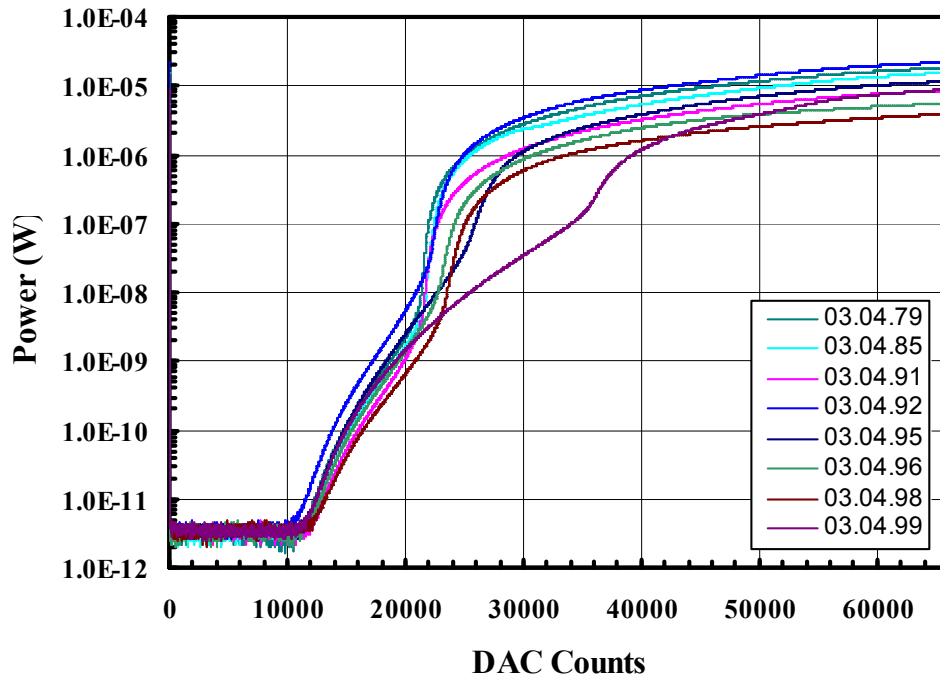

Figure 10. Laser output power as a function of DAC count for the lasers employed in the multi-channel system

#### 5. CONCLUSIONS

AMCOM RDEC has developed LADAR scene projector hardware that is suitable for testing imaging LADAR sensors, which operate in a direct detection mode at a 1064nm wavelength and employ a scanning linear array of detectors in the receiver. A single channel projector system was fabricated from this hardware and tested against LADAR receiver hardware. Though it turned out that the verification testing of range and amplitude control could not be conducted in a satisfactory manner, the projection of the “real” LADAR scenes and the test patterns clearly show what the LADAR scene projection technology is capable of accomplishing.

#### ACKNOWLEDGEMENTS

The authors would like to thank Buck Burns, Bill Conrad, Steve Yun, and Bob Gustavson of H. N. Burns Engineering Corporation for the use of their LADAR receiver hardware and their assistance (along with stimulating conversations and hospitality) during the testing of the LADAR scene projection hardware at their facilities. In addition, the authors would like to thank AMDREC Missile Guidance Directorate for providing us with the frames of real LADAR images.

## REFERENCES

1. H.J. Kim, S.B. Mobley, and J.A. Buford, "AMCOM RDEC LADAR HWIL Simulation System Development", *Technologies for Synthetic Environments: Hardware-in-the-Loop Testing VIII*, Robert L. Murrer, Jr., Editor, Proc. SPIE 5092, pp. 288-294 (2003).