



Global Communications Grid Architecture Tutorial

**Brian E. White, Ph.D.
The MITRE Corporation**

For MILCOM 2002

Wednesday, 9 October 2002

The Disneyland Resort

Anaheim, CA

NOTICE

**This technical data was produced for the U.S. Government
under Contract No. F19628-99-C-0001, and is
subject to the Rights in Technical Data-
Noncommercial Items clause at
DFARS 252.227-7013 (NOV 1995)**

© 2002 The MITRE Corporation

MITRE

Report Documentation Page

Form Approved
OMB No. 0704-0188

Public reporting burden for the collection of information is estimated to average 1 hour per response, including the time for reviewing instructions, searching existing data sources, gathering and maintaining the data needed, and completing and reviewing the collection of information. Send comments regarding this burden estimate or any other aspect of this collection of information, including suggestions for reducing this burden, to Washington Headquarters Services, Directorate for Information Operations and Reports, 1215 Jefferson Davis Highway, Suite 1204, Arlington VA 22202-4302. Respondents should be aware that notwithstanding any other provision of law, no person shall be subject to a penalty for failing to comply with a collection of information if it does not display a currently valid OMB control number.

1. REPORT DATE 2002		2. REPORT TYPE		3. DATES COVERED 00-00-2002 to 00-00-2002	
4. TITLE AND SUBTITLE Global Communications Grid Architecture Tutorial				5a. CONTRACT NUMBER	
				5b. GRANT NUMBER	
				5c. PROGRAM ELEMENT NUMBER	
6. AUTHOR(S)				5d. PROJECT NUMBER	
				5e. TASK NUMBER	
				5f. WORK UNIT NUMBER	
7. PERFORMING ORGANIZATION NAME(S) AND ADDRESS(ES) MITRE Corporation, 202 Burlington Road, Bedford, MA, 01730-1420				8. PERFORMING ORGANIZATION REPORT NUMBER	
9. SPONSORING/MONITORING AGENCY NAME(S) AND ADDRESS(ES)				10. SPONSOR/MONITOR'S ACRONYM(S)	
				11. SPONSOR/MONITOR'S REPORT NUMBER(S)	
12. DISTRIBUTION/AVAILABILITY STATEMENT Approved for public release; distribution unlimited					
13. SUPPLEMENTARY NOTES The original document contains color images.					
14. ABSTRACT					
15. SUBJECT TERMS					
16. SECURITY CLASSIFICATION OF:			17. LIMITATION OF ABSTRACT	18. NUMBER OF PAGES 81	19a. NAME OF RESPONSIBLE PERSON
a. REPORT unclassified	b. ABSTRACT unclassified	c. THIS PAGE unclassified			



Outline

- **Introduction**
- **Global Grid**
- **Layered architecture**
- **Getting connected**
- **The Internet Protocol (IP)**
- **Wrap-up**



Introduction



Expectations





What Is It?

- **Operationally**, at Department of Defense (DoD) level
 - Enabler of interoperable communications among Services and Allied/Coalition partners
- **Programmatically**, at Air Force (AF)/Electronic System Center's (ESC's) Global Grid Product Area Directorate (PAD) level, e.g.,
 - Means for horizontally integrating communications and networking of AF's integrated Command and Control System of Systems (C2SoS)
- **Technically**, communications transport network, e.g.,
 - Transport and Network Layers of Open Systems Interconnection (OSI) model
 - Transport and Internet Layers of the Transport Control Protocol/Internet Protocol (TCP/IP) model, using common network protocol, viz., IP

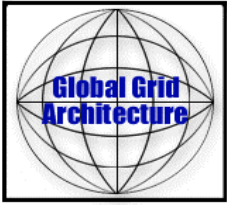

Why Do We Need It?

- **Shared communications infrastructure provides benefits**
 - **Operationally**, by helping to increase deployment flexibility and improved warfighting capabilities*
 - Connectivity among all participants
 - Capacity for exchanging any kind of information (perhaps with astute filtering and/or adaptive techniques)
 - Control that autonomously adapts to changing conditions
 - **Programmatically**, by saving money through
 - Utilizing acceptable products available commercially
 - Horizontal integration of like functions
 - **Technically**, by migrating towards extensible system architecture that can
 - Be technology independent as possible
 - Increase in size and complexity without bound

* This is how “network-centric” warfare will be done.



Where Are We Now?

- **Operationally**
 - Our command and control system is not fully integrated and can be improved in connectivity, capacity, and control
 - Our warfighters need better, i.e., more specific, useful, timely, and reliable information for
 - Tailored situational awareness
 - Robust global operations
 - Dynamic planning and execution
- **Programmatically**
 - Generally, our communications systems still are designed and funded to serve one User community and vertically integrated to ensure required performance
- **Technically**
 - Commercial world is ahead of DoD in developing many needed communications/networking technologies
 - But there are military needs that still require development



How Do We Get There?

- **Operationally**
 - Gradually evolve our operational communications systems with more integrated communications/networking structure
- **Programmatically**
 - Continue to develop and introduce communication, protocol, or other kinds of gateways as interim measures
 - Incorporate Global Grid architectural tenets into both current and new acquisition programs
 - Provide specific technology roadmaps, and whenever possible assist program offices migrate towards Global Grid
 - Continue to utilize vertical integration only in situations where requirements cannot be met with IP approach
- **Technically**
 - Utilize commercially available and widely used IP networking and other kinds of communications technologies wherever possible

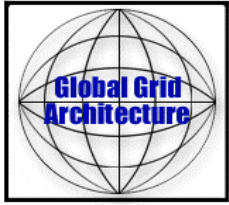

Global Grid



Global Grid Definition

The Global Grid is DoD's communications and networking infrastructure.

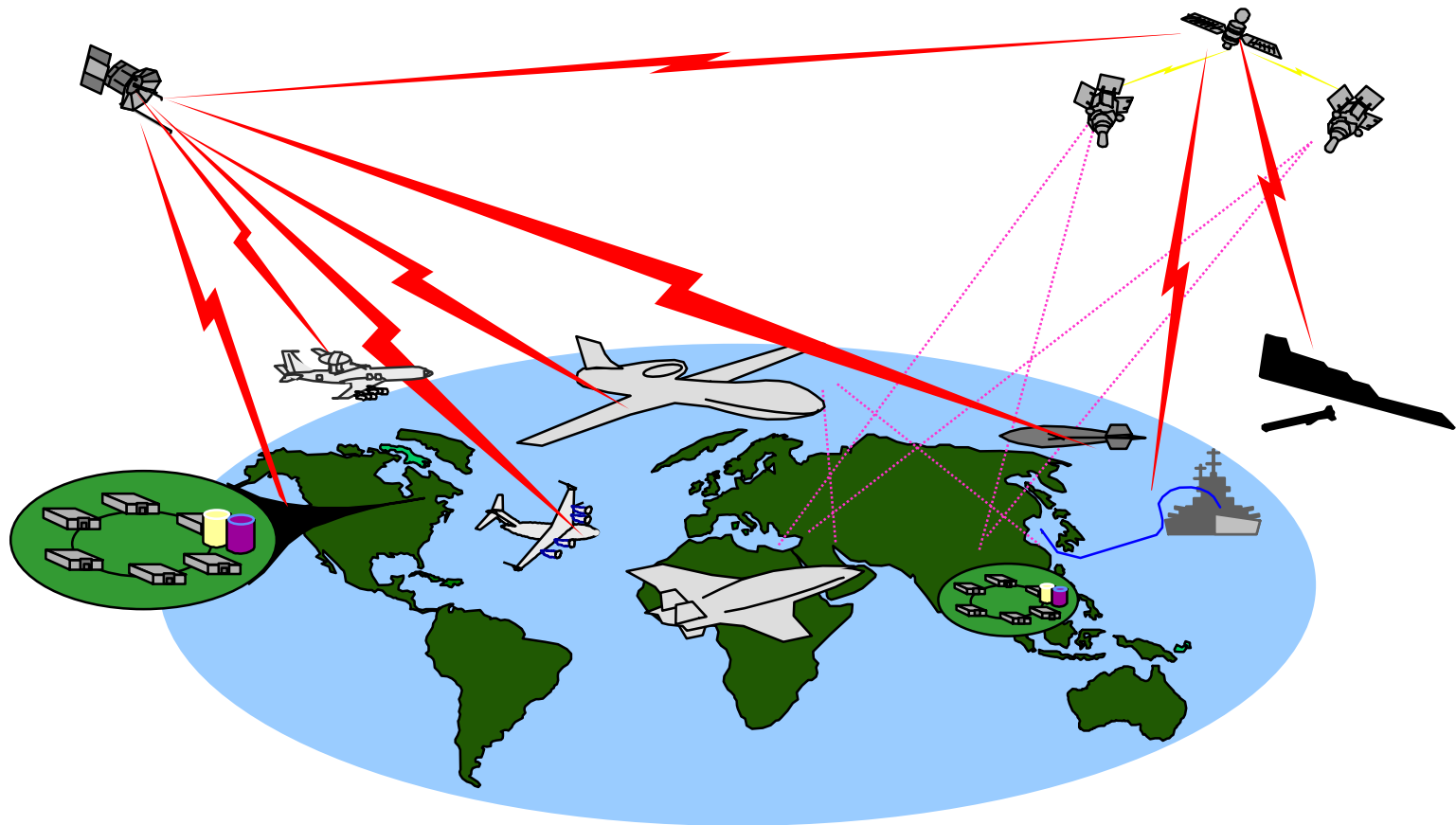



DoD's Global Information Grid (GIG)



The GIG Vision

- Single, secure infrastructure providing seamless, end-to-end capabilities to all warfighters; fused with weapons systems
- Supports strategic, operational, tactical, and naval, base/post/camp levels
- Mission process software applications and services
- “Plug and play” interoperability guaranteed for Joint, Allied, and Coalition Users
- Distributed information, database, network management, and computer processing
- High-capacity, netted operations; communication bandwidth on demand
- Defense in-depth against all threats; information assurance; security protection
- Commercial implementations when available, military when not, or requiring other capabilities

Assured, Interoperable Communications



Global Grid Relationships

- **Global Information Grid (GIG) of Joint Chiefs of Staff includes**
 - **Global Grid (GG)**
(applies DoD wide)
 - **Integrated Command and Control System of Systems (C2SoS)**
(Air Force contribution to GIG)
 - **Joint Battlespace Infosphere (JBI)** (“broker” and other “middleware” portion of GIG)

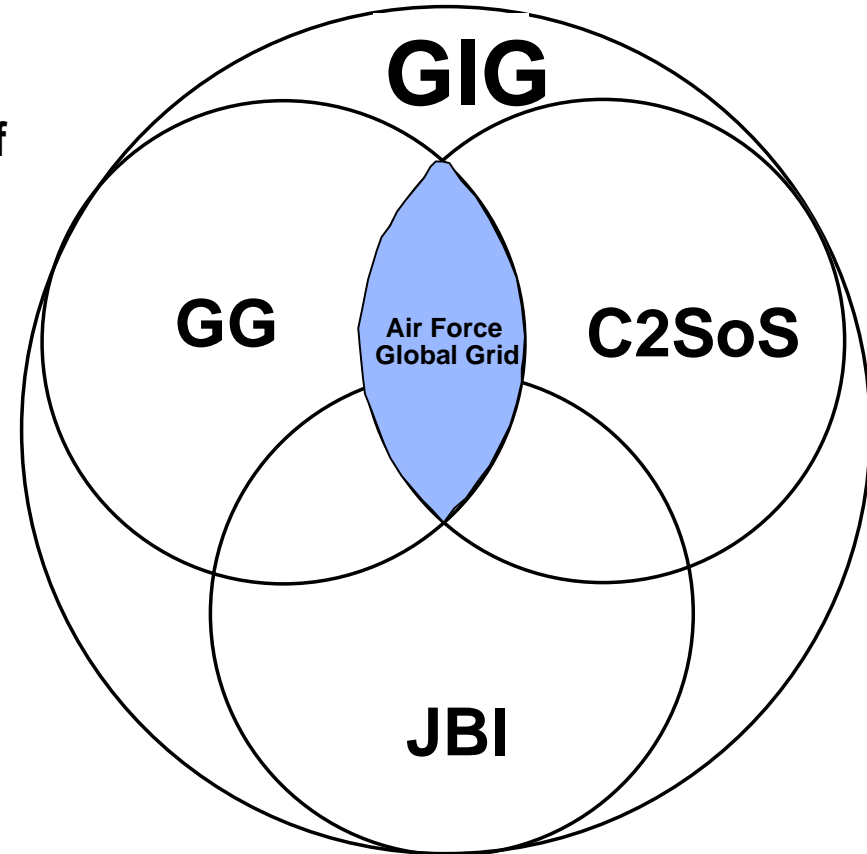



Where Does Air Force Global Grid Fit?

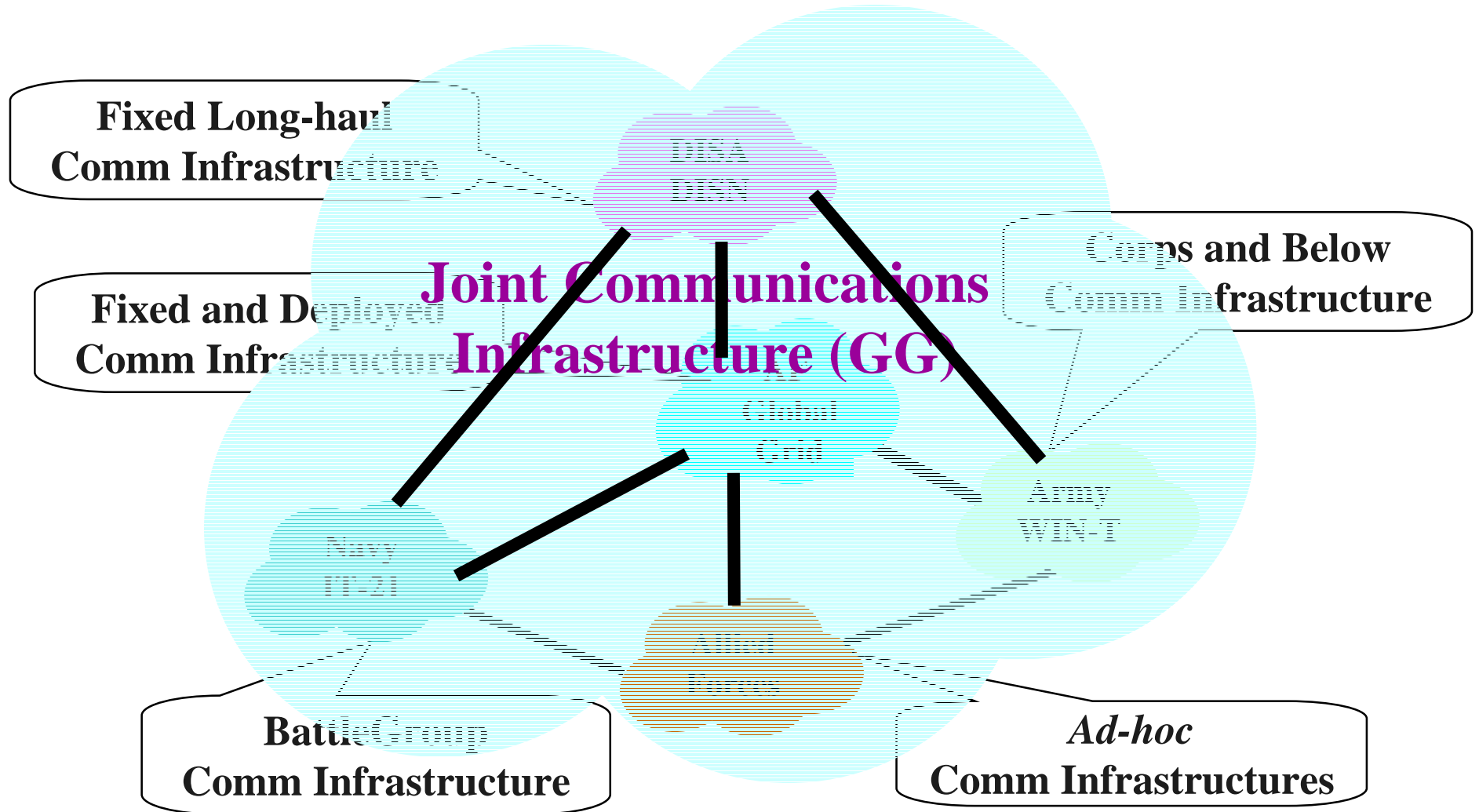



Top-Level Joint Battlespace Infosphere (JBI) - Global Grid (GG) Concept

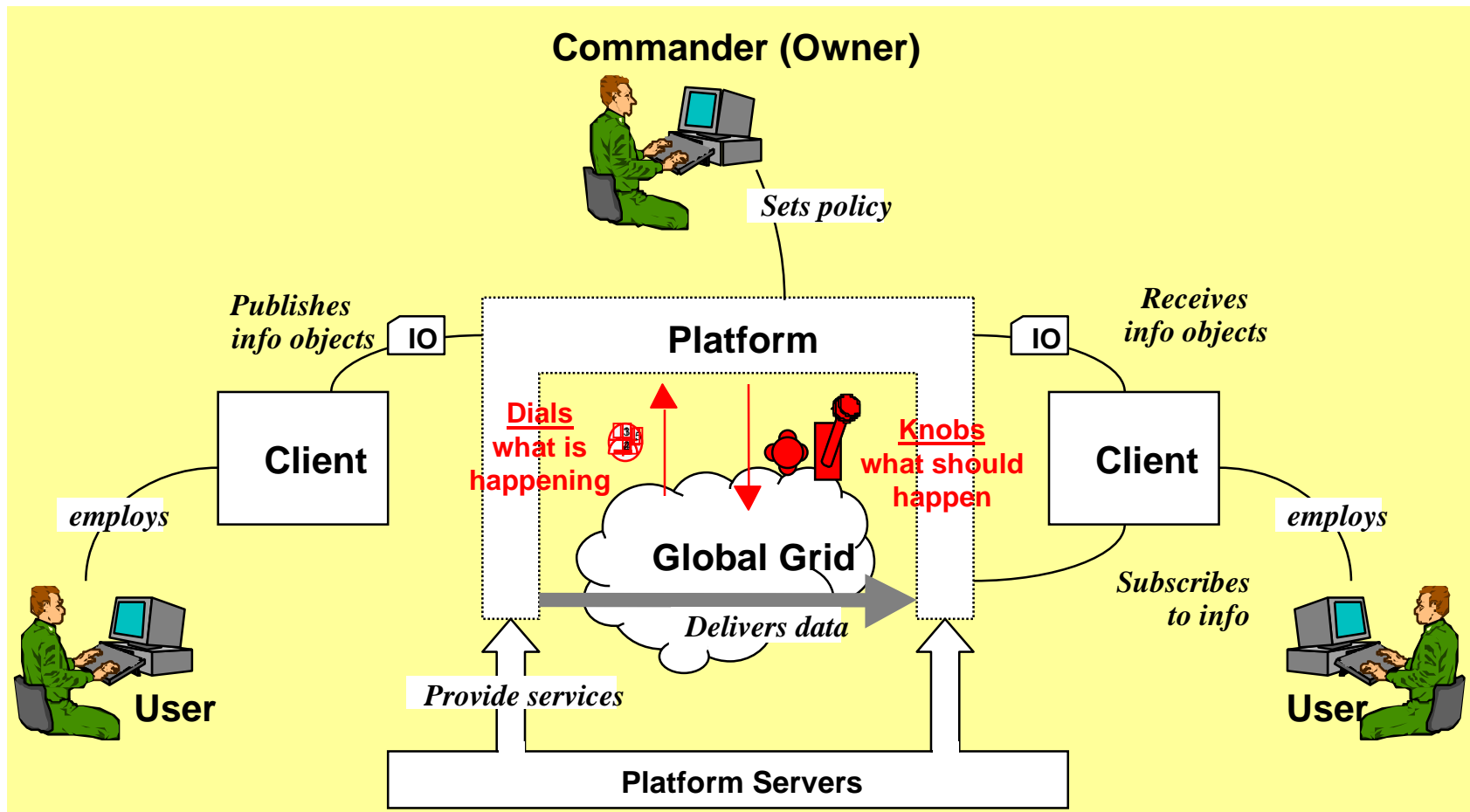



Some Architecture-Related Definitions

- **Architecture**: Structure of components, their relationships, and principles and guidelines governing their design and evolution over time [IEEE STD 610.12]
 - Operational: Viewpoint of User; Lead: AFC2ISRC
 - System: Viewpoint of Developer; Lead: ESC
 - Technical: Viewpoint of Provider; Lead: AF/SC & AFCA
- **Protocol**: Set of rules for processing communication data, managing communications functions, or providing communications security
- **Layer**: Portion of communication system architecture reference model encompassing closely related set of functions -- Protocols reside inside layers
- **Module**: Self-contained unit that can easily be replaced
 - Implementation of layer is module but module can encompass more than one layer



Some Architecture-Related Definitions (Concluded)

- **Interface between layers:** Directional boundary and associated application program interfaces (APIs) that enable two adjacent layers to interoperate
 - Simple, standardized interfaces can facilitate variety of layered implementations
- **Radio:** Any implementation of Physical and Link Layers (only) of communication system architecture
- **Network-Centricity:** Communications architecture attributes that facilitate interoperability among disparate Users
 - Network convergence, i.e., ability to utilize common networking protocol, viz., Internet Protocol (IP)
- **Global Grid compatibility:** Satisfied if one uses IP, can pass IP packets, and can exchange routing information using something like Border Gateway Protocol (BGP)
- **Tenet:** Principle that is useful as guide for achievement



Global Grid Architecture Tenets

- **Network-centric**
 - Common global network must connect to ALL centers and platforms
 - All Users are “addressees” on network
- **As much capacity as we can afford**
 - Capability-driven vs. requirements-driven
 - Network adapts to capacity available
- **Network must be modular and reconfigurable**
 - Adapts to meet changing User missions and battlefield conditions
- **Extensible**
 - Enables rapid technology insertion
- **Protection matched to threat**
 - Integrated security and protected links
 - Network adapts to threat



Air Force Network-Centric Global Grid Vision

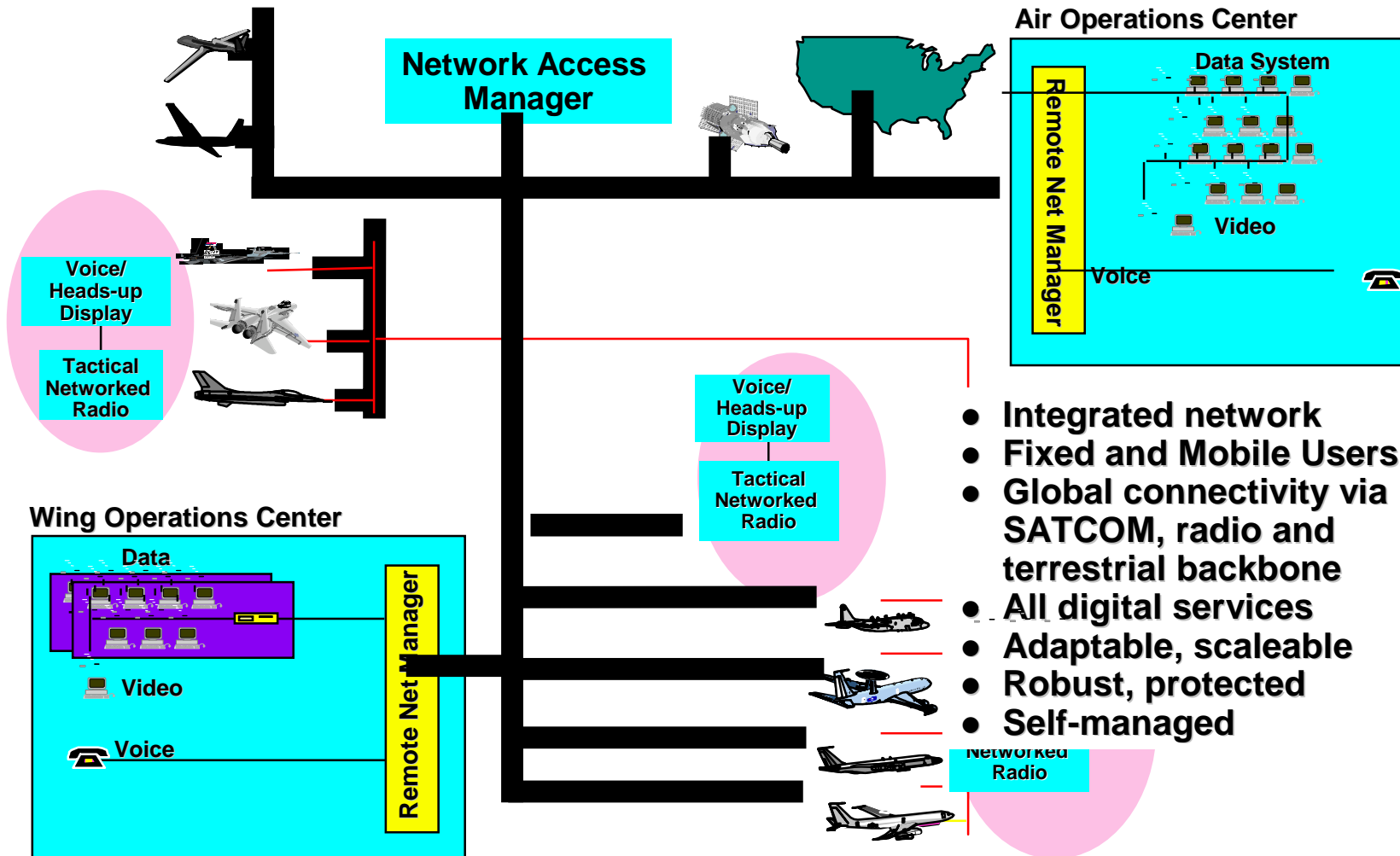

- Integrated network
- Fixed and Mobile Users
- Global connectivity via SATCOM, radio and terrestrial backbone
- All digital services
- Adaptable, scaleable
- Robust, protected
- Self-managed



Achieving the Global Grid Vision through a “Layered” Comm System Architecture

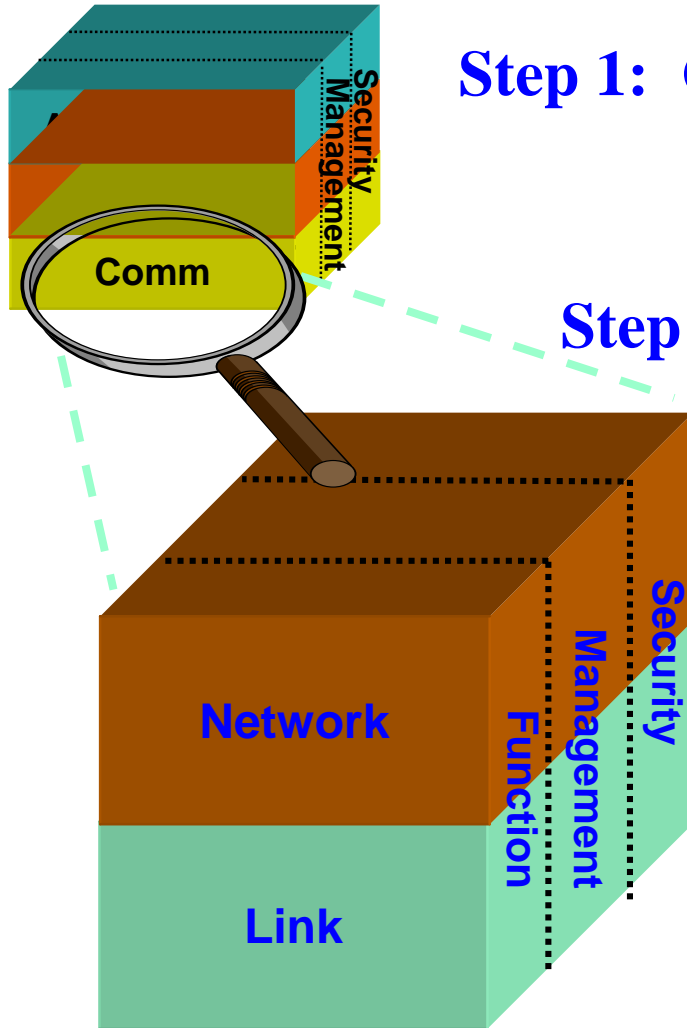

Step 1: Connectivity to all Users

- Connect links to a network
- Interconnect networks

Step 2: Capacity Users can afford

- Efficient use of RF spectrum
- Adaptable to needed bandwidth
- Higher data rate wireless comm

Step 3: Control by User

- Quality of service (QoS)
- Autonomous management
- Information assurance



Challenges: Applying Layered Architecture

Distributed Information System Reference Model

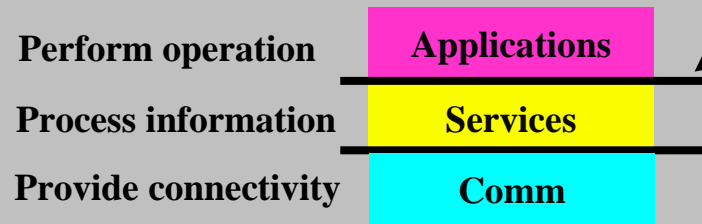

Architectural Challenge:

- **Defining boundaries between functional layers**
 - Utilize common services
 - Network-centric -- “ignorant” of information
 - Links adapt to needs of media environment
 - Separation of messages from the media

Integration Challenge:

- **Communication system is created vertically**
 - Provides communications service to a program
- **Communication must be designed horizontally**
 - Creates infrastructure for Air Force
 - Facilitates Joint interoperability
 - Lays basis for coalition partnerships
 - Could lead to cost savings

Used to design system vertically as “stove-pipe”.

Now design with interfaces and get whole new vertical capability, e.g., broader set of applications and communicate with more people.

Design horizontally; integrate and use vertically.



Developing the Global Grid

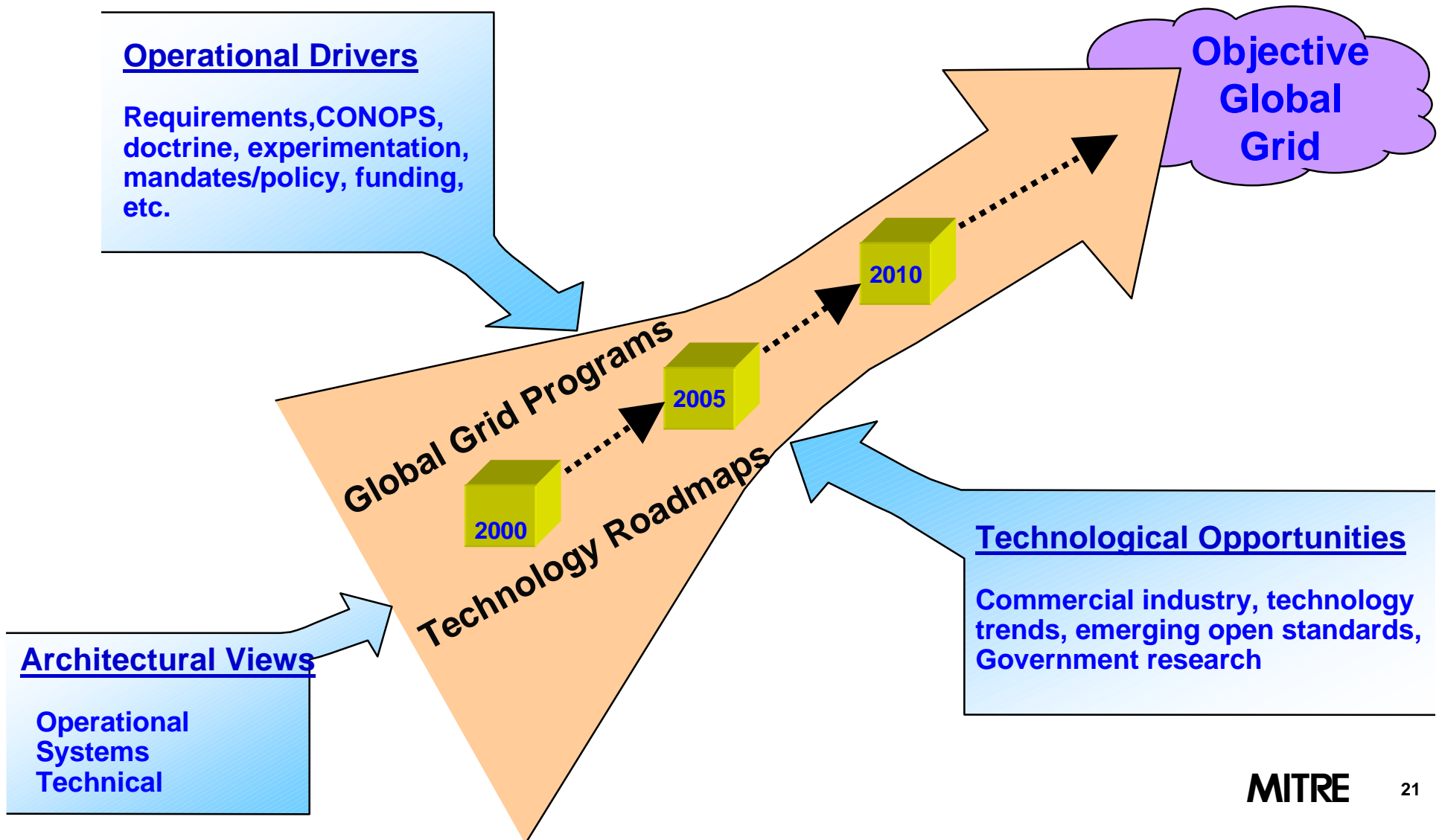



Air Force Global Grid Network Status

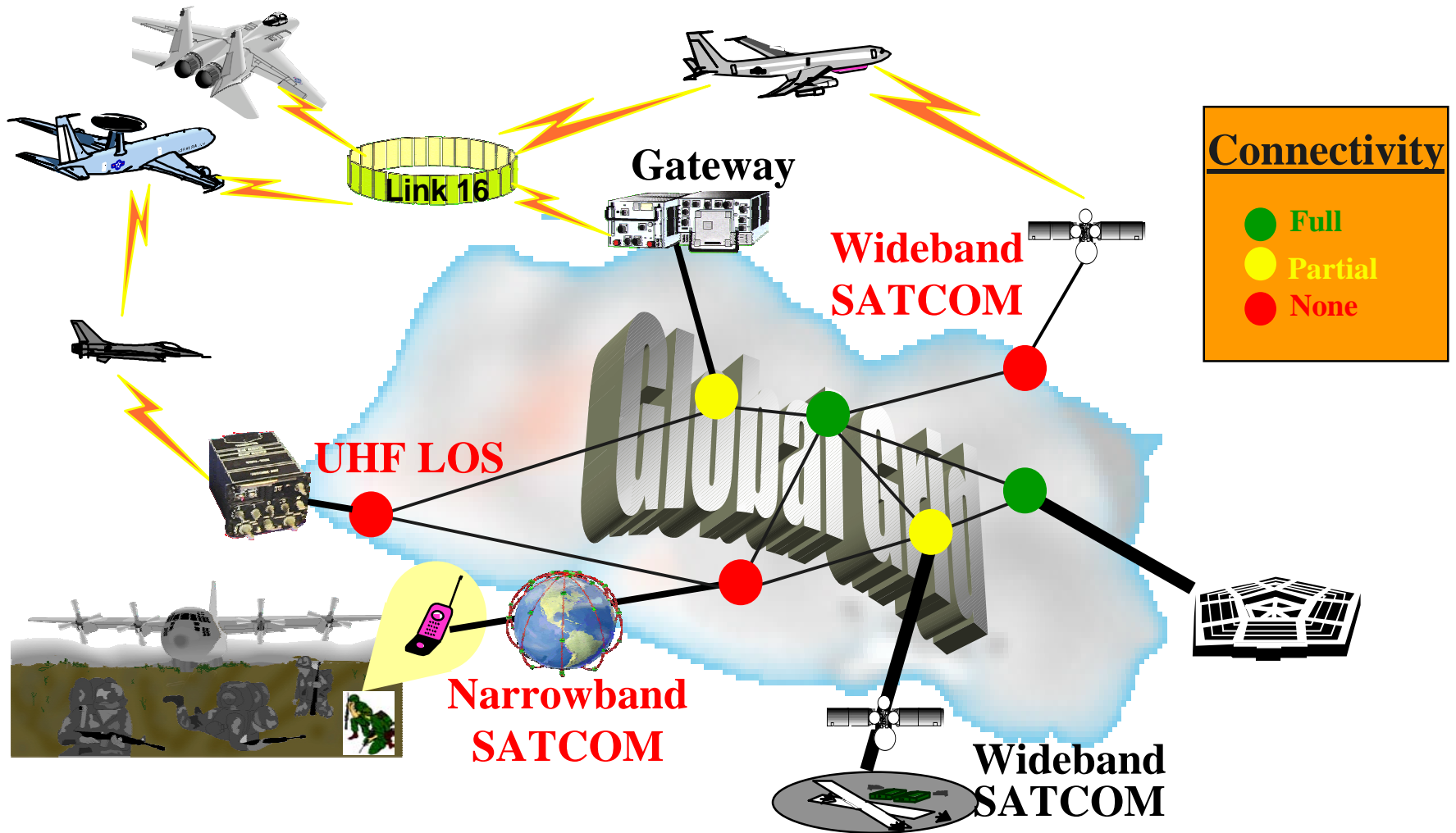



Layered Architecture



Layered Architectural Approach is Advocated But Why Layer?

- **Properly layered architecture is advocated as approach to achieving Global Grid vision**
 - Partitioning of system functions within independent groupings, i.e., layers or sub-layers
 - Each layer brings its own resources
 - Adoption of open, standard interfaces between layers
- **But why layer?**
 - Based on proven commercial implementation of Internet
 - **Flexible: Allows systems to evolve with fewer constraints**
 - **Extensible:**
 - Future -- even unknown -- technologies can be introduced with relative ease
 - Number of network nodes can grow without bound



Plan on Obsolescence -- Be Flexible and Extensible

- **Specify the components, then *integrate* the system to suit the immediate need.**

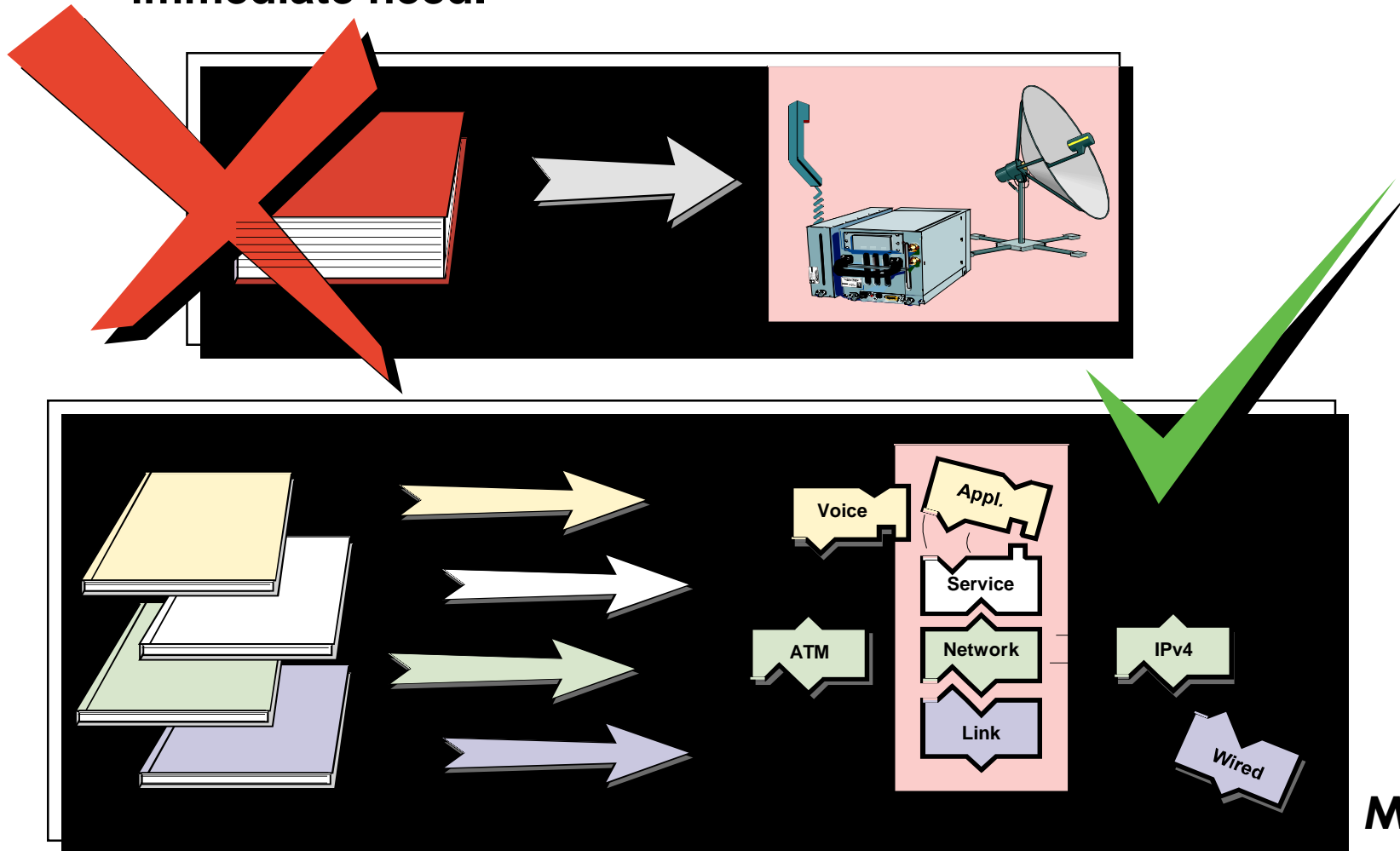



Global Grid Reference Model (GGRM) is Hybrid of OSI and TCP/IP Reference Models

OSI

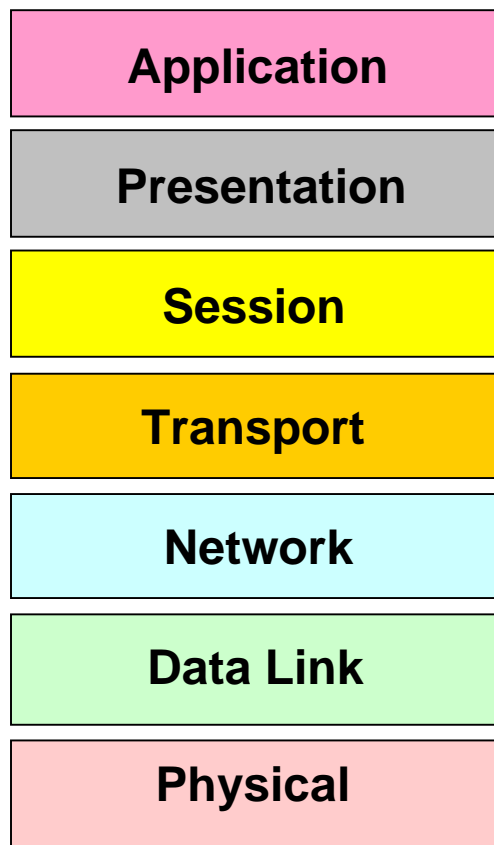

TCP/IP

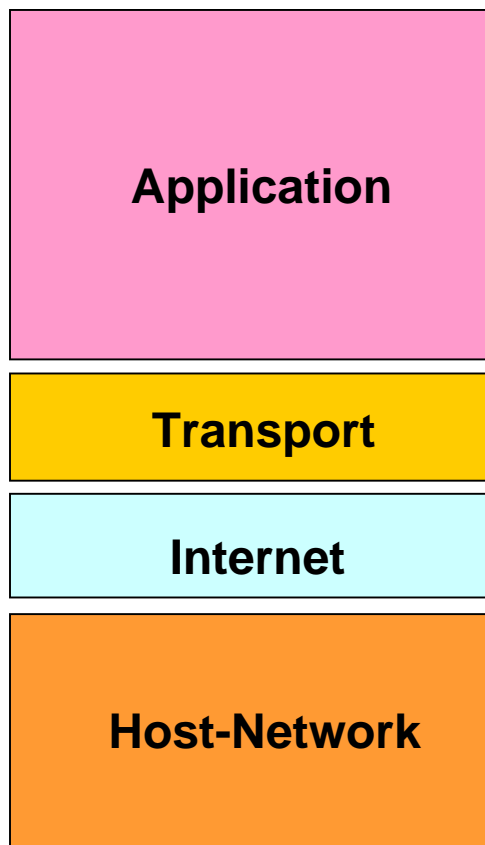

Global Grid

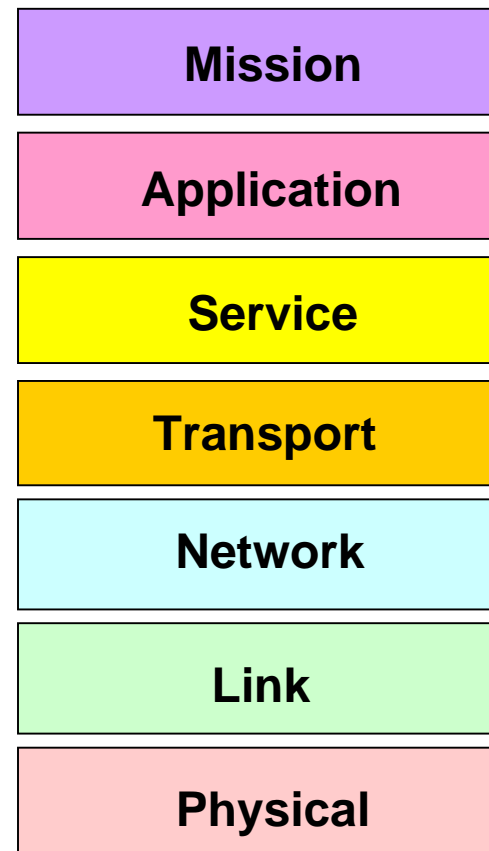



Comparing/Contrasting OSI and GG Models Layer and Sublayer Definitions

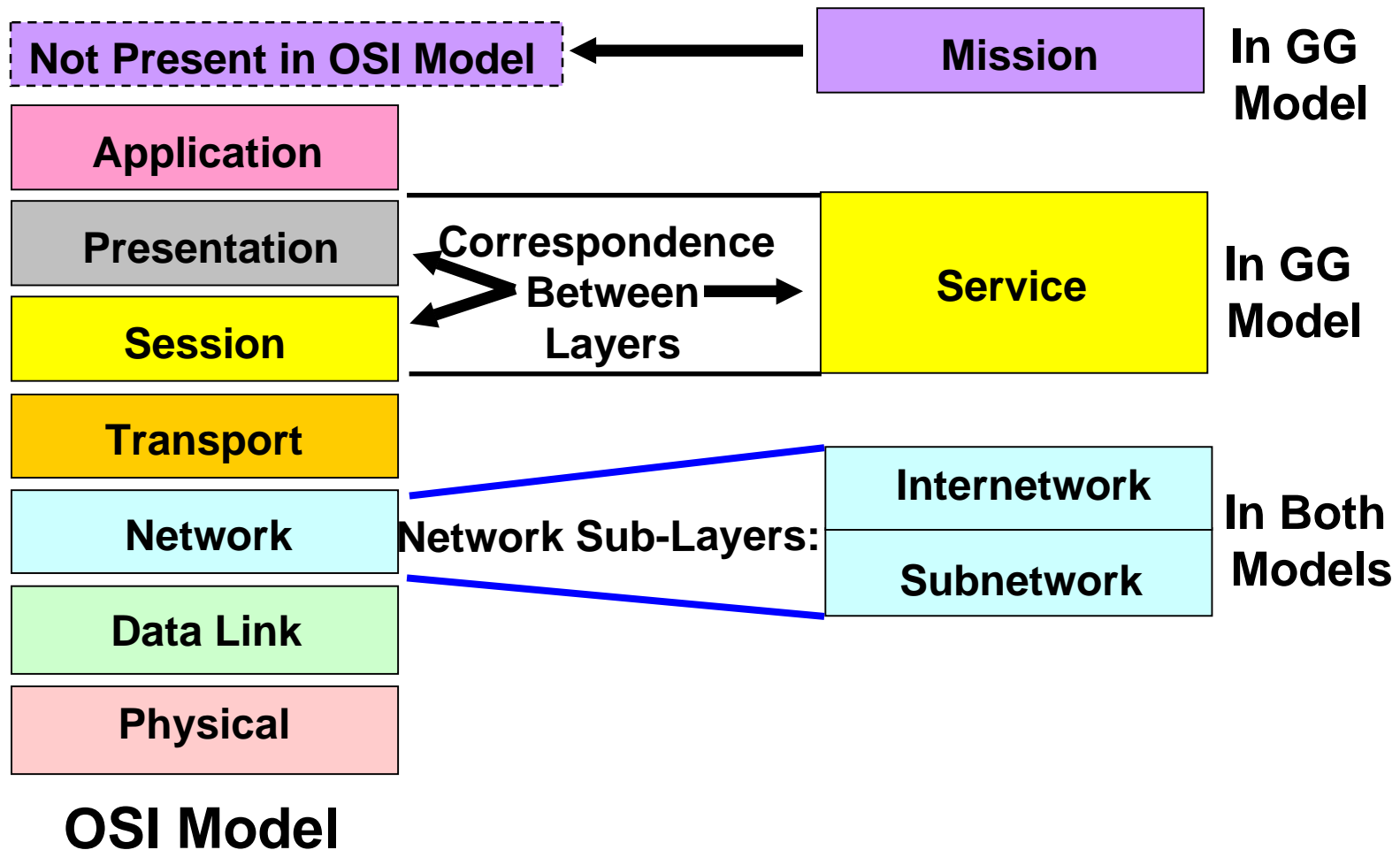



Comparing/Contrasting OSI and GG Models Layer and Sublayer Definitions (Concluded)

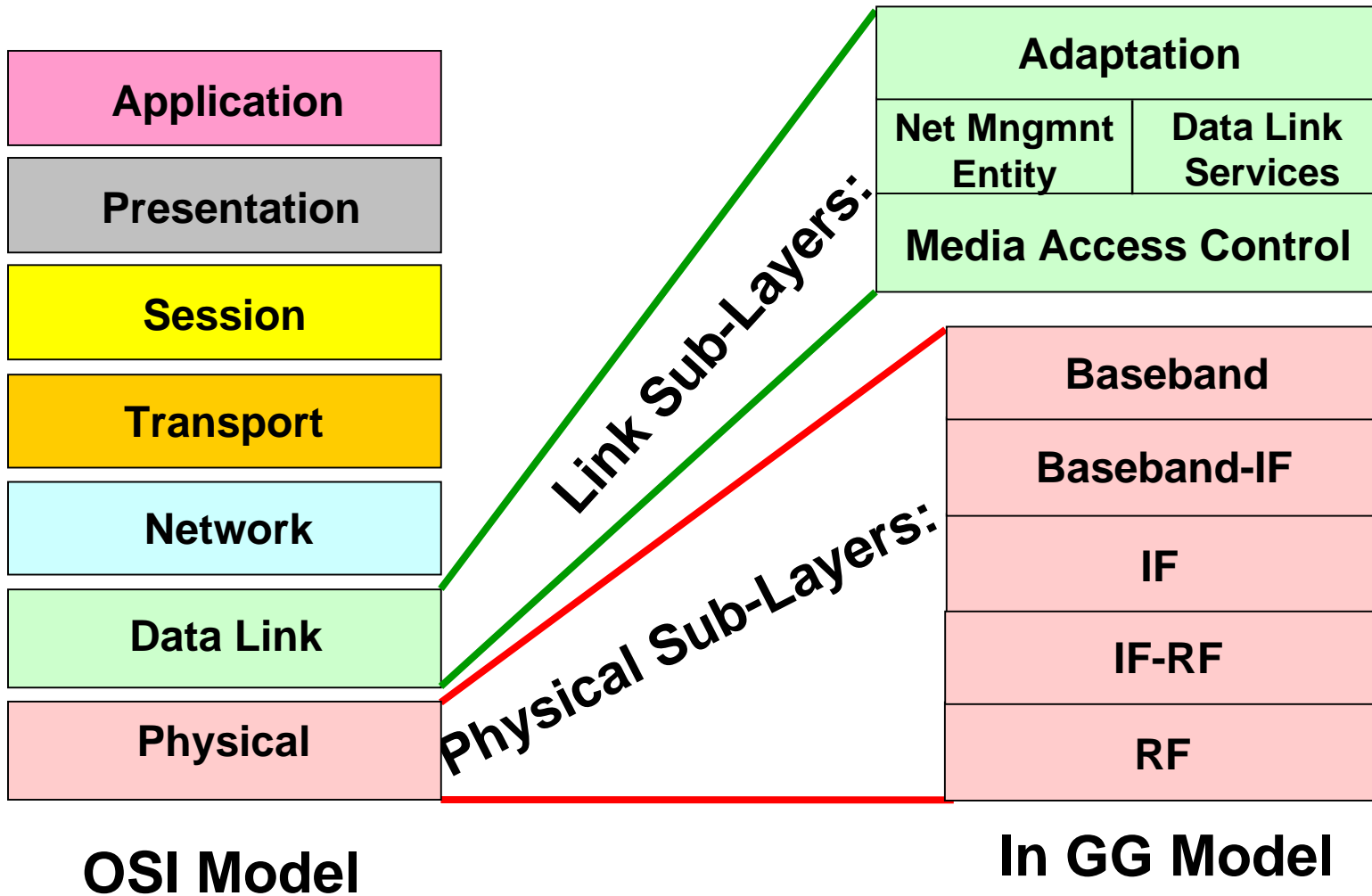



Generic Data Flow Operations GGRM Layers

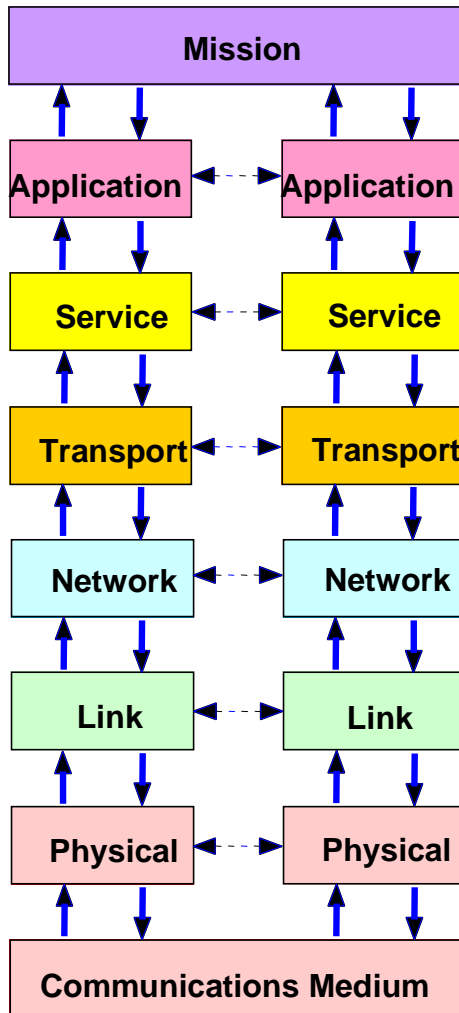

Generically for each layer:

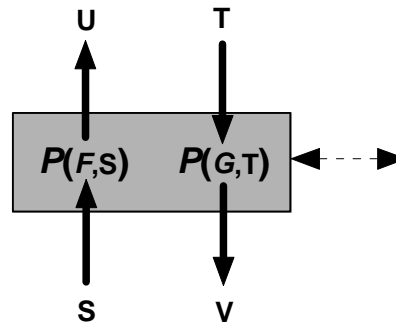

S and V are “streams” of data (or signals at the physical layer)

U and T are streams of data

F and G are functions performed within the layer

P is the layer protocol that operates on the functions and the streams

◄ --- ► represents logical peer-to-peer communication

Notes:

- The GGRM includes a technical architectural framework for analyzing and placing (among model layers)
 - All communication applications, protocols, and functions
 - Management and security functions
 - Standard interfaces between layers.
- The GG focuses primarily on the Transport and Network Layers and their associated interfaces.
- However, in the wider sense, the four bottom layers from the Transport Layer down can be considered part of the GG infrastructure.



Service Modeling of Layering

On the left, Layer N obtains services from Layer N-1 ($N = 2, \dots, 6$, for a 7-layer model) in order to perform formatting and procedural functions. Similarly, on the right. The two N^{th} Layers cooperate logically using the same protocol.

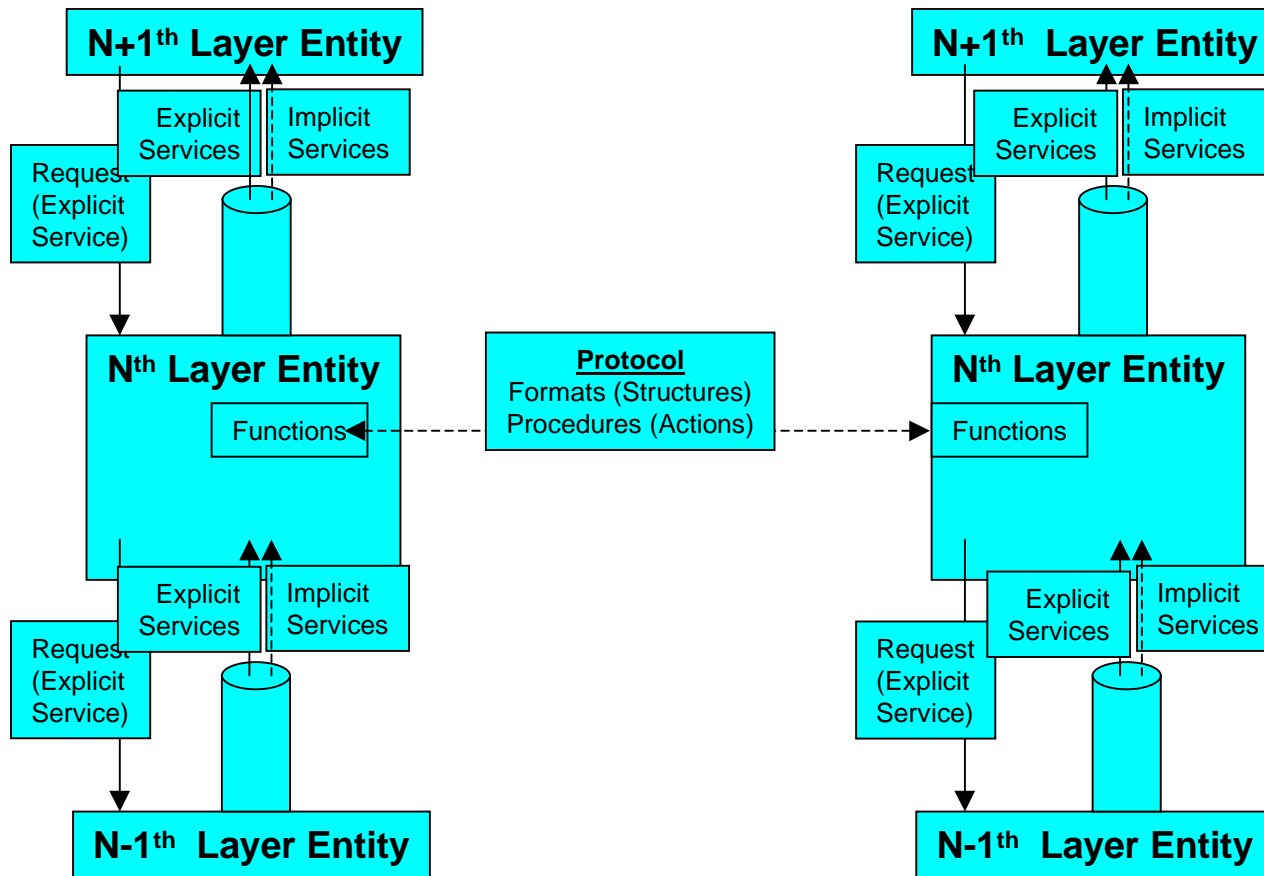



Applying GGRM to Air Force Enterprise Management

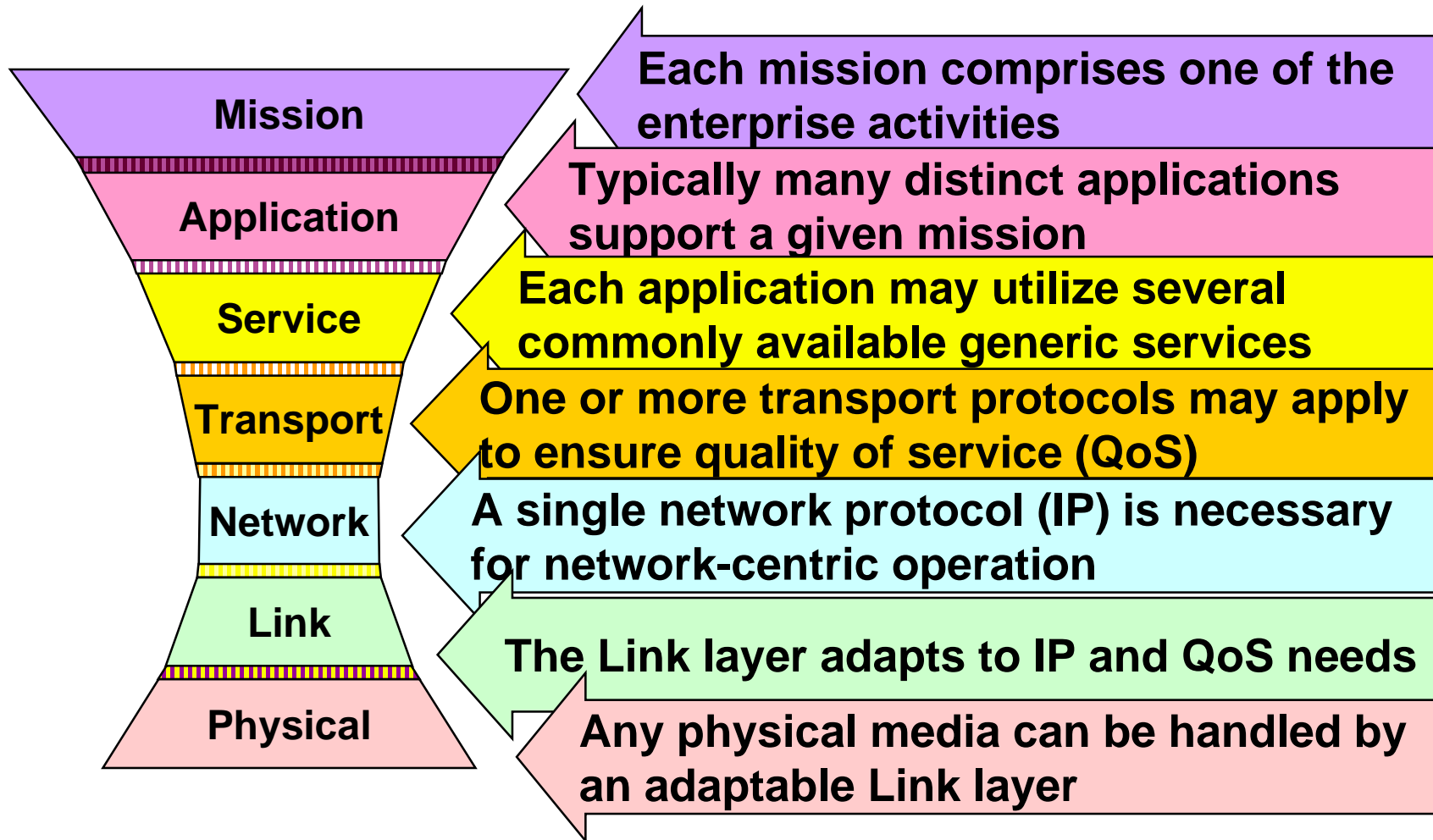



Mission Layer Functionality

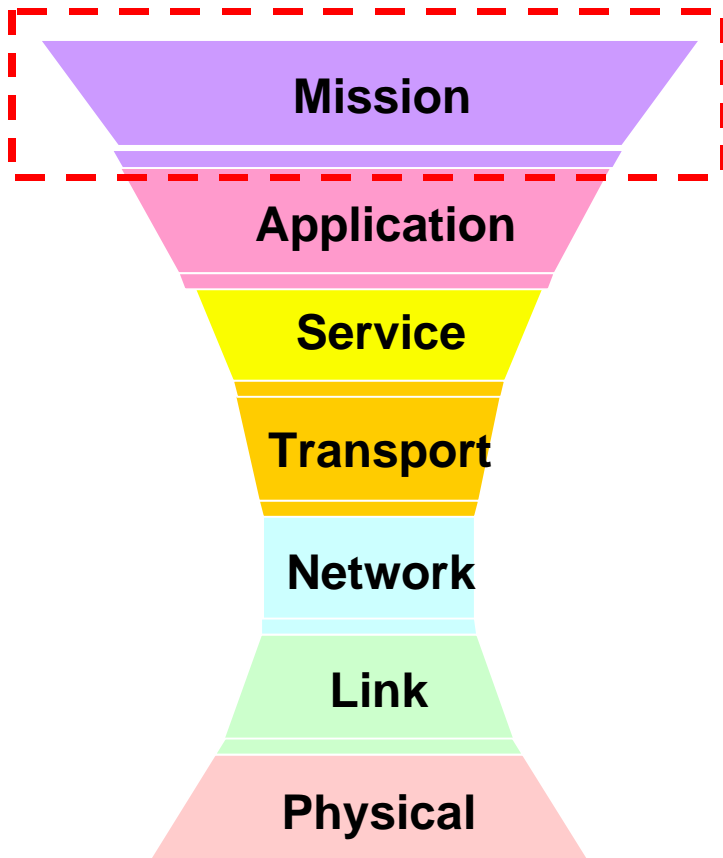

- Enterprise management contains many missions representing warfighting operations carried out by Air Force commanders, e.g., C2/ISR missions
 - AMTI/GMTI/SAR
 - NCCT/ISR
 - DTIG
- Each mission
 - Can be represented as a set of business processes
 - Involves the integrated use of multiple C2 systems and their related applications.



Application Layer Functionality

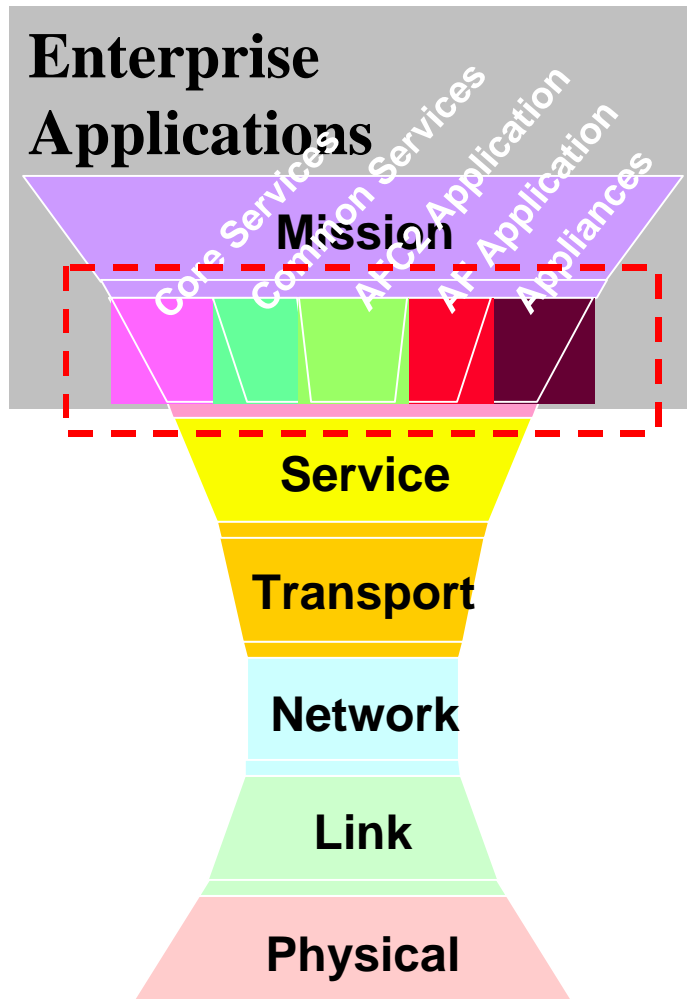

- The Application layer includes all AF enterprise applications that can be categorized as
 - Network core services
 - Common User services
 - AF C2 and ISR applications
 - Other AF applications
 - Information appliances.
- Other applications that User accesses directly, e.g.,
 - HTTP*
 - Telnet
 - X.400, X.500

* Also, could be viewed as being at the Service Layer



Service Layer Functionality

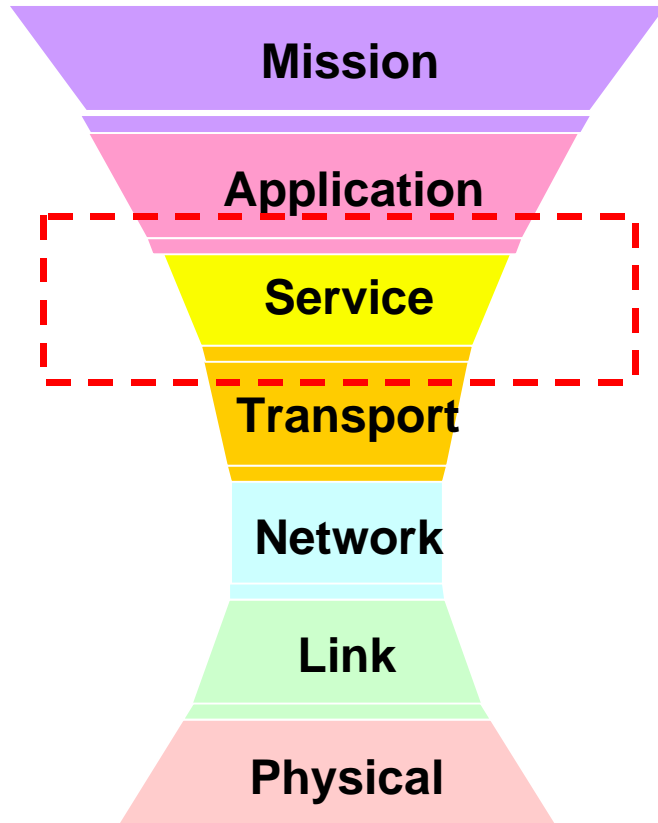

- The Service layer provides utilitarian services for supporting many applications, e.g.,
 - Message formatting standards, e.g.,
 - XML
 - TADIL-J
 - DII/COE software
- The TCP/IP suite contains many protocols considered to be at the GG Service layer, e.g.,
 - FTP*, SMTP
 - SNMP, MIB-II
 - OSPF, BGP4

* Also, could be viewed as being at the Application Layer



Transport Layer Functionality

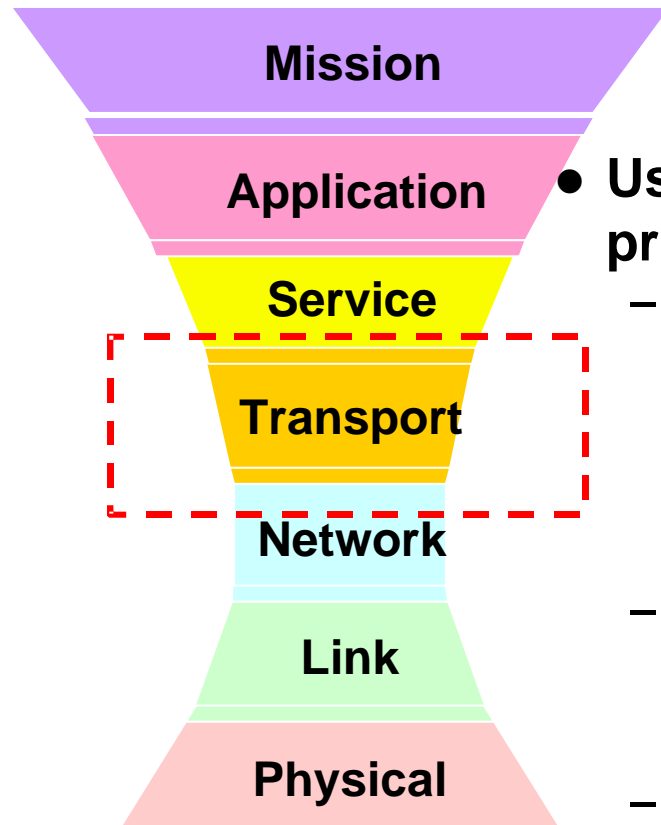

- Uses a minimal number of transport protocols -- TCP, UDP, etc.
 - TCP is a connection-oriented (“reliable”) protocol that ensures delivery of intact data, including
 - Scaled Window Option
 - Congestion Control
 - UDP is a flexible, connectionless (“unreliable”) protocol that does not ensure delivery of intact data.
 - TCP/UDP-to-IP and IP-to-TCP/UDP



Network Layer Functionality

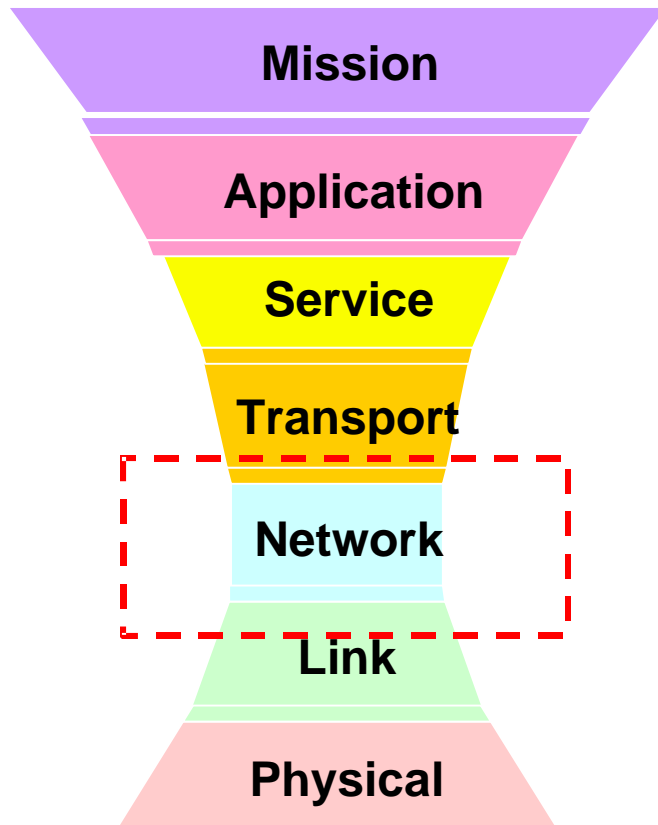

- Use a common network protocol, viz., the Internet Protocol (IPv4); IPv6 is under development and has many improvements.
- IP includes many sub-protocols, e.g.,
 - ICMP
 - IGMP
 - ARP
 - RARP
- Other networking protocols such as
 - IPX
 - IBM networking protocol
 - X.25are expected to die by attrition.



Link Layer Functionality*

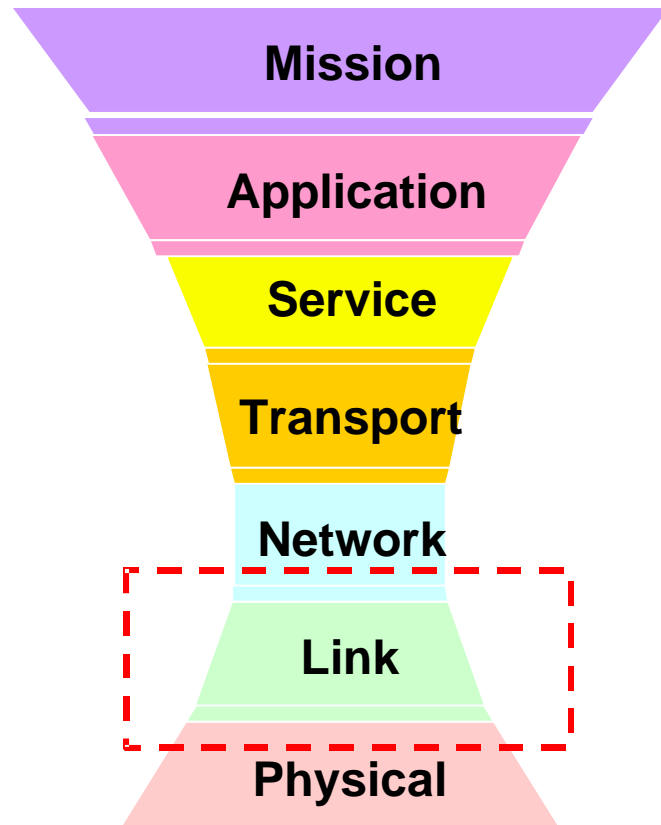

- **Asynchronous Transfer Mode (ATM) (LAN emulation protocol; ATM Forum specified)**
- **Ethernet (IEEE 802.3; 802.1p-QoS)**
- **Frame Relay**
- **MPLS**
- **Serial**
 - HDLC
 - PPP (full-duplex serial data links [RFC 1661]; IETF specified) provides
 - Datagram encapsulation
 - Link control
 - Network control

* All protocols listed are standard and support the Internet Protocol



Physical Layer Functionality

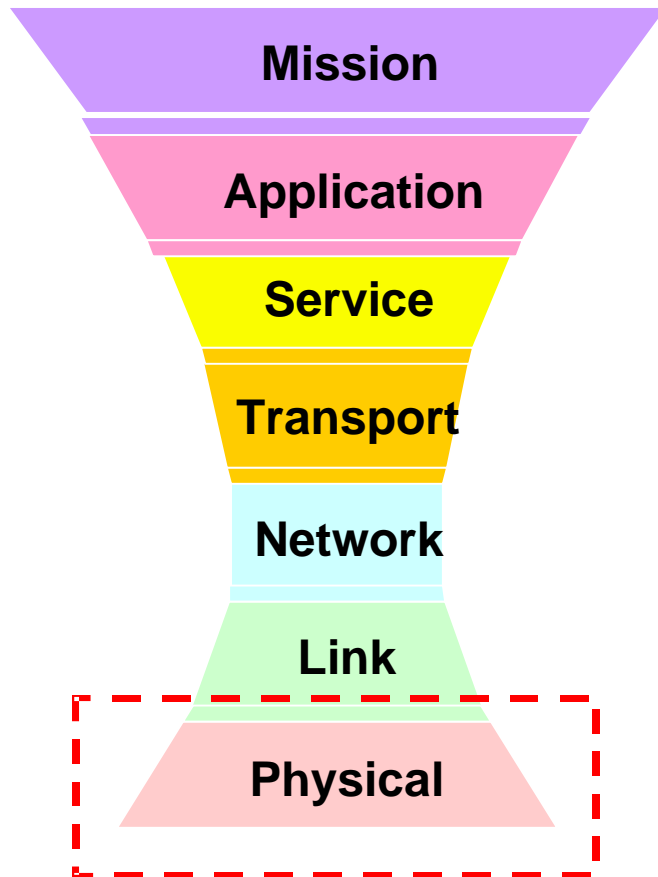

- **Typical wired physical media**
 - **Copper - twisted wire, e.g.,**
 - Ethernet 10 Base T
 - 100 Base T (802.3 PHY)
 - **Copper - coax, e.g.,**
 - Ethernet 10 Base 2 (802.3 PHY)
 - **Fiber, e.g.,**
 - FDDI PHY (X3.148)
- **Important wireless physical media**
 - **Satellite**
 - **Radio**



Summarizing Roles of Global Grid Reference Model Layers

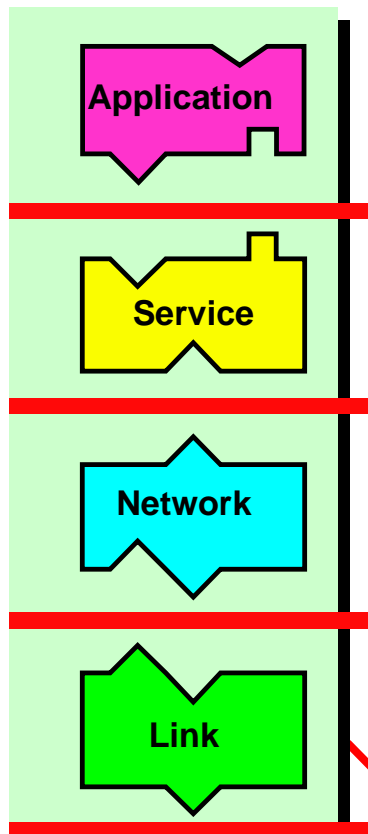

- Simplifying layer descriptions by combining three layers
 - Mission/Application
 - Service
 - Transport/Network
 - Link/Physical
- User interacts directly with Application Layer applications
- User does not interact directly with Service Layer applications
- Network connects with any other node via Internet Protocol
- Link only connects with same type Link over single “hop”

A radio is an implementation of the Link Layer.



Layering is *Ubiquitous* in Networking; It *Can Be Applied* to Radios...

- In the layered view, a “radio” is only one part of a complete, network-centric military communication system.
(And the “link” is where most military specific needs are...)

A “radio” implements only the lowest layers of the communication system. It is a “device” much like an Ethernet card or phone line modem.

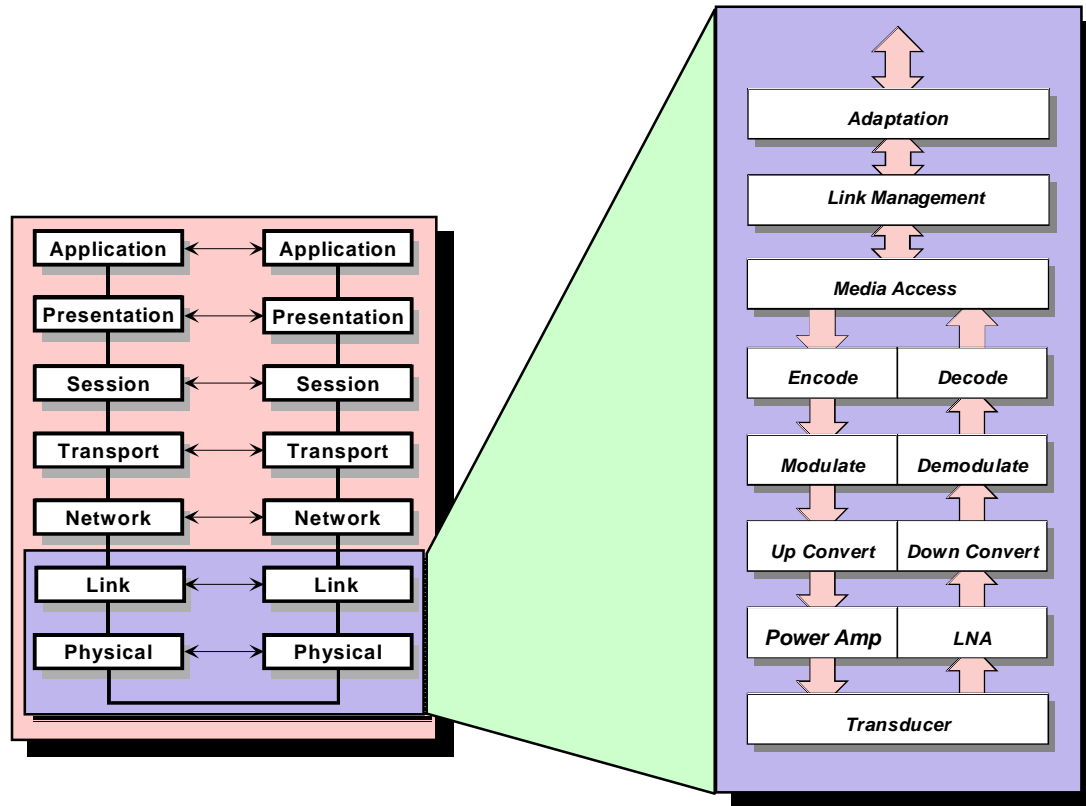



Layering Concepts are Applicable *Within* the Radio As Well.

- Decomposing the “radio” improves flexibility and enables component re-use.

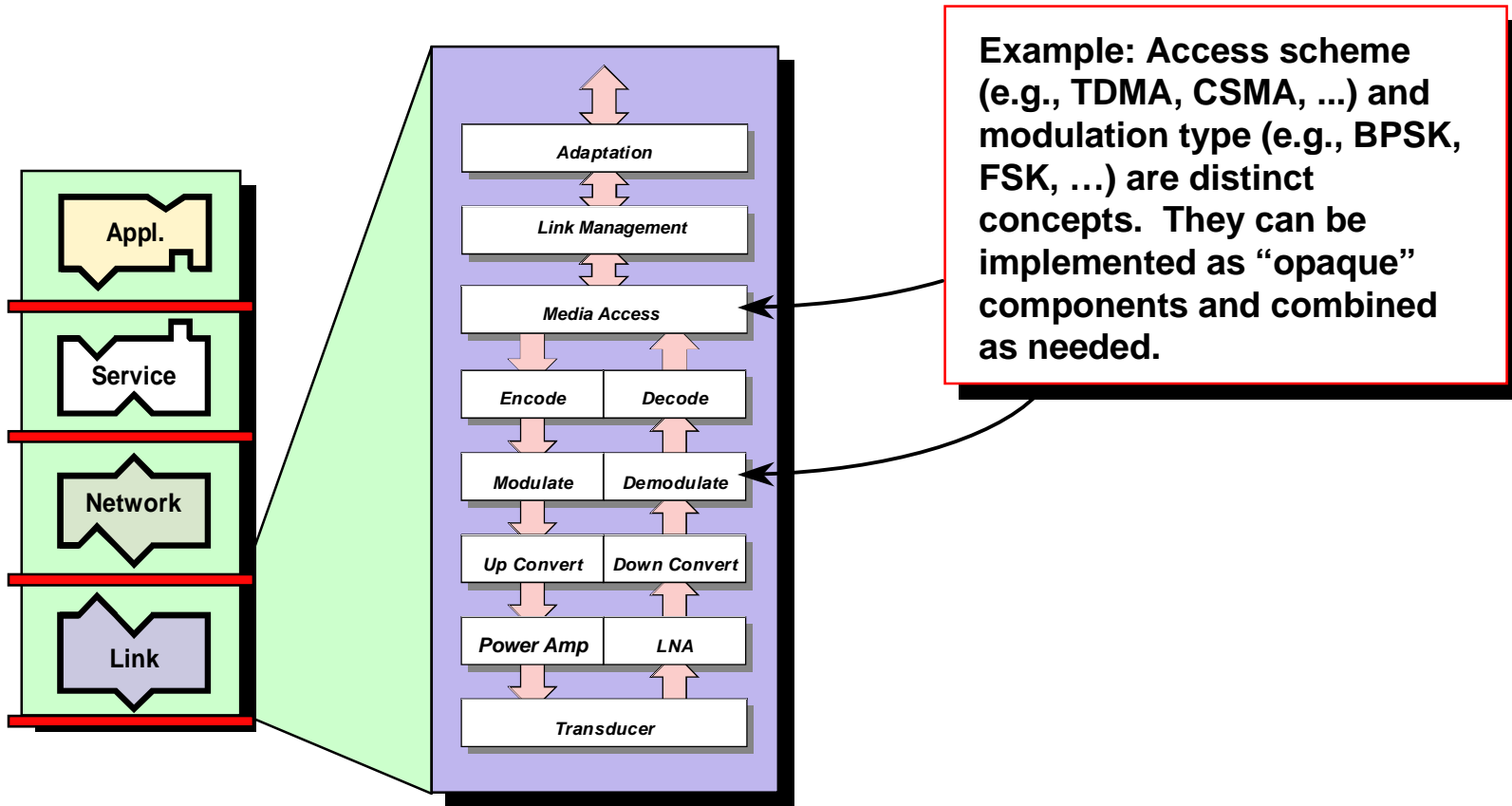



Adaptive RF Links

- Focus

- Protocol agnostic*, *adaptable*, wireless data links

- Challenges

- Achieving per-packet adaptation
- Standardizing control interface

- Impact

- Will provide open, inexpensive, adaptive, tactical radios

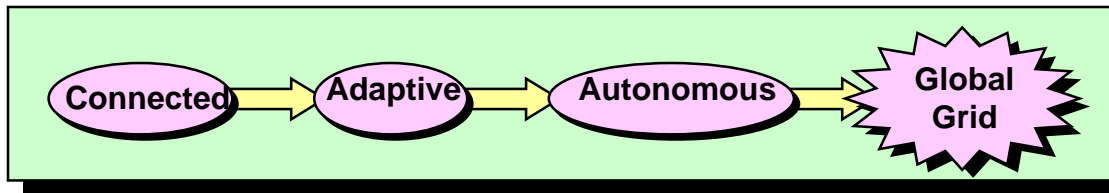
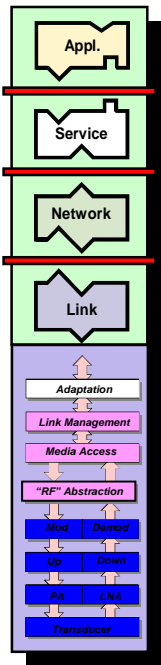
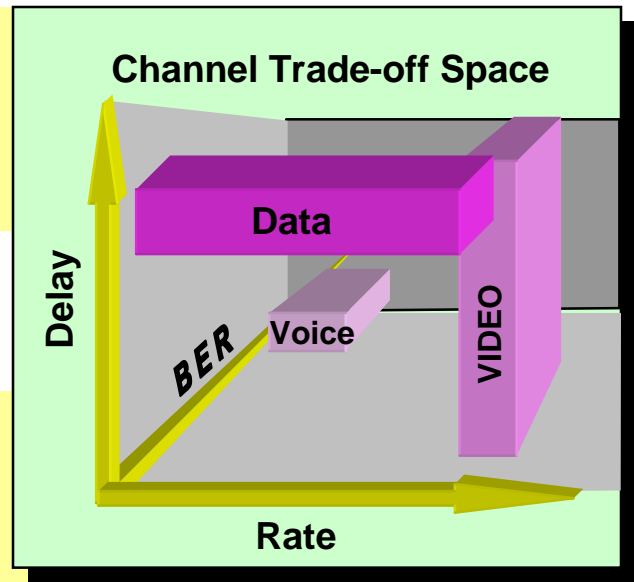

* Non-committal; non-dogmatic



Doesn't This Layering Preclude Integration?

- No, layering and integration complement each other...

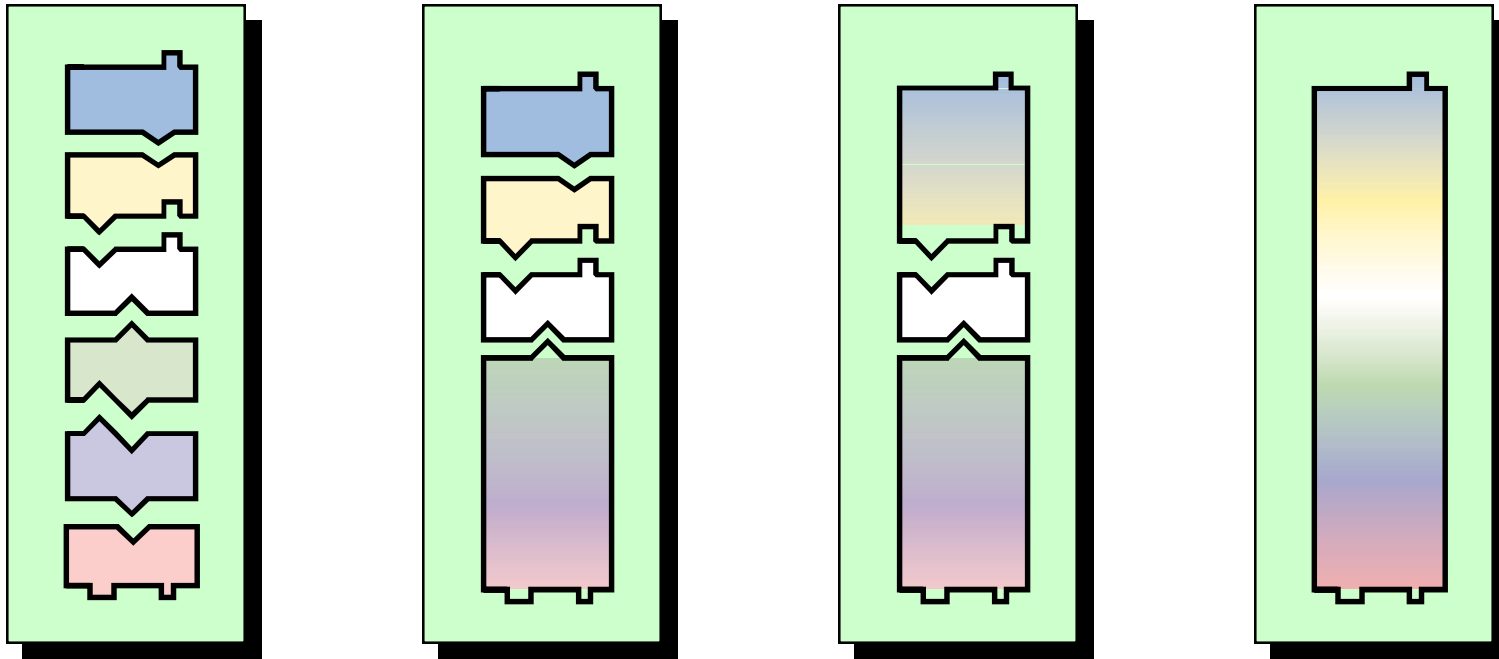

Exposed interfaces must be standard, but not all interfaces need be exposed.



Why Must We Change “INFOSEC”?

- In a heterogeneous network, we need to decouple concepts like data “privacy” and link “robustness/covertness”
 - “Privacy” is an end-to-end issue. Only the source and destination applications should ever see the data.
 - “Robustness/covertness” are link-specific issues. Each link may need to apply different protection schemes. There may be many links along one routed connection.

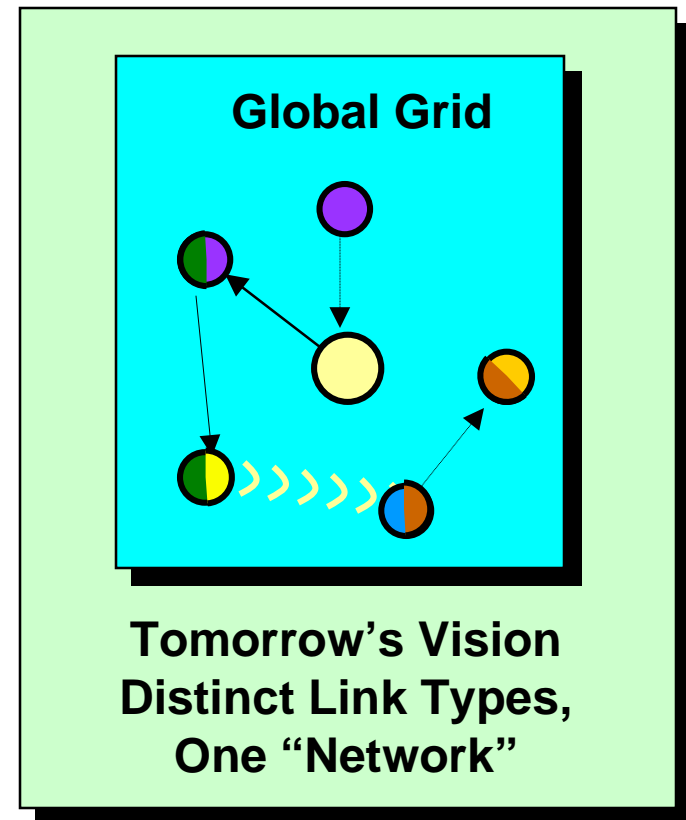



Partitioning INFOSEC/COMSEC - “Basis Vectors” for Security?

- “Security” is really several functions

- Non-repudiation →
- Privacy →
- Integrity →
- Authorization →
- Key Management →
- Authentication →
- Robustness →
- Covertness →

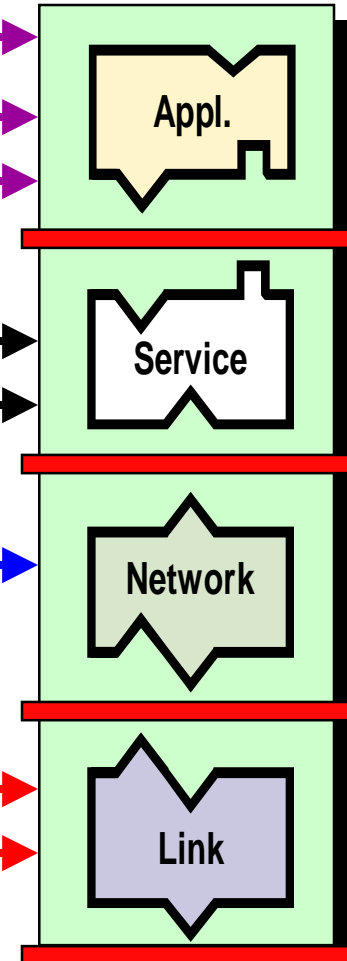

These functions should be *considered* separately; given function might be associated different layer than shown



Connectivity Among Network-Centric Radios

Multi-Link Capable Node

Enabling principle: Everyone uses the same networking protocol, viz., IP, and has an IP address.

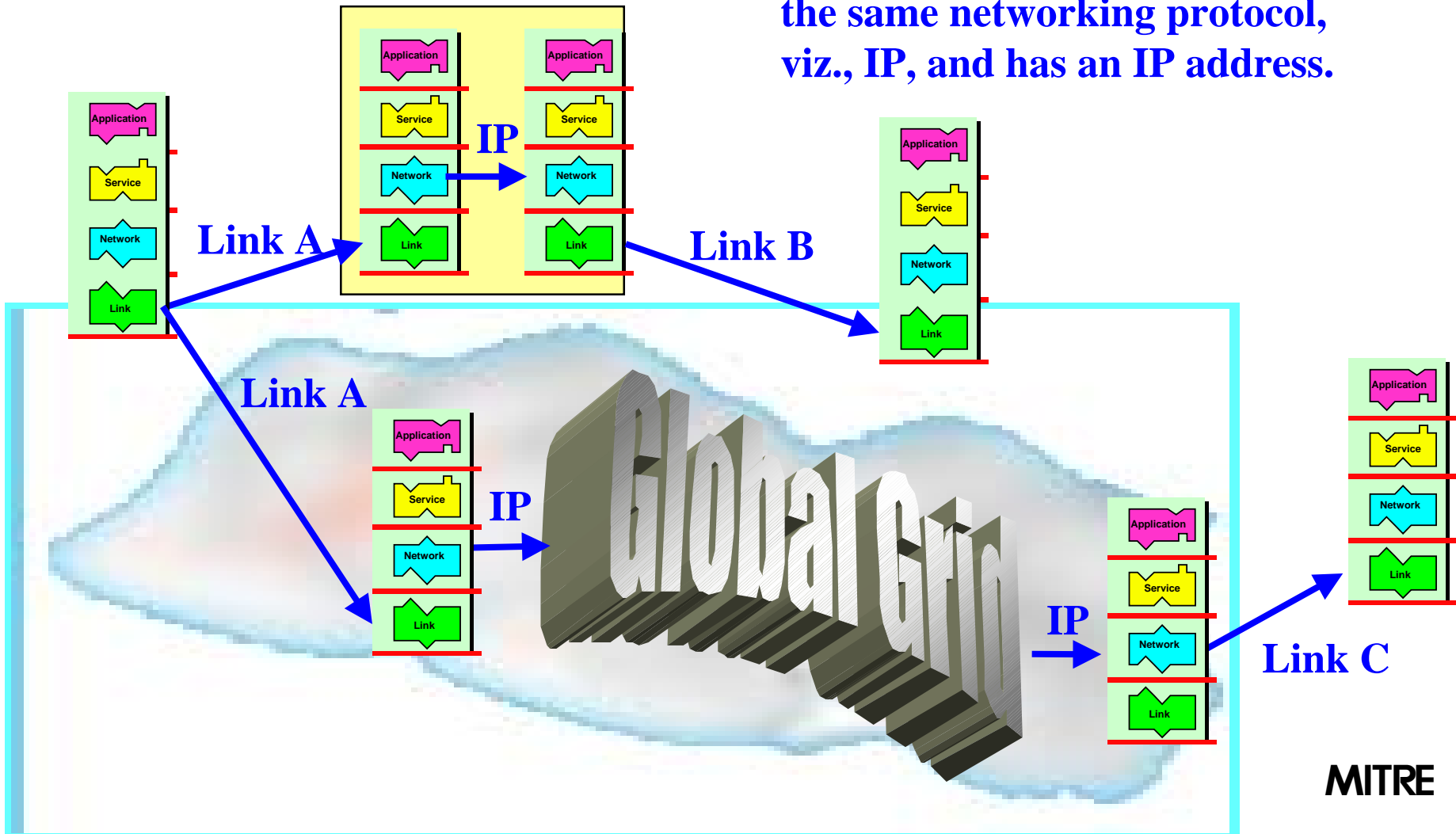



Our View of Architecture -- Definition and Properties

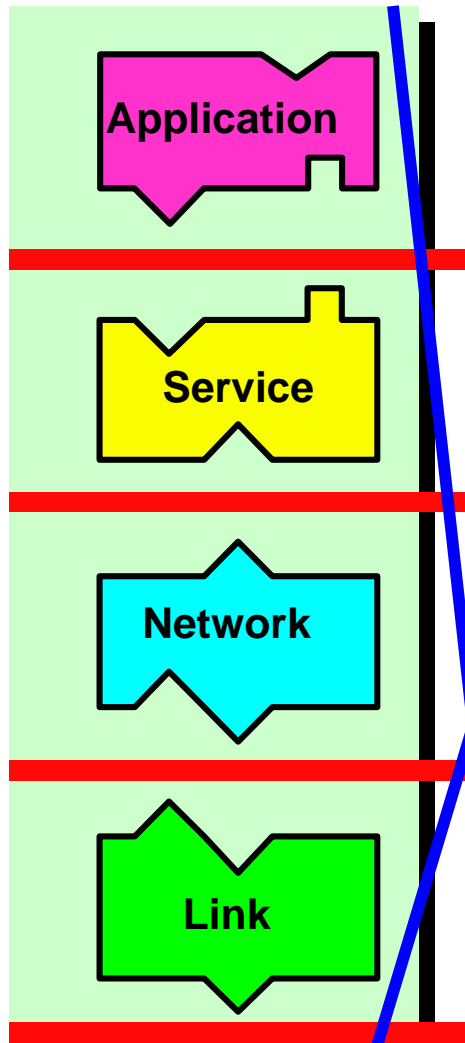

- **Definition:** Structure of components, their relationships, and principles and guidelines governing their design and evolution over time
- **Good architecture should**
 - Be independent of technology
 - Embrace alternative implementations
 - Not change (much) as system evolves
- Provides top-level design guidance
- Defines classes of technology available
- Changes slowly compared to
 - Technologies
 - Implementations
- **Layering** is recommended as way to ensure technology- and implementation-independence
- Interoperability can be achieved with horizontal integration (using common, e.g., XML and IP, standards and separating messages from Link Layer media)
- Build “robust” links without networking functions



Getting Connected



Migration Strategy

- **Today's subnets are largely unconnected**
 - Each built to meet individual community needs
- **Near-term and mid-term strategy**
 - Use gateways to achieve connectivity among subnets
 - Each community must plan to evolve its subnet toward future Global Grid vision; e.g.,
 - ESC DAC Directive 002 - Use IP
 - Systems-of-systems strategy must be developed for managing across gateway-connected subnets
- **Long-term strategy**
 - As each community achieves its plan, need for stand-alone gateways will diminish
 - End-to-end strategy for achieving enterprise Global Grid management must be developed



A Simple Internetworking Example

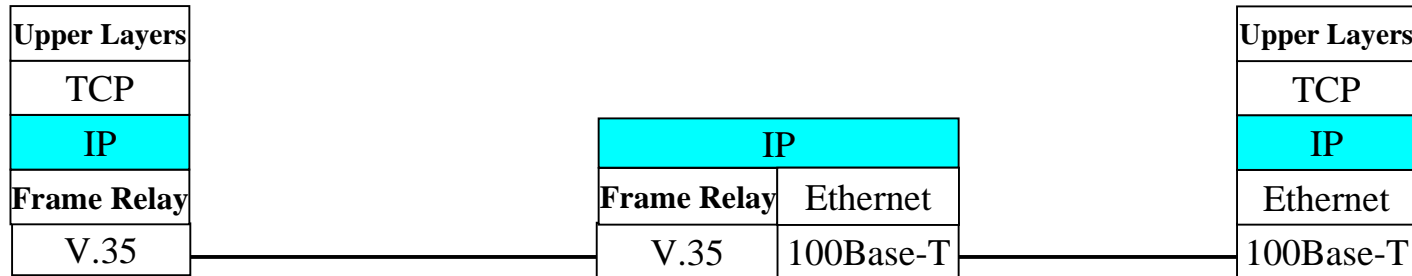
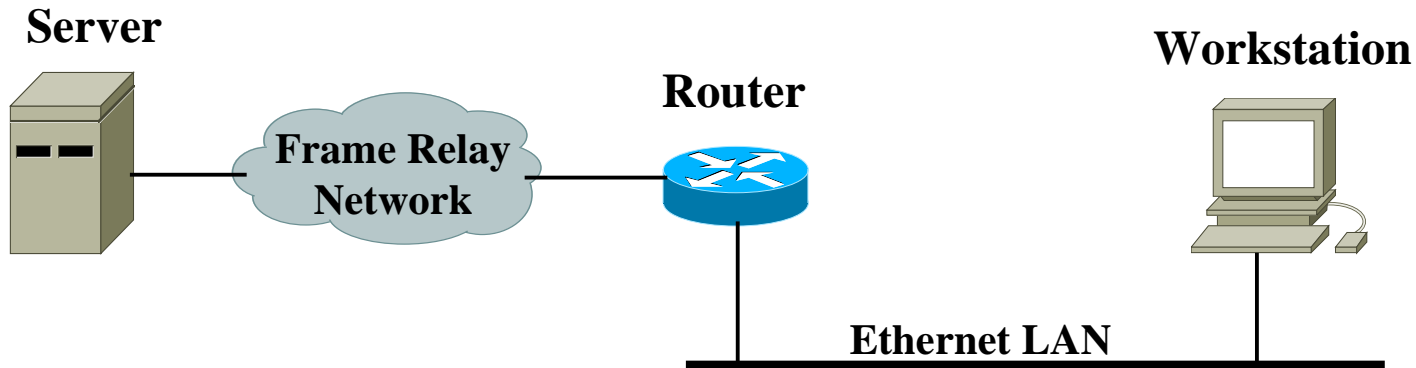

End Stations have nothing in common below the IP layer, but they're still "connected".



The Internet Model

IP Over Many COTS Link Layers

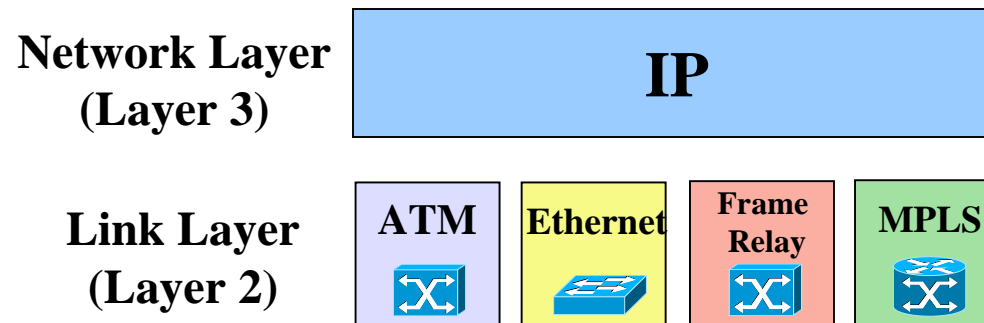

These commercial links have broad support on a variety of devices (PCs with various OSs, routers, firewalls, etc.)



But it Took Lots of Work to Make This Happen

Lots of specifications:

RFC 894-IP Over Ethernet

RFC 826-ARP Over Ethernet

RFC 2226-IP Broadcast Over ATM

RFC 2225-IP, ARP Over ATM

RFC 1932-IP Over ATM Framework

RFC 1926- Encapsulation of IP Over ATM

...And Many, Many Others!

Plus, hundreds (probably thousands) of Network Device Drivers for Windows (3.1, 95, NT, 98, ME, 2K, XP, etc), Solaris, MacIntosh, Linux, FreeBSD, NetBSD, etc.

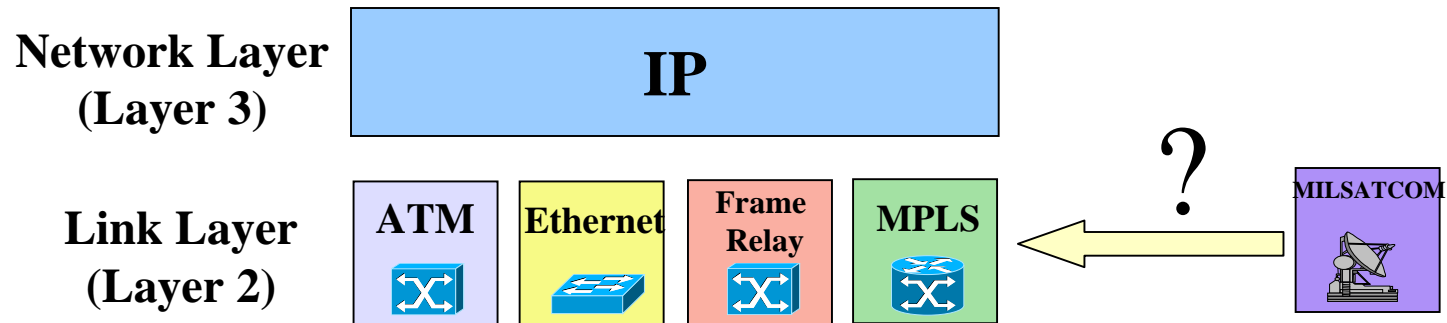

We cannot expect the same to be accomplished for all the different DoD Data Links!



But That's OK ... New Commercial Data-Links Face The Same Obstacle *They Have Successfully Worked Around It.*

- The secret is leveraging the existing base of broadly supported data-links (like Ethernet) in a terminal that transparently interfaces with the new data-link.
- Your cable modem is a commercial terminal that hides the cable data-link (DOCSIS) behind a standard Ethernet interface!



Ethernet

Cable TV Interface

(commercial data-link that doesn't fit Internet model)

MILSATCOM terminals can adopt this model, for example.



Some Protocols Useful for Instantiation of Global Grid-Compatible Network

Layer	Protocol	Reference	Notes
Application	BGP4	RFC 1775	Recommended for being part of the Global Grid.
	SNMP (including MIB-II)	RFC 1098	Recommended for being part of the Global Grid. The RFC references SNMPv1, which has minimal security features.
Transport	TCP (including Scaled Window Option and TCP Congestion Control)	RFC 793 RFC 1323 RFC 2001	Recommended for being part of the Global Grid. Current implementations do not support efficient communications over certain links, i.e., those with large delay-bandwidth products
	UDP	RFC 768	Recommended for being part of the Global Grid.
Network	IP	RFC 791; RFC 750 (subnets); RFC 922 (broadcast); RFC 1519 (CIDR); RFC 1108 (security)	Recommended for being attached to or part of the Global Grid. Currently, there is only limited support for mobile platforms and networks, multicast dissemination, and QoS/precedence
	ICMP	RFC 792	Recommended for attaching to the Global Grid.
Link	Ethernet Serial ATM Etc.	IEEE 802.3 HDLC; PPP [cf. JTA for ATM requirements]	Recommended for attaching to the Global Grid. A given network attaching to the Global Grid will not need to support all link types simultaneously; only one of those pertaining to the local interface.



Gateway to the Global Grid

- Focus

- Link-independent data representations (common format)
- IP networking over legacy systems (common transport)

- Approach

- IP "tunnel" over legacy (JTIDS) radios
- Capture "essence" of data in link-neutral schema

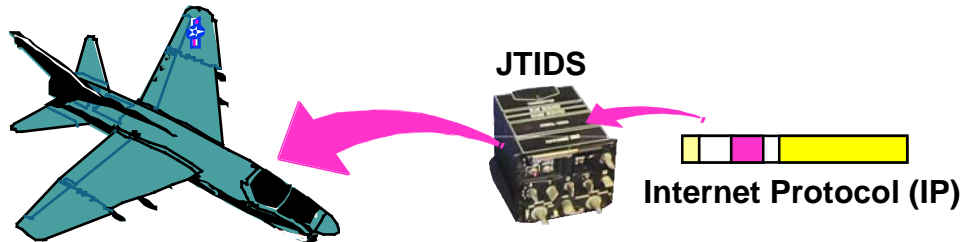
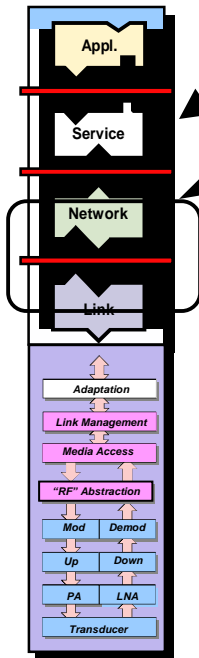

- Impact

- Makes legacy "links" components in the Global Grid

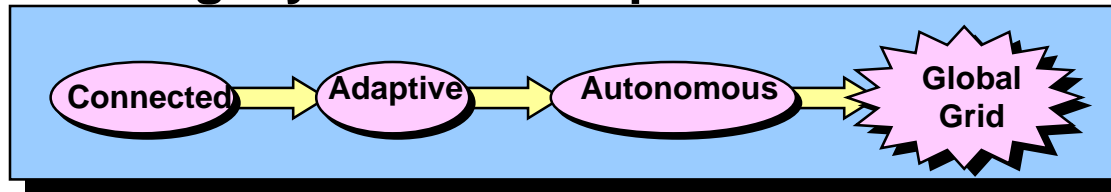



Example Long-Term Recommendations for Joint STARS

- COTS
- GOTS
- Legacy

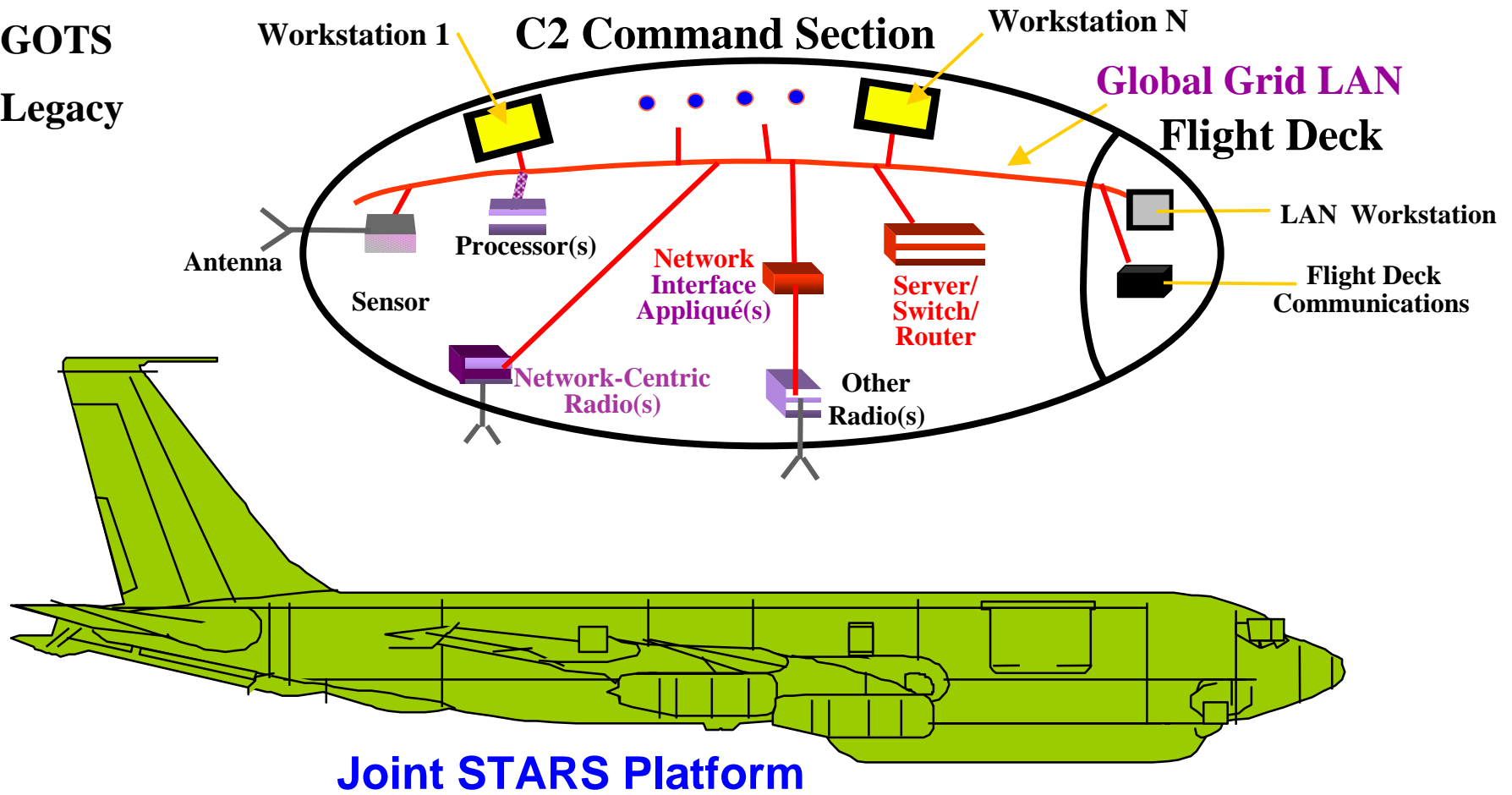

Joint STARS Platform



The Internet Protocol (IP)



Standards

- **IPv4 (This first major version of IP is the internet standard.)**
 - **What does IP do? (IP basically forwards packets!)**
 - **The IP header**
 - Originally provided a unique address (32 b) for everyone on the network
 - Allows for data transfer between different types of networks, e.g., Ethernet and Token Ring
 - Specifies to which Transport Layer protocol the IP datagram (block of data or packet) belongs
 - Provides bits of information on routing, time to live (TTL), options, e.g., security field, etc.
 - **What doesn't IP do?**
 - **IP does NOT guarantee***
 - Delivery**
 - Ordered arrivals of packets**
 - Unaltered content** (checksum is only for header)

* However, these services easily can be effected by the next higher layer protocol, e.g., the Transport Control Protocol (TCP).



Standards (Continued)

- IPv6 (next major version of IP expected -- **but this is debatable**)
 - What improvements are in the offing?
 - **128-b addressing formats permit vast network growth (but this implies lots of header overhead for short packets)**
 - Added fields and extension headers allow for
 - Improved QoS**
 - More efficient **mobility** mechanisms
 - More support to **wireless** communications
 - Enhanced **security** features
 - (but security is issue in changing from IPv4 to IPv6)**
 - More robust multicast capabilities
 - Inherent auto-configuration facilities
 - Extendable protocols and interfaces
 - Improved network maintainability
 - Backward compatible transition strategies include
 - Tunneling data through the IPv4 infrastructure
 - Building dual IPv4/IPv6 devices



Standards (Concluded)

- IPv6 (concluded)

- Why hasn't this standard "taken off"?

- Exist ways for getting around 32 b address limitation*

- IPv6 has many advantages but no great leap in capability, so overcoming legacy IPv4 may not be worth it. **However,**

- Most new devices on market can handle IPv6 routing

- **Proliferation of wireless communications is one of strongest motivations for transition to IPv6**

With ubiquity of wireless devices, IPv4 address space will be severely strained

Wireless community has mandated IPv6

- **Near-term transition to IPv6 must be addressed**

All major inventors and architects of IPv4 internet strongly promote IPv6

* Use of private addresses, combined with Network Address Translation (NAT) to public IP addresses when communicating with public peers



Formats

Version (4)	IHL (4)	TOS (8)	Total Length (16)	
Identification (16)			Flags (4)	Fragment Offset (12)
Time to Live (8)		Protocol (8)	Header Checksum (16)	
Source Address (32)				
Destination Address (32)				
Options (none or up to 32)				

IPv4 Packet Header Format

(The number of bits allocated to each field is shown in parentheses.)



Formats (Concluded)

Version (4)	Traffic Class (8)	Flow Label (20)	
Payload Length (16)		Next Header (8)	Hop Limit (8)
Source Address (32)			
Source Address (continued) (32)			
Source Address (continued) (32)			
Source Address (concluded) (32)			
Destination Address (32)			
Destination Address (continued) (32)			
Destination Address (continued) (32)			
Destination Address (concluded) (32)			

IPv6 Packet Header Format

(The number of bits allocated to each field is shown in parentheses.)



Characteristics

- Operationally, **IP is mostly “best effort” networking protocol**
 - Without much QoS capability for “meshed fabrics” (as yet)
 - IPv6 will have some improved QoS properties, e.g.,
 - Flow identification
- However, **IP products, especially routers and switches, have extremely robust QoS features that are not generally used**
 - Available bandwidth provides enough QoS
 - Network engineers/managers can be unaware of available IP QoS features or may not know how to configure them
 - ISPs may not know how to tariff value-added QoS services
- **IP provides rigid QoS, agile QoS, and precedence/priority**
 - Rigid IP QoS, provided by the Resource Reservation Protocol (RSVP), provides QoS equivalent to ATM, with additional multicast QoS features



Characteristics (Continued)

- IP provides rigid QoS, agile QoS, and precedence/priority (concluded)
 - Agile QoS bandwidth can be allocated parametrically, e.g., by protocol, source-destination pair, etc. If bandwidth for some parameter set is not being used, this bandwidth may be borrowed by another parameter regime
 - Precedence/priority: Large packet may be queued for transmission ahead of (smallish) voice packet that is delay sensitive -- IP will break large packet into small packets, and queue voice packet in front of fragmented large packet
- To help overcome disadvantages of *ad hoc* mechanisms with IP, **QoS frameworks have been developed**
 - Integrated services framework
 - Differentiated services framework
 - Combination of the two frameworks



Characteristics (Continued)

- **IP accommodates Classes of Service (CoSs)**
 - **Internet service provider (ISP) charges more for better CoS**, typically realized simply by more bandwidth
 - **In Internet, edge devices enforce customer Service Level Agreements (SLAs)** -- Edge devices may shape customer data to bring into SLA conformance -- If data are too far out of conformance to SLA, they may be dropped (reputable ISP would make sure that set of all SLAs can be handled by network interior)
 - Customer can use resource reservation (RSVP) in its portions of data path to get QoS
 - **Military utilizes precedence/priority model based on command hierarchies** in addition to buying commercial service, through DISA, for example



Characteristics (Continued)

- **IP can “ride” on almost anything**, commonly
 - 10 Mb/s, 100 Mb/s, & 1 Gb/s Ethernets
 - Token Ring
 - Fiber Distributed Data Interface (FDDI)
 - Asynchronous Transfer Mode (ATM)
 - **IP over ATM is not only possible, it is norm**
- ATM (debate between ATM and IP has raged) is protocol that
 - Operates at Network and Link Layers (mostly)
 - Employs fixed-length “cells”
 - **Higher speed encryptors exist for ATM than IP***
 - Provides good QoS, e.g., reliability, latency, throughput, capabilities through “virtual” circuit (emulation) service
 - One can pick path to get more timely delivery
 - But it is more difficult to maintain routing tables

* Thus, no market yet for IP encryptors; however, ASICs can solve variable-length IPv4 packet problem.



Characteristics (Continued)

- Largely because of beneficial QoS features of ATM, compared to IP, perceptions are that ATM
 - Uses more overhead
 - Is much harder to manage than IP (big drawback)
 - Is generally more expensive than IP
- Also,
 - **ATM does not scale well** with greatly increased end Users
 - DISA does not provide ATM service, i.e., DISA routers use IP, so ATM-ATM end-to-end QoS does not apply
 - DISA uses non-standard Leading Edge Service (LES)
 - DISA is moving away from ATM and towards Multi-Protocol Label Switching (MPLS)
- **Thus, because of this “apples and oranges” situation, cost-benefit tradeoffs between ATM and IP are advisable**



Characteristics (Concluded)

- **Current systems often employ hybrid of ATM and IP, e.g.,**
 - The Combat Information Transport System (CITS) uses
 - ATM “backbone” or Gb Ethernet for wider-band communications across AF base
 - Mostly Ethernet LANs and very few “native” ATMs
- Prevailing opinion seems to be: Do what CITS does, i.e.,
 - Employ ATM for network wide operations, e.g., to replace telephony
 - Utilize IP for end User
- However, it is noted that
 - CITS is evolving towards more IP
 - **U.S. Navy is also moving more towards IP after advocating ATM**



Wrap-Up



The Message

- **This is an exciting time!**
- **We're moving towards network-centric warfare.**
- **There are major initiatives in all the Services to implement better networks to help the warfighter**
 - **Air Force: Multi-Sensor C2 Constellation/Aircraft**
 - **Army: Objective Force/Future Combat Systems**
 - **Navy: FORCEnet**
 - **Coast Guard: Deep Water**
- **We need to design and build things horizontally for interoperability, and integrate components vertically for greater operational capability**
- **Good architectures help in reconfiguring evolving systems and inserting new (and as yet unknown) technologies; key is**
 - **Layering mentality**
 - **Clean, open system interfaces**



“So What” Should We Do?

- **Consider how our (mostly?) vertically-integrated system can evolve to have more of horizontal Global Grid component**
 - Think about and adopt layered architecture principles
 - Work on “layering” our systems for longer term
 - Become more “network-centric” as funding permits
 - At minimum adopt Internet Protocol and ensure capability to route IP packets
- **Define and publish what operational QoS is needed**
 - Quantify our missions’ communication/networking needs
 - Think Global Grid for most, if not all, of them
 - Then let Global Grid try to satisfy them
- **Work with Global Grid on two-way “interface” between our mission applications and communications transport**
 - Help determine what needs to stay (for now) “stovepiped” to meet timeliness and other QoS expectations
- **Ensure that our program applications are “network aware”**
 - Our program architectures should be able to accommodate shortfalls in expected Global Grid performance



Summary

- The Global Grid is a subset of the Global Information Grid (GIG); communications/networking infrastructure layer that will enable
 - Network-centric communications environment
 - Ubiquitous, scalable connectivity (using IP)
 - Adaptable and efficient comm links affording more capacity
 - Autonomous network control
 - Security (information assurance at each architectural layer)
- Global Grid activities are helping to
 - Define architectural vision and tenets for comm/networking
 - Highlight areas of concern about “stovepiped” thinking
 - Provide guidance for DoD decision makers
- Initial connectivity capability is achievable but we should
 - Align to commercial communication technology base
 - Focus DoD technology investments on gaps



Quiz

- What are some GG tenets?
 - Information centric
 - Complete connectivity
 - Affordable capacity
 - Unlimited extensibility
 - Protection matched to potential threats
 - Autonomous control
 - Full adaptability
- What do we mean by layering?
- How will the GG be achieved?
 - Technology-independent architectural approach for most flexibility in evolving to GG
 - Programs must utilize every chance to incorporate the GG tenets in their architectures and migrate their implementations accordingly



References

Butler, G. M., J. F. Providakes, T. G. Blythe, Jr., "The Layered Radio", MILCOM 98, 18-21 October 1998, The MITRE Corporation, Bedford, MA

White, B. E., "Layered Communications Architecture for the Global Communications Grid," MILCOM 2001, 30 October 2001, Sheraton Premiere Hotel, McLean, VA



Acronyms

- AF** = Air Force
- AFC2ISRC**=Air Force Command and Control Intelligence, Surveillance and Reconnaissance Center
- AFCA** = Air Force Communications Agency
- AMTI** = Airborne Moving Target Indicator
- API** = application program interface
- ARP** = Address Resolution Protocol
- ASIC** = application specific integrated circuit
- ATM** = Asynchronous Transfer Mode
- BGP** = Border Gateway Protocol
- BPSK** = binary phase shift keying
- C2** = command and control
- C2SoS** = Command and Control System of Systems
- CITS** = Combat Information Transport System
- COE** = Common Operating Environment
- CONOPS** = concept of operations
- CoS** = class of service
- CSMA** = Carrier Sense Multiple Access



Acronyms (Continued)

DII	= Defense Information Infrastructure
DISA	= Defense Information Systems Agency
DISN	= Defense Information Systems Network
DoD	= Department of Defense
DTIG	= Deployable Theater Information Grid
ESC	= Electronic Systems Center
FAB-T	= Family of Beyond-Line-of-Sight Terminals
FDDI	= Fiber Distributed Data Interface
FSK	= frequency shift keying
FTP	= File Transfer Protocol
GBS	= Global Broadcast Service
GG	= Global Grid
GGRM	= Global Grid Reference Model
GIG	= Global Information Grid
GMTI	= Ground Moving Target Indicator
GW	= gateway
HDLC	= High-Level Data Link Control
HTML	= hyper text markup language
HTTP	= Hyper Text Transfer Protocol



Acronyms (Continued)

IBM	= International Business Machines
ICMP	= Internet Control Message Protocol
ID	= identifier
IEEE	= Institute for Electrical and Electronics Engineers
IETF	= Internet Engineering Task Force
IGMP	= Internet Gateway Message Protocol
IHL	= internal header length
INFOSEC	= information security
IO	= input output
IP	= Internet Protocol
ISP	= Internet service provider
ISR	= intelligence, surveillance, and reconnaissance
IT	= information technology
IPX	= Internet Package Exchange
JBI	= Joint Battlespace Infosphere
JTA	= Joint Technical Architecture



Acronyms (Continued)

LAN	= local area network
LES	= Leading Edge Service
LOS	= line-of-sight
LPI	= low probability of intercept
MAC	= media access control
MC2A	= Multi-mission Command and Control Aircraft
MC2C	= Multi-mission Command and Control Constellation
MIB	= management information base
MPLS	= Multi Protocol Label Switching
NAT	= Network Address Translation
NCCT	= Network Centric Collaborative Targeting
OLE	= object linking and embedding
OS	= operating system
OSI	= Open Systems Interconnection
OSPF	= Open Shortest Path First
PAD	= product area directorate
PC	= personal computer
PHY	= physical
PPP	= point-to-point (tunneling) protocol



Acronyms (Continued)

QoS	= quality of service
RARP	= Reverse Address Resolution Protocol
RF	= radio frequency
RFC	= request for comments
RSVP	= Resource Reservation Protocol
SAR	= synthetic aperture radar
SATCOM	= satellite communications
SLA	= service level agreement
SMTP	= Simple Mail Transfer Protocol
SNMP	= Simple Network Management Protocol
SPO	= system program office
STD	= standard
TADIL	= tactical digital information link
TCP	= transport control protocol
TDC	= Theater Deployable Communications
TDMA	= Time Division Multiple Access
TOGAF	= The Open Group Architectural Framework
TOS	= type of service



Acronyms (Concluded)

UAV	= unmanned air vehicle
UDP	= User Datagram Protocol
UHF	= ultra high frequency
URL	= Uniform Resource Locator
U.S.	= United States
WIN-T	= Warfighter Information Network - Tactical
XML	= eXtensible Markup Language



Acknowledgment

Many of the author's Global Grid colleagues at MITRE contributed to the intellectual content of this presentation. Special thanks to the Air Force for supporting this work.