



# ARROYO CENTER

- THE ARTS
- CHILD POLICY
- CIVIL JUSTICE
- EDUCATION
- ENERGY AND ENVIRONMENT
- HEALTH AND HEALTH CARE
- INTERNATIONAL AFFAIRS
- NATIONAL SECURITY
- POPULATION AND AGING
- PUBLIC SAFETY
- SCIENCE AND TECHNOLOGY
- SUBSTANCE ABUSE
- TERRORISM AND HOMELAND SECURITY
- TRANSPORTATION AND INFRASTRUCTURE
- WORKFORCE AND WORKPLACE

This PDF document was made available from [www.rand.org](http://www.rand.org) as a public service of the RAND Corporation.

[Jump down to document](#) ▼

The RAND Corporation is a nonprofit research organization providing objective analysis and effective solutions that address the challenges facing the public and private sectors around the world.

## Support RAND

[Browse Books & Publications](#)

[Make a charitable contribution](#)

## For More Information

Visit RAND at [www.rand.org](http://www.rand.org)

Explore [RAND Arroyo Center](#)

View [document details](#)

## Limited Electronic Distribution Rights

This document and trademark(s) contained herein are protected by law as indicated in a notice appearing later in this work. This electronic representation of RAND intellectual property is provided for non-commercial use only. Permission is required from RAND to reproduce, or reuse in another form, any of our research documents for commercial use.

## Report Documentation Page

*Form Approved*  
*OMB No. 0704-0188*

Public reporting burden for the collection of information is estimated to average 1 hour per response, including the time for reviewing instructions, searching existing data sources, gathering and maintaining the data needed, and completing and reviewing the collection of information. Send comments regarding this burden estimate or any other aspect of this collection of information, including suggestions for reducing this burden, to Washington Headquarters Services, Directorate for Information Operations and Reports, 1215 Jefferson Davis Highway, Suite 1204, Arlington VA 22202-4302. Respondents should be aware that notwithstanding any other provision of law, no person shall be subject to a penalty for failing to comply with a collection of information if it does not display a currently valid OMB control number.

1. REPORT DATE <b>2006</b>	2. REPORT TYPE	3. DATES COVERED <b>00-00-2006 to 00-00-2006</b>	
4. TITLE AND SUBTITLE <b>The Impact of Network Performance on Warfighter Effectiveness</b>		5a. CONTRACT NUMBER	
		5b. GRANT NUMBER	
		5c. PROGRAM ELEMENT NUMBER	
6. AUTHOR(S)		5d. PROJECT NUMBER	
		5e. TASK NUMBER	
		5f. WORK UNIT NUMBER	
7. PERFORMING ORGANIZATION NAME(S) AND ADDRESS(ES) <b>RAND Corporation, 1776 Main Street, PO Box 2138, Santa Monica, CA, 90407-2138</b>		8. PERFORMING ORGANIZATION REPORT NUMBER	
9. SPONSORING/MONITORING AGENCY NAME(S) AND ADDRESS(ES)		10. SPONSOR/MONITOR'S ACRONYM(S)	
		11. SPONSOR/MONITOR'S REPORT NUMBER(S)	
12. DISTRIBUTION/AVAILABILITY STATEMENT <b>Approved for public release; distribution unlimited</b>			
13. SUPPLEMENTARY NOTES <b>The original document contains color images.</b>			
14. ABSTRACT			
15. SUBJECT TERMS			
16. SECURITY CLASSIFICATION OF:			17. LIMITATION OF ABSTRACT
a. REPORT <b>unclassified</b>	b. ABSTRACT <b>unclassified</b>	c. THIS PAGE <b>unclassified</b>	
			18. NUMBER OF PAGES <b>67</b>
			19a. NAME OF RESPONSIBLE PERSON

This product is part of the RAND Corporation technical report series. Reports may include research findings on a specific topic that is limited in scope; present discussions of the methodology employed in research; provide literature reviews, survey instruments, modeling exercises, guidelines for practitioners and research professionals, and supporting documentation; or deliver preliminary findings. All RAND reports undergo rigorous peer review to ensure that they meet high standards for research quality and objectivity.

TECHNICAL  
R E P O R T

---



# The Impact of Network Performance on Warfighter Effectiveness

Isaac R. Porche III, Bradley Wilson

Prepared for the United States Army

Approved for public release; distribution unlimited



ARROYO CENTER

The research described in this report was sponsored by the United States Army under Contract No. DASW01-01-C-0003.

The RAND Corporation is a nonprofit research organization providing objective analysis and effective solutions that address the challenges facing the public and private sectors around the world. RAND's publications do not necessarily reflect the opinions of its research clients and sponsors.

**RAND**® is a registered trademark.

© Copyright 2006 RAND Corporation

All rights reserved. No part of this book may be reproduced in any form by any electronic or mechanical means (including photocopying, recording, or information storage and retrieval) without permission in writing from RAND.

Published 2006 by the RAND Corporation  
1776 Main Street, P.O. Box 2138, Santa Monica, CA 90407-2138  
1200 South Hayes Street, Arlington, VA 22202-5050  
4570 Fifth Avenue, Suite 600, Pittsburgh, PA 15213  
RAND URL: <http://www.rand.org/>  
To order RAND documents or to obtain additional information, contact  
Distribution Services: Telephone: (310) 451-7002;  
Fax: (310) 451-6915; Email: [order@rand.org](mailto:order@rand.org)

## Preface

---

The objective of the research effort described in this report is to quantify the marginal impact of networking as part of an effort to evaluate the concept of network-centric operations. Specifically, this report analyzes networking concepts and uses simulation results from agent-based combat models to quantify and assess the marginal benefit of networking concepts with respect to warfighter effectiveness at the tactical level. It will give the Army unique and relevant information to guide its transition to a new force makeup that will be knowledge-based and network-centric.

This work is in support of a project entitled “Exploring the Capability of Network-Based Operations,” which is being co-sponsored by the Chief Information Officer (G-6) of the United States Army and the Office of the Assistant Secretary of the Army for Acquisition, Logistics, and Technology. A key task for this project is to “quantify the impact of cognitive capability on the performance of network-centric operations.” This report addresses this task appropriately.

This research was conducted in RAND Arroyo Center’s Force Development and Technology Program. RAND Arroyo Center, part of the RAND Corporation, is a federally funded research and development center sponsored by the United States Army.

The Project Unique Identification Code (PUIC) for the project that produced this document is DAPRR05030.

For more information on RAND Arroyo Center, contact the Director of Operations (telephone 310-393-0411, extension 6419; FAX 310-451-6952; email [Marcy\\_Agmon@rand.org](mailto:Marcy_Agmon@rand.org)), or visit Arroyo's web site at <http://www.rand.org/ard/>.

# Contents

---

Preface .....	iii
Figures .....	vii
Tables .....	ix
Summary .....	xi
Acknowledgments .....	xiii
Glossary .....	xv
<b>CHAPTER ONE</b>	
<b>Introduction</b> .....	1
The Advantages of Agent-Based Modeling .....	2
Map Aware Non-Uniform Automata (MANA) .....	3
Factoring Cognitive Parameters with MANA .....	4
Agent Movement in MANA .....	4
Factors Under Consideration .....	4
Communication Representation .....	5
Sensing Representation .....	5
Cognitive Representation .....	5
Relevant Studies Using MANA .....	6
Organization of This Report .....	7
<b>CHAPTER TWO</b>	
<b>Evaluating the Concept of Network-Centric Operations</b> .....	9
Quantifying the Benefits of NCO .....	9
NCO and the Cost of Communication .....	11
NCO and the Impact of Human Factors and Behaviors .....	12
<b>CHAPTER THREE</b>	
<b>Simulation Experiments</b> .....	13
First Set of Experiments .....	13
Description of Scenario .....	13
Overview of Data Farming Effort .....	15
Data Farming Results .....	15
Observations .....	17
Second Set of Experiments: Using a Dynamic Communication Model .....	18
Description of Scenario .....	18
Overview of Data Farming Effort .....	18



Design of Experiments .....	19
Data Farming Results .....	20
Observations.....	22
Third Set of Experiments: Expanded Three-Squad Scenario .....	22
Description of Expanded Scenario .....	22
Data Farming Results .....	23
Observations: Quantifying the Relative Impact of Sensors and Cognition .....	24
Fourth Set of Experiments: “Mosque-UAV” Scenario Description .....	25
Direct-Fire Case (Variant 1).....	25
Indirect-Fire Case (Variant 2): A Scenario With Enhancements to Blue .....	28
Other Performance Measures .....	31
Observations.....	33
 <b>CHAPTER FOUR</b>	
<b>Overall Conclusions .....</b>	<b>35</b>
 <b>APPENDIX</b>	
A. Synthesized Models .....	37
B. Past Work on Communication Models Leveraged in This Report .....	43
 <b>Bibliography .....</b>	 <b>47</b>

## Figures

---

1.1.	Capabilities That Affect Networking Performance .....	1
1.2.	For NCO: An Information Grid Connects the Distributed Sensors and Shooters Across the Battlespace .....	2
1.3.	CA Model Neighborhood .....	4
2.1.	Future Networks Will Be Multilayered .....	9
2.2.	Conjecture on Impact of Networks (Connections) on Warfighter Effectiveness .....	10
2.3.	Impact of Scaling on Useable (Per-node) Capacity .....	11
3.1.	Scenario: Small Force Maneuvering and Supported by Precision-Fire Area Weapon .....	14
3.2.	Blue Force Communication/SA Link .....	14
3.3.	Profile of Impact of Various Factors for Similar Model .....	16
3.4.	Plot of Warfighter Effectiveness (LR) as Capacity Varies .....	18
3.5.	Reliability Decreases as the Ratio of Data Rate to Capacity Increases .....	19
3.6.	The Factors Chosen Address the Components of NCO .....	19
3.7.	Profile of the Impact of the Factors on Warfighter Effectiveness .....	20
3.8.	Relative Impact of Communication Capacity and Latency and Sensing Ability on Warfighter .....	21
3.9.	Accuracy Versus Target Rate .....	22
3.10.	Blue Force Communication Link (Expanded Scenario) .....	23
3.11.	Profile of Factors for Experiment 3 .....	25
3.12.	UAVs in Urban Area: Direct-Fire Only .....	25
3.13.	Model Factors for Variant 1 .....	27
3.14.	Improved Sensing Resulted in Reduced Performance in Variant 1 .....	28
3.15.	UAVs in Urban Scenario with Indirect-Fire Support (Variant 2) .....	29
3.16.	Situational Awareness Is Shared Throughout All Blue Forces .....	29
3.17.	Profile of Factors .....	30
3.18.	The Communication of Accurate Information Is Needed to Increase Odds of Success ( $p$ ) in Variant 1 .....	32
3.19.	Force Makeup Was a Key Determinant .....	33
4.1.	Situations Where Networking Capability Increased Warfighter Effectiveness .....	36
A.1.	Predicted Versus Actual for Experiment 1 Model Fit .....	37
A.2.	Simulation Run Results That Explain the Role of Capacity .....	38
A.3.	Fit Achieved for Modeling Second Set of Results .....	38
A.4.	Fit Achieved for Modeling Third Set of Results (Two Squads) .....	39
A.5.	Actual Versus Predicted for Model of Ln(LR) for Variant 1 .....	40
A.6.	Actual Versus Predicted for Model of Ln(LR) for Enhanced Blue .....	41
B.1.	Factors and Responses .....	43

B.2. Generic Form of Meta-Model.....	44
B.3. Polynomial Fit Obtained Based on Meta-Model Data .....	45

## Tables

---

3.1.	A Full Factorial Set of Experiments (First Set) .....	16
3.2.	Significance of Terms .....	17
3.3.	A Full Factorial Set of Experiments (Second Set) .....	20
3.4.	Model Formula with Tests of Terms.....	21
3.5.	A Full Factorial Set of Experiments Totaled 10,800 Runs.....	23
3.6.	Terms of Model from Third Set of Experiments.....	24
3.7.	Design of Experiments .....	26
3.8.	Terms of Model: Direct-Fire Case (Variant 1) .....	27
3.9.	Variant 1 With Squad Size Varied .....	28
3.10.	Terms of Model: Indirect-Fire Case (Variant 2) .....	31
3.11.	Direct-Fire (Variant 1) Excursions with Binary Mission Success Variable.....	31
3.12.	Indirect-Fire (Variant 2) Excursions with Binary Mission Success Variable .....	32
B.1.	Example Design of Experiments .....	44



## Summary

---

The concept of network-centric operations (NCO) was described by the GAO (2004) as follows:<sup>1</sup>

The emerging concept of networked operations, referred to by DoD as network-centric operations [NCO], involves developing communications and other linkages among all elements of the force to create a shared awareness of operations.

The objective of the research effort described in this report is to quantify the marginal impact of networking as part of an effort to evaluate the concept of NCO. Three sets of capabilities initially identified as relevant are

- Sense/acquire data.
- Disseminate and communicate data.
- Interpret, fuse, and react to the data.

These capabilities correspond to the sensing, communication, and cognitive factors, respectively, that are analyzed in this work. In addition, we observed that the force makeup is an additional factor that has a marginal impact along with these three sets of factors.

In this report, we take our definition of “cognitive” from Gartska (2000), who defines a “cognitive domain” as

the mind of the warfighter and the supporting populace. This is the domain where battles and wars are won and lost. This is the domain of intangibles: leadership, morale, unit cohesion, level of training and experience, situational awareness, and public opinion. This is the domain where tactics, techniques, and procedures reside.

This is broad and difficult to quantify. In this report, the focus is narrowed to a small but critical subset of cognitive parameters, namely, accuracy of assessments of available targets and the rate at which they can be prosecuted (we call these collectively “targeting ability”). One specific objective of this report is to discuss the relative impact of all of the aforementioned factors on overall warfighter effectiveness.

A multi-agent-based, force-on-force simulator tool called Map Aware Non-Uniform Automata (MANA) was used to evaluate warfighter effectiveness for a simple urban scenario.

---

<sup>1</sup> Alberts, Garstka, and Stein (1999) specifically define NCO as “the information superiority-enabled concept of operations that generates increased combat power by networking sensors, decision makers, and shooters to achieve: shared awareness, increased speed of command, a higher tempo operations, and greater lethality.”

Agent-based simulations (ABS) utilize little to no scripting of movements and are made up of multiple agents and objects that behave autonomously.

Tens of thousands of MANA runs were conducted in an attempt to examine the impact of varied cognitive, communication, and sensing factors on warfighter effectiveness using a data farming process. Statistical analysis for numerous simulation results, as part of the data farming exercise, quantified the correlation between the factors discussed above and warfighter effectiveness.

In this report, we explicitly incorporated one of the costs of networking by modeling the capacity limits of a communication channel as a result of congestion. One clear conclusion: Warfighter effectiveness was affected by many of the parameters considered, including the parameter called communication capacity. Specifically, effectiveness, as measured by a loss ratio, could be cut in half without sufficient capacity; message latency (delay) affected warfighter effectiveness by as much as 50 percent for a given capacity in a selected scenario. On the other hand, improvements in effectiveness brought about by increasing communication capability eventually diminish. We also observed that while network capability may sometimes increase warfighter effectiveness, sometimes the force makeup is insufficient to support improvements in effectiveness. By some measures (loss ratio, or LR), increased networking capability worsened the outcome.

Agent-based simulation is relatively new in terms of utilization for analyses of force-on-force combat scenarios. Certainly, more validation will be needed. Furthermore, the results in this report may be sensitive to the assumptions that are made with regard to network architecture, force makeup, and technology performance. Although a large space of possibilities was explored for the parameters under consideration, all results need to be taken in the context of the specific scenarios simulated. Nonetheless, the results show how agent-based tools can be exploited to quantify the marginal impact of networks and networking performance to warfighters.

## Acknowledgments

---

The research effort documented in this report is co-sponsored by the U.S. Army CIO/G-6 office, which is headed by LTG Steven Boutelle. It is also co-sponsored by the Office of the Assistant Secretary of the Army for Acquisition, Logistics, and Technology (ASA[ALT]). Mr. Vern Bettencourt, Dr. Edward Siomacco, LTC Tonney Chandler, and Lew Saunders, all from the CIO/G-6 office, have provided valuable guidance, as has Dr. John Parmentola from ASA(ALT).

We wish to thank the MANA team at the New Zealand Defence Technology Agency, especially Dr. Michael Lauren and Dr. David Galligan, for their continued collaboration. We are indebted to our RAND colleagues, including Tom McNaugher, Ken Horn, Leland Joe, and Bruce Held, for their important advice and counsel. In addition, Susan Witty and Elliot Axelband provided helpful comments. Nikki Shacklett assisted with the editing and formatting of this document. Participants in Syndicate 9 of the Project Albert International Workshop helped synthesize one of our scenarios. Stephanie Lonsinger and Stephanie Sutton provided invaluable administrative support and additional proofreading. Dr. Louis Moore from RAND and Dr. Gary Horne from Mitre provided insightful reviews. The authors, of course, remain solely responsible for the observations and judgments contained in this report.





## Glossary

---

ABM	Agent-Based Models
ABS	Agent-Based Simulations
ALER	Adjusted Loss Exchange Ratio
ASA(ALT)	Office of the Assistant Secretary of the Army for Acquisition, Logistics, and Technology
C2	Command and Control
C4ISR	Command, Control, Communications, Computers, Intelligence, Surveillance, and Reconnaissance
CA	Cellular Automaton
DoD	Department of Defense
ISAAC	Irreducible Semi-Autonomous Adaptive Combat
GAO	Government Accountability Office
LR	Loss Ratio
MANA	Map Aware Non-Uniform Automata
NCO	Network-Centric Operations
NCW	Network Centric Warfare
SA	Situational Awareness
UAV	Unmanned Aerial Vehicle



## Introduction

---

The objective of the research effort described in this report is to quantify the marginal impact of networking as part of an effort to evaluate the concept of network-centric operations (NCO). The GAO (2004) provides a description of NCO as follows:<sup>1</sup>

The emerging concept of networked operations, referred to by DoD as network-centric operations [NCO], involves developing communications and other linkages among all elements of the force to create a shared awareness of operations.

We consider three sets of parameters of networking (or network-centric operations) as a means to investigate the impact of networking on warfighter effectiveness (see Figure 1.1). We identify these components as follows:

- Disseminate and communicate data (communication capability).
- Sense/acquire data (sensing capability).
- Interpret, fuse, and react to the data (cognitive capability).

These three capabilities are critical to the elements in the “info grid” that Cebrowski and Garstka (1998) use to illustrate their vision of NCO. Their vision: All users (sensors, shooters, commanders, etc.) are interconnected as part of an information grid (see Figure 1.2).

**Figure 1.1**  
**Capabilities That Affect Networking Performance**

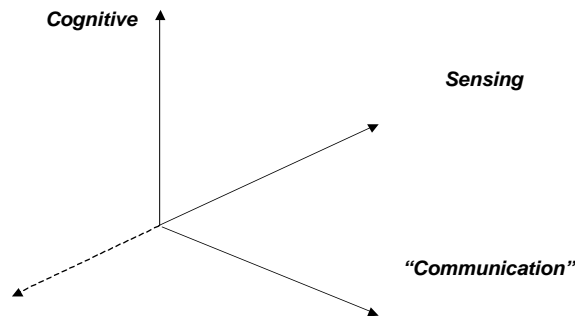

---

<sup>1</sup> Alberts, Garstka, and Stein (1999) specifically define NCO as “the information superiority–enabled concept of operations that generates increased combat power by networking sensors, decision makers, and shooters to achieve: shared awareness, increased speed of command, a higher tempo operations, and greater lethality.”

**Figure 1.2**  
**For NCO: An Information Grid Connects the Distributed Sensors and Shooters Across the Battlespace**

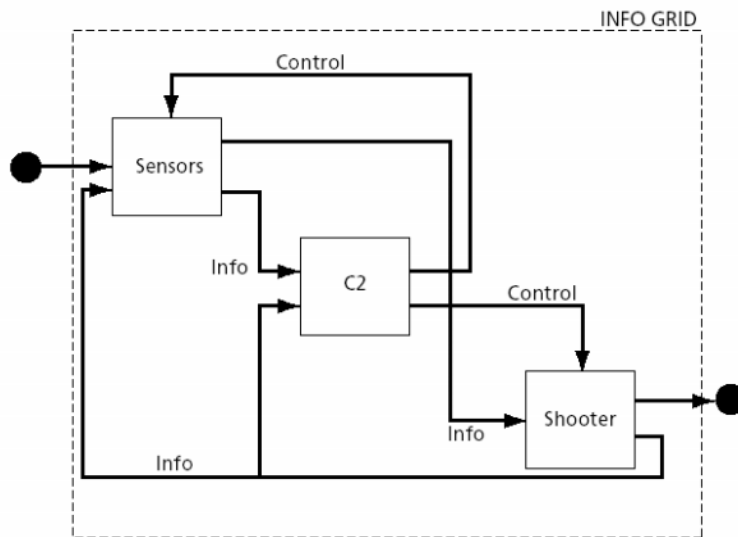

RAND MG156-1.1

SOURCE: Cebrowski and Garstka (1998).

One objective of this report is to discuss the relative impact of these components on overall warfighter effectiveness. The cognitive capability, as a component of networking performance (or the effectiveness of NCO), is arguably the most difficult to quantify and test. It is also critical for effective command and control (C2), especially with regard to determining what is or is not a target and the speed at which that can be done. The cognitive component may also be the one with the largest impact. Quoting Baker (2002): “The speed of information transfer in Network Centric Warfare is rapidly outpacing the human capacity to absorb and act effectively.” A GAO report (2004) supports this observation based on Operation Iraqi Freedom (OIF) after-action reports (which we will discuss later). And as we will report, the force makeup affected the marginal impact of the three aforementioned sets of factors.

## The Advantages of Agent-Based Modeling

Simulations with agent-based models (ABM) are made up of agents and objects that behave autonomously. Liu (2001) defines agents to be a “wide spectrum of computational entities that can sense their local task conditions and make decisions on how to react to sensed conditions by performing certain behaviors in task environments.” As defined by Phillips (2004), ABM are simulations that represent autonomous agents that make decisions based on data received through organic sensors, or communications links (the “network”). Simulations with ABM typically utilize little to no scripting of movements.<sup>2</sup> Users of agent-based

<sup>2</sup> In some simulation tools like MANA, optional waypoints can be specified that compose a path with a location goal.

simulation, which include the United States Marine Corps Warfighting Lab,<sup>3</sup> value it because, among other possibilities, it is seen as a means to model the human intangibles of combat, e.g., trust, unit cohesion, fatigue, morale, and leadership. Complex behavior such as swarming (Arquilla and Ronfeldt, 2000) can emerge from this approach.

Cienciolo (2003) rightly asserts, “In order to fully exploit and implement the concept of Network Centric Warfare, advocates must take into consideration the behavior of men in battle and recognize that external and situational factors such as fear, danger, stress, and hardship will impact on the decisions/judgment of leaders and individual warfighters alike.” Russell, Russell, and Benke (1996) suggest that this is rarely done at present when they note that “quantitative evaluations of combat performance rarely include detailed information on human factors.” With respect to these factors, agent-based models that incorporate personality traits can be useful.

There exist ABM that address these factors by enabling the user to model considerations such as the “cognitive domain” and other human factors quickly, efficiently, and autonomously. Agents in the model interact with each other in nonlinear ways, and they adapt to their local environment. How they cooperate in the battlespace is extracted from their personality, which is shaped by weighting factors that control their propensity to move toward or away from different units or objectives. The environment in which the agent belongs can be set up to represent network-centric issues in such a way that their actions depend on the quality, or lack thereof, of the information they receive. Knowing this, complex topics, such as unit cohesion and dissemination of information, can not only be explored as concepts but also quantified in terms of their impact.

#### **Map Aware Non-Uniform Automata (MANA)**

MANA<sup>4</sup> was developed by the New Zealand Defence Technology Agency. It is an agent-based simulation. In MANA, knowledge of enemy contacts (and friendly locations) is referred to as situational awareness. Two types of situational awareness (SA) maps are provided in MANA: a squad map, which holds direct squad contact memory, and an inorganic map, which stores contact memories provided by other squads through communications links. MANA allows communication of contact sightings between squads. An extensive range of parameters allows issues involving communications links to be thoroughly explored. MANA contains terrain features, such as roads, that agents can follow and undergrowth that agents can use for concealment. Users can define a set of waypoints for agent movements and not just specify an ultimate objective for autonomous movement. Events, such as being shot at, taking a shot, reaching a waypoint, and making enemy contact, can all trigger a different personality set, which lasts for a set time. Personality changes can apply to individuals or to a whole squad at once. According to Lucas, Sanchez, and Cioppa (2004), agent-based simulations have the potential to look at intangibles like leadership, courage, fear, and aggressiveness. Situational awareness in MANA is characterized by SA maps that contain only targeting and “Blue force” information and battle damage assessments.

---

<sup>3</sup> <http://www.mcwl.quantico.usmc.mil/divisions/DivisionDescription.cfm?ID=23>.

<sup>4</sup> Pronounced Mah-Nuh with emphasis on neither syllable, “MANA” is a Maori word meaning an aura of respect and authority.

### Factoring Cognitive Parameters with MANA

In MANA, individual agents have their own local perspective on their environment. This is achieved as follows: Agents in MANA have individual personality weights that can be exploited to factor the aforementioned parameters (Galligan, Anderson, and Lauren, 2004). Personality settings affect mobility, targeting, clustering, and other agent decisions. These personality settings can be made dynamic, i.e., they can be programmed to change based on external events or activity types or agent status (casualty status, fuel status, ammunition status) or mobility (e.g., moving or stationary).

With regard to mobility, an agent can be assigned varying amounts of attraction or repulsion uniquely associated with either friends, foes, neutrals, unknown agents, terrain types (concealed areas, open areas), and specified objective areas. Varying amounts of clustering or swarming may be a result. Agents are also assigned targeting decisionmaking schemes, which can be programmed to be different for various classes of targets. Autonomous mobility is assigned based on either specific movement algorithms, e.g., Gill (2004), Gill and Grieger (2003), and Lauren and Stephen (2000), or some predetermined path, or a combination. Further discussion is provided in the following section.

### Agent Movement in MANA

The movement of an agent in MANA, as the simulation progresses through steps, involves penalty calculations. This approach shares some similarities with robotic movement algorithms that determine the path of least resistance, but there is more randomness incorporated.

Specifically, there are multiple equations that calculate a penalty for each agent's possible movement to a neighboring cell. Based on their values and the agent's personality weight vector, movement is determined. Like other cellular automaton (CA) models (Illachinski, 2001), the movement neighborhood is defined as the cells surrounding the agent (see Figure 1.3). The actual move is the one that incurs the least penalty. MANA allows optional specification of waypoints and objective locations that adds a degree of "far-sightedness."

**Figure 1.3**  
CA Model Neighborhood



### Factors Under Consideration

A number of factors were varied in the investigations described in this report. We assign them to the three areas of impact, (i) communication capability, (ii) sensing capability, and (iii) a subset of cognitive parameters we refer to as targeting capability. We elaborate on them as follows.

### Communication Representation

MANA incorporates a number of specific communication capabilities associated with links. They include:

1. reliability
2. capacity, and
3. latency.

Reliability is the likelihood that a given message will be successfully transmitted on a communications link per try. Thus, it is similar to a message completion rate. Attempts will be made at resending unsuccessful messages until they are successfully communicated. Reliability ranges from 0 percent to 100 percent.

Capacity is the number of messages that can be sent through the link per time step. Latency is the number of time steps taken for each message to reach the receiving squad.

### Sensing Representation

In MANA, sensing ability is accounted for by the detection range. This is the radius in cells that an agent can see targets in its environment. Detection does not imply classification or identification. Contacts are recorded as unknown on the situational awareness maps if they are recorded in an area where the detection range extends but the classification range does not.<sup>5</sup>

### Cognitive Representation

Kamradt (2003) provides a concise summary of the limitations within the cognitive realm:

Compared to the 10s of gigabits per second that we might someday push across our networks, experts believe the limits of the human mind are far more restrictive. Experimentation indicates that while our senses take in huge amounts of information, consciousness processes only about 40 bits per second—at most. Additional research indicates that people are far less efficient at multitasking than was once believed. It seems trying to do several things at once or in rapid succession takes longer than doing them one at a time and may leave less brainpower to perform each task . . . The bottom line is that people are easy to overload.

In this report, the focus is narrowed to a small but critical subset of cognitive parameters, namely, accuracy of assessments of available targets and the rate at which they can be prosecuted (we call these collectively “targeting ability” or “targeting capability”). Targeting capability captures the limits discussed above by Kamradt. Two corresponding MANA parameters are used to account for targeting capability (which is an ability that partly results from good cognition).

Why have an accuracy parameter? Cianciolo (2003) cautions “NCW [network-centric warfare] advocates must address the issue of accuracy, especially with regard to highly perishable information. History has demonstrated that combat information can be extremely

---

<sup>5</sup> Checking the “Lock to Classification Range” option in the graphical user interface (GUI) ensures that detections are always classifiable by synchronizing the detection and maximum classification ranges. In MANA, its values range between 0 and 1000.



inaccurate, especially when individuals are influenced by fatigue, isolation, and stress.” In our work, that caution is heeded by including it as a factor.

In MANA, the accuracy parameter sets the probability that a contact’s type will be passed correctly. When a link is acting inaccurately, an incorrect type—out of the pool of enemy, friend, neutral, and unknown—is sent for the contact. The accuracy parameter is particularly useful for friendly fire type studies. Its values are between 0 percent and 100 percent. An accuracy of 0 percent means the link always sends the incorrect contact type and 100 percent means the link always sends the correct contact type.

The number of targets within both sensor and firing range that can be engaged in a single time step is referred to here as target rate. The actual number entered in the simulation is between 0 and 1000, where a value of 150 means 100 percent chance of engaging one target, and a further 50 percent chance of engaging another target in a step.

## Relevant Studies Using MANA

Ipekci and Lucas (2002) at the Naval Postgraduate School documented their research effort using MANA in the monograph titled “How Agent-Based Models Can Be Utilized to Explore and Exploit Non-Linearity and Intangibles in Guerilla Warfare.” This study was concerned with a small unit operation where intangibles like unit cohesion, movement, and decisionmaking at the level of individual combatants were of interest. MANA is capable of assessing these types of factors. The study’s conclusions are as follows: (1) Results are mostly affected by factors associated with Red (the opposing force); stealth ability is important. (2) More cohesive guerilla forces that do not stay with the injured and form big groups do better at infiltration. (3) Red negated Blue firepower by increasing the sizes of infiltration teams.

Dekker (2002) uses force-on-force simulation experiments to examine the marginal impact of C4ISR.<sup>6</sup> He develops an expression that relates the connectivity of a network topology and a measure of intelligence to the adjusted loss exchange ratio (ALER). The expression, developed from a set of simulation experiments, follows:

$$\text{ALER} \approx 1.6 \sqrt[4]{I} (1.043)^\kappa,$$

where  $\kappa$  is the node connectivity. The coefficient  $I$  is called the intelligence quotient.

The intelligence coefficient  $I$  is obtained by summing (over all combat nodes and all relevant sensors for that node) the quotient of sensor quality and total path delay. If  $\Delta_{ij}$  is the total path delay from sensor node  $i$  to combat node  $j$  (or infinite if there is no connection), and  $q_i$  is the quality of sensor  $i$ , then

$$I = \sum_{ij} \frac{q_i}{\Delta_{ij}}.$$

<sup>6</sup> Dekker’s work simulated 10 units engaged in combat with a non-networked enemy force of 30 units. Friendly force makeup included two long-range sensors, two headquarters units, and six combat units (which also had limited sensing capabilities). MANA was used as the agent-based combat simulator.

This reference does not address the method used for assigning a quality to a sensor. Essentially the intelligence coefficient measures the ability of the network to effectively move sensor information to the point where it is needed.

Lauren, Stephen, and Hore (2003) used MANA to model operational questions for East Timor. The simulations were in part used as an effort to see how suitable MANA could be as a tactical decision support tool. In that study, the authors were charged with addressing two key questions: What was the most effective way to conduct a cordon-and-search operation on a designated village? Was it possible to show the benefit of the use of “trackers” in this theater of operations?

The modeling results were considered *a priori* and compared with decisions and observations actually made by tactical commanders for actual operations. Post-operation review seemed to validate the MANA results using data and observations by tactical commanders deployed to East Timor.

The operation that was analyzed is described as an effort to capture an individual hiding in a village. Information flow between the target and sympathetic bystanders was modeled. An infantry company approaches the village in three groups from three directions in the daylight. An operation is considered successful if the target is captured. One interesting observation was made with respect to the impact of an additional aerial observer sensor. Quoting Lauren, Stephen, and Hore (2003):

Although the addition of the aerial observer significantly increased the number of Red that Blue was able to catch, it also increased the number of Blue casualties. This was because the effect of the addition of an observer was to increase the chances of an encounter between the sides, hence increasing the likelihood of casualties.

These authors concluded that “technological fixes do not necessarily make greater gains in an operation than the choice of appropriate tactics.”

## Organization of This Report

The remainder of this report is organized as follows: Chapter Two provides a summary of the concept of network-centric operations, along with critiques of the concept.

Chapter Three discusses the results of force-on-force simulation experiments using MANA, which were run to investigate the marginal impact of various factors that affect war-fighter effectiveness. Results for four sets of simulation experiments are described.

The first set of experiments has two Blue force squads, one an indirect-fire unit and the other an infantry squad. The only messages that get passed are “calls for fire” from the infantry squad back to the indirect-fire squad. These experiments show the diminishing return from increased communication capacity.

A second set is run using the same scenario, but a dynamic communication model is coded into the force-on-force simulator; this allows MANA to vary communication reliability based on message traffic and channel capacity during each time step. The main result is the same as the first simulation set, except effectiveness is lower overall. So these runs, compared with the first set of experiments, show how static assumptions on communications ability affect outcome.

The third set of simulation runs is executed with an expanded scenario; a second squad of six infantry is added to the initial scenario to give us a better understanding of the marginal impact of communications and sensing.

The fourth set of simulation runs came out of work done at the 9th Project Albert International Workshop in Wellington, New Zealand. A new scenario is used in which Blue forces are attempting to secure an area around a mosque and stop Red forces from entering. The result observed was that the Blue force consistently fared poorly, despite increased networking capability, until the force was augmented with sufficient indirect-fire capability. This scenario and the resulting experiments were run to provide counterexamples to unqualified assertions about the benefits of networking (that do not consider other factors, e.g., force makeup, scenario, etc.).

Finally, Chapter Four summarizes the overall conclusions of the report. Appendix A provides details on the models of warfighter effectiveness that are synthesized and examined in Chapter Three. Appendix B summarizes past work on communication models leveraged in this report.

## Evaluating the Concept of Network-Centric Operations

---

The multilayered concept of future force networking (as shown in Figure 2.1) is complex. The key motivation of this report is to be able to quantitatively assess the marginal impact of networking, which we attempt by considering each of the components of networking performance outlined in Chapter One.

**Figure 2.1**  
Future Networks Will Be Multilayered

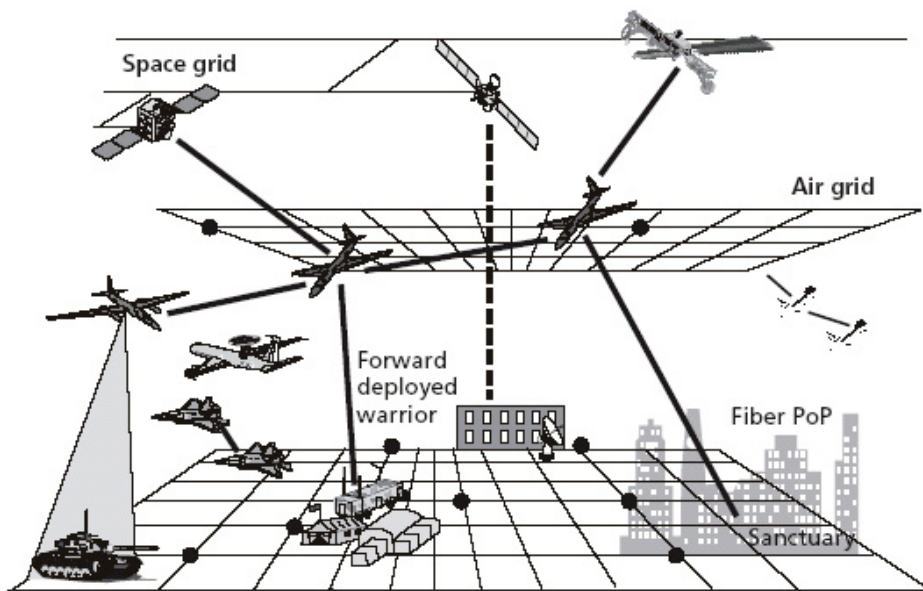

### Quantifying the Benefits of NCO

Proponents cite the potential for wide gains in warfighter effectiveness. In fact, interpretations of Army doctrine by some (Mazzanti, 2001, Gumbert et al, 2003, TRADOC, 1995) are that the impact of information on the warfighter, provided by ubiquitous networks, is exponential, and they explicitly formulate this notion<sup>1</sup> as follows:

<sup>1</sup> Quoting (Gumbert et al, 2003): "COMBAT POWER is defined as a linear function, being the sum of maneuver, fire-power, and protection multiplied by leadership. In the future combat systems (FCS)-equipped force, combat power be-

$$\text{Combat power} = ((\text{Maneuver} + \text{Firepower} + \text{Protection}) * \text{Leadership})^{\text{Information}}$$

One of the supposed underpinnings of this conjecture is Metcalfe's law.<sup>2</sup> Gilder (1993) interprets Metcalfe's law as follows:

**Metcalfe's law of telecosms:**<sup>3</sup> connect any number "n" of machines—whether computers, phones or even cars—and you get "n"-squared potential value.

This is derived from the calculation of the maximum number of possible (pair-wise) connections, e.g.,  $n(n-1)/2$ , in an information-providing network of  $n$  nodes. Reed's law (2000), which claims greater gains (e.g., exponential), is also derived in part by a similar type of calculation but includes all the  $n$ -way (e.g., 3-way, 4-way, etc.) connections. An example of an extrapolation of this law to the military environment is shown in Figure 2.2, most recently cited by Fisher (2003).

There has been renewed debate over the meaning and appropriateness of Metcalfe's law in a military context. Giffin and Reid (2003) argue that it has been inappropriately interpreted. Specifically, they argue that NCO proponents wrongly interpret Metcalfe to mean an increase in the power of the network or the value of its transactions. They claim instead

**Figure 2.2**  
Conjecture on Impact of Networks (Connections) on Warfighter Effectiveness

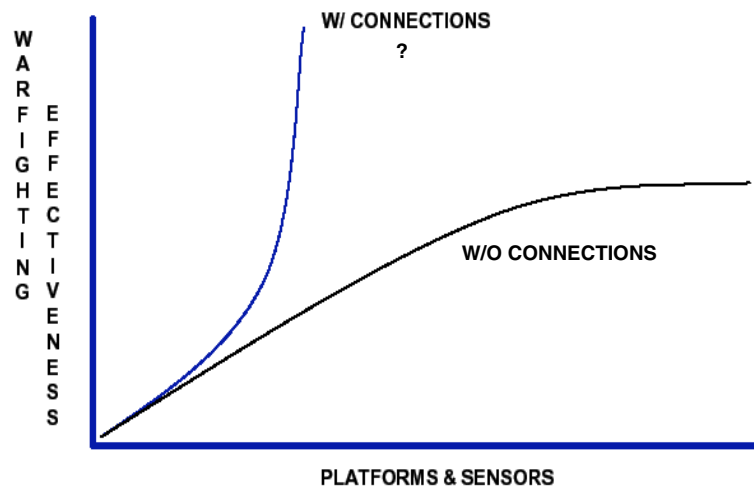

comes an exponential equation where the power of information will raise the factors of maneuver, firepower, protection, and leadership. Therefore, information and intelligent command and control (C2) systems are key to the success of the FCS-equipped force. This C2 system must enable the FCS-equipped force to synchronize intelligence, maneuver, effects, and logistics, as well as the exchange of information with joint or combined task force C2 systems and the Army's tactical C2 systems. In short, the C2 system will enable a force that is both network- and execution-centric to employ combined arms and joint capabilities at the lowest tactical echelons."

<sup>2</sup> Robert Metcalfe is the inventor of Ethernet LANs and founder of 3Com.

<sup>3</sup> George Gilder and others use the term "telecosm" when referring to "the world enabled and defined by new communications technology."

that it only applies, at best, to goods and services necessary to participate in a network. For example, facsimile machines may be increasingly more valuable as more people acquire them.

## NCO and the Cost of Communication

Whatever the potential benefit accrued from a network, the costs of such networking have to be factored to provide a perspective on true value. Tactical Army units will require mobile, ad hoc (wireless) communication. In wireless networks, communication costs can actually increase with the size ( $n$ ) of the network. If you assume the network value is proportional to network throughput (measured in bits per second), we see then from Gupta and Kumar (2000) and others that at least one measure of network value (e.g., throughput) decreases nonlinearly, as shown in Figure 2.3. Certainly, without sufficient throughput, information cannot be passed.

As shown in Figure 2.3, Gupta, Gray, and Kumar (2001) report wireless networking experiments in which per-node throughput decays like  $c/n^{1.68}$ . If network value increases proportional to  $n(n-1)/2$  but decreases proportional to  $n^{1.68}$  or  $\sqrt{n \log(n)}$ , then the aforementioned quantifications of the impact of network connectivity and information on combat power, as postulated by Fisher (see Figure 2.2), Gumbert et al (2003), and the U.S. Army Training & Doctrine Command (TRADOC, 1995), are in doubt. In other words, there may be nearly as much cost (or more) to sustaining a network as there is benefit in maintaining it. In the research effort documented in this report, we provide simulations that factor in the scaling limitation of the wireless networks that are envisioned at the tactical level.

**Figure 2.3**  
Impact of Scaling on Useable (Per-node) Capacity

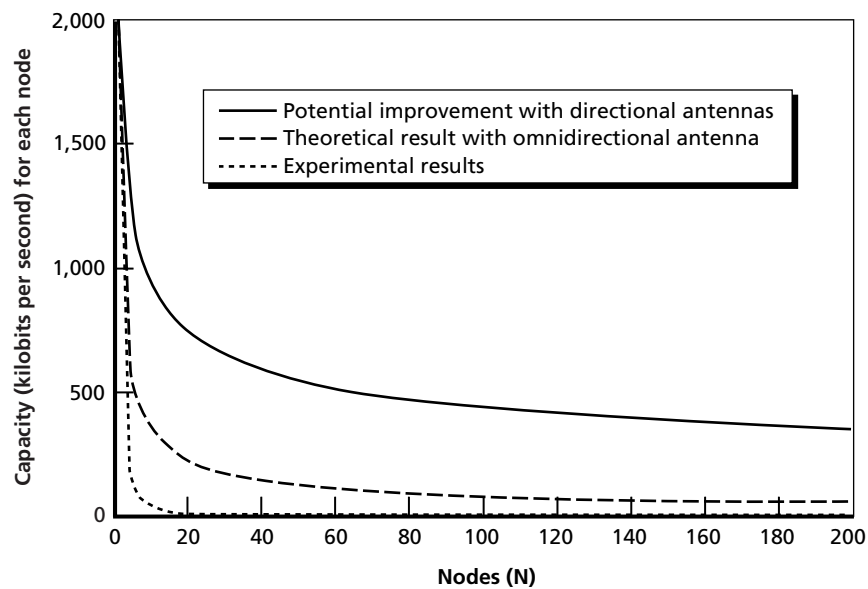

Proponents of NCO argue that its key attribute is the potential to connect to anyone, not necessarily constant or simultaneous use of all links. In other words, the network doesn't have to be fully connected at all times. Rather, it needs to be able to connect anyone at any time (McEver, 2004). This poses a difficulty for analysts. Exploratory analysis needs to examine how a given network could be potentially exploited by the warfighter. This will be very difficult for a scripted simulation. It is also difficult for real-world experimentation, which can only be repeated a small number of times. Some argue that only numerous stochastic simulations are appropriate to study these kinds of effects (Lucas, 2000), although the exact numbers of simulations depend on the underlying variance of the statistics used and the degree of accuracy required.<sup>4</sup> The research effort reported here uses stochastic, agent-based simulation to account for the dynamics of network use.

### NCO and the Impact of Human Factors and Behaviors

Baker (2002) highlights what he sees as “major problems that face NCW with regard to human tendencies.” They are listed below to highlight the potential interdependencies of networking concepts, human factors, and human behavior.

1. **Micromanagement:** the tendency for commanders to direct efforts at levels below their immediate subordinate commands.
2. **Information overload:** the result when information is acquired at a rate that impedes the information receiver's ability to process it.
3. **Poor degradation:** the inability to function autonomously if the network is compromised.
4. **Endurance:** decreased efficiency of the human mind after long periods of time.

Cianciolo (2003) considers the impact of human behavior on what he sees as one of the intended consequences of network-centric operations. Specifically, he considers the opportunity that NCO affords to redefine the size of the basic fighting unit. His critique is as follows:

Fewer warfighters will result in a condition of isolation for the individual soldier, and as we have seen through the study of human behavior in combat, the more isolated the individual warfighter becomes, the less combat effective he is because of the stress associated with the loss of association and safety of the group.

Clearly, the concept of NCO at the tactical level provides many areas of consideration involving what Gartska (2000) calls the “the cognitive domain.” Our simulations in the next chapter include some of these factors, e.g., ones that relate to cognitive capability and human behavior, albeit in a very basic manner. The cognitive aspects are focused on targeting capability.

---

<sup>4</sup> Quoting Lucas (2000): “The nature of combat, along with fundamental mathematical principles, implies that most combat simulations should be stochastic.”

## Simulation Experiments

---

In the following sections we will detail results from a number of experiments as part of a data farming effort.<sup>1</sup> “Data Farming is a method to address [a] decision-maker’s questions that applies high performance computing to modeling in order to examine and understand the landscape of potential simulated outcomes, enhance intuition, find surprises and outliers, and identify potential options” (source: [www.projectalbert.org](http://www.projectalbert.org)). As part of such an effort, a large number of MANA simulation runs can be used to provide enough information so that an algebraic expression of the performance response is formulated as a function of the factors of interest via regression analysis. This is also called meta-modeling (Law and Kelton, 1991).

### First Set of Experiments

To investigate the marginal impact of network performance on warfighter effectiveness, four sets of experiments were run.

#### Description of Scenario

In the first experiment, a simple scenario was developed to examine the marginal impact of communication capacity. The force-on-force simulation pitted a small Blue force consisting of two squads against an opposing Red force of 100 dismounted fighters. In the simulation, the fighting occurs in a stylized urban environment.

In this scenario, a squad of six Blue infantry armed with direct-fire weapons is moving from a position in the northwest (see Figure 3.1) to the southeast corner. (The term *squad* is used conceptually in MANA to represent any amount of soldiers sharing the same characteristics.) The members of this squad are to minimize enemy contact but engage if necessary, and based on that contact find the best way to reach the waypoint in the southeast. They have the support of another squad with an indirect-fire weapon with enough range to cover the entire city. The Red forces were randomly placed on the map, and they generally seek confrontation with the Blue forces. The purpose of this is to show how sensing

---

<sup>1</sup> Quoting Brandstein, Friman, and Horne (2001): “Data farming was first developed and used at the Marine Corps Combat Development Command in late 1997. It puts technology advances to work to engage the scientific method. The technique provides an opportunity to explore questions and grow more data in the areas of interest. This growth within a particular definition of a particular distillation might be in the form of more runs or a different preparation of the sample space to include different parameters, finer gradations of parameter values or greater ranges. After the execution of samples and analysis using data visualization and search methods, the data farmer is free to grow more data in interesting areas, integrate with information from other tools, prepare a different scenario using the same distillation, select another distillation or employ any combination of these possibilities that might lead to progress.”



and communicating can impact the battle on a fundamental level, ignoring complex behaviors or route planning. Although clearly outmatched (100 to 7), if the Blue force is conservative in its approach, it is able to reach the objective. Blue force benefits from an indirect precision weapon and a communication link that allows the Blue infantry squad to pass target information back to the indirect-fire squad. The Blue force makeup is illustrated in Figure 3.2. The Red force did not have such capacity.

**Figure 3.1**  
**Scenario: Small Force Maneuvering and Supported by Precision-Fire Area Weapon**



**Figure 3.2**  
**Blue Force Communication/SA Link**

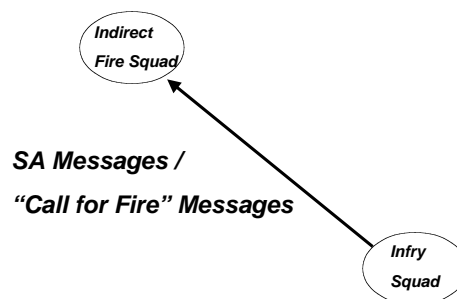

The only form of situational awareness (SA) the indirect-fire squad has, hence the only reason it fires, comes from the inorganic<sup>2</sup> messages it receives from the infantry squad. If messages are not being received, then the fire team will not discharge its weapon. A key motivation for using MANA is that agents in MANA react to messages about the state of other agents and adjust their movement and firing autonomously.

For our purposes, movement speed was left at one cell per simulation time step. We calibrate this to real-world time by considering that average human motion from walking to running is approximately 1–6 meters per second. We assume that each cell is approximately 5 meters in length, the agents move one cell per time step, and a time step is one second in duration. Since our scenario environment was  $200 \times 200$  cells, the approximate size of the town is 1 km<sup>2</sup>. The terrain utilized is a fictitious urban environment and depicts a small Blue force that is maneuvering with the support of a precision-fire area weapon.

For the described scenario, certain factors discussed in Chapter One were investigated using the data farming approach.

### Overview of Data Farming Effort

Factors in the scenario were varied to assess the effect on the scenario outcome in terms of the loss ratio (LR)<sup>3</sup> as part of a data farming effort (Horne, 1997). These factors were: (a) capacity, which reflects the number of messages that can be transmitted at one period; (b) latency, which represents any delay in terms of the message that gets passed when something is sensed and this information is communicated out; (c) accuracy, which determines if what is sensed is accurately classified as friend or foe or neutral; and (d) reliability, which is the likelihood that a message gets through.

To summarize, four key factors were varied in the experiments:

- Reliability (0–100 percent)
- Capacity (0–20 messages/step)
- Latency (0–4 time steps)
- Accuracy (50–100 percent)

### Data Farming Results

The synthesis of a meta-model of warfighter effectiveness for this experiment is described in the remaining paragraphs of this section.

Table 3.1 describes the experimental design. The meta-model that was synthesized, as described above, used the data from the results of the experiments. Linear least squares (LLS) regression was employed. After a number of attempts, a reasonable fit was achieved as evidenced by the R-square value of 0.85 and a significance level that was less than 0.001 (a plot of actual data versus model [predicted] data is in Appendix A). It was found that using the natural log (Ln) of capacity and capacity as terms improves the fit.<sup>4</sup>

<sup>2</sup> To distinguish between the two, MANA refers to intra-squad SA as organic and to inter-squad SA as inorganic.

<sup>3</sup> Loss ratio is the number of Red casualties divided by the number of Blue casualties.

<sup>4</sup> The best fit treated capacity and the log of capacity as separate terms, but for the purpose of illustrating the marginal impact of capacity as a parameter, we combined them in a different model.

**Table 3.1**  
**A Full Factorial Set of Experiments (First Set)**

	Capacity	Latency	Accuracy	Reliability
Min	0	0,2,4	50%, 100%	0,25,50,75,100
	5	0,2,4	50%, 100%	0,25,50,75,100
	10	0,2,4	50%, 100%	0,25,50,75,100
	15	0,2,4	50%, 100%	0,25,50,75,100
Max	20	0,2,4	50%, 100%	0,25,50,75,100

A profile of the impact of the factors for a similar model is shown in Figure 3.3 and illustrates the role of the terms capacity and log of capacity. The positive slopes for the reliability factor and the capacity factor follow intuition, i.e., the more reliable the message transmission, the more effective the warfighter in terms of loss ratio (LR).<sup>5</sup> Similarly, an increase in message latency hurts effectiveness. This is intuitive as well. Both Figure 3.3 and Table 3.2 indicate how reliability is significant relative to the other factors.

**Figure 3.3**  
**Profile of Impact of Various Factors for Similar Model**

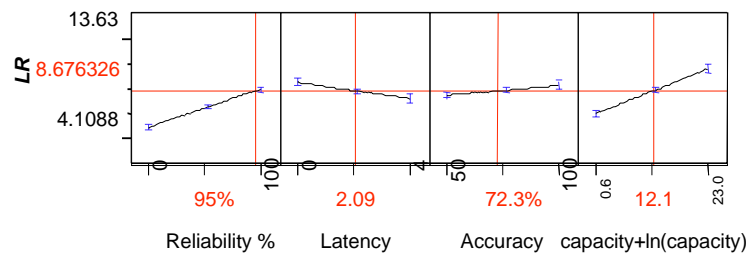

The model is the closed-form expression that is shown below (with rounded numbers) and in Appendix A. In the presentation of this equation and others that follow, the mean of the factor is subtracted from each factor (e.g., “Capacity – 10”).

$$\begin{aligned}
 LR = & (-13.25) + 0.037 * Reliability - 1.149 * Capacity + (Reliability - 50) * ((Capacity - 10) * \\
 & -0.0027) - 0.204 * Latency + (Reliability - 50) * ((Latency - 2) * -0.0044) + (Capacity - 10) * \\
 & ((Latency - 2) * 0.015) + 0.015 * Accuracy + (Reliability - 50) * ((Accuracy - 75) * 0.000107) \\
 & + (Capacity - 10) * ((Accuracy - 75) * -0.00072) + (Latency - 2) * ((Accuracy - 75) * \\
 & -0.0044) + 12.073 * (\ln(Capacity+2)) + (Reliability - 50) * (((\ln(Capacity+2)) - 2.21) * \\
 & 0.041) + (Capacity - 10) * (((\ln(Capacity+2)) - 2.21) * 0.46657) + (Latency - 2) * \\
 & (((\ln(Capacity+2)) - 2.21) * -0.211) + (Accuracy - 75) * (((\ln(Capacity + 2)) - 2.21) * \\
 & 0.013).
 \end{aligned}$$

<sup>5</sup> The Loss ratio (LR) is a typical measure of warfighter and force effectiveness. It is defined here as follows: LR = Red casualties / Blue casualties.

**Table 3.2**  
**Significance of Terms**

Term	Estimate	t Ratio	Prob> t
Intercept	-13.25166	-3.23	0.0014
Reliability	0.0370058	26.21	< .0001
Capacity	-1.149098	-4.03	< .0001
(Reliability - 50)*(Capacity - 10)	-0.002738	-4.46	< .0001
Latency	-0.204361	-6.69	< .0001
(Reliability - 50)*(Latency - 2)	-0.004444	-5.14	< .0001
(Capacity - 10)*(Latency - 2)	0.0148075	1.11	0.2668
Accuracy	0.014568	7.30	< .0001
(Reliability - 50)*(Accuracy - 75)	0.0001072	1.90	0.0587
(Capacity - 10)*(Accuracy - 75)	-0.000716	-0.82	0.4107
(Latency - 2)*(Accuracy - 75)	-0.004432	-3.63	0.0003
Ln(Capacity + 2)	12.072673	4.34	< .0001
(Reliability - 50)*(Ln(Capacity + 2) - 2.20964)	0.0407276	7.96	< .0001
(Capacity - 10)*(Ln(Capacity + 2) - 2.20964)	0.4665696	3.28	0.0012
(Latency - 2)*(Ln(Capacity + 2) - 2.20964)	-0.211188	-1.91	0.0575
(Accuracy - 75)*(Ln(Capacity + 2) - 2.20964)	0.0126874	1.75	0.0805

Table 3.2 shows how reliability is significant relative to the other factors. It suggests that the majority of the terms in the model are significant, assuming that likelihoods (see the third column) less than 5 percent are significant. Notable exceptions include the cross-product terms Capacity\*Accuracy and Capacity\*Latency.

Using the model above, plots of performance (as indicated by the LR) can be generated for various parameters. Figure 3.4 shows how the performance varies as communication capacity is varied. With LR as a surrogate for warfighter effectiveness and communications capacity a surrogate for networking capability, we argue that increases in warfighter effectiveness resulting from increased networking capability eventually diminish. Further detail on selected simulation runs from this experiment is found in Appendix A.

### Observations

One clear conclusion can be drawn from Figure 3.4: Warfighter effectiveness was affected by communication capacity. Specifically, effectiveness, as measured by LR, could be cut in half without sufficient capacity; message latency (delay) affected warfighter effectiveness by as much as 50 percent for a given capacity. The experiments and model above assumed that communication characteristics were static/fixed, i.e., capacity remained constant during the simulation, as did reliability and the other parameters. These results have to be considered specific to the scenario.

As shown earlier, communication capacity and reliability are variable and should be modeled dynamically. MANA was modified to insert a dynamic model. Other factors, like sensing and the rate that targets can be prosecuted, were also added. The results are discussed in the next section.

**Figure 3.4**  
**Plot of Warfighter Effectiveness (LR) as Capacity Varies**

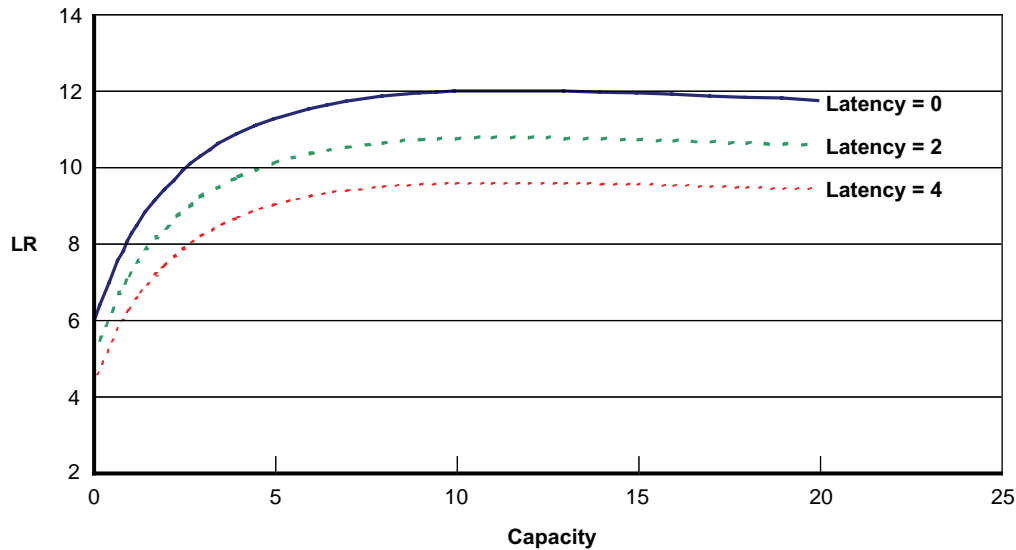

## Second Set of Experiments: Using a Dynamic Communication Model

### Description of Scenario

In this scenario, as in experiment 1, a squad of six Blue infantry armed with direct-fire weapons is moving from a position in the northwest to the southeast corner. The soldiers are to minimize enemy contact but engage if necessary, and based on that contact find the best way to reach the waypoint in the southeast. They have the support of an indirect-fire weapon with enough range to cover the entire city but are outmatched (100 to 7) in terms of sheer numbers. If the Blue force is conservative in its approach, it is able to reach the objective. The dynamic reliability model hurts communication capabilities but provides a more realistic reliability in terms of the impact of congestion.

### Overview of Data Farming Effort

In this experiment, reliability is not a factor included in the data farming effort. Instead, as is the case for the remaining experiments, a meta-model of communication reliability was inserted directly into MANA. We chose a meta-model that had a quadratic form, i.e., the equation we chose to use to characterize communication reliability is of the form  $ax^2 + bx + c$ , where  $x$  = load on the network as a fraction of capacity.<sup>6</sup> This was based on experimental simulations documented in Porche, Jamison, and Herbert (2004) using the Qualnet simulator. A plot of the actual equation used is shown in Figure 3.5. MANA was modified to utilize this equation instead of a static setting. Thus, a dynamic communication meta-model (of reliability) allows MANA to vary reliability based on message traffic and channel capacity during each time step. The dynamic reliability model appropriately reduces communication capabilities but provides more realistic reliability in terms of the impact of congestion.

<sup>6</sup> The values we estimated for the coefficients are  $a = -4.456$ ,  $b = -0.875$ , and  $c = 1.0145$ .

**Figure 3.5**  
Reliability Decreases as the Ratio of Data Rate to Capacity Increases

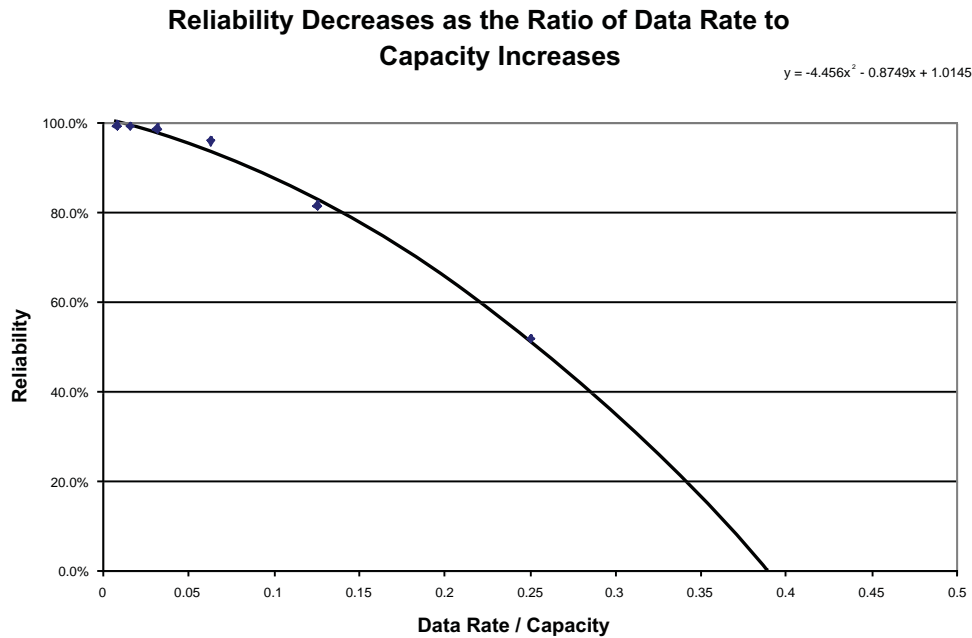

### Design of Experiments

Figure 3.6 shows the parameters chosen to address NCO components during the simulations run as outlined in Table 3.3. There were five levels for capacity, three levels for latency, three levels for accuracy, four levels for targeting rates, and four levels for sensing. This accounts for 720 excursions. Each (stochastic) design point is run 50 times, so a total of 36,000 runs were made for all of the values in Table 3.3.

**Figure 3.6**  
The Factors Chosen Address the Components of NCO

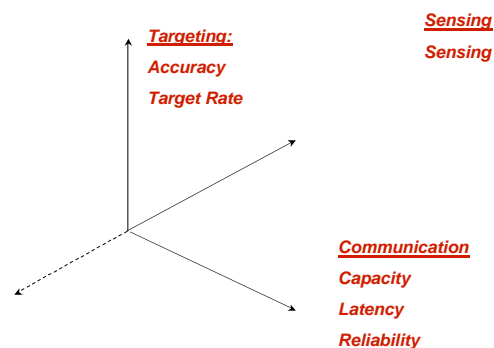

**Table 3.3**  
**A Full Factorial Set of Experiments (Second Set)**

	Capacity	Latency	Accuracy	Targeting Capability (Target Rate)	Sensing
Min	20	0,1,2	50%, 75%, 100%	50%, 100%, 150%, 200%	25,50,75,100
	40	0,1,2	50%, 75%, 100%	50%, 100%, 150%, 200%	25,50,75,100
	60	0,1,2	50%, 75%, 100%	50%, 100%, 150%, 200%	25,50,75,100
	80	0,1,2	50%, 75%, 100%	50%, 100%, 150%, 200%	25,50,75,100
Max	100	0,1,2	50%, 75%, 100%	50%, 100%, 150%, 200%	25,50,75,100

**Data Farming Results**

Using the same methods as in the first set of experiments, another meta-model was synthesized using the data from the experiments above. Linear least squares regression was employed. A reasonable fit (adjusted  $r^2 = 0.895$ , the significance is less than 0.001) was achieved. A plot of actual data versus predicted data is shown in Appendix A.

Analysis of this model highlights how sensing and communication factors (capacity and latency) significantly affect warfighter effectiveness as measured by the loss ratio (LR). Target rate and accuracy were less of a factor for this scenario.

**Figure 3.7**  
**Profile of the Impact of the Factors on Warfighter Effectiveness**

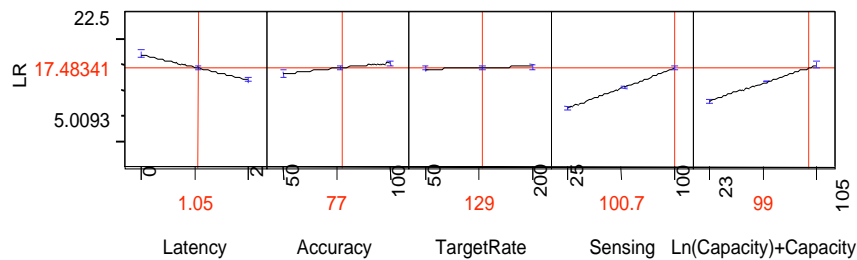

The significance of the model terms is shown in column three of Table 3.4. The lack of significance of target rate, by itself, is apparent; the likelihood that its coefficient is actually zero is approximately 40 percent.

Contour plots of the raw data from the simulation runs depict the relative sensitivities of the sensing and communication capacities. They are shown in Figure 3.8.

**Figure 3.8**  
**Relative Impact of Communication Capacity and Latency and Sensing Ability on Warfighter**

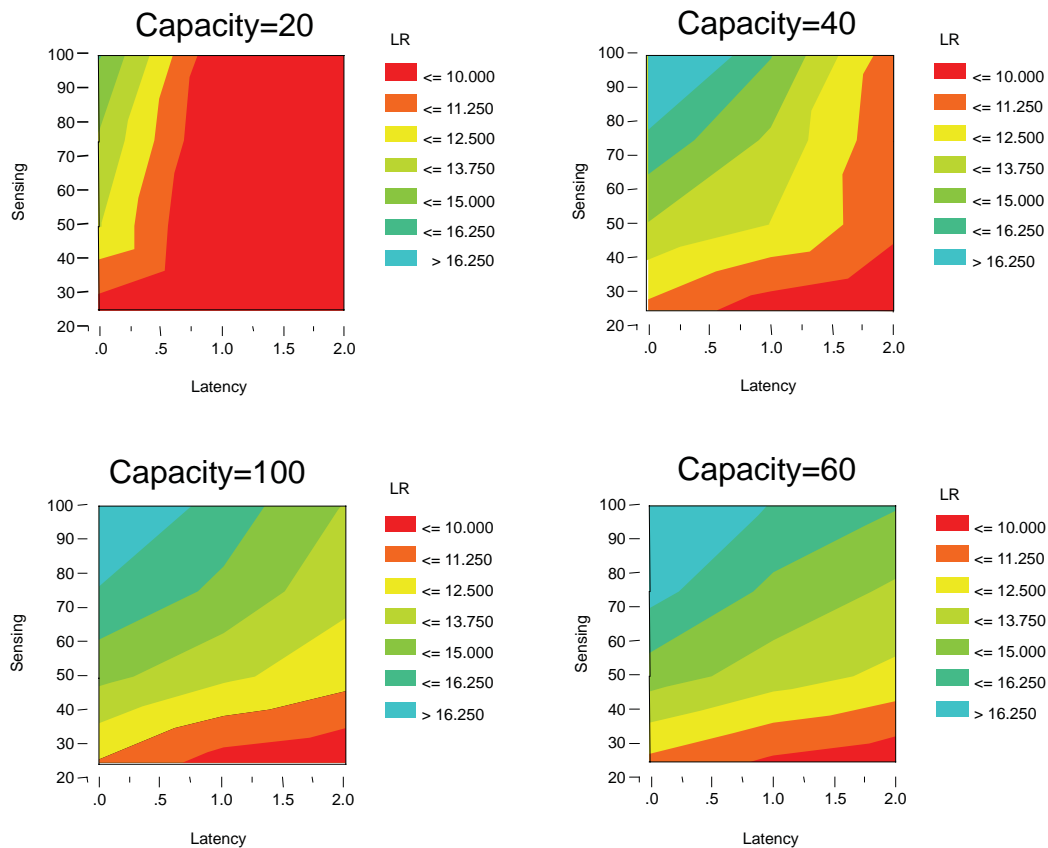

**Table 3.4**  
**Model Formula with Tests of Terms**

Term	Estimate	t Ratio	Prob >  t
Intercept	-72.620518	-3.585856	0.000363804
Capacity	-0.483965	-3.464287	0.000570206
Latency	-2.048534	-35.827286	0.000000000
(Capacity - 56.3158)*(Latency - 0.94737)	-0.006666	-0.819997	0.412549071
Accuracy	0.036934	16.300223	0.000000000
(Latency - 0.94737)*(Accuracy - 75)	-0.004117	-1.501654	0.133721348
TargetRate	0.000699	0.834888	0.404118945
(Latency - 0.94737)*(TargetRate - 125)	-0.005131	-5.056072	0.000000572
Sensing	0.067194	40.108477	0.000000000
(Capacity - 56.3158)*(Sensing - 62.5)	-0.000842	-3.545658	0.000422694
(Latency - 0.94737)*(Sensing - 62.5)	-0.024150	-11.880994	0.000000000
(Accuracy - 75)*(Sensing - 62.5)	0.000358	4.419294	0.000011786
(TargetRate - 125)*(Sensing - 62.5)	0.000104	3.467495	0.000563580
Ln(capacity)	26.801712	3.846034	0.000133109
(Capacity - 56.3158)*(Ln(capacity) - 3.87424)	0.193605	2.864815	0.004321080
(Latency - 0.94737)*(Ln(capacity) - 3.87424)	1.554273	3.816312	0.000149760
(Accuracy - 75)*(Ln(capacity) - 3.87424)	-0.018908	-4.854958	0.000001544
(Sensing - 62.5)*(Ln(capacity) - 3.87424)	0.075135	6.311532	0.000000001



### Observations

Sensing capability seems critical from our experiments; perhaps communications capacity is also as critical. The most important observation is that all three trade off against each other to some extent. Increasing just one of the three capabilities, without adjusting the others, may not result in a gain to warfighter effectiveness. In other words, for this scenario, assessments of the impacts of communication capacity without sufficient consideration of sensing capability could be misleading, and vice-versa. As shown in Figure 3.9, without good accuracy and targeting capability, results are very poor. The chart shows what we believe is intuitive: LR is proportional to Accuracy \* TargetRate.

**Figure 3.9**  
**Accuracy Versus Target Rate**

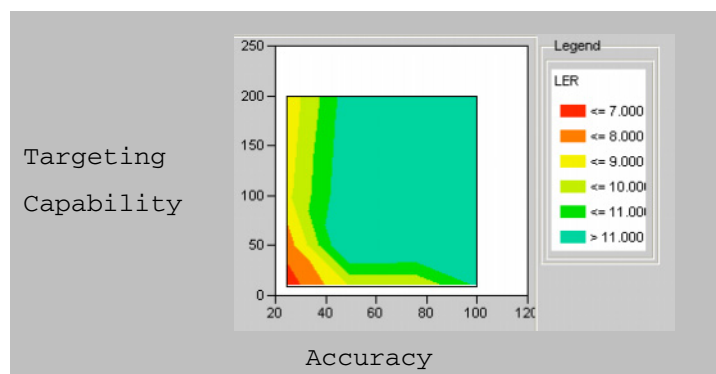

### Third Set of Experiments: Expanded Three-Squad Scenario

#### Description of Expanded Scenario

To better understand the marginal impact of communications, an expanded scenario was developed. A second squad of six infantry was added to the initial scenario. Each squad had its own communications link to pass messages to the indirect-fire squad. As shown in Figure 3.10, each squad's link is independent of the others. The existing numbers of Red forces were doubled in an attempt to generate increased communications activity.

At the end of each time step, a random order is determined in processing the communication queues<sup>7</sup> related to each squad. The two squads do not share capacity; capacity is preallocated to each one.

<sup>7</sup> The communication queue is the location where all messages from the squad are placed before being sent on the communications link. This is where a message is sent, or not sent, based on reliability and capacity (among other factors).

**Figure 3.10**  
**Blue Force Communication Link (Expanded Scenario)**

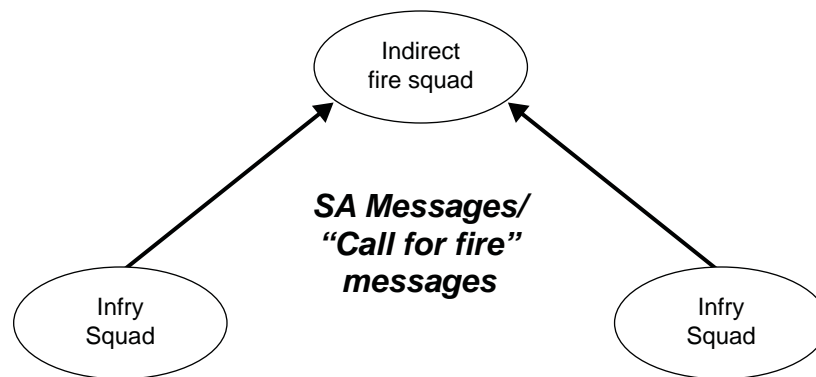

### Data Farming Results

The design of experiments is as follows: 216 combinations of factors were considered as shown in Table 3.5. Fifty runs were completed for each combination of factors for a total of 10,800 runs.

**Table 3.5**  
**A Full Factorial Set of Experiments Totaled 10,800 Runs**

	Squad 1 Capacity	Squad 2 Capacity	Latency	Accuracy	Targeting Capability	Sensing
<b>Min</b>	10	10,40,80	0,4	50%,100%	50%,100%,250%	50,100
	40	10,40,80	0,4	50%,100%	50%,100%,250%	50,100
<b>Max</b>	80	10,40,80	0,4	50%,100%	50%,100%,250%	50,100

A model was successfully fit to the resulting data. A better fit was achieved using the natural log of LR rather than simply LR. This was noticed for all subsequent models. The fit has an adjusted R-square value of 0.94 and a significance of less than 0.0001. (A plot of actual versus model-predicted data as well as the model's equation can be found in Appendix A). Analysis of the significance of each term is shown in Table 3.6.

**Table 3.6**  
**Terms of Model from Third Set of Experiments**

Term	Estimate	t Ratio	Prob> t
Intercept	-1.296511531	-2.07077503	0.03922918
CapacitySqd1	0.023468764	4.82209667	2.25555E-06
CapacitySqd2	0.027399798	5.62980117	4.1246E-08
(CapacitySqd1 - 43.3333)*(CapacitySqd2 - 43.3333)	-0.0002843	-1.67501117	0.094967144
Latency	-0.990199934	-14.1907054	2.25771E-35
(CapacitySqd1 - 43.3333)*(Latency - 2)	0.006961224	2.860627372	0.004522931
(CapacitySqd2 - 43.3333)*(Latency - 2)	0.005752684	2.363993223	0.018711918
Accuracy	0.042456186	7.605575391	3.62235E-13
(CapacitySqd1 - 43.3333)*(Accuracy - 75)	-0.00021383	-1.09838266	0.272912341
(CapacitySqd2 - 43.3333)*(Accuracy - 75)	-9.84688E-05	-0.50580626	0.613361652
(Latency - 2)*(Accuracy - 75)	-0.003749573	-1.34339245	0.180153507
Targeting	0.002041734	1.243327757	0.214711415
(CapacitySqd1 - 43.3333)*(Targeting - 133.333)	-1.68459E-05	-0.29415518	0.768841403
(CapacitySqd2 - 43.3333)*(Targeting - 133.333)	-8.33756E-06	-0.14558622	0.884345165
(Latency - 2)*(Targeting - 133.333)	-0.002092867	-2.54893154	0.01129988
(Accuracy - 75)*(Targeting - 133.333)	1.12169E-05	0.170765478	0.864522526
Sensing	0.116404973	30.71010418	6.70038E-95
(CapacitySqd1 - 43.3333)*(Sensing - 53.3333)	0.000394817	2.986756339	0.003050541
(CapacitySqd2 - 43.3333)*(Sensing - 53.3333)	0.000491893	3.721127598	0.000236485
(Latency - 2)*(Sensing - 53.3333)	-0.019494371	-10.2860582	1.79309E-21
(Accuracy - 75)*(Sensing - 53.3333)	0.000738129	4.868354441	1.81711E-06
(Targeting - 133.333)*(Sensing - 53.3333)	4.31927E-05	0.968402668	0.333618207

**Observations: Quantifying the Relative Impact of Sensors and Cognition**

It was observed that sensing is very significant. Table 3.6 (for experiment 3) quantifies the significance of this term. It should be noted that when communication capability (capacity and latency) is good, sensing has a large impact on warfighter effectiveness. If communication capability is poor (e.g., increased latency coupled with low capacities for both squads), then the sensors are ineffective. This is what is evident from Figure 3.11, which indicates the approximate change in LR for a small change in one of the factors. This also follows intuition. A common thread between this experiment and previous experiments was that message latency again proved it could impact LRs by as much as 50 percent. Clearly, the impact of communication factors cannot be ignored.

**Figure 3.11**  
**Profile of Factors for Experiment 3**

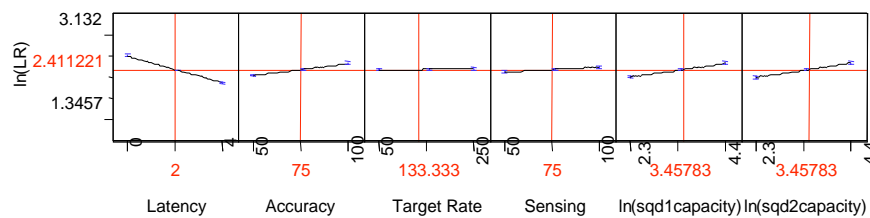

### Fourth Set of Experiments: "Mosque-UAV" Scenario Description

Two variants of a mosque-scenario are detailed as follows.

#### Direct-Fire Case (Variant 1)

**Description of Scenario.** The scenario used is depicted in Figure 3.12 and is outlined as follows. Blue forces are attempting to secure an area around a mosque and stop Red forces from entering. Blue relies on a set of four 12-man infantry squads. Blue force has UAVs that help with sensing and communicating. The squads have direct-fire weapons only. Red's mission: seek safe haven in the mosque where Blue cannot enter. Blue is seeking enemy contact because their goal is to stop Red from reaching the mosque. To keep Blue from firing on targets inside the mosque, a special terrain type was added that gave the Red forces 100 percent concealment while inside. There are two squads of Red forces, six leaders, and thirty security

**Figure 3.12**  
**UAVs in Urban Area: Direct-Fire Only**

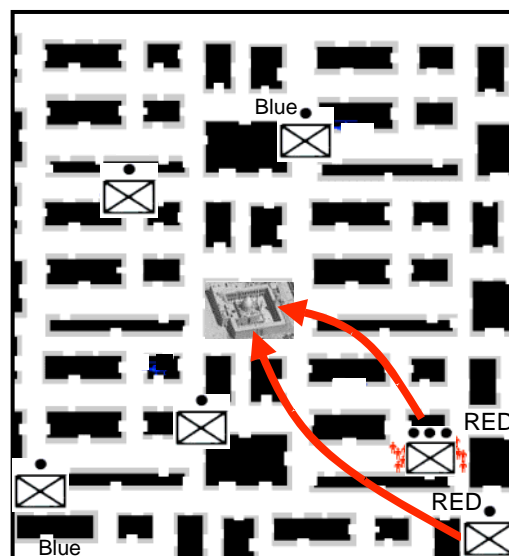

forces. The security forces are better equipped than their counterparts in experiments 1–3, and will stay with the leaders at all costs. They are successful when the leaders are able to move unimpeded to the mosque.

The result: It was observed that the more far-ranging the sensing ability of the Blue force infantry squads, the worse the outcome. The reason: the fight between Red and Blue infantry, in this scenario, was mostly even. So, increased sensing increased engagements overall and thus caused casualties on both sides. For example, the maximum LR seen for this scenario was one where the sensing capability of the Blue squads was most limited.

**Results of Data Farming Effort.** A model of the log of the LR was fit from the output of the simulation experiments run in MANA. A reasonable fit was achieved (R-square value is 0.84). The factors<sup>8</sup> involved were varied as shown in Table 3.7 and are explained as follows:

- “RangerSensing” and “UAVSensing” represent the ability of the infantry squads and the UAVs to sense the presence of Red forces.
- “Accuracy” determines whether what is sensed is accurately classified as friend or foe or neutral.
- “Latency” represents any delay in terms of the message that gets passed when something is sensed and this information is communicated out.
- “Capacity” reflects the number of messages that can be transmitted at one period.

Analysis of the factors shows the ability of the infantry (“Ranger”) squads to sense Red forces (labeled “RangerSensing”) predominated; increasing the communication capacity or sensing ability (RangerSensing or UAVSensing) did not significantly increase the warfighter effectiveness as measured by the LR.

Appendix A contains the model’s formula. Table 3.8 confirms the significance of the sensing ability (RangerSensing) on the Blue force’s performance and this is seen in Figure 3.13. Figure 3.14 incorporates the model’s formula and shows a decrease in warfighter performance, as measured by the LR, when RangerSensing is increased and the other factors, which have relatively little effect according to Figure 3.13, are held fixed.<sup>9</sup>

**Table 3.7**  
**Design of Experiments**

	Capacity	Ranger Sensing	UAV Sensing	Accuracy	Latency
<b>Min</b>	5	10,30,50	50,100,150	50%,100%	0,4
	25	10,30,50	50,100,150	50%,100%	0,4
	50	10,30,50	50,100,150	50%,100%	0,4
	75	10,30,50	50,100,150	50%,100%	0,4
<b>Max</b>	100	10,30,50	50,100,150	50%,100%	0,4

<sup>8</sup> Reliability is modeled dynamically.

<sup>9</sup> “UAVSensing” was fixed at 150, “Accuracy” was 75, “Latency” was 0, and “Capacity” was 148.

**Table 3.8**  
**Terms of Model: Direct-Fire Case (Variant 1)**

Term	Estimate	t Ratio	Prob >  t
Intercept	-2.6859045	-37.6396	1.5E-108
RangerSensing	0.0002678	0.354185	0.7234805
UAVSensing	0.0015678	6.348075	9.364E-10
(RangerSensing - 30)*(UAVSensing - 100)	-3.967E-05	-2.6227	0.0092267
Accuracy	0.0282132	57.1183	2.43E-151
(RangerSensing - 30)*(Accuracy - 75)	-4.98E-05	-1.64642	0.1008579
(UAVSensing - 100)*(Accuracy - 75)	1.397E-05	1.414376	0.158421
Latency	-0.1249862	-20.243	8.747E-56
(RangerSensing - 30)*(Latency - 2)	-0.0005452	-1.44194	0.1504954
(UAVSensing - 100)*(Latency - 2)	-0.0004222	-3.4192	0.0007266
(Accuracy - 75)*(Latency - 2)	-0.0033407	-13.5266	4.429E-32
IFRange	0.1010521	13.36328	1.648E-31
(RangerSensing - 30)*(IFRange - 4)	0.0008309	1.794275	0.0739047
(UAVSensing - 100)*(IFRange - 4)	0.0001704	1.126834	0.2608282
(Accuracy - 75)*(IFRange - 4)	0.0026394	8.726017	2.948E-16
(Latency - 2)*(IFRange - 4)	-0.0206377	-5.45831	1.101E-07
Ln(capacity)	0.2115579	19.03393	1.45E-51
(RangerSensing - 30)*(Ln(Capacity) - 3.3364)	0.0007487	1.099934	0.2723555
(UAVSensing - 100)*(Ln(Capacity) - 3.3364)	0.0011806	5.311125	2.303E-07
(Accuracy - 75)*(Ln(Capacity) - 3.3364)	0.0056576	12.72535	2.714E-29
(Latency - 2)*(Ln(Capacity) - 3.3364)	0.0221507	3.985814	8.692E-05
(IFRange - 4)*(Ln(Capacity) - 3.3364)	0.0263929	3.877668	0.000133

**Figure 3.13**  
**Model Factors for Variant 1**

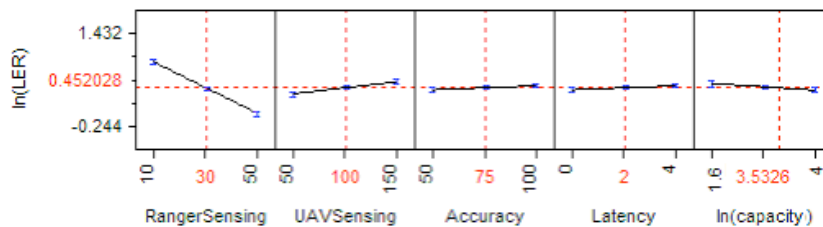

**Figure 3.14**  
**Improved Sensing Resulted in Reduced Performance in Variant 1**

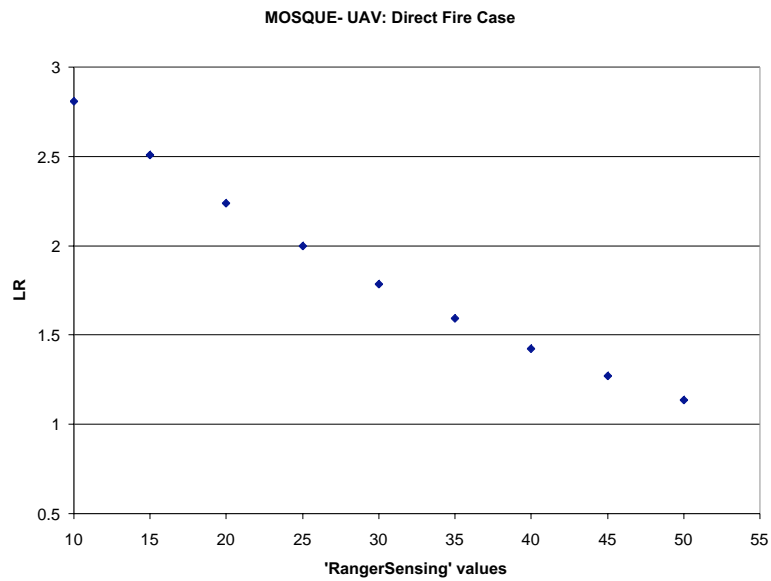

As noted earlier, the better Blue's sensing, the worse its outcome. Additional excursions that varied the squad size showed no difference in outcome in terms of average LR. These are shown in Table 3.9. The reason: The direct-fire fight is still fairly even in terms of capabilities. Increased sensing increases casualties somewhat evenly on both sides. In the next section, this scenario is modified to enhance the Blue force's makeup by adding indirect-fire capabilities.

**Table 3.9**  
**Variant 1 With Squad Size Varied**

	6-man squads	9-man squads	12-man squads
Mean LR	1.64	1.67	1.76
Max LR	3.75	3.83	4.18
Min LR	0.7	0.66	0.78

### Indirect-Fire Case (Variant 2): A Scenario With Enhancements to Blue

**Description of the Scenario.** We modified the scenario by adding an indirect-fire weapon to the Blue force, which also has four UAVs that provide sensing and communicating capability (see Figure 3.15). We refer to this as Variant 2. The UAVs are spaced evenly and move in a preplotted circular fashion above the city. They are fully networked, as shown in Figure 3.16. The Red forces will occasionally shoot at them, but they are difficult to hit. Blue is seeking enemy contact because its goal is to stop Red from reaching the mosque. To keep Blue from firing on targets inside the mosque, a special terrain type was added that gave the Red forces 100 percent concealment while inside. The security forces are better equipped

than their counterparts in experiments 1–3, and will stay with the leaders at all costs. They are successful when the leaders are able to move unimpeded to the mosque.

**Figure 3.15**  
UAVs in Urban Scenario with Indirect-Fire Support (Variant 2)

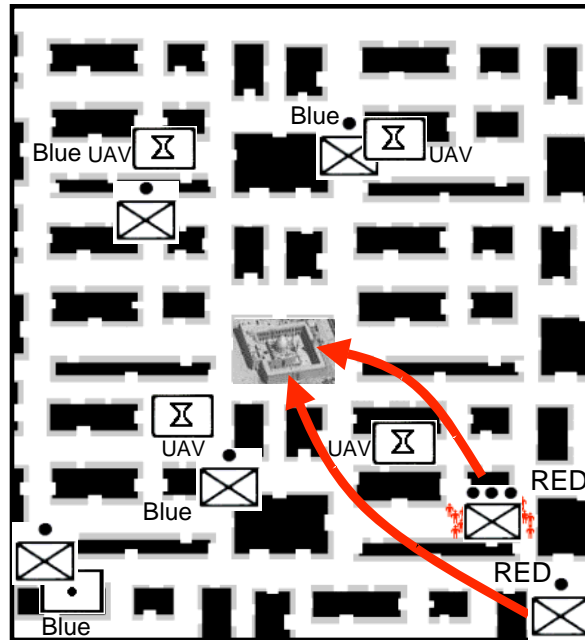

**Figure 3.16**  
Situational Awareness Is Shared Throughout All Blue Forces

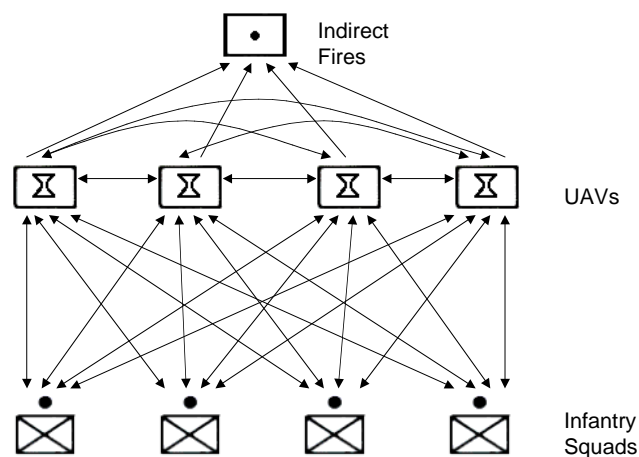



**Results of Data Farming Effort.** The results from augmenting the Blue force are significant: Mean LR was 2.2, with maximum LR an order of magnitude higher. The UAVs in the scenario are fully networked, so SA is shared among all Blue forces. In all, 288 combinations of factors resulted in 14,400 runs. A model of the log of the LR was fit from the output of the simulation experiments run in MANA, achieving an excellent fit ( $r^2$  value of 0.95). The significant terms of the model are shown in Table 3.10.

Analysis of the marginal impact of the individual factors is shown in Figure 3.17. Accuracy is the predominant factor: The more accurate the SA messages, the more effective the Blue force is in terms of LR. Increased accuracy also decreased casualties to noncombatants. Increased sensing on the UAV and improved communicating ability now help in this scenario, unlike the previous one, where increased networking (or C4ISR ability) hurt performance.

It also shows that unlike the earlier scenario runs that did not have an indirect-fire weapon, increasing the communication capacity did improve warfighter effectiveness as measured by the LR. Overall, the implication in comparing results from the two scenarios is that network capability may sometimes increase warfighter effectiveness, and sometimes it may not. The outcome is dependent on the scenario and the force makeup involved.

**Figure 3.17**  
**Profile of Factors**

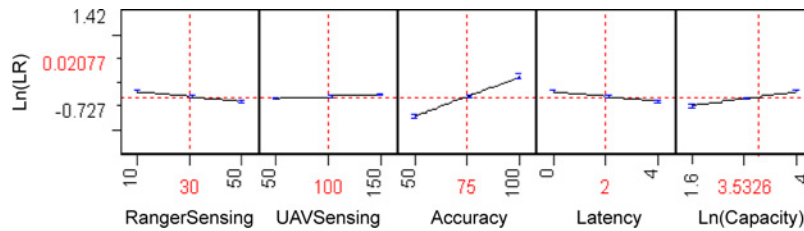

The equation that represents the synthesized model was fit to the data generated by the simulation experiments. Table 3.10 quantifies the significance of each term of the model and confirms the significance of accuracy.

**Table 3.10**  
**Terms of Model: Indirect-Fire Case (Variant 2)**

Term	Estimate	t Ratio	Prob> t
Intercept	-0.26507268	-4.54894075	1.89561E-05
RangerSensing	-0.00909447	-13.3391445	4.90514E-22
UAVSensing	0.001383295	6.212280551	2.2068E-08
(RangerSensing – 30)*(UAVSensing – 100)	-3.3933E-05	-2.48849842	0.014904617
Accuracy	0.002197356	4.934086155	4.30331E-06
(RangerSensing – 30)*(Accuracy – 75)	-0.00017721	-6.49787211	6.42529E-09
(UAVSensing – 100)*(Accuracy – 75)	-8.771E-06	-0.98474662	0.32771747
Latency	0.011784977	2.117020814	0.037365102
(RangerSensing – 30)*(Latency – 2)	0.000415976	1.220249413	0.225955158
(UAVSensing – 100)*(Latency – 2)	-0.00023843	-2.14155368	0.035272111
(Accuracy – 75)*(Latency – 2)	-0.00021789	-0.97853726	0.330758582
Ln(Capacity)	-0.02076718	-2.07233476	0.041455015
(RangerSensing – 30)*(Ln(Capacity) – 3.33638)	-0.00058586	-0.95469111	0.342609854
(UAVSensing – 100)*(Ln(Capacity) – 3.33638)	0.000496115	2.475339985	0.015423514
(Accuracy – 75)*(Ln(Capacity) – 3.33638)	0.000556827	1.389130495	0.16864782
(Latency – 2)*(Ln(Capacity) – 3.33638)	-0.01062972	-2.12145683	0.036978858

### Other Performance Measures

This scenario was used again with more simulation runs. However, instead of measuring the outcome with LR, the outcome was redefined as a binary variable called “mission success.” Specifically, Blue succeeds if it stops all Red high-value targets from reaching the mosque in the center of town. If one of the targets enters the mosque successfully, then Blue will have failed its mission. The mean success rate of all excursions is listed in the tables that follow.

As the data in Table 3.11 suggests, changing the size of the squads has a positive impact on the success rate of the Blue force for the scenario where Blue only has direct-fire weapons, despite the small change in LR. Of course, the results from the indirect-fire experiment, where Blue now has indirect-fire capabilities added, show it to be much more effective. Interestingly, Blue doesn’t benefit from adding more men per squad for this indirect-fire case; the data in Table 3.12 suggests that the likelihood of success remains virtually unchanged as a function of squad size.

**Table 3.11**  
**Direct-Fire (Variant 1) Excursions with Binary Mission Success Variable**

	6-man	9-man	12-man
Mean Loss Ratio	1.64	1.67	1.76
Max Loss Ratio	3.75	3.83	4.18
Min Loss Ratio	0.70	0.66	0.78
Likelihood Blue Objective Achieved	10%	17%	28%

**Table 3.12**  
**Indirect-Fire (Variant 2) Excursions with Binary Mission Success Variable**

	6-man	9-man	12-man
Mean loss ratio	1.92	1.19	1.19
Max loss ratio	5.72	3.65	4.13
Min loss ratio	0.65	0.52	0.48
Likelihood Blue Objective Achieved	34%	39%	38%

A new model was fit using the logit function (see Appendix A) so that the performance metric is now the likelihood of mission success. The figure below shows the relative impact of factors against Blue’s mission success for the 12-man squad. The accuracy of information coming in from the battlefield has significant impact on the success of the Blue team. If high-value targets can be identified correctly, the probability for success increases by as much as 20 percent.

Using the model described earlier, we see the impacts of accuracy in context. Force makeup is important both in composition (indirect-fire or none) and size (12-man versus 6-man). Comparisons of Tables 3.11 and 3.12 show how the use of precision indirect-fire facilitates a nearly equivalent measure of mission success with far less manpower (e.g., squad size). This is consistent with some of the hypotheses of NCO. This is made even clearer in Figures 3.18 and 3.19.

**Figure 3.18**  
**The Communication of Accurate Information Is Needed to Increase Odds of Success (p) in Variant 1**

**Accurate Reporting of High Value Target Locations Combined With Good Communications Can Boost Mission Success Rates**

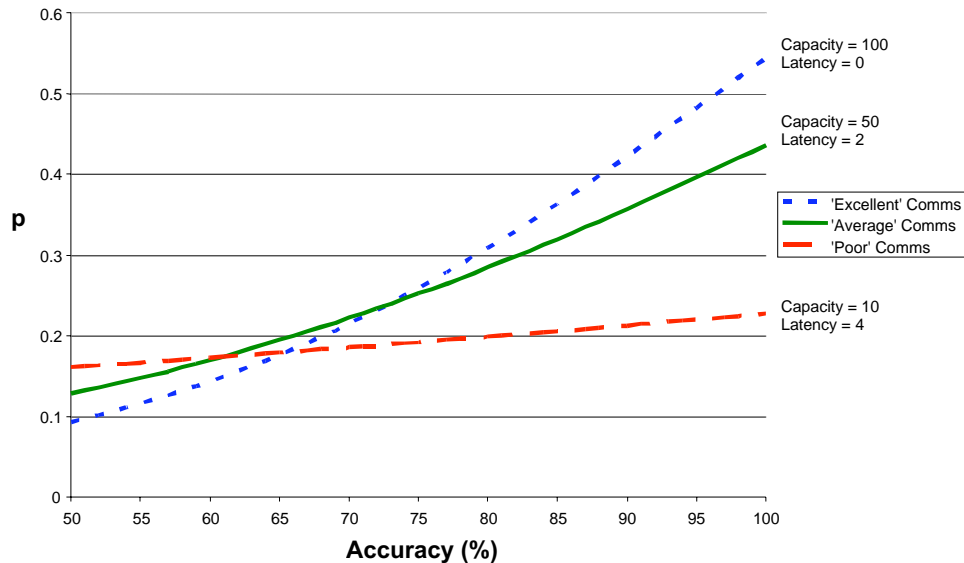

**Figure 3.19**  
**Force Makeup Was a Key Determinant**

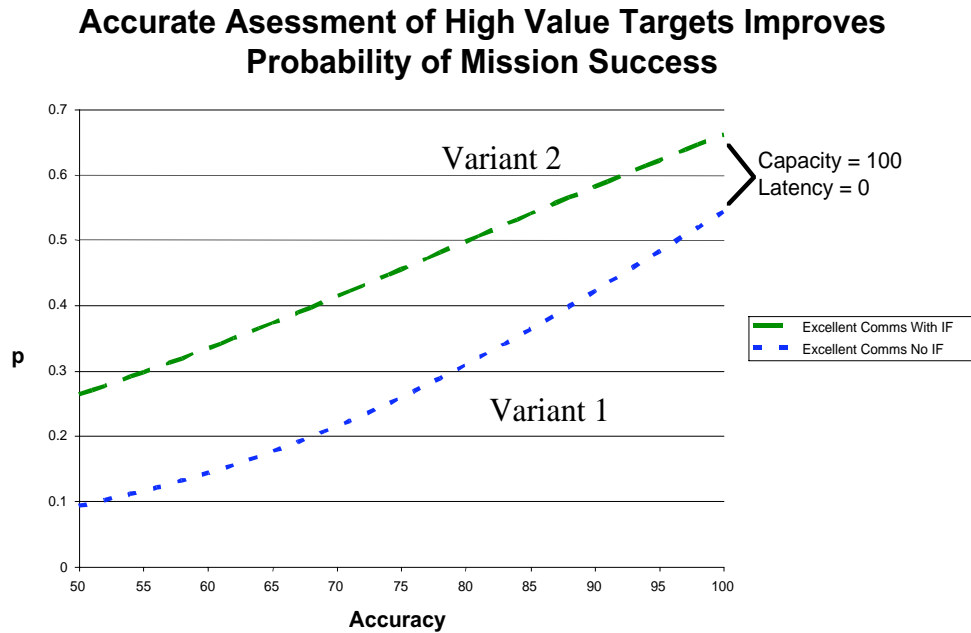

### Observations

The implication in comparing results from the scenarios just described is that network capability may sometimes increase warfighter effectiveness. Clearly, there is a minimum force makeup required before any enhancement can be seen. The curve that represents warfighter effectiveness given varying levels of networking capability can be nonincreasing or nondecreasing depending on the makeup of the force and firepower. Downes, Kwinn, and Brown (2004) had similar results: With regard to a direct-fire only scenario and a simulation of Blue infantry versus Red infantry in a small urban setting, they noted that they could not conclude that the increased situational awareness of the Land Warrior-equipped soldiers led to increased lethality and survivability; they utilized human-in-the-loop experimentation to draw the conclusion. For a set of MANA simulation runs of infantry squads in an urban environment, the same researchers again reached conclusions that were similar to what this report also found, i.e., “the force with improved situational awareness can only take advantage of their enhanced abilities to communicate and share a common vision of the battlefield if they are given additional combat multipliers such as artillery or attack helicopters” (Downes, Kwinn, and Brown 2004).

The analysis framework used in this report is one where warfighter effectiveness is a function of networking parameters that are input into and translated by the MANA force-on-force simulator. The results presented suggest that no “level of networking” or “degree of networking” can be defined as adequate, for NCO or other concepts, outside of any context. Specifically, the structure of the force and the scenario are additional significant factors. As Figure 3.14 illustrates, increased networking capability does not necessarily increase war-

fighter effectiveness.<sup>10</sup> As Figure 3.4 illustrates, when there are increases, they are not unbounded, i.e., increases in warfighter effectiveness eventually diminish as a result of increased networking capability.

Finally, two different performance metrics were considered: a loss ratio and a probability of mission success. In hindsight, a combination of the two metrics could be more useful. In a generalized form, we can express this as  $(1 - w)LR + wP$ , where  $LR$  is the loss ratio,  $P$  is the probability of mission success, and  $w$  is an arbitrary constant between zero and one that varies the importance of mission success over loss ratio. For example, for  $w = 1$ , mission success would be weighted such that the performance measure is impacted largely by mission success relative to loss ratio.

It is important to keep these simulation results in the proper context. Actual force makeup, network architecture, and communication performance may deviate from the assumptions in this report. The authors would like to claim that these results remain applicable even when finer resolution of technical and operational specifications are utilized. That remains to be seen. However, the integration of a high-resolution communication network simulator is under way which may verify these results. The tool being used is Qualnet®. Qualnet (or other suitable high-resolution networking modeling tools) can account for antenna models, routing protocols, signal power, and frequency of transmission. Currently, we relied on a meta-model to characterize dynamic message reliability. Although this meta-model was synthesized using Qualnet, we leave it to future work to repeat these examinations without the use of meta-models and perhaps with a force makeup that reflects actual future Army plans and official scenarios. As suggested, this would necessitate the integration of high-resolution network simulators to the force-on-force tool, which may or may not be practical.

---

<sup>10</sup> We assume two things: We can use (i) LR as a surrogate for warfighter effectiveness and (ii) communications capacity as a surrogate for networking capability in the case of the sufficient force makeup and sensing capacity as a surrogate for network capability. However, in both cases, these factors dominated the other parameters.

## Overall Conclusions

---

There are many factors that impact the effectiveness of battlefield networks. We initially identified three sets of factors: communication, sensing, and cognitive capabilities. In addition, we observed that the force makeup affected the marginal impact of these three factors. Some of the critiques of the networked operation, as summarized in the recent GAO report, are the result of a deficiency in one of these areas. For example, that report (GAO, 2004) noted: “The improved ability to share view of the battlefield and communicate quickly has compressed the time required for analysis and decision making such that large increases in the pace of operations and the volume of information have overwhelmed commanders at times.” This critique relates to improvement in communication without a corresponding improvement in cognitive/fusing capabilities. A second major critique in the same GAO report was as follows: “Slow or inaccurate [battle damage] assessments negated improvements in the speed of operations; battle damage assessments didn’t keep up with the pace of operations.” This directly relates to sensing deficiencies. Nonetheless, the same report found that overall it was improvements in force networks and the use of precision weapons that were the primary reasons for the overwhelming combat power in Operation Iraqi Freedom.

In this report, we considered a few components of the cost of networking (e.g., a model on the limits on a communication channel). The model was inserted into an agent-based, force-on-force combat simulator for a simple urban scenario. One clear conclusion is that warfighter effectiveness was affected by communication capacity. Specifically, effectiveness, as measured by a loss ratio, could be cut in half without sufficient capacity; message latency (delay) affected warfighter effectiveness by as much as 50 percent for a given capacity. We observed that the improvement in effectiveness, as a result of increasing communication capacity, diminishes eventually. We also observed a case where warfighter effectiveness decreases with networking capability.

Network capability may sometimes increase warfighter effectiveness and sometimes it may not; it depends on the scenario and the force makeup involved along with the key networking parameters investigated (sensing, communicating, targeting). These observations are counter to Metcalfe’s Law and Reed’s Law. This is illustrated in the notional curves of Figure 4.1, which is supported by data in the body of this report (see Figures 3.4 and 3.14) for a given scenario that had varied the makeup of the force. Therefore, we conclude that it is not only the sensing, communication, and certain cognitive parameters of networking that determine effectiveness, but also the force makeup that is utilizing these networking capabilities.

Although a large space of possibilities was explored for the parameters under consideration, all results need to be taken in the context of the specific scenarios simulated. Specifically, the results in this report may be sensitive to the assumptions that are made with regard to network architecture, force makeup, technology performance, and the focus at the tactical

level. Nonetheless, the results show how agent-based tools, when sufficiently validated, can be exploited to quantify the impact of networks and networking performance to warfighters.

**Figure 4.1**  
**Situations Where Networking Capability Increased Warfighter Effectiveness**

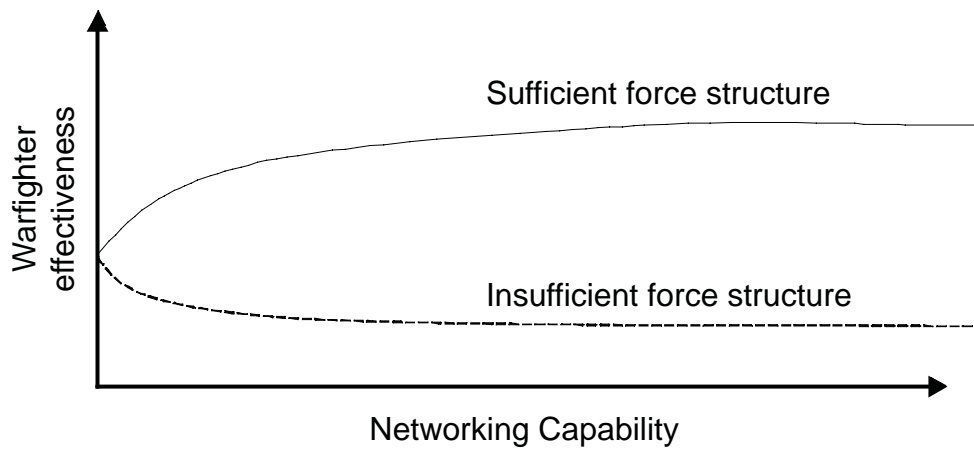

It is important to note that communication capacity depends on frequency spectrum allocation. Effective spectral and network management could help improve available capacity. This will be studied as part of future work.

## Synthesized Models

---

### First Set of Experiments

Figure A.1 is a plot of the actual versus predicted for the metamodel synthesized for experiment 1.

**Figure A.1**  
**Predicted Versus Actual for Experiment 1 Model Fit**

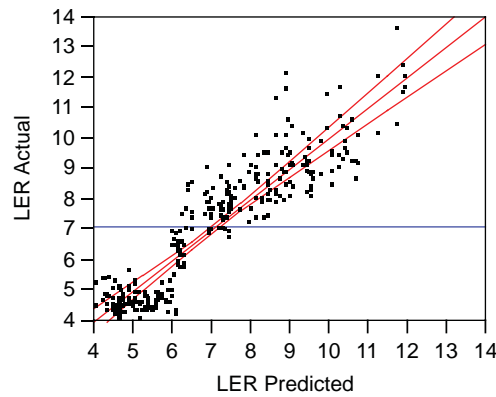

The equation for the model resulting from analysis of the first set of simulation runs is shown below.

$$\begin{aligned}
 LR = & (-13.25166) + 0.037006 * Reliability - 1.14909751293089 * Capacity + (Reliability - 50) * \\
 & ((Capacity - 10) * -0.0027384) - 0.204360923621705 * Latency + (Reliability - 50) * \\
 & ((Latency - 2) * -0.0044439) + (Capacity - 10) * ((Latency - 2) * 0.0148075) + 0.014568 * \\
 & Accuracy + (Reliability - 50) * ((Accuracy - 75) * 0.00010717) + (Capacity - 10) * \\
 & ((Accuracy - 75) * -0.00071616) + (Latency - 2) * ((Accuracy - 75) * -0.0044325) + \\
 & 12.07267 * (\ln(Capacity+2)) + (Reliability - 50) * (((\ln(Capacity+2)) - 2.20964) * \\
 & 0.040728) + (Capacity - 10) * (((\ln(Capacity+2)) - 2.20964) * 0.46657) + (Latency - 2) * \\
 & (((\ln(Capacity+2)) - 2.20964) * -0.21119) + (Accuracy - 75) * (((\ln(Capacity+2)) - \\
 & 2.20964) * 0.012687)
 \end{aligned}$$



Figure A.2 examines three selected simulation runs from the set created from the simulation experiments. Three outcomes are represented. One is poor (LR  $\sim$ 9) and the others are better (LR  $>$  12). The poor outcome happens to be one where the capacity was severely limited (3). The better outcomes had no such limitation. We infer that the agent's needs for messaging exceed a hard limit of 3, so that the poor case was a result of poor communication capacity.

**Figure A.2**  
Simulation Run Results That Explain the Role of Capacity

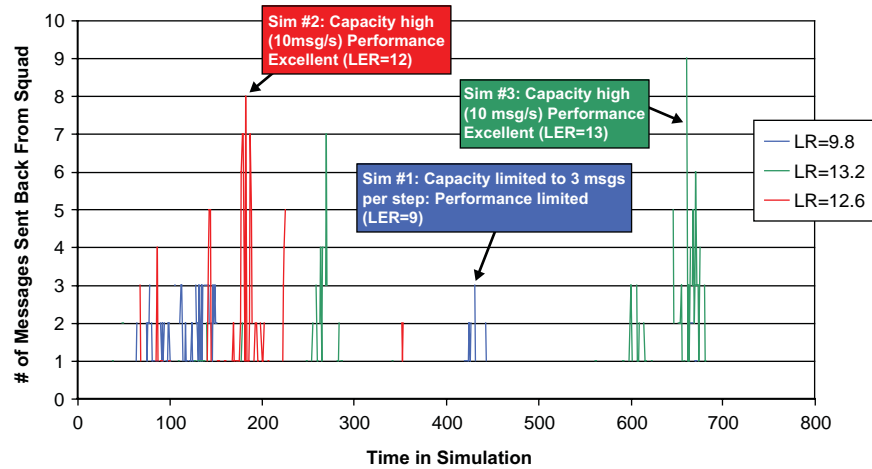

## Second Set of Experiments: Dynamic Communication Model

Figure A.3 is a plot of the actual data versus model-predicted data. Note that in Figure A.3 and similar figures, the diagonal lines represent best fit and confidence intervals.

**Figure A.3**  
Fit Achieved for Modeling Second Set of Results

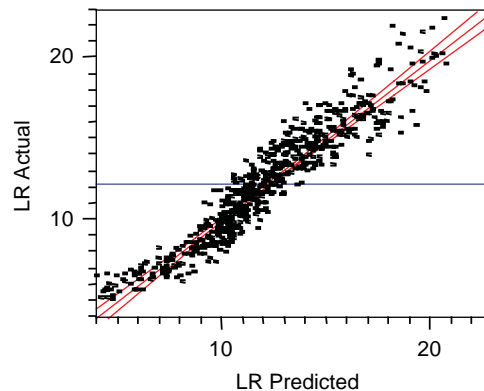

The equation for the model resulting from analysis of the second set of simulation runs, as well an assessment of the relative contribution of each term is as follows.

$$\begin{aligned} LR = & -72.62 - 0.4839 * Capacity - 2.0485 * Latency - 0.00667 * (Capacity - 56.3158) * (Latency - \\ & 0.94737) + 0.0369 * Accuracy - 0.00412 * (Latency - 0.94737) * (Accuracy - 75) + \\ & 0.000699 * TargetRate - 0.00513 * (Latency - 0.94737) * (TargetRate - 125) + \\ & 0.0672 * (Sensing) - 0.000842 * (Capacity - 56.3158) * (Sensing - 62.5) - 0.0241 * (Latency - \\ & 0.94737) * (Sensing - 62.5) + 0.000358 * (Accuracy - 75) * (Sensing - 62.5) + \\ & 0.000104 * (TargetRate - 125) * (Sensing - 62.5) + 26.802 * \ln(Capacity) + 0.197 * (Capacity - \\ & 56.3158) * (\ln(Capacity) - 3.87424) + 1.55 * (Latency - 0.94737) * (\ln(Capacity) - 3.87424) \\ & - 0.0189 * (Accuracy - 75) * (\ln(Capacity) - 3.87424) + 0.0751 * (Sensing - 62.5) \\ & * (\ln(Capacity) - 3.87424) \end{aligned}$$

### Third Set of Experiments: Expanded Three-Squad Scenario

Figure A.4 is a plot of the actual versus predicted for the meta-model synthesized for experiment 3.

**Figure A.4**  
Fit Achieved for Modeling Third Set of Results (Two Squads)

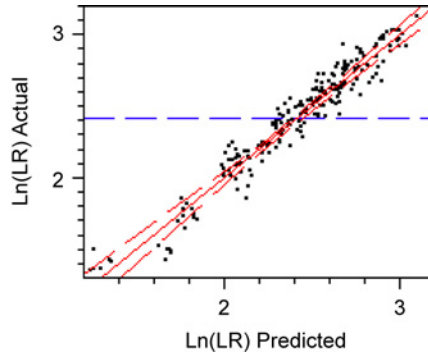

$$\begin{aligned} LR = & -1.296511531 + 0.023468764 * CapacitySqd1 + 0.027399798 * CapacitySqd2 - 0.0002843 \\ & * (CapacitySqd1 - 43.3333) * (CapacitySqd2 - 43.3333) - 0.990199934 * Latency + \\ & 0.006961224 * (CapacitySqd1 - 43.3333) * (Latency - 2) + 0.005752684 * (CapacitySqd2 - \\ & 43.3333) * (Latency - 2) + 0.042456186 * Accuracy - 0.00021383 * (CapacitySqd1 - \\ & 43.3333) * (Accuracy - 75) - 9.84688E-05 * (CapacitySqd2 - 43.3333) * (Accuracy - 75) - \\ & 0.003749573 * (Latency - 2) * (Accuracy - 75) + 0.002041734 * Targeting - 1.68459E-05 * \\ & (CapacitySqd1 - 43.3333) * (Targeting - 133.333) - 8.33756E-06 * (CapacitySqd2 - \\ & 43.3333) * (Targeting - 133.333) - 0.002092867 * (Latency - 2) * (Targeting - 133.333) + \\ & 1.12169E-05 * (Accuracy - 75) * (Targeting - 133.333) + 0.116404973 * Sensing + \\ & 0.000394817 * (CapacitySqd1 - 43.3333) * (Sensing - 53.3333) + 0.000491893 * \\ & (CapacitySqd2 - 43.3333) * (Sensing - 53.3333) - 0.019494371 * (Latency - 2) * (Sensing - \\ & 53.3333) + 0.000738129 * (Accuracy - 75) * (Sensing - 53.3333) + 4.31927E-05 * \\ & (Targeting - 133.333) * (Sensing - 53.3333) \end{aligned}$$

## Fourth Set of Experiments: "Mosque-UAV" Scenario

### The Mosque Direct-Fire Only Scenario: Model of the Loss Exchange Ratio

Figure A.5  
Actual Versus Predicted for Model of Ln(LR) for Variant 1

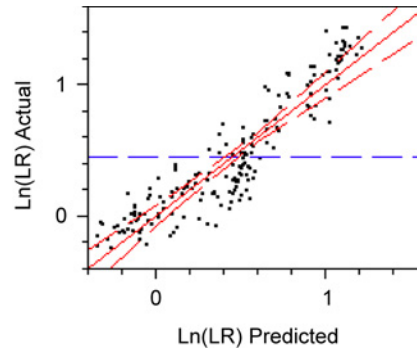

$$\begin{aligned}
 \text{Ln(LR)} = & 0.9327943 + (\text{RangerSensing} * 0.023402) + (\text{UAVSensing} * 0.0022061) + \\
 & ((\text{RangerSensing} - 30) * (\text{UAVSensing} - 100) * 0.0000042) + (\text{Accuracy} * 0.0014909) + \\
 & ((\text{RangerSensing} - 30) * (\text{Accuracy} - 75) * -0.000254) + ((\text{UAVSensing} - 100) * \\
 & (\text{Accuracy} - 75) * -0.000048) + (\text{Latency} * 0.0186922) + ((\text{RangerSensing} - 30) * \\
 & (\text{Latency} - 2) * 0.000565) + ((\text{UAVSensing} - 100) * (\text{Latency} - 2) * -0.000377) + \\
 & ((\text{Accuracy} - 75) * (\text{Latency} - 2) * 0.000305) + (\ln(\text{capacity}) * -0.042042) + \\
 & ((\text{RangerSensing} - 30) * (\ln(\text{capacity}) - 3.5326) * 0.003116) + ((\text{UAVSensing} - 100) * \\
 & (\ln(\text{capacity}) - 3.5326) * 0.0001381) + ((\text{Accuracy} - 75) * (\ln(\text{capacity}) - 3.5326) * \\
 & 0.0005501) + ((\text{Latency} - 2) * (\ln(\text{capacity}) - 3.5326) * 0.001937)
 \end{aligned}$$

### The Mosque Indirect-Fire Scenario: Model of the Loss Exchange Ratio

**Figure A.6**  
Actual Versus Predicted for Model of Ln(LR) for Enhanced Blue

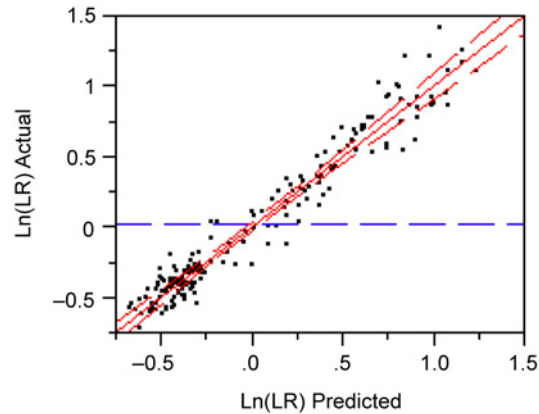

$$\begin{aligned} \text{Ln(LR)} &= -1.444054 + (\text{RangerSensing} * 0.005818) + (\text{UAVSensing} * 0.0007559) + \\ & ((\text{RangerSensing} - 30) * (\text{UAVSensing} - 100) * 4.5684e-9) + (\text{Accuracy} * \\ & 0.0174631) + ((\text{RangerSensing} - 30) * (\text{Accuracy} - 75) * -0.000112) + ((\text{UAVSensing} - \\ & 100) * (\text{Accuracy} - 75) * -0.000024) + (\text{Latency} * -0.053379) + ((\text{RangerSensing} - 30) \\ & * (\text{Latency} - 2) * -0.000031) + ((\text{UAVSensing} - 100) * (\text{Latency} - 2) * -0.000466) + \\ & ((\text{Accuracy} - 75) * (\text{Latency} - 2) * -0.002877) + (\text{Ln(Capacity)} * 0.1021319) + \\ & ((\text{RangerSensing} - 30) * (\text{Ln(Capacity)} - 3.5326) * 0.0003117) + ((\text{UAVSensing} - 100) \\ & * (\text{Ln(Capacity)} - 3.5326) * 0.0006046) + ((\text{Accuracy} - 75) * (\text{Ln(Capacity)} - 3.5326) * \\ & 0.0056856) + ((\text{Latency} - 2) * (\text{Ln(Capacity)} - 3.5326) * -0.011042) \end{aligned}$$

Note: the factor “IFRange” is not in the equation because it proved to be relatively insignificant.

### The Mosque Non-Indirect Scenario Fire Model of the Probability of Mission Success

$$\begin{aligned} \text{Logit(Probability of successful mission)} &= \\ & (-4.14229) + 0.0035755 * \text{UAVSensing} + 0.0296077 * \text{Accuracy} + ((\text{UAVSensing} - 100) * \\ & (\text{Accuracy} - 75) * -0.000023) + -0.017885 * \text{Latency} + ((\text{UAVSensing} - 100) * (\text{Latency} - 2) \\ & * -0.000807) + ((\text{Accuracy} - 75) * (\text{Latency} - 2) * -0.004596) + 0.1310321 * (\text{Ln(Capacity)}) \\ & + ((\text{UAVSensing} - 100) * ((\text{Ln(Capacity)}) - 3.5326) * 0.0014441) + ((\text{Accuracy} - 75) * \\ & ((\text{Ln(Capacity)}) - 3.5326) * 0.0096185) + ((\text{Latency} - 2) * ((\text{Ln(Capacity)}) - 3.5326) * \\ & 0.0423696) \end{aligned}$$

**The Mosque Indirect Scenario Fire Model of the Probability of Mission Success**

Logit(Probability of successful mission) =

$$\begin{aligned}
 & (-6.131673) - 0.007759 * \text{RangerSensing\_IF} + 0.0008443 * \text{UAVSensing\_IF} + \\
 & ((\text{RangerSensing\_IF} - 29.8857) * (\text{UAVSensing\_IF} - 99.4286) * 0.000078) + 0.0458734 * \\
 & \text{Accuracy\_IF} + ((\text{RangerSensing\_IF} - 29.8857) * (\text{Accuracy\_IF} - 75.1429) * -0.000658) + \\
 & ((\text{UAVSensing\_IF} - 99.4286) * (\text{Accuracy\_IF} - 75.1429) * -0.000135) + -0.269426 * \\
 & \text{Latency\_IF} + ((\text{RangerSensing\_IF} - 29.8857) * (\text{Latency\_IF} - 1.94286) * 0.0005658) + \\
 & ((\text{UAVSensing\_IF} - 99.4286) * (\text{Latency\_IF} - 1.94286) * -0.001092) + ((\text{Accuracy\_IF} - \\
 & 75.1429) * (\text{Latency\_IF} - 1.94286) * -0.007171) + 0.7642031 * \text{LN}(\text{Capacity\_IF}) + \\
 & ((\text{RangerSensing\_IF} - 29.8857) * (\text{LN}(\text{Capacity\_IF}) - 3.58755) * 0.0014354) + \\
 & ((\text{UAVSensing\_IF} - 99.4286) * (\text{LN}(\text{Capacity\_IF}) - 3.58755) * 0.0056196) + ((\text{Accuracy\_IF} \\
 & - 75.1429) * (\text{LN}(\text{Capacity\_IF}) - 3.58755) * 0.0200284) + ((\text{Latency\_IF} - 1.94286) * \\
 & (\text{LN}(\text{Capacity\_IF}) - 3.58755) * 0.1741425)
 \end{aligned}$$

## Past Work on Communication Models Leveraged in This Report

---

In the body of the report, a second-order polynomial was used to represent message reliability (or message completion rate, which is similar to packet delivery ratio). The use of a second-order polynomial was based on results from earlier work by Porche, Jamison, and Herbert (2004). A brief review of that work follows.

A number of simulation experiments were performed to generally assess communication network capabilities. From this data, a model was fit. Specifically, a factorial design (Law and Kelton, 1991) was employed for the factors described earlier (transmission frequency, number of UAVs, etc.) and shown in Figure B.1.

**Figure B.1**  
**Factors and Responses**

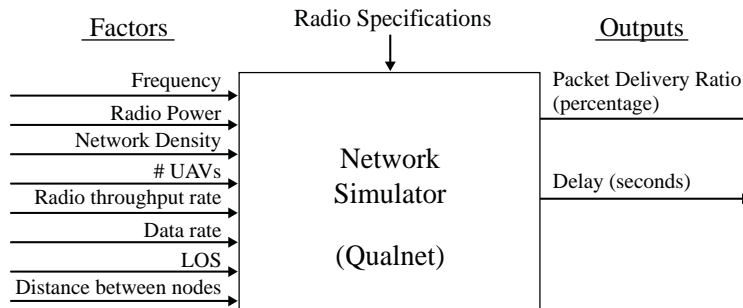

A number of simulation experiments were run. Details are shown in Table B.1. The table shown is not the actual experiment designed but is included to indicate how the factors were varied; the last two columns represent the responses sought, which are PDR (packet delivery ratio or message completion rate) and end-to-end delay. The simulations involved specific areas of interest.

**Table B.1**  
**Example Design of Experiments**

#	Frequency	# UAVs	Density	Radio Power	Radio Throughput	Data Rate	PDR	Delay
1	2 GHz	0	145	2 W	2Mbps	16Kbps	result	result
2	1 GHz	4	72	20 W	2Mbps	32Kbps	result	result
3	0.4 GHz	8	36	1600 W	2Mbps	64Kbps	result	result
4	0.2 GHz	0	145	2 W	6 Mbps	160Kbps	result	result
5	2.5 GHz	4	72	20 W	6 Mbps	320Kbps	result	result
6	0.1 GHz	8	36	1600 W	6 Mbps	533Kbps	result	result

Specifically, it was an area with randomly scattered nodes spread across a 25km by 25km piece of terrain in the Macedonia-Serbia region. Data traffic was varied. Network performance was observed as function of frequency, mobility, UAV usage, etc. The terrain is fairly flat.

All of the experiments were 20-minute Qualnet simulations. These experiments focused on data rates. A predictive model of the packet delivery ratio can be developed from data from simulation runs, as shown in Figure B.2. The logit function is convenient because it produces a value between 0 and 1. It is defined as follows:

$$\text{logit}(p) = \log\left(\frac{p}{1-p}\right).$$

Once a model for the logit(PDR) is determined, the actual PDR (labeled  $p$ ) may be calculated as follows:

$$p = \frac{\exp(\text{logit}(p))}{(\exp(\text{logit}(p)) + 1)}.$$

**Figure B.2**  
**Generic Form of Meta-Model**

$$\text{Logit (PDR)} = \beta_0 +$$

$$\beta_1(\text{Frequency}) + \beta_2(\text{UAVs}) + \dots \left\{ \begin{array}{l} \text{Other} \\ \text{First-Order} \\ \text{Terms} \end{array} \right.$$

$$\beta_3(\text{Frequency} \times \text{UAVs}) + \dots \left\{ \begin{array}{l} \text{Other} \\ \text{Second-Order} \\ \text{Terms} \end{array} \right.$$

Other Higher Order Interactions

**Figure B.3**  
**Polynomial Fit Obtained Based on Meta-Model Data**

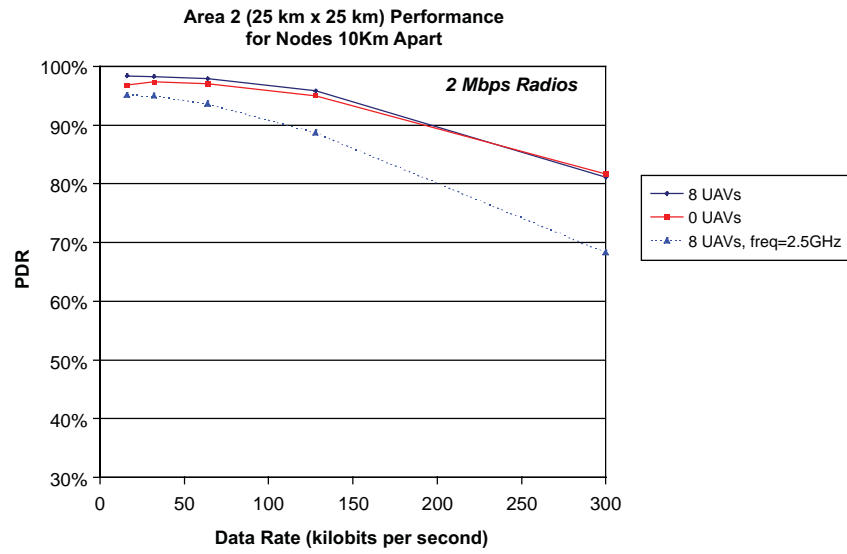





## Bibliography

---

- Alberts, David S., John J. Garstka, and Frederick P. Stein, *Network Centric Warfare: Developing and Leveraging Information Superiority*, 2nd ed. (rev.), CCRP Publication Series, 1999.
- Arquilla, John, and David Ronfeldt, *Swarming and the Future of Conflict*, Santa Monica, CA: RAND Corporation, DB-311-OSD, 2000.
- Baker, Matthew, "Human Factors in Network Centric Warfare," Naval War College, May 2002.
- Brandstein, Alfred, Henrik Friman, and Gary E. Horne, "Advancing the State of the Art in Command and Control," *Signal Magazine*, May 2001, <http://www.afcea.org/signal/articles/anmviewer.asp?a=551&z=7>.
- Cebrowski, Arthur K., and John J. Garstka, "Network-centric Warfare: Its Origin and Future," *Naval Institute Proceedings*, January 1998.
- Cianciolo, Mark, "Network Centric Warfare: A Bridge Too Far," Naval War College, December, 2003.
- Dekker, Anthony, "Simulating Network Robustness: Two Perspectives on Reality," 2002.
- Downes, Patrick, Michael Kwinn, and Donald Brown, "Using Agent-Based Modeling and Human-In-The-Loop Simulation to Analyze Army Acquisition Programs," in R.G. Ingalls, M.D. Rossetti, J.S. Smith, and B.A. Peters (eds.), *Proceedings of the 2004 Winter Simulation Conference*, New York: Institute of Electrical and Electronics Engineers, Inc., 2004.
- Fisher, R., "Transformational Communication: A Critical Warfare Enabler," *Spacecom*, February 2003.
- Galligan, David P., Mark A. Anderson, and Michael K. Lauren, "Map Aware Non-Uniform Automata," Users Manual, MANA, Version 3.0, Defence Technology Agency, New Zealand, 2004.
- Gartka, J., "Network Centric Warfare: An Overview of Emerging Theory," *PHALANX*, December 2000.
- Giffin, R. E., and D. J. Reid, "A Woven Web of Guesses, Canto One: Network Centric Warfare and the Myth of the New Economy," *8th International Command and Control Research Symposium*, Washington, D.C., C4ISR Cooperative, Research Program (CCRP), 2003.
- Gilder, George, "Metcalf's Law and Legacy," *Forbes ASAP*, September 13, 1993.
- Gill, A., "Improvement to the Movement Algorithm in the MANA Agent Based Distillation," *J. Battlefield Tech.*, Vol. 7, No. 2, 2004, pp. 19–22.
- Gill, A., and D. Grieger, "Validation of Agent Based Distillation Movement Algorithms," DSTO-TN-0476, (Defence Science and Technology Organisation, Systems Sciences Laboratory, Edinburgh, Australia), 2003.
- Government Accountability Office (GAO), *Recent Campaigns Benefited from Improved Communications and Technology, but Barriers to Continued Progress Remain*, GAO-04-547, June 2004.

- Gumbert, Jack, Ted Cranford, Thomas B. Lyles, and David S. Redding, "DARPA's Future Combat System Command and Control," *Military Review*, May–June, 2003.
- Gupta, P., and P. Kumar, "The Capacity of Wireless Networks," *IEEE Transactions on Information Theory*, Vol. 46, No. 2, March 2000, available at [http://www-ece.rice.edu/~amlexa/sensornets/gupta\\_kumar00.pdf](http://www-ece.rice.edu/~amlexa/sensornets/gupta_kumar00.pdf).
- Gupta, P., R. Gray, and P. Kumar, "An Experimental Scaling Law for Adhoc Networks," technical report, University of Illinois at Urbana, May, 2001, available at [citeseer.nj.nec.com/gupta01experimental.html](http://citeseer.nj.nec.com/gupta01experimental.html).
- Horne, Gary, "Data Farming: A Meta-technique for Research on 21st Century Questions," briefing presented at the Naval War College, Newport, Rhode Island, 13 November 1997.
- Illachinski, A., *Cellular Automata: A Discrete Universe*. World Scientific Publishing Co. Pte. Ltd., 2001.
- Ipekci, Arif Ilker, and Thomas Lucas, "How Agent-Based Models Can Be Utilized to Explore and Exploit Non-Linearity and Intangibles in Guerilla Warfare," Naval Postgraduate School, 2002.
- Kamradt, Hank, "Information Sufficiency and the Operational Commander: A Cautionary Tale," Thesis, Naval War College, May 16, 2003.
- Lauren, M. K., and R. T. Stephen, "Modeling Patrol Survivability in a Generic Peacekeeping Setting Using ISAAC," DOTSE Report 177, NR 1358, (Defence Operational Technology Support Establishment, Auckland, New Zealand), 2000.
- Lauren, M., R. Stephen, and N. Hore, "Application of the MANA Model to Operations in East Timor," New Zealand Defence Technology Agency Report 194, August 2003.
- Law, A., and W. Kelton, *Simulation Modeling and Analysis*, 2nd ed., McGraw-Hill, 1991.
- Liu, Jiming, *Autonomous Agents and Multi-Agent Systems*, World Scientific, 2001.
- Lucas, Thomas, "The Stochastic Versus Deterministic Argument for Combat Simulations: Tales of When The Average Won't Do," *Military Operations Research*, Vol. 5, No. 3, 2000.
- Lucas, Tom, Susan Sanchez, and Tom Cioppa, "Increasing the Harvest from Data Farming," presentation to the RAND Corporation, Santa Monica, California, February 2004.
- Mazzanti, Edwin, "Army Transformation: TRADOC Perspective," NDIA Conference, Parsippany, New Jersey, 19 June 2001, available at <http://www.dtic.mil/ndia/2001armaments/mazzanti.pdf>.
- McEver, Jimmie, personal communication, 2004.
- Phillips, Donovan, "Using a Low Resolution Entity Level Modeling Approach," presentation, <https://aorsxliii.com/presentations/Session%203/Phillips%20-%20low%20resolution%20modeling.pdf>, Army Operations Research Symposium, Ft. Lee, Virginia, 2004.
- Porche, Isaac, Lewis Jamison, and Tom Herbert, "Framework for Measuring the Impact of C4ISR Technologies and Concepts on Warfighter Effectiveness Using High Resolution Simulation," 2004 CCRTS, available at [http://www.dodccrp.org/events/2004/CCRTS\\_San\\_Diego/CD/papers/233.pdf](http://www.dodccrp.org/events/2004/CCRTS_San_Diego/CD/papers/233.pdf).
- Project Albert. [www.projectalbert.org](http://www.projectalbert.org). 2005.
- Reed, David, "The Law of the Pack," *Harvard Business Review*, February 2000.
- Russell, R. A., J. R. Russell, and K. K. Benke, "Subjective Factors in Combat Simulation: Correlation Between Fear and The Perception of Threat," technical report, DSTO, Australia, 1996.

U.S. Army Training and Doctrine Command (TRADOC), "Military Operations: Concept for Operation," TRADOC Pamphlet 525-69, 1 August 1995, available at <http://www.tradoc.army.mil/tpubs/pams/p525-69.htm>.