

June 1992
NSRP 0347

NATIONAL SHIPBUILDING RESEARCH PROGRAM

Implementation Guide for Approaching Shop Floor Control

U.S. DEPARTMENT OF TRANSPORTATION
Maritime Administration and the U.S. Navy

in cooperation with
National Steel and Shipbuilding Company
San Diego, California

Report Documentation Page

Form Approved
OMB No. 0704-0188

Public reporting burden for the collection of information is estimated to average 1 hour per response, including the time for reviewing instructions, searching existing data sources, gathering and maintaining the data needed, and completing and reviewing the collection of information. Send comments regarding this burden estimate or any other aspect of this collection of information, including suggestions for reducing this burden, to Washington Headquarters Services, Directorate for Information Operations and Reports, 1215 Jefferson Davis Highway, Suite 1204, Arlington VA 22202-4302. Respondents should be aware that notwithstanding any other provision of law, no person shall be subject to a penalty for failing to comply with a collection of information if it does not display a currently valid OMB control number.

1. REPORT DATE JUN 1992		2. REPORT TYPE N/A		3. DATES COVERED -	
4. TITLE AND SUBTITLE Implementation Guide for Approaching Ship Floor Control				5a. CONTRACT NUMBER	
				5b. GRANT NUMBER	
				5c. PROGRAM ELEMENT NUMBER	
6. AUTHOR(S)				5d. PROJECT NUMBER	
				5e. TASK NUMBER	
				5f. WORK UNIT NUMBER	
7. PERFORMING ORGANIZATION NAME(S) AND ADDRESS(ES) Naval Surface Warfare Center CD Code 2230-Design Integration Tools Bldg 192, Room 128 9500 MacArthur Blvd, Bethesda, MD 20817-5700				8. PERFORMING ORGANIZATION REPORT NUMBER	
9. SPONSORING/MONITORING AGENCY NAME(S) AND ADDRESS(ES)				10. SPONSOR/MONITOR'S ACRONYM(S)	
				11. SPONSOR/MONITOR'S REPORT NUMBER(S)	
12. DISTRIBUTION/AVAILABILITY STATEMENT Approved for public release, distribution unlimited					
13. SUPPLEMENTARY NOTES					
14. ABSTRACT					
15. SUBJECT TERMS					
16. SECURITY CLASSIFICATION OF:			17. LIMITATION OF ABSTRACT SAR	18. NUMBER OF PAGES 347	19a. NAME OF RESPONSIBLE PERSON
a. REPORT unclassified	b. ABSTRACT unclassified	c. THIS PAGE unclassified			

DISCLAIMER

These reports were prepared as an account of government-sponsored work. Neither the United States, nor the Maritime Administration, nor any person acting on behalf of the Maritime Administration, (A) makes any warranty or representation, expressed or implied, with respect to the accuracy, completeness or usefulness of the information contained in this report manual, or that the use of any information, apparatus, method, or process disclosed in this report may not infringe privately owned rights; or (B) assumes any liabilities with respect to the use of or for damages resulting from the use of any information, apparatus, method, or process disclosed in the report. As used in the above, "Persons acting on behalf of the Maritime Administration" includes any employee, contractor, or subcontractor to the contractor of the Maritime Administration to the extent that such employee, contractor, or subcontractor to the contractor prepares, handles, or distributes, or provides access to any information pursuant to his employment or contract or subcontract to the contractor with the Maritime Administration. ANY POSSIBLE IMPLIED WARRANTIES OF MERCHANTABILITY AND/OR FITNESS FOR PURPOSE ARE SPECIFICALLY DISCLAIMED.

**IMPLEMENTATION GUIDE FOR APPROACHING
SHOP FLOOR CONTROL**

Final Project Report

SP-8 INDUSTRIAL ENGINEERING PANEL

National Shipbuilding Research Program

PETERSON BUILDERS, INC.
101 Pennsylvania St.
P. O. Box 650
Sturgeon Bay, WI 54235
414-743-5577
Darrold Folz Ext X202
Karen Diedrick X284
FAX 414-743-3461

PROJECT ACKNOWLEDGEMENTS

This project was a result of the cooperative efforts of the shipbuilders that are associated with the National Shipbuilding Research Program's Industrial Engineering Panel. The project was completed by the Industrial Engineering Department at Peterson Builders, Inc. in Sturgeon Bay, Wisconsin. PBI staff that provided Project Management and Investigation included Mr. C. G. Higgins, Mr. J. G. Jessup, and Ms. K. K. Diedrick. The Peterson Builders, Inc. staff would also like to thank the following shipyards that assisted in technology exchange through discussion and/or site visits during the course of this project: Bath Iron Works, Corp. National Steel and Shipbuilding Co., Norfolk Naval Shipyard, and Jonathan Corp.

TABLE OF CONTENTS

Introduction	1
Project and Report Overview.....	1
The Corporate Tasking for Change.....	2
Shop Floor Control	4
Definition for Shipbuilding	4
Fundamental Parts of a Shop Floor Control System	11
Integration Issue.....	13
Implementation Guide for Integrated SFC	15
Enterprise Modeling	15
IDEF - An Overview of the Methodology	18
Fundamentals of IDEF	18
IDEF Application Example.....	24
Pipe Shop Case Study	24
Discussion of Case Study	30
Further Analysis of the Model	33
Recommendations and Conclusions	38
Appendix A: References and Resources	41
Appendix B: Case Study Application Example; Pipe Shop IDEF Model	45

I. INTRODUCTION

A. Project and Report Overview

The objective of this project was to develop a detailed implementation guide documenting an approach to integrated Shop Floor Control (SFC) for shipyards. The impetus for the project was SP-8's¹ recognition that the basic elements of SFC exist in all shipyards, however, most have not effectively integrated all these elements into a well structured production monitoring and control system.

The Panel further recognized that since the shipbuilding job shop environment revolves around the assembly of a single product, it is difficult to bring in "off the shelf" production control software which will speak to shipbuilding's unique needs.

This project report provides the guidelines for identifying the information requirements necessary to monitor and control production activity in a shipyard. The report documents a structured approach, provides a case study example utilizing that approach, and includes final conclusions of the project. The report is organized in the following manner.

The remainder of the Introduction describes the continuous improvement environment operating at Peterson Builders, Inc. (PBI) during the project period. Section II, defines shop floor control for the ship construction process. Data requirements for a generic system are identified.

Section III provides the Implementation Guide for approaching SFC using the structured analysis design technique of IDEF. The need for considering the entire enterprise is discussed along with the mechanics of using the IDEF approach within the shipyard.

Section IV provides an overview of a case study example. The "As-Is" model of a pipe shop is discussed and analyzed.

¹sp-s is the ship production committee Panel #8. Industrial Engineering, of the Society of Naval Architects and Marine Engineers. It is one of eight Panels that comprise the National Shipbuilding Research Program.

Finally, Section V makes recommendations and conclusions with regard to lessons learned during the project and further research that the NSRP should pursue. The report is supported by Appendices that provide references and a case study model.

B. The Corporate Tasking for Change

Peterson Builders Inc., is a medium sized shipyard that has been established for over 59 years. Recognizing the pressures that have demanded a more competitive manufacturing capability, PBI's shipyard management has been working steadily with aggressive programs for change. These programs have included implementation of the Deming² management philosophy, formalized strategic and operational planning, and the development of Integrated Business Systems to name a few.

The discussions at PBI regarding what needed to be done to support this NSRP project, firmed management's desire to fully understand all of the activities that are required to execute the ship construction process. A company wide initiative for the development of an Integrated Business System (IBS) coincided with this Shop Floor Control project in the spring of 1989. As of the writing of this report (Winter 1991), the IBS effort is installing a new organization of work, familiar to many as Product Work Breakdown Structure (PWBS), and a new integrated business software package.

It will be admitted by many, both inside the management group that made up the IBS Advisory Council and the Executive management directing the resources, that it has not been an easy road to this point. It is also recognized that the road ahead is going to be no less strenuous.

From the standpoint of the reader preparing to embark on system-wide overhaul it is important to understand that the climate for change that now operates at PBI was fundamental to using the tools described in this report. The open environment and willingness by top management to commit resources and if necessary, change everything, is fundamental to realizing the full benefits of the approach espoused in this report. The methodology is

²Many publications document the Deming Philosophy. The training course utilized by PBI for training in the Deming methods since 1988 is the *Transformation of American Industry* QIP, 1986.

rigorous, requires hard dedicated work, and bares all the blemishes of the system.

II. SHOP FLOOR CONTROL

A. Definition for Shipbuilding

Shop floor control, also known as **production activity control**, can mean many things to many people. One definition of shop floor control is:

that group of activities directly responsible for managing the transformation of planned orders into a set of outputs. It governs the very short-term detailed planning, execution, and monitoring activities needed to control the flow of an order from the moment the order is released by the planning system for execution until the order is filled and its disposition completed. The shop floor control system is responsible for making the detailed and final allocation of labor, machine capacity, tooling, and materials to the various competing orders. It collects data on the activities taking place on the shop floor involving the progress of various orders and the status of resources and makes this information available to the planning system. Finally, the shop floor control system is responsible for ensuring that the shop orders released to the shop floor by the planning system are completed in a timely and cost effective manner.³

In simpler terms, shop floor control is the system which plans, executes, monitors, and controls production. It provides production with the information, materials, and resources required, when required, to assure that the products are manufactured according to plan. Every shipyard and manufacturing company has a shop floor control system. It may be formal or informal, in or out of control, manual or automated.

Each shop floor control system includes some basic activities: order release, detailed assignment, data collection and monitoring, control and feedback, and order disposition. These activities and their relationships are outlined in Figure 1.⁴ As shown the shop floor control system relies heavily on formal planning efforts. Despite this, there is still some detailed planning which takes place on the shop floor. Priorities and resource assignments are

³Shop Floor Control, Melnyk, Steven A., Carter, Phillip L., Dilts, David M., Lyth, David M., Dow Jones-Irwin, 1985, page 35.

⁴Ibid page 40.

established by the shop supervisors. The diagram does not emphasize the important role of other functions within a company such as engineering, purchasing, materials, warehousing, etc. Those functions also provide valuable inputs to a shop floor control system. All functions within a successful shipyard must be capable of producing timely and accurate information.

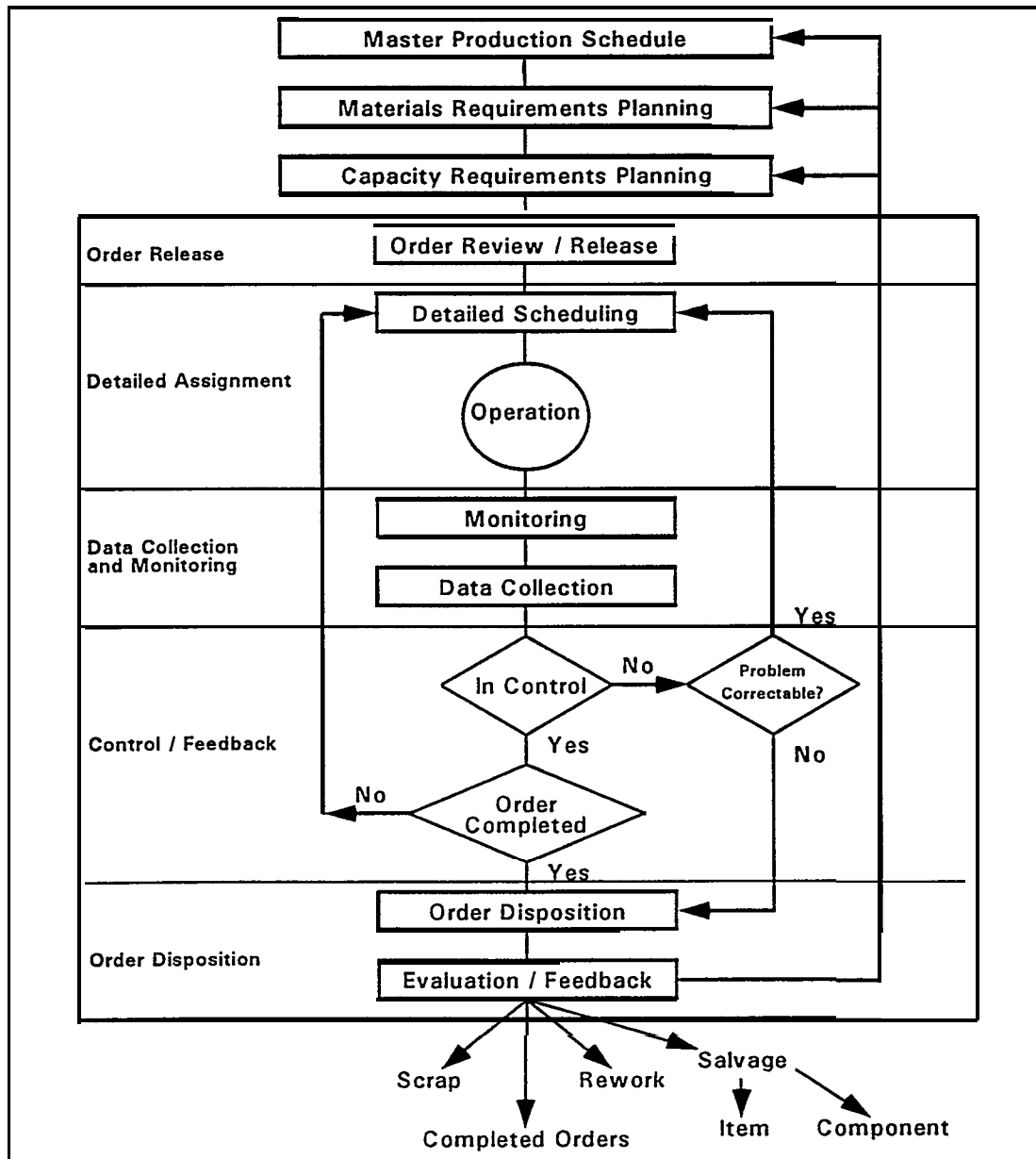

Figure 1- Framework of Shop Floor Control

Many inputs are needed in order to accomplish the activities displayed above, therefore it is essential that some fundamentals be in place in order to have an *effective* shop floor control system. One of the most important items is a formal planning system. A formal planning system establishes what will be produced, how much will be produced, and when it is needed.

The planning system includes several types of planning such as production planning, master scheduling, material planning, and capacity planning. The process of planning, the control aspects of shop floor control, and some of the information elements that are needed to accomplish each step are shown in Figure 2.⁵ This illustrates the dependency of shop floor control on the planning system.

⁵Shop Floor Control: A Detailed Guide to Its Understanding and Implementation, Wassweiler, William, MGI Management Institute, 1984, Page 1-9.

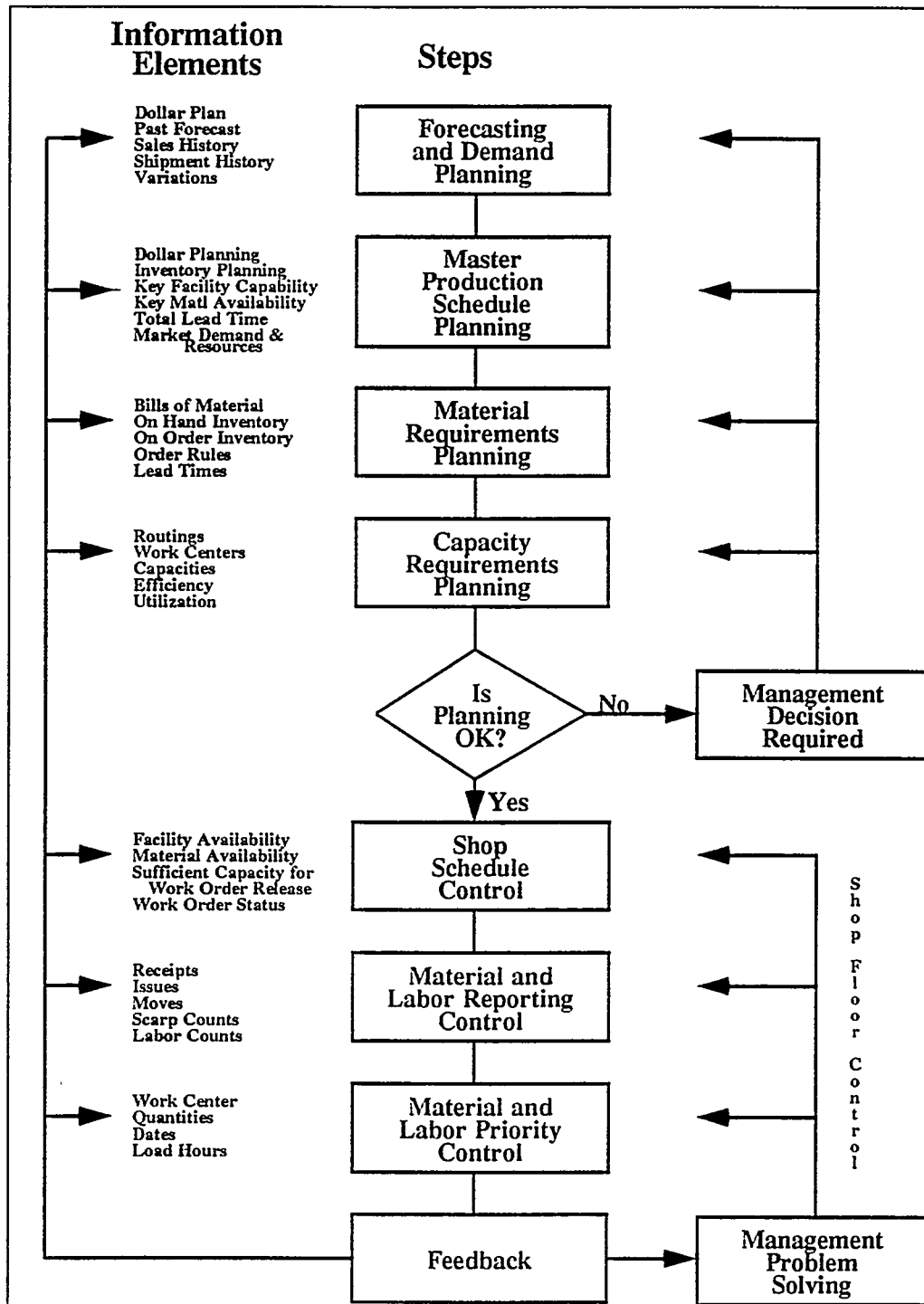

Figure 2 - Key Modules of Shop Floor Control

Production planning provides the overall game plan. It establishes how much of what type of products the company will build. One aspect of production planning which can have a major impact on a shipyard shop floor control system is the organization of work, the work breakdown structure. The

proper work breakdown structure facilitates a more efficient method of planning, manufacturing and controlling work. Many shipyards continue to divide the work by systems. System breakdown is "natural and appropriate for estimating and early design stages. However, system orientation for planning, scheduling, and execution is unnatural and inappropriate because it leads to poor coordination of work and generally results in work packages which are too large for effective control of material, man-hours and schedules. "⁶This implies that in order to have an effective shop floor control system, a shipyard must have the flexibility of looking at work from a system and a product perspective.

Master Scheduling utilizes the information generated in production planning to develop a schedule of major events, the milestone schedule. Key materials and capacities should be examined at this stage to make sure they are sufficient to meet the milestones. The milestone schedule drives the material and work center schedules.

Material Planning includes the activities which determine what material is needed and when. An accurate indented bill of material and inventory information is needed along with lead times, and the milestone schedule. The milestone schedule tells what needs to be done and by when. The bill of material communicates what parts and materials are needed to build the product. The inventory information reveals what is already available. The material planning process takes this information, the lead times, and other information to establish ordering dates and quantities. The material plan ensures that material is available when needed.

Capacity Planning is "the process of determining what quantity of labor and machine resources is required to accomplish the tasks of production. "⁷It utilizes the production plan and milestone schedule along with routing, workcenter capability and other work center information to accomplish this. The determination of capacity should also be based on engineered standards in

⁶Product Work Breakdown Structure, Okayama, Y., U.S. Department of Transportation, December, 1982, page 1.

⁷Production Activity Control, Melnyk, Steven A. and Carter, Philip L., Dow Jones Irwin, 1987, page 160.

order for it to provide a meaningful schedule.⁸ This phase of planning looks at what resources are needed and when they are needed to accomplish scheduled work. Whether or not the capacity exists in the shipyard should be looked at early in the process, when the production plan and master scheduling are being done.

Besides a formal planning system, an effective shop floor control system relies heavily on a database which stores and manipulates data. Shop floor control systems can be manual, but, a normalized computerized database ensures that information is current and consistent for everyone. Changes and updates should be entered into the system promptly and properly to ensure that information is correct and timely. Ideally the database would integrate the functions of planning, shop floor control, and other manufacturing information, and would be part of a larger company database. An integrated system reduces redundant data entry, increases accuracy, and allows everyone feedback from other functional areas.

Databases can take many forms and appear on many different systems. A sample of some of the entities related to planning and shop floor control are listed in Figure 3.¹⁰ Figure 3 also shows what the key field might be for each entity, as well as some of the other characteristics or attributes. The attributes list is by no means complete but is included to give the reader an idea of some of the minimum requirements that each shipyard must develop.

The issue of a single centralized data depository versus separate databases which are linked, is one that each shipyard needs to answer for itself. The primary advantage of a single centralized system is for system management and program standardization. The primary advantage of a decentralized architecture is flexibility.

⁸A Manual on Planning and Production Control for Shipyard Use, National Shipbuilding Research Program, Bath Iron Works Corp. and Corporate-Tech Planning, September 1978

⁹Normalized refers to database design that assures a data element (entity) only occurs once and is accessible whenever it is needed. This eliminates the need for redundant input and or updating of records.

¹⁰A Conceptual Information Model (Data Base Design) for Outfit Planning, Diesslin, Richard L., National Shipbuilding Research Project - Maritime Administration, 1982.

Entities	Key	Attributes
Hull part callout	Hull type id, Part type id	
Pallet part callout	Part id, Pallet id	
Part type	Part id	Description, Lead Time, Lot size quantity, On hand quantity, Allocated quantity, On order quantity
Shop order	Shop order #	Quantity, Quantity completed, Quantity scrapped, Due date, Priority
Active operation	Lot #, SO#, Oper seq #	Set-up hours reported, Run hours, Quantity reported complete, Quantity scrapped
Completed work ticket	SO#, Oper seq #, Employee id	Time
Lot	SO#, Lot #	Quantity
Receiving ticket	Receiving ticket #	Date received, location, Person receiving
Shop order due date	Milestone, Descr., SO#	
Shop order production qty	SO#, qty	
Area	Area id, Stage id, Pallet id	Description
Design zone cross ref.	Det dwg id, System dwg id	
Detailed design drawing	Det dwg id	
Pallet	Pallet id	
Stage	Stage id, Pallet id, SO#	
System zone cross ref.	System id, Zone id, Ship type vrsn id	
Zone	Zone id	
Equipment	Equip id	Equipment type, Location, Quantity
Equipment callout	SO#, Oper seq #, Equip id	
Material	Material id	Material type
Material callout	SO#, Oper seq #, Material id	
Planned operation	SO#, Oper seq #	Operation description, Movement of work, Set-up time, Operation time, Skill level
Special tools	Spec tools id	Tool description, Tool location, # of tools, Cost
Special tools callout	SO#, Oper seq #, Spec tool #	
Visual aid	Vis aid #, Det des dwg #	Operation
Hull	Hull type id, Ship type vrsn id	
System	System id, Ship type vrsn id	Description
System design drawing	System dwg id	
Work center	work center #	Status, Capacity, Description, Efficiency, Alternate wc

Figure 3 - Entities and Attributes

B. Fundamental Parts of a Shop Floor Control System

A formal planning system and a shop floor control database are prerequisites for an effective shop floor control system. Some of the basic parts of a shop floor control system are:

An effective **identification system** for parts and assemblies is essential. It is difficult to track parts and materials that are lacking a unique name or label. This is especially true in a shipyard where many parts are one-of-a-kind items. In this report, that unique name will be referred to as the item number.

The shop floor control system must include a method of **tracking** parts and assemblies as they get processed. This should allow all users to know the status of the parts, their location, and their stage of completion. The location can be particularly useful in a shipyard where buildings and departments can be miles away. Parts should be tracked at the level they are moved or installed.

The **BOM** (bill of material) is another important element of a successful shop floor control system. The BOM consists of item numbers with parent and child relationships. The BOM should be properly structured and indented so that the information is useful to all manufacturing and support functions. The information should be available in a single common database.

The **routing is** a list of operational steps or processes in the production of a part or assembly. Routings not only provide a list of the operations a part must go through, but also when, where, by by whom, and how much time it should take. Routings are needed for capacity planning and to execute capacity and material plans. Routings are captured for each item within the item master.

A **work center** can be either a group of people or equipment, or an individual or machine that is classified as a unit for the sake of capacity planning and standards development. A work center performs similar functions or a sequence of operations. An example would be a group of drill presses with the same capabilities. The drill presses could be classified as a work center and the capacity of the work center would be the combined capacities of each

drill. Aspects of group technology should be applied so that production is best organized to manufacture the product.

The up front definition of work centers is very important to the development of a database that controls work according to how it is to be organized. For shipbuilding, the following definition of a process lane helps to exemplify how work centers could be set up.

. . . . work should be organized to support interim product identification. A sequence of stages is a process lane. A portion of a lane, i.e., a few work stations, contiguous in a process lane or across process lanes can be grouped as a process yard (work center). For example, for producing a curved panel the work stations for collecting resources, fitting, welding, and finishing comprise a process yard organized within a process lane. Grouping the marking and cutting stations for built-up part, internal part, and part for flat panel is an example of a process yard organized across process lanes. Theoretically, each yard is managed by a foreman, and each station is managed by an assistant foreman. Based on a foreman's experience, shipyard size and workload, a foreman may be assigned more than one yard. ¹¹

Manufacturing Orders are production's authorization to do work. Manufacturing orders follow through every phase of shop floor control. Their issuance indicates the start of "shop floor control" and their closing indicates the end of the shop floor control cycle for that order. "All of the activities undertaken by the shop floor control system are directed at ensuring the timely and efficient completion of the work order." ¹²

¹¹Flexible Production Indices, NSRP #238, April 1986, pg 7

¹²shop Floor Control, Melnyk, Steven A., Carter, Phillip A., Dilts, David M., Lyth, David M., American Production and Inventory Control Society, 1985, Page 35-36.

There are many things imperative to an effective shop floor control system. The development of an effective system can be difficult, but the benefits which can be realized are numerous. An effective shop floor control system:

- Controls work in process by regulating the order release rate to any given shop
- Reduces manufacturing lead times by reducing the time an order waits for manpower or machines
- Plans and minimizes queue length
- Allows use of alternate routes
- Balances work flow
- Reduces work-in-process (material/storage)
- Helps identify special tooling and fixtures
- Identifies candidates for capital equipment or process improvement
- Identifies inspection requirements

C. Integration Issue

Shipbuilding consists of many unique and diverse trades doing their part to create a complete and complex product. One of the keys to improving the shipbuilding process is to integrate or coordinate everyone's functions. The shops must be provided with the correct materials, information, and instructions when it is needed.

Shipyards contain a variety of trades such as electrical, paint, hull, piping, sheet metal, fiberglass, wood, machine shops, and welding. Although there are some information needs common to each of these areas, they also have their own special information needs. An example of those special needs could be on a foundation. The fabrication shop needs to know specific information, such as size, material, etc., about each piece which makes up the foundation. The paint shop is only concerned with its color and the installers need only to know its final location onboard. Meeting each of those needs is the responsibility of shipyard shop floor control systems. The shop floor control

system must provide each of these information needs in an understandable format and in a timely manner.

There are many production control software packages available. Due to the complex nature of the shipyard's product and customer-imposed requirements, those packages cannot just be "plugged in". Before production control software is purchased or implemented, a full understanding of the shipyard activities is needed. The next section of this report describes a methodology for gaining this understanding. The activities should be simplified and integrated. After the simplification and integration occurs, automation can take place, if it is appropriate.

Finally in choosing or developing a shop floor control package, the software should be flexible enough to change. For a simple construction process/product, a manual system may be preferable. However, whether it is a manual or fully integrated computerized application, a shipyard should not have to change its methods just for the sake of suiting the system(s). The software should also be flexible enough to meet customer requirements, especially if a shipyard must deal with both military and commercial products. The extensive reporting requirements in military contracts provide unique specifications which must be considered. For a further discussion of some of these requirements, the reader is directed to the 1991 NSRP Symposium Paper *Manufacturing Software for Shipyards*.¹³

¹³Manufacturing software for Shipyards, C. Ziegelrnan, NSRP Symposium proceedings, Sept., 1991.

III. IMPLEMENTATION GUIDE FOR INTEGRATED SFC

A. Enterprise Modeling

Based on the definition of SFC in the previous section, it is quickly realized that it is not possible to consider approaching SFC without addressing all aspects of the organization. The primary prerequisite for effective shop floor control is that there be a formal planning system and manufacturing database to support it. It is not enough, therefore, to try to gain an understanding of only the shop floor view of controlling production activity. What is required, is a total understanding of the entire enterprise so that all the hooks can be established into the various systems, formal and informal, that will support the production activity. The understanding of the enterprise equates to knowing all of the **activities**, their associated inputs and **outputs**, the **controls** that govern effective operation, and the **resources** that are needed to carry them out.

A total understanding of the entire enterprise sounds very daunting, however, a number of structured analysis approaches exist which allow just that type of understanding to be achieved. Some of these approaches are called out in Table 1.

Wariner-Orr	This technique derives the ideal structure from the content of the outputs and inputs.
IDEF	This technique is process/activity oriented and identifies inputs, outputs, controls and mechanisms. An extension of this activity model supports data modeling.
Jackson	Derives the ideal structure from inputs and outputs.
Yourdon-Constantine	This technique derives the ideal structure from the flow of data through the necessary program functions.

Table 1- System Design and Analysis Table

The approach identified as the most applicable to the purpose of this project was the IDEF methodology. It was chosen because it was found to be very mature, able to address both manual and automated systems together, and is a

standard recognized internationally. One of its strongest points is its ability to tackle the entire enterprise with a very singular purpose.

The following fundamental concepts and benefits summarize why IDEF was chosen.¹⁴

1. Problem Analysis is: Top Down, Modular, Hierarchical, and Structured.
IDEF Supports Bottom-up Engineering of Solutions.
2. IDEF Functional Activity Model is Independent of Organization and Time.
3. IDEF shows interrelationships between component parts of the system. The function is not looked at alone.
4. IDEF supports coordinated team work.
5. IDEF is structured and rigorous and enforces discipline on complex system analysis.
6. IDEF provides a means of communicating and representing results.
7. IDEF identifies and categorizes information entities which form the foundation for data modeling.
8. IDEF reveals data flow relationships and incongruities. It may reveal that the people that need the information are not getting it and others that are getting it may not need it.
9. IDEF reveals redundant functions.

The key to enterprise modeling is to: (1) gather all the information about the system in a timely manner, and (2) effectively work with the model without being overloaded with information. IDEF has an ability to address these two aspects. It is based on the principal of hierarchical decomposition of the subject which uncovers increasing level of detail.

It is through this decomposition process that the subject of Shop Floor Control must be approached in order to properly interface with the rest of the enterprise. As depicted in Figure 4, the structured system analysis provides the opportunity to deal with the complexity of SFC by getting agreement on

¹⁴"IDEF Source -IDEF for Enterprise Modeling", Course 3, Volume 1, Wizdom Systems. Inc. 1989.

the problem, gaining an understanding of how the system operates now and how it should operate in the future, and finally supporting the preparation of a plan of execution.

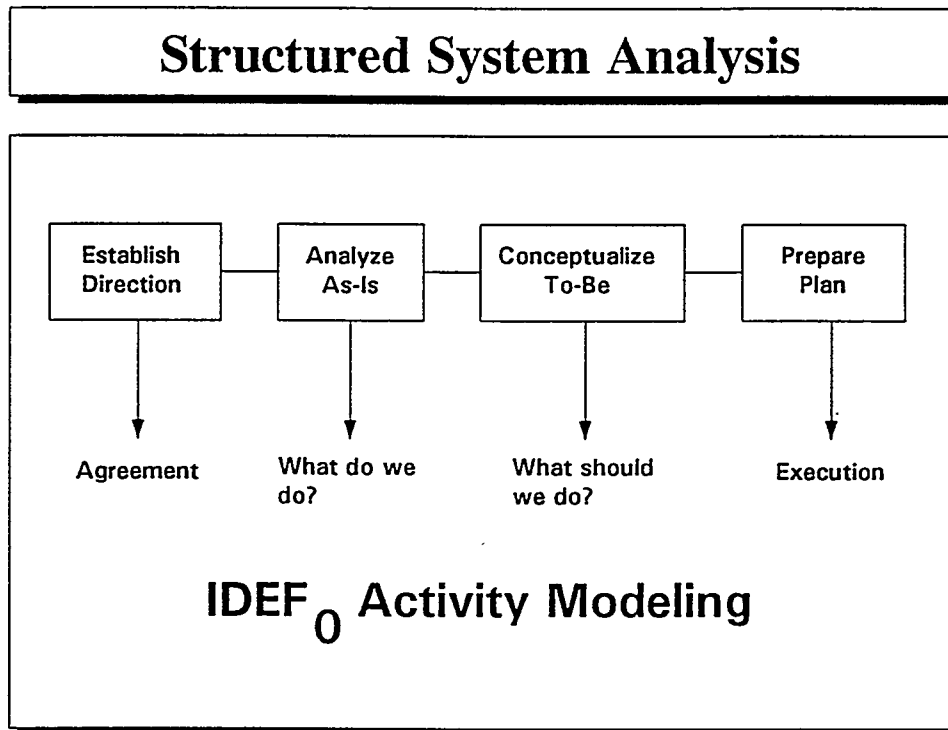

Figure 4 - IDEF Support of Total Systems Design

This study of shop floor control for the shipbuilding environment has led to the following working definition:

Shop floor control is the system of information required by manufacturing to plan, execute, monitor and control production.

This very brief definition does not presuppose any ideal existing system surrounding shop floor control. It takes into account the varied production environments that the products of shipbuilding require, and, it implicitly recognizes the fact that shop floor control is made up of both formal and informal systems, some of which may be automated. The system development issue then becomes one of understanding the existing system (the AsIs) to the point of making informed decisions for change. The change to

the new system (The ToBe) should be focused on bringing about increased productivity. Increased productivity is defined as: make it sooner, faster, better and within legal and functional requirements.

B. IDEF - An Overview of the Methodology

IDEF is an acronym made up of another acronym, ICAM, and the abbreviation **DEF**. The "I" in IDEF stands for the Integrated Computer Aided Manufacturing program funded by the Air Force in the mid 1970's. The ICAM program developed a standard for documenting and communicating a system's activities and data requirements that is today known as the ICAM Definition (IDEF) Methodology. The activity modeling tool is referred to as IDEF₀ (read IDEF zero) and the data modeling tool is referred to as IDEF_{ix} (the x indicates an extended version of IDEF_i as it was originally published). As noted earlier, although many other system analysis tools exist, the IDEF methodology has the unique ability to provide a framework that addresses both function and data requirements. PBI found the method to be both universal in its application and easy to teach to both modelers and modelees.

A key element of IDEF is its ability to highlight and work with the parts of systems that are not computer oriented and probably never will be. When talking in terms of data and information flows, it is easy to fall into the trap of just thinking about computer hardware and software. Modeling with IDEF allows the human element and the informal system to be considered. It does this by focusing on the activities of the process first, and then detailing the information as to how each activity relates.

C. Fundamentals of IDEF

Fundamental concepts and nomenclature are presented here to introduce the IDEF methodology. Further reading and training is absolutely necessary before a novice should try to work a company wide systems analysis. Appendix A provides a list of references and training resources that are available.

The IDEF methodology models a system using a set of diagrams, glossary, and text to rationalize the subject. The start of a model is a very generalized activity box with the associated inputs, outputs, controls and mechanisms that operate on the activity.

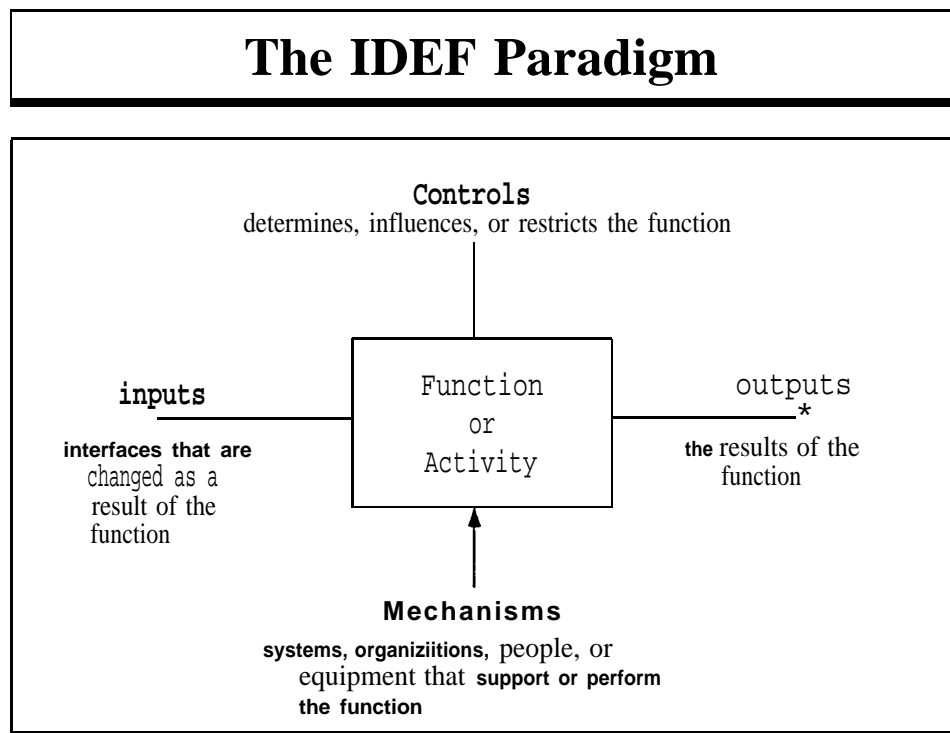

Figure 5- IDEF Nomenclature

This nomenclature, depicted in Figure 5, will be utilized throughout the remainder of the report and can be defined as follows:

Activity Box

These boxes represent functions that must be accomplished. Functions are described by an active verb phrase such as "develop drawing", "execute shop order", "feedback job status". Such functions occur over a period of time.

The arrows connecting the boxes are the "objects" that are needed or produced by the function. The object can be information as well as some physical document, piece, part, person or system. There are four types of arrows, Inputs, Controls, Outputs, and Mechanisms. As a whole, they will be

referred to as the ICOMS of the activity. The first two, are those objects that are necessary for the function to be accomplished:

- Inputs Inputs are those items that are *transformed* by the activity. This may be something physical such as "raw plate" that is transformed by the activity of "cut plate", or, it can be something such as "specifications" that are transformed by the activity of "interpret specifications". Inputs always come into the left side of the activity box. From a data perspective, inputs are sometimes referred to as entities.

- Controls A control is something that *constrains* the activity in some way. An example would be the control of "customer requirements" constraining the activity of design ship. Controls always come into the top of the box.

The last two ICOM's are the output and the mechanism.

- output The output is the object or data that is *produced* by the activity. The output always comes out of the right side of the box.

- Mechanism The mechanism denotes the *resources* that are *utilized* in order to accomplish the activity in the box. People, computer systems, or a fork lift could be a mechanism. The mechanisms always come into the bottom of the box.

The Activity boxes and ICOMS of IDEF move from the general to the specific. An IDEF₀ model starts by representing the whole system as a simple unit in a single box as shown in Figure 6. The single box is then decomposed into its sub-functions. These sub-functions have more specific names and the arrows (the ICOMs) will be more specific. Unlike flow charting techniques, the reader is not overwhelmed by all of the detail at once. The gradual exposition of detail allows a complex system to be comprehended.

Figures 7 and 8 depict this decomposition of activities and ICOMs. Note that the ICOMS of a parent activity are used for each child activity. In this way the model forces continuity of the system depiction and aids the modeler in not letting something "fall through the cracks" during the modeling process.

Figure 6 gives an example of the first diagram in a model. The intent of the first diagram is to provide a statement of the model's orientation. This is done

by stating the purpose and viewpoint of the model and establishing the context.

The context of the model is to define the external interfaces of the subject. In IDEF terms this would be depiction of the ICOMs. The purpose states the intent of the model, that is, why is it being developed. The viewpoint states the authors slant and determines from what perspective the model was built, and therefore establishes what can be seen in the model.¹⁵

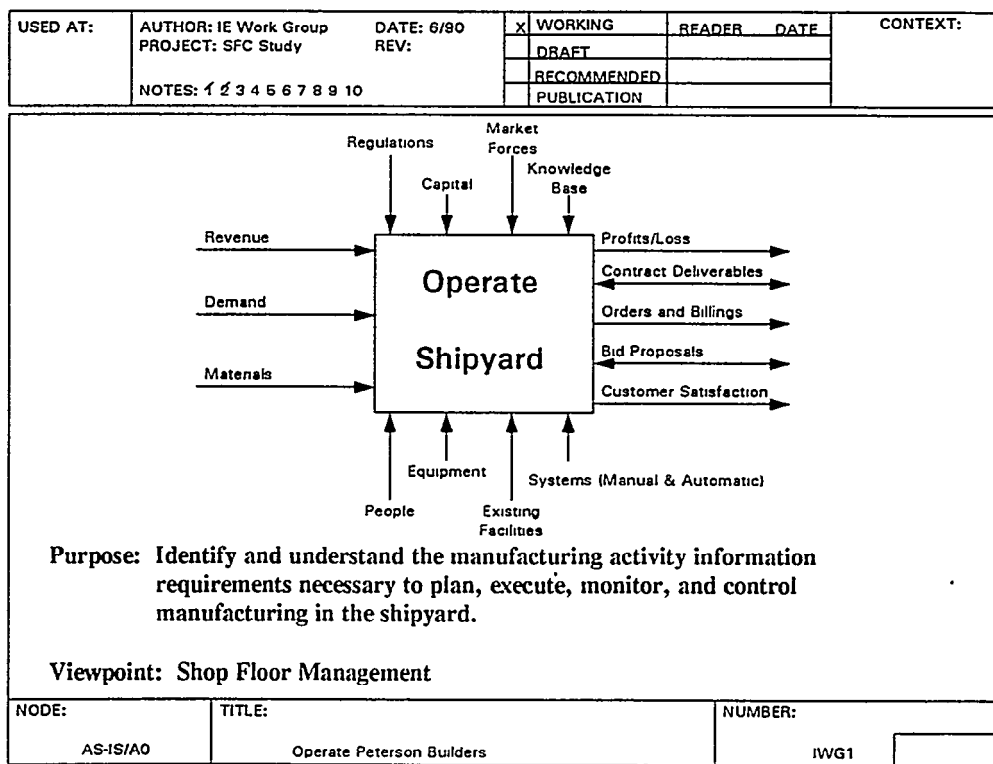

Figure 6 - IDEF Model Context Diagram

¹⁵IDEF Manual, pg 6-2

Decomposition from A-0 to A0

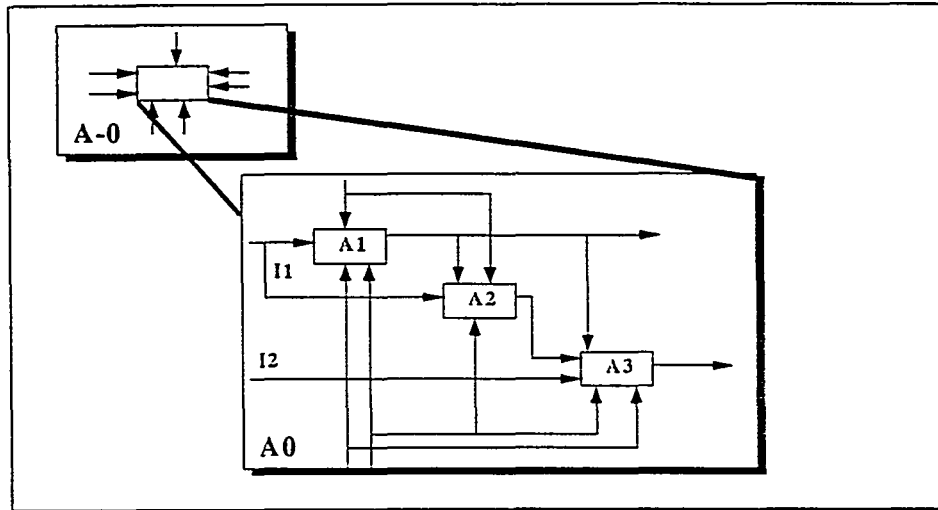

Figure 7 - IDEF Decomposition Framework (1)

Sub-Function A2 Decomposition

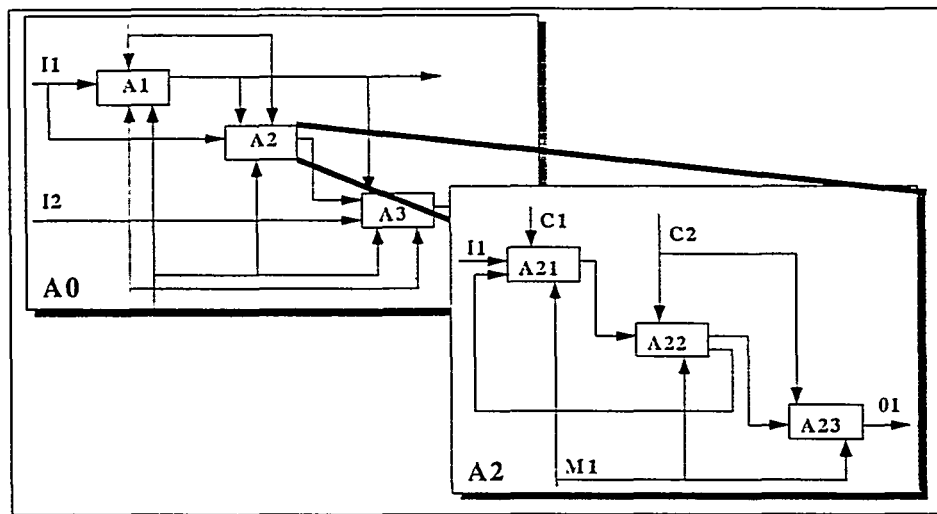

Figure 8 - IDEF Decomposition Framework (2)

As shown in the example diagram of Figure 6, the purpose and viewpoint of the model are stated as notes to orient the reader to boundaries of the analysis. Although this diagram is very simple in nature, it can take many hours to get a group of people to agree on such a diagram. This agreement however, is one of the major pay offs that an organization experiences in the use of this type of analysis tool. IDEF requires a consensus definition of the problem and it is therefore supportive of teamwork. It is the definition of the problem that is the power of IDEF.

For further details on the construction and application of the IDEF methodology, the reader is encouraged to obtain the IDEF Functional Modeling Manual and training from the sources listed in Appendix A.

IV. IDEF APPLICATION EXAMPLE

A. Pipe Shop Case Study

The development of Peterson Builder's piping shop floor control system started about ten years ago. At that time, standards had just been developed for the fabrication shop but they had not been verified or proven. The goals in developing a more formal shop floor control system were to have a method of validating the newly developed standards, to ease the burden on supervisors without sacrificing data collection, and to make the shop more competitive.

The development of the shop floor control system occurred in two stages. First the fabrication and pipe bending areas were addressed and in the second phase pipe installation was added to the system.

One important feature of the Pipe Shop's shop floor control system is its computer program. An outside consultant was contracted to develop a computer program tailored to PBI's Pipe Shop operations. The initial objective of this program was to provide a tool for: tracking material and pipe details, estimating work more accurately, and determining how good the returns are.

As the shop and software evolved, many additional changes took place. The shop started to kit material. They also started to issue work to the floor in eight hour packages based on the standards. Each day everyone was given eight hours worth of work and only the material to do that work. The work was issued according to the schedule and if all the material was available. This schedule disregarded contracts and only looked at the need date for work orders. This breakdown allowed the pipe shop to monitor their returns and evaluate their standards. The shop has taken this one step further. When they first started to kit and issue material on a daily basis the shop would order an entire work order of material and kit it within the shop. The shop now groups the pipe detail sheets (see Figure 9- Pipe Detail Sheet) into their eight hour packages and sends them to the warehouse. The warehouse kits the material and sends the kits to the shop as needed. The kits not only include the material they also include the appropriate paperwork such as pipe details.

The pipe detail sheet as shown in Figure 9 contains a Bill of Material for the pipe detail, the fabrication information including a sketch, bending and other information. An eight hour fabrication work package could include many of these.

At the same time that improvements were occurring in the fabrication shop, the shop realized that their pipe bending machine was a bottleneck. Because of the long set-up time the bender was very labor intensive and a big problem. They needed to maximize the machine utilization.

In an attempt to eliminate the bender problems the shop had Engineering develop the bend information and nest the bends by size (outer diameter) into twenty foot lengths. The shop then took this information and tried to bend everything ahead of schedule. This led to other problems. A lot of work-in-process inventory had to be discarded because changes occurred after the parts had been bent. As the evolution of the Pipe Shop's shop floor control system continued they solved this problem by including all the bend information on their pipe detail sheets (see bottom of Figure 9). During the system development for the fabrication shop each pipe detail was tied to the schedule. By including the bend information in the computer system the software could schedule the bends by size, material and schedule into eight hour packages. Excessive set-ups are eliminated when scheduling by size and the excessive work-in-process inventory is reduced when scheduling by pipe detail need dates.

The job card for bending presently lists all the bends for a day (see Figure 10). The worker only needs to fill in the time of each bend.

After many significant improvements had been made in the fabrication (and bending) of pipe details it was decided to expand the shop floor control system into the installation of pipe. By this time the details were being tracked up until installation. The system lacked the knowledge of when or if the details were installed in the ships. At this time there were no installation standards and job cards contained limited information.

Pipe shop management wanted the same type of system for installation that they already had in the fabrication area. The Industrial Engineering

department assisted in developing standards through extensive time studies and the same consultant expanded the shop floor control software to accommodate installation.

Pipe installation was grouped into work sequences (see Figure 11). A work sequence is basically a package of work for two people for a week. The work sequences were originally about 80 hours of work and the material for these work sequences was kitted for the installers. There were some complaints and problems with working with so many small work packages so the work sequences were made larger.

Presently the work sequences are larger than 80 hours of work and this has caused material control problems. The kits are so large that they can't be given to the workers each week; they must be stored in the warehouse and toolroom. Because of this problem the shop may go back to issuing smaller installation work packages.

Another problem presently being experienced in the pipe installation area is the estimating of work on standards which may or may not be accurate. The standards developed for installing pipe need to be evaluated and refined.

Today the Pipe Shop's shop floor control system is working very well for fabrication and bending. There are problems which need to be addressed in the installation area such as verifying and refining their standards and down sizing work packages, but the basic concept is in place. Just as the system has developed over the past ten years the shop sees opportunities for further enhancement.

The Pipe Shop at Peterson Builders, Inc. was modeled, for this project, using the IDEF methodology. The Pipe Shop was selected because it is viewed as having the most structured shop floor control system at Peterson Builders. This model can serve as a guideline for modifying other shops in the yard. The pipe shop model and glossary can be found in **Appendix B**.

The IDEF diagrams and glossary, in Appendix B, depict the activity of manufacture and install piping at Peterson Builders, Inc. The model was developed to explore the Pipe Shop's shop floor control system. "Manufacture and Install Piping" includes not only the actual process of

fabricating and installing pipe products but also the other associated shop management activities (see page B2).

The six main activities included in "Manufacture and Install piping" include; *plan work in detail, process work order information, assign work and allocate resources, obtain and allocate materials, execute tasks, and develop administrative feedback.* All of these activities are directly needed to manufacture and install piping (see page B4).

The first step in the shop floor control system for a new contract is part of the *process work order information activity*. The planners and shop supervisors sequence the drawings and develop schedules for the drawings, equipment, etc. They also develop a strategy for how the work should be done (see page B10).

The shop planner then takes this information and information on the pipe products such as the pipe detail sheets (see Figure 9) and plans the work in more detail. There are three major steps involved in this detailed planning. The three steps include *identify priority items, create work sequence package, and plan hanger operations* (see page B6).

In the first step the pipe shop planners and crewleaders review the arrangement drawings, work order strategy and information from other trades which may affect pipe installation. Pipe products which are launch critical, tank related, GLO required cable pull parts, or tied to a key construction event are identified. The drawings are divided into a logical installation breakdown. These groups of pipe products for installation are work sequences (see page B6).

The next step in the detailed planning is to assemble all the work sequence information into a package. This includes creating a list of all the loose material which belongs with each work sequence, identifying the pipe details, estimating the number of hangers needed, identifying the standard codes which apply and assigning a non-significant number to the sequence. This information is included on a cover sheet (see Figure 11) which is attached to other pertinent information such as the pipe detail sheets (see Figure 9 and page B8).

The last part of detailed planning is the planning of the hanger operations. This is a separate function performed a shop general supervisor rather than by a planner. The general supervisor develops a list of hangers and their quantities based on drawings and the hanger estimate (see page B6).

Each time all the work sequences have been established for a drawing, that drawing is sent back to the central planner. The central planner then groups the sequences into work orders. A scope, BOM, and budget are created for each work order. Work orders are used by the shop for reporting purposes. Work is assigned and performed by the work sequences (see page B10).

The information on the pipe details and work sequences is loaded into the Pipe Shop's computer shop floor control system. The software develops estimates based on the codes loaded in for the work sequences. It also schedules the work sequences and back schedules the fabrication and bending of pipe details.

Shop supervisors review the work sequences and various schedules in order to prioritize work. They also review drawings, work sequence packages and BOMs before issuing work to the floor to identify any problems or missing information. Resources such as equipment, material, and labor are monitored to ensure they are adequate to perform the necessary work. Work is not assigned unless all of the necessary material is available. If the material is available the shop requests it from the warehouse. The warehouse kits the material by work sequences and sends it to the shop. In the fabrication area the material is placed on carts by work sequence number in eight hour packages. When a pipefitter or crew has finished an assignment they take the next cart in line as their next assignment (see pages B 12 and B14).

The pipefitters in the fabrication and bending areas are issued work in 8 hour increments. An eight hour package may include many pipe details or bends (Figure 9). The shop floor control software automatically schedules the pipe details into eight hour packages but the shop supervisors do have the ability to change the assignments based on needs or knowledge they have. The pipefitters have a list of what they should be able to do each day based on the standards. They fill in the time for each item and submit the list as their time card for the day (see Figure 10). The installers have larger work packages

and use the more traditional time card (see Figure 12). Their work is issued as a work sequence, or about a weeks worth of work for two workers. The installers use the more traditional time card but supplement the cards with additional information. In order to accurately capture the actual time to perform a job and to provide a tool for validating the standards the shop uses a rework code on their time card to explain any rework performed (see page B16).

Rework Codes include:

1. **Damaged Equipment** - PBI
2. Faulty Equipment - Vendor
3. Trade Interference
4. Material Problems
5. Human Errors
6. Time Card Errors
7. Non Detail "E" Labor
8. Miscellaneous

After assignments have been issued the actual manufacturing process occurs. The bending process is based off a two week schedule. Within two weeks every size bend required is bent. The bent pipe is stored in the shop (see page B16).

The bent pipe is included on the material carts assigned to the fabricators. When the production crews fabricate pipe details they not only produce the pipe products they also provide feedback, problems, and data on their time cards (see page B 16).

The pipe details are stored in the waterfront shop awaiting installation. The pipe systems are then installed and inspected. Although *Test and Inspect* is a separate activity in the model there is some inspection inherent in the fabrication and installation processes (see page B1 6).

The daily time charges are reviewed and entered by the Pipe Shop. The smaller breakdown of work has simplified the process of progressing work. Instead of guessing the percent complete for a large job the shop can look at how much work is actually complete and how much is remaining (see page B18).

Part of the *Administrative Feedback* also includes addressing problems whether they be from the workers or the schedule (see page B18).

The modeling of the Pipe Shop was done by a core group of three people who had limited knowledge of the Pipe Shop plus experience creating IDEF models. Several of the key players in the piping shop floor control system were interviewed and also assisted in the modeling. The modeling interview process itself, without going through model development and analysis, cleared up several misconceptions on how the Pipe Shop operates. Most people, outside of the Pipe Shop planners, thought that work orders are developed and then broken into smaller packages, while actually, the detailed planning is done first. The role of the Pipe Shop planners in planning hanger operations was also made clearer.

B. Discussion of Case Study

The context of the model is *Manufacture and Install Piping Systems*. The model basically focuses on the shop floor control system and detailed planning activities. It does not illustrate the budgeting process, engineering, material procurement, early planning activities, etc. The results of these functions, however, are shown as inputs, controls, or mechanisms in the model. The model was decomposed two levels because this displayed a good overview of the shop floor control system. The activity of detailed planning was decomposed one level further since this is the area in particular where the piping shop floor control is different from other shops at Peterson Builders, Inc. Table 1 shows the indented activity list which is an index to the model.

AO MANUFACTURE AND INSTALL PIPING

A1 Plan Work in Detail

A11 Identify Priority Items

A12 Create Work Sequence package

A121 Create List of Loose Material

A122 Identify Details

A123 Estimate the Number of Hangers

A124 Put together Codes based on Material

A125 Assign Work Sequence Numbers

A126 Complete Work Sequence Cover Sheet

A13 Plan Hanger Operations

A2 Process Work Order Information

A21 Sequence Drawings

A22 Plan Work Order Strategy

A23 Write Work Order Scope

A24 Create Work Order BOM

A25 Allocate Budget

A3 Assign Work and Allocate Resources

A31 Identify and Prioritize Upcoming Work

A32 Review Drawings, Work Sequences and BOMS

A33 Monitor Resource Availability

A34 Assign Work

A4 Obtain and Allocate Materials

A41 Determine Material Availability

A42 Request Material

A43 Receive and Distribute Material

A44 Manage Shop Stores and Consumables

A5 Execute Tasks

A51 Fabricate Parts

A52 Assemble and Install Products

A53 Test and Inspect Products

A6 Develop Administrative Feedback

A61 Estimate Work

A62 Monitor Time Charging

A63 Progress Work

A64 Address Problems

Table 1- Activity List as the Model Index

The model shows that the Pipe Shop has a lot of up front planning taking place before orders are issued to the floor (node ASIS/AO page B4). The

extra time spent in up front planning pays for itself later on. During this planning, work sequences (see IDEF glossary, page B 19) are developed which are used as authorization for work. Work sequences are generally 40 to 100 hours worth of work. Most other departments at PBI were found to use work orders as authorization to start work. The control aspects of the Pipe Shop's work sequences (40-60 hrs of work) were recognized as an attribute to be pursued in the overall shipyard shop floor control scheme. The IDEF modeling allowed this difference to be documented and compared to other areas of the shipyard where such work organization does not exist.

The modeling process revealed the following activities necessary to achieve the shop floor control information for the Pipe Shop. Drawings are reviewed and work sequences (40 -100 hour packages) are created and prioritized. The work sequences are then assigned to a work order by drawing. The work orders are not used to perform the work in the Pipe Shop. Their role is primarily for reporting progress and monitoring time charges. The more detailed work sequences control the work execution on the shop floor.

In modeling other areas of the shipyard, it was evident that the detailed planning occurs as the work is hitting the shop floor. IDEF was able to contrast these two types of planning efforts. The contrast shows Up in the inputs, outputs, controls and mechanisms.

The Pipe Shop detailed planning also tries to ensure that most of the material is available before a work sequence is issued, thereby reducing delays and interrupted work. In the fabrication area, material is organized by work sequence on carts. When a worker or crew has finished a work sequence they take the next cart and start working on the next sequence.

The Pipe Shop has developed labor standards for the fabrication and installation processes of pipe details. These are used to develop work sequence and work order estimates. This is illustrated in the model on nodes ASIS/A 12 and ASIS/A2 (page B8 and B 10). Each type of detail has a code assigned to it. A list of codes is created for each work sequence and recorded on a work sequence cover sheet. (Figure 11 is a sample work sequence cover sheet. The codes appear in the lower right corner.) The codes are loaded into

the shop floor control computer system where the times associated with the codes are then added and an estimate is created.

C. Further Analysis of the Model

A completed model can be analyzed to produce information on costs, time and duplication of effort. For example, when a planning activity has several people listed as a resource, they may be duplicating efforts in that activity. Further decompositions would indicate whether or not they were doing the same tasks. If time or percent of time is added to the people mechanisms, the model can be used as a tool for **cost analysis**. Costs could also be assigned to other mechanisms such as systems or equipment.¹⁶ This information provides the foundation for Activity Based Cost accounting.

The listing of systems as mechanisms exemplifies the fact that the shop floor control system lacks a common integrated system. Some activities require information from more than three systems. For example, on node ASIS/A2, the activity *create work order bill of material* utilizes the material system, piping shop floor control system and several others. *Identify and prioritize upcoming work* on node ASISIA3 also requires many systems. These systems all utilize a database of their own -- databases which do not "talk" to each other, are not normalized and are found on different computer platforms. A major amount of time and effort could be saved if all information was available on a common normalized database. The shop would then receive all the information needed in one useable form.

The model helps reveal these characteristics and others. When utilized, it can serve as a tool to identify problem areas and make changes. The model can be decomposed further to help address any specific problem areas. Documentation of procedures can be developed based on the diagrams. Because of the model's graphical presentation, there is less reliance on words and more on "pictures" to explain the system. The model can also be used to acquaint others with how Peterson Builders, Inc. manufactures and installs piping systems. Finally, the model can be used to relate the pipe shop activities to all other activities in the shipyard.

¹⁶IDEF Source, Course 3, Volume 1, Cost Function Analysis Section. August, 1989

FAB INFORMATION

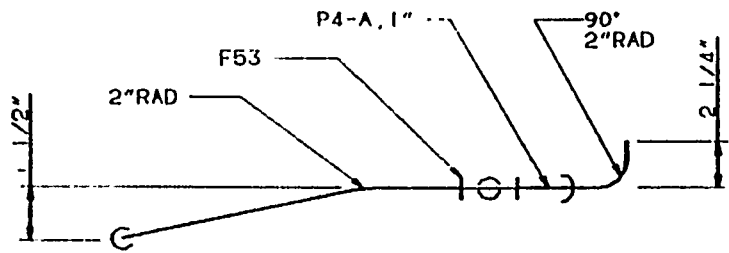

GENERAL NOTES
 P4-A SIS on Sht A95-1
 P4-B SIS on Sht A95-2

BOM

PBI STOCK NO	PC NO	QTY	COMP	MAT'L	TYPE	MISC	SIZE
1001340	F45	1	ELB	BRZ	-	SB	1 0
1002386	P4-F	3"	TUBE	CNA 90-10	SMLS	⓪	1 315 X 065
1006308	F141	4	CLAMP	SST 304	HDSE	--	24
1006309	F140	2	HOSE	SRB	--	--	1 375 ID X 5 0 LG
1002386	P4-E	7"	TUBE	CNA 90-10	SMLS	⓪	1 315 X 065
1002386	P4-D	4"	TUBE	CNA 90-10	SMLS	⓪	1 315 X 065
1002905	F53	1	T	BRZ	-	SB	1 0
1002386	P4-C	7 1/4"	TUBE	CNA 90-10	SMLS	⓪	1 315 X 065
1002386	P4-B	63 3/8"	TUBE	CNA 90-10	SMLS	⓪	1 315 X 065
1002386	P4-A	16 1/2"	TUBE	CNA 90-10	SMLS	⓪	1 315 X 065

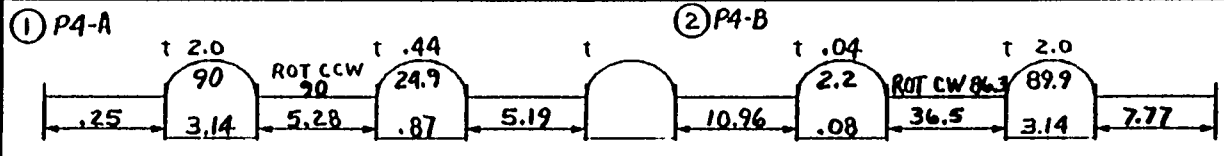
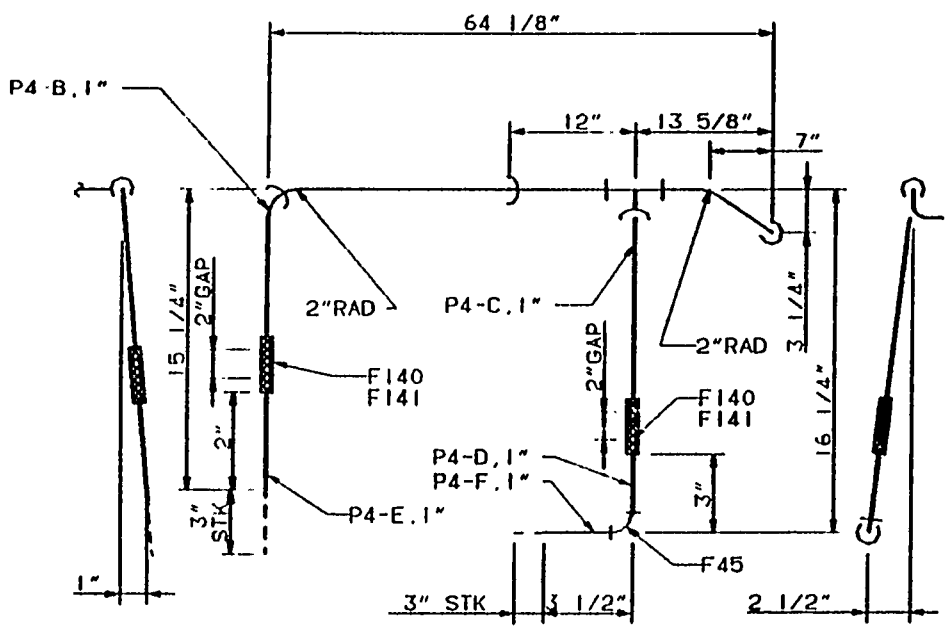

BEND INFORMATION

ZONE 71-G	COMP 02-35-2-L
PIPE DETAIL NO	
P B I DWG NO	
NAVSEA DWG NO	
SHEET NO 95	REV. A

Figure 9 - Pipe Detail Sheet and Bend Information

PIPE FABRICATION TIME CARD

PRI/PIP036

FABRICATION LABOR SCHEDULE

3/30/92 9.56.58 PAGE 1

EMPLOYEE NAME.. _____ SUPERVISOR SIGNATURE.. _____

EMPLOYEE NBR... _____ DEPT NBR.. _____

SHIFT _____ START _____

LABOR DATE..... ____/____/____

HOURS _____ FINISH _____

Figure 10 - Fabrication Time Card

CONT	HULL	ASSY	W.O.NO.	DTL LTP	SIS SHT	LN IT	STD TIME	OT HRS	"P" TIME	"E" TIME	WORK CCMP	WORK PART	DIAM	MATL	COMMENTS IF NEEDED	WORK ORDER	DESCRIPTICA
9700	0011	0000	556 161	AAH			-----	-----	-----	-----	-----	-----	1.00	CR	-----	STEER GR	HYDR
9700	0011	0000	556 161	AAI			-----	-----	-----	-----	-----	-----	1.00	CR	-----	STEER GR	HYDR
9700	0011	0000	556 161	AAJ			-----	-----	-----	-----	-----	-----	1.00	CR	-----	STEER GR	HYDR
9700	0011	0000	556 161	AAK			-----	-----	-----	-----	-----	-----	1.00	CR	-----	STEER GR	HYDR
9700	0011	0000	556 161	AAL			-----	-----	-----	-----	-----	-----	1.00	CR	-----	STEER GR	HYDR
9700	0011	0000	556 161	AAM			-----	-----	-----	-----	-----	-----	1.00	CR	-----	STEER GR	HYDR
9700	0011	0000	556 161	AAN			-----	-----	-----	-----	-----	-----	1.00	CR	-----	STEER GR	HYDR
9700	0011	0000	556 161	AAO			-----	-----	-----	-----	-----	-----	1.00	CR	-----	STEER GR	HYDR
9700	0011	0000	556 161	AAQ			-----	-----	-----	-----	-----	-----	1.00	CR	-----	STEER GR	HYDR
9700	0011	0000	556 161	AAR			-----	-----	-----	-----	-----	-----	1.00	CR	-----	STEER GR	HYDR
9700	0011	0000	556 161	AAS			-----	-----	-----	-----	-----	-----	1.00	CR	-----	STEER GR	HYDR
9700	0011	0000	556 161	AAT			-----	-----	-----	-----	-----	-----	1.00	CR	-----	STEER GR	HYDR
9700	0011	0000	556 161	AAU			-----	-----	-----	-----	-----	-----	1.00	CR	-----	STEER GR	HYDR
9700	0011	0000	556 161	AAV			-----	-----	-----	-----	-----	-----	1.00	CR	-----	STEER GR	HYDR
9700	0011	0000	556 161	AAW			-----	-----	-----	-----	-----	-----	1.00	CR	-----	STEER GR	HYDR
9700	0011	0000	556 161	AAZ			-----	-----	-----	-----	-----	-----	1.00	CR	-----	STEER GR	HYDR
9700	0011	0000	556 161	AAa			-----	-----	-----	-----	-----	-----	1.00	CR	-----	STEER GR	HYDR
9700	0011	0000	556 161	AAb			-----	-----	-----	-----	-----	-----	1.00	CR	-----	STEER GR	HYDR
9700	0011	0000	556 161	AAc			-----	-----	-----	-----	-----	-----	1.00	CR	-----	STEER GR	HYDR
9700	0011	0000	556 161	AAd			-----	-----	-----	-----	-----	-----	1.00	CR	-----	STEER GR	HYDR
9700	0011	0000	556 161	AAe			-----	-----	-----	-----	-----	-----	1.00	CR	-----	STEER GR	HYDR
9700	0011	0000	556 161	AAf			-----	-----	-----	-----	-----	-----	1.00	CR	-----	STEER GR	HYDR
9700	0011	0000	556 161	AAg			-----	-----	-----	-----	-----	-----	1.00	CR	-----	STEER GR	HYDR
9700	0011	0000	556 161	AAh			-----	-----	-----	-----	-----	-----	1.00	CP	-----	STEER GR	HYDR
9700	0011	0000	556 161	AAi			-----	-----	-----	-----	-----	-----	1.00	CR	-----	STEER GR	HYDR

IMPLEMENTATION GUIDE FOR APPROACHING SHOP FLOOR CONTROL

IMPLEMENTATION GUIDE FOR APPROACHING SHOP FLOOR CONTROL

PETERSON BUILDERS, INC.

WORK ORDER SEQUENCE 003

WORK ORDER NO. 529-156 DRAWING NO. 529-056 ACCOUNT NO. 9700
DATE ISSUED _____ B/M ATTACHED YES NO HULL NO. 09
SCHED. START _____ SCHED. COMP. _____ DEPT. 14 - Pipe
REV. A ECN. #001 COMPARTMENT NAME AND NO. AMB #1, 3-41-0-E

WORK ORDER TITLE Drain and Bilge LOOP # 2
Install Piping to OVB

THIS WORK SEQUENCE INCLUDES THE FOLLOWING DETAILS;
AAU, AAU, AAU, AAU

CHECKED BY _____	DATE _____		
INSTALLED BY _____	DATE _____	529-V56	W/S 003
REVIEWED BY _____	DATE _____		

SUPERVISORS COMMENTS

Note
Don't order F 64's
They are already
up at WPS bldg

ACTUAL NUMBER OF HANGERS USED - _____

Figure 11 - Peterson Builders' Work Order Sequence Form

IMPLEMENTATION GUIDE FOR APPROACHING SHOP FLOOR CONTROL

PIPE INSTALLATION TIME CARD											
SHIFT _____		HOURS _____		EMPLOYEE NO. _____				DATE: _____			
START _____		FINISH _____		EMPLOYEE NO. _____							
CONT NO.	HULL	W.O. NO.	DETAIL W.O. SEQ	HRS	OT HRS	TYPE LABOR			COMP Y/N	I N S	COMMENTS E LABOR - MUST SHOW ECN # R LABOR - EXPLAIN
						S	R	E			
SUPERVISOR _____			EMPLOYEE _____				EMPLOYEE _____				
			REWORK CODE — SEE REVERSE SIDE								

Figure 12 - Installation Time Card

V. RECOMMENDATIONS AND CONCLUSIONS

The project achieved its objective of providing an approach to Shop Floor Control. A structured analysis and design technique was utilized which proved very successful in identifying requirements necessary for PBI to move forward in further design of an integrated business system.

In this study it was found that an understanding of the entire shipyard operation is necessary to properly approach shop floor control. The approach used was found to be essential in developing a focused understanding of the total business system. Using the methodology is a rigorous effort.

This project presents PBI's pipe shop as a case study. This is only a small example of the large scale, company funded effort, which developed a model for the entire shipyard. Two major changes for the shipyard resulted from this analysis: (1) change the way work is organized by formally utilizing a Product Work Breakdown Structure, and (2) purchase a MRPII based software package to provide the integration of all business systems.

The IDEF methodology is currently being coupled with other techniques to define the ToBe environment. Input, process, and output diagrams are to be developed and are shown in Figure 13. From this information, detailed "play script" procedures for use in executing individual functions will be documented.

A key part of achieving a complete understanding of the new systems and procedures has been, and continues to be, an extensive education and training process requiring hands-on design by the ultimate users. It is expected that two to four separate planning/engineering cycles (on individual ship designs) will have to occur before there is a complete understanding and refinement of the new systems.

The biggest stumbling block in making the change in work organizations and software systems continues to be the human factor. There is a requirement for users of any system, when making a change, to make a paradigm shift. To accomplish this for the shipbuilding industry, it requires that everyone be

IMPLEMENTATION GUIDE FOR APPROACHING SHOP FLOOR CONTROL

capable of putting on their group technology glasses and asking, "How can this be done so there is the minimum amount

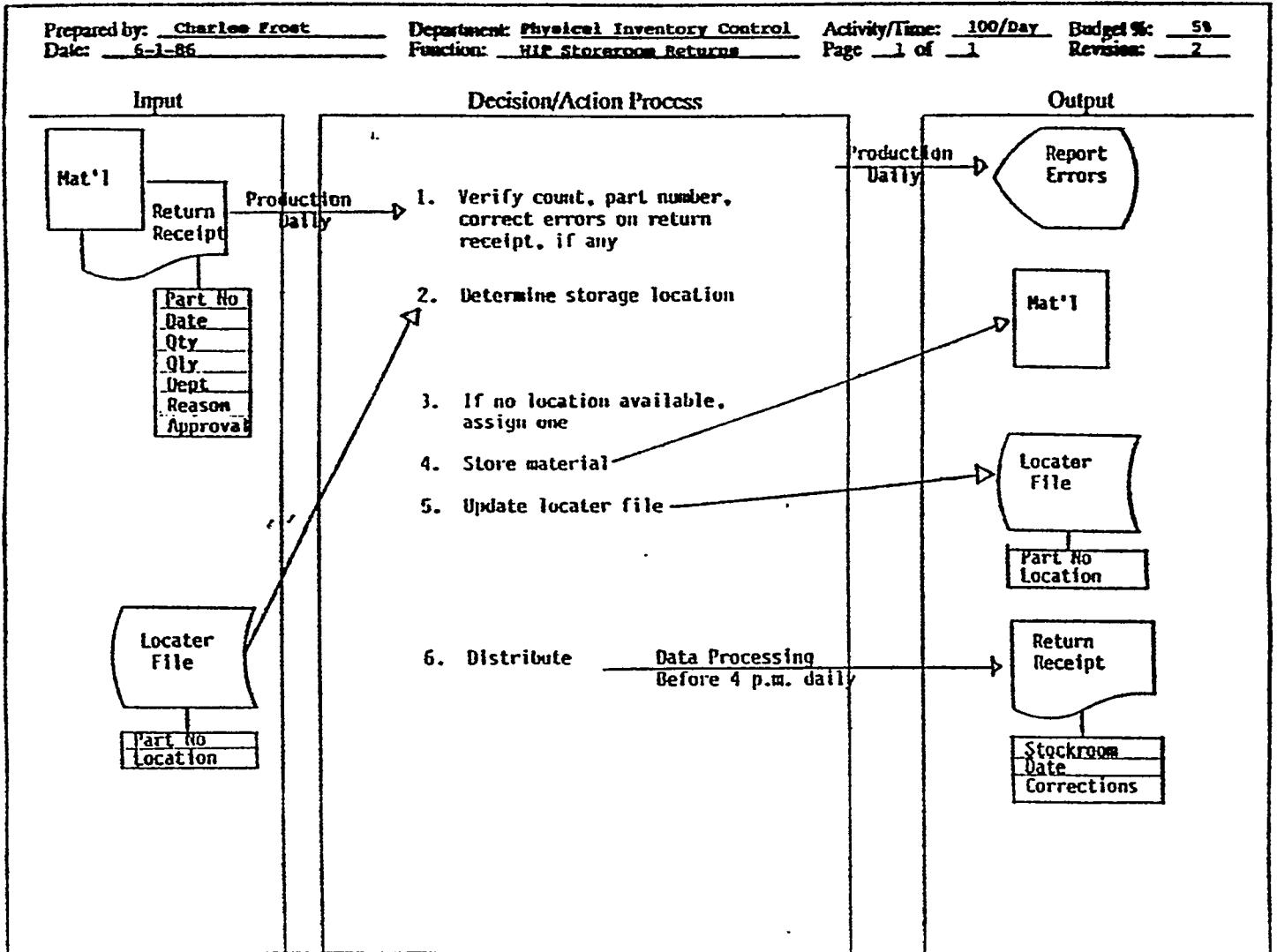

Figure 13 - Procedure Flow Chart

of redundant effort for the overall product execution." At the same time that these workers are achieving this shift, the management structure above them must be measuring the results of every function as to how it best supports the shop floor. This is a major shift away from implementations of shop floor control that result in systems that are designed to feed information to management. The focus must be on feeding the shop floor so that proper management can occur at that level.

The key to any shipyard's success in today's world market is hinged on its ability to eliminate redundancy of effort and shift effort into the up front planning and engineering activities. To do this, a product oriented framework that describes the build strategy must be established during the bid stage. Based on this framework, the planning and engineering activity must be capable of achieving successive iterations in the development of the shop floor information. The detail is established as the design unfolds and the master plan is then updated to reflect more refined information. ¹⁷ To accomplish this, the mechanism of a well educated workforce, that clearly understands how their job contributes to the overall system, is required. The approach outlined in this report helped to define those requirements.

Finally, one result of this project was to expose the authors to many efforts that have utilized the IDEF methodology or structured approaches that are very similar to it. An example is a major effort that is underway in Europe under the ESPRIT project ¹⁸ It is recommended that the National Shipbuilding Research Program recognize the IDEF methodology as a communication tool for the shipbuilding industry. Encouraging further work that utilizes IDEF would result in project outputs that could more readily be interpreted and transferred from one shipyard to another.

¹⁷Flexible Production Indices, NSRP #238, April 1986, pg 7.

¹⁸Shipyard Modelling - Approach to Obtain Comprehensive Understanding of Functions and Activities, NSRP 1990 Ship Production Symposium, August 21-24, 1990

Appendix A: References and Resources

Consolidated List of References

Cost/Schedule Control Systems Criteria. Fleming, Quentin W. Chicago, IL: Probus Publishing Company, 1983. pp. 78 - 91.

Shop Floor Control. Melnyk, Steven A., et al. Homewood, IL: Dow Jones-Irwin, 1985.

Production Planning and Inventory Control. McLeavey, Dennis W., and Narasimhan, Seetharama L. Newton, MA: Allyn and Bacon, Inc., 1985.

MRPII: Making it Happen. Wallace, Thomas F. Essex Junction, VT: Oliver Wight Limited Publications, 1985.

Shop Floor Control: A Detailed Guide to its Understanding and Effective Implementation. Wassweiler, William. Harrison, NY: MGI Management Institute, 1984.

Production Activity Control. Melnyk, Steven A., and Carter, Phillip L. Homewood, IL: Dow Jones-Irwin. 1987.

A Conceptual Information Model (Data Base Design) for Outfit Planning. National Shipbuilding Research Program. Diesslin, Richard L. September 1982

Manufacturing Software for Shipyards. National Shipbuilding Research Program. Zigelman, Charles. September 1991.

A Manual on Planning and Production Control for Shipyard Use. National Shipbuilding Research Program. Bath Iron Works Corp. and Corporate-Tech Planning. September 1978

"IDEF Modeling Part I: Pinpointing Needs Worth the Effort." CIM Strategies, Volume VI, No. 11 (1989), 1-6.

"IDEF Modeling Part II: Tools and Education." CIM Strategies, Volume VI, No. 12(1989), 13-15.

"Integrated Computer-Aided Manufacturing (ICAM), Function Modeling Manual IDEF₀", UM 110231100, June 1981, Materials Laboratory, Air Force Wright Aeronautical Lab, Wright-Patterson Air Force Base, OH 45433

Consolidated List of Resources

Control Data Corp., Bill Bradley, 2970 Presidential Dr., #22, Fairbom, OH 45234; 513-427-6323

D. Appleton Company (DACOM), Dan Appleton, 1334 Park View Avenue, Manhattan Beach, CA 90266; 213-546-7575

Datamatic, Barney Leifiste, Datamatic Plaza, 2121 North Glenville Dr., Richardson, TX 75082; 214-234-5000

Eclectic Solutions, Al Irvine, 5880 LaJolla Blvd, LaJolla, CA 92037; 619-454-5781

Finsiel, Bruno Scialpi, via Isonzo 21/B, 00198 Roma, Italy; 39.6.8431.1

John Flanagan, 19360 Rinaldi St., #304, Northridge, CA 91326; 818-773-9451

IDNF Users Group, Secretariat, Universal Technology Corp., 4031 Colonel Glenn Highway, Dayton, OH 45431; 513-426-8530

Meta Software, Andrew Levin, 150 Cambridge Park Dr., Cambridge, MA 02140; 617-576-6950

New England Business Consultants, Dan Thornhill or Rick Bevelaqua, 61 Elm St., Methuen, MA 01844; 508-794-0375

Softech, Clarence Feldman, 460 Totten Pond Rd., Waltham, MA 02254; 617-890-6900

Wizdom Systems, Dennis Wisnosky, 1260 Iriquois Ave., Naperville, IL 60563; 708-357-3000

Appendix B: Case Study Application Example; Pipe Shop IDEF Model

USED AT:	AUTHOR : Shop Floor Control Project	DATE: 12/21/90	X	WORKING	READER	DATE	<input type="checkbox"/> CONTEXT: SFC2 <input type="checkbox"/> <input type="checkbox"/> <input type="checkbox"/> <input type="checkbox"/> <input type="checkbox"/>
	PROJECT: sfc piping	REV.: 1/17/91		DRAFT			
	COMPANY: PETERSON BUILDERS, INC.			RECOMMENDED			
	NOTES : 1 2 3 4 5 6 7 8 9			PUBLICATION			

- The model's purpose includes the theme of shop floor control by focusing in on the information requirements for planning, executing, monitoring and controlling PBI manufacturing.

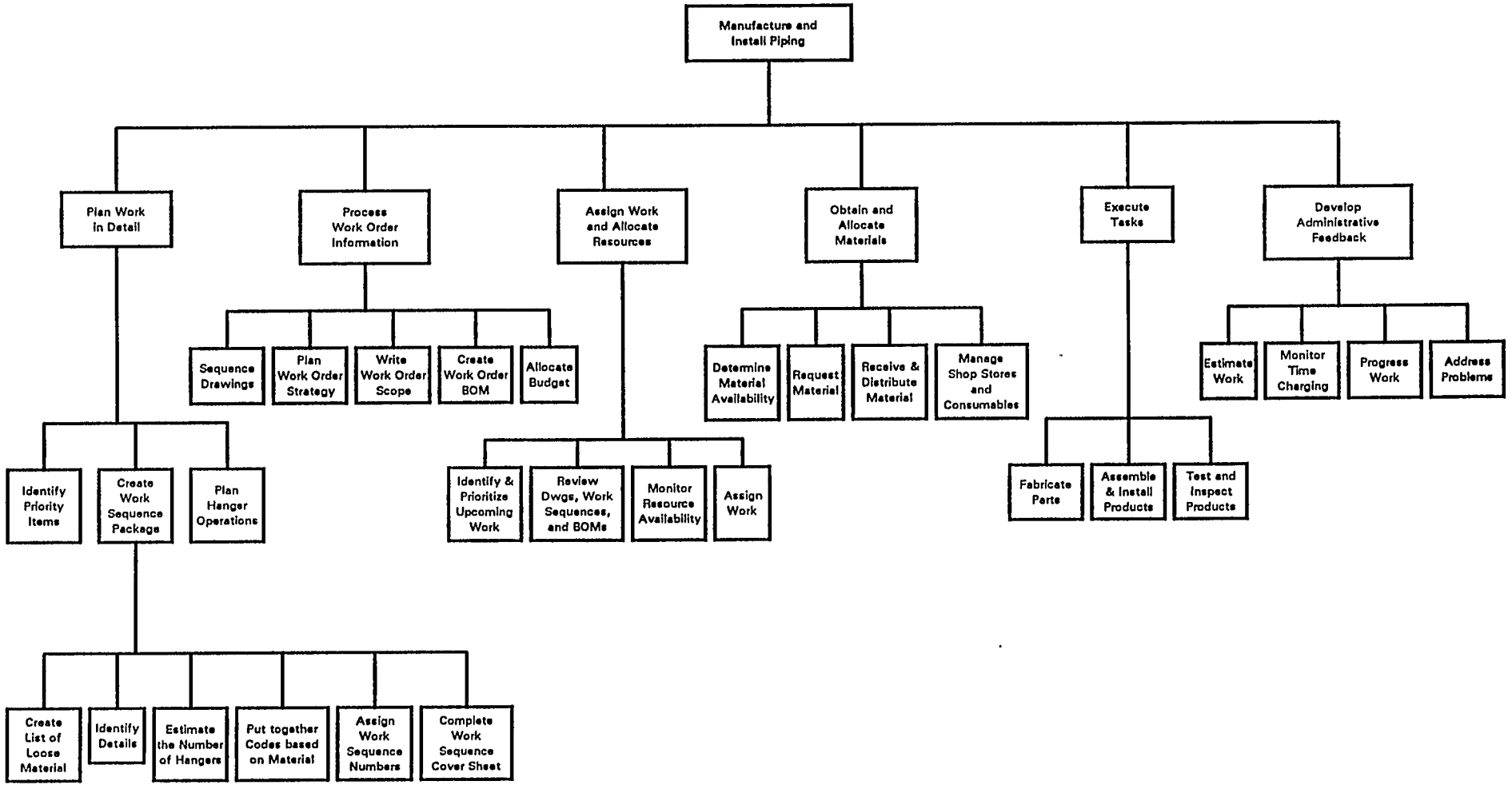

NODE: ASIS/A-0T	TITLE: Manufacture and Install Piping Systems - Text Diagram	NUMBER: SFC11
--------------------	---	------------------

USED AT:	AUTHOR : Shop Floor Control Project	DATE: 12/11/90	X	WORKING	READER	DATE	CONTEXT:
	PROJECT: sfc piping	REV.: 1/08/91		DRAFT			
	COMPANY: PETERSON BUILDERS, INC.			RECOMMENDED			
	NOTES : 1 2 3 4 5 6 7 8 9			PUBLICATION			

B2

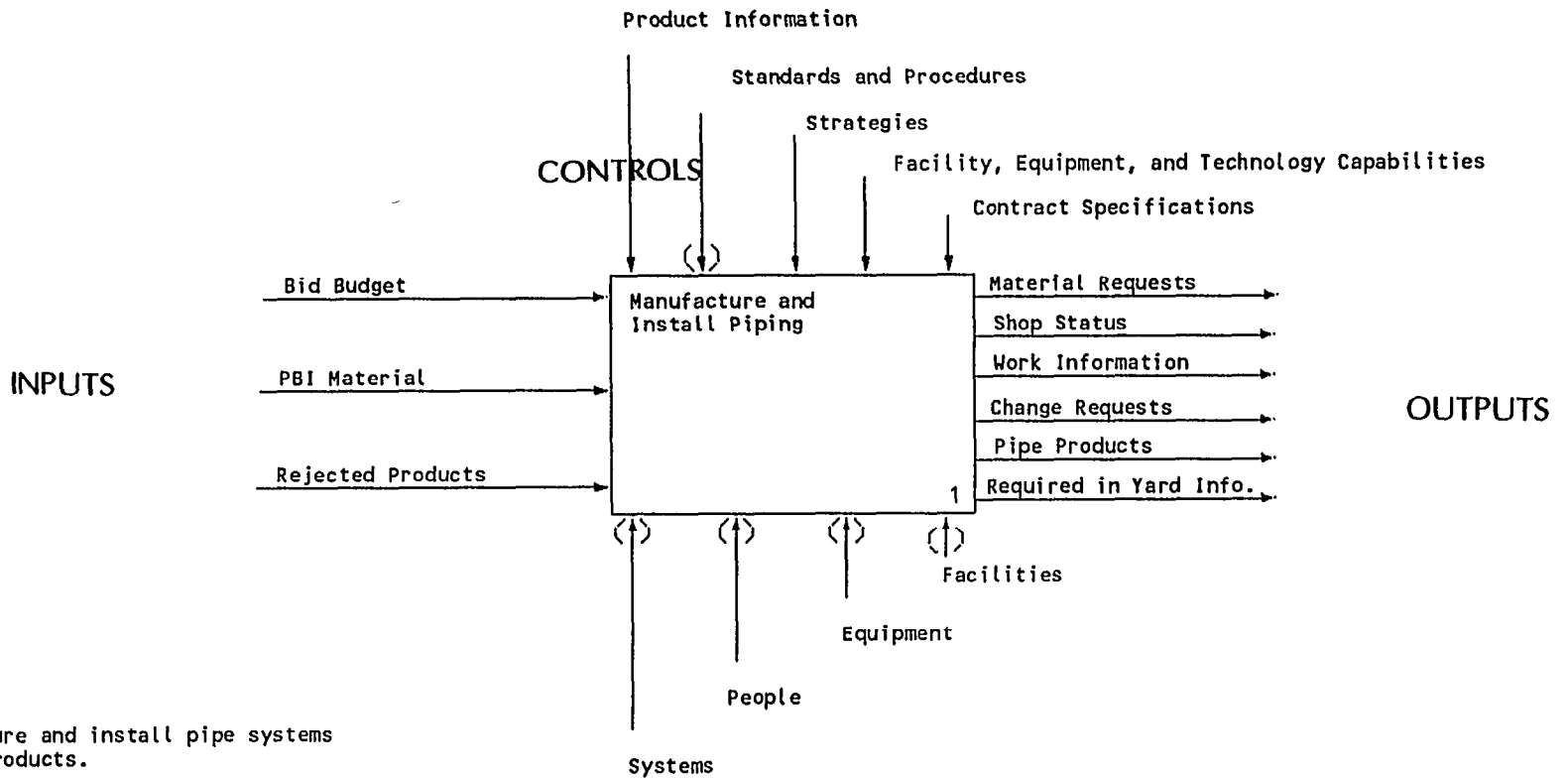

1 Context: Manufacture and install pipe systems in PBI products.

2 Purpose: Identify and understand the manufacturing activity information requirements necessary to plan, execute, monitor, and control pipe manufacturing at PBI.

3 Viewpoint: Pipe Shop Management.

NODE: ASIS/A-0	TITLE: Manufacture and Install Piping Systems	NUMBER: SFC1	
-------------------	--	-----------------	--

USED AT:	AUTHOR : Shop Floor Control Project	DATE: 12/21/90	X	WORKING	READER	DATE	<input type="checkbox"/> CONTEXT: SFC2 <input type="checkbox"/> <input type="checkbox"/> <input type="checkbox"/> <input type="checkbox"/> <input type="checkbox"/>
	PROJECT: sfc piping	REV.: 5/29/92		DRAFT			
	COMPANY: PETERSON BUILDERS, INC.			RECOMMENDED			
	NOTES : 1 2 3 4 5 6 7 8 9			PUBLICATION			

- The work order strategy is developed, then the work is planned in detail followed by the creation of work orders.
- The work order numbers are tied to schedule, material, and budget and are basically used for reporting purposes.
- A work order may consist of many work sequences which are used to assign and perform work.
- All of the activities below are directly needed to manufacture and install piping.

B3

NODE: ASIS/AOT	TITLE: Manufacture and Install Piping Systems - Text Diagram	NUMBER: SFC12	
-------------------	---	------------------	--

USED AT:	AUTHOR : Shop Floor Control Project	DATE: 12/11/90	X	WORKING	READER	DATE	CONTEXT: SFC1 <input type="checkbox"/>
	PROJECT: sfc piping	REV.: 1/22/91		DRAFT			
	COMPANY: PETERSON BUILDERS, INC.			RECOMMENDED			
	NOTES : 1 2 3 4 5 6 7 8 9			PUBLICATION			

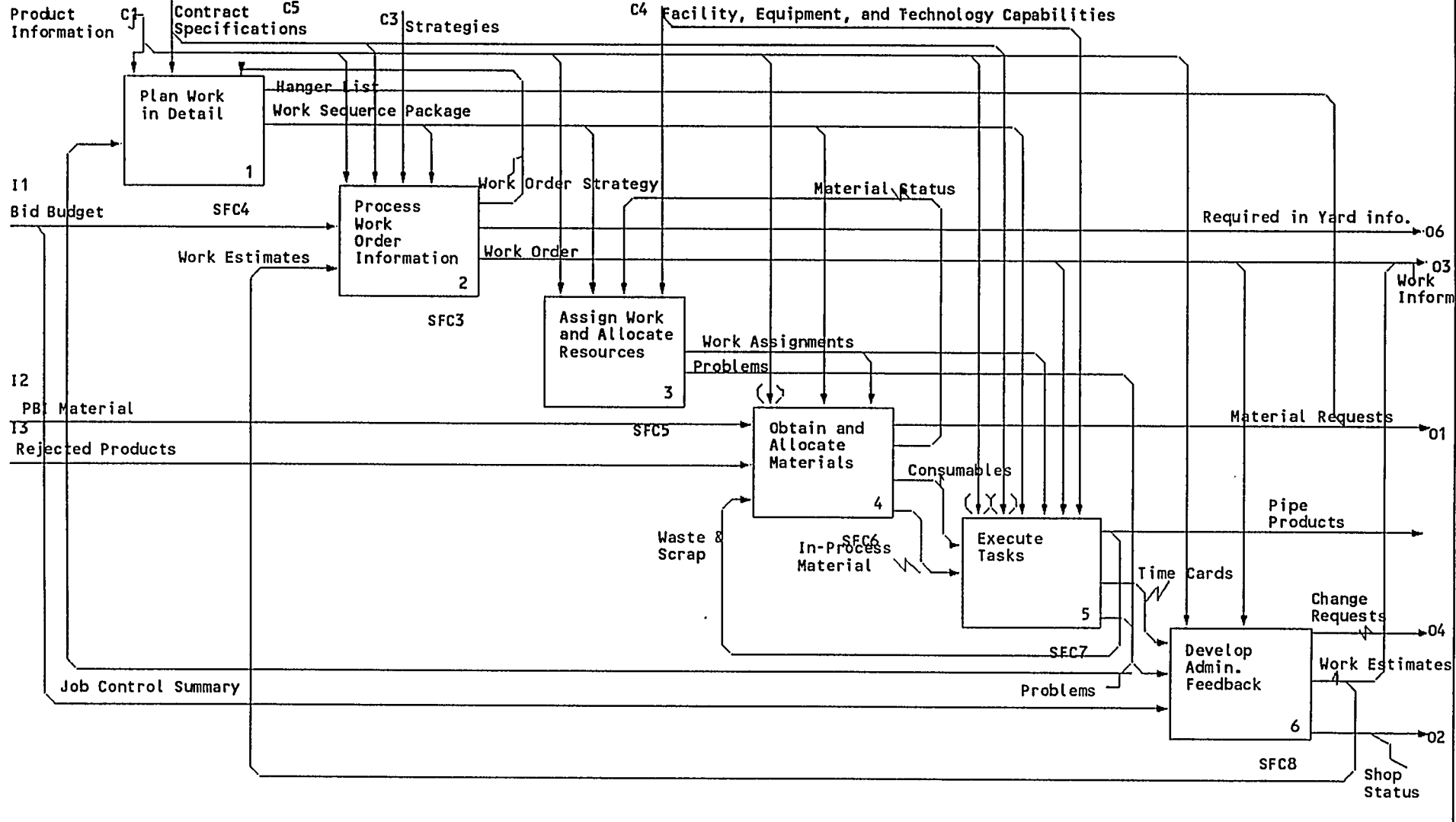

NODE: ASIS/A0	TITLE: Manufacture and Install Piping Systems	NUMBER: SFC2
------------------	--	-----------------

USED AT:	AUTHOR : Shop Floor Control Project	DATE: 12/21/90	X	WORKING	READER	DATE	CONTEXT: SFC4 <input type="checkbox"/> <input type="checkbox"/> <input type="checkbox"/> A1
	PROJECT: sfc piping	REV.: 5/27/92		DRAFT			
	COMPANY: PETERSON BUILDERS, INC.			RECOMMENDED			
	NOTES : 1 2 3 4 5 6 7 8 9			PUBLICATION			

- In the first activity the Pipe Shop planners and crewleaders review the arrangement drawings, work order strategy, and information from other trades which may affect pipe installation.
- Priority items include overboards or launch critical (V work orders), tanks (K work orders), GLO required (G work orders), cable pull parts, and other pipe products tied to a key construction event.
- Prioritized drawing is marked with a highlighter into a logical installation breakdown. Each work sequence is a different color.
- The hanger planning is a separate activity. It does not involve any central planners or pipe shop planners.
- The work sequences are 40-100 hour packages established at definite breaks or easily worked units.

B5

NODE: ASIS/A1T	TITLE: Plan Work in Detail - Text Diagram	NUMBER: SFC13
-------------------	--	------------------

USED AT:	AUTHOR : Shop Floor Control Project	DATE: 12/13/90	X	WORKING	READER	DATE	CONTEXT: SFC2 A0
	PROJECT: sfc piping	REV.: 1/22/91		DRAFT			
	COMPANY: PETERSON BUILDERS, INC.			RECOMMENDED			
	NOTES : 1 2 3 4 5 6 7 8 9			PUBLICATION			

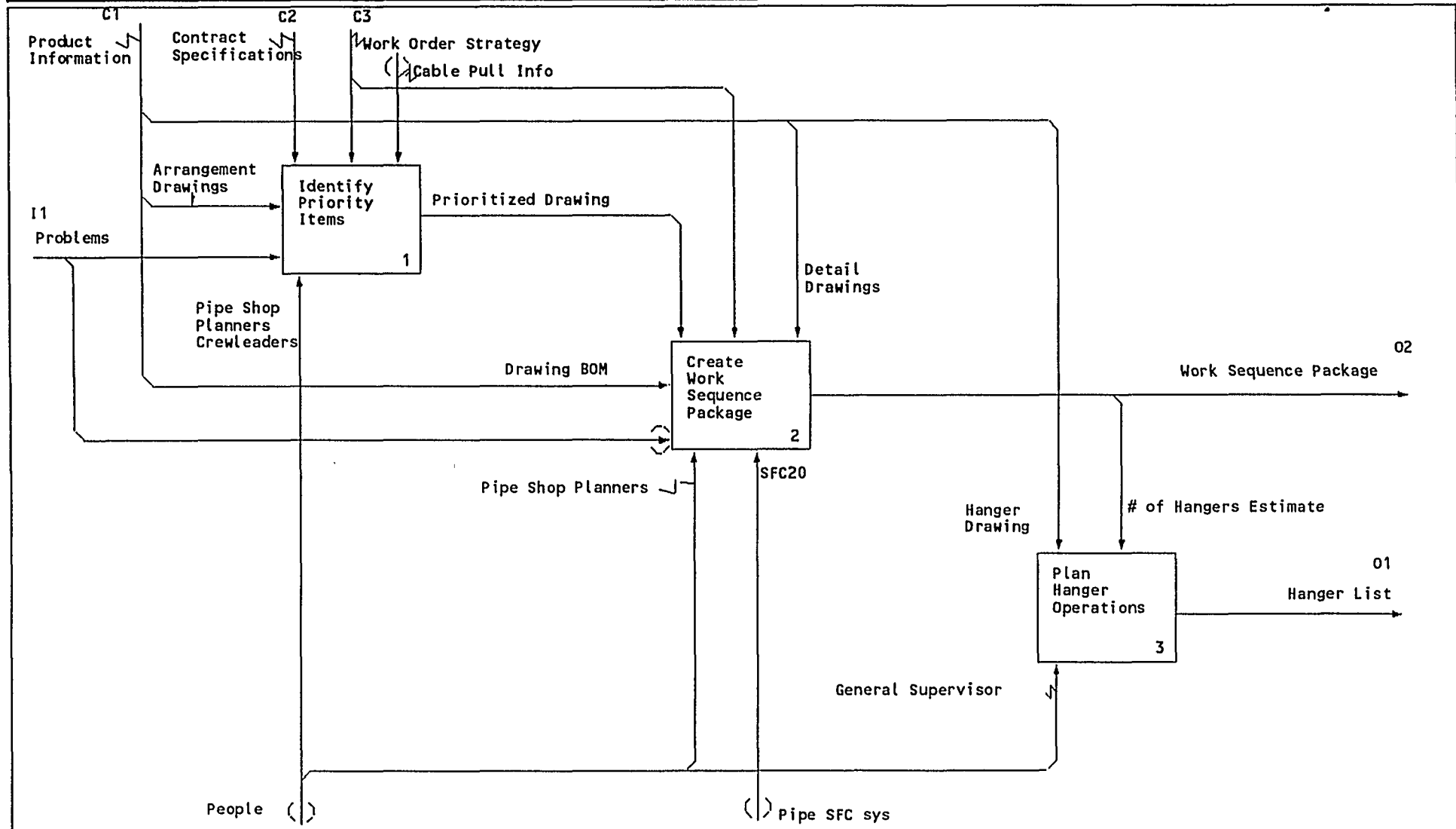

NODE: ASIS/A1	TITLE: Plan Work in Detail	NUMBER: SFC4
------------------	-------------------------------	-----------------

USED AT:	AUTHOR : Shop Floor Control Project	DATE: 12/21/90	X	WORKING	READER	DATE	<input type="checkbox"/> CONTEXT: SFC20 <input type="checkbox"/> <input type="checkbox"/> <input type="checkbox"/> <input type="checkbox"/> <input type="checkbox"/>
	PROJECT: sfcpipng	REV.: 5/27/92		DRAFT			
	COMPANY: PETERSON BUILDERS, INC.			RECOMMENDED			
	NOTES : 1 2 3 4 5 6 7 8 9			PUBLICATION			

A12

- The # of hangers estimate is based off one hanger for about every three feet of pipe.
- The work sequence packages are sent to central planning for the creation of work orders when a drawing has been completed.
- Assemble standard codes based on material - is the process of identifying which standard codes apply to the particular work sequence and the number of occurrences for each code.
- The standards associated with the "codes" include installation time.
- A work sequence number is a non-significant number only used once per SWBS.
- The work sequence cover sheet includes the sequence number, contract, hull, revision, drawings, ECN's, codes, a brief description and the details affected.
- The work sequence cover sheet is attached to other pertinent information such as the pipe detail sheets to create the work sequence package.

B7

NODE: ASIS/A12T	TITLE: Create Work Sequence Package - Text Diagram	NUMBER: SFC14	
--------------------	---	------------------	--

USED AT:	AUTHOR : Shop Floor Control Project	DATE: 1/22/91	X	WORKING	READER	DATE	CONTEXT: SFC4 <input type="checkbox"/> <input checked="" type="checkbox"/> <input type="checkbox"/>
	PROJECT: sfc piping	REV.: 5/28/92		DRAFT			
	COMPANY: PETERSON BUILDERS, INC.			RECOMMENDED			
	NOTES : 1 2 3 4 5 6 7 8 9			PUBLICATION			

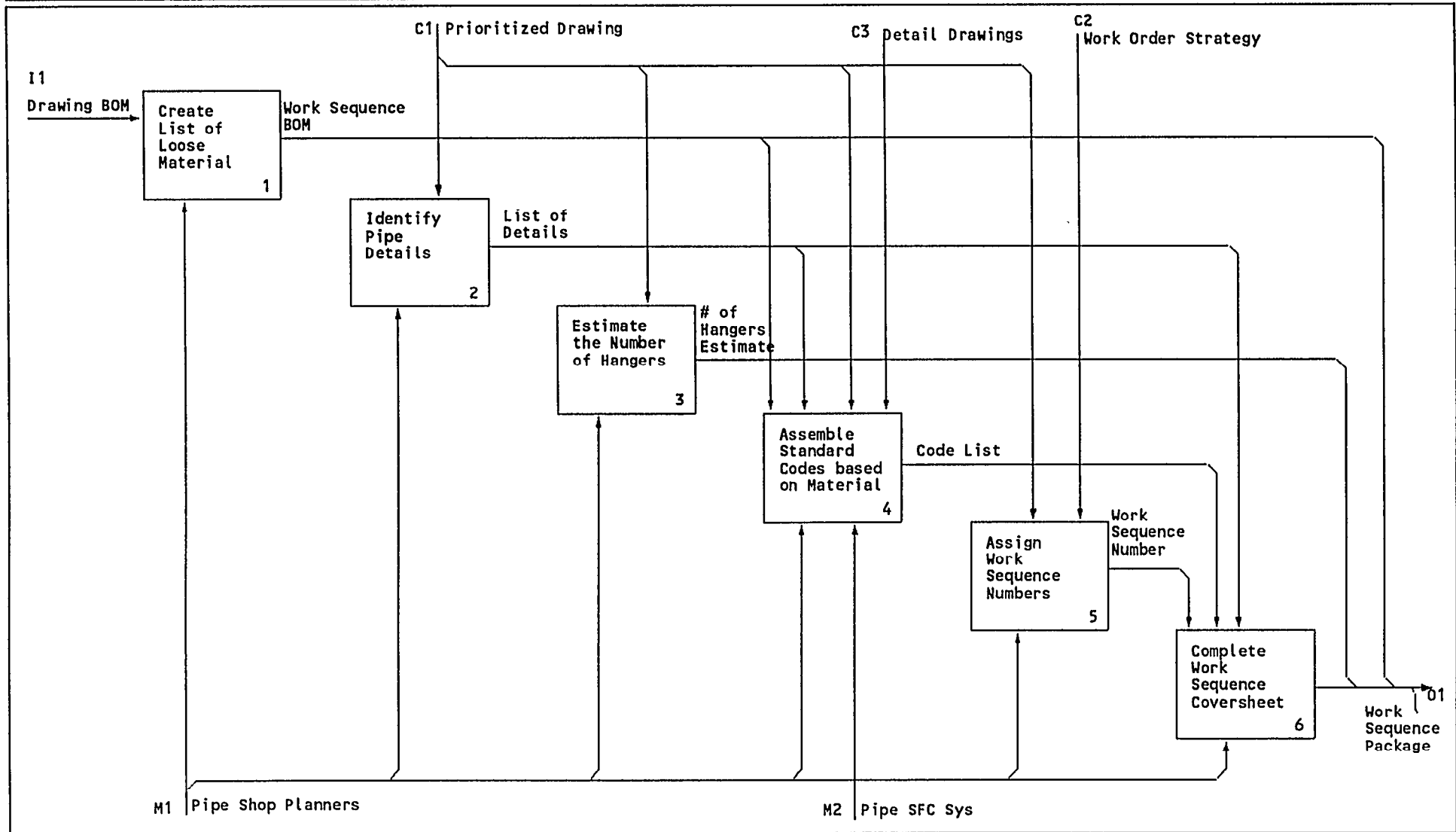

B8

NODE: ASIS/A12	TITLE: Create Work Sequence Package	NUMBER: SFC20
-------------------	--	------------------

USED AT:	AUTHOR : Shop Floor Control Project	DATE: 12/21/90	X	WORKING	READER	DATE	<input type="checkbox"/> CONTEXT: SFC3 <input type="checkbox"/> <input type="checkbox"/> <input type="checkbox"/> <input type="checkbox"/>
	PROJECT: sfcpipeg	REV.: 5/27/92		DRAFT			
	COMPANY: PETERSON BUILDERS, INC.			RECOMMENDED			
	NOTES : 1 2 3 4 5 6 7 8 9			PUBLICATION			

- The first step in the shop floor control system, for a new contract, is sequencing the drawings and developing schedules for the drawings and equipment. A strategy is also developed of how the work should be done.
- Sequence Drawings and Plan Work Order Strategy occur before work sequences are developed. Activities 3,4, and 5 occur after work sequences have been developed.
- In activity 1 the drawings are sequenced and scheduled as to when the drawings need to be completed by Engineering and when the pipe needs to be installed to meet key construction events.
- Each time all the work sequences have been established for a drawing, that drawing is sent back to the central planner. The central planner then groups the sequences into work orders. A scope, BOM, and budget are created for each work order.

B9

NODE: ASIS/A2T	TITLE: Process Work Order Information - Text Diagram	NUMBER: SFC15
-------------------	---	------------------

USED AT:	AUTHOR : Shop Floor Control Project	DATE: 12/13/90	X	WORKING	READER	DATE	<input type="checkbox"/> CONTEXT: SFC2 <input checked="" type="checkbox"/> <input type="checkbox"/> <input type="checkbox"/> <input type="checkbox"/>
	PROJECT: sfc piping	REV.: 1/08/91		DRAFT			
	COMPANY: PETERSON BUILDERS, INC.			RECOMMENDED			
	NOTES : 1 2 3 4 5 6 7 8 9			PUBLICATION			

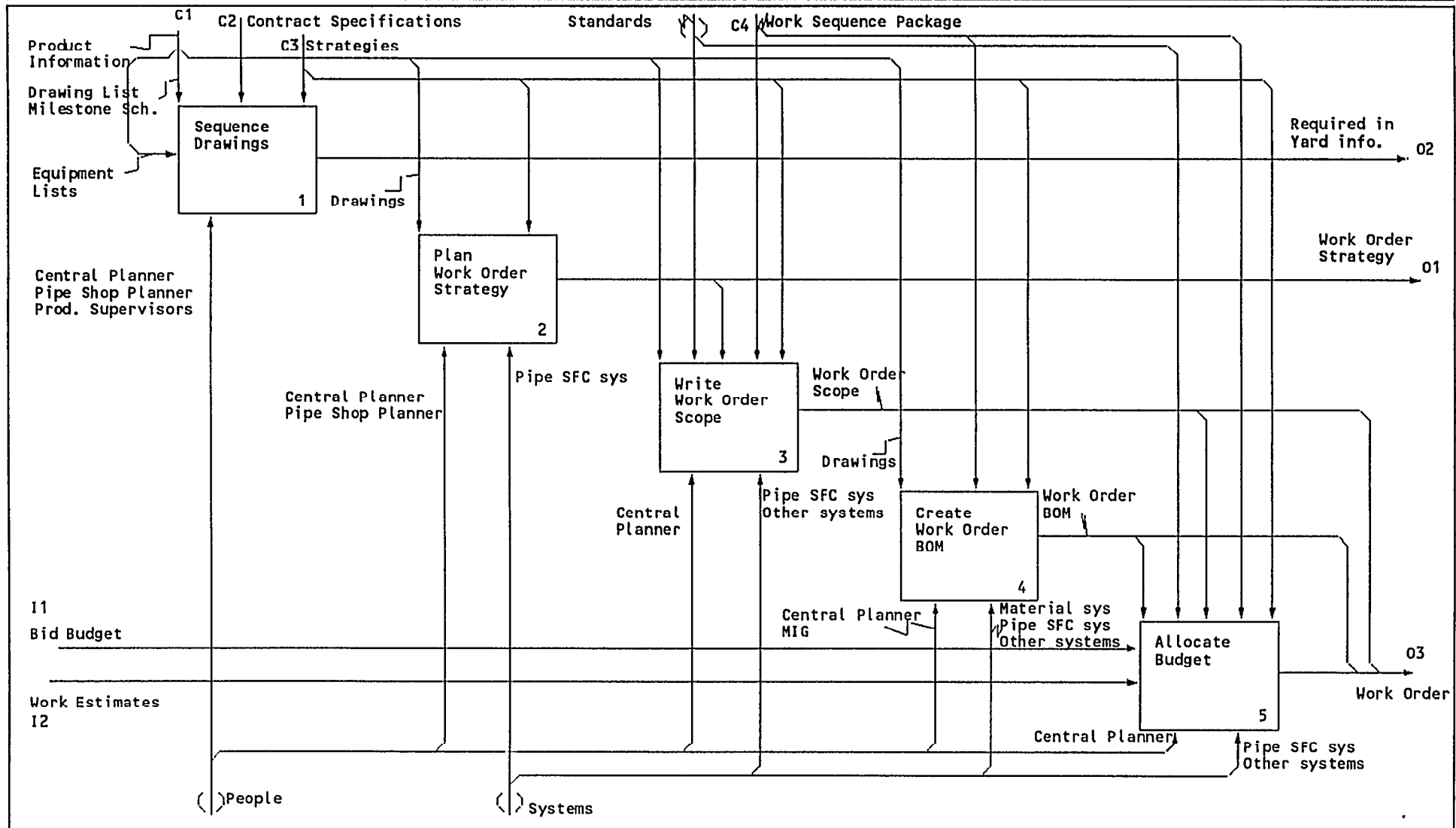

B10

NODE: ASIS/A2	TITLE: Process Work Order Information	NUMBER: SFC3
------------------	--	-----------------

USED AT:	AUTHOR : Shop Floor Control Project	DATE: 12/21/90	X	WORKING	READER	DATE	<input type="checkbox"/> CONTEXT: SFC5 <input type="checkbox"/> <input type="checkbox"/> <input type="checkbox"/>
	PROJECT: sfcpipng	REV.: 5/27/92		DRAFT			
	COMPANY: PETERSON BUILDERS, INC.			RECOMMENDED			
	NOTES : 1 2 3 4 5 6 7 8 9			PUBLICATION			

- Although the shop floor control software schedules the work for the shop the supervisors review the work sequences and other work occurring in the shipyard to prioritize work.
- Drawings, BOMs, work sequences, and resources are also reviewed before work is assigned to make there are no problems.
- In the fabrication area the material is placed on carts by work sequence numbers and eight hours worth of work. When a pipefitter or crew has finished their assignment they take the next cart in line.

B11

NODE: ASIS/A3T	TITLE: Assign Work and Allocate Resources - Text Diagram	NUMBER: SFC16	
-------------------	---	------------------	--

USED AT:	AUTHOR : Shop Floor Control Project	DATE: 12/13/90	X	WORKING	READER	DATE	<input type="checkbox"/> CONTEXT: SFC2 <input type="checkbox"/> <input checked="" type="checkbox"/> <input type="checkbox"/> <input type="checkbox"/> <input type="checkbox"/>
	PROJECT: sfc piping	REV.: 12/21/90		DRAFT			
	COMPANY: PETERSON BUILDERS, INC.			RECOMMENDED			
	NOTES : 1 2 3 4 5 6 7 8 9			PUBLICATION			

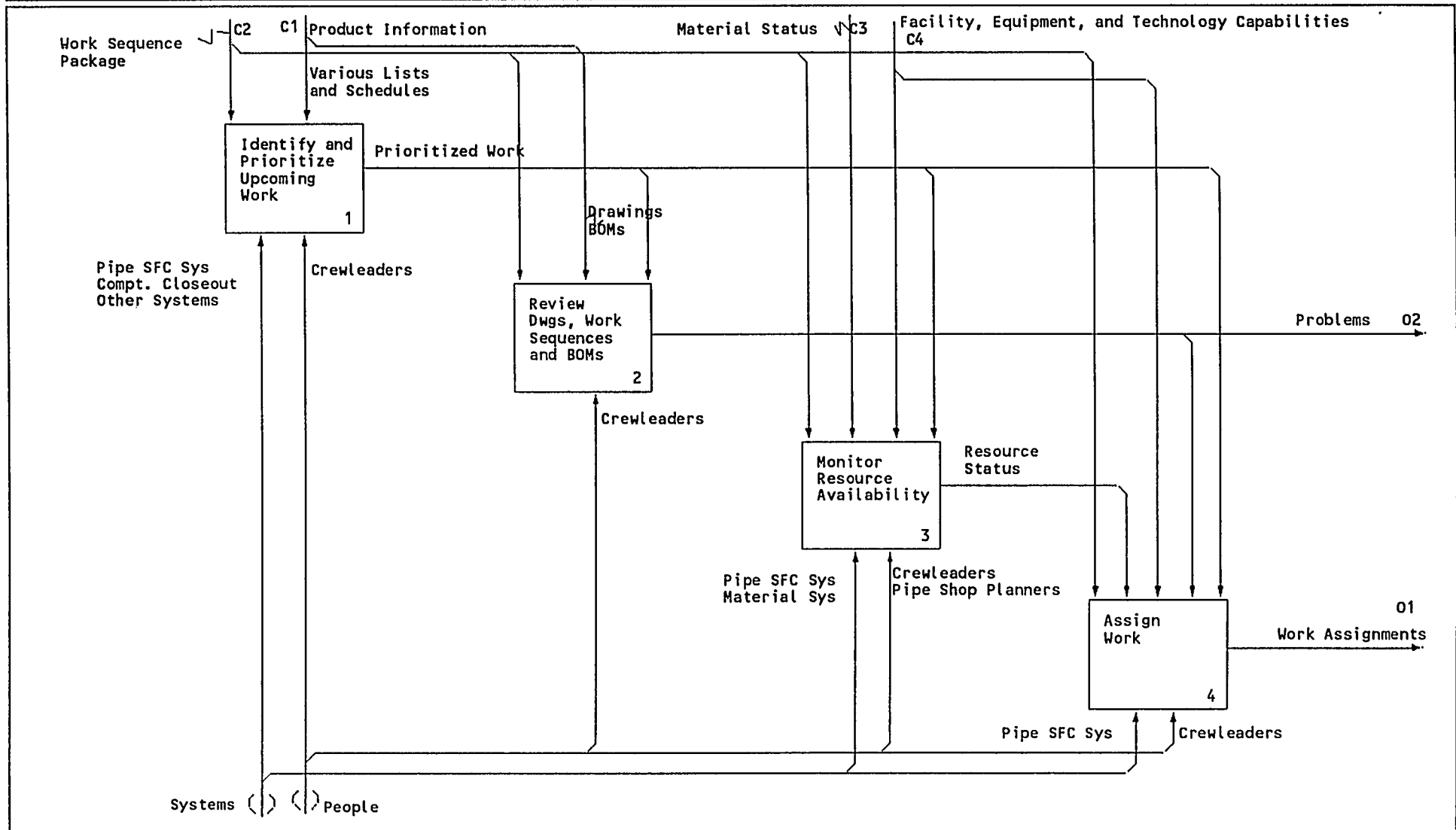

B12

NODE: ASIS/A3	TITLE: Assign Work and Allocate Resources	NUMBER: SFC5
------------------	--	-----------------

USED AT:	AUTHOR : Shop Floor Control Project	DATE: 12/21/90	X	WORKING	READER	DATE	<input type="checkbox"/> CONTEXT: SFC6 <input type="checkbox"/> <input type="checkbox"/> <input type="checkbox"/>
	PROJECT: sfcpiping	REV.: 5/27/92		DRAFT			
	COMPANY: PETERSON BUILDERS, INC.			RECOMMENDED			
	NOTES : 1 2 3 4 5 6 7 8 9			PUBLICATION			

- Work is not assigned unless all the necessary material is available.
- The shop requests the material from the warehouse by sending the pipe detail sheets and time cards. This lets the warehouse know what material is needed.
- The warehouse kits the material into eight hour packages, by work sequence, as defined on the time card (fabrication).
- Pipe installation obtains their material from the toolroom and waterfront storage.

B13

NODE: ASIS/A4T	TITLE: Obtain and Allocate Materials - Text Diagram	NUMBER: SFC17	
-------------------	--	------------------	--

USED AT:	AUTHOR : Shop Floor Control Project	DATE: 12/13/90	X	WORKING	READER	DATE	<input type="checkbox"/> CONTEXT: SFC2 <input type="checkbox"/> <input type="checkbox"/> <input checked="" type="checkbox"/> <input type="checkbox"/> <input type="checkbox"/>
	PROJECT: sfc piping	REV.: 1/22/91		DRAFT			
	COMPANY: PETERSON BUILDERS, INC.			RECOMMENDED			
	NOTES : 1 2 3 4 5 6 7 8 9			PUBLICATION			

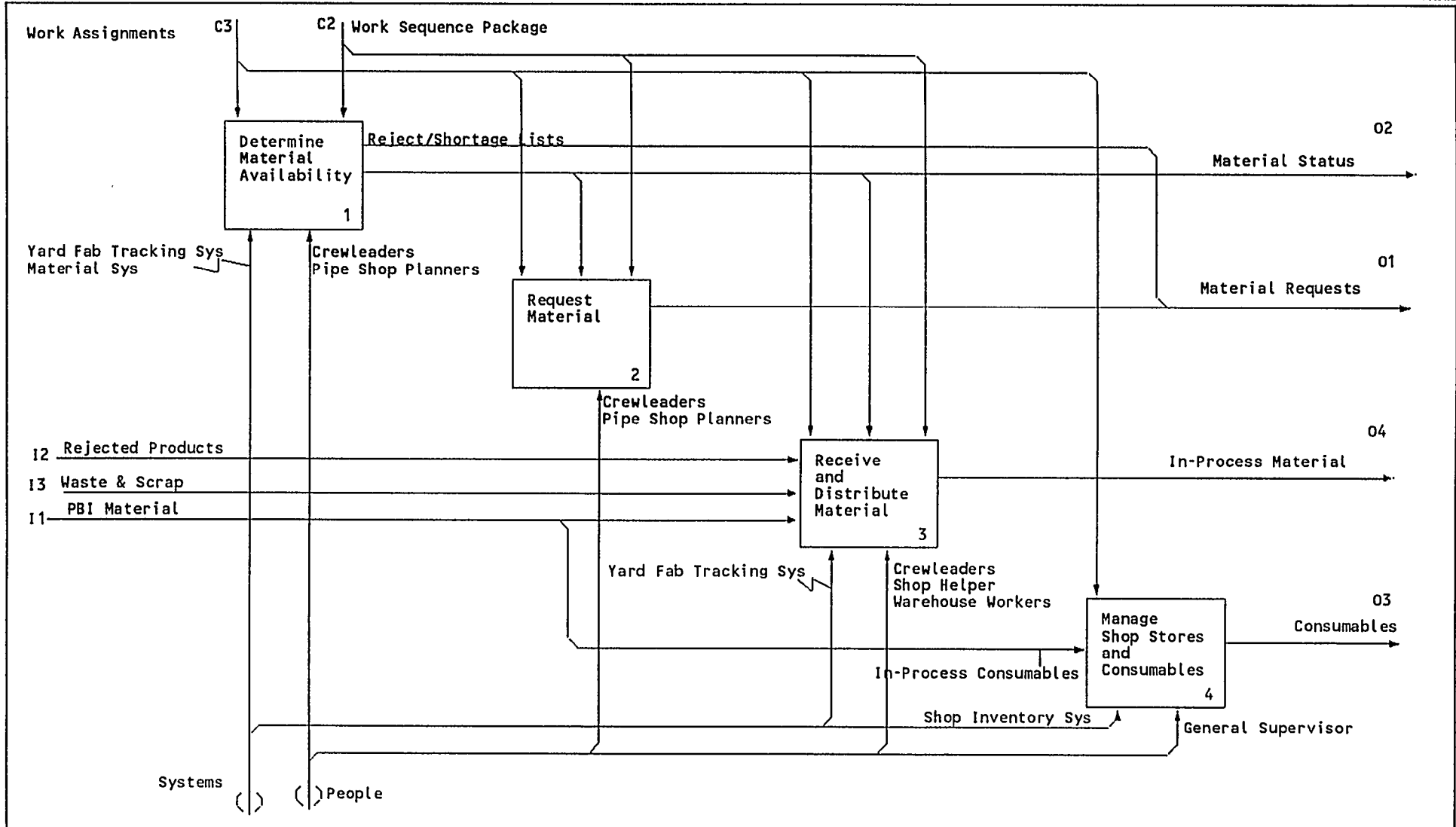

B14

NODE: ASIS/A4	TITLE: Obtain and Allocate Materials	NUMBER: SFC6
------------------	---	-----------------

USED AT:	AUTHOR : Shop Floor Control Project	DATE: 12/21/90	X	WORKING	READER	DATE	<input type="checkbox"/> CONTEXT: SFC7 <input type="checkbox"/> <input type="checkbox"/> <input type="checkbox"/>
	PROJECT: sfcpipng	REV.: 5/27/92		DRAFT			
	COMPANY: PETERSON BUILDERS, INC.			RECOMMENDED			
	NOTES : 1 2 3 4 5 6 7 8 9			PUBLICATION			

- Although there is an activity of Test and Inspect Products there is some inspection inherent in the fabrication and assembly processes.
- It should be noted that the Work Order is a control on the Test and Inspect Products activity because this activity is handled by a different department.
- The fabricators use special time cards which list everything they should be able to complete in an eight hour day. The shop has a system of codes for time charging which identify any problems.

B15

NODE: ASIS/A5T	TITLE: Execute Tasks - Text Diagram	NUMBER: SFC18	
-------------------	--	------------------	--

USED AT:	AUTHOR : Shop Floor Control Project	DATE: 12/17/90	X	WORKING	READER	DATE	<input type="checkbox"/> CONTEXT: SFC2 <input type="checkbox"/> <input type="checkbox"/> <input type="checkbox"/> <input checked="" type="checkbox"/> <input type="checkbox"/>
	PROJECT: sfc piping	REV.: 1/22/91		DRAFT			
	COMPANY: PETERSON BUILDERS, INC.			RECOMMENDED			
	NOTES : 1 2 3 4 5 6 7 8 9			PUBLICATION			

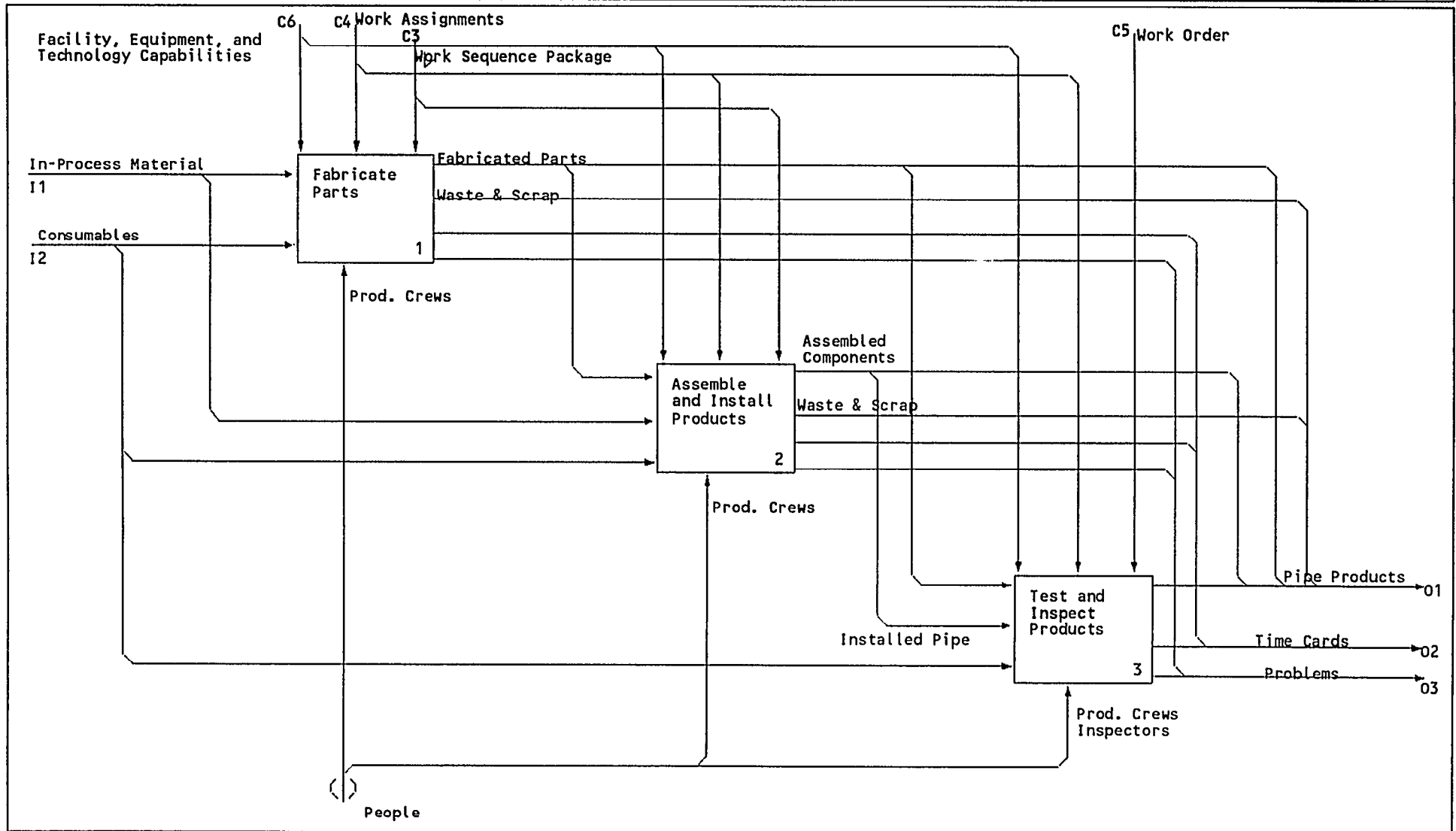

B16

NODE: ASIS/A5	TITLE: Execute Tasks	NUMBER: SFC7
------------------	-------------------------	-----------------

USED AT:	AUTHOR : Shop Floor Control Project	DATE: 12/21/90	X	WORKING	READER	DATE	<input type="checkbox"/> CONTEXT: SFCB <input type="checkbox"/> <input type="checkbox"/> <input type="checkbox"/>
	PROJECT: sfc piping	REV.: 5/27/92		DRAFT			
	COMPANY: PETERSON BUILDERS, INC.			RECOMMENDED			
	NOTES : 1 2 3 4 5 6 7 8 9			PUBLICATION			

- Unlike other shops in the shipyard, the Pipe shop enters their time charges in the shop, by a shop planner, after review by a supervisor.
- The shop uses standards to estimate both fabrication and installation work.
- Address problems is the activity of handling problems identified by supervisors, workers, or other shops.

B17

NODE: ASIS/A6T	TITLE: Develop Administrative Feedback - Text Diagram	NUMBER: SFC19	
-------------------	--	------------------	--

USED AT:	AUTHOR : Shop Floor Control Project	DATE: 12/13/90	X	WORKING	READER	DATE	<input type="checkbox"/> CONTEXT: SFC2 <input type="checkbox"/> <input type="checkbox"/> <input type="checkbox"/> <input type="checkbox"/> <input checked="" type="checkbox"/>
	PROJECT: sfcpipng	REV.: 1/02/91		DRAFT			
	COMPANY: PETERSON BUILDERS, INC.			RECOMMENDED			
	NOTES : 1 2 3 4 5 6 7 8 9			PUBLICATION			

B18

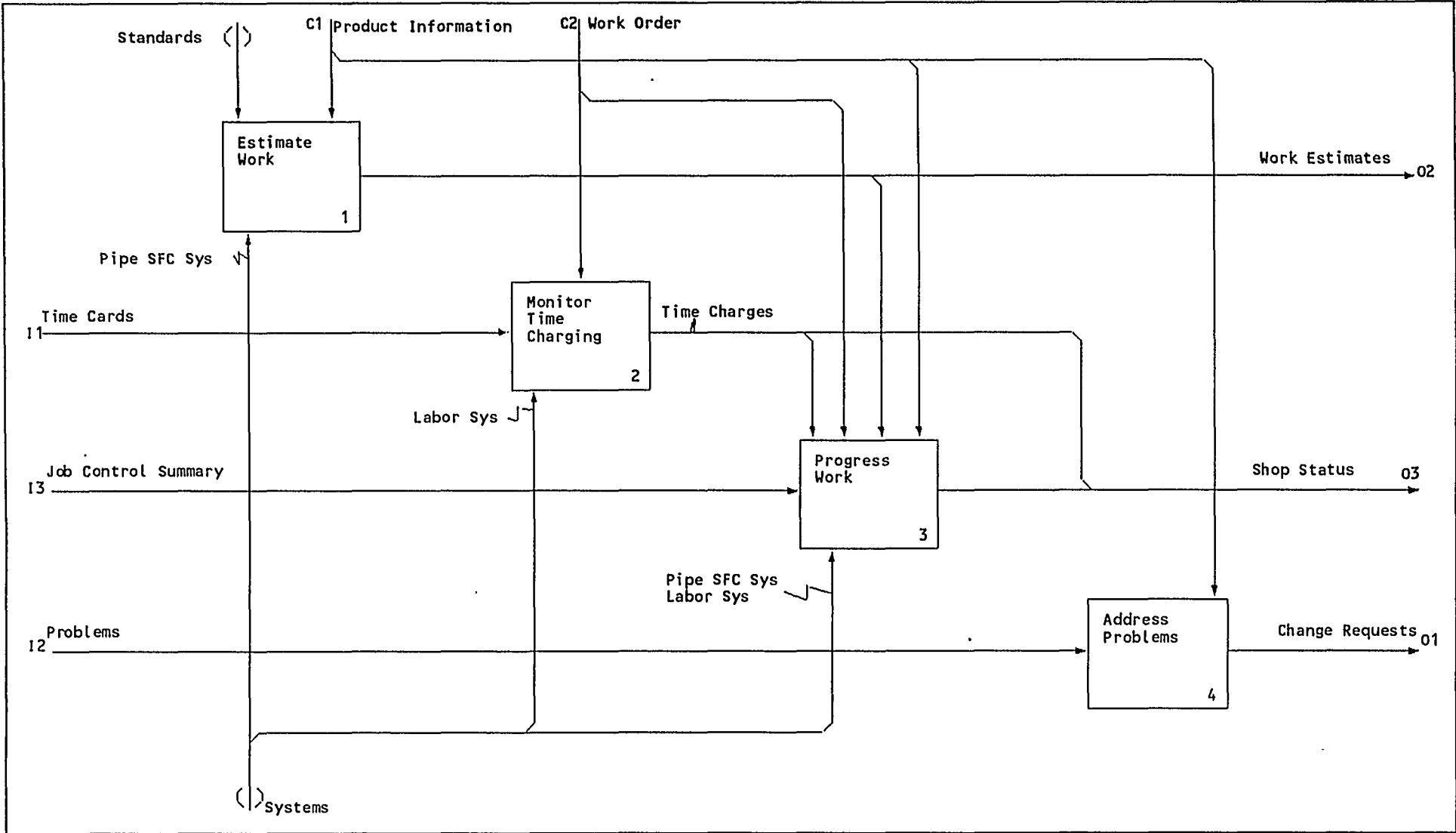

NODE: ASIS/A6	TITLE: Develop Administrative Feedback	NUMBER: SFC8
------------------	---	-----------------

USED AT:	AUTHOR :	DATE: 05/29/92	WORKING	READER	DATE	CONTEXT :
	PROJECT :	sfcpi pi ng	REV. :	DRAFT		
	COMPANY :	Peterson Builders, Inc.		RECOMHENDED		
	NOTES :	1 2 3 4 5 6 7 89		PUBLICATION		

#of Hangers Estimate

A rough guess of the number of hangers needed for a particular area based on the footage of pipe.

Address Problems

The activity of handling questions and discrepancies that arise during the manufacturing of pipe products.

Allocate Budget

To break the bid budget down into work order estimates.

Answer Variances

The activity of explaining differences between actuals and estimates.

Arrangement Drawings

Drawings which depict piping systems for a given area.

Assemble Standard Codes based on Material

The process of collecting information on what work needs to be done for a work sequence and assigning the correct standard code according to the material used.

Assemble and Install Products

The activities involved in joining parts or components and securing them in their final location.

Assembled Components

Parts or units which have been joined together to form a larger unit.

Assess Work Progress

Estimate the percentage of work which has been completed for a particular unit.

B19

NODE:	TITLE: GLOSSARY OF TERMS	NUMBER:	
-------	-----------------------------	---------	--

USED AT:	AUTHOR :	DATE: 05/29/92	WORKING	READER	DATE	CONTEXT:
	PROJECT : sfcpi pi ng	REV.:	DRAFT			
	COMPANY : Peterson Builders, 1 nc.		RECOMMENDED			
	NOTES : 1 2 3 4 5 6 7 8 9		PUBLI CATION			

Assign Work

The activity of delegating units of work to workers or a crew using information on the resources available.

Assign Work Sequence Numbers

To label a specific unit of work with a number according to its SWBS, drawing and sequence.

Assign Work and Allocate Resources

The activity of specifying what work is to be done and the material, equipment, manpower, etc. needed to do it.

BOM

An itemized list of materials and quantities.

Bid Budget

The estimated amount of resources, submitted on the bid, necessary to perform a scope of work.

Breakdown Work

The activity dividing and organizing the work to be performed into manageable units. Work can be broke down by drawing, compartment, zone, level, etc.

Cable Pull Info

Miscellaneous information and history on the cable pull. It could include information on the equipment, schedule, or knowledge from the electrical department superintendent.

Central Planner

PBI employees who identify and sequence work orders.

Change Requests

Notification that some aspect of the defined work is not producible.

B20

NODE :	TITLE: GLOSSARY OF TERMS	NUMBER :
--------	-----------------------------	----------

USED AT:	AUTHOR :	DATE : 05/29/92	WORKING	READER	DATE	CONTEXT :
	PROJECT: sfc piping	REV. :	DRAFT			
	COMPANY : Peterson Builders, Inc.		RECOMMENDED			
	NDTES : 1 2 3 4 5 6 7 8 9		PUBLICATION			

Code List

A tally of standard codes and the number of occurrences for a work sequence.

Complete Work Sequence Coversheet

The activity of filling out the coversheet and finish creating the work sequence package.

Compt. Closeout

A set of programs in the LAN to monitor the completion of compartments.

Consumables

Material that is "used up" in the process of manufacturing.

Contract Specifications

Legal commitments the company has, to perform work, in written specifications. May, include more general descriptions such as 'good shipbuilding practices'.

Create Work Order BOM

The activity of specifying which elements in a drawing BOM are needed for a specific unit of work.

Create List of Loose Material

The activity of developing the work sequence BOM.

Crewleaders

Production supervisors one level above the production crews.

Detail Drawings

Graphic and text diagrams of small sections of pipe.

Determine Material Availability

Includes the activities necessary to develop shortage and rejection lists of material needed to do a unit of work.

B21

NODE:	TITLE: GLOSSARY OF TERMS	NUMBER :	
-------	-----------------------------	----------	--

USED AT:	AUTHOR :	DATE: 05/29/92	WORKING	READER	DATE	CONTEXT :
	PROJECT: sfcpi pi ng	REV. :	DRAFT			
	COMPANY : Peterson Builders, Inc.		RECOMMENDED			
	NOTES : 1 2 3 4 5 6 7 8 9		PUBLI CATION			

Develop Admin. Feedback

Progressing work performed against budgets and estimates. This includes specifying when that work should be open for charges and when it has been completed.

Drawing BOM

An itemized list of items and their quantities.

Drawing List

A list of the drawings which together depict and describe a product.

Drawings

The representation of a product through graphics and text.

Equipment

Hardware items used to accomplish activities. Includes cranes, forklifts, computer workstations, etc.

Equipment Lists

Various lists of equipment such as GFE and the MOS.

Estimate Work

To assess how much labor, material, equipment, facilities, etc., is needed to accomplish a particular scope of work.

Estimate the Number of Hangers

The activity of calculating approximately how many hangers are needed for an area based on the footage of pipe.

Execute Tasks

Perform work directly associated with the fabrication, assembly, and finishing of in-process materials and finished goods.

B22

NODE:	TITLE: GLOSSARY OF TERMS	NUMBER :
-------	-----------------------------	----------

USED AT:	AUTHOR :	DATE: 05/29/92	WORKING	READER	DATE	CONTEXT :
	PROJECT: sfcpi pi ng	REV. :	DRAFT			
	COMPANY : Peterson Builders, Inc.		RECOMMENCED			
	NOTES : 1 2 3 4 5 6 7 8 9		PUBLICATION			

Fabricate Parts

To construct basic components for assembly and installation.

Fabricated Parts

Basic components constructed for installation or assembly.

Facilities

The buildings and grounds used by PBI to accomplish/perform activities.

Facility, Equipment, and Technology Capabilities

Facility, equipment, and technology availability, capacity, and limitations.

General Supervisor

A foreman of a production area.

Hanger Drawing

A NAVSEA drawing of hanger requirements.

Hanger List

An itemized list of hangers and their quantities.

Identify Pipe Details

The activity of recognizing the fabricated pipe components on a drawing.

Identify and Prioritize Upcoming Work

The activities necessary to determine what jobs are scheduled to be done and which jobs need to be done.

B23

NODE:	TITLE: GLOSSARY OF TERMS	NUMBER:	
-------	-----------------------------	---------	--

JSED AT:	AUTHOR :	DATE: 05/29/92	WORKING	READER	DATE	CONTEXT :
	PROJECT: sfcpi pi ng	REV. :	DRAFT			
	COMPANY : Peterson Builders, Inc.		RECOMMENDED			
	NOTES : 1 2 3 4 5 6 7 89		PUBLICATION			

In-Process Consumables

Consumables which have already been ordered and received by PBI which are then ordered from the warehouse by the shop.

In-Process Material

Assemblies, subassemblies, and other materials which are located at or near the work site.

Inspectors

People from the PBI QA department who look products over to determine whether they meet contract specifications.

Installed Pipe

Pipe which has been secured in its verified location, tested and inspected.

Job Control Summary

A general summation of the contracted activities to be performed. Includes dates of work, estimated hours, and percent work complete.

Labor Sys

A set of programs in the AS400 which store information on time charged to jobs,

List of Details

A table of all the details needed for a work sequence.

MIG

Material Identification Group

Manage Shop Stores and Consumables

The activities needed to receive, store and distribute, within the shop, consumables.

Manufacture and Install Piping

The activities necessary to plan and produce pipe systems at PBI.

B24

NODE:	TITLE: GLOSSARY OF TERMS	NUMBER:	
-------	-----------------------------	---------	--

USED AT:	AUTHOR :	DATE: 05/29/92	WORKING	READER	DATE	CONTEXT:
	PROJECT: sfc piping	REV.:	DRAFT			
	COMPANY: Peterson Builders, Inc.		RECOMMENDED			
	NOTES : 1 2 3 4 5 6 7 8 9		PUBLICATION			

Material Requests

The request for material that causes it to be released from a warehouse.

Material Status

The availability of material needed to perform work.

Material Sys

The AS400 set of programs which keep track of basic material information.

Milestone Schedule

The list of key events and their designated completion dates.

Monitor Resource Availability

The process of reviewing various information sources and determining if the necessary equipments, parts, material, etc. is available to complete a unit of work.

Monitor Time Charging

Reviewing time cards to ensure that numbers are valid and that cards have been completed correctly.

Obtain and Allocate Materials

The activity of managing the material within the shop.

Other Systems

Various computer and manual systems.

PBI Material

Materials in route to its location of use. PBI has already ordered, recieved, inspected and warehoused this material.

NODE:	TITLE: GLOSSARY OF TERMS	NUMBER:	
-------	-----------------------------	---------	--

USED AT:	AUTHOR :	DATE: 05/29/92	WORKING	READER	DATE	CONTEXT:
	PROJECT: sfc piping	REV.:	DRAFT			
	COMPANY: Peterson Builders, Inc.		RECOMMENDED			
	NOTES : 1 2 3 4 5 6 7 8 9		PUBLICATION			

People

The human resources employed to perform work in the interest of PBI. This includes employees, consultants, and sub-contractors.

Pipe Products

Any part or system made by the pipe shop.

Pipe SFC Sys

A set of programs in the AS400 which helps the pipe shop plan, monitor and control their work.

Pipe Shop Planners

People who do the more detailed planning for the pipe shop.

Plan Work Order Strategy

The process of deciding how work packages will be divided and numbered.

Plan Work in Detail

The activity of dividing work into short term manageable units.

Prioritized Drawing

A drawing which has been color coded highlighting the different work sequences.

Prioritized Work

A listing of the jobs which need to be done and the order in which they should be worked on.

Problems

An unsettled question which has been raised for consideration.

Process Work Order Information

The activities needed to plan and create work orders. These activities are basically performed by central planning.

NODE:	TITLE:	NUMBER:
-------	--------	---------

USED AT:	AUTHOR :	DATE: 05/29/92	WORKING	READER	DATE	CONTEXT:
	PROJECT: sfc piping	REV.:	DRAFT			
	COMPANY: Peterson Builders, Inc.		RECOMMENDED			
	NOTES : 1 2 3 4 5 6 7 8 9		PUBLICATION			

Prod. Crews

Production crews.

Prod. Supervisors

Those employees who oversee the production workers.

Product Information

This includes all the information necessary to fab and assemble a product. This would include drawings, bill of material, technical specifications, schedules, etc.

Progress Work

The process of analyzing the physical progress of a job and comparing it with the time charges and estimated time to come up with a estimate of the percent done and reporting this information.

Receive and Distribute Material

The process of acquiring material in the shop and dispersing it to the production crews as needed.

Reject/Shortage Lists

Tables of material or parts which are not suitable for their intended purpose or which are not available in the correct quantities.

Rejected Products

Products that do not meet contract requirements and require rework.

Request Material

The activity of asking for material by completing and submitting the necessary forms.

Required in Yard info.

Dates in which drawings, equipment, etc. need to be completed or available at PBI for use.

NODE:	TITLE: GLOSSARY OF TERMS	NUMBER:	
-------	-----------------------------	---------	--

USED AT:	AUTHOR :	DATE: 05/29/92	WORKING	READER	DATE	CONTEXT:
	PROJECT: sfcpijing	REV.:	DRAFT			
	COMPANY: Peterson Builders, Inc.		RECOMMENDED			
	NOTES : 1 2 3 4 5 6 7 8 9		PUBLICATION			

Resource Status

The availability of equipment, human skills and facilities.

Review Dwgs, Work Sequences and BOMs

The process of determining whether the necessary product information for a work sequence is available and correct.

Sequence Drawing

The activity of specifying what order the drawings are needed so that they are available when the work orders are scheduled to start.

Shop Helper

A production worker who has been assigned to assist with a certain part of the shop.

Shop Inventory Sys

A set of programs on the LAN which the pipe shop uses to keep track of the consumables and other shop stores.

Shop Status

The estimated physical progress towards completion for a specific scope of work.

Standards

Established time estimates for a particular task.

Standards and Procedures

Established estimates and methods for doing tasks.

Strategies

Tactics and plans developed by management to build boats in the most effective manner.

Systems

(Manual and Automated) - Coordination of information and activities using any means available.

USED AT:	AUTHOR :	DATE: 05/29/92	WORKING	READER	DATE	CONTEXT :
	PROJECT: sfc piping	REV. :	DRAFT			
	COMPANY : Peterson Builders, Inc.		RECOMMENDED			
	NOTES : 1 2 3 4 5 6 7 89		PUBLICATION			

Test and Inspect Products

To evaluate the fabricated pipe parts and completed systems for quality and adherence to contract specifications.

Time Cards

Reported time spent on a task.

Time Charges

The total time reported for a specific unit of work.

Various Lists and Schedules

Several different schedules and lists such as compartment closeout that are used to identify and prioritize work.

Warehouse Workers

PBI personnel who work for the warehouse department.

Waste & Scrap

The useable and unuseable material which is generated or remaining when a task has been completed.

Work Assignments

The delegation of who is responsible for a particular group of tasks.

Work Estimates

Anticipated labor, material, equipment, etc., needed to accomplish a particular scope of work.

Work Information

Work estimates and work orders.

B29

NODE:	TITLE: GLOSSARY OF TERMS	NUMBER:
-------	-----------------------------	---------

USED AT:	AUTHOR :	DATE: 05/29/92	WORKING	READER	DATE	CONTEXT :
	PROJECT: sfcpi pi ng	REV. :	DRAFT			
	COMPANY : Peterson Builders, Inc.		RECOMMENDED			
	NOTES : 1 2 3 4 5 6 7 8 9		PUBLICATION			

Work Order

Description of the dates, time, methods, and materials **needed to produce a product.**

Work Order BOM

A list of material which is assigned or allocated to a **work order.**

Work Order Scope

A written description of the tasks involved in a work order.

Work Order Strategy

Some general ideas or plan for. developing work orders for a particular contract. For example how the work will be divided and numbered.

Work Package

The information necessary to complete a task.

Work Sequence BOM

A list of all loose material needed for a work sequence package.

Work Sequence Number

The non-significant number used to identify a work sequence. A number is used only once per SWBS.

Work Sequence Package

A breakdown of work instructions in short term units.

Write Work Order Scope

The activity of defining the range of tasks involved within a unit of work.

Yard Fab Tracking Sys

A set of programs in the LAN which tracks items fabricated in-house for the pipe shop.

NODE :	TITLE: GLOSSARY OF TERMS	NUMBER:	
--------	-----------------------------	---------	--

B30

USED AT:	AUTHOR :	DATE: 05/29/92	WORKING	READER	DATE	CONTEXT :
	PROJECT : sfc piping	REV. :	DRAFT			
	COMPANY : Peterson Builders, Inc.		RECOMMENDED			
	NOTES : 1 2 3 4 5 6 7 89		PUBLICATION			

Yard Fab Tracking Sys Materzal Sys

A computerized method of inventorying parts which have been fabricated within PBI. This system is on TEAM-UP and located in the LAN.

B31

NODE:	TITLE: GLOSSARY OF TERMS	NUMBER:	
-------	-----------------------------	---------	--

THE NSRP NEEDS YOUR EVALUATION OF THIS REPORT!

PLEASE RETURN A RESPONSE CARD AFTER READING REPORT.

NSRP READER RESPONSE CARD

We would appreciate your comments on this report. Please take a few minutes to complete and return this postage-paid card. Thank you.

Name _____

Organization _____

Phone _____

• Overall Quality of Report

Excellent Good Fair Poor

• Usefulness to You/Your Organization

Very Useful Moderately Useful N/A

• Did/Will your organization implement the results of this project? Yes No

If not, why? _____

• How Did You Receive Report?

Mailed directly to you
 Referred to you by someone else

• Did/Will You Pass Report On To Someone Else?

Yes No

• In Your Opinion, Is Anything Missing That Would Make This Report Better?

Yes _____

• General Comments

NSRP 0347

NSRP READER RESPONSE CARD

We would appreciate your comments on this report. Please take a few minutes to complete and return this postage-paid card. Thank you.

Name _____

Organization _____

Phone _____

• Overall Quality of Report

Excellent Good Fair Poor

• Usefulness to You/Your Organization

Very Useful Moderately Useful N/A

• Did/Will your organization implement the results of this project? Yes No

If not, why? _____

• How Did You Receive Report?

Mailed directly to you
 Referred to you by someone else

• Did/Will You Pass Report On To Someone Else?

Yes No

• In Your Opinion, Is Anything Missing That Would Make This Report Better?

Yes _____

• General Comments

NSRP 0347



NO POSTAGE
NECESSARY
IF MAILED
IN THE
UNITED STATES

BUSINESS REPLY MAIL
FIRST CLASS MAIL PERMIT NO. 2635 SAN DIEGO CA

POSTAGE WILL BE PAID BY ADDRESSEE

NASSCO/NSRP PROGRAM MANAGER

ATTN: Les Hansen M.S. 20J
National Steel and Shipbuilding Co.
P.O. Box 85278
San Diego, CA 92186-5278



NO POSTAGE
NECESSARY
IF MAILED
IN THE
UNITED STATES

BUSINESS REPLY MAIL
FIRST CLASS MAIL PERMIT NO. 2635 SAN DIEGO CA

POSTAGE WILL BE PAID BY ADDRESSEE

NASSCO/NSRP PROGRAM MANAGER

ATTN: Les Hansen M.S. 20J
National Steel and Shipbuilding Co.
P.O. Box 85278
San Diego, CA 92186-5278



Additional copies of this report can be obtained from the National Shipbuilding Research Program Coordinator of the Bibliography of Publications and Microfiche Index. You can call or write to the address or phone number listed below.

NSRP Coordinator
The University of Michigan
Transportation Research Institute
Marine Systems Division
2901 Baxter Rd.
Ann Arbor, MI 48109-2150
Phone: (313) 763-2465
Fax: (313) 936-1081