



**NATURAL FREQUENCIES AND MODE
SHAPES OF A NONLINEAR, UNIFORM
CANTILEVERED BEAM**

THESIS

Daniel J. Marquez-Chisolm, Lieutenant, USAF

AFIT/GAE/ENY/06-S06

**DEPARTMENT OF THE AIR FORCE
AIR UNIVERSITY**

AIR FORCE INSTITUTE OF TECHNOLOGY

Wright-Patterson Air Force Base, Ohio

APPROVED FOR PUBLIC RELEASE; DISTRIBUTION UNLIMITED

The views expressed in this thesis are those of the author and do not reflect the official policy or position of the United States Air Force, Department of Defense, or the United States Government.

AFIT/GAE/ENY/06-S06

NATURAL FREQUENCES AND MODE SHAPES OF A NONLINEAR, UNIFORM
CANTILEVERED BEAM

THESIS

Presented to the Faculty

Department of Aeronautics and Astronautics

Graduate School of Engineering and Management

Air Force Institute of Technology

Air University

Air Education and Training Command

In Partial Fulfillment of the Requirements for the
Degree of Master of Science in Aeronautical Engineering

Daniel J. Marquez-Chisolm, BS

Lieutenant, USAF

September 2006

APPROVED FOR PUBLIC RELEASE; DISTRIBUTION UNLIMITED.

AFIT/GAE/ENY/06-S06

NATURAL FREQUENCIES AND MODE SHAPES OF A NONLINEAR, UNIFORM
CANTILEVERED BEAM

Daniel J. Marquez-Chisolm, BS
Lieutenant, USAF

Approved:

Donald L. Kunz (Chairman)

date

Maj. Eric D. Swenson (Member)

date

Richard G. Cobb (Member)

date

Abstract

A series of experiments in 1975, referred to as the Princeton Beam Experiments, were performed to measure natural frequencies and create a nonlinear elastic deformation model to improve helicopter main beam designs. These experiments used a uniform, homogeneous 7075 aluminum beam and have been referenced as a baseline for the past thirty years to validate computer models and theories in an effort to build beams capable of withstanding aero elastic, static, and dynamic loading.

The purpose of this study is to measure the dynamic nonlinear bending and torsion response of a cantilever beam. The natural frequencies are measured in the flatwise and edgewise directions at different static root pitch angles with varying levels of tip weights. The measured natural frequencies were compared to linear equations of motion, a nonlinear computer model and previous experiments to verify the nonlinear effects of root pitch angle and tip weights.

The experiment produced promising results in that the first mode in the edgewise and flatwise directions were within the error bands of the Princeton Beam Experiment for all weights and that the linear model matched the experimental case with no tip weights. Further experimentation is needed in order to properly calculate the edgewise frequencies and estimate mode shapes.

AFIT/GAE/ENY/06-S06

To The Instructors Who Have Inspired Me To Get This Far.

Acknowledgments

I like to express my appreciation to Dr. Kunz (advisor), Andy Cottle (Intern) and my friends and colleagues. Without their help and encouragement I would not have been able to finish this project.

Daniel J. Marquez-Chisolm

Table of Contents

Abstract.....	iv
Acknowledgments	vi
List of Figures.....	viii
List of Tables	x
List of Symbols.....	xi
1. Introduction.....	1
1.1 Princeton Beam Experiment.....	1
1.2 Purpose	1
2. Literature Review	3
2.1 The Princeton Beam Experiments.....	3
2.2 Princeton Beam References.....	5
2.2.1 Rotorcraft Dynamics Division (1987)	5
2.2.2 Hopkins and Ormiston (2003)	5
2.2.3 Hodges (2005).....	6
2.2.4 Laulusa.....	6
2.2.5 Whiting	7
3. Methodology.....	9
3.1 Experimental Components	9
3.1.1 Beams.....	9
3.1.2 Tip Weights.....	10
3.1.3 Swiveling Hub	13
3.1.4 Inclinometer	15
3.1.5 Excitation Force.....	15
3.1.6 Laser Vibrometer	16
3.2 Experiment	18
3.2.1 Beam Preparation.....	18
3.2.2 Procedure	18
3.3 Linear Equations of Motion	23
3.4 Finite Element Analysis	24
4. Results and Analysis.....	25
4.1 Frequency Analysis.....	25
4.2 Mode Shape Analysis.....	32
4.2.1 Mode Shape of No Tip Weight.....	37
4.2.2 Mode Shapes of One Pound Tip Weight	40
4.2.3 Mode Shape of Three Pound Tip Weight	43
5. Discussion.....	47
5.1 Conclusion and Recommendations	47
Appendix A: Raw Data for Frequencies` Below 250 Hz	50
Appendix B: MathCad File for Linear Theory [8]	187
Appendix C: Nastran Input Files	191
Bibliography	192

List of Figures

	Page
Figure 1: Axis and Angular System of Experiment [11]	3
Figure 2: Side view of Beam #2 [11].....	4
Figure 3: Flatwise Frequency vs. Pitch Angle [15]	7
Figure 4: Edgewise Frequency vs. Pitch Angle [15]	8
Figure 5: Initial Tip Deflection Due to Machining [11]	10
Figure 6: Weight Cross Sections [15].....	11
Figure 7: Tip Weights [15]	12
Figure 8: Moment of Inertia Equation Variables [15]	13
Figure 9: Swiveling Hub Attachment [11].....	14
Figure 10: Directional Orientation [11]	14
Figure 11: Excitation Force	16
Figure 12: 3-D Laser Vibrometer Setup	17
Figure 13: Swiveling Hub Attachment	19
Figure 14: Grid Points Tested During a 3 Pound Tip Weight at 0° Root Pitch Angle	20
Figure 15: FFT and Coherence Plot for No Tip Weight and 0° test.....	21
Figure 16: Coherence and FFT with no Tip Weight and at 0° Root Pitch	26
Figure 17: Frequency Comparison for Experimental and Linear Equations for No Tip Weight.....	27
Figure 18: Coherence and FFT with One Pound Tip Weight and at 0° Root Pitch.....	28
Figure 19: Frequency Comparison for Experimental and Linear Equations for a One Pound Tip Weight.....	29
Figure 20: Coherence and FFT with Three Pound Tip Weight and at 0° Root Pitch.....	30
Figure 21: Frequency Comparison for Experimental and Linear Equations for a Three Pound Tip Weight.....	31
Figure 22: Mode Shape for No Tip Weight at Zero Degree Root Pitch Angle With a 60Hz Frequency.....	33
Figure 23: Mode Shape for No Tip Weight at 15 Degree Root Pitch Angle With a 60Hz Frequency.....	33
Figure 24: Mode Shape for No Tip Weight at 45 Degree Root Pitch Angle With a 60Hz Frequency.....	34
Figure 25: Frequencies Corresponding to Figures 22-24	34
Figure 26: Mode Shape for Three Pound Tip Weight at 30 Degree Root Pitch Angle with a 160Hz Frequency	35
Figure 27: Mode Shape for Three Pound Tip Weight at 15 Degree Root Pitch Angle with a 149.4Hz Frequency	36
Figure 28: Mode Shape for Three Pound Tip Weight at Zero Degree Root Pitch Angle at 154.4Hz.....	36
Figure 29: Frequencies Corresponding to Figures 26-28	37
Figure 30: 2nd Mode Shape for the Beam at Varying Root Pitch Angles.....	38
Figure 31: 3rd Mode Shape for the Beam at Varying Root Pitch Angles	38
Figure 32: 4th Mode Shape for the Beam at Varying Root Pitch Angles.....	39
Figure 33: 5th Mode Shape for the Beam at Varying Root Pitch Angles.....	39

Figure 34: 2nd Mode Shape for the Beam at Varying Root Pitch Angles with a One Pound Tip Weight	40
Figure 35: 3rd Mode Shape for the Beam at Varying Root Pitch Angles with a One Pound Tip Weight	41
Figure 36: 4th Mode Shape for the Beam at Varying Root Pitch Angles with a One Pound Tip Weight	41
Figure 37: 5th Mode Shape for the Beam at Varying Root Pitch Angles with a One Pound Tip Weight	42
Figure 38: 6th Mode Shape for the Beam at Varying Root Pitch Angles with a One Pound Tip Weight.....	42
Figure 39: 2nd Mode Shape for the Beam at Varying Root Pitch Angles with a Three Pound Tip Weight.....	44
Figure 40: 3rd Mode Shape for the Beam at Varying Root Pitch Angles with a Three Pound Tip Weight.....	44
Figure 41: 4th Mode Shape for the Beam at Varying Root Pitch Angles with a Three Pound Tip Weight.....	45
Figure 42: 5th Mode Shape for the Beam at Varying Root Pitch Angles with a Three Pound Tip Weight.....	45
Figure 43: 6th Mode Shape for the Beam at Varying Root Pitch Angles with a Three Pound Tip Weight.....	46

List of Tables

	Page
Table 1: Tip Weight Dimensions	11
Table 2: Moment of Inertia Calculations	13
Table 3: Angles and Weight Configuration of Testing.....	22
Table 4: Modal Frequencies No Tip Mass at 0° Root Pitch	26
Table 5: Modal Frequencies One Pound Tip Mass 0° Root Pitch	28
Table 6: Modal Frequencies Three Pound Tip Mass at 0° Root Pitch	31
Table 7: Corresponding Frequencies to the Mode Shapes Found in Figure 30-33	40
Table 8: Frequencies Corresponding to Mode Shapes from Figures 34-38	43
Table 9: Frequencies Corresponding to Mode Shapes from Figures 39-43	46

List of Symbols

d_A = distance from A section mass center to weight mass center (in)

d_B = distance from B section mass center to weight mass center (in)

d_S = distance from solid section mass center to weight mass center (in)

I_{xx} = moment of inertia about the x-axis (lb-in²)

I_{yy} = moment of inertia about the y-axis (lb-in²)

I_{zz} = moment of inertia about the z-axis (lb-in²)

L_A = length A section (in)

L_B = length B section (in)

L_S = length solid section (in)

M_A = mass of A section (lb)

M_B = mass of B section (lb)

M_S = mass of solid section (lb)

R_{iA} = inner radius of A section (in)

R_{iB} = inner radius of B section (in)

R_{iS} = inner radius of solid section (in)

R_o = outer radius (in)

Hz = Hertz

RCAS = Rotorcraft Comprehensive Analysis System

NATURAL FREQUENCES AND MODE SHAPES OF A NONLINEAR, UNIFORM CANTILEVERED BEAM

1. Introduction

1.1 Princeton Beam Experiment

The Princeton Beam Experiments are a pair of tests performed by Dowell and Traybar in 1975 [1]. These tests have been a baseline for nonlinear effects on a homogeneous rotor blade with varying pitch angle and tip load. The Princeton Beam Experiment measured the first natural frequency and nonlinear deformation of a beam undergoing flap, lag and twist. The tests were completed on three different beams made of Aluminum 7075. The results of this test have been used to validate analytical models even to this day. Due to the rudimentary technology used in 1975 the measurement technique was inaccurate. Some of the inaccuracies are caused by the general lack of precision of the instruments used and the instrumentation having to be placed on the beam itself. Current technology allows the opportunity for more precise contact-free measurements of all displacement and frequency measurements. These contact-free instruments will enable determination of a more accurate baseline for rotor designers to compare with their analytical results.

1.2 Purpose

The purpose of this experiment is to expand upon the Princeton Beam Experiments completed by Dowell and Traybar. In Dowell and Traybar's experiment, they measured displacements and the first natural frequency in both the flatwise and edgewise directions. The experiment for this thesis will seek to measure higher order

frequencies and estimate the mode shapes at these frequencies using a 3-D laser vibrometer.

The procedures used in the investigation for this thesis are documented accurately so that future validation can be re-accomplished. The natural frequencies measured will be validated with the Princeton Beam Experiment data, linear equations of motion, and a nonlinear finite element model in Nastran.

2. Literature Review

2.1 The Princeton Beam Experiments

In 1975, Dowell and Traybar completed a series of tests called the Princeton Beam Experiments which was funded by the U.S. Army Air Mobility Research and Development Laboratory, Ames Research Center. The Princeton Beam Experiment investigated the dynamic and static responses of a rotor blade experiencing flap, lag and twist deformations at pitch angles ranging from 0° to 180° . The investigation was meant to “support the validity [of]...nonlinear structural theory for rotor blade applications” [1:ii]. Figure 1 shows the axis and angular systems used by Dowell and Traybar.

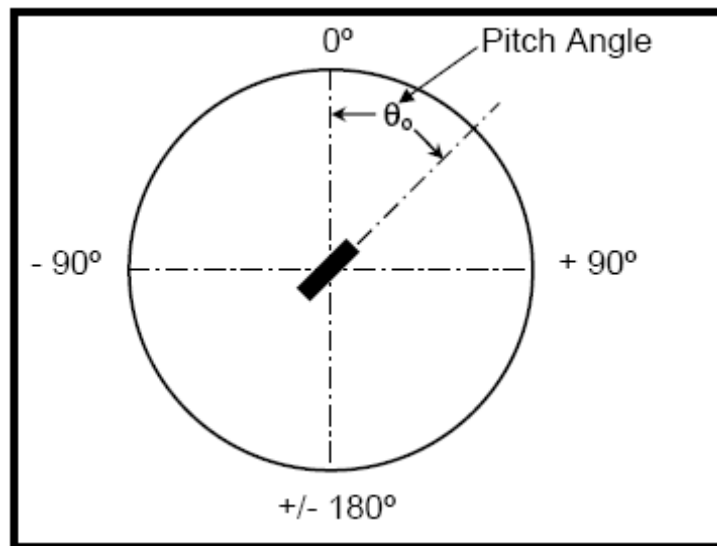

Figure 1: Axis and Angular System of Experiment [11]

The pitch angle is determined from the root of the beam since the tip angle will change when tip weights are added.

The Princeton Beam Experiment consisted of two components: static tests and dynamic tests. Both components used a homogeneous cantilever beam that had different tip weights applied to the free end of the beam. The beam was then tested at varying root pitch angles. The Princeton Beam Experiment used three different beams made from

7075-T6 aluminum. For the static component, the beam was loaded with the various tip weights and for the twenty inch beam the displacement was measured every five inches from the root, as shown in Figure 2. A beam made of 7075-T6 aluminum bending will not be completely straight due to the processing of the aluminum. Looking at Dowell and Traybar's data, the natural bending was dealt with by measuring the displacements relative to the unloaded static state. From the literature, the method Dowell and Traybar used to measure displacements was to project a light over the beam to cast a shadow on graphing paper and then use a ruler to measure the displacement.

The dynamic component tests were an effort to determine the nonlinear effects of a tip weight and varying root pitch angles would have on the natural frequency of the beam. The dynamic portion of the Princeton Beam Experiment was completed using two beams. The beam of interest for this thesis investigation is the beam with a length of 20". Figure 2 shows a side view of the beam.

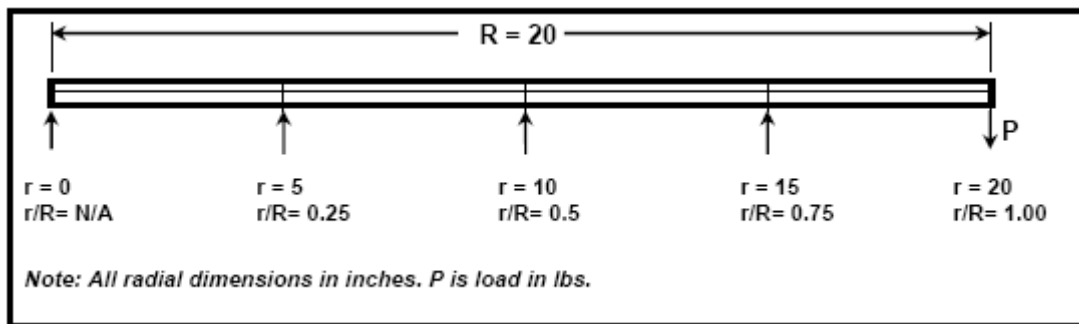

Figure 2: Side view of Beam #2 [11]

The first mode was excited by using a finger to flick the beam in either the flatwise or edgewise direction. Using strain gauges mounted to the tip root, frequency data was recorded. The Princeton Beam Experiments, even with rudimentary technology have been accepted by the engineering community as a baseline for the nonlinear response of a

beam. In 1975, the available technology was not capable of making more accurate measurements [1].

2.2 Princeton Beam References

The results from the Princeton Beam Experiments have been used since the test was completed in 1975 as a baseline for nonlinear effects on a beam. The 30 year history consists of many computer programs and theories that have been compared to the Princeton Beam Experiments for validation. Hodges used the data collected from these experiments as recently as 2005 [4].

2.2.1 Rotorcraft Dynamics Division (1987)

The U.S. Army Aeroflightdynamics Directorate Rotorcraft Dynamics Division developed the General Rotorcraft Aeromechanical Stability Program (GRASP) [5]. Those involved in the study were Hodges, Hopkins, Kunz and Hinnant. The GRASP was designed to analyze beam aero elastic, static and dynamic deflections with and without loads. The output from the GRASP was compared to the Princeton Beam Experiments for validation and had results which were very similar to the Princeton Beam Experiments with an average error of 0.5%.

2.2.2 Hopkins and Ormiston (2003)

Hopkins and Ormiston validated the beam element which was implemented in a program called Rotorcraft Comprehensive Analysis System (RCAS) [7]. The RCAS is an analytical tool to calculate rigid and flexible body kinematics. The software output was compared to the Princeton Beam Experiment results for the 20" 7075-T6 Aluminum

beam, Maryland vacuum chamber experiments and UH-60 flight test data [7]. Through these comparisons, it was found that the RCAS software adequately predicted elastic beam deformations and that the software can also be used for varying cross section and material properties.

2.2.3 Hodges (2005)

Hodges tried to propose a beam theory that would be adequate for modeling composite rotor blades that could be useful and tractable [4:51]. Similar to the Princeton Beam Experiments and RCAS, Hodges was trying to produce a modern beam theory which accurately analyzed static deflection, estimating natural frequencies, mode shapes, dynamic stability and aero elastic stability under specified loads and buckling loads while recovering the 3-D stresses for a variety of geometries and material properties. Hodges never directly mentioned the comparison to the Princeton Beam data; however, his theory did include the work by Hopkins and Ormiston and the RCAS computing system which was verified with the Princeton Beam Experiments.

2.2.4 Laulusa

Laulusa created a “beam-type finite element method” to evaluate static deflection and predict natural frequencies for small vibrations [9]. The results of his theoretical model and numerical code were compared with the experimental studies of Dowell, Traybar and Hodges [3]. Laulusa’s tip deflection measurements showed “very good agreement” with the numerical results except for cases with large tip deflections [9:14-17].

2.2.5 Whiting

Whiting completed research using the laser vibrometer setup used in this investigation to try and duplicate the Princeton Beam Experiment. Whiting's experiment was done in order to get better data and at the same time was a way to validate the experimental technique. He showed that using the laser vibrometer, with the correct error bars, the data with the Princeton Beam Experiment matched very well. This shows that the experimental technique proves to be correct and that the test is measuring the correct thing. In his research he measured the first natural frequency of the beam with different tip masses. In Figures 3 and 4, plots can be seen of the Princeton Beam Experiment first mode natural frequencies in the flap and chord directions at different angles compared to data that he collected.

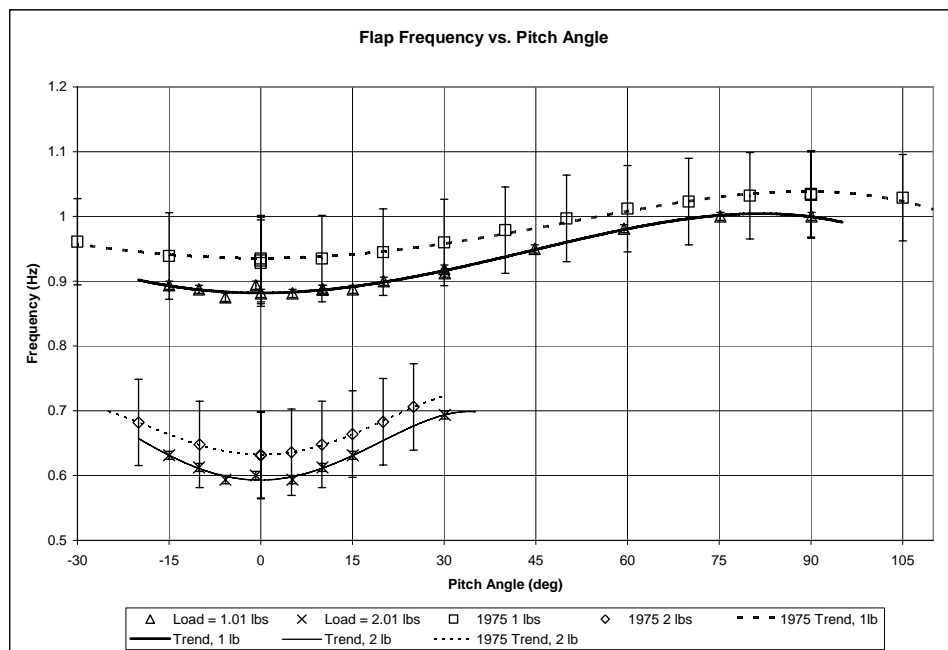

Figure 3: Flatwise Frequency vs. Pitch Angle [15]

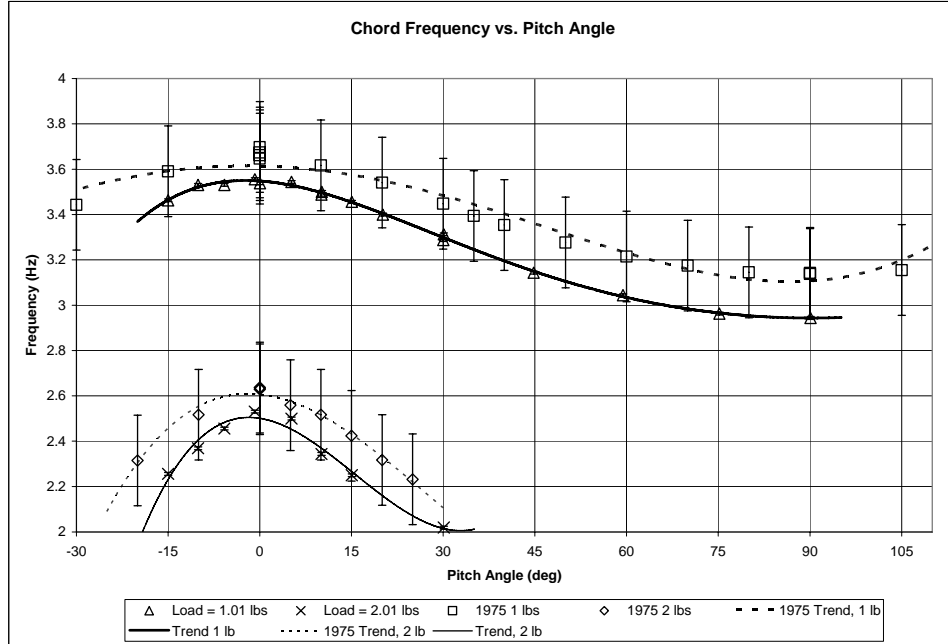

Figure 4: Edgewise Frequency vs. Pitch Angle [15]

In Whiting's research, he calculated the error bands by using the root mean squared method shown below:

$$E = \left(\frac{e_1^2 + e_2^2 + \dots + e_n^2}{n} \right)^{0.5} \quad (1)$$

Where E is the total error and e_i is the error from each source. The sources of error in this experiment come from the digitizing process, frequency resolution and instrument accuracy. The frequency resolution in the Princeton Beam Experiment was ± 0.06667 Hz in the flatwise direction, and ± 0.10 Hz in the chordwise direction.

3. Methodology

The research for this thesis is designed to build upon the Princeton Beam Experiment by calculating higher order natural frequencies and estimate mode shapes of a homogeneous uniform cantilever beam. For this reason, the setup for this investigation will mimic Dowell and Traybar's experiment by using similar weights and a beam of the same material and dimensions that were used in the Princeton Beam Experiment.

3.1 Experimental Components

3.1.1 Beams

The Princeton Beam Experiment used two different beams for the dynamic portion of the test, one 20" in length and the other 30" in length made from a sheet of 7075-T6 aluminum with a thickness of 1/8". The beam of interest for the investigation in this thesis is the beam with a length of 20". The beam has a manufactured length of 24" (20" of cantilever), is 1/2" wide and is 1/8" thick. Due to the machining procedure, the beam was visibly warped. Figure 5 shows initial deflection of the beam which was measured by McGraw [11]. The center of the tip was tapped for a 1/16" diameter screw to keep the various tip weights attached, which are described in the next section.

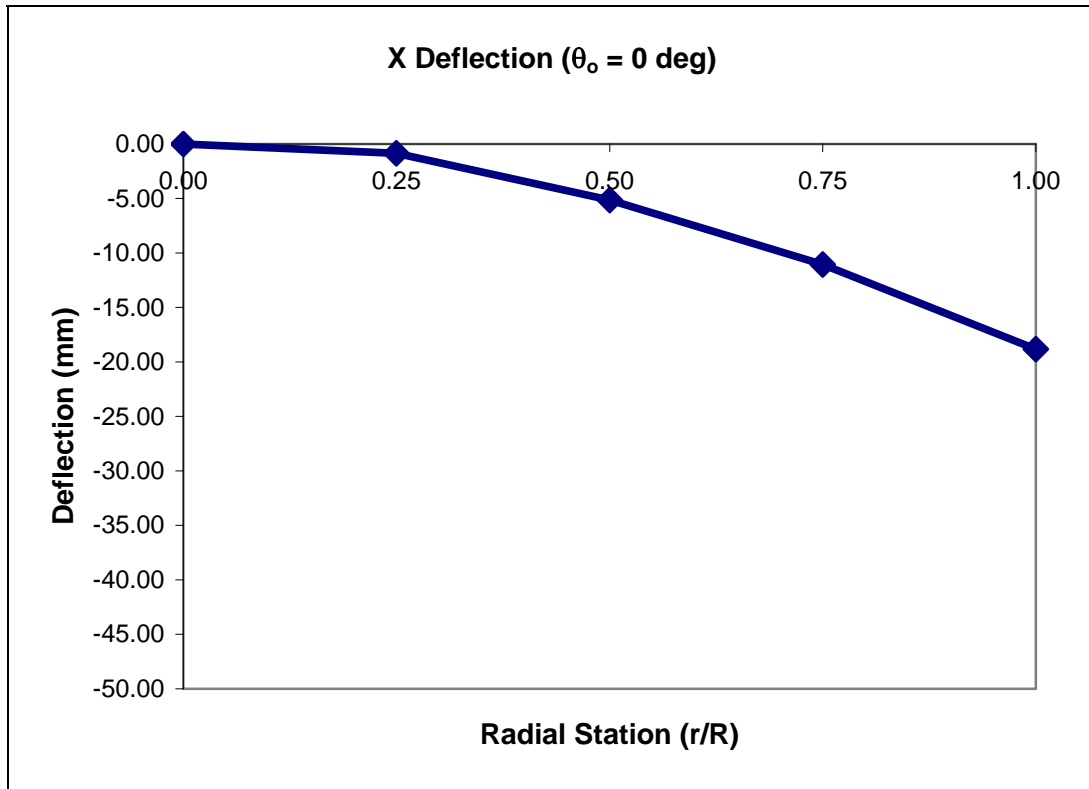

Figure 5: Initial Tip Deflection Due to Machining [11]

3.1.2 Tip Weights

Four cylindrical steel weights were made varying from one to four pounds in one pound increments. The weights were cut from three separate solid steel rods with diameters of 2", 3.5" and 4". Figure 6 shows that each tip weight had a .516" bore in the center with a 1/4" solid section in the middle that had a 1/16" hole for the fastening screw. The weights were designed so that when the weight was attached to the beam, the center of mass of the weight would be located at the tip of the beam as seen in Figure 6.

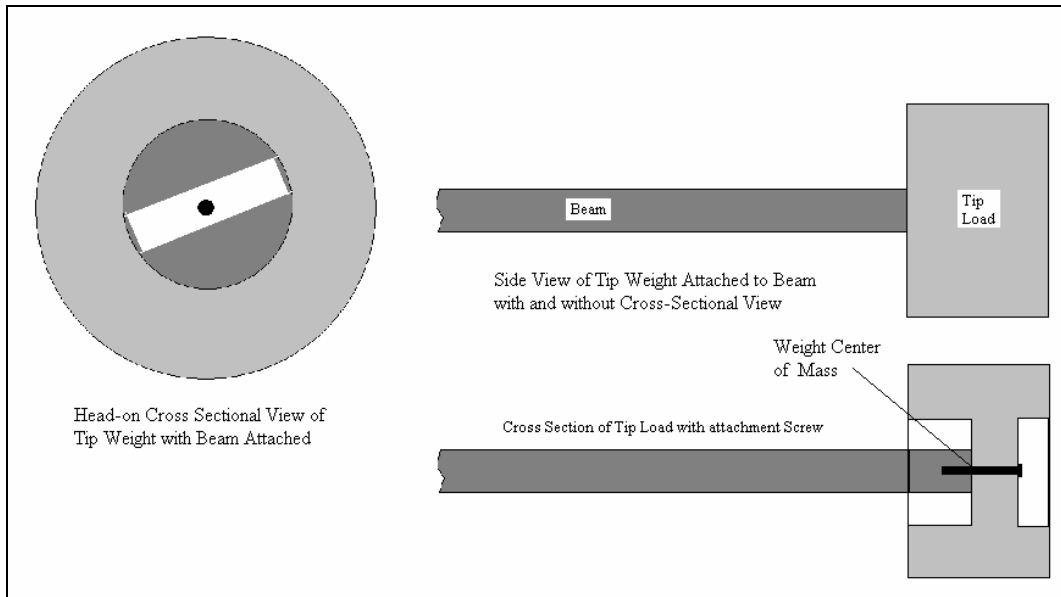

Figure 6: Weight Cross Sections [15]

The dimensions of the beams used are show in Table 1 and can be seen in Figure 7. Bore A refers to the side of the weight that the beam is attached, and Bore B refers to the free end where the screw is inserted.

Table 1: Tip Weight Dimensions [16]

Designed Weight (lb)	Diameter (in)	Total Length (in)	Bore A Length (in)	Bore B Length (in)	Actual Weight (lb)
1	2	1.158	0.588	0.320	1.01
2	3.5	0.727	0.366	0.111	2.01
3	3.5	1.094	0.550	0.294	3.02
4	4	1.112	0.733	0.129	4.01

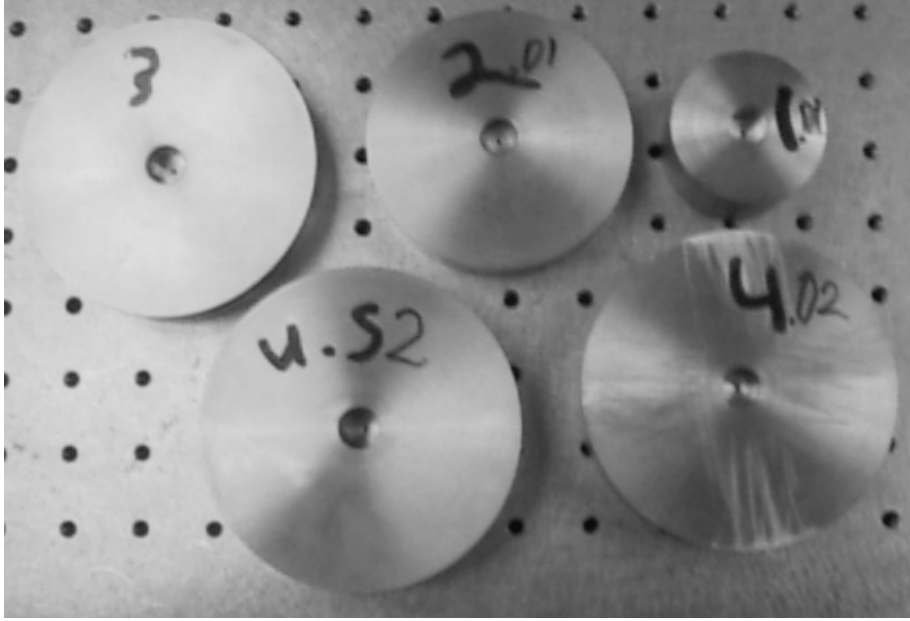

Figure 7: Tip Weights [15]

The moments of inertia for all of the tip weights were calculated using the following equations:

$$I_{xx} = \frac{\pi\rho L_{\text{solid}} R_o^4}{2} + \frac{\pi\rho L_A (R_o^4 - R_{iA}^4)}{2} + \frac{\pi\rho L_B (R_o^4 - R_{iB}^4)}{2} \quad (1)$$

$$I_{yy} = \frac{M_{\text{solid}} (3R_o^2 + L_{\text{solid}}^2)}{12} + M_{\text{solid}} d_{\text{solid}}^2 + \frac{M_A (3R_o^2 + 3R_{iA}^2 + L_A^2)}{12} + M_A d_A^2 + \frac{M_B (3R_o^2 + 3R_{iB}^2 + L_B^2)}{12} + M_B d_B^2 \quad (2)$$

Where R_o , R_{iA} , R_{iB} , L_{solid} , L_A , and L_B can be seen in Figure 8 and the values for the moments of inertia can be seen in Table 2.

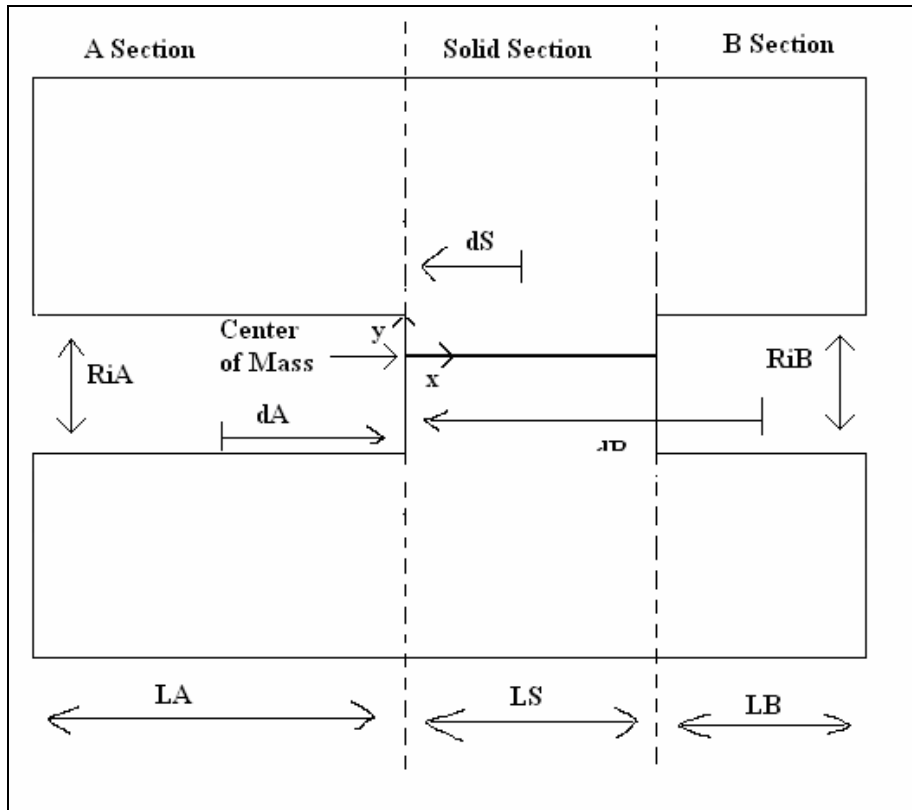

Figure 8: Moment of Inertia Equation Variables [15]

Table 2: Moment of Inertia Calculations

Weight (lb) Measured	I_{xx} (lb-in ²) Calculated	I_{yy} (lb-in ²) Calculated
1.01	0.531	0.375
2.01	3.122	1.646
3.02	4.702	2.643
4.01	8.124	4.603

3.1.3 Swiveling Hub

Figure 9 shows the clamp used to ensure that the beam had a fixed boundary condition at the root. The hub that was made clamps four inches of the 24" beam. This allows the beam to have a cantilever end and have the desired 20" length. Figure 10

displays some of the orientations of the root pitch angle used in the experiment for this thesis.

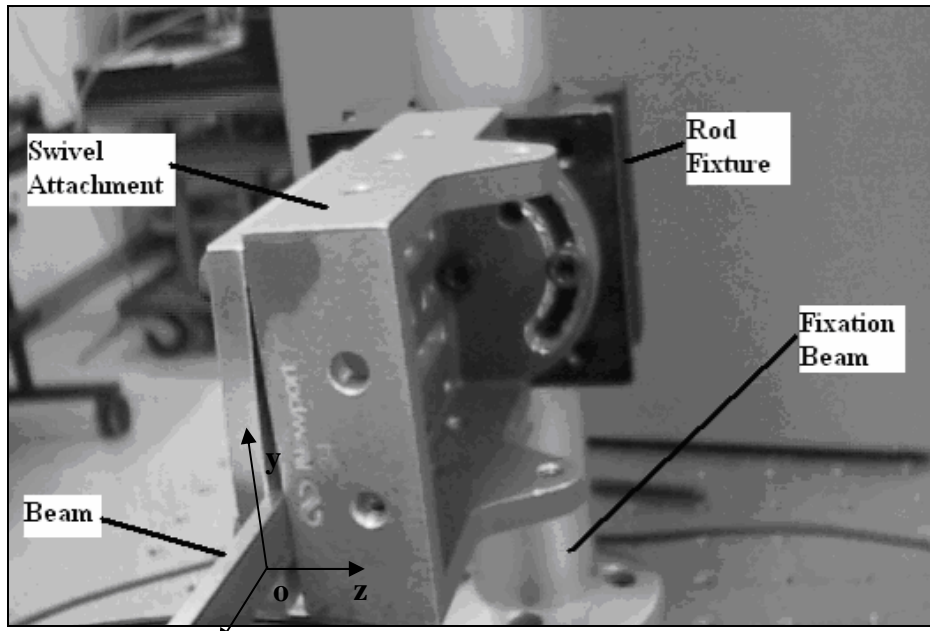

Figure 9: Swiveling Hub Attachment [11]

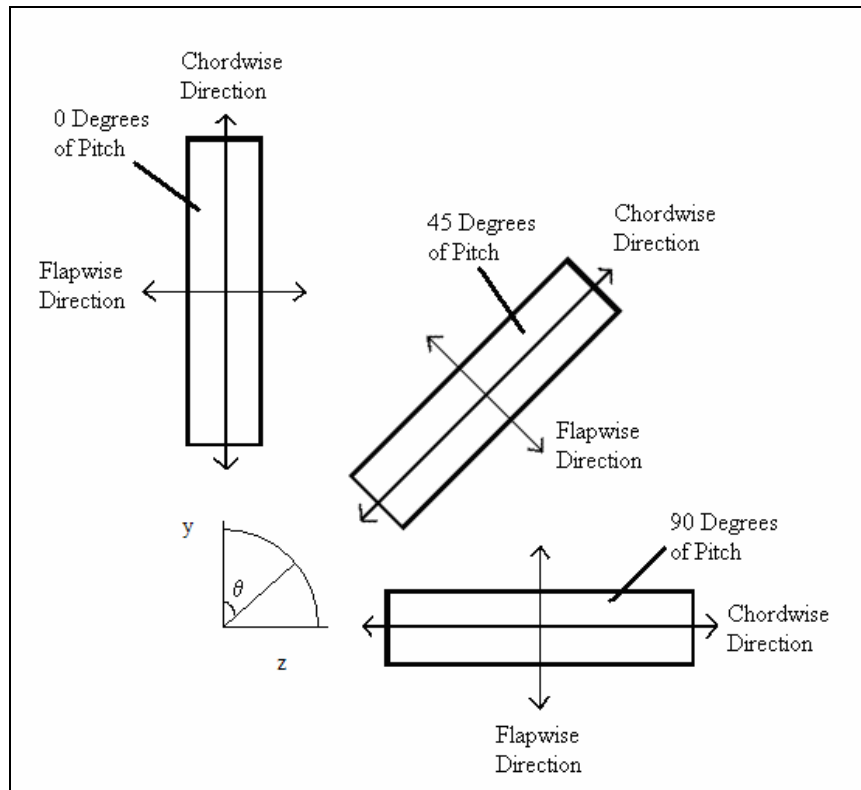

Figure 10: Directional Orientation [11]

3.1.4 Inclinometer

The inclinometer is used to determine that the beam is placed at the correct angle. The SPI Protracto Level II Inclinometer has a digital readout and is accurate to a tenth of a degree. The inclinometer has a maximum range of 50° but the investigation only required testing up to 45° . The inclinometer is attached to the clamp that held the beam during the experiment so that an accurate reading could be taken for each test.

3.1.5 Excitation Force

An Atlas Sound 60 watt, 8 ohm speaker is used to excite the beam to measure the natural frequencies. The excitation signal used was a periodic chirp from 10 Hz to 2000 Hz for the test. A periodic chirp is “designed to excite all FFT lines of the measured spectrum” [13]. The speaker is shown in Figure 11.

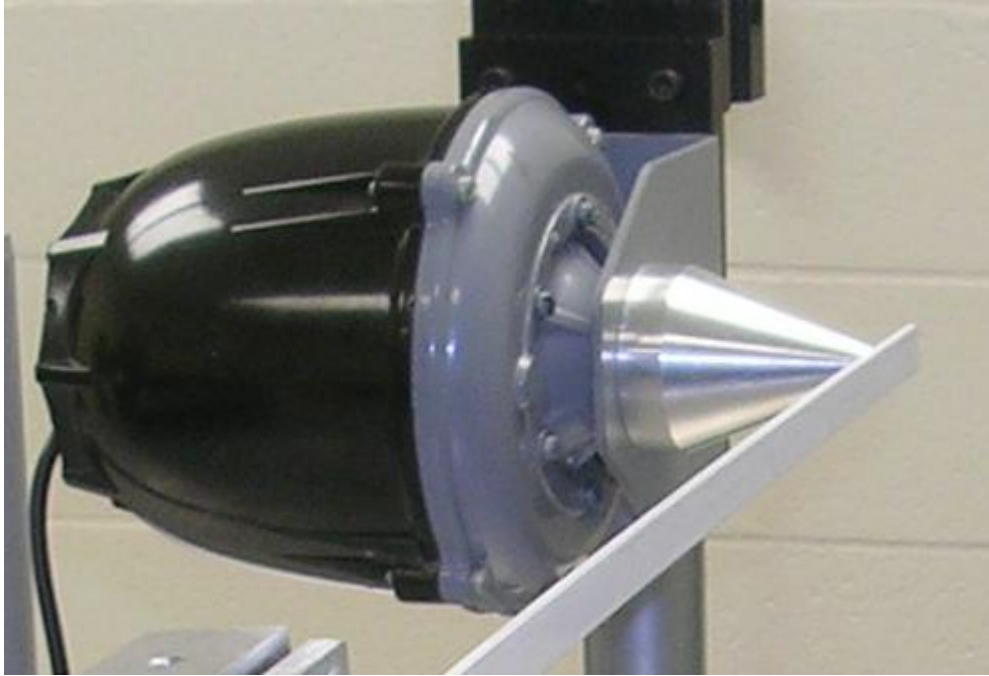

Figure 11: Excitation Force

3.1.6 Laser Vibrometer

The Polytec Scanning Vibrometer PSV 400-3D is used to measure the natural frequencies and estimate the mode shapes. The laser vibrometer can be used as either a 1-D or 3-D system. This investigation used the 3-D method.

The 3-D laser vibrometer used Polytec software version 8.3 to analyze the data. Once the beam was in place, at the correct angle and with the right tip weight, there were many steps needed before the laser vibrometer was ready to do the testing. There are three lasers that comprise the set-up. Figure 12 shows the three laser setup.



Figure 12: 3-D Laser Vibrometer Setup

The three lasers are referred to as the left, right and top head. The top head (middle laser) has a camera and a scanning laser which measures distances. The laser vibrometer measures velocities at points selected during a grid making stage which will be discussed in the next section. The velocities measured by the lasers were sent to the Polytec software which applied a Fast Fourier Transform (FFT) to find the frequencies. From the FFT the natural frequencies could be found for the range of frequencies excited by the excitation force.

3.2 Experiment

3.2.1 Beam Preparation

In Whiting's tests [15], measurements could not be taken at large root pitch angles due to the laser beam being reflected off the beam and not back to the laser head. To help alleviate this problem the beam was sprayed with a lightweight white paint. The paint used is Magnaflux Spotcheck Developer SKD-S2. The paint increases the amount of the laser reflected back to the source during testing. A mark four inches from the base of the beam was made so that the portion of the beam that was needed to be clamped in the swiveling hub was easy to determine.

3.2.2 Procedure

The first step in the setup of the experiment was to make sure that the fixation beams were secure to the optical table. The fixation beam held the swiveling hub and beam was fastened to the table by use of Newport Research Corporation Model 100 Magnetic Base. The fixation beam holding the speaker was locked using four bolts that were 1/4" in diameter. The bolts were required for the speaker because the magnet was not strong enough to counter the large moment arm. The swiveling hub was attached to the fixation beam which was secured by the magnet. The swiveling hub was fastened around the 24" beam, with four inches of the beam fastened inside the hub. The bolt holding the swiveling hub was loosened and adjusted while observing the reading on the inclinometer until the beam was placed at the correct root pitch angle. Once the correct angle was found and the bolt was tightened. Figure 13 shows the final configuration including the excitation force.



Figure 13: Swiveling Hub Attachment

After the beam is set up, the lasers must be aligned. The top laser's camera displays the specimen on a computer screen. The computer is able to dictate what the laser does, but each test requires an alignment between the computer and the lasers. The alignment between the computer and the lasers is a two step process which is called the 1-D and 3-D alignment.

The first step in the alignment process is the 1-D alignment. The 1-D alignment is done by moving the laser beam from the top head from point to point on the specimen. This associates a distance per pixel so that the computer knows how much to move the

laser beam when you move the laser with the mouse on the computer. The next step, which is the most time consuming, is to complete the 3-D alignment. This requires all three lasers to be located at the same point on the specimen. When completed, all three lasers will move to the same point on the specimen. The first three points chosen during this step are considered the origin, a point on the x-axis and a point in the positive x-y plane. Up to four more points can be aligned on the specimen to ensure all three lasers are aligned throughout the entire specimen. After the 3-D alignment is complete, a grid must be made over the specimen for testing. This grid determines each test point on the beam. The grid is made using the computer by overlaying a mesh on top of the beam. When the density of the grid is determined, the scanning laser from the top laser scans all grid points on the beam to calculate the distance. A typical grid configuration can be seen in Figure 14. Once the grid is complete, testing is ready to begin.

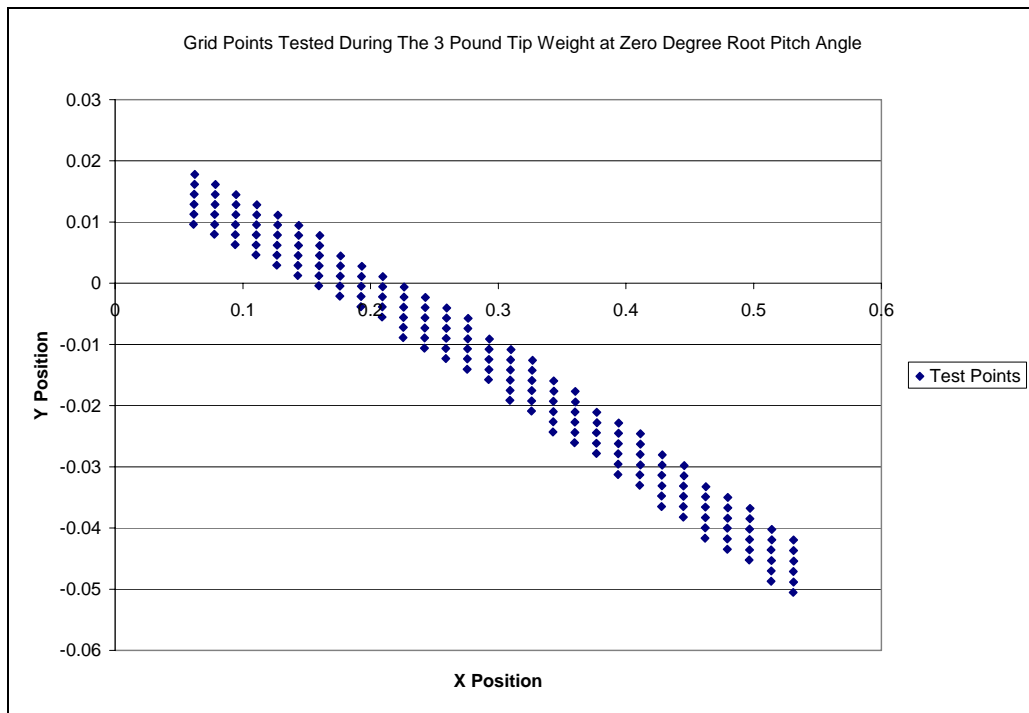

Figure 14: Grid Points Tested During a 3 Pound Tip Weight at 0° Root Pitch Angle

The testing starts by setting the excitation force to a periodic chirp from 10 Hz to 2000 Hz. During the setup of the test, it was determined that each point should be tested through three cycles of the periodic chirp. Once the laser vibrometer scans every grid point for the three cycles the test is complete. The Polytec software graphs the Fast Fourier Transform. Figure 15 shows the FFT and the coherence of no tip weight at the zero root pitch case.

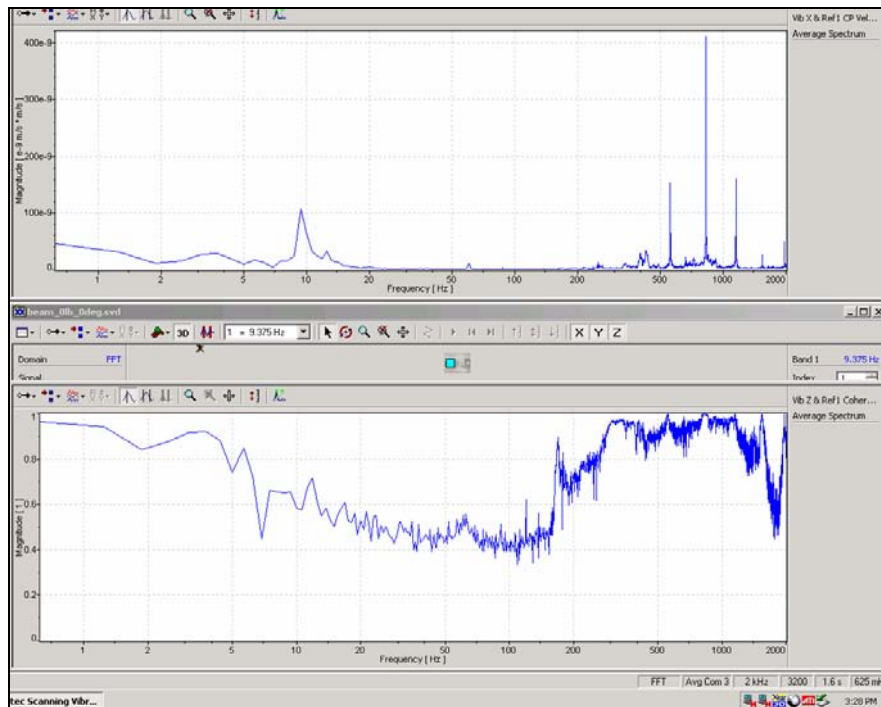

Figure 15: FFT and Coherence Plot for No Tip Weight and 0° test

The next step is to manually highlight all the peaks on the FFT and let the program calculate the frequency of the max value of each peak, respectively. By doing this, each frequency can be selected individually and the movement of the beam can be seen in a separate screen. This is useful to determine whether the frequency selected was an actual natural frequency or just noise. After examining each movement, all of the natural frequencies were recorded.

The first scan of the specimen used a periodic chirp which tested the beam through a range of frequencies which is time consuming making it impractical to have a dense grid. A different type of scan which can be performed is called a Fast Scan. The Fast Scan takes measurements of the specimen at a specific frequency [13]. Testing at one frequency allows a more densely populated grid to be tested in less time. The periodic chirp scan had about 40 scan points where the Fast Scan had about 140 scan points. The excitation frequency, positions and velocities from the Fast Scan were then exported into an ASCII file. This is the conclusion of one test at a specific root pitch angle and tip weight. The testing procedure for this investigation tested the beam at a specific root pitch angle and changed the tip weight after each test. Once the beam was tested with every weight at a specific root pitch angle, the angle was changed and the beam was tested with all the weights at the new angle. The angles and weights tested can be seen in Table 3.

Table 3: Angles and Weight Configuration of Testing

	Angle						
Weight	-45°	-30°	-15°	0°	15°	30°	45°
0	x	x	x	x	x	x	x
1	x	x	x	x	x	x	x
2	x	x	x	x	x	x	x
3		x	x	x	x	x	
4		x	x	x	x	x	

3.3 Linear Equations of Motion

The linear equations used to calculate the bending and torsion natural frequencies of the beam are presented by Hodges and Pierce [6:44-45]. The derived equation of motion for transverse beam displacements is:

$$a^4 \frac{\partial^4 v}{\partial x^4} + \frac{\partial^2 v}{\partial t^2} = 0 \quad (3)$$

Where:

$$a^4 = \frac{EI}{m} \quad (4)$$

The solution to this equation can be attained using a separation of variables. The solution for the time-dependent equation is:

$$Y(t) = A \sin(\omega t) + B \cos(\omega t) \quad (5)$$

Where

$$\omega = a^2 \alpha^2 \frac{EI}{m} = \alpha^2 \sqrt{\frac{EI}{m}} = (\alpha l)^2 \sqrt{\frac{EI}{ml^4}} \quad (6)$$

Assuming the solution of the spatially dependent equation takes the form of $X(x) = \exp(\lambda x)$, the general solution is:

$$X(x) = D_1 \sin(\alpha x) + D_2 \cos(\alpha x) + D_3 \sinh(\alpha x) + D_4 \cosh(\alpha x) \quad (7)$$

The constant D_i ($i=1, 2, 3, 4$) can be evaluated using the boundary conditions at the end of the beams. For the investigation for this thesis, a cantilever boundary condition is set at the root and translational and rotational inertia boundary conditions are at the tip.

Once the constants are solved for, this is called the characteristic equation and can be seen in Appendix B [8]. The next step is to solve the characteristic equation for each

bending and torsion frequency, which is done by finding the roots of the characteristic equation. This step can be seen in Appendix B.

3.4 Finite Element Analysis

The finite element analysis tool used in the investigation for this thesis is called Nastran. Nastran is a finite element analysis tool which “provides a wide range of modeling and analysis capabilities, including [...] vibration” [12]. Nastran can analyze a structure’s natural frequencies with the geometry and material properties of the structure. The geometry and material properties for the analysis was created in a program called FEMAP. FEMAP is a finite element modeling system. A geometry can be made “directly in FEMAP using powerful wireframe and solid modeling tools” [14]. In FEMAP a beam was created with the same dimensions as the beam mentioned in 3.1.1. For an accurate analysis of high order modes the number of elements (CBEAM) on the beam is important. If there are too few elements the higher order frequencies will not be calculated correctly because there will be an insufficient degrees of freedom. The beam created in FEMAP for this investigation had 1600 CBEAM elements. The CBEAM element simulates a bar defined by two grid points and it provides resistance to torsion and bending moments, it also has the ability of performing nonlinear geometric and material process [12]. The material properties used for the beam are the material properties for 7075-T6 aluminum [10]. The file created by FEMAP to be analyzed by Nastran can be seen in Appendix C.

4. Results and Analysis

The goal of this research is to determine the frequency response and mode shapes of nonlinear bending on a homogeneous uniform beam. To measure this effect, the natural frequencies from this investigation will be compared to those derived from linear equations and a nonlinear finite element analysis in Nastran. In this section, the graphs and figures with frequencies below 250 Hz were produced from the raw data shown in Appendix A. The speaker used to excite the beam had a minimum excitation frequency of 10 Hz, which caused problems in measuring the first natural frequency of the system. In a previous study, Whiting [15] measured the first natural frequency and estimated the corresponding mode shapes with a very similar setup.

4.1 Frequency Analysis

The frequencies measured during this experiment with no tip weight are predicted to match those derived from the linear equations and the finite element model. Once weight is added to the system, coupling will occur and the linear equations will no longer accurately predict the natural frequencies, however, the nonlinear results from the finite element model should still predict the natural frequencies fairly well. Table 4 and Figure 16 show the natural frequencies found for the beam with no tip mass using the linear equations, the nonlinear finite element model, and through experimentation.

During the experiment, the laser vibrometer did not measure all natural frequencies. This could have occurred for many reasons, either because of noise at 60 Hz, or the natural frequency was lower than the minimum excitation frequency of the speaker, which is the case for any frequency lower than 10 Hz. The measured

frequencies in Table 4 have been aligned to match the closest calculated frequency by looking at the mode shape and matching it to the correct calculated mode shape.

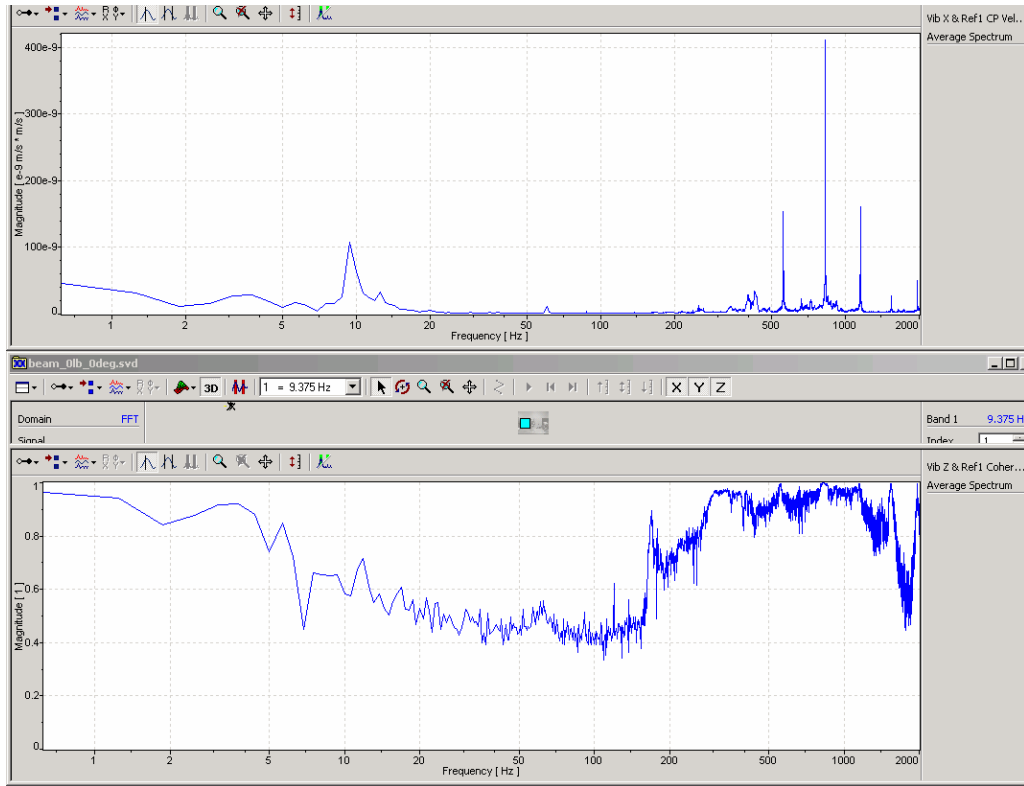

Figure 16: Coherence and FFT with no Tip Weight and at 0° Root Pitch

Table 4: Modal Frequencies No Tip Mass at 0° Root Pitch

Mode Type	Equations	Nastran	Experimental
	cyc/sec		
1st Mode Flat	10.05	9.94	9.375
1st Mode Edge	40.21	40.10	
2nd Mode Flat	62.99	62.26	60
3rd Mode Flat	176.38	174.32	
2nd Mode Edge	251.97	251.16	250
4th Mode Flat	345.64	341.60	338.1
5th Mode Flat	571.37	564.68	556.3
3rd Mode Edge	705.53	703.25	
6th Mode Flat	853.53	843.54	826.3

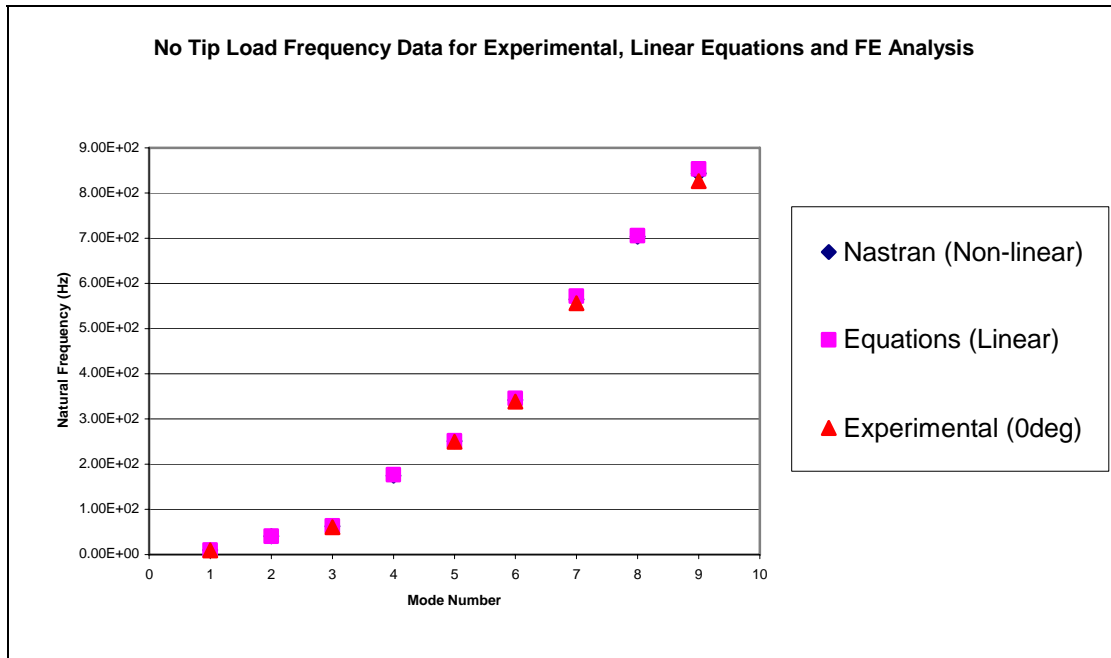

Figure 17: Frequency Comparison for Experimental and Linear Equations for No Tip Weight

Figure 17 shows that the linear equations agreed with measured natural frequencies with no tip weight with the greatest error being 4.7%. The finite element model predicted natural frequencies which also agreed with the measured natural frequencies with the greatest error being 3.6%.

In the next test, a one pound tip weight was added to the tip of the beam. Due to the system being nonlinear the linear equations did not yield accurate predictions to the natural frequencies of the beam found with a tip weight. The natural frequencies at 0° root pitch angle can be seen in Table 5 and Figure 19. The linear equations had a max error of 55.2% while the finite element analysis had a max error of only 6.9%

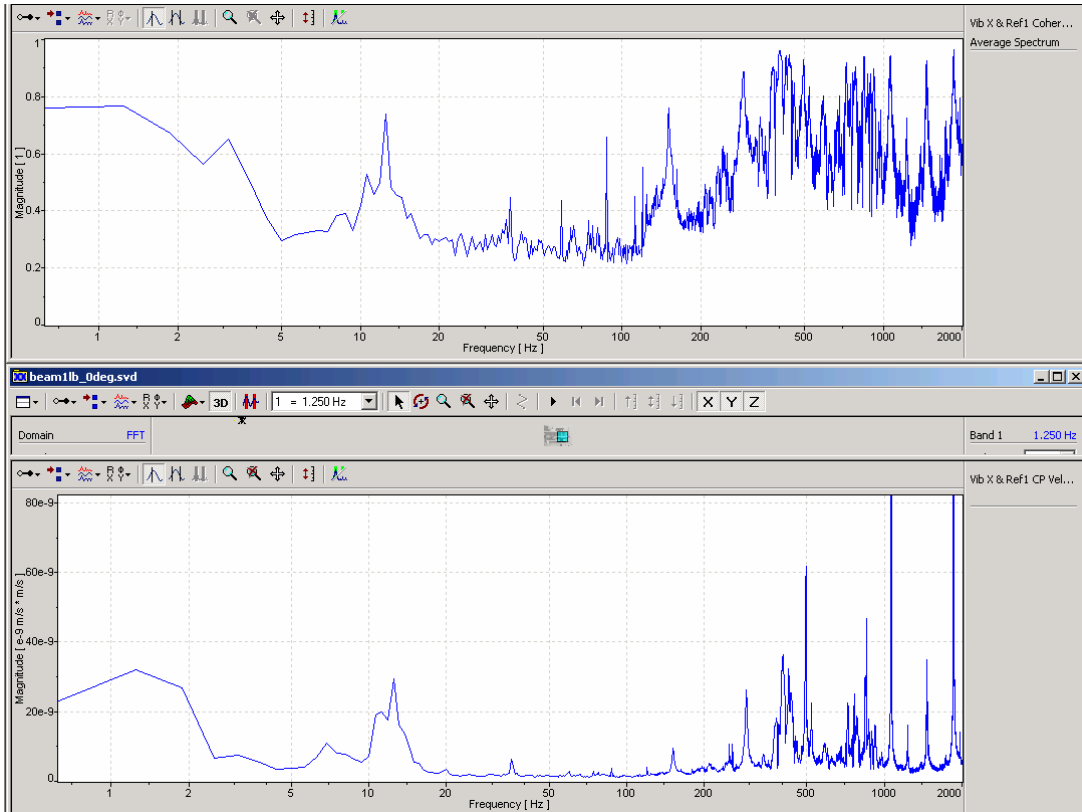

Figure 18: Coherence and FFT with One Pound Tip Weight and at 0° Root Pitch

Table 5: Modal Frequencies One Pound Tip Mass at 0° Root Pitch

Mode Type	Equations	Nastran	Experimental
		cyc/sec	
1st Mode Flat	1.7309	1.72E+00	
1st Mode Edge	6.9237	6.95E+00	
2nd Mode Flat	38.9421	4.39E+01	
3rd Mode Flat	97.4754	1.42E+02	151.3
2nd Mode Edge	155.7682	1.77E+02	
4th Mode Flat	191.2654	2.95E+02	291.3
5th Mode Flat	353.134	5.04E+02	493.8
3rd Mode Edge	389.9016	5.71E+02	
6th Mode Flat	576.0466	7.69E+02	763.1

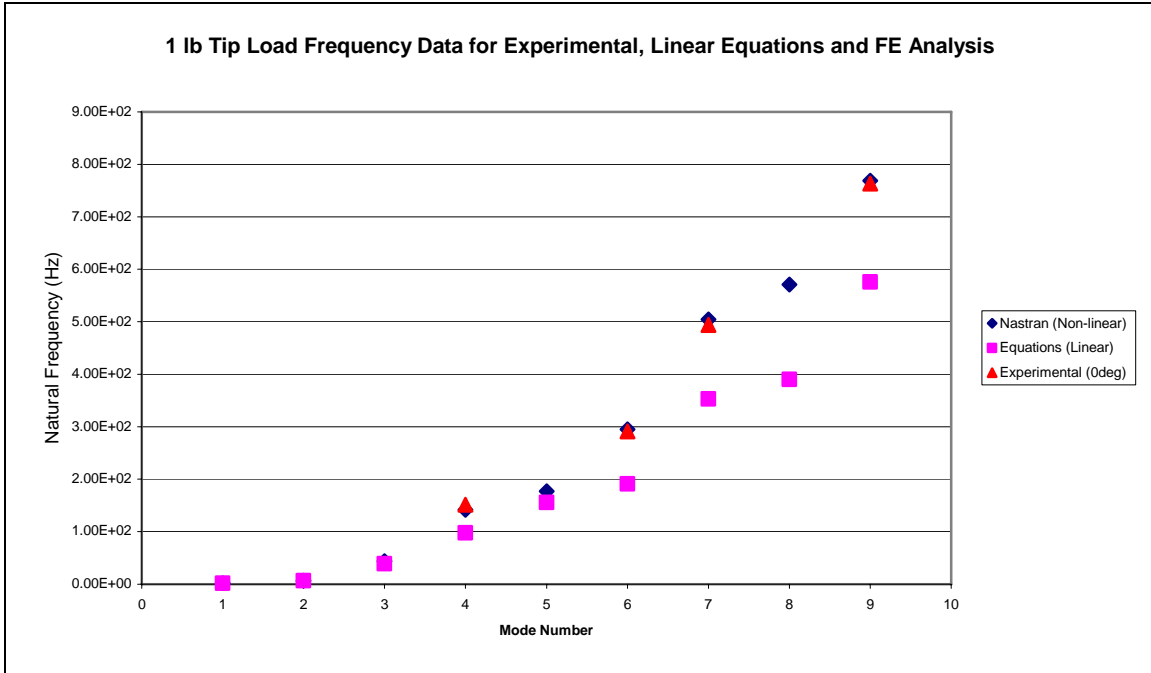

Figure 19: Frequency Comparison for Experimental and Linear Equations for a One Pound Tip Weight

Figure 19 shows the linear equations fail to predict the natural frequencies as the mode number increases due to the nonlinear effects that the linear equations do not account for.

The three pound tip weight is predicted to have the highest nonlinear effects on the natural frequency. Table 6 and Figure 21 depict the nonlinear results of the three pound tip weight compared to the linear equations.

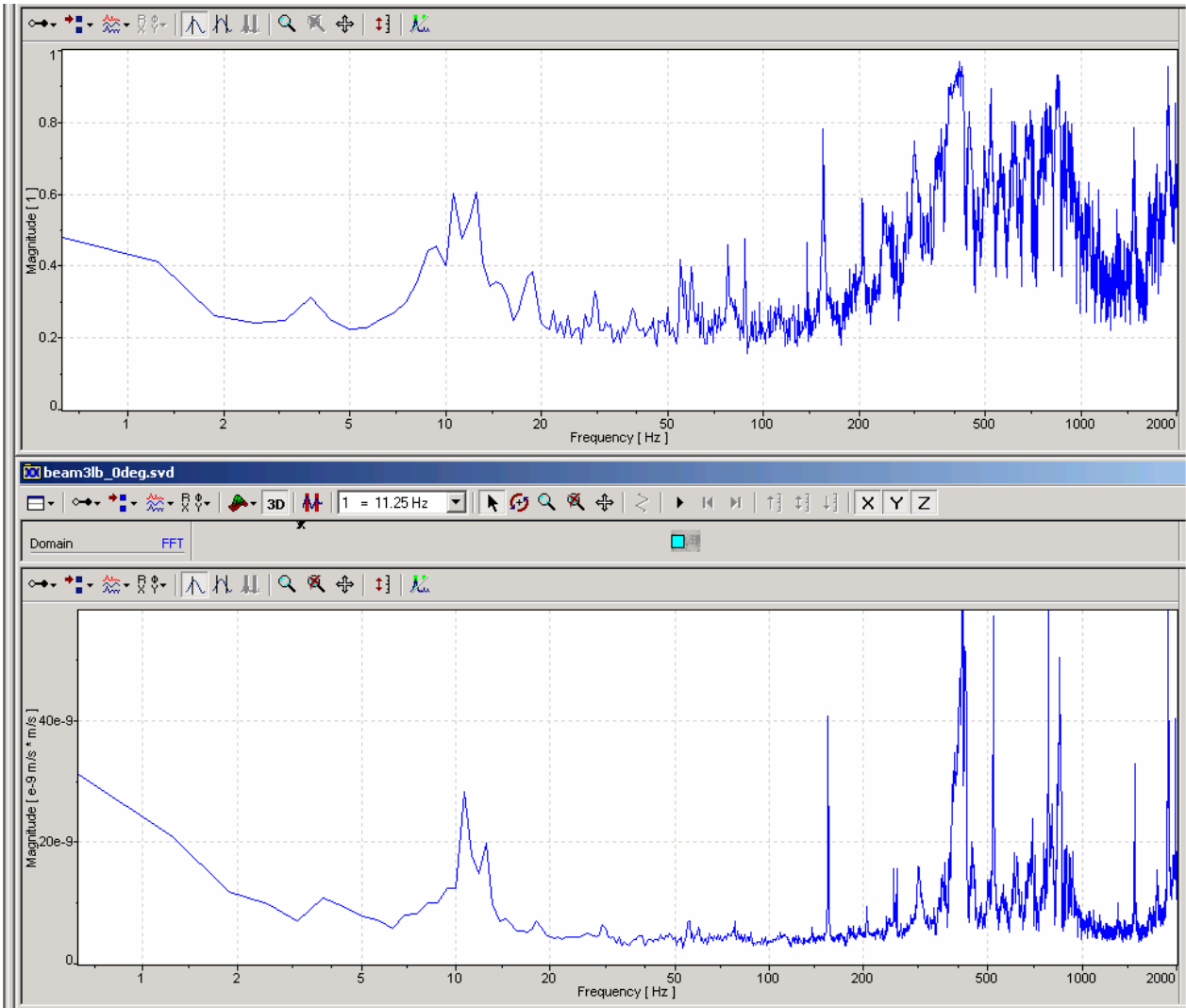

Figure 20: Coherence and FFT with Three Pound Tip Weight and at 0° Root Pitch

Table 6: Modal Frequencies Three Pound Tip Mass at 0° Root Pitch

Mode Type	Equations	Nastran	Experimental
	cyc/sec		
1st Mode Flat	1.0072	1.00E+00	
1st Mode Edge	4.0287	4.05E+00	
2nd Mode Flat	22.7553	4.37E+01	55.63
3rd Mode Flat	69.3401	1.41E+02	154.4
2nd Mode Edge	91.0212	1.76E+02	
4th Mode Flat	178.3618	2.95E+02	299.4
5th Mode Flat	346.7946	5.04E+02	520.6
3rd Mode Edge	277.3604	5.70E+02	
6th Mode Flat	572.1567	7.69E+02	780

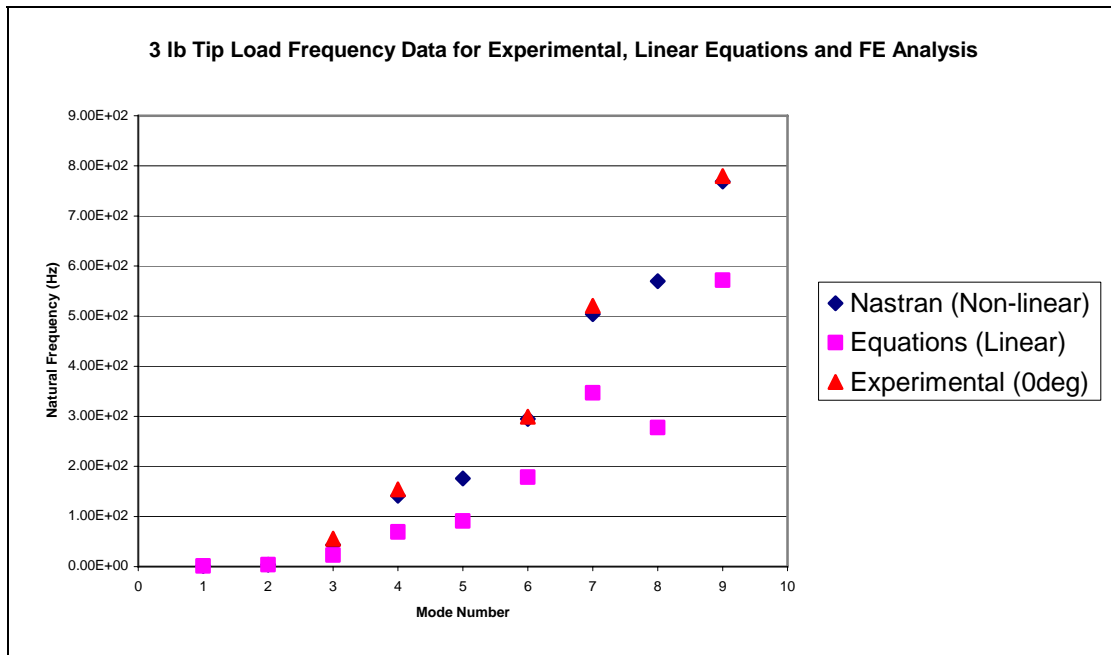

Figure 21: Frequency Comparison for Experimental and Linear Equations for a Three Pound Tip Weight

The three pound tip mass caused a maximum error of 144.4% with the linear equations and only 27.3% with finite element analysis.

4.2 Mode Shape Analysis

During the post processing of the data, the Polytec software ordered the data in the output file depending on the order in which the beam was scanned. The output file contained the displacement from the origin determined during the 3-D scan and the magnitudes of velocity. There were few changes to the raw data (Appendix A) that were needed to view the mode shape correctly. One of these changes was to determine when a negative sign was needed on the velocity which could be done by viewing the mode shape on the Polytec viewing tool. The second is to put the data points in the correct order. The Polytec software gave a position of each data point based on an origin and x-direction determined during the 3D alignment part of the setup, which made it possible to put all the data points in order by sorting the x-position. After the data was sorted and the correct sign was added to make the mode shape look correct, the x-position and velocity were normalized so that the x-position went from zero to one and the largest magnitude of velocity was ± 1 .

During one experiment, a natural frequency was found close to 60 Hz for no tip mass for 0 deg, 15 deg and 45 deg. The mode shape for this frequency is the second mode in the flatwise direction and can be seen in Figures 22-24.



Figure 22: Mode Shape for No Tip Weight at Zero Degree Root Pitch Angle With a 60Hz Frequency

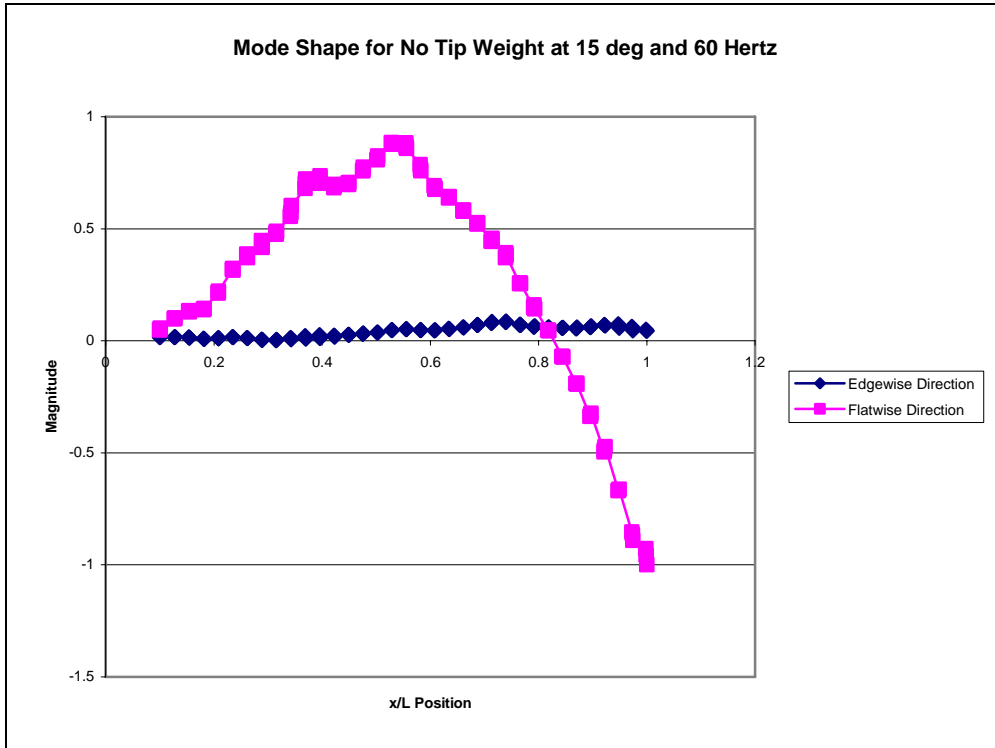

Figure 23: Mode Shape for No Tip Weight at 15 Degree Root Pitch Angle With a 60Hz Frequency

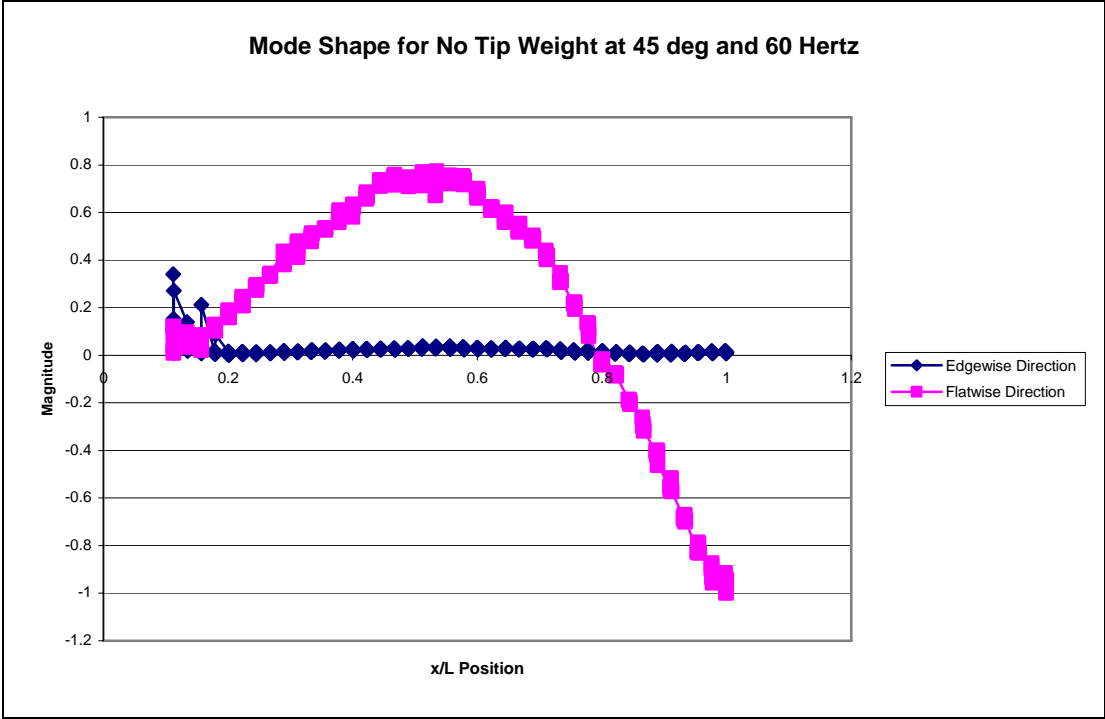

Figure 24: Mode Shape for No Tip Weight at 45 Degree Root Pitch Angle With a 60Hz Frequency

This linear relationship of the natural frequencies can more easily be seen in Figure 25

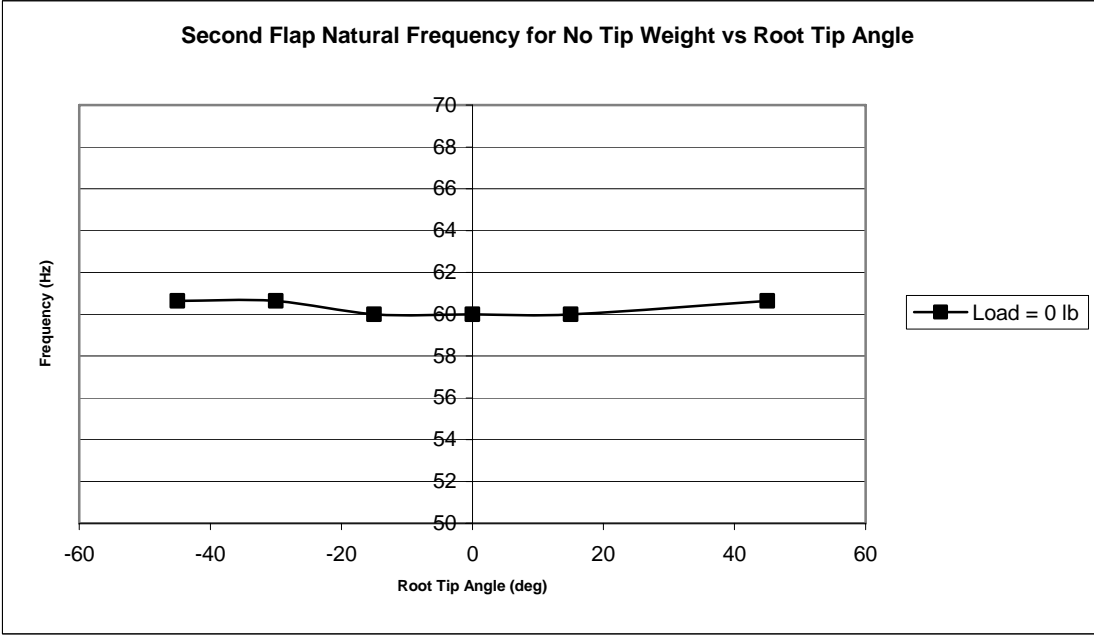

Figure 25: Frequencies Corresponding to Figures 22-24

The variation in these frequencies is only 0.67 Hz, a 1.1% change.

When a tip weight was added, a much larger change in the natural frequency can be seen. Figure 26-28 show the third mode shape for a three pound tip load at 160.0, 149.4, and 154.4 Hz respectively.

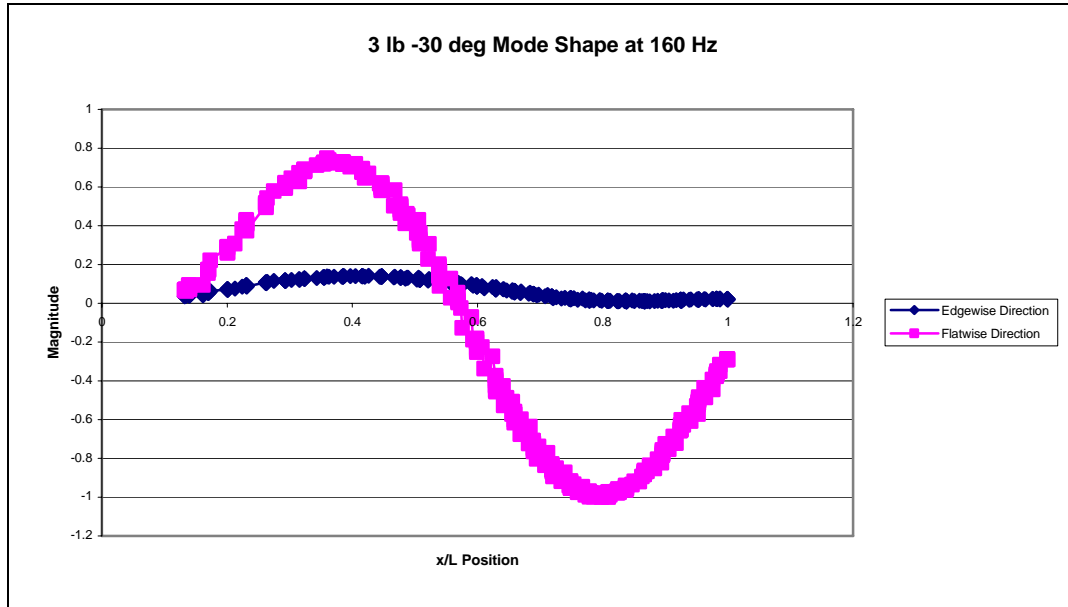

Figure 26: Mode Shape for Three Pound Tip Weight at 30 Degree Root Pitch Angle with a 160Hz Frequency

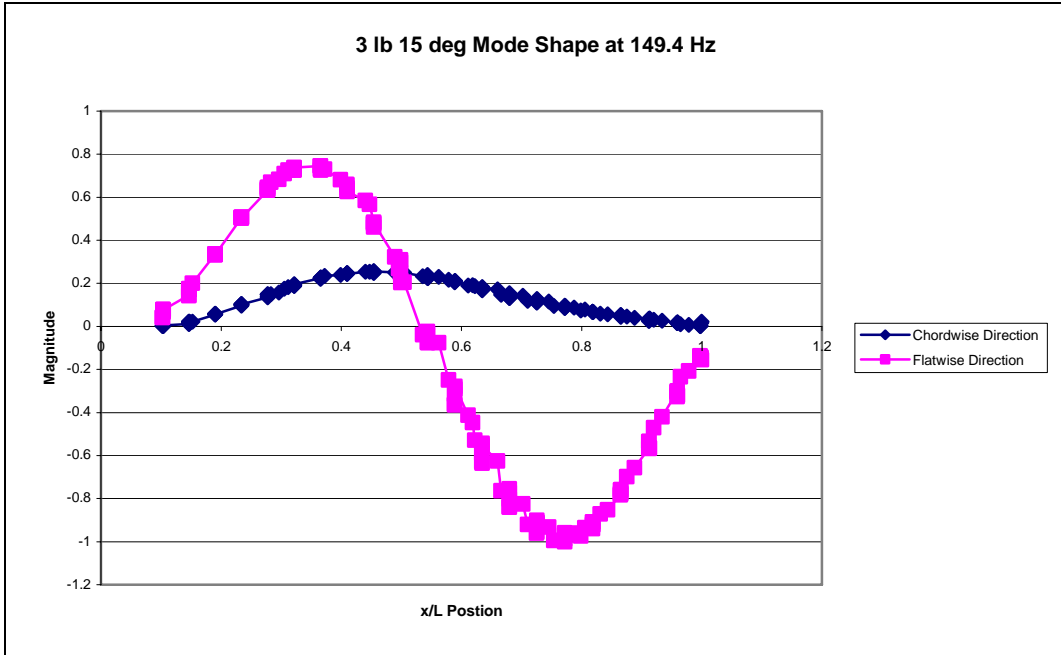

Figure 27: Mode Shape for Three Pound Tip Weight at 15 Degree Root Pitch Angle with a 149.4Hz Frequency

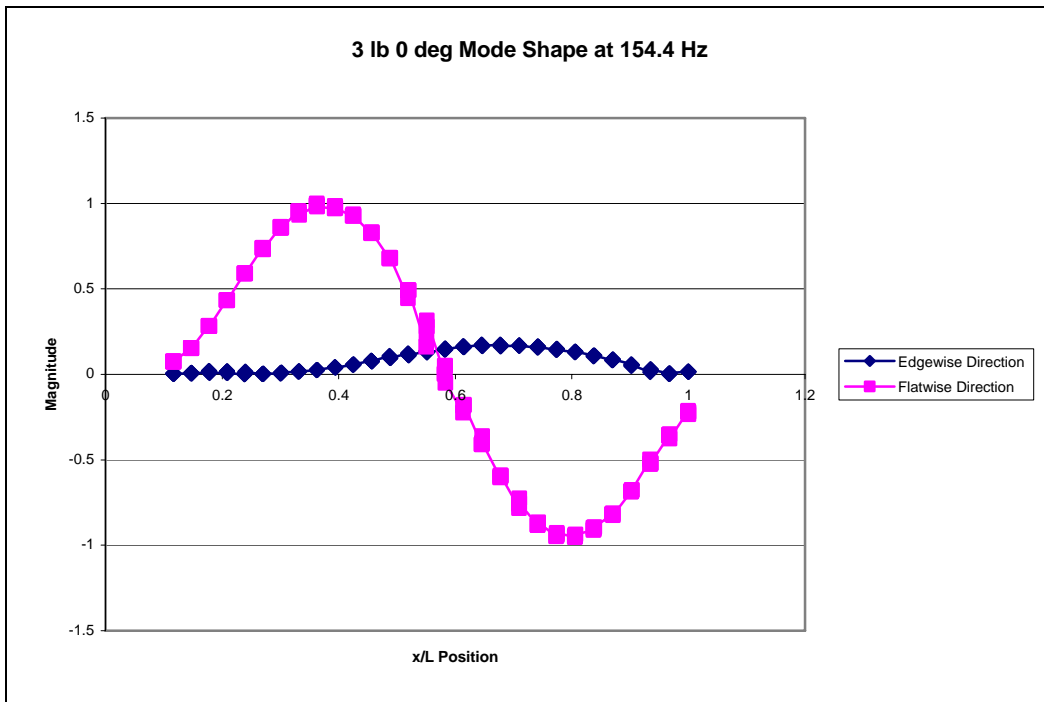

Figure 28: Mode Shape for Three Pound Tip Weight at Zero Degree Root Pitch Angle at 154.4Hz

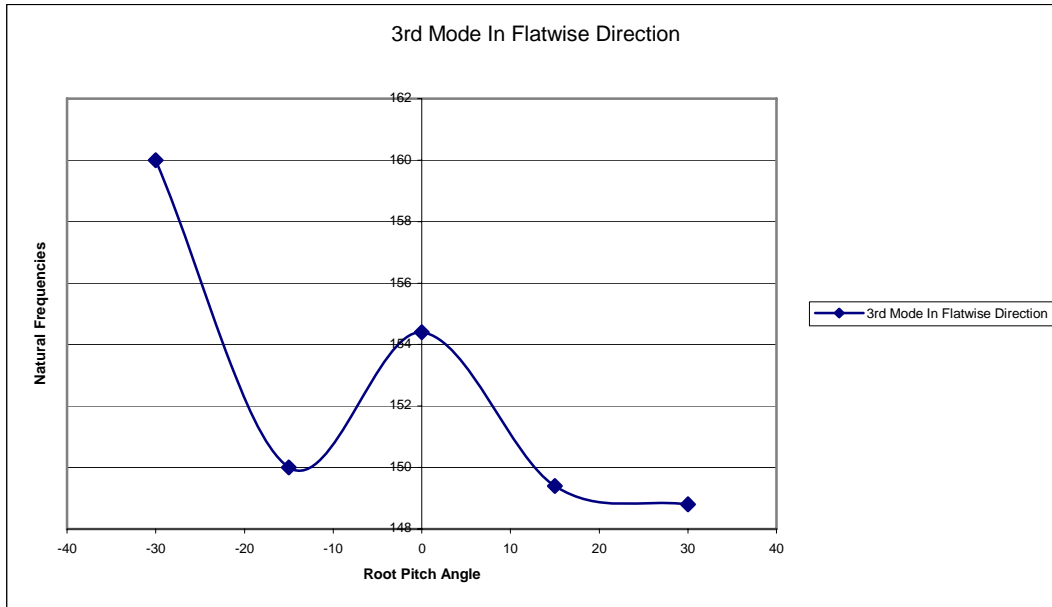

Figure 29: Frequencies Corresponding to Figures 26-28

For the case with a three pound tip weight for the third mode, the difference in frequencies for the same mode shape is 7.9% as seen in Figure 29. Figure 29 shows that the frequency response of the root pitch angle follows a nonlinear pattern.

4.2.1 Mode Shape of No Tip Weight

Figures 30-33 show all measured mode shapes for no tip weights at varying angles. The mode shapes all have similar shapes and natural frequencies at varying root pitch angles. The largest variation in natural frequency corresponding to a particular mode shape is 4.4%.

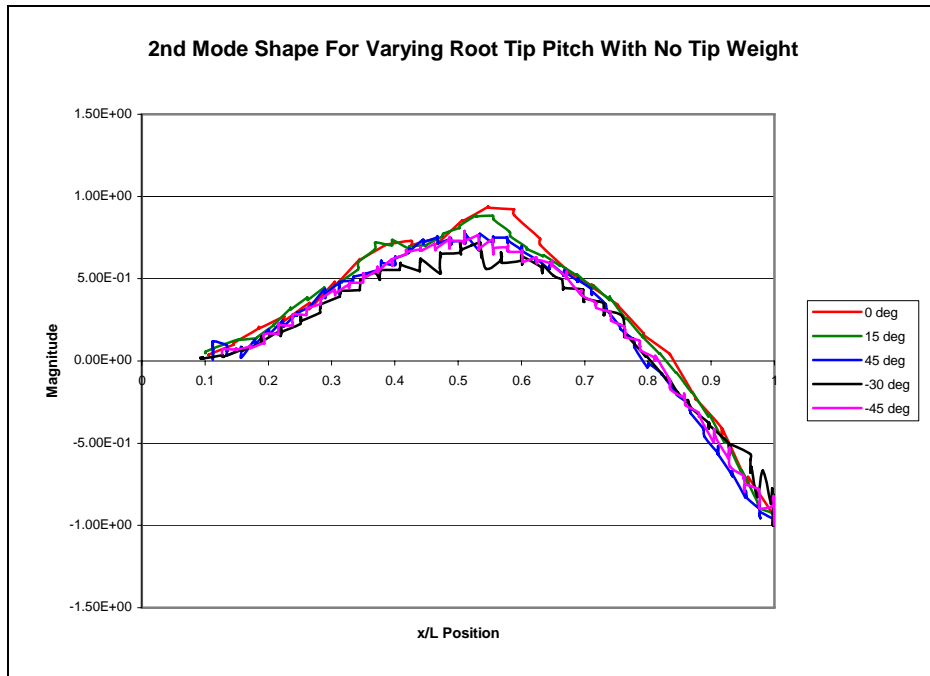

Figure 30: 2nd Mode Shape for the Beam at Varying Root Pitch Angles

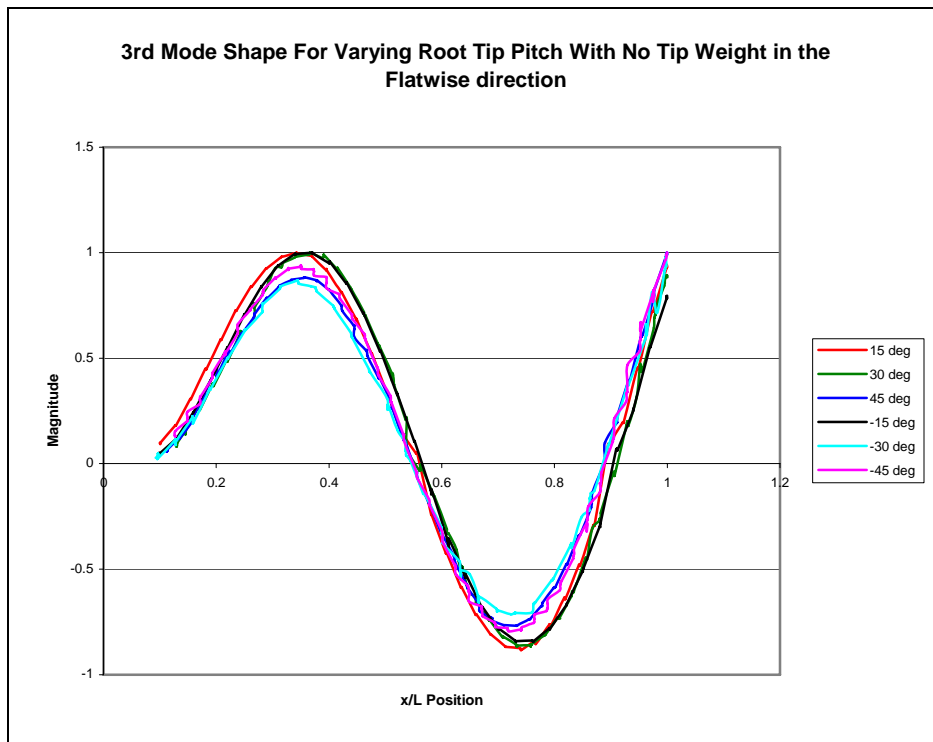

Figure 31: 3rd Mode Shape for the Beam at Varying Root Pitch Angles

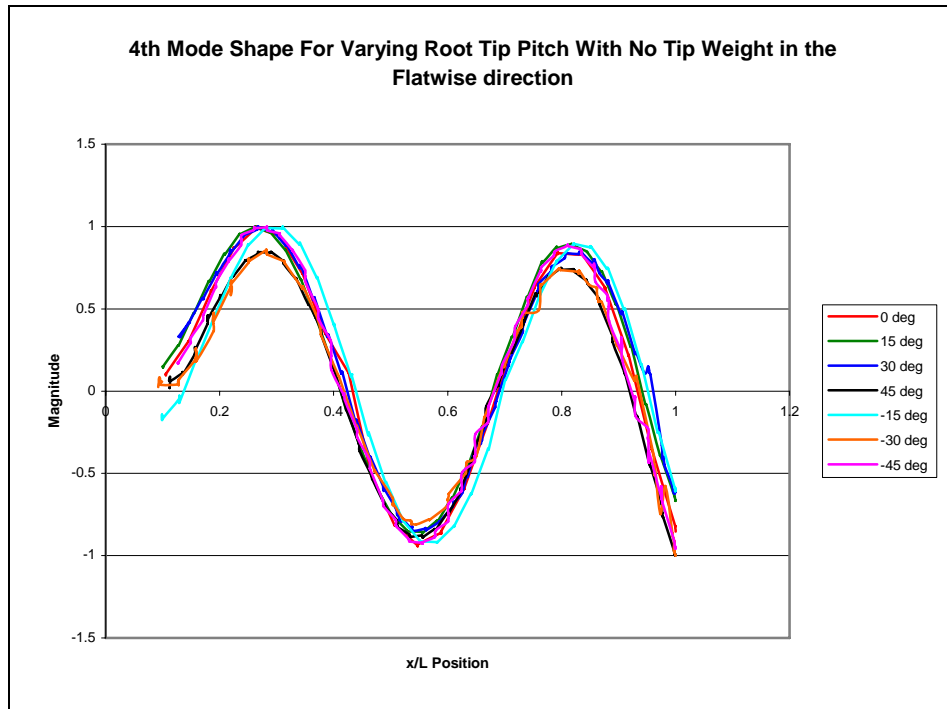

Figure 32: 4th Mode Shape for the Beam at Varying Root Pitch Angles

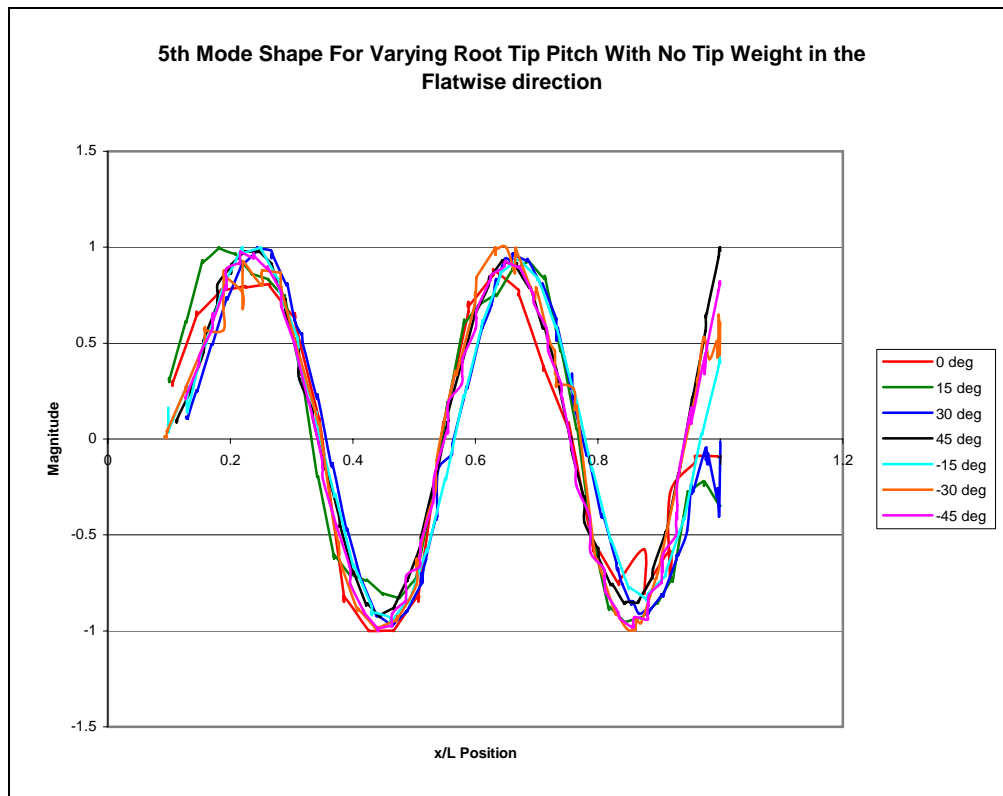

Figure 33: 5th Mode Shape for the Beam at Varying Root Pitch Angles

The frequencies which correspond to these modes are very similar and are represented in Table 7.

Table 7: Corresponding Frequencies to the Mode Shapes Found in Figure 30-33

	Experimental No Tip Weight						
	-45 deg	-30 deg	-15 deg	0 deg	15 deg	30 deg	45 deg
2nd mode	60.63	60.63	60	60	60		60.63
3rd mode	167.5	168.8	169.4		168.8	168.8	169.4
4th mode	333.8	341.3	348.4	338.1	341.3	320	335.6
5th mode	554.4	555.6	550	556.3	557.5	554.4	556.3

4.2.2 Mode Shapes of One Pound Tip Weight

Once a tip weight is added, although the mode shapes do not change much, the modal frequencies corresponding to these mode shapes do change with root pitch angle. The mode shapes and corresponding frequencies can be seen in Figures 34-38 and Table 8. The largest variation in natural frequency corresponding to a particular mode shape is 7.2%.

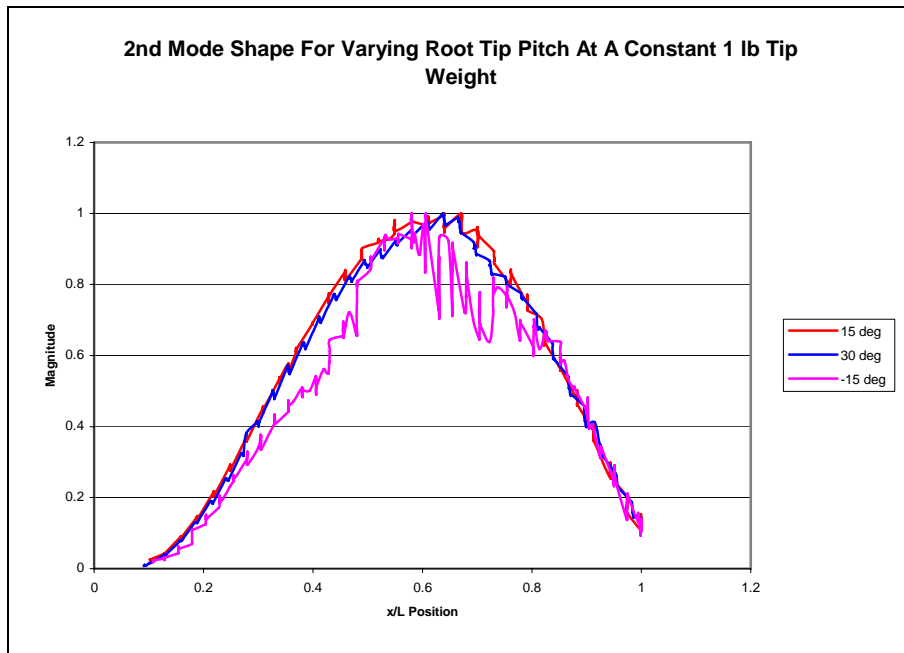

Figure 34: 2nd Mode Shape for the Beam at Varying Root Pitch Angles with a One Pound Tip Weight

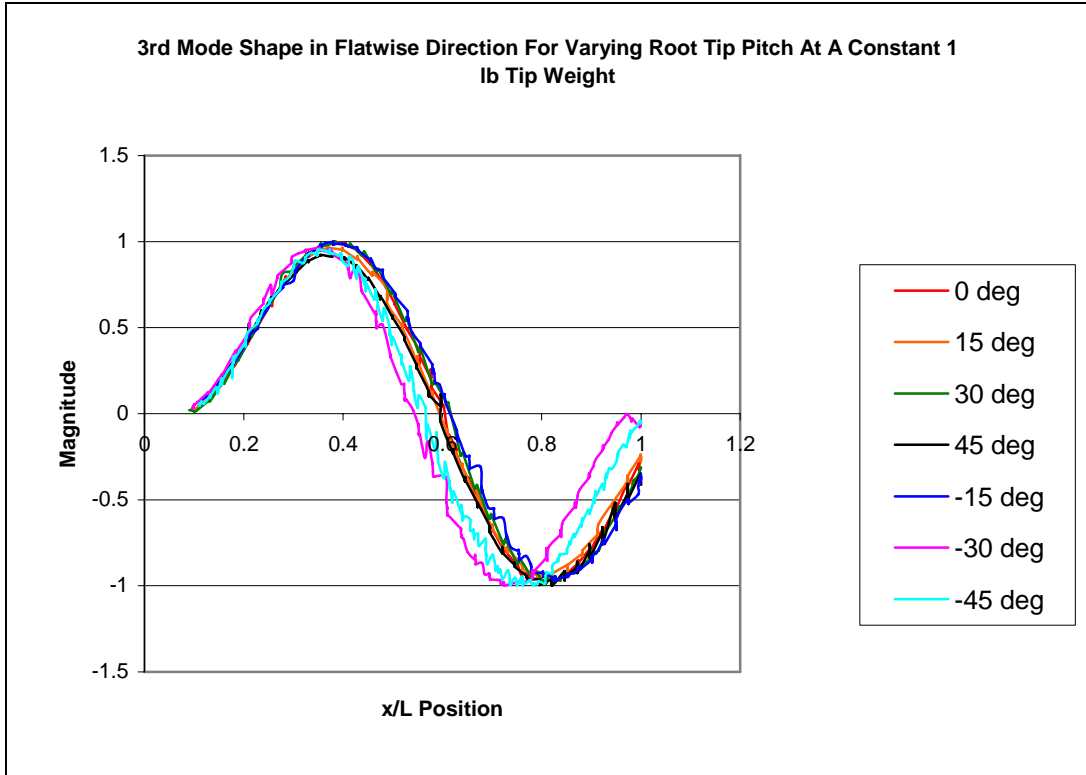

Figure 35: 3rd Mode Shape for the Beam at Varying Root Pitch Angles with a One Pound Tip Weight

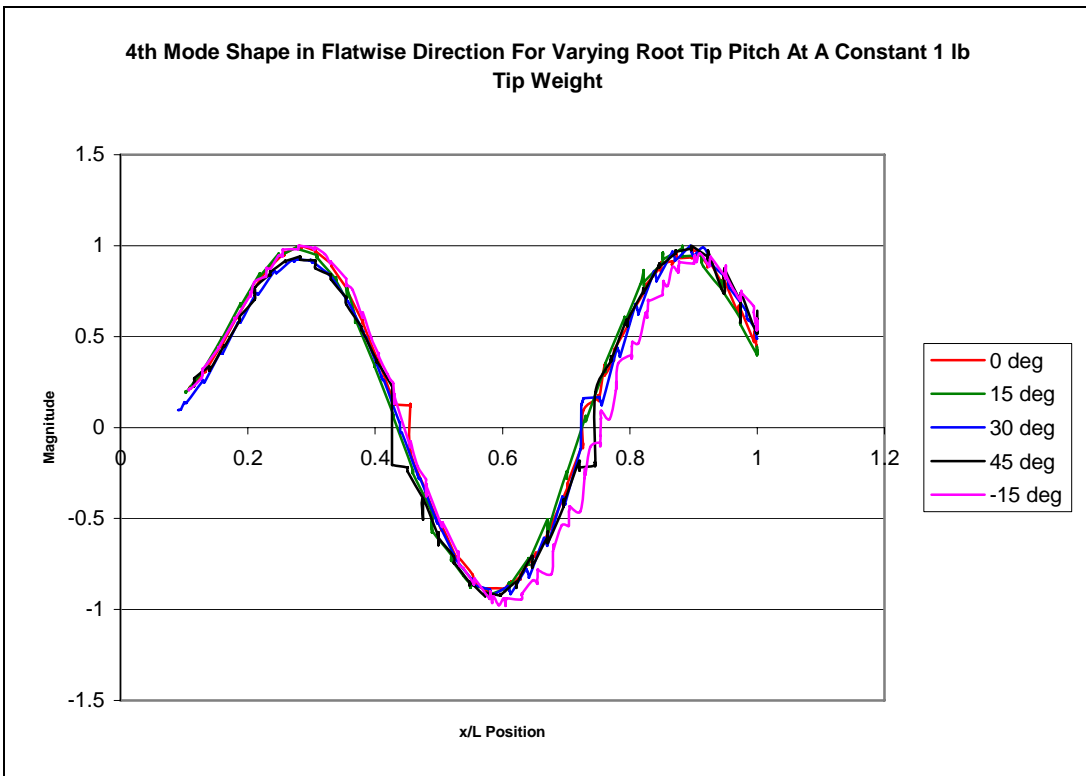

Figure 36: 4th Mode Shape for the Beam at Varying Root Pitch Angles with a One Pound Tip Weight

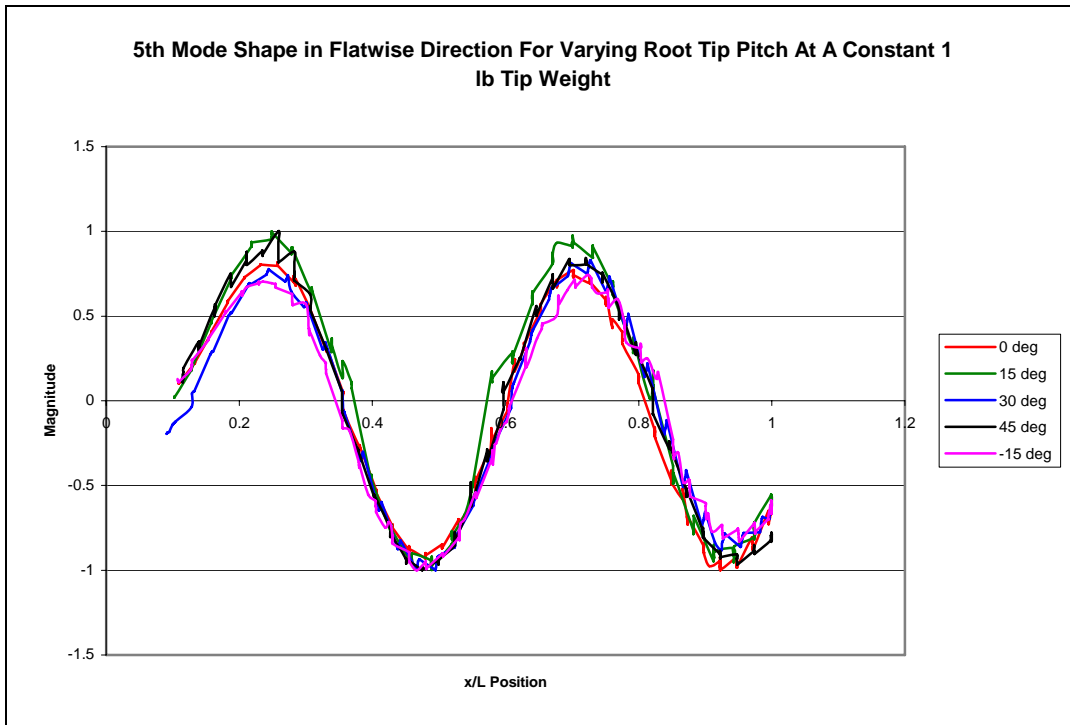

Figure 37: 5th Mode Shape for the Beam at Varying Root Pitch Angles with a One Pound Tip Weight

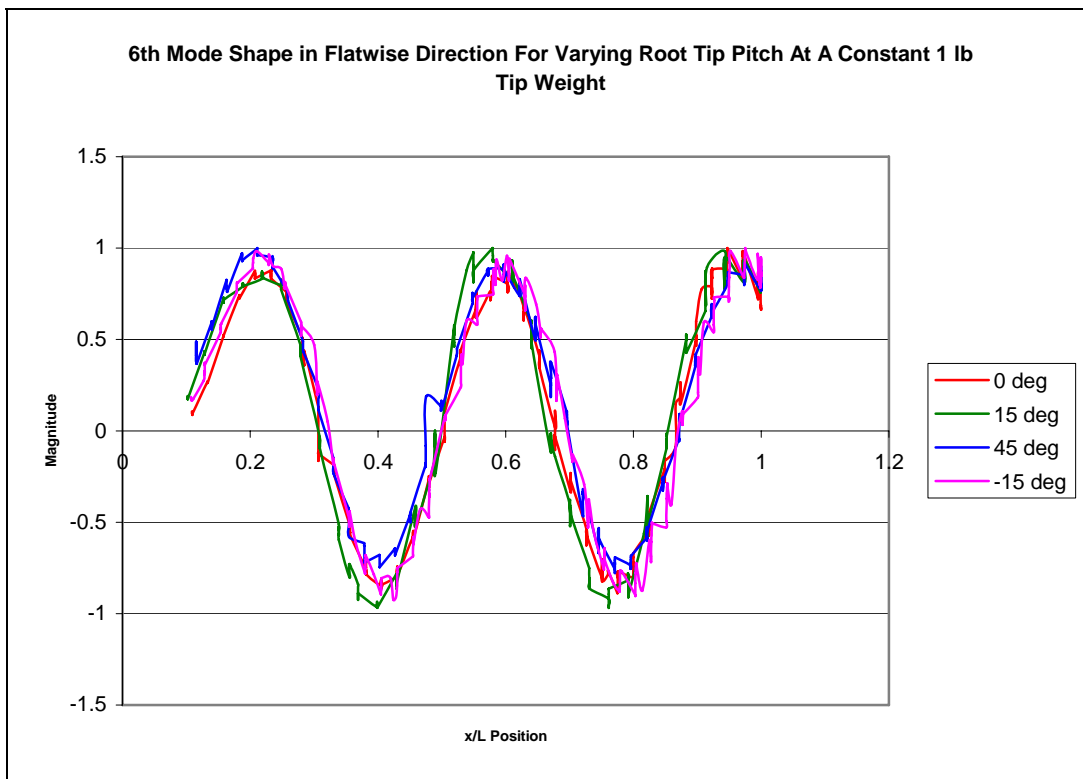

Figure 38: 6th Mode Shape for the Beam at Varying Root Pitch Angles with a One Pound Tip Weight

The one pound tip weight has very similar mode shapes; however the frequencies for these mode shapes are very different which can be seen in Table 8.

Table 8: Frequencies Corresponding to Mode Shapes from Figures 34-38

	Experimental 1lb Tip Weight						
	-45 deg	-30 deg	-15 deg	0 deg	15 deg	30 deg	45 deg
2nd mode			47.5		48.13	48.13	
3rd mode	150	183.1	146.3	151.3	147.5	147.5	150
4th mode			285.6	291.3	290	291.3	306.3
5th mode			477.5	493.8	496.3	493.1	506.9
6th mode			755.6	763.1	755		774.4

4.2.3 Mode Shape of Three Pound Tip Weight

The mode shapes for the three pound tip weights can be seen in Figures 39-43. All the mode shapes again look very similar; however, the natural frequencies for these mode shapes fluctuate with a change in root pitch angle. The largest fluctuation is 21.6%.

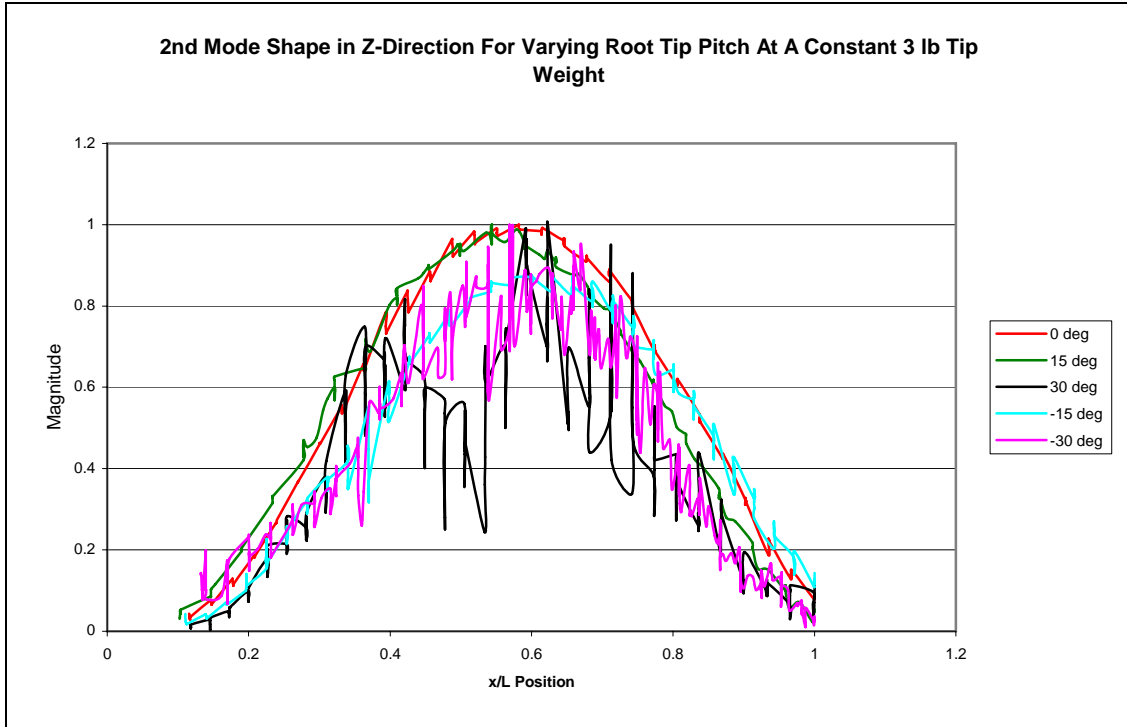

Figure 39: 2nd Mode Shape for the Beam at Varying Root Pitch Angles with a Three Pound Tip Weight

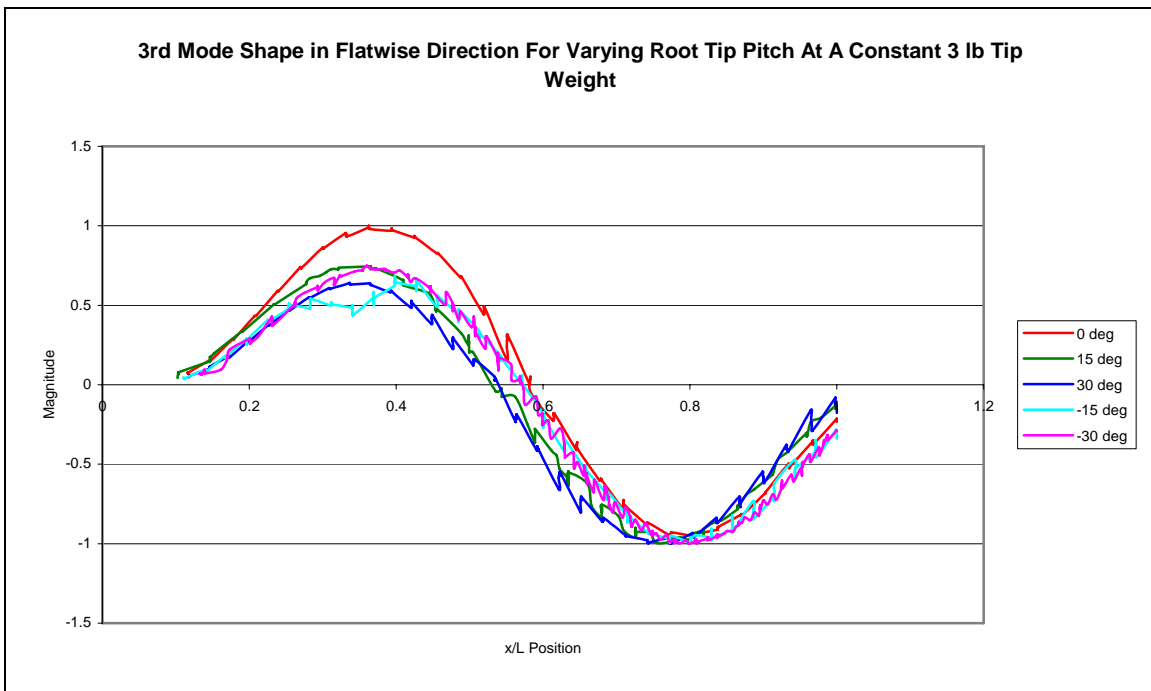

Figure 40: 3rd Mode Shape for the Beam at Varying Root Pitch Angles with a Three Pound Tip Weight

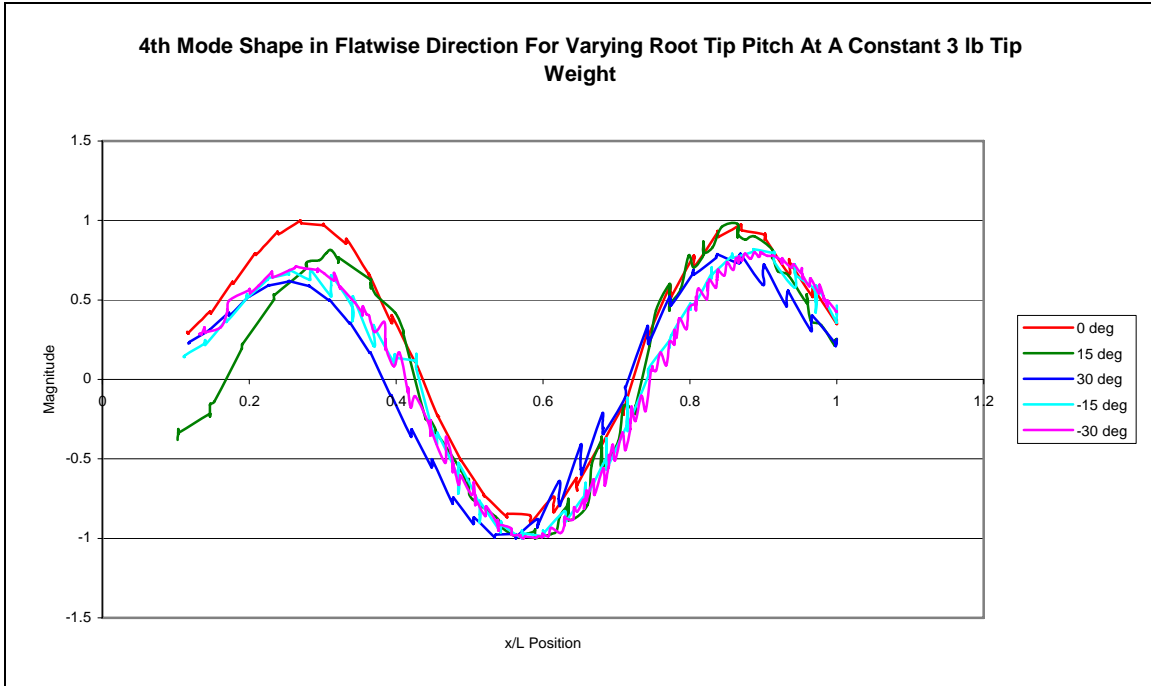

Figure 41: 4th Mode Shape for the Beam at Varying Root Pitch Angles with a Three Pound Tip Weight

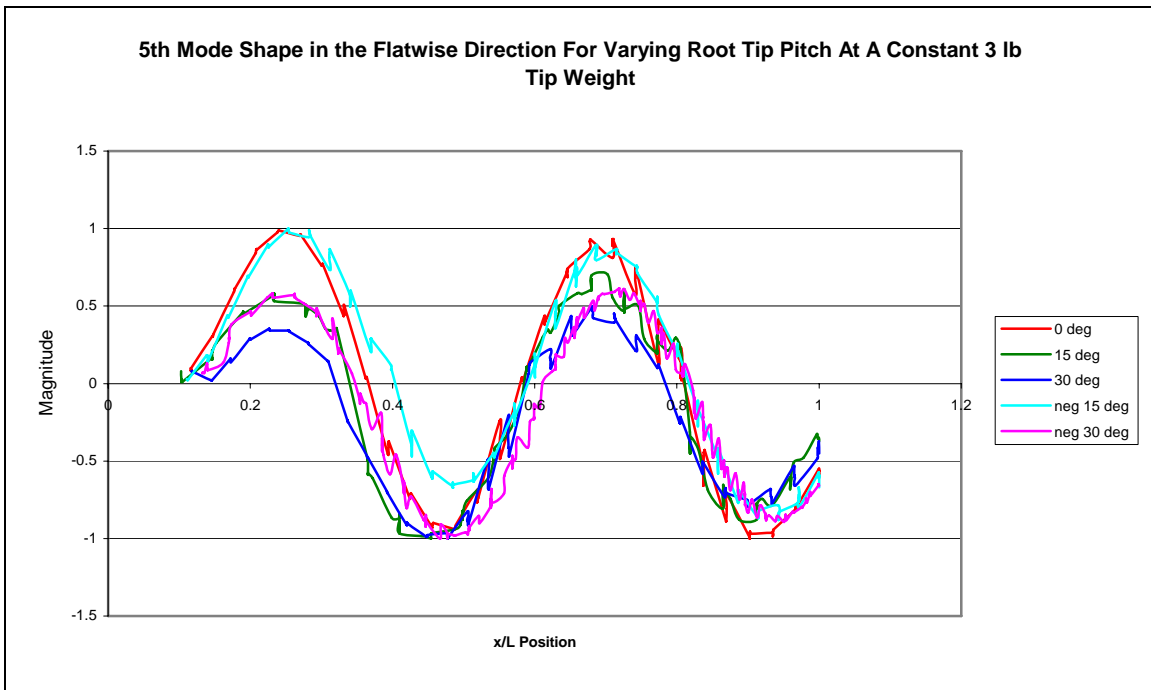

Figure 42: 5th Mode Shape for the Beam at Varying Root Pitch Angles with a Three Pound Tip Weight

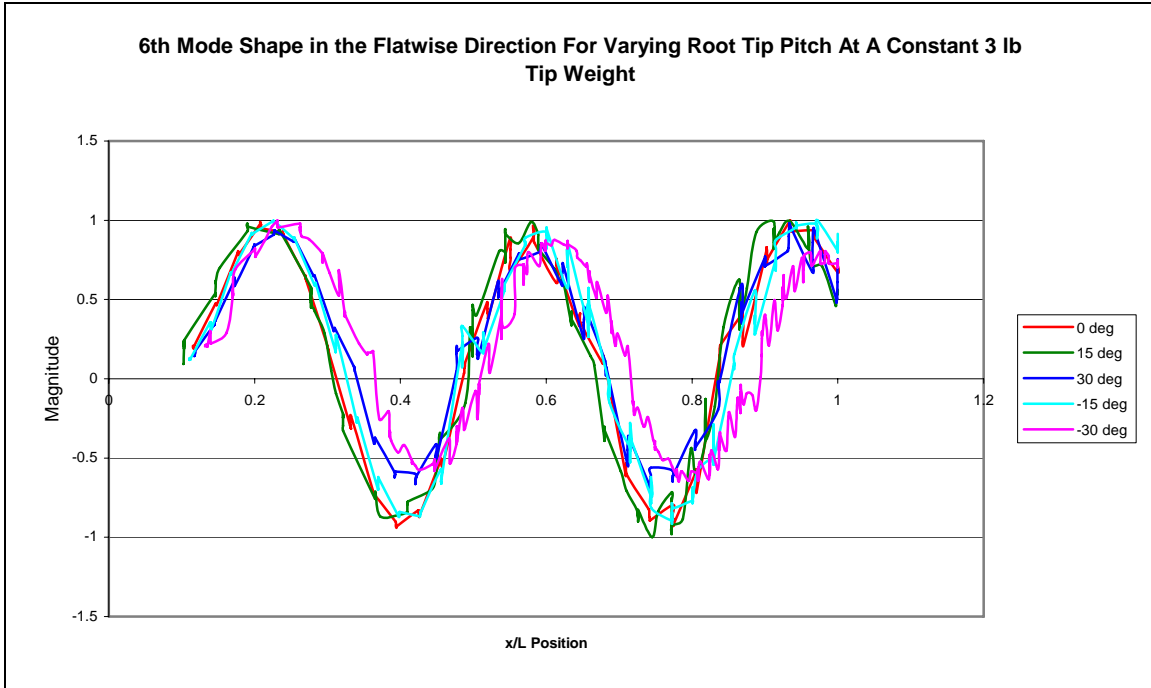

Figure 43: 6th Mode Shape for the Beam at Varying Root Pitch Angles with a Three Pound Tip Weight

Table 9: Frequencies Corresponding to Mode Shapes from Figures 39-43

	Experimental 3lb Tip Weight				
	-30 deg	-15 deg	0 deg	15 deg	30 deg
2nd mode	60	66.88	55.63	39.38	55
3rd mode	160	150	154.4	149.4	148.8
4th mode	301.9	295.6	299.4	285	293.1
5th mode	535.6	550	520.6	496.9	502.5
6th mode	841.3	792.5	780	800.6	808.1

5. Discussion

Following the experiment, the raw data was analyzed and appears to have promising results. Due to time constraints, multiple tests could not be completed to verify results; however, when compared to previous experiments, linear theory and a nonlinear finite element analysis, much of the results seem to be of good quality.

5.1 Conclusion and Recommendations

This investigation has found the nonlinear frequency response of a beam at varying pitch angles when a tip weight is added. This information can be useful in initial helicopter blade design since the nonlinear effects must be taken into account. The data also can validate finite element analysis programs. Although there were frequency results from the Princeton Beam Experiment, this investigation acquired data up to 2000 Hz, which encompasses up to the 6th mode for most cases.

The use of the laser vibrometer made the resolution of the results very accurate and acquired data for higher modes compared to that of the Princeton Beam Experiments. The linear results of the beam with no tip weights were extremely accurate with the linear equations. The laser vibrometer has an uncertainty of ± 0.01562 Hz, which, for the frequencies tested is less than 0.1% uncertainty for the worst case. However, there were problems that were encountered from the laser vibrometer. In previous experiments there were problems with the laser having insufficient scatter off of the beam, this was relieved by spraying the beam with a white reflective spray. Although this helped the situation, the deflection at $\pm 45^\circ$ with weights of 3 lbs or higher caused problems for the limited

vertical position of the lasers. In future tests this can be fixed by using stands which can hold the lasers at a higher position in order to decrease the angle.

Using the periodic chirp ended up not giving good results for the y-direction bending or for the twist. Only for one case, the 0 lb at 45 degrees was satisfactory twist and y-deflection data taken. This may be due to the excitation speaker being placed only in the z-direction. Testing with two speakers or just two separate tests may alleviate this problem.

The laser vibrometer measures velocities at every point determined by the generated grid. While measuring the velocities for modes in the flatwise direction, the magnitudes of the velocities differed from points that were in the same x-position, figure 43 does a great job in conveying this. The magnitude of the mode shape in Figure 43 varies and causes the graph to look inaccurate. This problem can be fixed multiple ways, one of which is by making a grid which only goes down the centerline of the beam. The problem with this approach would be the inability to measure twist. Another way to alleviate this problem is to use a densely populated grid and find the points from the data closest to the centerline and interpolate the magnitudes and positions of the points to represent the centerline. Fixing the problem with the changing velocities at the same x-position would eliminate the tooth-like appearance of the mode shape.

The use of the 3-D laser vibrometer made the testing run very smoothly. It was able to measure approximate static deflections, natural frequencies, and plot the mode shapes. Except for the negligible mass of the spray paint the laser vibrometer did not require any measuring devices fixed to the test specimen. Thus the measurements are free of error due to added mass/stiffness. The disadvantage of the 3-D laser vibrometer was

the amount of time each test took to set-up. This was caused by the 3-D alignment part of the set-up.

Appendix A: Raw Data for Frequencies` Below 250 Hz

beam_0lb_0deg_fast_60Hz						
FFT - Vib 3D Velocity -				Magnitude		
0 dB = 1 m/s						
1						
60.00 Hz						
Yes						
Yes						
X	Y	Z	Mag X	Mag Y	Mag Z	
0.0567627	0.0187332	-0.0050961	9.12E-07	2.36E-06	8.86E-06	
0.0567049	0.016055	-0.0046505	2.33E-07	7.30E-07	7.37E-06	
0.0565818	0.0132307	-0.0051882	1.71E-07	8.23E-07	7.99E-06	
0.0780054	0.0184938	-0.0048264	2.46E-06	4.52E-06	2.46E-05	
0.0779256	0.0157407	-0.0049761	2.15E-06	6.00E-06	2.31E-05	
0.0778618	0.0130975	-0.0041274	1.86E-06	3.91E-06	2.24E-05	
0.0993654	0.0183413	-0.0040044	3.65E-06	4.99E-06	4.46E-05	
0.0992842	0.0156359	-0.0036564	3.37E-06	6.82E-06	4.64E-05	
0.0991898	0.0128535	-0.003899	3.62E-06	6.45E-06	4.47E-05	
0.120777	0.0183036	-0.0021245	4.49E-06	3.01E-06	5.49E-05	
0.1207	0.0156527	-0.0013809	4.54E-06	6.78E-06	5.94E-05	
0.120623	0.0127518	-0.0024156	4.58E-06	6.32E-06	6.11E-05	
0.142231	0.0182412	-0.0005781	5.84E-06	3.35E-06	7.11E-05	
0.142173	0.0152923	-0.0020147	5.13E-06	4.70E-06	7.70E-05	
0.142088	0.0127273	-0.0004717	5.72E-06	4.27E-06	7.96E-05	
0.163765	0.0179398	-0.0007462	7.35E-06	3.96E-06	0.000103876	
0.16369	0.0153231	0.00039544	6.97E-06	3.76E-06	0.000108112	
0.163628	0.0124374	-0.0005413	6.91E-06	4.23E-06	0.000108539	
0.185331	0.0179936	0.0017336	8.43E-06	5.04E-06	0.000139073	
0.185249	0.0152778	0.00208058	7.79E-06	5.19E-06	0.000139887	
0.185189	0.0124401	0.00164131	7.89E-06	5.03E-06	0.000139949	
0.206981	0.0177841	0.00230566	7.87E-06	4.11E-06	0.000159843	
0.206948	0.0149138	0.00146303	7.81E-06	5.28E-06	0.0001594	
0.206857	0.012287	0.00250822	7.65E-06	6.24E-06	0.000159391	
0.228673	0.0176902	0.00364562	8.56E-06	3.30E-06	0.00015892	
0.228639	0.0148402	0.00310252	8.52E-06	4.57E-06	0.000159189	
0.228515	0.0122276	0.00424482	8.47E-06	6.49E-06	0.000164938	
0.250384	0.017656	0.00545921	9.07E-06	2.80E-06	0.000160509	
0.250381	0.0147681	0.00461923	8.93E-06	3.63E-06	0.000160448	
0.250299	0.0120332	0.00497123	8.89E-06	5.61E-06	0.000168084	
0.272182	0.0175363	0.00676114	9.63E-06	5.34E-06	0.000192036	

0.272115	0.0147764	0.00691035	9.60E-06	5.22E-06	0.000192282
0.271978	0.0121336	0.00795349	9.54E-06	6.03E-06	0.000193004
0.294011	0.0174573	0.00824059	9.41E-06	9.52E-06	0.000210127
0.293956	0.0146839	0.00829074	9.47E-06	9.59E-06	0.00021205
0.293874	0.0119751	0.00884065	9.51E-06	9.46E-06	0.000211731
0.315858	0.0174388	0.0101994	7.80E-06	1.29E-05	0.000199964
0.315849	0.0145951	0.00985722	7.89E-06	1.29E-05	0.000207982
0.315818	0.0117942	0.00971448	8.01E-06	1.26E-05	0.000208267
0.337863	0.0172595	0.0110606	5.67E-06	1.33E-05	0.000159644
0.337758	0.0145474	0.0116031	5.70E-06	1.36E-05	0.000166512
0.337728	0.0117714	0.0116597	5.78E-06	1.31E-05	0.000167895
0.359842	0.0171851	0.0125967	3.38E-06	1.15E-05	0.000124464
0.359688	0.0145353	0.0136325	3.26E-06	1.19E-05	0.000126308
0.359709	0.0116745	0.0131978	3.26E-06	1.20E-05	0.00012683
0.381781	0.0172099	0.0149098	1.33E-06	1.02E-05	0.000101719
0.381727	0.0144248	0.0150606	7.64E-07	1.08E-05	0.000104912
0.381705	0.0116451	0.0151179	6.02E-07	1.12E-05	0.000103556
0.403774	0.0171887	0.0170154	3.04E-06	9.63E-06	7.32E-05
0.403831	0.0143303	0.0164781	3.33E-06	1.00E-05	7.63E-05
0.403597	0.0117296	0.0179071	3.60E-06	1.01E-05	7.74E-05
0.425987	0.0170319	0.0179308	7.48E-06	7.45E-06	3.50E-05
0.425756	0.0144131	0.0192557	7.92E-06	8.36E-06	3.79E-05
0.425824	0.0115326	0.0187269	7.78E-06	8.56E-06	3.78E-05
0.448023	0.0170635	0.0203083	9.91E-06	6.86E-06	9.26E-06
0.447977	0.0143012	0.0205581	9.88E-06	8.71E-06	9.79E-06
0.44793	0.0115074	0.0207137	9.91E-06	8.99E-06	9.84E-06
0.470047	0.0171186	0.0228684	1.23E-05	6.95E-06	5.12E-05
0.470099	0.0142711	0.0226342	1.22E-05	8.13E-06	5.17E-05
0.470054	0.0114926	0.0227878	1.23E-05	7.14E-06	5.26E-05
0.492426	0.016964	0.0239674	1.58E-05	7.08E-06	9.33E-05
0.492139	0.0143342	0.0252815	1.57E-05	6.91E-06	9.22E-05
0.492322	0.0114105	0.0243681	1.71E-05	4.89E-06	0.000102108
0.514361	0.0171168	0.0272851	2.31E-05	4.93E-06	0.000162466
0.514496	0.0142293	0.0266608	2.31E-05	4.96E-06	0.000159393
0.514348	0.0115072	0.0272989	2.46E-05	4.51E-06	0.000169696
0.5366	0.0170853	0.0293344	3.04E-05	6.21E-06	0.000225847
0.536726	0.0142246	0.0288071	2.92E-05	6.16E-06	0.000215814
0.536436	0.0115753	0.0300231	2.94E-05	6.51E-06	0.000213912

Source File Name: beam_0lb_15deg_fast_60Hz
Signal: FFT - Vib 3D Velocity - Magnitude
dB-Reference: 0 dB = 1 m/s
Band No.: 1
Frequency: 60.00 Hz

Interpolated: Yes
Filtered: Yes

X	Y	Z	Mag X	Mag Y	Mag Z
0.0525786	0.0183739	-0.00945197	2.37E-06	5.98E-06	1.72E-05
0.0524399	0.0150012	-0.00808787	1.62E-06	5.13E-06	1.52E-05
0.052145	0.0119172	-0.00807937	7.81E-07	4.73E-06	1.49E-05
0.066827	0.0163648	-0.00757013	5.15E-07	5.28E-06	3.06E-05
0.0664505	0.0134657	-0.00854681	3.04E-07	4.85E-06	3.06E-05
0.0662332	0.0102044	-0.00765938	2.68E-07	5.03E-06	2.98E-05
0.0808676	0.0147424	-0.00762213	6.43E-07	4.09E-06	3.96E-05
0.0806053	0.0116024	-0.00732618	4.66E-07	4.51E-06	4.07E-05
0.0802319	0.00866764	-0.00809994	6.99E-07	4.88E-06	4.04E-05
0.0949482	0.0129953	-0.0070707	9.43E-07	2.33E-06	4.40E-05
0.0946236	0.00996159	-0.00725992	3.95E-07	2.63E-06	4.29E-05
0.0943447	0.00682896	-0.00705792	3.36E-07	3.35E-06	4.24E-05
0.10896	0.0113858	-0.00708219	5.44E-07	3.30E-06	6.75E-05
0.108701	0.00817545	-0.00649368	4.26E-07	3.65E-06	6.55E-05
0.108385	0.00516352	-0.00677591	2.92E-07	3.97E-06	6.54E-05
0.123021	0.00963239	-0.00649465	9.12E-07	4.74E-06	9.64E-05
0.12269	0.00660472	-0.0066824	9.71E-07	5.01E-06	9.89E-05
0.122422	0.00340018	-0.00608656	9.12E-07	5.47E-06	9.76E-05
0.137046	0.00793566	-0.00607972	1.55E-06	3.41E-06	0.00011
0.136734	0.00479454	-0.00578073	1.64E-06	3.78E-06	0.00012
0.136441	0.00165319	-0.0054772	1.63E-06	4.12E-06	0.00012
0.151037	0.00625965	-0.00584514	2.04E-06	1.23E-06	0.00013
0.150734	0.00315642	-0.00564105	2.03E-06	1.09E-06	0.00013
0.150382	0.000175933	-0.00611934	2.20E-06	1.89E-06	0.00014
0.165022	0.00463679	-0.00578572	2.15E-06	1.58E-06	0.00015
0.164711	0.00151814	-0.00558433	2.22E-06	1.38E-06	0.00015
0.164368	-0.00151886	-0.00576821	2.14E-06	3.72E-07	0.00015
0.178997	0.00295479	-0.00551552	2.55E-06	3.27E-06	0.00018
0.178689	-0.000202205	-0.00501579	2.45E-06	1.64E-06	0.00017
0.178359	-0.00335241	-0.00461065	2.07E-06	4.12E-06	0.00017
0.192956	0.00132767	-0.00541986	3.49E-06	2.67E-06	0.00022
0.192653	-0.00203868	-0.00394201	2.85E-06	4.21E-06	0.00022
0.192325	-0.00511054	-0.00392928	2.52E-06	6.72E-06	0.00021
0.206908	-0.000475245	-0.00452526	3.97E-06	4.15E-06	0.00023
0.206564	-0.00362421	-0.00402336	3.92E-06	3.63E-06	0.00022
0.206237	-0.00680958	-0.00342138	3.49E-06	7.86E-06	0.00022
0.22084	-0.00241657	-0.00282442	3.89E-06	5.34E-06	0.00021
0.220485	-0.00550166	-0.00271768	3.53E-06	6.94E-06	0.00021
0.22015	-0.00839889	-0.00348579	3.65E-06	7.27E-06	0.00021
0.234752	-0.00404893	-0.00267562	4.02E-06	8.12E-06	0.00022
0.234396	-0.00701796	-0.00315767	3.69E-06	8.57E-06	0.00021

0.234049	-0.0101796	-0.00265283	3.30E-06	8.39E-06	0.00022
0.248643	-0.00562073	-0.00300707	4.67E-06	1.00E-05	0.00024
0.248276	-0.00891721	-0.00171906	4.49E-06	1.04E-05	0.00023
0.24793	-0.011982	-0.00160288	4.12E-06	9.37E-06	0.00023
0.262528	-0.00741184	-0.00203913	4.81E-06	1.15E-05	0.00025
0.262171	-0.0105156	-0.00173234	4.73E-06	1.12E-05	0.00025
0.261794	-0.0136322	-0.00142311	4.77E-06	1.13E-05	0.00025
0.27637	-0.00925738	-0.00086154	4.38E-06	1.47E-05	0.00027
0.276011	-0.0122252	-0.00113995	4.53E-06	1.51E-05	0.00027
0.275647	-0.0153241	-0.000928793	4.50E-06	1.47E-05	0.00027
0.290242	-0.0108004	-0.00113586	3.76E-06	1.57E-05	0.00026
0.289853	-0.0139762	-0.000436358	3.97E-06	1.63E-05	0.00027
0.28948	-0.0169976	-0.000516426	4.01E-06	1.59E-05	0.00027
0.304022	-0.0126633	0.000171972	2.40E-06	1.47E-05	0.00023
0.303655	-0.0157068	0.00028635	2.77E-06	1.49E-05	0.00024
0.303293	-0.0187471	0.000203173	2.80E-06	1.45E-05	0.00024
0.317805	-0.0144535	0.00120475	1.47E-06	1.45E-05	0.00021
0.317442	-0.0174758	0.00111952	1.78E-06	1.45E-05	0.00021
0.317061	-0.0204947	0.0010393	1.74E-06	1.41E-05	0.00021
0.331612	-0.0161117	0.0014648	1.22E-06	1.61E-05	0.0002
0.331196	-0.0192059	0.00187247	1.18E-06	1.65E-05	0.0002
0.330861	-0.0221353	0.00130225	1.23E-06	1.65E-05	0.0002
0.345331	-0.0178983	0.00252662	1.06E-06	1.79E-05	0.00018
0.344981	-0.0208645	0.0021471	8.83E-07	1.85E-05	0.00018
0.344632	-0.023831	0.00177291	8.10E-07	1.86E-05	0.00018
0.359032	-0.0197229	0.00369773	1.63E-06	2.15E-05	0.00016
0.358673	-0.0227064	0.00341629	1.82E-06	2.19E-05	0.00016
0.358315	-0.0256334	0.00294671	1.76E-06	2.15E-05	0.00016
0.372737	-0.0214524	0.00439193	2.89E-06	2.51E-05	0.00014
0.372338	-0.0245083	0.00450202	2.65E-06	2.58E-05	0.00014
0.371946	-0.0274891	0.00442765	3.05E-06	2.43E-05	0.00014
0.386476	-0.0230913	0.00461054	4.60E-06	2.60E-05	0.00012
0.385976	-0.0263102	0.00570213	5.16E-06	2.66E-05	0.00012
0.385626	-0.0292185	0.00513448	4.58E-06	2.56E-05	0.00011
0.400175	-0.0247473	0.00504078	7.41E-06	2.17E-05	7.79E-05
0.399636	-0.028019	0.00632313	8.07E-06	2.25E-05	7.88E-05
0.399296	-0.0309311	0.00585794	8.19E-06	2.16E-05	7.80E-05
0.413794	-0.0265296	0.00606691	7.75E-06	2.01E-05	4.34E-05
0.413252	-0.0297818	0.00725014	9.26E-06	1.95E-05	4.86E-05
0.41287	-0.0327267	0.0069788	9.07E-06	1.90E-05	4.52E-05
0.427456	-0.0282019	0.00651787	8.84E-06	1.87E-05	1.37E-05
0.426938	-0.0313831	0.00741	9.21E-06	1.84E-05	1.40E-05
0.426569	-0.0343501	0.00713614	9.67E-06	1.76E-05	1.46E-05
0.441035	-0.0299817	0.00756669	1.05E-05	1.81E-05	2.24E-05
0.440553	-0.0330713	0.00796783	1.12E-05	1.74E-05	2.17E-05
0.440118	-0.0361089	0.00818491	1.14E-05	1.74E-05	2.12E-05
0.454525	-0.0318087	0.00891538	1.23E-05	1.84E-05	5.93E-05

0.454165	-0.0347608	0.00853771	1.30E-05	1.70E-05	5.83E-05
0.453549	-0.0380039	0.0098208	1.35E-05	1.68E-05	5.87E-05
0.468103	-0.0335124	0.00959296	1.39E-05	2.02E-05	9.96E-05
0.46762	-0.0365844	0.00989427	1.43E-05	1.88E-05	0.0001
0.467201	-0.0395882	0.00991471	1.44E-05	1.83E-05	0.0001
0.481533	-0.0353506	0.0109546	1.68E-05	2.08E-05	0.00015
0.48111	-0.038356	0.0109688	1.62E-05	2.20E-05	0.00015
0.480746	-0.0412721	0.0104997	1.68E-05	2.18E-05	0.00015
0.495052	-0.0370671	0.0117464	2.04E-05	1.75E-05	0.0002
0.494524	-0.0401563	0.012243	2.01E-05	1.98E-05	0.0002
0.49421	-0.0430423	0.0115815	2.04E-05	2.28E-05	0.00021
0.50857	-0.0387443	0.0123498	2.53E-05	1.41E-05	0.00027
0.508085	-0.0417836	0.0125534	2.37E-05	1.75E-05	0.00027
0.507496	-0.0449418	0.0134447	2.41E-05	1.93E-05	0.00026
0.521873	-0.0406251	0.0140232	2.82E-05	1.37E-05	0.00031
0.521493	-0.0435453	0.0136478	2.67E-05	1.38E-05	0.00029
0.521036	-0.0465699	0.0137613	2.55E-05	1.55E-05	0.00028

Source File Name: beam_0lb_15deg_fast_168.8Hz
Signal: FFT - Vib 3D Velocity - Magnitude
dB-Reference: 0 dB = 1 m/s
Band No.: 1
Frequency: 168.8 Hz

Interpolated: Yes
Filtered: Yes

X	Y	Z	Mag X	Mag Y	Mag Z
0.0525786	0.0183739	-0.00945197	1.02E-05	2.78E-05	9.24E-05
0.0524399	0.0150012	-0.00808787	9.26E-06	2.49E-05	8.83E-05
0.052145	0.0119172	-0.00807937	9.68E-06	2.39E-05	9.32E-05
0.066827	0.0163648	-0.00757013	6.64E-06	2.95E-05	0.00017
0.0664505	0.0134657	-0.00854681	8.16E-06	2.64E-05	0.00017
0.0662332	0.0102044	-0.00765938	9.24E-06	2.52E-05	0.00017
0.0808676	0.0147424	-0.00762213	5.55E-06	2.63E-05	0.00029
0.0806053	0.0116024	-0.00732618	6.55E-06	2.61E-05	0.00029
0.0802319	0.00866764	-0.00809994	7.72E-06	2.37E-05	0.00029
0.0949482	0.0129953	-0.0070707	3.95E-06	1.83E-05	0.00042
0.0946236	0.00996159	-0.00725992	3.75E-06	1.73E-05	0.00042
0.0943447	0.00682896	-0.00705792	3.26E-06	1.64E-05	0.00042
0.10896	0.0113858	-0.00708219	4.71E-06	1.62E-05	0.00055
0.108701	0.00817545	-0.00649368	4.77E-06	1.71E-05	0.00056
0.108385	0.00516352	-0.00677591	6.49E-06	1.64E-05	0.00056
0.123021	0.00963239	-0.00649465	5.24E-06	1.76E-05	0.00068
0.12269	0.00660472	-0.0066824	5.14E-06	2.04E-05	0.00069
0.122422	0.00340018	-0.00608656	6.87E-06	2.05E-05	0.00069
0.137046	0.00793566	-0.00607972	6.38E-06	1.46E-05	0.00079
0.136734	0.00479454	-0.00578073	6.20E-06	1.51E-05	0.00079
0.136441	0.00165319	-0.0054772	5.80E-06	1.37E-05	0.00079

0.151037	0.00625965	-0.00584514	6.46E-06	2.33E-05	0.00087
0.150734	0.00315642	-0.00564105	6.39E-06	2.45E-05	0.00087
0.150382	0.000175933	-0.00611934	5.53E-06	2.30E-05	0.00087
0.165022	0.00463679	-0.00578572	4.90E-06	3.32E-05	0.00092
0.164711	0.00151814	-0.00558433	4.96E-06	3.43E-05	0.00093
0.164368	-0.00151886	-0.00576821	4.31E-06	3.76E-05	0.00092
0.178997	0.00295479	-0.00551552	4.55E-06	4.49E-05	0.00094
0.178689	-0.000202205	-0.00501579	4.48E-06	4.68E-05	0.00094
0.178359	-0.00335241	-0.00461065	3.93E-06	4.86E-05	0.00094
0.192956	0.00132767	-0.00541986	3.39E-06	5.84E-05	0.00093
0.192653	-0.00203868	-0.00394201	3.32E-06	5.68E-05	0.00093
0.192325	-0.00511054	-0.00392928	2.93E-06	5.92E-05	0.00093
0.206908	-0.000475245	-0.00452526	5.31E-06	7.40E-05	0.00086
0.206564	-0.00362421	-0.00402336	6.43E-06	7.25E-05	0.00087
0.206237	-0.00680958	-0.00342138	6.93E-06	7.22E-05	0.00087
0.22084	-0.00241657	-0.00282442	1.15E-05	8.35E-05	0.00076
0.220485	-0.00550166	-0.00271768	1.28E-05	8.04E-05	0.00077
0.22015	-0.00839889	-0.00348579	1.27E-05	7.66E-05	0.00077
0.234752	-0.00404893	-0.00267562	1.66E-05	8.71E-05	0.00064
0.234396	-0.00701796	-0.00315767	1.85E-05	8.26E-05	0.00065
0.234049	-0.0101796	-0.00265283	1.90E-05	7.82E-05	0.00065
0.248643	-0.00562073	-0.00300707	2.15E-05	8.51E-05	0.00049
0.248276	-0.00891721	-0.00171906	2.39E-05	8.42E-05	0.00049
0.24793	-0.011982	-0.00160288	2.58E-05	7.99E-05	0.00049
0.262528	-0.00741184	-0.00203913	2.61E-05	8.33E-05	0.00032
0.262171	-0.0105156	-0.00173234	2.84E-05	8.58E-05	0.00032
0.261794	-0.0136322	-0.00142311	2.94E-05	8.47E-05	0.00032
0.27637	-0.00925738	-0.00086154	3.26E-05	8.14E-05	0.00014
0.276011	-0.0122252	-0.00113995	3.32E-05	8.51E-05	0.00014
0.275647	-0.0153241	-0.000928793	3.36E-05	8.63E-05	0.00014
0.290242	-0.0108004	-0.00113586	3.69E-05	7.13E-05	4.97E-05
0.289853	-0.0139762	-0.000436358	3.69E-05	7.40E-05	4.71E-05
0.28948	-0.0169976	-0.000516426	3.69E-05	7.40E-05	4.47E-05
0.304022	-0.0126633	0.000171972	4.45E-05	5.97E-05	0.00023
0.303655	-0.0157068	0.00028635	4.43E-05	6.01E-05	0.00023
0.303293	-0.0187471	0.000203173	4.42E-05	6.02E-05	0.00023
0.317805	-0.0144535	0.00120475	5.23E-05	4.68E-05	0.0004
0.317442	-0.0174758	0.00111952	5.23E-05	4.75E-05	0.0004
0.317061	-0.0204947	0.0010393	5.06E-05	4.78E-05	0.0004
0.331612	-0.0161117	0.0014648	5.51E-05	3.20E-05	0.00055
0.331196	-0.0192059	0.00187247	5.38E-05	3.29E-05	0.00055
0.330861	-0.0221353	0.00130225	5.17E-05	3.40E-05	0.00055
0.345331	-0.0178983	0.00252662	5.52E-05	1.67E-05	0.00067
0.344981	-0.0208645	0.0021471	5.46E-05	1.44E-05	0.00067
0.344632	-0.023831	0.00177291	5.25E-05	1.53E-05	0.00068
0.359032	-0.0197229	0.00369773	5.41E-05	7.39E-06	0.00077
0.358673	-0.0227064	0.00341629	5.32E-05	1.09E-05	0.00077
0.358315	-0.0256334	0.00294671	5.33E-05	1.48E-05	0.00077
0.372737	-0.0214524	0.00439193	5.03E-05	2.21E-05	0.00082
0.372338	-0.0245083	0.00450202	5.01E-05	2.12E-05	0.00082
0.371946	-0.0274891	0.00442765	5.03E-05	2.43E-05	0.00082
0.386476	-0.0230913	0.00461054	4.55E-05	3.67E-05	0.00083

0.385976	-0.0263102	0.00570213	4.27E-05	3.45E-05	0.00083
0.385626	-0.0292185	0.00513448	4.25E-05	3.29E-05	0.00082
0.400175	-0.0247473	0.00504078	3.70E-05	4.92E-05	0.00081
0.399636	-0.028019	0.00632313	3.19E-05	4.81E-05	0.0008
0.399296	-0.0309311	0.00585794	3.00E-05	4.84E-05	0.00079
0.413794	-0.0265296	0.00606691	3.07E-05	6.56E-05	0.00073
0.413252	-0.0297818	0.00725014	2.68E-05	6.66E-05	0.00072
0.41287	-0.0327267	0.0069788	2.57E-05	6.52E-05	0.00072
0.427456	-0.0282019	0.00651787	2.23E-05	7.65E-05	0.00061
0.426938	-0.0313831	0.00741	2.14E-05	7.47E-05	0.0006
0.426569	-0.0343501	0.00713614	2.12E-05	7.49E-05	0.0006
0.441035	-0.0299817	0.00756669	1.16E-05	7.93E-05	0.00046
0.440553	-0.0330713	0.00796783	1.16E-05	7.75E-05	0.00045
0.440118	-0.0361089	0.00818491	8.84E-06	7.80E-05	0.00045
0.454525	-0.0318087	0.00891538	1.18E-06	8.35E-05	0.00028
0.454165	-0.0347608	0.00853771	3.16E-06	8.21E-05	0.00028
0.453549	-0.0380039	0.0098208	6.43E-06	8.37E-05	0.00027
0.468103	-0.0335124	0.00959296	1.59E-05	8.29E-05	8.81E-05
0.46762	-0.0365844	0.00989427	1.57E-05	8.40E-05	8.90E-05
0.467201	-0.0395882	0.00991471	1.86E-05	8.54E-05	8.81E-05
0.481533	-0.0353506	0.0109546	3.36E-05	7.85E-05	0.00018
0.48111	-0.038356	0.0109688	3.37E-05	8.28E-05	0.00018
0.480746	-0.0412721	0.0104997	3.36E-05	8.47E-05	0.00018
0.495052	-0.0370671	0.0117464	4.87E-05	7.10E-05	0.00042
0.494524	-0.0401563	0.012243	4.91E-05	7.59E-05	0.00043
0.49421	-0.0430423	0.0115815	5.23E-05	7.86E-05	0.00043
0.50857	-0.0387443	0.0123498	5.93E-05	6.11E-05	0.00068
0.508085	-0.0417836	0.0125534	6.06E-05	6.23E-05	0.00068
0.507496	-0.0449418	0.0134447	6.60E-05	6.00E-05	0.00068
0.521873	-0.0406251	0.0140232	7.22E-05	5.77E-05	0.00088
0.521493	-0.0435453	0.0136478	7.20E-05	5.22E-05	0.00089
0.521036	-0.0465699	0.0137613	7.53E-05	4.69E-05	0.00087

Source File

Name: beam0lb_30deg_fast_168.8Hz
Signal: FFT - Vib 3D Velocity - Magnitude
dB-Reference: 0 dB = 1 m/s
Band No.: 1
Frequency: 168.8 Hz

Interpolated: Yes
Filtered: Yes

X	Y	Z	Mag X	Mag Y	Mag Z
0.0780807	0.0178588	-0.0112446	3.27E-05	2.52E-05	0.000425271
0.0910977	0.0162863	-0.0113467	3.75E-05	7.26E-05	0.000712724
0.0909522	0.0151186	-0.0118792	4.09E-05	8.89E-05	0.00072829
0.0779314	0.0164491	-0.0113396	3.08E-05	2.75E-05	0.000405276
0.0908001	0.0137578	-0.0120603	3.51E-05	9.58E-05	0.000742807

0.0777932	0.0156187	-0.0124842	3.05E-05	2.41E-05	0.000383246
0.0906413	0.0122047	-0.0118897	3.06E-05	0.000106442	0.000745422
0.0776312	0.0135341	-0.0113505	2.53E-05	2.34E-05	0.000392961
0.090476	0.0104601	-0.0113669	2.74E-05	0.000115937	0.000756977
0.0774957	0.0128473	-0.0127564	2.67E-05	2.21E-05	0.000406758
0.104143	0.01505	-0.0120624	4.03E-05	0.000175795	0.00102575
0.103958	0.0131115	-0.0111933	3.62E-05	0.000188481	0.0010512
0.103834	0.0123773	-0.0125132	3.32E-05	0.000194733	0.00105459
0.103644	0.0103446	-0.0114657	2.57E-05	0.000212041	0.00104644
0.103466	0.00855367	-0.0108545	2.91E-05	0.00021424	0.00104877
0.117152	0.0131868	-0.0116397	3.07E-05	0.000275196	0.00133343
0.116983	0.011683	-0.0115586	2.76E-05	0.000283438	0.00135738
0.116826	0.0103719	-0.0118268	2.06E-05	0.000287509	0.00136329
0.116638	0.00858133	-0.0112169	2.18E-05	0.000302947	0.00134794
0.1165	0.00755836	-0.0120089	3.01E-05	0.000305949	0.00137154
0.1302	0.0115129	-0.0115678	2.69E-05	0.000397537	0.00170633
0.130017	0.00991415	-0.0113112	2.25E-05	0.000411228	0.00173743
0.12985	0.00850794	-0.0114038	2.17E-05	0.000413764	0.00173685
0.129635	0.0065276	-0.0104426	2.02E-05	0.00040694	0.00171807
0.129515	0.00569646	-0.0115852	3.14E-05	0.000414014	0.00171873
0.14323	0.00988894	-0.0115831	2.40E-05	0.000523364	0.00206708
0.143067	0.00857867	-0.0118522	2.09E-05	0.000536568	0.00207734
0.142857	0.00678999	-0.0112434	2.07E-05	0.000533764	0.00207106
0.142699	0.00552825	-0.0115977	2.77E-05	0.00051323	0.00204318
0.156211	0.00770426	-0.0105379	2.36E-05	0.000644331	0.00238287
0.156087	0.00676152	-0.0115168	1.63E-05	0.000647356	0.00237215
0.1559	0.00526099	-0.0114339	1.50E-05	0.000633889	0.00235459
0.15574	0.00399948	-0.0117882	1.97E-05	0.000606676	0.00234593
0.169402	0.00712767	-0.0124804	2.83E-05	0.000713106	0.00259925
0.169146	0.00514946	-0.0115227	2.39E-05	0.000712012	0.00258939
0.168919	0.00339518	-0.0110103	2.08E-05	0.000707042	0.00258055
0.168763	0.0021819	-0.0114522	2.23E-05	0.000693514	0.00258028
0.169515	0.00800712	-0.0114215	3.45E-05	0.000717566	0.0026269
0.182596	0.00647216	-0.0116109	3.34E-05	0.000749551	0.00271559
0.18241	0.00506746	-0.0117061	2.97E-05	0.000751735	0.00272604
0.182182	0.0033773	-0.0112742	2.78E-05	0.00075217	0.00272282
0.182031	0.00221142	-0.0118051	2.63E-05	0.000748124	0.0027135
0.181808	0.000553997	-0.0114669	2.37E-05	0.000742165	0.002712
0.19569	0.00498335	-0.0118873	3.36E-05	0.00078413	0.0027575
0.195484	0.00348377	-0.0118076	3.25E-05	0.000774348	0.00275925
0.195286	0.00203228	-0.0118141	3.26E-05	0.000764742	0.00275638
0.195041	0.000296464	-0.0112932	3.17E-05	0.000752716	0.00274399
0.19485	-0.00110635	-0.0113846	3.00E-05	0.000750934	0.002743
0.208743	0.00322352	-0.0116287	3.72E-05	0.000778596	0.00272755
0.208556	0.00186725	-0.0118119	3.72E-05	0.000768637	0.00272209
0.208368	0.000494914	-0.0120029	3.70E-05	0.000746016	0.00270624
0.208079	-0.0014293	-0.0111318	3.83E-05	0.000742278	0.00269334
0.207926	-0.00259505	-0.0116618	3.68E-05	0.000744479	0.00269282
0.221795	0.00154378	-0.0115542	4.21E-05	0.000723962	0.00256208
0.221623	0.00028263	-0.0119128	3.96E-05	0.000713544	0.00255812

0.221303	-0.00173568	-0.0108686	4.02E-05	0.000695727	0.00254628
0.221147	-0.00291768	-0.0114087	4.31E-05	0.000681577	0.00253633
0.220985	-0.00413094	-0.0118514	4.41E-05	0.000704833	0.00255059
0.234901	2.12E-06	-0.011741	4.16E-05	0.000641559	0.00228498
0.234676	-0.0014955	-0.0116621	4.31E-05	0.000637442	0.0022869
0.234532	-0.00261487	-0.0122826	4.44E-05	0.00061624	0.00228117
0.234187	-0.0046776	-0.0111499	5.34E-05	0.000606009	0.00228426
0.233963	-0.00617323	-0.0110667	5.79E-05	0.000616885	0.00230727
0.247966	-0.00176196	-0.0114803	4.54E-05	0.000543063	0.00193606
0.247703	-0.00340034	-0.0111393	4.84E-05	0.000534545	0.00193643
0.247632	-0.00420625	-0.0123817	5.12E-05	0.000531753	0.00193872
0.247164	-0.00673752	-0.0103739	5.98E-05	0.00050985	0.00194758
0.24703	-0.00780931	-0.0110796	6.51E-05	0.000518465	0.00198175
0.261027	-0.00349427	-0.0113162	6.01E-05	0.000419083	0.00154505
0.260744	-0.00517875	-0.0108884	6.78E-05	0.000407201	0.00153706
0.260646	-0.00611037	-0.0118591	7.18E-05	0.000400825	0.00153844
0.26034	-0.00788754	-0.0112534	7.34E-05	0.00039351	0.00154548
0.260089	-0.00944533	-0.0110927	7.57E-05	0.000398597	0.00156747
0.274154	-0.00507404	-0.0114035	7.19E-05	0.000281032	0.00109293
0.273749	-0.00719633	-0.0101985	8.25E-05	0.000260848	0.00108967
0.273592	-0.00836274	-0.0107317	9.07E-05	0.000255483	0.00108883
0.2733	-0.0100443	-0.0103014	8.76E-05	0.000259601	0.00109191
0.273057	-0.0115378	-0.0102196	8.73E-05	0.000293961	0.00116481
0.287086	-0.00727723	-0.010365	8.91E-05	0.000143325	0.000604932
0.286916	-0.00849107	-0.0108124	9.20E-05	0.000124636	0.00059703
0.286601	-0.0102193	-0.0102971	9.74E-05	0.000118031	0.000596576
0.286535	-0.0110594	-0.0114419	8.33E-05	0.000120701	0.000596305
0.300158	-0.00906249	-0.010111	9.27E-05	1.86E-05	9.18E-05
0.300027	-0.0101364	-0.0108208	9.08E-05	2.76E-05	8.48E-05
0.299633	-0.0120969	-0.00986969	8.77E-05	3.84E-05	7.84E-05
0.299544	-0.0130311	-0.0108396	7.88E-05	3.10E-05	8.64E-05
0.300387	-0.0076451	-0.0100023	0.000101521	2.59E-05	1.11E-05
0.313456	-0.00943046	-0.00974795	0.000101518	0.000164792	0.000430314
0.31334	-0.0104583	-0.0105463	9.82E-05	0.000168076	0.000429167
0.313195	-0.0115799	-0.0111694	9.27E-05	0.000171814	0.000433606
0.312803	-0.0134925	-0.0103071	9.08E-05	0.000164686	0.000426538
0.312585	-0.0148461	-0.0104912	8.36E-05	0.000155875	0.000415658
0.326629	-0.0108735	-0.010095	0.000102984	0.000294867	0.000915653
0.326223	-0.0127861	-0.00923714	0.00010719	0.000297304	0.000914837
0.32603	-0.0140631	-0.00960748	0.00010782	0.000303545	0.000915696
0.325901	-0.0151384	-0.0103168	9.96E-05	0.000303408	0.00091493
0.325557	-0.0168626	-0.00980323	0.000101735	0.000276233	0.000875507
0.339645	-0.012799	-0.0095796	9.74E-05	0.000409744	0.0013518
0.339323	-0.0144316	-0.00924593	0.000104622	0.000416932	0.00135522
0.339114	-0.015739	-0.0095208	0.000104529	0.00042985	0.00136353
0.338953	-0.0169077	-0.0100562	9.98E-05	0.000433449	0.00136185
0.352759	-0.0144791	-0.00948936	9.35E-05	0.000505579	0.00174328
0.352462	-0.0160186	-0.00933109	9.59E-05	0.000514555	0.00174323
0.352283	-0.0172341	-0.009781	9.70E-05	0.000520224	0.00174275
0.351886	-0.0190492	-0.00909729	9.71E-05	0.00050637	0.00173188

0.353207	-0.0125216	-0.010429	8.80E-05	0.000512998	0.00181263
0.366053	-0.0149604	-0.0089554	8.62E-05	0.000572165	0.00205592
0.365925	-0.0160381	-0.00966902	8.77E-05	0.00057731	0.00205415
0.365569	-0.0177157	-0.00925112	8.65E-05	0.000586785	0.00205227
0.365318	-0.019116	-0.00935364	9.02E-05	0.000590298	0.00204889
0.365087	-0.0204536	-0.00953296	9.21E-05	0.000575135	0.00204054
0.379284	-0.0163656	-0.00938544	8.03E-05	0.00062513	0.00228113
0.378717	-0.0185495	-0.008015	8.03E-05	0.000624448	0.00227992
0.378553	-0.0197196	-0.00855391	7.94E-05	0.000626256	0.00227721
0.378627	-0.0202932	-0.0102221	8.17E-05	0.000628893	0.00227763
0.377841	-0.0230233	-0.00780264	8.64E-05	0.000622519	0.00227015
0.392337	-0.0182004	-0.00904503	7.57E-05	0.000635459	0.00239456
0.391736	-0.0204114	-0.0075812	7.46E-05	0.000631842	0.00239056
0.391686	-0.0213072	-0.00864157	7.38E-05	0.000625625	0.00238749
0.391406	-0.0227531	-0.00865925	7.78E-05	0.000624741	0.00238359
0.39107	-0.0243357	-0.00841494	8.10E-05	0.000625789	0.00237921
0.405313	-0.0202519	-0.00826062	6.32E-05	0.000610162	0.00238181
0.404969	-0.0218359	-0.00802203	6.19E-05	0.000608943	0.00238346
0.404726	-0.0231743	-0.00820649	6.18E-05	0.000596897	0.00238126
0.404462	-0.0245744	-0.00831207	6.36E-05	0.0006006	0.00237933
0.405518	-0.0189882	-0.00789133	6.15E-05	0.000608775	0.00237498
0.418638	-0.0206697	-0.00780227	5.38E-05	0.000542315	0.00224558
0.418287	-0.0222538	-0.00756661	4.80E-05	0.000541106	0.00224428
0.417957	-0.0237914	-0.007416	4.62E-05	0.000549109	0.00225264
0.417996	-0.0245086	-0.00882328	4.72E-05	0.000550142	0.00225491
0.417626	-0.0261205	-0.00848801	5.10E-05	0.000558428	0.00225552
0.431852	-0.0221871	-0.00806802	4.89E-05	0.000473628	0.00202802
0.43124	-0.024301	-0.00678759	3.48E-05	0.000465365	0.00201934
0.431009	-0.0256107	-0.0070708	3.13E-05	0.000466445	0.00202067
0.430756	-0.0269657	-0.00726636	3.47E-05	0.000457419	0.00201921
0.43057	-0.0281681	-0.00771139	3.78E-05	0.000452713	0.00201444
0.445128	-0.0236004	-0.00849638	4.14E-05	0.000361032	0.00168821
0.444409	-0.0259105	-0.00688288	1.90E-05	0.000365208	0.00167629
0.444155	-0.0272499	-0.00707184	1.73E-05	0.00036689	0.00167649
0.443943	-0.028515	-0.00744157	2.36E-05	0.000370617	0.00168295
0.4436	-0.0300348	-0.00728243	2.21E-05	0.000365961	0.00173046
0.457633	-0.0265539	-0.00599484	1.45E-05	0.000231823	0.00124921
0.457442	-0.0277744	-0.00645389	3.76E-06	0.000229869	0.00123111
0.457184	-0.029114	-0.00664404	1.24E-06	0.000241652	0.00123224
0.457014	-0.0302895	-0.00718738	9.47E-06	0.000259447	0.00125506
0.471027	-0.0277412	-0.00685728	9.29E-06	8.85E-05	0.000725851
0.470458	-0.0296845	-0.00593965	2.73E-05	8.26E-05	0.000719752
0.47015	-0.0311144	-0.00595867	2.30E-05	8.64E-05	0.000729265
0.469745	-0.0327401	-0.00564067	1.93E-05	9.32E-05	0.000746272
0.471406	-0.0261741	-0.00709346	1.09E-05	8.73E-05	0.000646283
0.484288	-0.028354	-0.00606297	1.66E-05	9.88E-05	0.000117295
0.483779	-0.0301617	-0.00540768	3.58E-05	0.000131051	0.000107941
0.483683	-0.0311879	-0.00620363	4.12E-05	0.000155592	0.000106245
0.483296	-0.0327529	-0.00596632	3.66E-05	0.000149629	0.000125881
0.483028	-0.0341096	-0.00616703	3.43E-05	0.000148545	0.000135562

0.497345	-0.0302192	-0.00563562	4.25E-05	0.000274913	0.000543292
0.49685	-0.0319809	-0.00506878	5.65E-05	0.000312157	0.000556535
0.496556	-0.0333667	-0.00517814	5.72E-05	0.000317485	0.000552882
0.496137	-0.0349756	-0.00485663	5.57E-05	0.000310643	0.000542986
0.495965	-0.0361538	-0.00540227	6.58E-05	0.000341685	0.000516348
0.510197	-0.0324079	-0.00462479	7.59E-05	0.000494797	0.00125763
0.509796	-0.0339731	-0.00439402	7.48E-05	0.000488148	0.00124584
0.509549	-0.0352699	-0.00467634	7.13E-05	0.000457566	0.00123035
0.509352	-0.0364775	-0.00512918	7.43E-05	0.000463043	0.00121296
0.523002	-0.0346688	-0.00343635	9.24E-05	0.000649193	0.00195728
0.522778	-0.0359217	-0.00380659	9.52E-05	0.000653089	0.0019602
0.522791	-0.0367747	-0.00494651	8.77E-05	0.000631814	0.00194427
0.522172	-0.0386938	-0.00403002	9.03E-05	0.000615874	0.00191441
0.531909	-0.0395824	-0.00462163	9.47E-05	0.000729891	0.00238454
0.531276	-0.040822	-0.00370793	0.000110417	0.000709694	0.00232897
0.521895	-0.0398137	-0.00387748	0.000110257	0.000616401	0.00187776
0.532296	-0.0385656	-0.00385705	9.72E-05	0.000724219	0.00241846
0.533094	-0.0368355	-0.00446316	0.000100783	0.000769186	0.00244822
0.533562	-0.0356856	-0.00395281	9.96E-05	0.000781251	0.00246623
0.534135	-0.0343745	-0.00379234	8.54E-05	0.000742583	0.00246846
0.5237	-0.0326128	-0.0046046	7.23E-05	0.000595408	0.00204646
0.523706	-0.0325632	-0.004577	6.21E-05	0.000580157	0.00206013
0.534324	-0.0339603	-0.00398522	7.60E-05	0.000724589	0.00244063
0.508626	-0.0385531	-0.00374213	0.000103713	0.000490276	0.0013001
0.521599	-0.0322847	-0.00472854	5.98E-05	0.000506901	0.0017782
0.51055	-0.0310847	-0.00487862	5.68E-05	0.000399562	0.00120657
0.505404	-0.0380082	-0.00418371	9.13E-05	0.000440173	0.000869844
0.495727	-0.0366883	-0.00481783	6.75E-05	0.000338815	0.000501933
0.497395	-0.0296045	-0.00518309	3.09E-05	0.000197657	0.000496944
0.482591	-0.0352705	-0.00503491	3.62E-05	0.000133835	0.00015069
0.484357	-0.0279137	-0.00592912	3.74E-06	5.33E-05	0.000159333
0.469553	-0.0336231	-0.00568898	2.09E-05	0.000101715	0.000757821
0.47154	-0.0258	-0.00744138	1.69E-05	8.28E-05	0.000622976
0.456364	-0.0322918	-0.00573951	3.48E-06	0.000260472	0.00124803
0.463088	-0.025663	-0.00616723	2.34E-05	0.000139089	0.000852383
0.458221	-0.0246325	-0.00714995	2.83E-05	0.000240966	0.00125512
0.448651	-0.030935	-0.00680739	1.22E-05	0.000328822	0.00156788
0.443523	-0.0302688	-0.00707735	2.18E-05	0.000367587	0.00173763
0.445079	-0.0231501	-0.00746064	4.50E-05	0.000378015	0.00169057
0.43038	-0.0288461	-0.00730432	4.02E-05	0.000457346	0.00201378
0.431929	-0.0216656	-0.00777381	5.12E-05	0.000493244	0.00202798
0.417473	-0.0269252	-0.00848471	5.34E-05	0.000568386	0.00225604
0.418791	-0.0201331	-0.00817575	5.39E-05	0.000561909	0.00224304
0.404284	-0.025592	-0.00854149	6.54E-05	0.000605314	0.00237892
0.405539	-0.018926	-0.00796886	5.99E-05	0.000610657	0.0023672
0.391497	-0.0246589	-0.00791597	7.80E-05	0.000619816	0.00239636
0.391051	-0.0243815	-0.00832806	8.52E-05	0.000628276	0.00236906
0.404863	-0.0185202	-0.00860102	6.49E-05	0.000627599	0.00239865
0.39259	-0.0169819	-0.00915046	7.54E-05	0.000631132	0.00238413
0.377885	-0.0230523	-0.00838357	9.15E-05	0.000623642	0.00225931

0.379319	-0.0158203	-0.008858	8.44E-05	0.000613936	0.00227105
0.364727	-0.0217248	-0.00843875	0.00010184	0.000570189	0.00203086
0.366115	-0.0145223	-0.00882482	8.90E-05	0.000558126	0.00204728
0.351712	-0.0200137	-0.00918191	0.000104145	0.000501497	0.00172521
0.353104	-0.0127156	-0.00974766	8.99E-05	0.00050644	0.0018216
0.33856	-0.0186878	-0.00923725	0.000103467	0.000445247	0.0014191
0.346316	-0.0121444	-0.00959224	8.84E-05	0.000475203	0.00168026
0.33997	-0.0112331	-0.0100621	9.03E-05	0.00039484	0.00134794
0.33458	-0.0179328	-0.00990796	0.00010598	0.000348708	0.00112459
0.325414	-0.0174123	-0.00920342	0.000102835	0.000256402	0.000859461
0.326823	-0.00984698	-0.0102005	9.54E-05	0.000280714	0.000912351
0.312415	-0.0156081	-0.0101231	8.77E-05	0.000128571	0.000398462
0.313672	-0.00842799	-0.0104363	0.000100586	0.000154342	0.000426616
0.299488	-0.0135891	-0.0114886	7.48E-05	2.16E-05	9.16E-05
0.30047	-0.00721362	-0.010216	0.000102465	3.06E-05	1.03E-05
0.286244	-0.012673	-0.0107456	7.86E-05	0.000135616	0.000577068
0.287942	-0.00543322	-0.0111928	0.000100777	4.52E-05	0.000198924
0.287388	-0.00559416	-0.0107899	9.48E-05	0.000145157	0.000585063
0.277539	-0.0116661	-0.0110234	8.39E-05	0.000246309	0.000940008
0.275251	-0.0115871	-0.0107361	8.61E-05	0.000271899	0.00103926
0.273044	-0.0115535	-0.010344	8.68E-05	0.000315277	0.00119086
0.274304	-0.00399095	-0.0112572	6.87E-05	0.000316893	0.00118172
0.27769	-0.00478328	-0.0105156	8.42E-05	0.000247505	0.000932941
0.25999	-0.00993588	-0.0105689	7.51E-05	0.000428859	0.00157332
0.261181	-0.00251138	-0.0112235	5.87E-05	0.00042638	0.00155342
0.246959	-0.00817704	-0.0110571	6.25E-05	0.000541438	0.00198707
0.248183	-0.000464691	-0.012239	4.59E-05	0.00054483	0.00194554
0.233911	-0.00651371	-0.0113696	5.32E-05	0.000641994	0.00231351
0.234977	0.000634641	-0.0115042	4.41E-05	0.000642267	0.00228417
0.220893	-0.00471047	-0.0119447	4.05E-05	0.000710457	0.00255334
0.22182	0.00187254	-0.0110305	4.31E-05	0.00072455	0.00256861
0.207798	-0.00343019	-0.0115543	3.51E-05	0.000745335	0.00269349
0.208751	0.00340685	-0.0110715	3.70E-05	0.00078142	0.00273903
0.194769	-0.00170776	-0.0119446	2.96E-05	0.00075139	0.00274191
0.195745	0.00540251	-0.011997	3.08E-05	0.000782201	0.00276588
0.181659	-0.000524304	-0.0113784	2.41E-05	0.000739462	0.00270683
0.182635	0.00677785	-0.0117836	3.15E-05	0.000739787	0.00271375
0.168586	0.00084674	-0.0111628	2.25E-05	0.000687634	0.00257175
0.169508	0.00796011	-0.0112193	3.43E-05	0.000708181	0.00262821
0.155576	0.00270871	-0.0118158	2.86E-05	0.000594733	0.00233405
0.16288	0.00942261	-0.0124769	3.63E-05	0.000691118	0.00256216
0.156514	0.0102112	-0.0125723	3.41E-05	0.000634083	0.00237615
0.142593	0.00479134	-0.0129163	4.03E-05	0.000526609	0.00210031
0.143428	0.0115815	-0.0123573	3.20E-05	0.000515646	0.00205664
0.142429	0.00480917	-0.0129153	4.10E-05	0.000469991	0.00191287
0.12948	0.0055369	-0.0115597	3.22E-05	0.000396988	0.00170556
0.130321	0.0126621	-0.0116165	3.13E-05	0.000391069	0.00169101
0.116486	0.00749079	-0.0123882	3.24E-05	0.00027261	0.00135646
0.117275	0.0142373	-0.0117425	3.62E-05	0.000268907	0.00133331
0.103432	0.00827687	-0.0111208	2.71E-05	0.000175471	0.00105153

0.104206	0.0155068	-0.011352	3.88E-05	0.000165564	0.00101579
0.0904122	0.0095573	-0.0107223	2.85E-05	9.25E-05	0.0007605
0.0911713	0.0172091	-0.0117497	3.85E-05	6.03E-05	0.000701887
0.077404	0.0115906	-0.011736	3.28E-05	1.75E-05	0.000421796
0.078128	0.0182007	-0.0108264	3.18E-05	2.35E-05	0.000442355
0.068584	0.0125329	-0.0101419	2.25E-05	3.02E-05	0.000241999
0.0684519	0.0129494	-0.0123099	3.17E-05	3.16E-05	0.000254302
0.0688784	0.0144913	-0.0111174	2.10E-05	3.70E-05	0.000231692
0.0691504	0.0156963	-0.0106802	2.68E-05	4.76E-05	0.000224201
0.0694463	0.0175284	-0.0113805	3.20E-05	4.61E-05	0.000229907
0.0697204	0.0189276	-0.0112908	3.23E-05	4.06E-05	0.000256187
0.0698224	0.0198781	-0.0121356	3.42E-05	3.63E-05	0.000269626

Source File

Name: beam0lb_45deg_fast_60.63Hz
Signal: FFT - Vib 3D Velocity - Magnitude
dB-Reference: 0 dB = 1 m/s
Band No.: 1
Frequency: 60.63 Hz

Interpolated: Yes
Filtered: Yes

X	Y	Z	Mag X	Mag Y	Mag Z
0.0622235	0.0193966	-0.0081903	4.20E-05	0.000102849	4.47E-05
0.062097	0.0180518	-0.0083055	1.63E-05	4.30E-05	2.63E-05
0.0620045	0.0166294	-0.00823762	2.19E-06	3.32E-06	1.21E-05
0.0618559	0.015464	-0.00870844	2.10E-06	7.82E-06	9.42E-06
0.0618698	0.0135845	-0.00753341	2.49E-06	1.45E-05	3.36E-06
0.0617082	0.0124314	-0.00810393	2.37E-05	5.80E-05	3.42E-05
0.0615968	0.0110874	-0.00821371	5.38E-05	0.000128477	4.59E-05
0.0743432	0.0179062	-0.00876108	1.93E-05	3.43E-05	1.33E-05
0.074274	0.0163829	-0.00841235	5.92E-06	7.22E-06	2.28E-05
0.0742051	0.0148606	-0.00806188	2.57E-06	7.53E-06	2.51E-05
0.0740213	0.013748	-0.00872467	2.49E-06	9.55E-06	2.38E-05
0.0739694	0.0121375	-0.00819241	2.91E-06	1.19E-05	2.11E-05
0.0738815	0.0106807	-0.00802633	5.66E-06	1.18E-05	2.75E-05
0.0737362	0.00942889	-0.00831182	2.19E-05	5.29E-05	3.64E-05
0.086535	0.0161925	-0.00876564	3.60E-05	8.04E-05	8.10E-06
0.086448	0.0146965	-0.00851247	1.69E-05	3.06E-05	1.90E-05
0.0863003	0.0134452	-0.0088028	1.01E-06	3.07E-06	3.14E-05
0.0862073	0.0120018	-0.00863319	2.88E-06	6.80E-06	3.21E-05
0.0861292	0.0104699	-0.00828307	3.86E-06	8.25E-06	2.77E-05
0.0860131	0.00905412	-0.00820593	5.41E-06	9.52E-06	2.76E-05
0.0986895	0.0146662	-0.00921804	1.52E-05	3.30E-05	3.84E-05
0.0985887	0.0131347	-0.0088698	9.75E-07	2.15E-06	4.59E-05

0.0985037	0.0116163	-0.008516	4.65E-07	4.84E-06	4.64E-05
0.0983889	0.0101631	-0.00834858	7.90E-07	2.39E-06	4.26E-05
0.0982449	0.00893742	-0.00873439	2.34E-06	4.47E-06	4.61E-05
0.0981154	0.00763569	-0.00893448	3.21E-06	6.91E-06	4.89E-05
0.111004	0.0142461	-0.00899009	7.50E-07	8.08E-07	6.03E-05
0.11089	0.0128296	-0.00891992	4.02E-07	2.73E-06	5.97E-05
0.110699	0.0117966	-0.00976891	3.16E-07	2.43E-06	6.25E-05
0.110619	0.0102032	-0.00922938	1.40E-06	4.41E-06	6.21E-05
0.110472	0.00896476	-0.00962145	4.31E-07	2.00E-06	6.14E-05
0.110351	0.00751302	-0.00945161	1.06E-06	2.92E-07	6.39E-05
0.11025	0.00602306	-0.0091892	7.71E-07	5.76E-06	7.16E-05
0.123142	0.0128622	-0.00978694	5.22E-07	2.28E-06	7.91E-05
0.123069	0.01109	-0.00889076	1.26E-06	1.93E-06	7.96E-05
0.122877	0.0100959	-0.00983193	6.34E-07	4.41E-06	8.59E-05
0.122754	0.0087325	-0.00984483	1.10E-06	1.28E-06	8.98E-05
0.122624	0.00739424	-0.00995395	3.41E-06	5.34E-06	8.45E-05
0.122497	0.00594402	-0.00978307	4.31E-06	5.23E-06	8.76E-05
0.12242	0.0042161	-0.00896998	4.41E-06	3.63E-06	9.30E-05
0.135316	0.0113057	-0.0102085	1.10E-06	3.43E-06	0.000110511
0.13519	0.00977845	-0.00985823	4.25E-07	4.56E-06	0.000108835
0.135083	0.00821303	-0.00941495	2.60E-06	4.29E-06	0.000111916
0.134978	0.00666208	-0.00896451	2.39E-08	2.99E-06	0.000109238
0.134798	0.00557883	-0.00972377	2.15E-06	3.93E-06	0.00010358
0.134683	0.00409159	-0.00946041	1.95E-06	1.48E-06	0.00010398
0.134541	0.00271947	-0.00947178	1.53E-06	4.25E-06	0.000108634
0.147482	0.00972053	-0.0105177	2.81E-06	4.30E-06	0.000129821
0.14739	0.00788974	-0.00942795	1.37E-06	2.81E-06	0.000126856
0.147241	0.00665445	-0.00982082	1.99E-06	4.08E-06	0.000129439
0.147092	0.00533313	-0.00992321	7.51E-07	4.81E-06	0.000128407
0.146944	0.00411068	-0.0103082	8.23E-07	4.08E-06	0.000128248
0.146841	0.00238575	-0.00949368	3.43E-07	4.62E-06	0.000125863
0.159686	0.00778724	-0.0099821	2.46E-06	3.73E-06	0.000152831
0.159525	0.00670377	-0.0107461	2.41E-06	3.79E-06	0.000150456
0.159389	0.00529242	-0.0106708	1.28E-06	4.09E-06	0.000144144
0.159244	0.00385851	-0.0104951	1.05E-06	6.62E-06	0.000146426
0.159123	0.00220966	-0.0098662	8.00E-07	6.93E-06	0.000156336
0.158961	0.00117587	-0.0107125	1.10E-06	6.35E-06	0.000164706
0.171855	0.00625361	-0.0104549	1.98E-06	6.18E-06	0.000181114
0.171719	0.00473009	-0.0101025	2.38E-06	4.97E-06	0.000170746
0.171559	0.00368435	-0.0109576	2.25E-06	5.01E-06	0.000160985
0.171418	0.00202616	-0.0102253	1.86E-06	6.44E-06	0.000155669
0.171258	0.00103023	-0.0111655	1.93E-06	5.28E-06	0.000166869
0.171131	-0.000728439	-0.0102557	1.80E-06	4.40E-06	0.000179192
0.184194	0.00617328	-0.0110758	2.36E-06	8.40E-06	0.000193689
0.184038	0.00450049	-0.0103532	2.52E-06	6.09E-06	0.000193187
0.183885	0.00334212	-0.0109315	2.92E-06	6.00E-06	0.000191245
0.18374	0.00190884	-0.0107567	2.63E-06	7.12E-06	0.000186617

0.183578	0.000488998	-0.0106829	2.86E-06	7.34E-06	0.000180871
0.18343	-0.000843793	-0.0107885	2.68E-06	6.13E-06	0.000183237
0.183278	-0.00195252	-0.0114492	2.59E-06	4.96E-06	0.000185007
0.196373	0.00441439	-0.0109601	4.36E-06	8.24E-06	0.000202002
0.19622	0.00310543	-0.011169	3.77E-06	6.28E-06	0.000201187
0.196068	0.00188476	-0.0115566	3.74E-06	6.75E-06	0.00020143
0.195902	0.000403128	-0.0112934	2.70E-06	7.57E-06	0.000199092
0.195749	-0.00111645	-0.0109363	2.79E-06	7.25E-06	0.000200378
0.195596	-0.00246163	-0.0110466	3.17E-06	5.73E-06	0.000201662
0.19543	-0.00401505	-0.0105927	3.03E-06	5.63E-06	0.000200407
0.208577	0.00298711	-0.0116645	5.77E-06	8.47E-06	0.000226315
0.208394	0.00126712	-0.0108532	4.76E-06	7.65E-06	0.000230374
0.208237	-7.81E-05	-0.0109675	3.95E-06	8.83E-06	0.000229584
0.208082	-0.0014342	-0.0109769	2.97E-06	9.03E-06	0.000225251
0.207914	-0.00266552	-0.0113662	3.10E-06	7.99E-06	0.000214088
0.207766	-0.00377408	-0.0120279	3.22E-06	6.94E-06	0.00021141
0.22074	0.00101726	-0.0110619	4.85E-06	7.48E-06	0.00023643
0.220593	-9.02E-05	-0.0117283	4.33E-06	7.70E-06	0.000235805
0.22042	-0.00165932	-0.0112859	4.64E-06	8.71E-06	0.000239938
0.220261	-0.00272848	-0.0120423	4.60E-06	9.80E-06	0.000239129
0.220087	-0.00432016	-0.0114986	4.45E-06	9.80E-06	0.000230656
0.219905	-0.00581072	-0.0112364	4.10E-06	8.30E-06	0.000220104
0.232923	-0.000645128	-0.0111809	5.08E-06	8.10E-06	0.000252729
0.232761	-0.00195222	-0.0113888	5.07E-06	8.79E-06	0.000251667
0.232601	-0.00324611	-0.01159	5.48E-06	9.27E-06	0.000252752
0.232422	-0.00461246	-0.0116039	5.66E-06	1.05E-05	0.000258886
0.232233	-0.00625229	-0.0109719	5.53E-06	1.00E-05	0.00025572
0.232086	-0.007211	-0.0120044	4.96E-06	8.93E-06	0.000248482
0.245142	-0.0018027	-0.0125888	6.20E-06	9.14E-06	0.000273754
0.244944	-0.00343188	-0.0119568	6.12E-06	1.00E-05	0.000278721
0.244748	-0.00503547	-0.0114209	6.20E-06	1.04E-05	0.000274977
0.244615	-0.00592014	-0.0126414	6.32E-06	1.04E-05	0.000269013
0.244425	-0.00747241	-0.0121898	5.75E-06	1.05E-05	0.00027736
0.244219	-0.00903478	-0.0117416	5.54E-06	9.25E-06	0.000278459
0.257425	-0.00285433	-0.0108065	6.51E-06	8.76E-06	0.000270586
0.257309	-0.00366299	-0.0122154	6.50E-06	9.12E-06	0.000274351
0.257123	-0.00511826	-0.0120522	6.71E-06	1.04E-05	0.000284436
0.256947	-0.00648573	-0.0120675	6.72E-06	1.06E-05	0.000287144
0.256758	-0.007851	-0.0120814	6.56E-06	1.11E-05	0.000283077
0.256523	-0.00967189	-0.0109846	6.14E-06	1.05E-05	0.000282185
0.256377	-0.010817	-0.0115525	5.86E-06	1.04E-05	0.000283603
0.269673	-0.00408782	-0.0119945	6.07E-06	1.08E-05	0.000274628
0.269489	-0.00539289	-0.0122037	6.48E-06	1.04E-05	0.000270673
0.269326	-0.00664968	-0.0124988	6.97E-06	1.01E-05	0.00026805
0.269137	-0.0079915	-0.0126125	7.22E-06	1.06E-05	0.000270201
0.26891	-0.00965222	-0.0118837	7.16E-06	1.12E-05	0.000280747
0.268754	-0.0108715	-0.0122674	7.05E-06	1.14E-05	0.000282837

0.268576	-0.012139	-0.0125623	6.83E-06	1.11E-05	0.000281819
0.281848	-0.0057849	-0.0120611	6.53E-06	1.45E-05	0.00029112
0.28169	-0.00700478	-0.0124502	6.87E-06	1.35E-05	0.00028812
0.281436	-0.00867735	-0.0117307	7.26E-06	1.29E-05	0.000276209
0.281292	-0.00982339	-0.0123025	7.19E-06	1.08E-05	0.000269979
0.28106	-0.0114456	-0.0116665	7.19E-06	1.04E-05	0.000275131
0.280934	-0.0124206	-0.0127056	7.25E-06	1.06E-05	0.000275776
0.294065	-0.00730404	-0.0125766	7.80E-06	1.21E-05	0.000292773
0.293891	-0.00859797	-0.0127805	7.89E-06	1.19E-05	0.000290295
0.293703	-0.00988991	-0.0129834	7.77E-06	1.39E-05	0.000286511
0.293529	-0.0111837	-0.0131845	7.77E-06	1.31E-05	0.000278608
0.293288	-0.0127306	-0.0127351	7.70E-06	1.09E-05	0.00026919
0.293013	-0.0145094	-0.0117316	7.52E-06	1.03E-05	0.000254201
0.306293	-0.00877915	-0.0131651	8.85E-06	1.01E-05	0.000283408
0.306055	-0.0103428	-0.0127259	8.63E-06	1.02E-05	0.000280257
0.305873	-0.0115981	-0.0130217	8.56E-06	1.39E-05	0.000277986
0.305654	-0.0130606	-0.0127539	8.92E-06	1.40E-05	0.000286296
0.305424	-0.0145849	-0.0124022	8.67E-06	1.20E-05	0.000285069
0.305165	-0.0161653	-0.0118583	8.24E-06	1.24E-05	0.000272823
0.318576	-0.00951651	-0.0121442	9.03E-06	1.03E-05	0.000277261
0.318414	-0.0107504	-0.0125402	8.90E-06	9.65E-06	0.000279252
0.318268	-0.0118602	-0.0132081	8.68E-06	9.02E-06	0.000278863
0.318058	-0.0132766	-0.0131383	8.90E-06	1.19E-05	0.000271119
0.317852	-0.0146661	-0.0130563	9.28E-06	1.23E-05	0.000274629
0.317487	-0.0166086	-0.0115874	9.45E-06	1.20E-05	0.000285055
0.317458	-0.0173365	-0.0132752	9.07E-06	1.33E-05	0.000283387
0.330816	-0.0110168	-0.0127089	8.78E-06	1.05E-05	0.000253414
0.330672	-0.0121274	-0.0133783	8.81E-06	9.63E-06	0.000257332
0.330405	-0.0137256	-0.0128475	8.87E-06	9.02E-06	0.000264877
0.330232	-0.0149835	-0.0131431	8.89E-06	1.10E-05	0.000260129
0.329944	-0.0165873	-0.0125061	9.27E-06	1.18E-05	0.000250052
0.329853	-0.0175695	-0.0135457	8.79E-06	1.04E-05	0.00025264
0.329584	-0.0191128	-0.0130962	8.82E-06	1.14E-05	0.000256774
0.343027	-0.0125944	-0.0130752	8.82E-06	1.02E-05	0.000234782
0.34274	-0.0142154	-0.0124487	8.91E-06	9.98E-06	0.000230744
0.342597	-0.0153268	-0.0131169	8.84E-06	8.53E-06	0.00023525
0.342285	-0.017031	-0.0123071	9.26E-06	1.06E-05	0.000235679
0.342204	-0.0179877	-0.0133369	9.29E-06	1.14E-05	0.00023048
0.342016	-0.019244	-0.013631	8.88E-06	1.08E-05	0.000234265
0.355184	-0.0143459	-0.01296	9.24E-06	1.22E-05	0.000226352
0.354995	-0.0156544	-0.0131718	9.21E-06	1.20E-05	0.000227023
0.354657	-0.0173431	-0.0123605	9.02E-06	1.00E-05	0.000211707
0.354543	-0.0184219	-0.013119	9.01E-06	9.68E-06	0.000212243
0.354184	-0.0202045	-0.0120201	9.34E-06	1.06E-05	0.000211789
0.354227	-0.0207813	-0.0140734	8.75E-06	1.05E-05	0.00021715
0.367378	-0.0160076	-0.0131138	1.02E-05	1.08E-05	0.000205643
0.367292	-0.016978	-0.0141534	1.05E-05	1.03E-05	0.0002092

0.366955	-0.0186686	-0.0133426	1.01E-05	9.78E-06	0.000201447
0.366632	-0.0203214	-0.0126222	9.98E-06	9.14E-06	0.000195908
0.366546	-0.0212929	-0.0136582	9.82E-06	9.99E-06	0.00019723
0.366341	-0.0226237	-0.013767	9.70E-06	9.29E-06	0.000198839
0.379827	-0.016197	-0.0135077	1.01E-05	1.04E-05	0.000185263
0.379548	-0.017709	-0.013163	1.05E-05	9.89E-06	0.000185278
0.379326	-0.0190769	-0.0131857	1.10E-05	9.87E-06	0.000190463
0.379005	-0.0206561	-0.0126542	1.10E-05	8.83E-06	0.000181999
0.37891	-0.0217024	-0.0135052	1.05E-05	9.26E-06	0.000182421
0.378549	-0.0234109	-0.012594	1.10E-05	9.70E-06	0.000182227
0.378341	-0.0247033	-0.0127967	1.07E-05	9.34E-06	0.000185703
0.392026	-0.0178691	-0.0136345	1.03E-05	9.30E-06	0.000158256
0.391848	-0.0190799	-0.0140245	1.03E-05	1.00E-05	0.000157241
0.39144	-0.020876	-0.0129415	1.04E-05	1.01E-05	0.000154954
0.391304	-0.0220305	-0.013517	1.02E-05	9.57E-06	0.000151986
0.390989	-0.0235596	-0.0130721	9.69E-06	9.78E-06	0.000153933
0.390777	-0.0248909	-0.0131833	1.02E-05	1.18E-05	0.000162242
0.390505	-0.026363	-0.0129237	1.05E-05	1.10E-05	0.000166633
0.403921	-0.0201707	-0.012088	1.09E-05	4.98E-06	0.000118419
0.403833	-0.021219	-0.0129423	1.09E-05	6.50E-06	0.000116947
0.403618	-0.0225519	-0.0130586	1.09E-05	7.86E-06	0.000118589
0.403277	-0.0241295	-0.0125297	1.03E-05	8.58E-06	0.000115935
0.403286	-0.0249545	-0.0139285	9.57E-06	7.52E-06	0.000116967
0.403088	-0.0262145	-0.0142268	9.50E-06	9.92E-06	0.000130985
0.416281	-0.0214586	-0.0132042	9.87E-06	4.25E-06	7.31E-05
0.416116	-0.0226489	-0.0136925	1.00E-05	3.70E-06	8.12E-05
0.415846	-0.0240889	-0.0135337	1.05E-05	5.05E-06	8.45E-05
0.415527	-0.0256203	-0.0130916	1.10E-05	5.18E-06	8.36E-05
0.415296	-0.0269376	-0.013202	1.05E-05	6.73E-06	8.26E-05
0.414942	-0.0285501	-0.0125775	9.72E-06	8.38E-06	8.20E-05
0.428451	-0.0231402	-0.0132976	1.04E-05	6.06E-06	3.05E-05
0.428228	-0.0244751	-0.0134171	1.02E-05	5.55E-06	4.19E-05
0.427918	-0.0259719	-0.01307	1.06E-05	4.19E-06	5.00E-05
0.427645	-0.0273734	-0.0130042	1.07E-05	3.94E-06	4.98E-05
0.42737	-0.0287984	-0.0128378	1.07E-05	5.29E-06	5.14E-05
0.427224	-0.0299415	-0.0134078	9.50E-06	8.62E-06	5.11E-05
0.440804	-0.0235984	-0.0129808	1.13E-05	6.65E-06	6.03E-06
0.440583	-0.0248966	-0.0131961	1.10E-05	6.72E-06	7.54E-06
0.440283	-0.0263589	-0.0129439	1.09E-05	6.68E-06	1.26E-05
0.440038	-0.0277288	-0.0129708	1.08E-05	5.94E-06	1.30E-05
0.439799	-0.0290477	-0.0130845	1.10E-05	3.70E-06	1.29E-05
0.439648	-0.0302298	-0.0135627	1.02E-05	3.40E-06	1.48E-05
0.439422	-0.0315509	-0.0136719	1.00E-05	4.92E-06	1.49E-05
0.452923	-0.0253555	-0.0128697	1.12E-05	5.15E-06	3.29E-05
0.45285	-0.0264127	-0.0137254	1.10E-05	5.11E-06	2.99E-05
0.45266	-0.0276668	-0.0140248	1.05E-05	5.09E-06	3.05E-05
0.452319	-0.0291615	-0.013683	1.04E-05	4.23E-06	3.06E-05

0.451932	-0.0307749	-0.0130675	1.04E-05	2.67E-06	3.09E-05
0.451627	-0.0322218	-0.0128065	1.06E-05	2.37E-06	2.90E-05
0.451616	-0.0331401	-0.0140255	1.06E-05	2.89E-06	2.83E-05
0.465138	-0.0269801	-0.0131119	1.20E-05	3.31E-06	7.83E-05
0.46483	-0.0284061	-0.0129578	1.21E-05	4.59E-06	7.47E-05
0.464576	-0.029778	-0.0129884	1.16E-05	4.28E-06	7.19E-05
0.464343	-0.0311016	-0.0131038	1.02E-05	2.36E-06	7.21E-05
0.464097	-0.0324222	-0.0132198	1.03E-05	1.31E-06	7.20E-05
0.463988	-0.0335256	-0.0138769	1.03E-05	1.77E-06	7.13E-05
0.463576	-0.035134	-0.0132622	1.09E-05	2.91E-06	7.04E-05
0.477205	-0.0288131	-0.0127989	1.19E-05	1.51E-06	0.000120204
0.476927	-0.0302074	-0.0127354	1.20E-05	1.24E-06	0.000113154
0.476591	-0.0316674	-0.0124897	1.13E-05	1.80E-06	0.000114413
0.476461	-0.0328196	-0.0130632	9.95E-06	1.25E-06	0.000112014
0.476287	-0.0340543	-0.0134581	9.41E-06	2.11E-06	0.000108144
0.475889	-0.035602	-0.012928	9.91E-06	3.11E-06	9.88E-05
0.48945	-0.0303742	-0.013206	1.16E-05	5.29E-06	0.000174652
0.489263	-0.0315951	-0.0136026	1.06E-05	2.80E-06	0.000153293
0.488956	-0.0330246	-0.0134481	9.61E-06	1.43E-06	0.000151305
0.48876	-0.0342823	-0.0137484	8.93E-06	6.58E-07	0.000158397
0.488107	-0.0362198	-0.012223	8.94E-06	2.90E-06	0.000154712
0.488112	-0.0371563	-0.0133372	9.08E-06	4.20E-06	0.000151468
0.501732	-0.0309202	-0.0126613	1.21E-05	5.93E-06	0.000216802
0.501451	-0.0322795	-0.0126957	1.24E-05	4.92E-06	0.000214678
0.501092	-0.0337779	-0.0123618	1.14E-05	2.32E-06	0.000195273
0.501056	-0.0347976	-0.0133019	1.04E-05	1.93E-06	0.000197735
0.500777	-0.0361427	-0.0133267	9.43E-06	9.72E-07	0.000207912
0.500535	-0.0374562	-0.0134388	9.71E-06	2.83E-06	0.000214045
0.50036	-0.0386812	-0.0138286	9.75E-06	3.30E-06	0.000208957
0.514011	-0.0324153	-0.0132342	1.23E-05	4.68E-06	0.000261748
0.513596	-0.0339836	-0.0127224	1.23E-05	2.93E-06	0.000264958
0.513278	-0.035401	-0.012567	1.24E-05	2.25E-06	0.000254135
0.512969	-0.0367942	-0.012509	1.22E-05	1.98E-06	0.000253936
0.512937	-0.0378174	-0.013448	1.15E-05	2.12E-06	0.000261947
0.512549	-0.0393213	-0.0130098	1.11E-05	2.43E-06	0.000259801
0.512168	-0.0408143	-0.0126742	1.11E-05	2.58E-06	0.000258095
0.526038	-0.0342922	-0.0127974	1.16E-05	3.86E-06	0.000314584
0.525837	-0.035555	-0.0131046	1.12E-05	4.61E-06	0.000313485
0.5255	-0.0369707	-0.0129539	1.13E-05	4.81E-06	0.000300485
0.524852	-0.0388403	-0.0116238	1.24E-05	5.61E-06	0.000297376
0.5249	-0.0397514	-0.0128294	1.19E-05	4.87E-06	0.00030004
0.524686	-0.040997	-0.0131284	1.21E-05	3.54E-06	0.000313604
0.524411	-0.042346	-0.0131507	1.17E-05	3.85E-06	0.000312235
0.538094	-0.0360997	-0.0125389	1.18E-05	4.08E-06	0.000348921
0.537968	-0.037263	-0.0131187	1.19E-05	2.85E-06	0.000361756
0.537316	-0.039083	-0.0118828	1.21E-05	3.99E-06	0.000353424
0.537038	-0.0404335	-0.0119106	1.22E-05	6.49E-06	0.000333893

0.537142	-0.0412951	-0.0133025	1.17E-05	6.25E-06	0.000330915
0.536697	-0.0428298	-0.012781	1.18E-05	5.22E-06	0.000339361
0.550119	-0.0379428	-0.0121841	1.12E-05	4.93E-06	0.00035606
0.549836	-0.0392958	-0.0122166	1.15E-05	3.10E-06	0.000374947
0.54967	-0.0404918	-0.0127082	1.14E-05	3.65E-06	0.000378298
0.549281	-0.0419778	-0.012376	1.13E-05	5.45E-06	0.000355098
0.549024	-0.0432963	-0.0124947	1.10E-05	6.52E-06	0.0003458
0.548755	-0.0445981	-0.0126095	1.18E-05	6.83E-06	0.000361877

Source File beam0lb_45deg_fast_169.4Hz
Name:
Signal: FFT - Vib 3D Velocity - Magnitude
dB-Reference: 0 dB = 1 m/s
Band No.: 1
Frequency: 169.4 Hz

Interpolated: Yes
Filtered: Yes

X	Y	Z	Mag X	Mag Y	Mag Z
0.0622235	0.0193966	-0.0081903	5.68E-06	2.26E-05	0.000220373
0.062097	0.0180518	-0.0083055	8.67E-06	3.36E-05	0.000206652
0.0620045	0.0166294	-0.00823762	9.35E-06	3.18E-05	0.00019835
0.0618559	0.015464	-0.00870844	1.01E-05	1.93E-05	0.000194622
0.0618698	0.0135845	-0.00753341	1.15E-05	1.69E-05	0.000187824
0.0617082	0.0124314	-0.00810393	1.09E-05	1.38E-05	0.000185504
0.0615968	0.0110874	-0.00821371	1.01E-05	1.60E-05	0.000192757
0.0743432	0.0179062	-0.00876108	9.72E-06	2.06E-05	0.000395505
0.074274	0.0163829	-0.00841235	7.89E-06	2.52E-05	0.000392216
0.0742051	0.0148606	-0.00806188	1.23E-05	2.10E-05	0.000389766
0.0740213	0.013748	-0.00872467	1.37E-05	1.92E-05	0.000394965
0.0739694	0.0121375	-0.00819241	1.50E-05	1.86E-05	0.000395022
0.0738815	0.0106807	-0.00802633	1.66E-05	1.85E-05	0.000396978
0.0737362	0.00942889	-0.00831182	1.62E-05	2.21E-05	0.000398602
0.086535	0.0161925	-0.00876564	1.41E-05	2.19E-05	0.000704045
0.086448	0.0146965	-0.00851247	1.51E-05	2.43E-05	0.000703989
0.0863003	0.0134452	-0.0088028	1.77E-05	3.07E-05	0.000695825
0.0862073	0.0120018	-0.00863319	1.69E-05	3.42E-05	0.000701466
0.0861292	0.0104699	-0.00828307	1.67E-05	3.66E-05	0.000699911
0.0860131	0.00905412	-0.00820593	1.62E-05	3.38E-05	0.0006449
0.0986895	0.0146662	-0.00921804	1.36E-05	3.04E-05	0.00110062
0.0985887	0.0131347	-0.0088698	1.46E-05	2.19E-05	0.00103415
0.0985037	0.0116163	-0.008516	1.22E-05	3.49E-05	0.00101289
0.0983889	0.0101631	-0.00834858	1.19E-05	3.89E-05	0.000997023
0.0982449	0.00893742	-0.00873439	7.80E-06	4.06E-05	0.000998314
0.0981154	0.00763569	-0.00893448	7.68E-06	4.09E-05	0.00106261
0.111004	0.0142461	-0.00899009	2.39E-06	4.72E-05	0.0013762
0.11089	0.0128296	-0.00891992	1.65E-06	3.97E-05	0.00137706
0.110699	0.0117966	-0.00976891	2.35E-06	3.19E-05	0.00137908
0.110619	0.0102032	-0.00922938	6.37E-06	3.79E-05	0.00136289

0.110472	0.00896476	-0.00962145	9.98E-06	4.57E-05	0.00135762
0.110351	0.00751302	-0.00945161	9.67E-06	4.50E-05	0.00141293
0.11025	0.00602306	-0.0091892	9.22E-06	4.69E-05	0.00148939
0.123142	0.0128622	-0.00978694	1.96E-05	4.93E-05	0.0017037
0.123069	0.01109	-0.00889076	1.78E-05	4.39E-05	0.00170216
0.122877	0.0100959	-0.00983193	1.37E-05	3.55E-05	0.00170665
0.122754	0.0087325	-0.00984483	1.37E-05	3.97E-05	0.00170744
0.122624	0.00739424	-0.00995395	1.51E-05	4.87E-05	0.00170223
0.122497	0.00594402	-0.00978307	1.83E-05	5.32E-05	0.0017063
0.12242	0.0042161	-0.00896998	1.65E-05	5.67E-05	0.00177062
0.135316	0.0113057	-0.0102085	3.14E-05	4.56E-05	0.00204718
0.13519	0.00977845	-0.00985823	2.66E-05	4.38E-05	0.00204717
0.135083	0.00821303	-0.00941495	2.23E-05	3.83E-05	0.00204898
0.134978	0.00666208	-0.00896451	2.41E-05	3.89E-05	0.00204652
0.134798	0.00557883	-0.00972377	2.25E-05	5.35E-05	0.00204398
0.134683	0.00409159	-0.00946041	2.14E-05	6.15E-05	0.00203959
0.134541	0.00271947	-0.00947178	2.21E-05	6.42E-05	0.00203861
0.147482	0.00972053	-0.0105177	4.40E-05	5.75E-05	0.00234692
0.14739	0.00788974	-0.00942795	3.74E-05	5.57E-05	0.00235107
0.147241	0.00665445	-0.00982082	3.82E-05	4.84E-05	0.00235742
0.147092	0.00533313	-0.00992321	4.21E-05	4.03E-05	0.00235855
0.146944	0.00411068	-0.0103082	4.22E-05	5.07E-05	0.00235699
0.146841	0.00238575	-0.00949368	3.52E-05	6.14E-05	0.00229838
0.159686	0.00778724	-0.0099821	6.46E-05	6.52E-05	0.00259028
0.159525	0.00670377	-0.0107461	6.17E-05	6.65E-05	0.00259381
0.159389	0.00529242	-0.0106708	5.97E-05	5.93E-05	0.00260415
0.159244	0.00385851	-0.0104951	6.29E-05	4.73E-05	0.00260578
0.159123	0.00220966	-0.0098662	6.16E-05	5.17E-05	0.00260495
0.158961	0.00117587	-0.0107125	6.14E-05	5.89E-05	0.00259926
0.171855	0.00625361	-0.0104549	7.61E-05	6.72E-05	0.00279325
0.171719	0.00473009	-0.0101025	7.50E-05	6.59E-05	0.00277304
0.171559	0.00368435	-0.0109576	7.60E-05	6.07E-05	0.00277533
0.171418	0.00202616	-0.0102253	7.60E-05	5.33E-05	0.00278059
0.171258	0.00103023	-0.0111655	7.77E-05	5.59E-05	0.00277729
0.171131	-0.000728439	-0.0102557	7.84E-05	6.12E-05	0.00277404
0.184194	0.00617328	-0.0110758	8.58E-05	6.70E-05	0.00289036
0.184038	0.00450049	-0.0103532	8.71E-05	6.49E-05	0.00289245
0.183885	0.00334212	-0.0109315	8.87E-05	6.40E-05	0.0028886
0.18374	0.00190884	-0.0107567	9.02E-05	6.42E-05	0.00288999
0.183578	0.000488998	-0.0106829	9.11E-05	6.13E-05	0.00288995
0.18343	-0.000843793	-0.0107885	9.09E-05	6.41E-05	0.00288504
0.183278	-0.00195252	-0.0114492	9.13E-05	6.38E-05	0.0028798
0.196373	0.00441439	-0.0109601	0.000102701	6.66E-05	0.00292433
0.19622	0.00310543	-0.011169	0.000100415	6.56E-05	0.00292466
0.196068	0.00188476	-0.0115566	0.000101961	6.40E-05	0.00292076
0.195902	0.000403128	-0.0112934	0.000102056	6.44E-05	0.00291942
0.195749	-0.00111645	-0.0109363	0.000103674	6.40E-05	0.00292299
0.195596	-0.00246163	-0.0110466	0.000101956	6.32E-05	0.00292088
0.19543	-0.00401505	-0.0105927	0.00010226	6.28E-05	0.00291698
0.208577	0.00298711	-0.0116645	0.000118007	7.03E-05	0.00287291
0.208394	0.00126712	-0.0108532	0.000115204	6.99E-05	0.0028719
0.208237	-7.81E-05	-0.0109675	0.000113024	6.50E-05	0.00286656

0.208082	-0.0014342	-0.0109769	0.000112596	6.32E-05	0.00286654
0.207914	-0.00266552	-0.0113662	0.000111153	6.28E-05	0.00286896
0.207766	-0.00377408	-0.0120279	0.000108989	6.23E-05	0.00287797
0.22074	0.00101726	-0.0110619	0.000127478	7.05E-05	0.0027201
0.220593	-9.02E-05	-0.0117283	0.000123096	6.83E-05	0.00272433
0.22042	-0.00165932	-0.0112859	0.000122304	6.33E-05	0.00272634
0.220261	-0.00272848	-0.0120423	0.000120023	6.18E-05	0.00273364
0.220087	-0.00432016	-0.0114986	0.000121524	6.20E-05	0.00273558
0.219905	-0.00581072	-0.0112364	0.000121719	6.22E-05	0.0027291
0.232923	-0.000645128	-0.0111809	0.000126396	6.18E-05	0.00240288
0.232761	-0.00195222	-0.0113888	0.000125572	5.86E-05	0.00248025
0.232601	-0.00324611	-0.01159	0.000124645	5.80E-05	0.00248126
0.232422	-0.00461246	-0.0116039	0.00012584	5.76E-05	0.00248521
0.232233	-0.00625229	-0.0109719	0.000128489	5.78E-05	0.0024857
0.232086	-0.007211	-0.0120044	0.000129927	5.67E-05	0.00248271
0.245142	-0.0018027	-0.0125888	0.000126666	3.89E-05	0.00197777
0.244944	-0.00343188	-0.0119568	0.000123607	3.83E-05	0.00210946
0.244748	-0.00503547	-0.0114209	0.000125159	4.44E-05	0.00217189
0.244615	-0.00592014	-0.0126414	0.000129329	5.26E-05	0.00217051
0.244425	-0.00747241	-0.0121898	0.000133679	5.24E-05	0.00216886
0.244219	-0.00903478	-0.0117416	0.000136062	5.10E-05	0.00216489
0.257425	-0.00285433	-0.0108065	0.000128948	3.17E-05	0.0017018
0.257309	-0.00366299	-0.0122154	0.000125189	2.97E-05	0.00171878
0.257123	-0.00511826	-0.0120522	0.000122328	2.54E-05	0.00178283
0.256947	-0.00648573	-0.0120675	0.00012524	3.46E-05	0.00178156
0.256758	-0.007851	-0.0120814	0.000132144	4.22E-05	0.00178089
0.256523	-0.00967189	-0.0109846	0.000136735	4.61E-05	0.0017786
0.256377	-0.010817	-0.0115525	0.000137073	4.32E-05	0.00177693
0.269673	-0.00408782	-0.0119945	0.000122561	2.33E-05	0.00134016
0.269489	-0.00539289	-0.0122037	0.000117898	2.06E-05	0.0013459
0.269326	-0.00664968	-0.0124988	0.000116667	1.86E-05	0.00134536
0.269137	-0.0079915	-0.0126125	0.000119681	1.96E-05	0.00134411
0.26891	-0.00965222	-0.0118837	0.000121816	2.77E-05	0.00134302
0.268754	-0.0108715	-0.0122674	0.000120935	2.89E-05	0.00134019
0.268576	-0.012139	-0.0125623	0.000120499	2.85E-05	0.0013385
0.281848	-0.0057849	-0.0120611	0.000113526	8.04E-06	0.000866445
0.28169	-0.00700478	-0.0124502	0.000112829	7.01E-06	0.000871318
0.281436	-0.00867735	-0.0117307	0.000111709	4.06E-06	0.000874268
0.281292	-0.00982339	-0.0123025	0.000114148	5.02E-06	0.000875507
0.28106	-0.0114456	-0.0116665	0.000118259	7.27E-06	0.000874836
0.280934	-0.0124206	-0.0127056	0.000121987	1.39E-05	0.000949272
0.294065	-0.00730404	-0.0125766	0.000102018	1.02E-05	0.000365728
0.293891	-0.00859797	-0.0127805	9.77E-05	9.26E-06	0.000368583
0.293703	-0.00988991	-0.0129834	9.80E-05	8.91E-06	0.000369721
0.293529	-0.0111837	-0.0131845	0.000100885	1.27E-05	0.000372429
0.293288	-0.0127306	-0.0127351	0.000114345	9.88E-06	0.000372689
0.293013	-0.0145094	-0.0117316	0.000127601	1.09E-05	0.000371104
0.306293	-0.00877915	-0.0131651	9.20E-05	2.84E-05	0.000224277
0.306055	-0.0103428	-0.0127259	9.09E-05	2.70E-05	0.00013949
0.305873	-0.0115981	-0.0130217	9.25E-05	2.96E-05	0.000136833
0.305654	-0.0130606	-0.0127539	0.000104102	3.52E-05	0.000133053
0.305424	-0.0145849	-0.0124022	0.000108927	3.31E-05	0.000131973

0.305165	-0.0161653	-0.0118583	0.000117358	2.84E-05	0.000132763
0.318576	-0.00951651	-0.0121442	8.65E-05	3.97E-05	0.000641508
0.318414	-0.0107504	-0.0125402	8.56E-05	4.41E-05	0.000638382
0.318268	-0.0118602	-0.0132081	7.93E-05	4.65E-05	0.00063184
0.318058	-0.0132766	-0.0131383	8.83E-05	5.01E-05	0.000628749
0.317852	-0.0146661	-0.0130563	8.95E-05	5.57E-05	0.000626465
0.317487	-0.0166086	-0.0115874	9.07E-05	5.22E-05	0.00062601
0.317458	-0.0173365	-0.0132752	8.43E-05	4.81E-05	0.00062565
0.330816	-0.0110168	-0.0127089	7.26E-05	5.04E-05	0.00111921
0.330672	-0.0121274	-0.0133783	7.19E-05	5.56E-05	0.00111184
0.330405	-0.0137256	-0.0128475	8.00E-05	5.98E-05	0.00110322
0.330232	-0.0149835	-0.0131431	7.78E-05	6.07E-05	0.00109504
0.329944	-0.0165873	-0.0125061	7.98E-05	6.34E-05	0.00109289
0.329853	-0.0175695	-0.0135457	7.02E-05	6.19E-05	0.00109077
0.329584	-0.0191128	-0.0130962	6.55E-05	5.91E-05	0.00108938
0.343027	-0.0125944	-0.0130752	5.98E-05	7.10E-05	0.00154011
0.34274	-0.0142154	-0.0124487	6.62E-05	7.75E-05	0.001536
0.342597	-0.0153268	-0.0131169	6.79E-05	7.82E-05	0.00152701
0.342285	-0.017031	-0.0123071	7.17E-05	7.68E-05	0.00152395
0.342204	-0.0179877	-0.0133369	5.81E-05	7.40E-05	0.00152172
0.342016	-0.019244	-0.013631	5.69E-05	6.85E-05	0.00144748
0.355184	-0.0143459	-0.01296	4.97E-05	8.95E-05	0.0019492
0.354995	-0.0156544	-0.0131718	5.15E-05	8.93E-05	0.00190587
0.354657	-0.0173431	-0.0123605	5.81E-05	9.01E-05	0.00190344
0.354543	-0.0184219	-0.013119	5.67E-05	8.81E-05	0.00190187
0.354184	-0.0202045	-0.0120201	4.98E-05	8.59E-05	0.0018971
0.354227	-0.0207813	-0.0140734	4.26E-05	8.18E-05	0.00189272
0.367378	-0.0160076	-0.0131138	3.34E-05	0.000101827	0.00232006
0.367292	-0.016978	-0.0141534	3.76E-05	9.98E-05	0.00225008
0.366955	-0.0186686	-0.0133426	3.77E-05	9.35E-05	0.00221686
0.366632	-0.0203214	-0.0126222	4.33E-05	9.46E-05	0.00221329
0.366546	-0.0212929	-0.0136582	3.78E-05	9.36E-05	0.00220136
0.366341	-0.0226237	-0.013767	3.74E-05	9.19E-05	0.00219451
0.379827	-0.016197	-0.0135077	2.36E-05	0.000107911	0.00246763
0.379548	-0.017709	-0.013163	2.55E-05	0.000109068	0.00246061
0.379326	-0.0190769	-0.0131857	2.56E-05	0.000106112	0.00242528
0.379005	-0.0206561	-0.0126542	2.55E-05	0.000100222	0.00242802
0.37891	-0.0217024	-0.0135052	2.91E-05	9.38E-05	0.00243131
0.378549	-0.0234109	-0.012594	3.22E-05	9.38E-05	0.00242416
0.378341	-0.0247033	-0.0127967	3.25E-05	9.72E-05	0.00241849
0.392026	-0.0178691	-0.0136345	1.29E-05	0.000104278	0.00253526
0.391848	-0.0190799	-0.0140245	1.37E-05	0.000104052	0.00253652
0.39144	-0.020876	-0.0129415	1.42E-05	0.000110477	0.00253429
0.391304	-0.0220305	-0.013517	1.16E-05	0.000103882	0.00253673
0.390989	-0.0235596	-0.0130721	1.48E-05	9.70E-05	0.00254006
0.390777	-0.0248909	-0.0131833	1.76E-05	9.65E-05	0.00254068
0.390505	-0.026363	-0.0129237	1.94E-05	9.97E-05	0.00253686
0.403921	-0.0201707	-0.012088	4.84E-06	9.31E-05	0.00253772
0.403833	-0.021219	-0.0129423	2.42E-06	9.59E-05	0.00254112
0.403618	-0.0225519	-0.0130586	2.75E-06	0.000103703	0.00254045
0.403277	-0.0241295	-0.0125297	2.76E-06	0.000102335	0.00254011
0.403286	-0.0249545	-0.0139285	2.74E-06	9.88E-05	0.00254232

0.403088	-0.0262145	-0.0142268	6.25E-06	9.42E-05	0.00254468
0.416281	-0.0214586	-0.0132042	2.21E-05	7.98E-05	0.00243788
0.416116	-0.0226489	-0.0136925	1.98E-05	8.29E-05	0.0024447
0.415846	-0.0240889	-0.0135337	1.75E-05	9.08E-05	0.00244634
0.415527	-0.0256203	-0.0130916	1.59E-05	9.54E-05	0.00244619
0.415296	-0.0269376	-0.013202	1.54E-05	9.10E-05	0.00244647
0.414942	-0.0285501	-0.0125775	1.48E-05	9.03E-05	0.00244362
0.428451	-0.0231402	-0.0132976	3.60E-05	8.21E-05	0.00218442
0.428228	-0.0244751	-0.0134171	3.03E-05	8.61E-05	0.00223396
0.427918	-0.0259719	-0.01307	3.11E-05	9.13E-05	0.00223551
0.427645	-0.0273734	-0.0130042	2.98E-05	8.54E-05	0.00223656
0.42737	-0.0287984	-0.0128378	2.86E-05	8.83E-05	0.00223856
0.427224	-0.0299415	-0.0134078	2.54E-05	8.16E-05	0.00223581
0.440804	-0.0235984	-0.0129808	4.57E-05	7.80E-05	0.00193775
0.440583	-0.0248966	-0.0131961	4.58E-05	7.97E-05	0.0019437
0.440283	-0.0263589	-0.0129439	4.03E-05	7.94E-05	0.00194586
0.440038	-0.0277288	-0.0129708	4.01E-05	7.83E-05	0.0019475
0.439799	-0.0290477	-0.0130845	4.35E-05	7.34E-05	0.00194909
0.439648	-0.0302298	-0.0135627	3.33E-05	7.13E-05	0.00195168
0.439422	-0.0315509	-0.0136719	3.36E-05	7.13E-05	0.0019484
0.452923	-0.0253555	-0.0128697	5.66E-05	6.44E-05	0.00156452
0.45285	-0.0264127	-0.0137254	5.23E-05	6.62E-05	0.00157122
0.45266	-0.0276668	-0.0140248	4.40E-05	5.86E-05	0.00157687
0.452319	-0.0291615	-0.013683	4.42E-05	5.63E-05	0.00158045
0.451932	-0.0307749	-0.0130675	4.72E-05	4.97E-05	0.00158152
0.451627	-0.0322218	-0.0128065	4.83E-05	5.05E-05	0.0015848
0.451616	-0.0331401	-0.0140255	4.88E-05	5.34E-05	0.00158152
0.465138	-0.0269801	-0.0131119	6.73E-05	5.15E-05	0.00111181
0.46483	-0.0284061	-0.0129578	6.74E-05	4.36E-05	0.00111687
0.464576	-0.029778	-0.0129884	6.16E-05	3.85E-05	0.00112385
0.464343	-0.0311016	-0.0131038	5.72E-05	3.44E-05	0.00112671
0.464097	-0.0324222	-0.0132198	6.01E-05	3.26E-05	0.0011283
0.463988	-0.0335256	-0.0138769	5.43E-05	3.25E-05	0.00112827
0.463576	-0.035134	-0.0132622	6.02E-05	4.02E-05	0.00112573
0.477205	-0.0288131	-0.0127989	7.07E-05	3.57E-05	0.000449781
0.476927	-0.0302074	-0.0127354	7.07E-05	3.04E-05	0.000579374
0.476591	-0.0316674	-0.0124897	6.76E-05	2.25E-05	0.000589151
0.476461	-0.0328196	-0.0130632	7.32E-05	2.75E-05	0.000598313
0.476287	-0.0340543	-0.0134581	6.71E-05	2.96E-05	0.000596917
0.475889	-0.035602	-0.012928	6.47E-05	2.94E-05	0.000687317
0.48945	-0.0303742	-0.013206	7.52E-05	1.09E-05	0.000327639
0.489263	-0.0315951	-0.0136026	6.74E-05	8.76E-06	0.000118098
0.488956	-0.0330246	-0.0134481	6.51E-05	8.97E-06	1.52E-05
0.48876	-0.0342823	-0.0137484	6.72E-05	8.91E-06	1.20E-05
0.488107	-0.0362198	-0.012223	6.99E-05	1.05E-05	1.13E-05
0.488112	-0.0371563	-0.0133372	5.99E-05	8.99E-06	1.06E-05
0.501732	-0.0309202	-0.0126613	8.83E-05	2.81E-05	0.000774728
0.501451	-0.0322795	-0.0126957	9.29E-05	2.68E-05	0.000749119
0.501092	-0.0337779	-0.0123618	9.25E-05	2.59E-05	0.000644185
0.501056	-0.0347976	-0.0133019	8.36E-05	2.47E-05	0.000648624
0.500777	-0.0361427	-0.0133267	7.75E-05	2.45E-05	0.000643364
0.500535	-0.0374562	-0.0134388	7.12E-05	2.20E-05	0.000640367

0.50036	-0.0386812	-0.0138286	7.02E-05	2.28E-05	0.000630671
0.514011	-0.0324153	-0.0132342	9.12E-05	5.86E-05	0.00132277
0.513596	-0.0339836	-0.0127224	9.56E-05	5.21E-05	0.0013194
0.513278	-0.035401	-0.012567	0.000116384	5.28E-05	0.00131656
0.512969	-0.0367942	-0.012509	0.000115067	5.20E-05	0.0013149
0.512937	-0.0378174	-0.013448	9.47E-05	5.18E-05	0.00130653
0.512549	-0.0393213	-0.0130098	8.90E-05	5.25E-05	0.00130143
0.512168	-0.0408143	-0.0126742	8.46E-05	5.30E-05	0.00129614
0.526038	-0.0342922	-0.0127974	8.83E-05	8.69E-05	0.0020196
0.525837	-0.035555	-0.0131046	9.78E-05	7.48E-05	0.00201769
0.5255	-0.0369707	-0.0129539	0.000120996	6.96E-05	0.0020165
0.524852	-0.0388403	-0.0116238	0.00013119	6.31E-05	0.00200678
0.5249	-0.0397514	-0.0128294	0.000107311	7.37E-05	0.00199325
0.524686	-0.040997	-0.0131284	9.21E-05	8.05E-05	0.00198795
0.524411	-0.042346	-0.0131507	9.20E-05	8.46E-05	0.0019841
0.538094	-0.0360997	-0.0125389	0.000108645	0.000107534	0.00274771
0.537968	-0.037263	-0.0131187	0.0001005	9.20E-05	0.00274923
0.537316	-0.039083	-0.0118828	0.000115108	7.70E-05	0.00274436
0.537038	-0.0404335	-0.0119106	0.000119472	7.49E-05	0.00272837
0.537142	-0.0412951	-0.0133025	0.000108769	8.58E-05	0.00271117
0.536697	-0.0428298	-0.012781	0.000100552	0.000101792	0.00258387
0.550119	-0.0379428	-0.0121841	0.000117056	0.000116566	0.00328001
0.549836	-0.0392958	-0.0122166	0.000111586	9.44E-05	0.00331333
0.54967	-0.0404918	-0.0127082	0.000111232	7.74E-05	0.00330762
0.549281	-0.0419778	-0.012376	0.000116932	7.91E-05	0.00329157
0.549024	-0.0432963	-0.0124947	0.000113334	0.000109399	0.00328315
0.548755	-0.0445981	-0.0126095	0.000110283	0.000125501	0.00324332

Source File beam_0lb_neg15deg_fast_60Hz
Name:
Signal: FFT - Vib 3D Velocity - Magnitude
dB-Reference: 0 dB = 1 m/s
Band No.: 1
Frequency: 60.00 Hz

Interpolated: Yes
Filtered: Yes

X	Y	Z	Mag X	Mag Y	Mag Z
0.0523132	0.0188111	-0.006511	9.90E-07	2.67E-06	7.04E-07
0.0523834	0.0172002	-0.006344	6.03E-07	1.19E-06	7.91E-07
0.0524291	0.0153095	-0.006818	7.73E-07	2.72E-06	7.07E-07
0.0524893	0.013853	-0.006172	6.28E-07	2.55E-06	2.79E-07
0.0525336	0.0119781	-0.006649	3.04E-07	2.29E-06	7.18E-07
0.068309	0.0198132	-0.005963	1.29E-06	2.88E-06	1.26E-06
0.0683698	0.018496	-0.004945	9.75E-07	1.84E-06	1.24E-06
0.0684281	0.0169719	-0.004488	7.91E-07	1.40E-06	1.44E-06
0.0684976	0.0148233	-0.005719	7.95E-07	1.00E-06	1.45E-06
0.068556	0.0131413	-0.005627	7.26E-07	1.53E-06	2.06E-06
0.0843041	0.0209364	-0.005087	6.51E-07	2.31E-06	1.37E-06

0.0843649	0.0193087	-0.004914	6.71E-07	2.35E-06	1.34E-06
0.0844198	0.0181487	-0.00342	7.22E-07	1.96E-06	1.68E-06
0.0844918	0.0157921	-0.005213	7.86E-07	2.71E-06	2.86E-06
0.0845715	0.0141299	-0.005129	1.07E-06	2.91E-06	3.87E-06
0.100287	0.0222836	-0.003603	5.61E-07	4.22E-06	3.96E-06
0.100359	0.0205019	-0.003799	7.59E-07	4.10E-06	6.57E-06
0.10042	0.0189446	-0.003437	8.76E-07	2.55E-06	4.37E-06
0.100482	0.0173873	-0.003074	9.71E-07	2.93E-06	1.33E-06
0.10057	0.0152214	-0.004296	5.92E-07	2.18E-06	1.02E-06
0.116257	0.023388	-0.002722	5.27E-07	2.30E-06	5.25E-06
0.116358	0.0215574	-0.003113	7.84E-07	4.73E-07	8.60E-06
0.116437	0.0197758	-0.003308	8.43E-07	1.65E-06	8.97E-06
0.1165	0.0182187	-0.002945	1.09E-06	1.46E-06	7.44E-06
0.116568	0.0165923	-0.002768	9.34E-07	9.10E-07	8.46E-06
0.132254	0.024426	-0.002084	3.12E-07	2.89E-06	1.94E-06
0.132381	0.0222329	-0.003407	2.82E-07	1.36E-06	2.62E-06
0.132434	0.0209881	-0.002201	6.19E-07	2.21E-06	8.07E-06
0.132508	0.0193453	-0.002019	1.40E-06	2.51E-06	1.00E-05
0.1326	0.0175115	-0.002405	1.93E-06	2.21E-06	1.12E-05
0.148231	0.0255659	-0.001111	9.67E-07	3.60E-06	1.05E-05
0.148337	0.0238406	-0.00122	1.16E-06	3.09E-06	1.21E-05
0.148436	0.0220265	-0.00151	1.17E-06	4.50E-07	1.20E-05
0.148494	0.0205398	-0.00096	1.09E-06	1.62E-06	8.79E-06
0.148584	0.0187937	-0.001058	1.32E-06	1.30E-06	9.01E-06
0.164189	0.0268781	0.0002779	7.22E-07	2.26E-06	5.02E-06
0.164332	0.0248259	-0.00067	6.51E-07	3.30E-06	2.50E-06
0.164424	0.023238	-0.000403	5.99E-07	1.94E-06	4.06E-06
0.164479	0.0217689	0.0002472	4.28E-07	8.58E-07	6.25E-06
0.164547	0.0202142	0.0006107	1.64E-07	6.31E-07	6.33E-06
0.180214	0.02771	0.0004064	1.05E-06	1.38E-06	1.68E-05
0.180266	0.0263629	0.0013282	1.20E-06	1.18E-06	1.81E-05
0.180387	0.0245168	0.0009451	1.60E-06	9.95E-07	2.03E-05
0.180507	0.0226868	0.0005574	1.81E-06	1.20E-06	2.46E-05
0.180658	0.0206657	-0.00029	1.29E-06	1.72E-06	2.40E-05
0.196185	0.028954	0.0016077	1.95E-06	2.88E-06	3.20E-05
0.196259	0.0273826	0.0019727	1.99E-06	3.51E-06	3.10E-05
0.196367	0.0256572	0.0018644	1.90E-06	3.89E-06	2.48E-05
0.196462	0.0239825	0.0019516	1.60E-06	4.44E-06	2.27E-05
0.196552	0.0224301	0.0023156	1.45E-06	4.90E-06	2.63E-05
0.212102	0.0302271	0.0029541	8.98E-07	2.68E-07	1.76E-05
0.212208	0.028537	0.0029379	7.30E-07	2.02E-06	1.34E-05
0.212326	0.0268651	0.0030243	6.69E-07	2.79E-06	6.96E-06
0.212488	0.0249338	0.0023564	8.75E-07	3.01E-06	1.26E-05
0.212523	0.0235338	0.0031941	1.17E-06	3.56E-06	1.98E-05
0.228156	0.0310256	0.0029369	3.52E-07	1.27E-06	4.31E-06
0.228198	0.0296602	0.0038646	4.29E-07	1.00E-06	4.94E-06
0.228292	0.0280381	0.0040374	5.82E-07	6.67E-07	8.25E-06
0.228423	0.0262615	0.0038443	1.03E-06	2.84E-06	1.98E-05
0.228544	0.0245358	0.00374	1.03E-06	3.41E-06	2.21E-05
0.244013	0.032571	0.0050327	1.49E-06	1.78E-06	2.17E-05
0.244109	0.0310196	0.0053922	1.63E-06	2.03E-06	2.17E-05
0.244208	0.0293807	0.0055715	1.77E-06	1.40E-06	1.90E-05

0.244374	0.0275198	0.0050918	1.20E-06	2.12E-06	2.37E-06
0.244433	0.026017	0.0056483	7.13E-07	2.59E-06	3.74E-06
0.259942	0.0338443	0.0063262	2.49E-06	4.56E-06	3.32E-05
0.260076	0.0321213	0.0062173	2.50E-06	4.77E-06	3.38E-05
0.260167	0.0305162	0.0064904	2.61E-06	5.70E-06	3.52E-05
0.260233	0.029067	0.0071334	2.28E-06	5.91E-06	3.20E-05
0.260486	0.0269496	0.0060091	2.15E-06	5.97E-06	3.19E-05
0.275907	0.034963	0.0071981	1.67E-06	3.66E-06	3.20E-05
0.27599	0.0333919	0.0075632	2.01E-06	4.26E-06	3.48E-05
0.276172	0.0316028	0.0072714	2.24E-06	6.57E-06	4.12E-05
0.276337	0.0297932	0.0069865	2.39E-06	6.99E-06	4.30E-05
0.276418	0.0282387	0.0073499	2.31E-06	6.73E-06	4.35E-05
0.291861	0.0360968	0.0081161	6.58E-07	4.91E-06	1.64E-05
0.291976	0.0344935	0.0083898	1.15E-06	4.20E-06	1.97E-05
0.292161	0.0326685	0.0080041	1.32E-06	4.36E-06	2.46E-05
0.292334	0.0308588	0.0077202	1.26E-06	3.56E-06	2.82E-05
0.292328	0.0295417	0.0087362	1.20E-06	2.87E-06	2.69E-05
0.307728	0.0374655	0.0097407	1.37E-07	3.07E-06	2.40E-06
0.3078	0.035945	0.0101927	2.84E-08	3.08E-06	6.46E-06
0.30798	0.0341545	0.009901	3.05E-07	2.31E-06	6.77E-06
0.308161	0.0323457	0.0096178	7.02E-07	2.64E-06	1.46E-05
0.30825	0.030827	0.0100764	6.24E-07	2.88E-06	1.06E-05
0.323656	0.0386286	0.0107496	1.80E-06	2.19E-06	3.30E-05
0.323743	0.0370737	0.0111088	1.76E-06	2.45E-06	3.52E-05
0.323949	0.0352854	0.0108202	1.34E-06	2.60E-06	2.99E-05
0.324182	0.0333751	0.0102591	8.92E-07	2.00E-06	1.88E-05
0.32437	0.0315822	0.0099725	5.85E-07	2.90E-06	1.34E-05
0.339607	0.0397397	0.0116182	1.55E-06	2.86E-06	2.97E-05
0.339714	0.0381863	0.01198	1.59E-06	3.63E-06	3.41E-05
0.339972	0.036261	0.011319	1.61E-06	4.05E-06	4.13E-05
0.340046	0.0347208	0.0117814	1.63E-06	4.40E-06	4.32E-05
0.340088	0.0332659	0.0124244	1.57E-06	4.79E-06	4.16E-05
0.35549	0.0409994	0.0129043	5.18E-07	2.94E-06	2.01E-05
0.35558	0.0394429	0.0132644	3.31E-07	2.72E-06	2.25E-05
0.355705	0.0378556	0.0135353	7.23E-07	2.39E-06	2.17E-05
0.356105	0.0356611	0.0121358	1.13E-06	2.58E-06	2.68E-05
0.356048	0.0344064	0.0133355	1.31E-06	3.00E-06	2.91E-05
0.371313	0.0423734	0.0145136	3.97E-07	1.94E-06	9.60E-06
0.371508	0.0406165	0.0143178	5.50E-07	1.64E-06	1.21E-05
0.371601	0.0390592	0.0146798	7.93E-07	2.23E-06	1.31E-05
0.371882	0.0371336	0.0140243	1.21E-06	3.53E-06	1.46E-05
0.371957	0.0356453	0.0145772	1.33E-06	3.79E-06	1.60E-05
0.387086	0.0437736	0.0161554	2.00E-07	1.75E-06	1.50E-05
0.387325	0.0419861	0.0158708	3.69E-07	1.10E-06	1.60E-05
0.387527	0.0402283	0.015678	6.62E-07	8.54E-07	1.98E-05
0.387567	0.0387702	0.0163196	7.77E-07	1.92E-06	1.66E-05
0.387842	0.0368774	0.0157603	1.37E-06	2.78E-06	1.15E-05
0.402963	0.0449719	0.0172925	6.33E-07	6.09E-07	1.56E-05
0.403039	0.0434822	0.0178414	6.51E-07	1.29E-06	1.54E-05
0.403401	0.0414589	0.0169108	6.37E-07	1.78E-06	1.62E-05
0.403706	0.0395332	0.0162595	3.37E-07	2.50E-06	1.47E-05
0.403801	0.038009	0.016721	3.58E-07	3.10E-06	1.07E-05

0.418821	0.0462356	0.0185606	4.45E-07	1.08E-06	1.26E-05
0.418819	0.044841	0.0193839	5.13E-07	1.54E-06	1.37E-05
0.419136	0.0429176	0.0187326	6.29E-07	1.68E-06	1.24E-05
0.419333	0.0411916	0.0186366	1.04E-06	1.72E-06	8.44E-06
0.419388	0.0397338	0.0192827	7.25E-07	1.76E-06	6.38E-06
0.434707	0.0473927	0.0195979	1.03E-06	1.63E-06	8.37E-06
0.434682	0.046029	0.0205132	9.98E-07	1.34E-06	6.76E-06
0.434988	0.0441558	0.0199499	1.14E-06	1.67E-06	7.27E-06
0.43523	0.0423987	0.0197664	1.23E-06	1.43E-06	7.21E-06
0.435474	0.0406048	0.0194897	1.30E-06	1.64E-06	6.94E-06
0.450213	0.0491363	0.0222344	1.41E-06	3.13E-06	8.18E-06
0.450466	0.0473452	0.0219538	1.40E-06	2.91E-06	8.37E-06
0.450565	0.0458009	0.0223118	1.36E-06	3.11E-06	7.40E-06
0.45064	0.044308	0.0228649	1.40E-06	3.16E-06	6.57E-06
0.45111	0.0421845	0.0216711	1.04E-06	2.88E-06	6.16E-06
0.465955	0.0504617	0.0237105	1.09E-06	4.98E-06	4.68E-06
0.466166	0.0487711	0.0237106	1.68E-06	4.83E-06	1.28E-06
0.466426	0.0469962	0.0234271	1.62E-06	4.62E-06	3.09E-06
0.466799	0.0450384	0.0226937	1.78E-06	4.32E-06	7.00E-06
0.467081	0.0432281	0.0223224	1.71E-06	3.36E-06	8.00E-06
0.481729	0.0517336	0.0250436	1.05E-06	2.83E-06	7.44E-06
0.482179	0.0497335	0.024123	2.15E-06	2.60E-06	5.25E-06
0.482143	0.0483643	0.0250385	3.01E-06	2.97E-06	1.18E-05
0.482692	0.0461947	0.0236608	3.47E-06	1.79E-06	1.55E-05
0.482837	0.0445987	0.0239425	3.31E-06	1.62E-06	1.51E-05
0.497592	0.0528876	0.0260516	3.33E-06	3.81E-06	2.43E-05
0.497697	0.051339	0.0264104	3.17E-06	2.22E-06	2.20E-05
0.497941	0.0496307	0.0263176	2.16E-06	2.08E-06	1.48E-05
0.498242	0.0478032	0.0259555	1.34E-06	1.89E-06	7.62E-06
0.498346	0.0462538	0.026319	1.44E-06	1.65E-06	6.30E-06
0.513208	0.0543419	0.0279188	2.94E-06	4.65E-06	2.03E-05
0.513618	0.0524037	0.0271841	1.92E-06	3.54E-06	1.65E-05
0.513742	0.0508559	0.0275493	1.62E-06	1.08E-06	1.50E-05
0.514151	0.0489149	0.0268186	1.65E-06	4.98E-07	1.29E-05
0.514206	0.0474286	0.0273653	1.54E-06	1.06E-06	1.60E-05
0.52892	0.0556604	0.0293582	2.37E-06	1.74E-06	1.26E-05
0.529054	0.0540765	0.0296277	6.33E-07	1.04E-06	6.69E-06
0.529233	0.0524633	0.0298118	2.36E-06	2.97E-06	1.83E-05
0.529471	0.0507496	0.0297206	3.13E-06	4.31E-06	2.37E-05
0.529735	0.0490026	0.0295402	3.09E-06	4.75E-06	2.76E-05

Source File beam_0lb_neg15deg_fast_169.4Hz
Name:
Signal: FFT - Vib 3D Velocity - Magnitude
dB-Reference: 0 dB = 1 m/s
Band No.: 1
Frequency: 169.4 Hz

Interpolated: Yes
Filtered: Yes

X	Y	Z	Mag X	Mag Y	Mag Z
0.0523132	0.0188111	-0.006511	1.07E-05	2.42E-05	5.01E-05
0.0523834	0.0172002	-0.006344	1.19E-05	2.66E-05	4.94E-05
0.0524291	0.0153095	-0.006818	1.33E-05	2.84E-05	4.88E-05
0.0524893	0.013853	-0.006172	1.19E-05	2.37E-05	4.52E-05
0.0525336	0.0119781	-0.006649	1.24E-05	2.04E-05	4.69E-05
0.068309	0.0198132	-0.005963	1.81E-05	3.28E-05	0.000114961
0.0683698	0.018496	-0.004945	1.95E-05	3.32E-05	0.000115227
0.0684281	0.0169719	-0.004488	2.16E-05	3.89E-05	0.000116333
0.0684976	0.0148233	-0.005719	1.76E-05	3.56E-05	0.000115084
0.068556	0.0131413	-0.005627	1.73E-05	3.27E-05	0.000116364
0.0843041	0.0209364	-0.005087	2.78E-05	5.23E-05	0.000235957
0.0843649	0.0193087	-0.004914	3.01E-05	5.39E-05	0.000236436
0.0844198	0.0181487	-0.00342	3.27E-05	5.15E-05	0.000236416
0.0844918	0.0157921	-0.005213	2.72E-05	5.06E-05	0.000236254
0.0845715	0.0141299	-0.005129	2.47E-05	4.78E-05	0.000237122
0.100287	0.0222836	-0.003603	3.78E-05	7.40E-05	0.000382624
0.100359	0.0205019	-0.003799	3.78E-05	7.20E-05	0.000382694
0.10042	0.0189446	-0.003437	4.18E-05	6.85E-05	0.000382977
0.100482	0.0173873	-0.003074	3.93E-05	6.83E-05	0.000381521
0.10057	0.0152214	-0.004296	3.78E-05	6.69E-05	0.000381816
0.116257	0.023388	-0.002722	4.70E-05	8.69E-05	0.000536941
0.116358	0.0215574	-0.003113	4.46E-05	8.63E-05	0.000535821
0.116437	0.0197758	-0.003308	4.48E-05	8.37E-05	0.000535799
0.1165	0.0182187	-0.002945	4.53E-05	8.34E-05	0.000533329
0.116568	0.0165923	-0.002768	4.58E-05	8.58E-05	0.000533874
0.132254	0.024426	-0.002084	5.23E-05	0.00010067	0.000688127
0.132381	0.0222329	-0.003407	5.06E-05	0.000101029	0.000688489
0.132434	0.0209881	-0.002201	4.98E-05	9.93E-05	0.0006884
0.132508	0.0193453	-0.002019	5.11E-05	9.94E-05	0.000686616
0.1326	0.0175115	-0.002405	5.17E-05	0.000102562	0.000687352
0.148231	0.0255659	-0.001111	5.43E-05	0.000116045	0.000817102
0.148337	0.0238406	-0.00122	5.38E-05	0.00011838	0.00081644
0.148436	0.0220265	-0.00151	5.34E-05	0.000118029	0.0008167
0.148494	0.0205398	-0.00096	5.50E-05	0.000117598	0.000814075
0.148584	0.0187937	-0.001058	5.58E-05	0.000119969	0.000816374
0.164189	0.0268781	0.0002779	5.52E-05	0.000129941	0.000915721
0.164332	0.0248259	-0.00067	5.48E-05	0.000131702	0.000914993
0.164424	0.023238	-0.000403	5.32E-05	0.000131993	0.000914291
0.164479	0.0217689	0.0002472	5.40E-05	0.000131867	0.000914454
0.164547	0.0202142	0.0006107	5.45E-05	0.000134554	0.000914265
0.180214	0.02771	0.0004064	5.02E-05	0.000144521	0.000968656
0.180266	0.0263629	0.0013282	5.05E-05	0.000145595	0.000964589
0.180387	0.0245168	0.0009451	4.83E-05	0.00014472	0.00096472
0.180507	0.0226868	0.0005574	4.81E-05	0.000145859	0.000967086
0.180658	0.0206657	-0.00029	4.74E-05	0.000149349	0.00096742
0.196185	0.028954	0.0016077	3.96E-05	0.000147628	0.000972845
0.196259	0.0273826	0.0019727	4.03E-05	0.000147393	0.000969923
0.196367	0.0256572	0.0018644	4.04E-05	0.000148834	0.000968422
0.196462	0.0239825	0.0019516	3.90E-05	0.000150258	0.000973458
0.196552	0.0224301	0.0023156	3.82E-05	0.000154638	0.000970562
0.212102	0.0302271	0.0029541	2.77E-05	0.00013832	0.000924678

0.212208	0.028537	0.0029379	2.83E-05	0.000140714	0.000924667
0.212326	0.0268651	0.0030243	2.76E-05	0.000148232	0.000928896
0.212488	0.0249338	0.0023564	2.62E-05	0.000151085	0.000933692
0.212523	0.0235338	0.0031941	2.50E-05	0.000152899	0.000932025
0.228156	0.0310256	0.0029369	1.35E-05	0.000123885	0.000830166
0.228198	0.0296602	0.0038646	1.31E-05	0.000128797	0.000832398
0.228292	0.0280381	0.0040374	1.28E-05	0.000137748	0.000833233
0.228423	0.0262615	0.0038443	1.17E-05	0.000142193	0.000837452
0.228544	0.0245358	0.00374	1.15E-05	0.000141784	0.000834436
0.244013	0.032571	0.0050327	7.62E-06	0.000106685	0.00069471
0.244109	0.0310196	0.0053922	8.40E-06	0.00010893	0.000695193
0.244208	0.0293807	0.0055715	9.11E-06	0.000116846	0.000695009
0.244374	0.0275198	0.0050918	9.16E-06	0.000116132	0.000694305
0.244433	0.026017	0.0056483	1.05E-05	0.0001164	0.000692201
0.259942	0.0338443	0.0063262	2.50E-05	7.60E-05	0.000517257
0.260076	0.0321213	0.0062173	2.54E-05	8.06E-05	0.000519233
0.260167	0.0305162	0.0064904	2.53E-05	8.70E-05	0.000521665
0.260233	0.029067	0.0071334	2.62E-05	9.29E-05	0.000522962
0.260486	0.0269496	0.0060091	2.79E-05	8.74E-05	0.000519629
0.275907	0.034963	0.0071981	4.02E-05	5.91E-05	0.000317112
0.27599	0.0333919	0.0075632	4.02E-05	6.09E-05	0.000318482
0.276172	0.0316028	0.0072714	3.98E-05	6.73E-05	0.000320893
0.276337	0.0297932	0.0069865	3.99E-05	6.63E-05	0.00032204
0.276418	0.0282387	0.0073499	4.13E-05	6.23E-05	0.000318451
0.291861	0.0360968	0.0081161	5.45E-05	3.62E-05	0.000101817
0.291976	0.0344935	0.0083898	5.44E-05	3.79E-05	0.000102201
0.292161	0.0326685	0.0080041	5.49E-05	3.85E-05	0.00010351
0.292334	0.0308588	0.0077202	5.62E-05	4.10E-05	0.000105026
0.292328	0.0295417	0.0087362	5.68E-05	3.63E-05	0.000103564
0.307728	0.0374655	0.0097407	6.93E-05	2.59E-05	0.000124287
0.3078	0.035945	0.0101927	6.94E-05	2.56E-05	0.000140383
0.30798	0.0341545	0.009901	6.86E-05	2.45E-05	0.000139821
0.308161	0.0323457	0.0096178	6.88E-05	1.68E-05	0.000137706
0.30825	0.030827	0.0100764	6.86E-05	1.15E-05	0.000119446
0.323656	0.0386286	0.0107496	7.81E-05	3.70E-05	0.000356134
0.323743	0.0370737	0.0111088	7.79E-05	3.88E-05	0.000383645
0.323949	0.0352854	0.0108202	7.65E-05	3.97E-05	0.000399198
0.324182	0.0333751	0.0102591	7.52E-05	3.43E-05	0.0003802
0.32437	0.0315822	0.0099725	7.49E-05	3.34E-05	0.000346357
0.339607	0.0397397	0.0116182	8.26E-05	5.98E-05	0.000514598
0.339714	0.0381863	0.01198	8.27E-05	5.33E-05	0.000526238
0.339972	0.036261	0.011319	8.20E-05	5.21E-05	0.000525393
0.340046	0.0347208	0.0117814	8.10E-05	5.63E-05	0.000526436
0.340088	0.0332659	0.0124244	7.98E-05	5.63E-05	0.000507369
0.35549	0.0409994	0.0129043	8.37E-05	8.43E-05	0.000663727
0.35558	0.0394429	0.0132644	8.38E-05	7.28E-05	0.000661384
0.355705	0.0378556	0.0135353	8.42E-05	7.00E-05	0.000659883
0.356105	0.0356611	0.0121358	8.34E-05	6.84E-05	0.000661223
0.356048	0.0344064	0.0133355	8.23E-05	7.08E-05	0.000659943
0.371313	0.0423734	0.0145136	8.14E-05	9.25E-05	0.000765611
0.371508	0.0406165	0.0143178	8.16E-05	8.72E-05	0.000764528
0.371601	0.0390592	0.0146798	8.20E-05	8.67E-05	0.000763368

0.371882	0.0371336	0.0140243	8.22E-05	8.54E-05	0.000763275
0.371957	0.0356453	0.0145772	8.13E-05	8.25E-05	0.000762266
0.387086	0.0437736	0.0161554	7.65E-05	8.89E-05	0.000817143
0.387325	0.0419861	0.0158708	7.69E-05	8.91E-05	0.00081927
0.387527	0.0402283	0.015678	7.72E-05	9.38E-05	0.000818846
0.387567	0.0387702	0.0163196	7.77E-05	9.41E-05	0.000819266
0.387842	0.0368774	0.0157603	7.79E-05	9.41E-05	0.000818128
0.402963	0.0449719	0.0172925	6.53E-05	8.25E-05	0.000815065
0.403039	0.0434822	0.0178414	6.54E-05	8.45E-05	0.000817025
0.403401	0.0414589	0.0169108	6.58E-05	8.97E-05	0.000819196
0.403706	0.0395332	0.0162595	6.72E-05	9.30E-05	0.000820842
0.403801	0.038009	0.016721	6.80E-05	9.52E-05	0.000820595
0.418821	0.0462356	0.0185606	5.07E-05	7.17E-05	0.00075841
0.418819	0.044841	0.0193839	5.07E-05	7.30E-05	0.000760098
0.419136	0.0429176	0.0187326	5.10E-05	7.69E-05	0.000762748
0.419333	0.0411916	0.0186366	5.25E-05	8.01E-05	0.000764282
0.419388	0.0397338	0.0192827	5.34E-05	8.11E-05	0.00076269
0.434707	0.0473927	0.0195979	3.31E-05	5.62E-05	0.000653224
0.434682	0.046029	0.0205132	3.25E-05	5.53E-05	0.000653445
0.434988	0.0441558	0.0199499	3.32E-05	5.69E-05	0.0006526
0.43523	0.0423987	0.0197664	3.49E-05	5.68E-05	0.000648768
0.435474	0.0406048	0.0194897	3.48E-05	5.68E-05	0.000646102
0.450213	0.0491363	0.0222344	1.02E-05	3.21E-05	0.000497293
0.450466	0.0473452	0.0219538	9.09E-06	3.05E-05	0.000497402
0.450565	0.0458009	0.0223118	8.51E-06	2.93E-05	0.000493741
0.45064	0.044308	0.0228649	1.08E-05	2.94E-05	0.000485801
0.45111	0.0421845	0.0216711	1.17E-05	2.91E-05	0.000481633
0.465955	0.0504617	0.0237105	1.62E-05	9.41E-06	0.000291179
0.466166	0.0487711	0.0237106	1.72E-05	1.22E-05	0.000291491
0.466426	0.0469962	0.0234271	1.31E-05	1.07E-05	0.000288669
0.466799	0.0450384	0.0226937	1.18E-05	7.28E-06	0.000282164
0.467081	0.0432281	0.0223224	9.01E-06	7.51E-06	0.000275642
0.481729	0.0517336	0.0250436	3.90E-05	4.59E-05	6.52E-05
0.482179	0.0497335	0.024123	3.72E-05	4.64E-05	6.80E-05
0.482143	0.0483643	0.0250385	3.52E-05	4.63E-05	6.86E-05
0.482692	0.0461947	0.0236608	3.25E-05	4.32E-05	6.52E-05
0.482837	0.0445987	0.0239425	2.97E-05	3.96E-05	6.11E-05
0.497592	0.0528876	0.0260516	6.29E-05	8.70E-05	0.000242469
0.497697	0.051339	0.0264104	6.31E-05	8.76E-05	0.000246422
0.497941	0.0496307	0.0263176	5.86E-05	8.67E-05	0.000249715
0.498242	0.0478032	0.0259555	6.08E-05	8.53E-05	0.00025242
0.498346	0.0462538	0.026319	5.68E-05	8.23E-05	0.000255663
0.513208	0.0543419	0.0279188	8.99E-05	0.00013664	0.000534836
0.513618	0.0524037	0.0271841	8.93E-05	0.000129132	0.000534299
0.513742	0.0508559	0.0275493	8.52E-05	0.000130122	0.000537542
0.514151	0.0489149	0.0268186	8.25E-05	0.000128529	0.000539257
0.514206	0.0474286	0.0273653	8.31E-05	0.000127997	0.000542793
0.52892	0.0556604	0.0293582	0.00010851	0.000179709	0.000759141
0.529054	0.0540765	0.0296277	0.000112194	0.000170476	0.000772319
0.529233	0.0524633	0.0298118	0.000110618	0.000161964	0.000770664
0.529471	0.0507496	0.0297206	0.000109051	0.000160396	0.000774398
0.529735	0.0490026	0.0295402	0.000106589	0.000157486	0.000763933

Source File
 Name: beam0lb_neg30deg_fast_60.63Hz
 Signal: FFT - Vib 3D Velocity - Magnitude
 dB-Reference: 0 dB = 1 m/s
 Band No.: 1
 Frequency: 60.63 Hz

Interpolated: Yes
 Filtered: Yes

X	Y	Z	Mag X	Mag Y	Mag Z
0.0533167	0.0254045	-0.003977	2.93E-06	7.05E-06	9.89E-06
0.0702199	0.0260086	-0.004857	4.39E-07	5.55E-07	1.95E-05
0.0702813	0.0245392	-0.004182	4.32E-06	6.97E-06	1.89E-05
0.05339	0.0238539	-0.003484	5.09E-07	1.36E-06	1.01E-05
0.0703886	0.0229198	-0.003873	6.13E-06	1.46E-05	1.69E-05
0.0536137	0.0214872	-0.004809	1.11E-06	3.66E-06	9.93E-06
0.0705848	0.0208288	-0.004553	6.04E-07	2.02E-05	1.36E-05
0.0536746	0.0201032	-0.003948	1.78E-06	5.18E-06	7.80E-06
0.087143	0.0268674	-0.005188	2.32E-06	2.37E-06	4.17E-05
0.087175	0.0256043	-0.004058	6.63E-06	9.09E-06	4.26E-05
0.0873346	0.0237775	-0.004202	8.16E-06	1.99E-05	4.05E-05
0.087526	0.0217269	-0.00479	5.60E-06	2.52E-05	3.49E-05
0.104084	0.0279816	-0.004968	5.96E-07	2.48E-06	6.90E-05
0.104201	0.0263038	-0.004745	2.47E-06	1.95E-06	7.72E-05
0.104384	0.0244207	-0.004971	2.63E-06	5.61E-06	7.35E-05
0.104556	0.0225918	-0.005111	3.87E-06	1.51E-05	6.46E-05
0.121112	0.0289379	-0.005106	1.87E-06	1.03E-05	9.66E-05
0.121275	0.0271784	-0.005061	1.49E-06	9.79E-07	0.000105204
0.121375	0.0255815	-0.004654	1.88E-06	3.02E-06	0.000107434
0.12163	0.0234909	-0.005328	1.39E-06	4.57E-06	9.57E-05
0.138249	0.0297812	-0.005505	2.96E-06	1.98E-06	0.000128665
0.138447	0.0279387	-0.00564	2.70E-06	1.09E-06	0.000141304
0.138616	0.0261345	-0.005682	3.18E-06	6.78E-07	0.000141563
0.138788	0.0243722	-0.005631	2.55E-06	9.88E-07	0.000133316
0.155425	0.0307017	-0.005708	2.80E-06	3.03E-06	0.000160083
0.155593	0.0289808	-0.005569	2.99E-06	1.38E-06	0.000166678
0.155788	0.027135	-0.0057	3.26E-06	3.20E-06	0.000176082
0.15604	0.0251667	-0.006098	2.87E-06	3.78E-06	0.000177144
0.172769	0.030128	-0.005314	3.66E-06	2.55E-06	0.000206445
0.173112	0.0279144	-0.006254	3.86E-06	4.53E-06	0.00021637
0.173213	0.0263949	-0.005658	4.10E-06	5.56E-06	0.000223931
0.190087	0.031026	-0.005582	6.30E-06	2.98E-06	0.000228015
0.190354	0.0290989	-0.005887	6.89E-06	5.40E-06	0.000250963
0.190623	0.0271276	-0.00628	6.98E-06	5.32E-06	0.000252126

0.207415	0.0320703	-0.005573	7.48E-06	5.25E-06	0.000265451
0.207752	0.0299783	-0.006236	7.80E-06	4.65E-06	0.000280754
0.207911	0.0283328	-0.005907	7.69E-06	4.25E-06	0.000283827
0.224823	0.0330712	-0.005633	7.98E-06	6.14E-06	0.000289793
0.225232	0.0309001	-0.006469	8.45E-06	5.01E-06	0.000302818
0.225435	0.0291714	-0.006316	8.58E-06	3.97E-06	0.000307509
0.22566	0.027359	-0.006343	9.32E-06	4.19E-06	0.000312098
0.208228	0.0263208	-0.006382	8.09E-06	1.94E-06	0.000288142
0.242398	0.033884	-0.006124	8.74E-06	5.47E-06	0.000289384
0.242769	0.0318328	-0.006686	1.03E-05	4.54E-06	0.000313325
0.242842	0.0303842	-0.005906	1.06E-05	4.48E-06	0.000322192
0.243197	0.0283282	-0.006465	1.06E-05	3.67E-06	0.000325269
0.26002	0.0347638	-0.006514	1.02E-05	4.85E-06	0.000295197
0.260114	0.033272	-0.005823	1.26E-05	5.54E-06	0.000344214
0.260398	0.0314198	-0.005933	1.23E-05	5.17E-06	0.000340839
0.260849	0.0292444	-0.006753	1.12E-05	5.34E-06	0.000340686
0.277617	0.0358441	-0.006431	1.45E-05	6.75E-06	0.000373834
0.277876	0.0340279	-0.006453	1.48E-05	6.17E-06	0.000379641
0.278105	0.0322932	-0.006291	1.23E-05	5.71E-06	0.000348423
0.278245	0.0307182	-0.005772	1.15E-05	6.58E-06	0.000339016
0.295107	0.0371701	-0.005801	1.48E-05	5.99E-06	0.000376589
0.295392	0.035355	-0.005817	1.52E-05	7.14E-06	0.000374871
0.295957	0.0330613	-0.006894	1.29E-05	5.44E-06	0.000339541
0.296054	0.0315625	-0.006195	1.23E-05	5.19E-06	0.000328006
0.31329	0.0361377	-0.006406	1.55E-05	7.56E-06	0.000345411
0.31356	0.0343727	-0.006332	1.37E-05	6.30E-06	0.000326649
0.313487	0.033149	-0.005012	1.33E-05	4.51E-06	0.000315686
0.330878	0.0375253	-0.005647	1.50E-05	8.02E-06	0.000327128
0.331389	0.0354037	-0.006364	1.49E-05	7.45E-06	0.000320185
0.331577	0.0337372	-0.006017	1.39E-05	6.07E-06	0.000306657
0.348737	0.0385821	-0.005674	1.49E-05	7.67E-06	0.000290119
0.349188	0.0365629	-0.006114	1.56E-05	8.84E-06	0.000279072
0.349289	0.0350679	-0.005415	1.54E-05	6.76E-06	0.000281336
0.34974	0.0330462	-0.00585	1.44E-05	6.95E-06	0.000292722
0.331933	0.0318497	-0.0062	1.35E-05	6.20E-06	0.000324513
0.366769	0.03814	-0.004972	1.58E-05	9.27E-06	0.00025363
0.367461	0.0358052	-0.006105	1.44E-05	6.48E-06	0.000234448
0.367408	0.0344994	-0.004967	1.35E-05	5.18E-06	0.000227781
0.384788	0.0391654	-0.005033	1.47E-05	8.39E-06	0.000219376
0.38514	0.0373094	-0.005119	1.38E-05	6.64E-06	0.000188795
0.38571	0.0351817	-0.00581	1.38E-05	6.71E-06	0.000187811
0.402797	0.0402781	-0.0049	1.42E-05	8.22E-06	0.000169624
0.402812	0.0388875	-0.003932	1.38E-05	7.57E-06	0.000145527
0.403553	0.0365655	-0.005052	1.53E-05	7.66E-06	0.000147433
0.421196	0.0396366	-0.004649	1.45E-05	7.78E-06	7.64E-05
0.421634	0.0376968	-0.004896	1.47E-05	6.20E-06	8.20E-05
0.422023	0.035836	-0.004962	1.45E-05	5.34E-06	8.58E-05

0.403976	0.0346266	-0.005302	1.67E-05	7.66E-06	0.000160454
0.439381	0.0407036	-0.004652	1.54E-05	8.77E-06	1.46E-05
0.439522	0.0391486	-0.004024	1.56E-05	6.74E-06	1.45E-05
0.440052	0.0371461	-0.004437	1.39E-05	4.04E-06	1.43E-05
0.457273	0.0422047	-0.00368	1.65E-05	6.95E-06	5.86E-05
0.457618	0.040431	-0.003572	1.70E-05	5.05E-06	5.60E-05
0.457862	0.038757	-0.003197	1.64E-05	3.38E-06	5.37E-05
0.4754	0.0434821	-0.003211	1.76E-05	4.55E-06	0.000127503
0.475997	0.0414391	-0.003698	1.66E-05	3.64E-06	0.000124144
0.475898	0.040156	-0.002468	1.88E-05	4.05E-06	0.000129535
0.494054	0.0428907	-0.002864	1.86E-05	3.97E-06	0.000198463
0.494473	0.04103	-0.002918	2.02E-05	4.09E-06	0.000214759
0.495051	0.0390051	-0.003299	1.67E-05	4.84E-06	0.000204887
0.476912	0.0376378	-0.003971	1.62E-05	5.83E-06	0.000130486
0.511841	0.0446297	-0.001332	2.04E-05	4.16E-06	0.000272057
0.512691	0.0423711	-0.002317	2.11E-05	2.68E-06	0.000297886
0.513209	0.0404342	-0.002528	1.56E-05	3.56E-06	0.000273536
0.530638	0.0454296	-0.002005	1.86E-05	1.52E-06	0.000314071
0.530866	0.0437902	-0.001533	2.04E-05	1.55E-06	0.000354367
0.531398	0.0418508	-0.001737	1.67E-05	3.19E-06	0.000346605
0.54901	0.0453045	-0.00057	2.10E-05	5.70E-07	0.000442157
0.549672	0.0432508	-0.001019	1.89E-05	2.72E-06	0.000405054
0.551405	0.0417363	-0.000494	1.84E-05	2.70E-06	0.000427276
0.551652	0.0411817	-0.000846	1.93E-05	1.15E-06	0.000471474
0.55042	0.0408342	-0.001501	2.17E-05	2.15E-06	0.000483467
0.5502	0.0413181	-0.001224	2.06E-05	3.13E-06	0.000446094
0.551135	0.0434039	-0.000883	1.76E-05	3.23E-06	0.000435757
0.55059	0.0453314	-0.000681	2.04E-05	2.03E-06	0.000485383
0.548519	0.0470298	-0.000371	2.08E-05	1.33E-06	0.000454118
0.550296	0.0468421	-0.000889	2.13E-05	1.86E-06	0.000523133
0.536792	0.0405892	-0.001111	2.14E-05	1.82E-06	0.000433396
0.531577	0.0403667	-0.001233	1.75E-05	2.93E-06	0.000337476
0.541746	0.046761	-0.000522	1.69E-05	7.13E-07	0.00034863
0.530576	0.045748	-0.002055	1.60E-05	2.18E-06	0.000295823
0.513462	0.039239	-0.002475	1.47E-05	3.31E-06	0.000264553
0.511757	0.0454073	-0.001594	1.80E-05	3.41E-06	0.00026108
0.494886	0.0386306	-0.002498	1.43E-05	5.14E-06	0.000196452
0.493526	0.0445186	-0.002399	1.70E-05	2.52E-06	0.00019504
0.476927	0.0374473	-0.00388	1.55E-05	6.33E-06	0.000134689
0.480228	0.0439778	-0.002751	1.76E-05	4.00E-06	0.000154054
0.475355	0.0436518	-0.003188	1.67E-05	6.25E-06	0.000126039
0.467449	0.037303	-0.00354	1.67E-05	5.96E-06	0.000100913
0.458391	0.0369414	-0.003692	1.59E-05	4.03E-06	5.01E-05
0.457006	0.0430438	-0.003343	1.49E-05	8.69E-06	5.74E-05
0.440404	0.0358787	-0.004781	1.29E-05	3.44E-06	1.43E-05
0.438728	0.0424148	-0.003574	1.35E-05	9.38E-06	1.63E-05
0.421969	0.0354445	-0.00446	1.40E-05	4.57E-06	8.66E-05

0.420559	0.0417591	-0.003863	1.33E-05	7.24E-06	7.62E-05
0.403773	0.0347837	-0.004638	1.71E-05	7.56E-06	0.000160574
0.419034	0.0416055	-0.004114	1.40E-05	7.09E-06	0.000141782
0.402521	0.0410067	-0.004401	1.57E-05	7.66E-06	0.000183084
0.398523	0.0345196	-0.004842	1.63E-05	7.99E-06	0.000188117
0.385733	0.0340306	-0.005058	1.40E-05	6.44E-06	0.000197574
0.384517	0.0402881	-0.004821	1.65E-05	9.19E-06	0.000227026
0.367529	0.0335867	-0.004747	1.41E-05	5.07E-06	0.000232454
0.366318	0.039944	-0.004436	1.57E-05	1.09E-05	0.000260006
0.349839	0.0324945	-0.005913	1.55E-05	6.80E-06	0.000304597
0.358697	0.0390252	-0.005979	1.43E-05	8.76E-06	0.000271597
0.34861	0.0389826	-0.005436	1.48E-05	7.66E-06	0.000297075
0.331962	0.0317671	-0.006267	1.48E-05	7.49E-06	0.000332029
0.330773	0.0383051	-0.005799	1.56E-05	8.03E-06	0.000335337
0.330537	0.0317064	-0.006315	1.27E-05	5.85E-06	0.000318671
0.314073	0.0311836	-0.006341	1.23E-05	4.75E-06	0.000311373
0.312973	0.0376775	-0.006051	1.40E-05	7.79E-06	0.000320368
0.296187	0.0306736	-0.006211	1.37E-05	6.54E-06	0.000346132
0.296138	0.036934	-0.006438	1.14E-05	3.01E-06	0.000327701
0.300388	0.0371867	-0.006324	1.08E-05	4.96E-06	0.00029217
0.287625	0.0301979	-0.006649	1.39E-05	9.11E-06	0.000368249
0.278399	0.0299921	-0.006081	1.17E-05	7.61E-06	0.000351215
0.277559	0.0361084	-0.006339	1.36E-05	5.48E-06	0.000345923
0.26063	0.0293162	-0.005602	1.03E-05	4.96E-06	0.000330079
0.259987	0.0351749	-0.006594	9.63E-06	3.49E-06	0.000278012
0.243195	0.0281137	-0.006256	1.01E-05	4.08E-06	0.000316034
0.242253	0.0346929	-0.005848	8.74E-06	3.96E-06	0.000285595
0.225689	0.0271771	-0.006366	9.61E-06	5.11E-06	0.000306954
0.224878	0.033621	-0.006427	8.15E-06	6.16E-06	0.000289378
0.208301	0.0261156	-0.006721	8.21E-06	2.70E-06	0.000289565
0.207402	0.0328801	-0.006274	6.93E-06	5.38E-06	0.000257722
0.20286	0.0260845	-0.006197	7.80E-06	1.69E-06	0.000280202
0.190867	0.0253227	-0.006529	6.99E-06	4.40E-06	0.000256671
0.190008	0.032181	-0.006005	5.77E-06	2.85E-06	0.000225085
0.173422	0.0247309	-0.005866	3.85E-06	5.07E-06	0.000223674
0.172574	0.0317482	-0.00519	3.44E-06	2.33E-06	0.000204382
0.156187	0.0237525	-0.006097	1.96E-06	4.30E-06	0.000180155
0.155616	0.0305967	-0.005963	2.83E-06	2.93E-06	0.000174276
0.155383	0.0308239	-0.005437	2.56E-06	2.81E-06	0.000152773
0.13892	0.0230574	-0.005677	1.09E-06	1.13E-06	0.000127744
0.138173	0.0301677	-0.005138	2.58E-06	1.16E-05	0.000117645
0.12178	0.0221788	-0.005705	3.80E-06	1.03E-05	9.26E-05
0.121135	0.0291383	-0.005636	2.34E-06	2.13E-05	7.92E-05
0.104646	0.0215435	-0.005173	1.20E-05	2.21E-05	6.08E-05
0.103997	0.0287326	-0.004767	1.24E-06	1.10E-05	5.80E-05
0.0875995	0.0208753	-0.004723	1.10E-05	2.72E-05	3.29E-05
0.087066	0.0278018	-0.005068	1.06E-06	1.16E-06	3.52E-05

0.0705839	0.0203378	-0.003996	2.37E-06	1.49E-05	1.36E-05
0.0700754	0.0273706	-0.004276	1.64E-06	4.22E-06	1.81E-05
0.0537386	0.0194061	-0.004175	3.48E-06	5.47E-06	8.34E-06
0.0531969	0.0269077	-0.00357	6.83E-06	1.26E-05	8.62E-06
0.052676	0.0202777	-0.003442	2.83E-06	6.69E-06	8.76E-06
0.052839	0.0197154	-0.003391	1.33E-05	1.63E-05	1.17E-05
0.0522238	0.0219251	-0.00368	3.99E-06	5.35E-07	8.71E-06
0.0517124	0.0239318	-0.003094	6.45E-07	3.39E-06	8.14E-06
0.0512993	0.0252456	-0.004055	6.17E-06	1.31E-05	8.37E-06
0.0509505	0.0265078	-0.004215	1.24E-05	2.36E-05	1.14E-05

Source File

Name: beam0lb_neg30deg_fast_168.8Hz
 Signal: FFT - Vib 3D Velocity - Magnitude
 dB-Reference: 0 dB = 1 m/s
 Band No.: 1
 Frequency: 168.8 Hz

Interpolated: Yes
 Filtered: Yes

X	Y	Z	Mag X	Mag Y	Mag Z
0.0533167	0.0254045	-0.003977	1.43E-05	2.15E-05	9.39E-05
0.0702199	0.0260086	-0.004857	2.10E-05	2.72E-05	0.000225172
0.0702813	0.0245392	-0.004182	3.49E-05	1.90E-05	0.000230704
0.05339	0.0238539	-0.003484	2.05E-05	1.98E-05	9.35E-05
0.0703886	0.0229198	-0.003873	3.94E-05	8.50E-06	0.000235496
0.0536137	0.0214872	-0.004809	2.00E-05	1.07E-05	9.62E-05
0.0705848	0.0208288	-0.004553	3.18E-05	1.42E-05	0.000203809
0.0536746	0.0201032	-0.003948	1.86E-05	1.58E-05	9.24E-05
0.087143	0.0268674	-0.005188	2.52E-05	2.02E-05	0.000448941
0.087175	0.0256043	-0.004058	3.76E-05	1.89E-05	0.000454842
0.0873346	0.0237775	-0.004202	4.01E-05	1.14E-05	0.000444668
0.087526	0.0217269	-0.00479	5.94E-05	3.41E-05	0.000418974
0.104084	0.0279816	-0.004968	1.93E-05	2.07E-05	0.000719267
0.104201	0.0263038	-0.004745	2.69E-05	1.85E-05	0.000722108
0.104384	0.0244207	-0.004971	2.66E-05	1.88E-05	0.000723726
0.104556	0.0225918	-0.005111	2.55E-05	1.56E-05	0.000711972
0.121112	0.0289379	-0.005106	1.11E-05	2.03E-05	0.0010091
0.121275	0.0271784	-0.005061	1.25E-05	2.08E-05	0.0010113
0.121375	0.0255815	-0.004654	1.22E-05	1.65E-05	0.00101024
0.12163	0.0234909	-0.005328	9.81E-06	1.17E-05	0.00101199
0.138249	0.0297812	-0.005505	4.48E-06	2.43E-05	0.00127695
0.138447	0.0279387	-0.00564	3.34E-06	2.29E-05	0.00128763
0.138616	0.0261345	-0.005682	5.46E-06	1.91E-05	0.00128672
0.138788	0.0243722	-0.005631	4.03E-06	1.47E-05	0.00128312

0.155425	0.0307017	-0.005708	1.69E-05	2.49E-05	0.00146857
0.155593	0.0289808	-0.005569	1.96E-05	2.73E-05	0.00152261
0.155788	0.027135	-0.0057	2.02E-05	2.36E-05	0.00153453
0.15604	0.0251667	-0.006098	2.01E-05	2.25E-05	0.00153515
0.172769	0.030128	-0.005314	3.42E-05	2.97E-05	0.00169282
0.173112	0.0279144	-0.006254	3.51E-05	2.93E-05	0.00170141
0.173213	0.0263949	-0.005658	3.56E-05	2.83E-05	0.00169825
0.190087	0.031026	-0.005582	5.03E-05	3.61E-05	0.00176031
0.190354	0.0290989	-0.005887	5.11E-05	3.72E-05	0.00174752
0.190623	0.0271276	-0.00628	5.11E-05	3.41E-05	0.00173005
0.207415	0.0320703	-0.005573	5.78E-05	4.41E-05	0.00169135
0.207752	0.0299783	-0.006236	6.01E-05	4.25E-05	0.0016869
0.207911	0.0283328	-0.005907	6.09E-05	3.89E-05	0.00167048
0.224823	0.0330712	-0.005633	6.05E-05	4.24E-05	0.00151257
0.225232	0.0309001	-0.006469	6.47E-05	4.22E-05	0.00150083
0.225435	0.0291714	-0.006316	6.32E-05	4.12E-05	0.00149729
0.22566	0.027359	-0.006343	6.33E-05	4.40E-05	0.00149506
0.208228	0.0263208	-0.006382	6.16E-05	4.01E-05	0.00166352
0.242398	0.033884	-0.006124	6.08E-05	4.55E-05	0.0012449
0.242769	0.0318328	-0.006686	6.48E-05	4.77E-05	0.00122388
0.242842	0.0303842	-0.005906	6.34E-05	4.82E-05	0.00121252
0.243197	0.0283282	-0.006465	6.29E-05	4.87E-05	0.0012104
0.26002	0.0347638	-0.006514	5.30E-05	5.14E-05	0.000896116
0.260114	0.033272	-0.005823	5.80E-05	5.37E-05	0.000880872
0.260398	0.0314198	-0.005933	5.76E-05	5.64E-05	0.00087709
0.260849	0.0292444	-0.006753	6.09E-05	5.80E-05	0.000879025
0.277617	0.0358441	-0.006431	4.80E-05	5.68E-05	0.000526196
0.277876	0.0340279	-0.006453	4.97E-05	5.84E-05	0.000517038
0.278105	0.0322932	-0.006291	4.77E-05	5.93E-05	0.000516518
0.278245	0.0307182	-0.005772	5.52E-05	6.69E-05	0.000519464
0.295107	0.0371701	-0.005801	4.45E-05	7.04E-05	0.000213029
0.295392	0.035355	-0.005817	4.64E-05	6.48E-05	0.000128235
0.295957	0.0330613	-0.006894	4.52E-05	6.52E-05	0.000118951
0.296054	0.0315625	-0.006195	5.06E-05	6.83E-05	0.000116976
0.31329	0.0361377	-0.006406	3.56E-05	6.75E-05	0.00027466
0.31356	0.0343727	-0.006332	3.38E-05	6.87E-05	0.000285306
0.313487	0.033149	-0.005012	4.12E-05	7.06E-05	0.00029116
0.330878	0.0375253	-0.005647	2.92E-05	6.93E-05	0.000661857
0.331389	0.0354037	-0.006364	2.47E-05	7.14E-05	0.000675922
0.331577	0.0337372	-0.006017	2.63E-05	6.85E-05	0.000727108
0.348737	0.0385821	-0.005674	2.72E-05	6.91E-05	0.000956947
0.349188	0.0365629	-0.006114	1.99E-05	7.25E-05	0.00107285
0.349289	0.0350679	-0.005415	1.62E-05	6.89E-05	0.00110945
0.34974	0.0330462	-0.00585	1.79E-05	6.55E-05	0.00106811
0.331933	0.0318497	-0.0062	2.52E-05	6.52E-05	0.000751371
0.366769	0.03814	-0.004972	1.68E-05	7.02E-05	0.00130238
0.367461	0.0358052	-0.006105	1.33E-05	6.84E-05	0.00133395

0.367408	0.0344994	-0.004967	1.54E-05	6.51E-05	0.00127873
0.384788	0.0391654	-0.005033	1.19E-05	6.15E-05	0.00141056
0.38514	0.0373094	-0.005119	9.81E-06	5.96E-05	0.00141825
0.38571	0.0351817	-0.00581	9.94E-06	5.96E-05	0.00141079
0.402797	0.0402781	-0.0049	8.93E-06	5.51E-05	0.00143498
0.402812	0.0388875	-0.003932	5.44E-06	5.11E-05	0.00142782
0.403553	0.0365655	-0.005052	4.40E-06	5.01E-05	0.00143046
0.421196	0.0396366	-0.004649	3.18E-06	4.08E-05	0.00134672
0.421634	0.0376968	-0.004896	3.43E-06	3.80E-05	0.00133691
0.422023	0.035836	-0.004962	2.72E-06	3.84E-05	0.00133535
0.403976	0.0346266	-0.005302	3.01E-06	4.91E-05	0.00143133
0.439381	0.0407036	-0.004652	3.28E-06	2.75E-05	0.00111879
0.439522	0.0391486	-0.004024	3.96E-06	2.16E-05	0.00110903
0.440052	0.0371461	-0.004437	6.95E-06	2.10E-05	0.00110395
0.457273	0.0422047	-0.00368	3.72E-06	9.61E-06	0.000782579
0.457618	0.040431	-0.003572	6.75E-06	1.01E-05	0.000771962
0.457862	0.038757	-0.003197	1.50E-05	1.06E-05	0.000762029
0.4754	0.0434821	-0.003211	5.74E-06	2.31E-05	0.000432219
0.475997	0.0414391	-0.003698	8.69E-06	3.00E-05	0.000338499
0.475898	0.040156	-0.002468	1.83E-05	2.96E-05	0.000322753
0.494054	0.0428907	-0.002864	1.62E-05	5.18E-05	0.000175012
0.494473	0.04103	-0.002918	1.84E-05	5.55E-05	0.000193582
0.495051	0.0390051	-0.003299	1.24E-05	5.55E-05	0.000193385
0.476912	0.0376378	-0.003971	1.32E-05	3.40E-05	0.000289984
0.511841	0.0446297	-0.001332	3.00E-05	7.97E-05	0.000732045
0.512691	0.0423711	-0.002317	3.15E-05	8.19E-05	0.000751505
0.513209	0.0404342	-0.002528	2.58E-05	8.02E-05	0.000751224
0.530638	0.0454296	-0.002005	2.33E-05	9.77E-05	0.00122789
0.530866	0.0437902	-0.001533	3.46E-05	0.00010169	0.00133623
0.531398	0.0418508	-0.001737	3.54E-05	0.000103097	0.00133402
0.54901	0.0453045	-0.00057	4.34E-05	0.00011751	0.00185148
0.549672	0.0432508	-0.001019	3.98E-05	0.000118253	0.00186162
0.551405	0.0417363	-0.000494	4.46E-05	0.000127885	0.00200985
0.551652	0.0411817	-0.000846	4.51E-05	0.000127924	0.00202333
0.55042	0.0408342	-0.001501	4.06E-05	0.00011922	0.00188671
0.5502	0.0413181	-0.001224	3.95E-05	0.000120638	0.00189203
0.551135	0.0434039	-0.000883	4.40E-05	0.000126071	0.00199775
0.55059	0.0453314	-0.000681	4.28E-05	0.000123226	0.00198552
0.548519	0.0470298	-0.000371	3.87E-05	0.000115565	0.00182238
0.550296	0.0468421	-0.000889	3.96E-05	0.000123076	0.00197335
0.536792	0.0405892	-0.001111	3.98E-05	0.00011294	0.00164498
0.531577	0.0403667	-0.001233	3.69E-05	9.94E-05	0.00123925
0.541746	0.046761	-0.000522	2.31E-05	0.00010357	0.00144686
0.530576	0.045748	-0.002055	2.07E-05	9.51E-05	0.00119958
0.513462	0.039239	-0.002475	2.44E-05	7.82E-05	0.000750669
0.511757	0.0454073	-0.001594	2.89E-05	7.38E-05	0.000718398
0.494886	0.0386306	-0.002498	9.25E-06	5.46E-05	0.000192654

0.493526	0.0445186	-0.002399	1.71E-05	4.56E-05	0.000164555
0.476927	0.0374473	-0.00388	8.79E-06	3.58E-05	0.000281032
0.480228	0.0439778	-0.002751	8.97E-06	2.89E-05	0.000258193
0.475355	0.0436518	-0.003188	7.70E-06	2.07E-05	0.000448902
0.467449	0.037303	-0.00354	1.17E-05	2.52E-05	0.000518521
0.458391	0.0369414	-0.003692	1.25E-05	1.07E-05	0.000806172
0.457006	0.0430438	-0.003343	5.66E-06	9.90E-06	0.000784521
0.440404	0.0358787	-0.004781	4.63E-06	2.27E-05	0.00110376
0.438728	0.0424148	-0.003574	4.04E-06	2.92E-05	0.00111456
0.421969	0.0354445	-0.00446	2.27E-06	4.00E-05	0.00133154
0.420559	0.0417591	-0.003863	2.49E-06	4.24E-05	0.00134118
0.403773	0.0347837	-0.004638	3.18E-06	5.06E-05	0.00143247
0.419034	0.0416055	-0.004114	6.50E-06	5.28E-05	0.00142779
0.402521	0.0410067	-0.004401	1.04E-05	5.67E-05	0.0014328
0.398523	0.0345196	-0.004842	4.30E-06	5.54E-05	0.0014423
0.385733	0.0340306	-0.005058	8.86E-06	6.30E-05	0.00140654
0.384517	0.0402881	-0.004821	1.52E-05	6.25E-05	0.00139042
0.367529	0.0335867	-0.004747	1.61E-05	6.73E-05	0.00127513
0.366318	0.039944	-0.004436	2.04E-05	6.99E-05	0.00126532
0.349839	0.0324945	-0.005913	1.99E-05	6.53E-05	0.00102239
0.358697	0.0390252	-0.005979	2.66E-05	6.92E-05	0.00106292
0.34861	0.0389826	-0.005436	2.79E-05	6.74E-05	0.000938435
0.331962	0.0317671	-0.006267	2.67E-05	6.58E-05	0.000762869
0.330773	0.0383051	-0.005799	3.02E-05	6.62E-05	0.00065425
0.330537	0.0317064	-0.006315	3.08E-05	6.89E-05	0.00061059
0.314073	0.0311836	-0.006341	4.04E-05	6.97E-05	0.00028609
0.312973	0.0376775	-0.006051	3.31E-05	6.21E-05	0.000290226
0.296187	0.0306736	-0.006211	4.51E-05	6.51E-05	7.78E-05
0.296138	0.036934	-0.006438	3.48E-05	7.16E-05	0.000102331
0.300388	0.0371867	-0.006324	3.26E-05	6.17E-05	2.79E-05
0.287625	0.0301979	-0.006649	4.75E-05	6.24E-05	0.000320236
0.278399	0.0299921	-0.006081	5.80E-05	6.54E-05	0.000562358
0.277559	0.0361084	-0.006339	4.79E-05	5.18E-05	0.000627615
0.26063	0.0293162	-0.005602	6.46E-05	5.78E-05	0.000881074
0.259987	0.0351749	-0.006594	5.05E-05	4.80E-05	0.000901917
0.243195	0.0281137	-0.006256	6.35E-05	4.86E-05	0.00121221
0.242253	0.0346929	-0.005848	5.81E-05	4.44E-05	0.00125085
0.225689	0.0271771	-0.006366	6.26E-05	4.69E-05	0.00149032
0.224878	0.033621	-0.006427	5.91E-05	4.29E-05	0.00151421
0.208301	0.0261156	-0.006721	6.10E-05	4.23E-05	0.00165443
0.207402	0.0328801	-0.006274	5.62E-05	4.06E-05	0.00169229
0.20286	0.0260845	-0.006197	5.85E-05	3.63E-05	0.00169996
0.190867	0.0253227	-0.006529	5.00E-05	3.15E-05	0.00172378
0.190008	0.032181	-0.006005	4.97E-05	3.19E-05	0.00175866
0.173422	0.0247309	-0.005866	3.58E-05	2.78E-05	0.00170176
0.172574	0.0317482	-0.00519	3.54E-05	2.40E-05	0.00167683
0.156187	0.0237525	-0.006097	1.71E-05	1.96E-05	0.00153123

0.155616	0.0305967	-0.005963	2.44E-05	2.24E-05	0.0015352
0.155383	0.0308239	-0.005437	1.67E-05	2.49E-05	0.00145241
0.13892	0.0230574	-0.005677	1.49E-06	1.15E-05	0.00128015
0.138173	0.0301677	-0.005138	3.45E-06	2.39E-05	0.00127147
0.12178	0.0221788	-0.005705	1.29E-05	1.16E-05	0.00100945
0.121135	0.0291383	-0.005636	1.09E-05	2.05E-05	0.00100622
0.104646	0.0215435	-0.005173	5.31E-05	3.89E-05	0.000708872
0.103997	0.0287326	-0.004767	2.13E-05	1.76E-05	0.000716816
0.0875995	0.0208753	-0.004723	8.69E-05	6.85E-05	0.000387912
0.087066	0.0278018	-0.005068	2.10E-05	2.14E-05	0.000446969
0.0705839	0.0203378	-0.003996	5.38E-05	4.33E-05	0.000178047
0.0700754	0.0273706	-0.004276	1.55E-05	2.61E-05	0.000227015
0.0537386	0.0194061	-0.004175	8.08E-05	9.56E-05	5.75E-05
0.0531969	0.0269077	-0.00357	1.22E-05	1.74E-05	9.65E-05
0.052676	0.0202777	-0.003442	8.25E-05	8.57E-05	4.44E-05
0.052839	0.0197154	-0.003391	0.000186171	0.000198056	7.01E-05
0.0522238	0.0219251	-0.00368	1.54E-05	1.15E-05	6.02E-05
0.0517124	0.0239318	-0.003094	1.36E-05	1.69E-05	5.59E-05
0.0512993	0.0252456	-0.004055	1.22E-05	9.43E-06	5.51E-05
0.0509505	0.0265078	-0.004215	9.35E-06	8.73E-06	5.71E-05

Source File beam0lb_neg45deg_fast_60.63Hz
Name:
Signal: FFT - Vib 3D Velocity - Magnitude
dB-Reference: 0 dB = 1 m/s
Band No.: 1
Frequency: 60.63 Hz

Interpolated: Yes
Filtered: Yes

X	Y	Z	Mag X	Mag Y	Mag Z
0.0692212	0.0193962	-0.002302	4.61E-06	2.94E-06	1.31E-05
0.0693261	0.0181367	-0.002257	4.35E-06	6.07E-07	1.47E-05
0.0694843	0.0166934	-0.002563	6.08E-06	2.70E-06	1.83E-05
0.0695538	0.0156025	-0.002155	1.17E-05	6.85E-06	2.10E-05
0.0696241	0.0144963	-0.001738	1.40E-05	2.25E-05	2.09E-05
0.0812174	0.0203633	-0.001528	5.02E-06	3.98E-06	1.99E-05
0.0814032	0.0187667	-0.002204	4.95E-06	5.22E-06	1.99E-05
0.0815515	0.0173221	-0.00251	4.69E-06	3.60E-06	2.22E-05
0.0816518	0.0160882	-0.002364	6.12E-06	5.49E-06	2.18E-05
0.081768	0.0148714	-0.002224	6.14E-06	4.39E-06	1.97E-05
0.0934909	0.019467	-0.00197	5.01E-06	6.35E-06	2.54E-05
0.0935522	0.0184178	-0.001472	4.33E-06	6.42E-06	2.66E-05
0.0936661	0.0171421	-0.001416	3.02E-06	1.06E-05	2.60E-05
0.0939043	0.0153584	-0.002439	3.40E-06	8.62E-06	2.27E-05
0.0938004	0.0149713	-0.000491	4.68E-06	2.87E-06	2.62E-05
0.105523	0.0204353	-0.001211	4.23E-06	7.74E-06	3.14E-05
0.105714	0.0189508	-0.001604	3.70E-06	5.80E-06	3.03E-05

0.105943	0.0172529	-0.002448	3.00E-06	3.03E-06	3.17E-05
0.105994	0.0162294	-0.00185	3.62E-06	2.57E-06	3.67E-05
0.106078	0.0150951	-0.001529	4.92E-06	2.62E-06	4.72E-05
0.117761	0.020803	-0.00171	3.86E-06	7.73E-06	4.75E-05
0.117895	0.0194847	-0.001744	3.72E-06	5.53E-06	4.63E-05
0.11804	0.018124	-0.001866	3.83E-06	1.37E-06	4.84E-05
0.118066	0.0172002	-0.001096	4.41E-06	2.42E-06	5.52E-05
0.118295	0.0155432	-0.001845	5.05E-06	4.30E-06	6.28E-05
0.118263	0.0148157	-0.000617	4.40E-06	6.19E-06	6.60E-05
0.130088	0.0201055	-0.001709	3.49E-06	6.31E-06	6.21E-05
0.130126	0.0191229	-0.001022	3.79E-06	2.67E-06	6.80E-05
0.130365	0.0174828	-0.001778	4.41E-06	3.30E-06	7.48E-05
0.130453	0.0163318	-0.001448	4.00E-06	6.25E-06	7.92E-05
0.130528	0.015223	-0.001028	5.20E-06	8.19E-06	8.20E-05
0.142155	0.0211883	-0.000692	3.54E-06	1.03E-05	8.00E-05
0.142325	0.0197858	-0.000903	3.72E-06	8.03E-06	8.09E-05
0.142415	0.0186348	-0.000574	4.41E-06	5.91E-06	8.41E-05
0.142655	0.0170804	-0.001146	4.20E-06	7.72E-06	8.45E-05
0.142678	0.0161398	-0.000367	3.21E-06	3.36E-06	8.72E-05
0.142834	0.0147777	-0.000483	3.49E-06	4.42E-06	9.19E-05
0.154532	0.0205356	-0.000609	4.48E-06	1.10E-05	9.90E-05
0.154695	0.0191743	-0.000727	4.10E-06	1.03E-05	0.000101949
0.154959	0.0175622	-0.001381	3.42E-06	1.02E-05	0.00010099
0.154994	0.0165782	-0.00069	2.89E-06	7.08E-06	0.000102335
0.155268	0.0148939	-0.001529	3.59E-06	4.85E-06	0.000108407
0.166672	0.0215657	0.0003157	4.88E-06	2.51E-06	0.000124451
0.167002	0.0197596	-0.000795	4.23E-06	1.47E-06	0.000121119
0.167096	0.0186071	-0.000463	3.08E-06	4.89E-06	0.000115097
0.167189	0.0174547	-0.000131	3.37E-06	4.52E-06	0.000117447
0.167312	0.0162182	2.38E-05	4.26E-06	6.14E-06	0.000118936
0.167301	0.0153608	0.0009843	4.42E-06	6.34E-06	0.000120902
0.179021	0.0220256	-2.90E-05	3.69E-06	2.02E-06	0.000133299
0.179133	0.0208749	0.0003041	3.21E-06	1.26E-06	0.000129281
0.179275	0.0195967	0.0003678	2.93E-06	2.04E-06	0.000127747
0.179543	0.0179828	-0.000283	3.14E-06	4.80E-06	0.000136545
0.1797	0.0166615	-0.000306	3.92E-06	4.14E-06	0.000136048
0.179686	0.0158025	0.0006547	3.78E-06	4.35E-06	0.000133488
0.191353	0.0217381	0.0008581	2.68E-06	1.37E-06	0.000137245
0.191582	0.0202946	0.0005674	2.39E-06	2.06E-06	0.000142055
0.191745	0.0189738	0.0005438	2.83E-06	3.64E-06	0.000153496
0.191956	0.0175268	0.0002536	3.01E-06	1.83E-06	0.000151166
0.1922	0.0160108	-0.000221	2.58E-06	9.91E-07	0.000145662
0.203711	0.0223989	0.0009648	2.63E-06	7.90E-06	0.000158539
0.203776	0.0213284	0.0014768	2.65E-06	6.47E-06	0.000160959
0.204063	0.0197152	0.0008297	2.63E-06	5.16E-06	0.000164904
0.204162	0.0185609	0.0011653	2.41E-06	1.71E-06	0.000159972
0.204397	0.0170873	0.0007808	2.12E-06	1.89E-06	0.000154175
0.204632	0.015597	0.0004054	2.17E-06	2.73E-06	0.000157188
0.216163	0.0219033	0.0013978	2.17E-06	6.08E-06	0.000177829
0.216532	0.0201234	0.0003962	1.69E-06	3.26E-06	0.000172402
0.216579	0.019093	0.0010002	1.30E-06	6.55E-07	0.000166948
0.216697	0.0178958	0.0012486	1.85E-06	2.84E-06	0.000171486

0.216869	0.016573	0.0012309	1.97E-06	3.08E-06	0.000178265
0.228618	0.0224421	0.0012293	1.13E-06	2.49E-06	0.000194063
0.228608	0.0215357	0.0020998	9.07E-07	5.77E-07	0.000187321
0.228953	0.0198388	0.0012801	7.96E-07	9.43E-07	0.000187289
0.22913	0.0185157	0.0012626	1.39E-06	2.65E-06	0.000190203
0.22923	0.0174033	0.0016934	1.83E-06	3.57E-06	0.000193931
0.229481	0.0159124	0.0013225	1.73E-06	9.81E-07	0.000191021
0.24074	0.0237562	0.0027563	8.19E-07	1.91E-06	0.000195161
0.240864	0.0225588	0.0030042	9.17E-07	2.01E-06	0.000192615
0.241181	0.0209457	0.0023644	1.05E-06	2.09E-06	0.000198898
0.241301	0.0198072	0.0026984	1.54E-06	5.59E-06	0.000198513
0.24156	0.0183173	0.0023279	1.25E-06	3.85E-06	0.000195762
0.241799	0.0168681	0.0020475	9.30E-07	1.74E-06	0.000193041
0.253337	0.0231855	0.0030092	3.37E-07	3.11E-06	0.000205075
0.253504	0.021904	0.0030818	6.66E-07	3.05E-06	0.000204261
0.25375	0.0204561	0.0028006	7.74E-07	3.34E-06	0.000196314
0.254074	0.018885	0.0022574	6.70E-07	3.54E-06	0.000193873
0.254079	0.0179352	0.0030427	6.08E-07	2.04E-06	0.000196984
0.254325	0.0164854	0.0027653	4.37E-07	2.35E-06	0.000196412
0.265638	0.0242135	0.0039071	6.40E-07	2.40E-06	0.000211696
0.266017	0.0225181	0.0030947	5.66E-07	1.02E-06	0.00020579
0.26625	0.021111	0.002904	2.42E-07	1.09E-06	0.000196953
0.266357	0.0199523	0.003246	2.78E-07	1.56E-06	0.000204345
0.266631	0.0184612	0.0028807	5.21E-07	1.08E-06	0.000216676
0.266963	0.0169041	0.002335	2.07E-07	2.23E-06	0.000211214
0.278399	0.0234229	0.0037235	1.01E-06	1.34E-06	0.000209002
0.278616	0.022057	0.0036231	9.22E-07	1.48E-06	0.000205006
0.278893	0.0206102	0.00335	4.63E-07	9.36E-07	0.000216061
0.279196	0.019093	0.0028908	2.26E-07	6.71E-07	0.000227723
0.279218	0.0180988	0.0035894	1.89E-07	2.21E-06	0.000214142
0.279327	0.0169388	0.0039353	2.94E-07	2.60E-06	0.000209997
0.29074	0.0244545	0.0046155	1.62E-06	6.00E-06	0.000220039
0.290896	0.0232121	0.0047815	1.49E-06	5.87E-06	0.000220336
0.291052	0.0219695	0.0049486	1.11E-06	3.15E-06	0.000219969
0.291491	0.0202488	0.0040531	9.02E-07	1.81E-06	0.000213836
0.291669	0.0189637	0.0041343	1.02E-06	1.45E-06	0.000194601
0.291712	0.0179272	0.0047458	1.28E-06	2.03E-06	0.000196408
0.303335	0.0241226	0.0054079	2.03E-06	6.28E-06	0.00021248
0.303655	0.0225909	0.0049592	1.87E-06	3.98E-06	0.000203325
0.303905	0.0211978	0.0047687	1.67E-06	1.42E-06	0.000193328
0.304064	0.0199535	0.0049395	1.58E-06	1.47E-06	0.000186431
0.304222	0.018709	0.0051113	1.63E-06	2.31E-06	0.000196016
0.30445	0.0173399	0.00502	2.15E-06	2.12E-06	0.000197781
0.316044	0.0236259	0.0058478	2.64E-06	3.27E-06	0.000198222
0.316325	0.0221756	0.0055789	2.45E-06	1.24E-06	0.000192882
0.31663	0.0206833	0.0052233	2.00E-06	2.10E-06	0.000196603
0.316766	0.0194949	0.0054768	2.00E-06	2.45E-06	0.000202273
0.316904	0.0182906	0.0057389	2.59E-06	2.14E-06	0.00019398
0.317065	0.0170448	0.0059141	2.85E-06	1.60E-06	0.000191302
0.328805	0.023088	0.0062014	3.16E-06	1.22E-06	0.000191318
0.329043	0.0217188	0.0061115	2.88E-06	1.55E-06	0.00019404
0.329085	0.0206784	0.0067248	2.63E-06	1.71E-06	0.000192201

0.329347	0.0192833	0.0065416	3.35E-06	1.76E-06	0.000176195
0.329659	0.017789	0.0061921	3.33E-06	1.40E-06	0.000173198
0.341074	0.0243544	0.0076171	3.33E-06	1.35E-06	0.000181114
0.34141	0.0228809	0.0072618	3.23E-06	1.81E-06	0.000181553
0.341628	0.021552	0.0072624	3.47E-06	1.81E-06	0.000181375
0.341897	0.0201405	0.0070891	4.58E-06	1.71E-06	0.000170778
0.342064	0.0189089	0.0072594	4.12E-06	2.01E-06	0.000171531
0.34251	0.0172075	0.006476	3.90E-06	3.04E-06	0.000176461
0.354029	0.0236157	0.0075368	3.46E-06	2.27E-06	0.000170827
0.354201	0.0223678	0.0077142	3.89E-06	2.57E-06	0.000169239
0.354344	0.0211766	0.0079724	5.20E-06	2.04E-06	0.000165748
0.354932	0.0192711	0.0067539	4.62E-06	1.75E-06	0.000170625
0.355068	0.0181068	0.0071133	4.25E-06	2.28E-06	0.000175496
0.355185	0.0169557	0.007462	4.49E-06	3.64E-06	0.00016767
0.366838	0.0231638	0.0080727	4.25E-06	2.19E-06	0.000147894
0.366985	0.0219553	0.0083401	5.25E-06	2.55E-06	0.000143959
0.367426	0.0203122	0.0076414	5.08E-06	1.72E-06	0.000149577
0.367626	0.0190209	0.0077367	5.06E-06	1.38E-06	0.000156222
0.367746	0.0178526	0.0080945	5.10E-06	2.26E-06	0.000151373
0.36807	0.0164152	0.0078394	4.95E-06	3.40E-06	0.000144966
0.379363	0.0241502	0.0088734	5.20E-06	1.68E-06	0.000116619
0.37965	0.0227368	0.0087069	5.41E-06	2.01E-06	0.000117623
0.379964	0.0212979	0.0084468	5.47E-06	1.20E-06	0.000121818
0.380251	0.019883	0.0082828	5.94E-06	2.01E-06	0.000123055
0.380482	0.0185654	0.0082861	6.09E-06	1.24E-06	0.000123558
0.380769	0.0171494	0.0081246	6.05E-06	2.20E-06	0.000114337
0.391985	0.0240222	0.0101038	6.25E-06	1.12E-06	0.000102995
0.392533	0.0222415	0.0091589	6.72E-06	3.21E-06	0.000101066
0.39239	0.0214977	0.0103826	7.33E-06	3.96E-06	9.83E-05
0.392795	0.0199193	0.0098746	7.59E-06	3.07E-06	9.99E-05
0.3932	0.0183556	0.0093602	7.26E-06	3.03E-06	0.000100073
0.393577	0.0168157	0.0089419	6.90E-06	2.43E-06	9.25E-05
0.405024	0.0233528	0.0102201	7.90E-06	2.89E-06	8.55E-05
0.405062	0.022319	0.0108327	8.42E-06	3.40E-06	7.97E-05
0.40536	0.0209032	0.0106743	8.14E-06	1.07E-06	7.93E-05
0.405832	0.0192579	0.0099898	8.01E-06	1.72E-06	7.95E-05
0.406101	0.0178811	0.0099207	7.64E-06	2.57E-06	7.48E-05
0.406126	0.0168912	0.0106277	7.94E-06	2.34E-06	6.99E-05
0.417517	0.0244625	0.0112744	9.50E-06	2.26E-06	6.01E-05
0.417672	0.023265	0.0115418	9.31E-06	1.67E-06	5.90E-05
0.417888	0.0219703	0.0116452	9.42E-06	3.22E-07	5.71E-05
0.418119	0.0206944	0.011746	9.18E-06	3.41E-06	5.44E-05
0.418452	0.0192522	0.0114982	9.62E-06	4.41E-06	4.88E-05
0.418786	0.0177931	0.0112596	1.06E-05	2.81E-06	4.13E-05
0.430095	0.0244965	0.0128538	1.03E-05	1.87E-06	3.63E-05
0.430587	0.0228528	0.0121749	1.06E-05	9.19E-07	2.99E-05
0.430823	0.0215597	0.0122859	1.06E-05	3.05E-06	2.66E-05
0.431163	0.0201168	0.0120408	1.08E-05	2.68E-06	2.60E-05
0.431228	0.0190392	0.0125724	1.17E-05	3.26E-06	2.29E-05
0.431538	0.0176199	0.0124237	1.19E-05	1.02E-06	1.87E-05
0.443222	0.0238437	0.012971	1.17E-05	1.43E-06	6.18E-06
0.443445	0.0225463	0.0130795	1.20E-05	2.48E-06	8.20E-07

0.443854	0.0210219	0.0126653	1.23E-05	3.67E-06	1.61E-06
0.444013	0.0198207	0.0129401	1.22E-05	2.83E-06	1.60E-06
0.444142	0.0186441	0.0133097	1.19E-05	1.56E-06	1.76E-06
0.444567	0.0171208	0.0129038	1.15E-05	4.55E-06	8.85E-06
0.455804	0.0248983	0.0139417	1.29E-05	2.26E-06	3.05E-05
0.456125	0.0234952	0.0137868	1.33E-05	2.48E-06	3.20E-05
0.456256	0.0223335	0.0141479	1.36E-05	2.45E-06	3.29E-05
0.456753	0.0207307	0.0135712	1.32E-05	4.28E-06	3.27E-05
0.457201	0.0191637	0.0130771	1.20E-05	5.75E-06	3.78E-05
0.457522	0.0177416	0.0129354	1.18E-05	5.19E-06	5.02E-05
0.469095	0.0241261	0.0138094	1.34E-05	1.11E-06	5.74E-05
0.468836	0.0234448	0.0151993	1.40E-05	1.66E-06	6.39E-05
0.469456	0.0216776	0.0142794	1.39E-05	5.56E-06	6.43E-05
0.469783	0.0202717	0.0141309	1.36E-05	3.28E-06	6.69E-05
0.470044	0.0189459	0.0141547	1.32E-05	4.02E-06	7.04E-05
0.470616	0.0172427	0.0134234	1.21E-05	9.11E-06	7.78E-05
0.48179	0.0241142	0.0153058	1.52E-05	4.98E-06	9.04E-05
0.482056	0.0227884	0.0153296	1.58E-05	2.48E-06	9.74E-05
0.482256	0.0215427	0.0155251	1.57E-05	3.44E-06	9.54E-05
0.482787	0.0198941	0.0148688	1.51E-05	6.05E-06	9.54E-05
0.483169	0.0184492	0.0146452	3.13E-06	4.07E-05	9.61E-05
0.483568	0.0169596	0.0143329	6.58E-06	3.28E-05	0.00010024
0.494531	0.0250651	0.0160076	1.96E-05	1.64E-05	0.000142073
0.494784	0.0237817	0.0161239	2.00E-05	1.41E-05	0.000139261
0.495055	0.0224544	0.0161512	1.93E-05	1.43E-05	0.000131062
0.495189	0.0212872	0.0165199	7.00E-06	4.22E-05	0.000119175
0.495561	0.0198388	0.0162942	9.04E-06	8.76E-05	0.000120667
0.495966	0.0183492	0.0159848	7.07E-06	7.63E-05	0.000119449
0.496202	0.0170604	0.0161016	6.72E-06	4.09E-05	0.000131913
0.507476	0.0248113	0.0169942	1.94E-05	8.83E-06	0.000170186
0.507647	0.0236026	0.0172786	1.88E-05	7.51E-06	0.000163891
0.508233	0.021914	0.0165457	1.82E-05	1.57E-05	0.000156463
0.508524	0.0205879	0.016583	6.51E-06	4.70E-05	0.000151339
0.508729	0.0193381	0.0167858	1.24E-05	2.66E-05	0.000160181
0.509037	0.0179676	0.0167354	1.78E-05	1.63E-05	0.000184402
0.520548	0.024435	0.0177283	1.93E-05	7.17E-06	0.000200887
0.520756	0.0231846	0.017931	2.00E-05	5.87E-06	0.000206194
0.520858	0.0220538	0.0183885	2.08E-05	1.28E-05	0.00020246
0.521295	0.0205669	0.0180909	2.01E-05	1.37E-05	0.000207843
0.52182	0.0189553	0.0175358	2.21E-05	8.37E-06	0.000216994
0.521639	0.0181447	0.0186724	2.25E-05	7.93E-06	0.000228443
0.533468	0.0242548	0.0188878	2.04E-05	1.09E-05	0.000226666
0.533462	0.0232415	0.0195998	2.08E-05	2.90E-05	0.000223925
0.533961	0.0216708	0.0191316	2.08E-05	2.42E-05	0.0002254
0.534476	0.0201191	0.0186621	2.10E-05	1.43E-05	0.000231011
0.534722	0.0188259	0.0187868	2.25E-05	7.26E-06	0.000247987
0.534823	0.0176926	0.0192496	2.39E-05	6.14E-06	0.000258185
0.546048	0.0254832	0.0201773	2.20E-05	1.44E-05	0.000253579
0.546409	0.0240713	0.0200484	2.16E-05	2.78E-05	0.00024167
0.546622	0.0228175	0.0202573	2.11E-05	2.20E-05	0.000235752
0.546888	0.0215439	0.0203804	2.19E-05	8.79E-06	0.000240346
0.547174	0.0202101	0.0204232	2.40E-05	6.86E-06	0.00027118

0.547387 0.0189557 0.0206351 2.61E-05 5.78E-06 0.000287774

Source File beam0lb_neg45deg_fast_167.5Hz
Name:
Signal: FFT - Vib 3D Velocity - Magnitude
dB-Reference: 0 dB = 1 m/s
Band No.: 1
Frequency: 167.5 Hz

Interpolated: Yes
Filtered: Yes

X	Y	Z	Mag X	Mag Y	Mag Z
0.0692212	0.0193962	-0.002302	1.75E-05	3.03E-05	9.31E-05
0.0693261	0.0181367	-0.002257	1.76E-05	2.44E-05	9.14E-05
0.0694843	0.0166934	-0.002563	1.93E-05	2.08E-05	9.15E-05
0.0695538	0.0156025	-0.002155	1.84E-05	2.29E-05	8.97E-05
0.0696241	0.0144963	-0.001738	1.52E-05	2.90E-05	0.000106849
0.0812174	0.0203633	-0.001528	2.08E-05	2.92E-05	0.000139998
0.0814032	0.0187667	-0.002204	2.10E-05	2.38E-05	0.000140825
0.0815515	0.0173221	-0.00251	2.22E-05	2.44E-05	0.000140718
0.0816518	0.0160882	-0.002364	2.18E-05	2.14E-05	0.000151613
0.081768	0.0148714	-0.002224	2.03E-05	2.72E-05	0.000171177
0.0934909	0.019467	-0.00197	2.12E-05	2.65E-05	0.00019694
0.0935522	0.0184178	-0.001472	2.07E-05	2.58E-05	0.000211874
0.0936661	0.0171421	-0.001416	2.05E-05	2.54E-05	0.000210328
0.0939043	0.0153584	-0.002439	2.13E-05	2.57E-05	0.000219202
0.0938004	0.0149713	-0.000491	2.26E-05	2.66E-05	0.000221108
0.105523	0.0204353	-0.001211	1.81E-05	2.45E-05	0.000282825
0.105714	0.0189508	-0.001604	1.84E-05	2.75E-05	0.000286014
0.105943	0.0172529	-0.002448	1.85E-05	2.80E-05	0.000286895
0.105994	0.0162294	-0.00185	1.95E-05	2.90E-05	0.000284486
0.106078	0.0150951	-0.001529	2.12E-05	2.88E-05	0.000300697
0.117761	0.020803	-0.00171	1.59E-05	2.79E-05	0.00036407
0.117895	0.0194847	-0.001744	1.53E-05	2.96E-05	0.000365657
0.11804	0.018124	-0.001866	1.57E-05	3.31E-05	0.000361615
0.118066	0.0172002	-0.001096	1.78E-05	3.44E-05	0.000358252
0.118295	0.0155432	-0.001845	1.95E-05	3.27E-05	0.000365454
0.118263	0.0148157	-0.000617	2.02E-05	2.91E-05	0.00037089
0.130088	0.0201055	-0.001709	1.43E-05	3.31E-05	0.000429558
0.130126	0.0191229	-0.001022	1.50E-05	3.66E-05	0.0004417
0.130365	0.0174828	-0.001778	1.67E-05	3.48E-05	0.000440972
0.130453	0.0163318	-0.001448	1.75E-05	3.36E-05	0.000444975
0.130528	0.015223	-0.001028	1.71E-05	2.95E-05	0.000460836
0.142155	0.0211883	-0.000692	1.21E-05	3.65E-05	0.000506965
0.142325	0.0197858	-0.000903	1.25E-05	3.52E-05	0.000509987
0.142415	0.0186348	-0.000574	1.30E-05	3.53E-05	0.00050846
0.142655	0.0170804	-0.001146	1.26E-05	3.50E-05	0.000506224
0.142678	0.0161398	-0.000367	1.17E-05	3.12E-05	0.000506907
0.142834	0.0147777	-0.000483	1.26E-05	3.02E-05	0.000511891
0.154532	0.0205356	-0.000609	8.85E-06	3.59E-05	0.000555848

0.154695	0.0191743	-0.000727	8.05E-06	3.59E-05	0.000567825
0.154959	0.0175622	-0.001381	6.63E-06	3.62E-05	0.000565822
0.154994	0.0165782	-0.00069	6.37E-06	3.43E-05	0.000564757
0.155268	0.0148939	-0.001529	7.19E-06	3.21E-05	0.000574687
0.166672	0.0215657	0.0003157	5.01E-06	3.61E-05	0.000613517
0.167002	0.0197596	-0.000795	4.63E-06	3.32E-05	0.000612297
0.167096	0.0186071	-0.000463	3.63E-06	3.30E-05	0.000615814
0.167189	0.0174547	-0.000131	2.65E-06	3.22E-05	0.00061355
0.167312	0.0162182	2.38E-05	4.22E-06	3.18E-05	0.000612016
0.167301	0.0153608	0.0009843	5.63E-06	3.09E-05	0.000611179
0.179021	0.0220256	-2.90E-05	2.98E-06	3.56E-05	0.000641523
0.179133	0.0208749	0.0003041	2.98E-06	3.26E-05	0.000641592
0.179275	0.0195967	0.0003678	2.88E-06	3.17E-05	0.000645649
0.179543	0.0179828	-0.000283	2.52E-06	3.23E-05	0.000646031
0.1797	0.0166615	-0.000306	2.38E-06	3.10E-05	0.0006444
0.179686	0.0158025	0.0006547	2.82E-06	3.00E-05	0.000639851
0.191353	0.0217381	0.0008581	4.39E-06	3.28E-05	0.000649986
0.191582	0.0202946	0.0005674	5.15E-06	3.20E-05	0.000655148
0.191745	0.0189738	0.0005438	5.86E-06	3.11E-05	0.000653068
0.191956	0.0175268	0.0002536	6.46E-06	2.99E-05	0.000650467
0.1922	0.0160108	-0.000221	7.33E-06	2.94E-05	0.00064299
0.203711	0.0223989	0.0009648	7.89E-06	3.03E-05	0.00064186
0.203776	0.0213284	0.0014768	8.28E-06	3.00E-05	0.000642575
0.204063	0.0197152	0.0008297	9.88E-06	2.91E-05	0.000642128
0.204162	0.0185609	0.0011653	1.08E-05	2.82E-05	0.000641509
0.204397	0.0170873	0.0007808	1.16E-05	2.98E-05	0.00063475
0.204632	0.015597	0.0004054	1.15E-05	3.03E-05	0.000621032
0.216163	0.0219033	0.0013978	1.12E-05	3.06E-05	0.000616718
0.216532	0.0201234	0.0003962	1.30E-05	2.93E-05	0.000610218
0.216579	0.019093	0.0010002	1.51E-05	2.89E-05	0.000609609
0.216697	0.0178958	0.0012486	1.50E-05	2.99E-05	0.000597663
0.216869	0.016573	0.0012309	1.61E-05	2.92E-05	0.000578896
0.228618	0.0224421	0.0012293	1.66E-05	3.64E-05	0.000560632
0.228608	0.0215357	0.0020998	1.84E-05	3.46E-05	0.000560936
0.228953	0.0198388	0.0012801	1.88E-05	3.28E-05	0.000558687
0.22913	0.0185157	0.0012626	1.83E-05	3.10E-05	0.000555494
0.22923	0.0174033	0.0016934	1.81E-05	2.82E-05	0.000546202
0.229481	0.0159124	0.0013225	1.92E-05	2.81E-05	0.000544455
0.24074	0.0237562	0.0027563	2.23E-05	3.61E-05	0.000493136
0.240864	0.0225588	0.0030042	2.26E-05	3.54E-05	0.000493362
0.241181	0.0209457	0.0023644	2.29E-05	3.18E-05	0.000493549
0.241301	0.0198072	0.0026984	2.23E-05	3.06E-05	0.00049206
0.24156	0.0183173	0.0023279	2.25E-05	2.87E-05	0.000491399
0.241799	0.0168681	0.0020475	2.39E-05	3.03E-05	0.00047806
0.253337	0.0231855	0.0030092	2.48E-05	3.14E-05	0.00042814
0.253504	0.021904	0.0030818	2.46E-05	2.82E-05	0.000415539
0.25375	0.0204561	0.0028006	2.41E-05	2.81E-05	0.000414352
0.254074	0.018885	0.0022574	2.44E-05	2.84E-05	0.00041276
0.254079	0.0179352	0.0030427	2.48E-05	3.01E-05	0.000410572
0.254325	0.0164854	0.0027653	2.65E-05	3.12E-05	0.000409787
0.265638	0.0242135	0.0039071	2.52E-05	3.11E-05	0.000317938
0.266017	0.0225181	0.0030947	2.44E-05	2.98E-05	0.000317941

0.26625	0.021111	0.002904	2.48E-05	2.86E-05	0.000317649
0.266357	0.0199523	0.003246	2.44E-05	2.72E-05	0.000314844
0.266631	0.0184612	0.0028807	2.50E-05	2.72E-05	0.000311287
0.266963	0.0169041	0.002335	2.76E-05	2.94E-05	0.00029215
0.278399	0.0234229	0.0037235	2.63E-05	2.82E-05	0.000225437
0.278616	0.022057	0.0036231	2.68E-05	2.60E-05	0.00020575
0.278893	0.0206102	0.00335	2.63E-05	2.49E-05	0.00020411
0.279196	0.019093	0.0028908	2.64E-05	2.63E-05	0.000202605
0.279218	0.0180988	0.0035894	2.92E-05	2.95E-05	0.000203816
0.279327	0.0169388	0.0039353	3.01E-05	2.98E-05	0.00020392
0.29074	0.0244545	0.0046155	3.16E-05	2.34E-05	9.96E-05
0.290896	0.0232121	0.0047815	3.13E-05	2.20E-05	9.85E-05
0.291052	0.0219695	0.0049486	2.95E-05	2.31E-05	9.46E-05
0.291491	0.0202488	0.0040531	2.93E-05	2.57E-05	9.49E-05
0.291669	0.0189637	0.0041343	3.10E-05	2.83E-05	9.65E-05
0.291712	0.0179272	0.0047458	3.25E-05	2.64E-05	7.53E-05
0.303335	0.0241226	0.0054079	3.28E-05	2.21E-05	2.20E-05
0.303655	0.0225909	0.0049592	3.16E-05	2.26E-05	2.89E-05
0.303905	0.0211978	0.0047687	3.15E-05	2.37E-05	2.76E-05
0.304064	0.0199535	0.0049395	3.17E-05	2.43E-05	2.79E-05
0.304222	0.018709	0.0051113	3.33E-05	2.33E-05	2.91E-05
0.30445	0.0173399	0.00502	3.49E-05	2.23E-05	4.76E-05
0.316044	0.0236259	0.0058478	3.21E-05	2.27E-05	0.000117063
0.316325	0.0221756	0.0055789	3.16E-05	2.29E-05	0.000136622
0.31663	0.0206833	0.0052233	3.26E-05	2.30E-05	0.000136626
0.316766	0.0194949	0.0054768	3.47E-05	2.20E-05	0.000137521
0.316904	0.0182906	0.0057389	3.65E-05	2.29E-05	0.000137843
0.317065	0.0170448	0.0059141	3.62E-05	2.27E-05	0.00013878
0.328805	0.023088	0.0062014	3.27E-05	2.13E-05	0.00022339
0.329043	0.0217188	0.0061115	3.37E-05	2.06E-05	0.000240682
0.329085	0.0206784	0.0067248	3.60E-05	2.35E-05	0.000241583
0.329347	0.0192833	0.0065416	3.62E-05	2.51E-05	0.000243919
0.329659	0.017789	0.0061921	3.49E-05	2.55E-05	0.000261357
0.341074	0.0243544	0.0076171	3.35E-05	1.77E-05	0.000334687
0.34141	0.0228809	0.0072618	3.42E-05	1.92E-05	0.000335031
0.341628	0.021552	0.0072624	3.48E-05	2.13E-05	0.000337747
0.341897	0.0201405	0.0070891	3.51E-05	2.52E-05	0.000341082
0.342064	0.0189089	0.0072594	3.32E-05	2.44E-05	0.000342179
0.34251	0.0172075	0.006476	3.15E-05	2.28E-05	0.000366171
0.354029	0.0236157	0.0075368	3.24E-05	1.93E-05	0.000404647
0.354201	0.0223678	0.0077142	3.23E-05	2.02E-05	0.000419925
0.354344	0.0211766	0.0079724	3.13E-05	1.87E-05	0.000421003
0.354932	0.0192711	0.0067539	2.97E-05	1.85E-05	0.000421085
0.355068	0.0181068	0.0071133	2.87E-05	1.92E-05	0.0004322
0.355185	0.0169557	0.007462	2.85E-05	1.96E-05	0.000455853
0.366838	0.0231638	0.0080727	2.91E-05	1.86E-05	0.000470784
0.366985	0.0219553	0.0083401	2.79E-05	1.63E-05	0.000480102
0.367426	0.0203122	0.0076414	2.62E-05	1.65E-05	0.000480323
0.367626	0.0190209	0.0077367	2.68E-05	1.77E-05	0.000483759
0.367746	0.0178526	0.0080945	2.76E-05	1.93E-05	0.000497952
0.36807	0.0164152	0.0078394	2.76E-05	1.90E-05	0.000504094
0.379363	0.0241502	0.0088734	2.67E-05	1.56E-05	0.000523856

0.37965	0.0227368	0.0087069	2.58E-05	1.42E-05	0.000525346
0.379964	0.0212979	0.0084468	2.41E-05	1.43E-05	0.000526019
0.380251	0.019883	0.0082828	2.43E-05	1.55E-05	0.000527837
0.380482	0.0185654	0.0082861	2.56E-05	1.76E-05	0.000532892
0.380769	0.0171494	0.0081246	2.56E-05	1.82E-05	0.000539288
0.391985	0.0240222	0.0101038	2.42E-05	1.29E-05	0.000542669
0.392533	0.0222415	0.0091589	2.24E-05	1.23E-05	0.000546493
0.39239	0.0214977	0.0103826	2.13E-05	1.41E-05	0.000548466
0.392795	0.0199193	0.0098746	2.19E-05	1.53E-05	0.000549363
0.3932	0.0183556	0.0093602	2.26E-05	1.61E-05	0.000551687
0.393577	0.0168157	0.0089419	2.15E-05	1.43E-05	0.000554031
0.405024	0.0233528	0.0102201	1.90E-05	1.08E-05	0.000548297
0.405062	0.022319	0.0108327	1.73E-05	1.23E-05	0.000551258
0.40536	0.0209032	0.0106743	1.79E-05	1.40E-05	0.000550344
0.405832	0.0192579	0.0099898	1.87E-05	1.31E-05	0.000547529
0.406101	0.0178811	0.0099207	1.84E-05	1.25E-05	0.000548979
0.406126	0.0168912	0.0106277	1.62E-05	1.35E-05	0.000541154
0.417517	0.0244625	0.0112744	1.30E-05	1.03E-05	0.000525433
0.417672	0.023265	0.0115418	1.32E-05	1.08E-05	0.00052591
0.417888	0.0219703	0.0116452	1.30E-05	1.07E-05	0.000525399
0.418119	0.0206944	0.011746	1.38E-05	1.23E-05	0.000523057
0.418452	0.0192522	0.0114982	1.21E-05	1.49E-05	0.000512492
0.418786	0.0177931	0.0112596	8.83E-06	1.73E-05	0.000498223
0.430095	0.0244965	0.0128538	9.41E-06	1.04E-05	0.000486971
0.430587	0.0228528	0.0121749	8.15E-06	1.03E-05	0.000480759
0.430823	0.0215597	0.0122859	7.63E-06	1.26E-05	0.00047832
0.431163	0.0201168	0.0120408	7.39E-06	1.63E-05	0.000472132
0.431228	0.0190392	0.0125724	5.05E-06	1.85E-05	0.000462513
0.431538	0.0176199	0.0124237	4.41E-06	1.88E-05	0.000446436
0.443222	0.0238437	0.012971	4.80E-06	1.09E-05	0.000418451
0.443445	0.0225463	0.0130795	3.87E-06	1.49E-05	0.000402766
0.443854	0.0210219	0.0126653	3.51E-06	1.71E-05	0.000398905
0.444013	0.0198207	0.0129401	4.06E-06	1.89E-05	0.000394289
0.444142	0.0186441	0.0133097	3.39E-06	1.94E-05	0.000390305
0.444567	0.0171208	0.0129038	3.66E-06	1.95E-05	0.000388286
0.455804	0.0248983	0.0139417	2.17E-06	1.26E-05	0.000315012
0.456125	0.0234952	0.0137868	3.04E-06	1.49E-05	0.000313622
0.456256	0.0223335	0.0141479	6.06E-06	1.82E-05	0.00030579
0.456753	0.0207307	0.0135712	7.58E-06	2.11E-05	0.000300642
0.457201	0.0191637	0.0130771	7.09E-06	2.39E-05	0.00029686
0.457522	0.0177416	0.0129354	9.07E-06	2.47E-05	0.000276413
0.469095	0.0241261	0.0138094	6.90E-06	1.63E-05	0.000223547
0.468836	0.0234448	0.0151993	1.15E-05	1.90E-05	0.00019778
0.469456	0.0216776	0.0142794	1.48E-05	2.35E-05	0.000186164
0.469783	0.0202717	0.0141309	1.28E-05	2.78E-05	0.00018406
0.470044	0.0189459	0.0141547	1.28E-05	3.20E-05	0.000184649
0.470616	0.0172427	0.0134234	1.54E-05	3.04E-05	0.000140775
0.48179	0.0241142	0.0153058	1.59E-05	1.90E-05	9.50E-05
0.482056	0.0227884	0.0153296	1.92E-05	2.03E-05	6.50E-05
0.482256	0.0215427	0.0155251	1.77E-05	2.71E-05	6.60E-05
0.482787	0.0198941	0.0148688	1.57E-05	3.05E-05	6.68E-05
0.483169	0.0184492	0.0146452	1.88E-05	3.30E-05	4.70E-05

0.483568	0.0169596	0.0143329	2.42E-05	3.21E-05	2.95E-05
0.494531	0.0250651	0.0160076	2.33E-05	1.66E-05	7.44E-05
0.494784	0.0237817	0.0161239	2.44E-05	1.77E-05	7.87E-05
0.495055	0.0224544	0.0161512	2.32E-05	2.17E-05	8.14E-05
0.495189	0.0212872	0.0165199	2.44E-05	2.69E-05	8.29E-05
0.495561	0.0198388	0.0162942	2.67E-05	2.65E-05	8.59E-05
0.495966	0.0183492	0.0159848	3.04E-05	3.07E-05	0.000111304
0.496202	0.0170604	0.0161016	3.07E-05	3.10E-05	0.000150762
0.507476	0.0248113	0.0169942	2.96E-05	1.89E-05	0.000203983
0.507647	0.0236026	0.0172786	3.09E-05	2.38E-05	0.000232002
0.508233	0.021914	0.0165457	3.24E-05	2.27E-05	0.000236405
0.508524	0.0205879	0.016583	3.38E-05	2.28E-05	0.000236031
0.508729	0.0193381	0.0167858	3.49E-05	2.67E-05	0.000267908
0.509037	0.0179676	0.0167354	3.82E-05	2.90E-05	0.000327329
0.520548	0.024435	0.0177283	4.03E-05	2.44E-05	0.00037005
0.520756	0.0231846	0.017931	4.36E-05	2.60E-05	0.000399136
0.520858	0.0220538	0.0183885	4.35E-05	2.54E-05	0.000403253
0.521295	0.0205669	0.0180909	4.43E-05	2.92E-05	0.000409658
0.52182	0.0189553	0.0175358	4.53E-05	3.04E-05	0.000441266
0.521639	0.0181447	0.0186724	4.86E-05	3.11E-05	0.000467228
0.533468	0.0242548	0.0188878	5.02E-05	2.52E-05	0.000535526
0.533462	0.0232415	0.0195998	5.32E-05	2.62E-05	0.00056302
0.533961	0.0216708	0.0191316	5.42E-05	3.08E-05	0.000572649
0.534476	0.0201191	0.0186621	5.32E-05	3.05E-05	0.000572521
0.534722	0.0188259	0.0187868	5.46E-05	3.02E-05	0.000573809
0.534823	0.0176926	0.0192496	5.79E-05	3.01E-05	0.000576323
0.546048	0.0254832	0.0201773	5.41E-05	2.18E-05	0.000674177
0.546409	0.0240713	0.0200484	5.67E-05	2.46E-05	0.000683568
0.546622	0.0228175	0.0202573	6.04E-05	2.99E-05	0.00068635
0.546888	0.0215439	0.0203804	6.11E-05	2.95E-05	0.00069088
0.547174	0.0202101	0.0204232	6.36E-05	2.50E-05	0.000697036
0.547387	0.0189557	0.0206351	6.69E-05	2.36E-05	0.000695219

Source File

Name: beam1lb_0deg_fast_151.3Hz
Signal: FFT - Vib 3D Velocity - Magnitude
dB-Reference: 0 dB = 1 m/s
Band No.: 1
Frequency: 151.3 Hz

Interpolated: Yes
Filtered: Yes

X	Y	Z	Mag X	Mag Y	Mag Z
0.0705651	0.0191472	-0.0056867	3.06E-05	3.69E-05	0.000153738
0.0836842	0.0189807	-0.0050214	4.00E-05	6.16E-05	0.000302843
0.0836197	0.0175561	-0.0063738	4.18E-05	5.73E-05	0.00030216
0.0705203	0.0177902	-0.006242	2.98E-05	4.13E-05	0.000153684

0.0836638	0.0164281	-0.0048424	4.36E-05	5.79E-05	0.000301883
0.0705554	0.0166257	-0.0052097	3.13E-05	3.75E-05	0.000154107
0.083649	0.0150931	-0.0051978	4.60E-05	5.42E-05	0.000301273
0.0705251	0.0152572	-0.0058631	3.58E-05	3.15E-05	0.000153547
0.083628	0.0138202	-0.0051564	4.71E-05	5.52E-05	0.000300463
0.0705227	0.0140388	-0.005325	3.73E-05	3.12E-05	0.000152956
0.0836226	0.0125177	-0.0052118	4.51E-05	5.57E-05	0.000300326
0.0705079	0.0127136	-0.0055791	3.54E-05	3.35E-05	0.000152876
0.0967851	0.0188044	-0.0044556	5.01E-05	8.02E-05	0.000487188
0.0967878	0.0175544	-0.0042187	5.37E-05	7.90E-05	0.000487225
0.0967862	0.0162643	-0.0041776	5.71E-05	8.77E-05	0.000486002
0.096759	0.0149593	-0.0044352	5.93E-05	8.31E-05	0.00048589
0.0967504	0.0136356	-0.0046903	6.01E-05	7.75E-05	0.000486469
0.0967558	0.0123783	-0.0043483	5.94E-05	7.04E-05	0.000485914
0.109906	0.0186264	-0.0040914	5.66E-05	9.98E-05	0.000692174
0.109884	0.0173145	-0.0042496	5.84E-05	0.000105151	0.000693009
0.109891	0.0160793	-0.0037115	6.34E-05	0.000119069	0.000691765
0.10989	0.0148082	-0.0036714	6.60E-05	0.000114107	0.000691697
0.109869	0.0135071	-0.0037273	6.61E-05	0.000103995	0.000693324
0.109853	0.0121054	-0.0046769	6.65E-05	0.000102096	0.000693965
0.123012	0.0183332	-0.0046198	6.42E-05	0.00013443	0.000907681
0.122993	0.0170319	-0.0046785	6.39E-05	0.000137745	0.000911341
0.122997	0.0157965	-0.0041402	6.67E-05	0.000150789	0.000911661
0.122997	0.0145362	-0.0040005	7.14E-05	0.000148468	0.000912289
0.12298	0.0132572	-0.0038577	7.46E-05	0.000150944	0.000912178
0.122981	0.0119785	-0.0037141	7.69E-05	0.000151419	0.000910895
0.136126	0.0183007	-0.0027623	7.88E-05	0.000178404	0.00111869
0.136126	0.0169028	-0.0037159	7.48E-05	0.00018246	0.00112155
0.136108	0.0155911	-0.0038731	7.65E-05	0.000184097	0.00112261
0.13611	0.0144858	-0.0023419	8.12E-05	0.000184505	0.00112271
0.13611	0.0131749	-0.0024974	8.26E-05	0.000182908	0.00112181
0.136093	0.0118186	-0.0030493	8.43E-05	0.000186642	0.00111967
0.149233	0.0182153	-0.001402	8.29E-05	0.00020711	0.00128495
0.149243	0.0167964	-0.0025542	7.94E-05	0.000215327	0.00130612
0.14923	0.0154524	-0.0030096	8.30E-05	0.000218241	0.00130764
0.149226	0.0142594	-0.0022734	8.68E-05	0.000218138	0.00131008
0.149229	0.0129596	-0.0023293	8.70E-05	0.000222426	0.00131361
0.149217	0.011592	-0.0029806	8.78E-05	0.000222757	0.00131356
0.162347	0.0166689	-0.0015912	8.48E-05	0.000260007	0.0014714
0.16235	0.0153808	-0.0015495	8.81E-05	0.000261985	0.00147311
0.162335	0.0140998	-0.0016085	9.08E-05	0.000262654	0.00147324
0.162342	0.0127781	-0.001863	9.20E-05	0.000258887	0.00147506
0.16234	0.0115233	-0.0015203	9.31E-05	0.000253917	0.0014731
0.17547	0.0164877	-0.0011248	8.48E-05	0.000304547	0.00159805
0.175455	0.0151994	-0.0010833	8.65E-05	0.000304263	0.00159687
0.175458	0.0139114	-0.0010404	9.02E-05	0.000302656	0.00159034
0.175443	0.0126416	-0.0009991	9.48E-05	0.000303862	0.00158946

0.175439	0.0113872	-0.0006563	9.66E-05	0.000299178	0.00158936
0.188595	0.0162189	-0.0014533	8.06E-05	0.000342744	0.00167607
0.188584	0.0149856	-0.0009144	8.21E-05	0.000343296	0.00167386
0.188561	0.0137975	2.27E-05	8.70E-05	0.000341658	0.00166843
0.188547	0.0125282	6.40E-05	9.26E-05	0.000338658	0.00166966
0.188554	0.0112294	9.55E-06	9.46E-05	0.000334592	0.00167063
0.201687	0.0161373	-9.21E-05	7.75E-05	0.000377782	0.00171002
0.201703	0.0148164	-0.0003477	7.82E-05	0.000382481	0.00170829
0.201678	0.0135614	-7.23E-06	8.14E-05	0.000382621	0.00170618
0.201694	0.0122399	-0.0002609	8.51E-05	0.000376935	0.00170398
0.201695	0.0109816	-0.0001186	8.78E-05	0.000370793	0.00170292
0.214742	0.016067	0.00136755	6.92E-05	0.000411867	0.00168749
0.214766	0.0147357	0.00101282	7.32E-05	0.000416114	0.00168418
0.214803	0.0133254	-3.66E-05	7.48E-05	0.000414	0.00168139
0.214746	0.012194	0.00139757	7.76E-05	0.000409633	0.00168079
0.214764	0.0108914	0.00114296	8.10E-05	0.000405533	0.00168048
0.22783	0.0159242	0.00233338	5.92E-05	0.000438501	0.00161983
0.227913	0.0144562	0.00058658	6.42E-05	0.000439464	0.00161404
0.227904	0.0132014	0.00092799	6.77E-05	0.000436382	0.0016103
0.227889	0.0119582	0.00136953	6.78E-05	0.000434314	0.00160824
0.227904	0.0106136	0.00091804	7.15E-05	0.000432952	0.00160815
0.240956	0.0156899	0.00230415	4.72E-05	0.000456313	0.00148988
0.240994	0.0143471	0.00185104	5.05E-05	0.00045844	0.00148892
0.240916	0.0132338	0.00328152	5.01E-05	0.00045626	0.00148584
0.240935	0.0118904	0.00282925	4.89E-05	0.000454564	0.00148681
0.240936	0.0106144	0.00297413	5.36E-05	0.000454699	0.00148698
0.254093	0.0154892	0.00257453	3.79E-05	0.000460977	0.00131011
0.254117	0.0141455	0.00212074	3.87E-05	0.000463846	0.00130893
0.25409	0.012913	0.00266061	3.96E-05	0.000465235	0.00130579
0.25403	0.0117558	0.00369491	3.81E-05	0.000463409	0.00130552
0.25404	0.0104343	0.00344226	3.91E-05	0.000462245	0.00130557
0.267107	0.0154537	0.00433122	2.13E-05	0.000464774	0.00109461
0.267131	0.0141442	0.00417637	2.09E-05	0.000468294	0.00109255
0.267167	0.0127894	0.00362482	2.19E-05	0.000473431	0.00108969
0.267161	0.0115424	0.00386616	2.44E-05	0.000469352	0.00108815
0.267143	0.0102839	0.00400798	2.64E-05	0.000469054	0.0010864
0.280202	0.0152973	0.00499771	1.97E-05	0.000471462	0.000844184
0.28011	0.0141202	0.00603015	2.38E-05	0.00047474	0.000841843
0.280303	0.0125876	0.00389611	2.70E-05	0.000477236	0.000838237
0.280254	0.0113778	0.00463483	2.41E-05	0.000472995	0.00083426
0.280178	0.0102168	0.00546763	2.04E-05	0.000465815	0.000832964
0.293323	0.015078	0.00526951	3.17E-05	0.000464423	0.000532552
0.293287	0.0138412	0.00560661	3.28E-05	0.00046874	0.00056184
0.293188	0.0126872	0.00683893	4.09E-05	0.0004732	0.000557298
0.293253	0.0113325	0.00629095	4.09E-05	0.000468891	0.000552239
0.293353	0.00994559	0.00514447	3.55E-05	0.000460176	0.000550773
0.306351	0.0136991	0.0065719	4.59E-05	0.000453037	0.000269627

0.306372	0.0124181	0.00651603	5.52E-05	0.000460414	0.000264618
0.306305	0.0112153	0.00715146	5.73E-05	0.00046548	0.000258745
0.306375	0.00987795	0.00660309	4.92E-05	0.000463619	0.00025796
0.319466	0.0135084	0.00694079	5.61E-05	0.000433097	6.73E-05
0.319403	0.0123162	0.00767576	6.82E-05	0.00043932	7.22E-05
0.319354	0.0110908	0.00811325	7.25E-05	0.000443496	7.66E-05
0.319397	0.0097686	0.00786415	6.62E-05	0.000440982	7.96E-05
0.332454	0.0134395	0.00839508	7.32E-05	0.000413766	0.000347864
0.332443	0.0121914	0.00863612	8.22E-05	0.000422409	0.000355868
0.332467	0.0109099	0.00858192	8.97E-05	0.000427155	0.000361797
0.332438	0.00964309	0.00882488	8.58E-05	0.000424912	0.000365607
0.345551	0.0132705	0.00896119	9.11E-05	0.000387162	0.000638377
0.345461	0.0120772	0.00969335	9.85E-05	0.000389619	0.000646715
0.345522	0.0107615	0.00934368	0.000102737	0.000398263	0.000650526
0.34545	0.00955136	0.0100819	0.000106122	0.000399634	0.000656198
0.345499	0.00824662	0.00983272	0.000102477	0.000404083	0.000656113
0.332541	0.00828154	0.00808168	8.08E-05	0.00042058	0.000362488
0.358448	0.0132562	0.0109037	0.000105773	0.000359047	0.000907355
0.358564	0.0118957	0.0101596	0.000110039	0.000357545	0.000914749
0.358514	0.0106806	0.0106974	0.000111324	0.000367569	0.000920802
0.358548	0.0093563	0.0104478	0.000114405	0.000369006	0.000924561
0.358561	0.00808486	0.0104948	0.000115393	0.000369342	0.000925921
0.371477	0.0131305	0.0118603	0.000113802	0.000338342	0.00114093
0.371628	0.0117471	0.0109205	0.000117657	0.000330237	0.00115042
0.371542	0.0105419	0.0115541	0.000114995	0.000327505	0.00115585
0.371652	0.00919076	0.0109116	0.000116191	0.00032582	0.00116013
0.371625	0.0079341	0.0112564	0.00011787	0.000332335	0.00116151
0.38453	0.0130004	0.0126163	0.000120266	0.0003148	0.00134332
0.384541	0.0116979	0.0125624	0.000122909	0.000305414	0.00135295
0.384628	0.0103692	0.0121166	0.000120622	0.000299028	0.00136013
0.38473	0.00902847	0.0115735	0.000119717	0.000297509	0.00136271
0.384525	0.00789591	0.0129971	0.000120921	0.000300896	0.00136671
0.397609	0.0128171	0.0130756	0.000122751	0.000280678	0.00149808
0.397535	0.0115925	0.0137123	0.000125741	0.000277309	0.00150811
0.397563	0.0102964	0.0135593	0.000125446	0.000269277	0.00151212
0.397563	0.00903471	0.0137046	0.000124539	0.000269906	0.00151646
0.397685	0.00766324	0.0130675	0.000125278	0.000277274	0.00152007
0.410377	0.0128554	0.015496	0.00012378	0.000254024	0.00159564
0.410488	0.0115153	0.0149529	0.000126048	0.000246945	0.00160527
0.410537	0.0102008	0.0148054	0.000125856	0.000240694	0.00160884
0.41071	0.0088018	0.0137712	0.000125417	0.000243425	0.00161281
0.410694	0.00755016	0.0140158	0.000127272	0.000250764	0.00161525
0.423437	0.0126815	0.016049	0.000117368	0.000227408	0.00163893
0.423504	0.0113739	0.015801	0.000118529	0.000225318	0.00164391
0.423504	0.0101108	0.0159459	0.000120512	0.00022127	0.00164787
0.423454	0.00885127	0.0162867	0.000121616	0.000224303	0.00165239
0.423553	0.00752006	0.0158457	0.000123906	0.000231223	0.00165567

0.423587	0.00623403	0.0157974	0.000125264	0.00023043	0.00166101
0.410694	0.00628729	0.0141632	0.000131276	0.00024852	0.00162479
0.436521	0.0124956	0.016503	0.0001067	0.000212641	0.00163414
0.436434	0.0112756	0.0170355	0.00010736	0.000208009	0.00163808
0.436486	0.00997797	0.0168871	0.000108468	0.000208377	0.00164302
0.436521	0.00869139	0.0168375	0.000111879	0.000201204	0.00165118
0.436503	0.00742681	0.0169813	0.00011439	0.000200227	0.00165632
0.436556	0.00610994	0.0168379	0.000119742	0.000200177	0.00166657
0.449524	0.0123526	0.0173439	9.50E-05	0.000187024	0.00157793
0.449453	0.0111321	0.0178793	9.45E-05	0.000186808	0.00158604
0.449381	0.00990034	0.0183145	9.77E-05	0.00017994	0.00159307
0.449562	0.00852246	0.0174839	9.95E-05	0.00016915	0.00160081
0.449743	0.00714325	0.0166543	0.0001036	0.000161813	0.00160703
0.449634	0.00593422	0.0172876	0.00010978	0.000165554	0.00162394
0.462685	0.0108407	0.0174462	8.24E-05	0.000158849	0.00148292
0.462422	0.00975003	0.0189557	8.53E-05	0.000154514	0.00149016
0.462535	0.00841623	0.0185169	9.11E-05	0.000141826	0.00149429
0.462441	0.00719503	0.0190512	9.30E-05	0.000143481	0.0015025
0.462498	0.00589486	0.018907	9.78E-05	0.000149088	0.00151918
0.475337	0.0109136	0.0200328	6.70E-05	0.000127537	0.00133627
0.475376	0.00962426	0.0199839	6.90E-05	0.00012695	0.00133959
0.475454	0.00831207	0.0197411	7.70E-05	0.000124859	0.0013445
0.475534	0.00698734	0.0193984	8.22E-05	0.000125268	0.00135205
0.475534	0.00572002	0.0195471	8.50E-05	0.000129575	0.00136761
0.488478	0.010687	0.0201824	5.82E-05	9.80E-05	0.00115027
0.488257	0.00953026	0.0212977	5.55E-05	9.85E-05	0.00115327
0.4885	0.00814522	0.0202755	6.26E-05	0.000101747	0.00115649
0.488683	0.00677411	0.0195484	6.98E-05	0.000100754	0.00116762
0.488421	0.00564192	0.0208607	7.20E-05	9.59E-05	0.00118032
0.501224	0.0106777	0.0220708	3.31E-05	7.67E-05	0.000933165
0.50114	0.00945351	0.0226058	3.17E-05	7.94E-05	0.00093861
0.501393	0.00804889	0.0215879	3.61E-05	8.53E-05	0.000942892
0.501332	0.00682008	0.0219244	4.25E-05	8.49E-05	0.000951855
0.501374	0.00552786	0.0218795	5.11E-05	8.03E-05	0.000962254
0.501541	0.00416626	0.0212531	6.54E-05	7.49E-05	0.000973187
0.488705	0.00421225	0.0196493	8.02E-05	8.59E-05	0.00118276
0.514249	0.010503	0.0226953	1.73E-05	5.96E-05	0.000701036
0.513922	0.0094196	0.0242942	1.75E-05	5.25E-05	0.0007051
0.514118	0.00804823	0.0235694	1.85E-05	5.75E-05	0.000710049
0.514143	0.00675463	0.0235201	2.19E-05	6.35E-05	0.000718255
0.514382	0.00537713	0.0226012	2.82E-05	6.28E-05	0.000729977
0.514316	0.00414089	0.0230425	4.25E-05	6.49E-05	0.000741621
0.526844	0.0105571	0.0251514	2.18E-05	4.94E-05	0.000491854
0.527001	0.00922616	0.0246187	1.78E-05	4.35E-05	0.000496468
0.527045	0.00793213	0.0245731	1.64E-05	4.53E-05	0.000502778
0.52687	0.00673959	0.0253954	1.61E-05	4.97E-05	0.000511304
0.527026	0.00540728	0.0248655	1.67E-05	5.37E-05	0.000525637

0.527048	0.00412452	0.0249195	2.07E-05	5.81E-05	0.000538412
0.528561	0.00409976	0.0248612	1.63E-05	5.16E-05	0.000479933
0.528401	0.00331412	0.0251243	1.63E-05	5.29E-05	0.000487555
0.527107	0.00332305	0.0247189	2.23E-05	5.98E-05	0.000550289
0.528742	0.00536012	0.0247538	1.63E-05	4.49E-05	0.000467008
0.529014	0.00657506	0.0242603	1.66E-05	4.11E-05	0.000452912
0.529172	0.00786591	0.0242492	1.63E-05	3.66E-05	0.000442682
0.529352	0.00912679	0.0241446	1.78E-05	4.17E-05	0.000431
0.529307	0.0104994	0.0250085	1.97E-05	3.78E-05	0.000423807
0.526807	0.0112713	0.0252672	1.85E-05	4.82E-05	0.000498469
0.529495	0.0111322	0.0245664	1.98E-05	2.66E-05	0.000423037
0.514414	0.00352216	0.0226223	4.64E-05	6.88E-05	0.000743992
0.51382	0.0115294	0.0245437	1.94E-05	7.20E-05	0.000701017
0.50157	0.00378783	0.0210983	6.92E-05	7.69E-05	0.000976481
0.501145	0.011637	0.0223553	4.11E-05	8.97E-05	0.000932584
0.488645	0.00411632	0.0199569	8.24E-05	8.56E-05	0.00118274
0.48842	0.0117467	0.0203573	5.95E-05	0.000103679	0.00114845
0.47992	0.00438987	0.0197698	8.59E-05	0.000104382	0.00128525
0.475493	0.00455039	0.0198825	8.88E-05	0.000136407	0.00139604
0.475397	0.0119982	0.0196129	7.04E-05	0.000133326	0.00133472
0.462512	0.00489654	0.018925	9.88E-05	0.000156268	0.00152333
0.462346	0.0122892	0.0190599	7.98E-05	0.000160994	0.00146162
0.449609	0.00519474	0.0175747	0.000113046	0.000169735	0.00162747
0.458477	0.0123082	0.0184178	8.81E-05	0.000177691	0.00152215
0.458495	0.0123088	0.0184211	9.10E-05	0.000179761	0.00155672
0.449505	0.0124381	0.017433	9.75E-05	0.00019127	0.00158859
0.436633	0.00550653	0.0165136	0.000121773	0.000201356	0.00166907
0.436518	0.0126814	0.0164814	0.00010851	0.000212313	0.0016331
0.42364	0.00583463	0.0154449	0.000126853	0.000230392	0.00166816
0.423515	0.0129231	0.0155246	0.000118203	0.000230506	0.00163507
0.410726	0.00610372	0.0138839	0.000131724	0.000243305	0.00163679
0.410421	0.0132233	0.0152576	0.000124109	0.000255633	0.00159223
0.402568	0.00641686	0.0141768	0.000136069	0.000246683	0.00161531
0.402646	0.00635943	0.0136861	0.000129773	0.000261228	0.00158106
0.397574	0.00656219	0.01379	0.000125559	0.000278812	0.00150941
0.397771	0.0132077	0.0120383	0.000121941	0.000284494	0.00149351
0.384708	0.00678259	0.0118309	0.000120033	0.000308742	0.001363
0.384535	0.0135825	0.0124496	0.000118531	0.00031626	0.00133788
0.371632	0.00716229	0.0112453	0.000118664	0.000341023	0.00116014
0.37158	0.013776	0.0110907	0.000111591	0.000342977	0.0011389
0.358492	0.00759785	0.0111513	0.000115445	0.000375767	0.000924577
0.358531	0.0140236	0.0102193	0.000101465	0.00036063	0.000903993
0.34551	0.00789003	0.00967252	0.000101136	0.000405518	0.000656969
0.345506	0.0142599	0.00924997	8.83E-05	0.000389514	0.00063573
0.332543	0.00815194	0.00809689	8.13E-05	0.000423513	0.00039354
0.332479	0.0144731	0.00807934	6.93E-05	0.000412492	0.000345151
0.325029	0.00846661	0.00852773	7.76E-05	0.00042829	0.000283912

0.325062	0.0084324	0.0082315	6.78E-05	0.000416636	0.000210938
0.319471	0.00852276	0.00730671	5.81E-05	0.000438031	6.08E-05
0.319371	0.0147746	0.00769941	5.41E-05	0.000430691	6.59E-05
0.306431	0.00882865	0.00612221	4.21E-05	0.000461079	0.000257624
0.30636	0.0149652	0.00632992	4.86E-05	0.000444654	0.000219809
0.293265	0.00931191	0.00632075	3.00E-05	0.000456206	0.00049682
0.305092	0.0150255	0.00670267	4.41E-05	0.000448506	0.000362397
0.305092	0.0150255	0.00670267	3.77E-05	0.000461088	0.000436532
0.293385	0.0151119	0.00456418	2.80E-05	0.000470498	0.00057242
0.292846	0.00920392	0.00528388	2.03E-05	0.000462799	0.000631041
0.280305	0.00927666	0.00396985	2.10E-05	0.000469938	0.000834876
0.280174	0.0155337	0.00527195	1.84E-05	0.000473819	0.000845777
0.267185	0.00946179	0.00370144	3.15E-05	0.000469534	0.00108574
0.267133	0.015724	0.00389953	2.19E-05	0.000463292	0.00109617
0.254058	0.00964637	0.00343265	4.27E-05	0.000463895	0.00130489
0.254059	0.0159587	0.00292354	3.78E-05	0.000457996	0.00131163
0.24099	0.00970573	0.00207279	5.81E-05	0.000453252	0.00148607
0.240924	0.0163034	0.00293981	4.84E-05	0.000454465	0.0014915
0.227876	0.00984455	0.0014074	7.45E-05	0.000432152	0.00161045
0.227857	0.0164945	0.00156651	5.79E-05	0.000436793	0.00162108
0.214782	0.00998379	0.00074332	8.27E-05	0.000401621	0.0016833
0.214768	0.0167632	0.00088899	6.96E-05	0.000405806	0.00168973
0.201701	0.0100779	-0.0003177	8.94E-05	0.000366077	0.00169964
0.201688	0.0169996	-8.64E-05	7.77E-05	0.00037147	0.00170826
0.188552	0.0103301	1.10E-05	9.51E-05	0.000330016	0.00166716
0.188566	0.0173017	-0.0004662	8.12E-05	0.000339107	0.00167473
0.175434	0.0104991	-0.0005557	9.76E-05	0.000294954	0.00158563
0.175463	0.0176047	-0.0008452	8.49E-05	0.000299446	0.00159543
0.162337	0.010605	-0.001517	9.54E-05	0.000249561	0.00146946
0.162335	0.0179514	-0.0008267	8.58E-05	0.000254241	0.00147338
0.149208	0.0107335	-0.0022796	9.04E-05	0.000222793	0.00131031
0.150755	0.0181185	-0.0019834	8.50E-05	0.000219196	0.00136218
0.150755	0.0181185	-0.0019834	8.42E-05	0.000217007	0.00132305
0.136089	0.0109978	-0.0018495	8.48E-05	0.000181936	0.00111525
0.136124	0.018466	-0.0022774	7.74E-05	0.000172499	0.00106903
0.122978	0.011056	-0.0034086	7.70E-05	0.000146913	0.000906552
0.123015	0.0186421	-0.0038487	6.49E-05	0.000132795	0.000906595
0.10986	0.0112198	-0.0038726	6.54E-05	9.43E-05	0.000692397
0.10992	0.0190896	-0.0029347	5.72E-05	9.58E-05	0.000691291
0.0967428	0.0113507	-0.0046348	5.70E-05	6.01E-05	0.000485696
0.0968085	0.0193035	-0.0040072	4.93E-05	7.84E-05	0.000486971
0.0836037	0.0114597	-0.0055955	4.31E-05	4.66E-05	0.000300983
0.083676	0.0195372	-0.0050815	3.80E-05	5.78E-05	0.000302976
0.0704855	0.0116367	-0.0059607	3.30E-05	2.96E-05	0.000154643
0.0705855	0.0198292	-0.0054594	2.87E-05	3.50E-05	0.000155051
0.0576737	0.0129573	-0.0055622	3.02E-05	2.85E-05	7.32E-05
0.0576708	0.0119174	-0.0054453	3.00E-05	2.84E-05	7.66E-05

0.0577008	0.0142423	-0.0055055	3.19E-05	2.77E-05	7.34E-05
0.0577508	0.0156005	-0.0049534	3.14E-05	2.93E-05	7.41E-05
0.0577136	0.0167756	-0.0058868	2.76E-05	3.61E-05	7.41E-05
0.0577268	0.0180465	-0.0061272	2.67E-05	3.78E-05	7.37E-05
0.0577496	0.0193634	-0.0057678	2.63E-05	3.13E-05	7.33E-05
0.0577292	0.0200607	-0.0064464	2.46E-05	2.68E-05	7.71E-05

Source File beam1lb_15deg_fast_48.13Hz
Name:
Signal: FFT - Vib 3D Velocity - Magnitude
dB-Reference: 0 dB = 1 m/s
Band No.: 1
Frequency: 48.13 Hz

Interpolated: Yes
Filtered: Yes

X	Y	Z	Mag X	Mag Y	Mag Z
0.0678508	0.0183671	-0.00550797	1.33E-06	5.45E-07	6.55E-06
0.0837558	0.0177925	-0.00437785	1.88E-06	1.03E-06	1.35E-05
0.0837386	0.016267	-0.00422232	1.96E-06	1.51E-06	1.39E-05
0.0678582	0.016774	-0.00465608	1.28E-06	1.20E-06	6.52E-06
0.0837404	0.0147791	-0.00426276	2.03E-06	3.34E-06	1.42E-05
0.0678573	0.0153328	-0.00519474	1.35E-06	9.90E-07	6.51E-06
0.0837232	0.0132542	-0.00410459	1.98E-06	2.28E-06	1.44E-05
0.0678454	0.0137604	-0.00453909	1.35E-06	1.55E-06	6.74E-06
0.083724	0.0117205	-0.00384543	1.85E-06	2.86E-06	1.45E-05
0.0678534	0.0121615	-0.00358341	1.33E-06	1.25E-06	6.95E-06
0.0996472	0.0172774	-0.00379674	2.28E-06	3.67E-06	2.21E-05
0.0996101	0.0156201	-0.0022473	2.50E-06	4.81E-06	2.28E-05
0.0996229	0.0141996	-0.0031849	2.62E-06	6.06E-06	2.31E-05
0.0996179	0.0126663	-0.00272575	2.49E-06	7.56E-06	2.34E-05
0.0996011	0.0111613	-0.00276504	2.48E-06	7.92E-06	2.35E-05
0.115526	0.0166506	-0.00217365	2.98E-06	8.34E-06	3.28E-05
0.115529	0.0151735	-0.00231395	3.20E-06	9.67E-06	3.37E-05
0.115486	0.0135565	-0.00116111	3.23E-06	1.12E-05	3.42E-05
0.115522	0.0122005	-0.0027937	3.06E-06	1.23E-05	3.46E-05
0.115489	0.0106312	-0.00213586	2.89E-06	1.20E-05	3.45E-05
0.131417	0.016083	-0.00109908	3.62E-06	1.26E-05	4.45E-05
0.131415	0.014644	-0.00163749	3.70E-06	1.50E-05	4.56E-05
0.131409	0.0131206	-0.00147924	3.80E-06	1.55E-05	4.61E-05
0.131394	0.01157	-0.00102107	3.90E-06	1.58E-05	4.67E-05
0.131404	0.0101482	-0.00195556	3.62E-06	1.58E-05	4.63E-05
0.147342	0.0156305	-0.00116982	4.54E-06	1.79E-05	5.75E-05
0.14733	0.0140976	-0.000913047	4.42E-06	1.96E-05	5.90E-05
0.147314	0.0125559	-0.000555432	4.35E-06	1.99E-05	5.98E-05
0.1473	0.0110794	-0.000692958	4.54E-06	2.01E-05	6.02E-05
0.147317	0.00961153	-0.00112868	4.25E-06	1.97E-05	5.95E-05
0.163217	0.0150102	0.000398667	5.40E-06	2.34E-05	7.01E-05
0.163306	0.0136924	-0.00143066	5.26E-06	2.46E-05	7.11E-05

0.163241	0.0120666	-0.000177864	5.02E-06	2.54E-05	7.20E-05
0.163238	0.0105896	-0.000515741	5.03E-06	2.59E-05	7.26E-05
0.163248	0.00910308	-0.000751989	4.93E-06	2.58E-05	7.23E-05
0.179174	0.0145415	0.000626835	5.78E-06	2.77E-05	8.48E-05
0.179168	0.0130554	0.000386183	5.90E-06	2.84E-05	8.53E-05
0.179173	0.0115599	0.000247279	5.82E-06	3.04E-05	8.55E-05
0.179107	0.00998209	0.00100325	5.86E-06	3.00E-05	8.56E-05
0.179136	0.0085232	0.000469331	5.88E-06	2.96E-05	8.55E-05
0.195105	0.0125317	0.000858639	6.47E-06	3.17E-05	9.78E-05
0.195038	0.0109807	0.00151538	6.47E-06	3.26E-05	9.75E-05
0.195009	0.00943978	0.00187502	6.50E-06	3.31E-05	9.72E-05
0.195003	0.00795366	0.00163863	6.52E-06	3.33E-05	9.73E-05
0.210987	0.0119535	0.00217666	7.13E-06	3.41E-05	0.000109436
0.211071	0.010549	0.00104595	7.14E-06	3.57E-05	0.000110021
0.210896	0.00886193	0.00299276	7.06E-06	3.64E-05	0.000109662
0.210948	0.00742056	0.00226172	6.96E-06	3.80E-05	0.00010952
0.22695	0.0114502	0.00254979	7.43E-06	4.00E-05	0.000120142
0.226965	0.00996253	0.00231307	7.32E-06	4.07E-05	0.000121631
0.226937	0.00842949	0.00257368	7.32E-06	4.18E-05	0.000122682
0.226934	0.00694177	0.00233796	7.27E-06	4.28E-05	0.000123232
0.242878	0.0109016	0.00346899	7.47E-06	4.27E-05	0.000129219
0.242866	0.00938623	0.00353019	7.68E-06	4.36E-05	0.00013085
0.242893	0.00790706	0.00319619	7.79E-06	4.57E-05	0.000132358
0.242882	0.00640968	0.00305997	7.69E-06	4.55E-05	0.000133519
0.258929	0.0104358	0.00334727	7.91E-06	4.55E-05	0.000139889
0.258802	0.00883768	0.004298	8.23E-06	4.70E-05	0.000139479
0.258799	0.00733083	0.00426176	8.34E-06	4.69E-05	0.00013969
0.258786	0.00583366	0.00432752	8.15E-06	4.73E-05	0.000139578
0.274759	0.00978812	0.00525434	8.33E-06	4.97E-05	0.000147416
0.274715	0.0082626	0.00541293	8.39E-06	5.00E-05	0.00014682
0.274792	0.00683617	0.00468619	8.48E-06	4.99E-05	0.000146757
0.274742	0.00529291	0.00504734	8.43E-06	4.88E-05	0.000146034
0.290749	0.00927764	0.0057254	8.67E-06	5.35E-05	0.000155405
0.290746	0.00776883	0.00568855	8.46E-06	5.22E-05	0.000153483
0.290823	0.00634975	0.00486177	8.20E-06	5.10E-05	0.000151127
0.29067	0.0047348	0.00601347	8.30E-06	5.01E-05	0.000150089
0.30677	0.00878536	0.00604838	8.35E-06	5.28E-05	0.000157925
0.306752	0.00726615	0.00611053	8.08E-06	5.12E-05	0.000157092
0.30681	0.00580919	0.00548058	7.87E-06	5.11E-05	0.000155705
0.306712	0.00425581	0.00613924	7.92E-06	4.97E-05	0.000154726
0.306676	0.0027373	0.00620287	8.24E-06	4.81E-05	0.000155733
0.290561	0.00316562	0.00667017	8.42E-06	5.00E-05	0.000150149
0.322869	0.00831935	0.00592669	7.71E-06	4.92E-05	0.00015189
0.322722	0.00671816	0.00687617	7.69E-06	4.94E-05	0.000153984
0.322917	0.00534866	0.0054627	7.49E-06	4.95E-05	0.000154297
0.322765	0.00375779	0.00631368	7.69E-06	4.91E-05	0.000155616
0.322732	0.0022474	0.00648011	8.00E-06	4.76E-05	0.000157515
0.338745	0.0077097	0.00743133	7.71E-06	4.97E-05	0.000151515
0.33883	0.00626843	0.00680639	7.75E-06	5.03E-05	0.000152456
0.338731	0.00471129	0.00726118	7.89E-06	5.19E-05	0.000154984
0.338817	0.00325045	0.00663707	7.95E-06	5.23E-05	0.000155748
0.33872	0.00170405	0.00719738	8.16E-06	5.21E-05	0.00015847

0.354852	0.00723408	0.00750865	7.53E-06	5.26E-05	0.000150874
0.354814	0.00572001	0.00767122	7.56E-06	5.13E-05	0.000150259
0.35471	0.0041617	0.00812544	7.69E-06	5.11E-05	0.000152802
0.354736	0.00266466	0.00789575	7.78E-06	5.26E-05	0.00015482
0.354776	0.00120319	0.00746934	7.54E-06	5.22E-05	0.000157601
0.370768	0.00514415	0.00867863	7.02E-06	4.85E-05	0.00014392
0.370777	0.0036641	0.00844675	7.13E-06	4.82E-05	0.000147262
0.370873	0.00219942	0.00782495	7.15E-06	5.03E-05	0.000149862
0.370644	0.000599202	0.00896997	7.08E-06	5.01E-05	0.000151687
0.386815	0.00463924	0.00914512	6.27E-06	4.62E-05	0.000136568
0.386772	0.00310377	0.0093073	6.14E-06	4.52E-05	0.00013782
0.386765	0.00161318	0.00917509	6.53E-06	4.56E-05	0.000139392
0.386686	7.99E-05	0.0095375	6.59E-06	4.63E-05	0.00014155
0.402728	0.00404534	0.0104431	5.80E-06	4.33E-05	0.000126689
0.402627	0.00251017	0.0107991	5.69E-06	4.07E-05	0.000126876
0.40277	0.00105919	0.00998412	6.05E-06	4.17E-05	0.000128973
0.402782	-0.000424898	0.00975557	6.49E-06	4.07E-05	0.000132241
0.418904	0.00358125	0.0103171	5.39E-06	3.94E-05	0.000115458
0.418857	0.0020605	0.0104807	5.28E-06	3.85E-05	0.000116878
0.41873	0.000506223	0.0110362	5.57E-06	3.81E-05	0.000118804
0.418743	-0.000998321	0.0108065	5.88E-06	3.69E-05	0.000121446
0.434926	0.00303807	0.0111213	4.45E-06	3.53E-05	9.99E-05
0.435042	0.00158353	0.0105049	4.59E-06	3.52E-05	0.000102029
0.434994	6.92E-05	0.0105684	4.84E-06	3.50E-05	0.000103663
0.43482	-0.00150363	0.0113193	5.02E-06	3.39E-05	0.000106128
0.450582	0.0023485	0.0136256	3.45E-06	3.17E-05	8.87E-05
0.450792	0.000935603	0.0125203	3.66E-06	3.30E-05	8.97E-05
0.450739	-0.00058841	0.0126849	3.81E-06	3.26E-05	9.02E-05
0.450669	-0.00211183	0.0128468	4.27E-06	3.18E-05	9.32E-05
0.450723	-0.00359392	0.0125275	4.56E-06	3.19E-05	9.55E-05
0.434793	-0.00302739	0.0112863	5.26E-06	3.40E-05	0.000106351
0.466951	0.00193063	0.0128626	3.28E-06	2.30E-05	7.29E-05
0.466946	0.000429259	0.0127303	3.11E-06	2.50E-05	7.36E-05
0.466936	-0.00108077	0.0127005	3.11E-06	2.88E-05	7.45E-05
0.466774	-0.00264013	0.0132505	3.57E-06	2.79E-05	7.58E-05
0.466786	-0.00414135	0.0131261	3.79E-06	3.00E-05	7.77E-05
0.483101	0.00142568	0.0131166	3.26E-06	1.75E-05	6.09E-05
0.482951	-0.000118751	0.0136686	3.00E-06	2.06E-05	5.71E-05
0.482918	-0.00163939	0.0137359	2.53E-06	2.28E-05	5.87E-05
0.483215	-0.00303627	0.0123467	2.78E-06	2.23E-05	5.93E-05
0.482785	-0.00469602	0.0140639	2.86E-06	2.54E-05	6.17E-05
0.498941	-0.00068653	0.0146465	2.88E-06	1.89E-05	4.04E-05
0.498979	-0.00218472	0.0144238	2.48E-06	1.79E-05	4.17E-05
0.499046	-0.00364778	0.0140059	2.16E-06	1.62E-05	4.43E-05
0.498962	-0.00518715	0.0142691	2.07E-06	1.91E-05	4.57E-05
0.515093	-0.00119729	0.0149898	2.82E-06	1.78E-05	2.51E-05
0.515006	-0.00272084	0.0152515	2.50E-06	1.46E-05	2.65E-05
0.515076	-0.00420554	0.014833	2.12E-06	1.37E-05	2.94E-05
0.514838	-0.00577681	0.0156761	1.85E-06	1.50E-05	3.22E-05
0.529038	-0.00619734	0.0155477	1.79E-06	1.37E-05	2.30E-05
0.52893	-0.00726388	0.0162612	1.68E-06	1.30E-05	2.44E-05
0.515071	-0.00657246	0.0147375	1.84E-06	1.54E-05	3.35E-05

0.528804	-0.00470772	0.015921	1.78E-06	1.43E-05	2.08E-05
0.529007	-0.00307973	0.0146589	1.89E-06	1.35E-05	1.84E-05
0.528687	-0.00164207	0.0154231	1.59E-06	1.55E-05	1.78E-05
0.515025	-9.05E-05	0.0153789	2.37E-06	1.76E-05	2.66E-05
0.528537	-0.000674695	0.0156738	1.26E-06	1.50E-05	1.73E-05
0.498943	-0.00587323	0.0143106	2.41E-06	2.10E-05	4.74E-05
0.499244	0.000740973	0.0135011	2.97E-06	1.79E-05	4.13E-05
0.482887	-0.00518155	0.0135319	3.08E-06	2.68E-05	6.43E-05
0.484132	0.00141111	0.0129504	3.23E-06	1.72E-05	5.62E-05
0.483008	0.00141059	0.0135057	3.30E-06	2.13E-05	6.23E-05
0.466833	-0.00448158	0.0129026	3.72E-06	2.95E-05	7.98E-05
0.466994	0.00215415	0.0126861	3.30E-06	2.66E-05	7.36E-05
0.450617	-0.00384106	0.012997	4.39E-06	3.22E-05	9.59E-05
0.450579	0.00274167	0.0136595	3.66E-06	3.38E-05	8.96E-05
0.434752	-0.00306263	0.0114797	5.19E-06	3.39E-05	0.000106364
0.434922	0.00361818	0.0111716	4.62E-06	3.67E-05	0.000101828
0.431921	-0.00281688	0.0100842	5.74E-06	3.41E-05	0.000112133
0.418773	-0.00235384	0.0105942	6.22E-06	3.57E-05	0.000122471
0.418857	0.00433986	0.0106821	5.61E-06	4.23E-05	0.000116595
0.402771	-0.00162756	0.00975253	6.46E-06	4.14E-05	0.000133931
0.402758	0.00503277	0.0103324	5.93E-06	4.65E-05	0.000129442
0.386603	-0.000996953	0.0098377	6.77E-06	4.71E-05	0.000142252
0.386734	0.0057594	0.00963884	6.30E-06	4.89E-05	0.000137748
0.370803	-0.000199136	0.00801172	7.18E-06	5.18E-05	0.000152917
0.370741	0.00649382	0.00889705	6.94E-06	4.94E-05	0.000144697
0.354588	0.000394359	0.00858867	7.69E-06	5.39E-05	0.000159027
0.358216	0.00706956	0.00814982	7.35E-06	5.29E-05	0.000149882
0.354771	0.00722676	0.00800345	7.47E-06	5.32E-05	0.000150922
0.338721	0.0011556	0.00704811	7.95E-06	5.34E-05	0.000158966
0.338728	0.00794213	0.00755145	7.67E-06	4.97E-05	0.00015056
0.322777	0.00188362	0.00615056	7.90E-06	4.88E-05	0.000157647
0.322856	0.00872809	0.00616496	7.91E-06	4.97E-05	0.000152113
0.306624	0.00248026	0.00657843	8.09E-06	4.76E-05	0.000155248
0.306792	0.0094151	0.00590647	8.49E-06	5.37E-05	0.000157056
0.290611	0.00314493	0.00626994	8.33E-06	4.92E-05	0.000150256
0.290658	0.0100286	0.00649129	8.91E-06	5.40E-05	0.000156066
0.284995	0.00339023	0.00610104	8.52E-06	5.03E-05	0.000147526
0.274663	0.00385273	0.00551645	8.61E-06	4.85E-05	0.000145964
0.274776	0.0108054	0.00514796	8.30E-06	4.83E-05	0.00014765
0.259335	0.00457379	0.00427388	8.49E-06	4.60E-05	0.000143525
0.258805	0.00462118	0.00391859	8.13E-06	4.58E-05	0.000138493
0.258901	0.0116015	0.00365417	7.96E-06	4.53E-05	0.000142648
0.242771	0.00512038	0.00414432	7.78E-06	4.56E-05	0.000132903
0.242948	0.0121953	0.00299045	7.61E-06	4.20E-05	0.000129223
0.258761	0.0115744	0.00393966	7.95E-06	4.38E-05	0.000138914
0.22687	0.00574348	0.00303099	7.28E-06	4.19E-05	0.000122071
0.226953	0.0127527	0.00277216	7.39E-06	3.88E-05	0.000118555
0.210953	0.00634947	0.00216561	6.95E-06	3.86E-05	0.00010951
0.211022	0.0133664	0.00200917	7.12E-06	3.44E-05	0.00010913
0.194994	0.00690195	0.00174422	6.56E-06	3.34E-05	9.69E-05
0.19503	0.0139157	0.0019899	6.47E-06	3.13E-05	9.88E-05
0.179086	0.00746384	0.00127563	5.92E-06	2.95E-05	8.49E-05

0.187751	0.0142659	0.000731142	6.07E-06	3.08E-05	9.19E-05
0.18777	0.014294	0.000433083	5.71E-06	2.66E-05	8.80E-05
0.179139	0.0145221	0.00122661	5.65E-06	2.58E-05	8.29E-05
0.163188	0.00809864	5.85E-05	4.96E-06	2.49E-05	7.19E-05
0.163211	0.0151115	0.000508563	5.35E-06	2.16E-05	6.96E-05
0.147248	0.0086077	8.35E-05	4.15E-06	1.90E-05	5.90E-05
0.147344	0.0157773	-0.00075369	4.52E-06	1.54E-05	5.68E-05
0.131363	0.00919007	-0.000637978	3.58E-06	1.43E-05	4.61E-05
0.131425	0.0163698	-0.00137299	3.60E-06	1.01E-05	4.39E-05
0.115482	0.00981929	-0.00180874	3.03E-06	1.07E-05	3.42E-05
0.115537	0.017012	-0.00264129	2.87E-06	7.17E-06	3.24E-05
0.0995948	0.0103862	-0.00223388	2.46E-06	7.02E-06	2.33E-05
0.0996566	0.0177418	-0.00455584	2.25E-06	3.48E-06	2.20E-05
0.0837269	0.0111104	-0.00450431	1.69E-06	2.11E-06	1.44E-05
0.0837555	0.0182457	-0.00443475	1.87E-06	8.13E-07	1.33E-05
0.0678558	0.0115242	-0.00334116	1.34E-06	1.60E-06	6.72E-06
0.0678708	0.0188465	-0.00506	1.26E-06	9.50E-07	6.57E-06
0.0541391	0.0126361	-0.00420611	1.40E-06	1.43E-06	4.11E-06
0.0541339	0.0120815	-0.0046593	1.57E-06	3.71E-06	3.67E-06
0.0541115	0.0142921	-0.00595941	1.37E-06	1.68E-06	4.36E-06
0.054119	0.0158567	-0.00651511	1.33E-06	1.64E-06	4.12E-06
0.0541166	0.0173466	-0.0064737	1.19E-06	2.31E-06	4.04E-06
0.0541477	0.0187496	-0.00533467	1.03E-06	2.41E-06	3.96E-06
0.054139	0.0193807	-0.0058764	1.00E-06	1.99E-06	3.73E-06

Source File beam1lb_15deg_fast_147.5Hz
Name:
Signal: FFT - Vib 3D Velocity - Magnitude
dB-Reference: 0 dB = 1 m/s
Band No.: 1
Frequency: 147.5 Hz

Interpolated: Yes
Filtered: Yes

X	Y	Z	Mag X	Mag Y	Mag Z
0.0678508	0.0183671	-0.00550797	3.65E-05	4.87E-05	8.25E-05
0.0837558	0.0177925	-0.00437785	2.98E-05	0.000113033	0.00019184
0.0837386	0.016267	-0.00422232	2.81E-05	0.000113623	0.000192261
0.0678582	0.016774	-0.00465608	3.65E-05	4.93E-05	8.23E-05
0.0837404	0.0147791	-0.00426276	2.87E-05	0.000114969	0.000192287
0.0678573	0.0153328	-0.00519474	3.68E-05	5.01E-05	8.21E-05
0.0837232	0.0132542	-0.00410459	3.11E-05	0.000112435	0.000192045
0.0678454	0.0137604	-0.00453909	3.74E-05	5.03E-05	8.20E-05
0.083724	0.0117205	-0.00384543	3.16E-05	0.000107746	0.000191287
0.0678534	0.0121615	-0.00358341	3.58E-05	4.75E-05	8.19E-05
0.0996472	0.0172774	-0.00379674	2.41E-05	0.000203098	0.000330064
0.0996101	0.0156201	-0.0022473	2.20E-05	0.000205349	0.000330094
0.0996229	0.0141996	-0.0031849	2.16E-05	0.000203654	0.000329546
0.0996179	0.0126663	-0.00272575	2.39E-05	0.000203205	0.000328738
0.0996011	0.0111613	-0.00276504	2.55E-05	0.0001979	0.000328359

0.115526	0.0166506	-0.00217365	2.11E-05	0.000306426	0.000476038
0.115529	0.0151735	-0.00231395	2.13E-05	0.00030488	0.000475831
0.115486	0.0135565	-0.00116111	2.13E-05	0.000305036	0.000476198
0.115522	0.0122005	-0.0027937	2.20E-05	0.000300842	0.000474616
0.115489	0.0106312	-0.00213586	2.35E-05	0.000296594	0.000473024
0.131417	0.016083	-0.00109908	2.30E-05	0.000412366	0.000621284
0.131415	0.014644	-0.00163749	2.28E-05	0.000412186	0.00062275
0.131409	0.0131206	-0.00147924	2.20E-05	0.000412284	0.000622086
0.131394	0.01157	-0.00102107	2.19E-05	0.000414323	0.000620418
0.131404	0.0101482	-0.00195556	2.25E-05	0.000405304	0.000614722
0.147342	0.0156305	-0.00116982	2.48E-05	0.000521875	0.000750838
0.14733	0.0140976	-0.000913047	2.32E-05	0.0005219	0.000752911
0.147314	0.0125559	-0.000555432	2.22E-05	0.000524402	0.000752794
0.1473	0.0110794	-0.000692958	2.15E-05	0.000520818	0.000750159
0.147317	0.00961153	-0.00112868	2.19E-05	0.000516073	0.00074513
0.163217	0.0150102	0.000398667	2.55E-05	0.000624671	0.000855283
0.163306	0.0136924	-0.00143066	2.28E-05	0.000627292	0.000861851
0.163241	0.0120666	-0.000177864	2.16E-05	0.000626915	0.000862146
0.163238	0.0105896	-0.000515741	2.14E-05	0.000624156	0.000858061
0.163248	0.00910308	-0.000751989	2.14E-05	0.000617921	0.000850382
0.179174	0.0145415	0.000626835	2.51E-05	0.000722568	0.000935588
0.179168	0.0130554	0.000386183	2.25E-05	0.000721657	0.000932202
0.179173	0.0115599	0.000247279	2.13E-05	0.000720096	0.000931449
0.179107	0.00998209	0.00100325	2.14E-05	0.000719209	0.000929667
0.179136	0.0085232	0.000469331	2.15E-05	0.000717537	0.000925439
0.195105	0.0125317	0.000858639	2.11E-05	0.000808069	0.000959432
0.195038	0.0109807	0.00151538	2.04E-05	0.000803168	0.00095607
0.195009	0.00943978	0.00187502	2.08E-05	0.000805159	0.000956215
0.195003	0.00795366	0.00163863	2.20E-05	0.000801942	0.000954234
0.210987	0.0119535	0.00217666	2.00E-05	0.000873703	0.000955518
0.211071	0.010549	0.00104595	2.22E-05	0.00086827	0.000948947
0.210896	0.00886193	0.00299276	2.38E-05	0.00086508	0.000946104
0.210948	0.00742056	0.00226172	2.49E-05	0.000859043	0.000941985
0.22695	0.0114502	0.00254979	2.20E-05	0.000937512	0.000909198
0.226965	0.00996253	0.00231307	2.65E-05	0.000935574	0.000900909
0.226937	0.00842949	0.00257368	2.73E-05	0.000925479	0.000897772
0.226934	0.00694177	0.00233796	2.84E-05	0.000909355	0.000892328
0.242878	0.0109016	0.00346899	2.77E-05	0.000984853	0.000817876
0.242866	0.00938623	0.00353019	3.35E-05	0.000984653	0.000804273
0.242893	0.00790706	0.00319619	3.57E-05	0.000964904	0.000799995
0.242882	0.00640968	0.00305997	3.70E-05	0.000945641	0.000798949
0.258929	0.0104358	0.00334727	3.94E-05	0.000994454	0.000685161
0.258802	0.00883768	0.004298	4.67E-05	0.000982482	0.000669339
0.258799	0.00733083	0.00426176	5.00E-05	0.000965318	0.000665669
0.258786	0.00583366	0.00432752	5.23E-05	0.000956669	0.00066733
0.274759	0.00978812	0.00525434	5.55E-05	0.000983767	0.000518602
0.274715	0.0082626	0.00541293	6.15E-05	0.00097426	0.000502797
0.274792	0.00683617	0.00468619	6.40E-05	0.000963756	0.00049707
0.274742	0.00529291	0.00504734	6.65E-05	0.000963045	0.000496376
0.290749	0.00927764	0.0057254	6.76E-05	0.00097168	0.00032955
0.290746	0.00776883	0.00568855	7.09E-05	0.000969333	0.000314176
0.290823	0.00634975	0.00486177	7.26E-05	0.000964219	0.000307278

0.29067	0.0047348	0.00601347	7.69E-05	0.00095986	0.000304491
0.30677	0.00878536	0.00604838	7.51E-05	0.000945078	0.000126352
0.306752	0.00726615	0.00611053	7.86E-05	0.000941139	0.000113653
0.30681	0.00580919	0.00548058	8.01E-05	0.000940815	0.000107163
0.306712	0.00425581	0.00613924	8.28E-05	0.000929773	0.000104395
0.306676	0.0027373	0.00620287	8.53E-05	0.000911991	0.0001038
0.290561	0.00316562	0.00667017	8.16E-05	0.000944781	0.000284623
0.322869	0.00831935	0.00592669	8.21E-05	0.000906277	9.32E-05
0.322722	0.00671816	0.00687617	8.60E-05	0.000905219	0.00010574
0.322917	0.00534866	0.0054627	8.71E-05	0.00090035	0.000111574
0.322765	0.00375779	0.00631368	8.71E-05	0.000891231	0.000115872
0.322732	0.0022474	0.00648011	8.83E-05	0.00087846	0.000117429
0.338745	0.0077097	0.00743133	9.18E-05	0.000857185	0.0002921
0.33883	0.00626843	0.00680639	9.33E-05	0.000857982	0.000305084
0.338731	0.00471129	0.00726118	9.31E-05	0.000858085	0.000313995
0.338817	0.00325045	0.00663707	9.21E-05	0.000849702	0.000317078
0.33872	0.00170405	0.00719738	9.25E-05	0.000846397	0.000320945
0.354852	0.00723408	0.00750865	9.63E-05	0.000822114	0.000450303
0.354814	0.00572001	0.00767122	9.79E-05	0.000808051	0.000489356
0.35471	0.0041617	0.00812544	9.84E-05	0.000804594	0.000497306
0.354736	0.00266466	0.00789575	9.73E-05	0.000790654	0.00050266
0.354776	0.00120319	0.00746934	9.58E-05	0.000786367	0.000505994
0.370768	0.00514415	0.00867863	0.000101152	0.000758749	0.000649016
0.370777	0.0036641	0.00844675	0.000100834	0.000751091	0.00065844
0.370873	0.00219942	0.00782495	9.96E-05	0.000740818	0.000664507
0.370644	0.000599202	0.00896997	9.90E-05	0.000742443	0.0006681
0.386815	0.00463924	0.00914512	0.000101838	0.000713623	0.000777842
0.386772	0.00310377	0.0093073	0.000101875	0.000706436	0.000787618
0.386765	0.00161318	0.00917509	0.000100841	0.000700287	0.000796208
0.386686	7.99E-05	0.0095375	9.98E-05	0.000702814	0.000802985
0.402728	0.00404534	0.0104431	0.000101955	0.000660963	0.000870166
0.402627	0.00251017	0.0107991	0.000100553	0.000650031	0.000879556
0.40277	0.00105919	0.00998412	9.83E-05	0.000638049	0.000890384
0.402782	-0.000424898	0.00975557	9.61E-05	0.000640263	0.000898154
0.418904	0.00358125	0.0103171	9.84E-05	0.00059146	0.000916144
0.418857	0.0020605	0.0104807	9.53E-05	0.000578514	0.000924158
0.41873	0.000506223	0.0110362	9.27E-05	0.000569443	0.000934843
0.418743	-0.000998321	0.0108065	9.01E-05	0.000576482	0.000946135
0.434926	0.00303807	0.0111213	9.22E-05	0.000521442	0.000917654
0.435042	0.00158353	0.0105049	8.83E-05	0.000511509	0.000921606
0.434994	6.92E-05	0.0105684	8.46E-05	0.000508504	0.000932887
0.43482	-0.00150363	0.0113193	8.26E-05	0.000517562	0.000944133
0.450582	0.0023485	0.0136256	8.40E-05	0.000457667	0.000874087
0.450792	0.000935603	0.0125203	7.92E-05	0.000455918	0.000876211
0.450739	-0.00058841	0.0126849	7.68E-05	0.000450604	0.000883048
0.450669	-0.00211183	0.0128468	7.41E-05	0.000452357	0.000894812
0.450723	-0.00359392	0.0125275	7.19E-05	0.00045725	0.000904043
0.434793	-0.00302739	0.0112863	8.04E-05	0.000516607	0.000950424
0.466951	0.00193063	0.0128626	7.93E-05	0.000405127	0.000789096
0.466946	0.000429259	0.0127303	7.45E-05	0.000402053	0.000793204
0.466936	-0.00108077	0.0127005	7.11E-05	0.000394651	0.00079736
0.466774	-0.00264013	0.0132505	6.89E-05	0.000392222	0.000808102

0.466786	-0.00414135	0.0131261	6.38E-05	0.000400581	0.000818258
0.483101	0.00142568	0.0131166	7.57E-05	0.000362168	0.000685745
0.482951	-0.000118751	0.0136686	7.01E-05	0.000347089	0.000667087
0.482918	-0.00163939	0.0137359	6.45E-05	0.000330863	0.000674247
0.483215	-0.00303627	0.0123467	6.09E-05	0.000330971	0.000683843
0.482785	-0.00469602	0.0140639	5.57E-05	0.000340422	0.000696929
0.498941	-0.00068653	0.0146465	6.29E-05	0.000264487	0.000518984
0.498979	-0.00218472	0.0144238	5.68E-05	0.000263013	0.000524915
0.499046	-0.00364778	0.0140059	5.04E-05	0.000259208	0.000536517
0.498962	-0.00518715	0.0142691	4.71E-05	0.00026651	0.000549601
0.515093	-0.00119729	0.0149898	5.43E-05	0.0001807	0.000356275
0.515006	-0.00272084	0.0152515	4.77E-05	0.000186436	0.000362119
0.515076	-0.00420554	0.014833	4.04E-05	0.000199879	0.000371996
0.514838	-0.00577681	0.0156761	3.63E-05	0.000201404	0.00038691
0.529038	-0.00619734	0.0155477	2.91E-05	0.000158137	0.000263122
0.52893	-0.00726388	0.0162612	2.40E-05	0.000174825	0.000276546
0.515071	-0.00657246	0.0147375	3.33E-05	0.000215048	0.000393335
0.528804	-0.00470772	0.015921	3.78E-05	0.000147933	0.000252709
0.529007	-0.00307973	0.0146589	4.72E-05	0.000140365	0.000242672
0.528687	-0.00164207	0.0154231	4.94E-05	0.000120278	0.000236678
0.515025	-9.05E-05	0.0153789	5.83E-05	0.000189995	0.000355804
0.528537	-0.000674695	0.0156738	5.25E-05	0.000137633	0.000242132
0.498943	-0.00587323	0.0143106	4.70E-05	0.00027465	0.000555912
0.499244	0.000740973	0.0135011	6.91E-05	0.00028185	0.000514792
0.482887	-0.00518155	0.0135319	5.50E-05	0.000346027	0.000700822
0.484132	0.00141111	0.0129504	7.44E-05	0.000342057	0.000632841
0.483008	0.00141059	0.0135057	7.65E-05	0.000371921	0.000689499
0.466833	-0.00448158	0.0129026	6.35E-05	0.00040795	0.000821912
0.466994	0.00215415	0.0126861	8.01E-05	0.000412224	0.000787669
0.450617	-0.00384106	0.012997	7.19E-05	0.000464441	0.000908891
0.450579	0.00274167	0.0136595	8.52E-05	0.000465523	0.000873665
0.434752	-0.00306263	0.0114797	8.03E-05	0.000518229	0.000952147
0.434922	0.00361818	0.0111716	9.34E-05	0.000526345	0.000915347
0.431921	-0.00281688	0.0100842	8.54E-05	0.000545511	0.000958056
0.418773	-0.00235384	0.0105942	9.11E-05	0.000589784	0.000945183
0.418857	0.00433986	0.0106821	9.96E-05	0.000593176	0.000910341
0.402771	-0.00162756	0.00975253	9.54E-05	0.000650525	0.000896206
0.402758	0.00503277	0.0103324	0.000102107	0.000662563	0.00086169
0.386603	-0.000996953	0.0098377	9.99E-05	0.000708946	0.000799521
0.386734	0.0057594	0.00963884	0.000102479	0.000718746	0.000770083
0.370803	-0.000199136	0.00801172	9.84E-05	0.00074587	0.000666086
0.370741	0.00649382	0.00889705	0.000100594	0.000766411	0.000640651
0.354588	0.000394359	0.00858867	9.51E-05	0.000789832	0.000506217
0.358216	0.00706956	0.00814982	9.72E-05	0.000808941	0.00051265
0.354771	0.00722676	0.00800345	9.52E-05	0.000824697	0.000441299
0.338721	0.0011556	0.00704811	9.26E-05	0.000845338	0.000319941
0.338728	0.00794213	0.00755145	9.04E-05	0.000858659	0.000287914
0.322777	0.00188362	0.00615056	9.01E-05	0.000883085	0.000117696
0.322856	0.00872809	0.00616496	7.98E-05	0.000915332	9.01E-05
0.306624	0.00248026	0.00657843	8.82E-05	0.000911468	0.000103671
0.306792	0.0094151	0.00590647	7.39E-05	0.00095517	0.000129439
0.290611	0.00314493	0.00626994	8.41E-05	0.000946232	0.000281077

0.290658	0.0100286	0.00649129	6.57E-05	0.000980519	0.000332593
0.284995	0.00339023	0.00610104	7.81E-05	0.000957852	0.000372669
0.274663	0.00385273	0.00551645	6.65E-05	0.000968728	0.000507499
0.274776	0.0108054	0.00514796	5.29E-05	0.000985067	0.000521576
0.259335	0.00457379	0.00427388	5.51E-05	0.00097537	0.000626719
0.258805	0.00462118	0.00391859	4.87E-05	0.000960838	0.00069974
0.258901	0.0116015	0.00365417	3.91E-05	0.00098769	0.000659267
0.242771	0.00512038	0.00414432	3.77E-05	0.000937775	0.000797855
0.242948	0.0121953	0.00299045	2.63E-05	0.000958096	0.000818848
0.258761	0.0115744	0.00393966	3.34E-05	0.000967774	0.000724539
0.22687	0.00574348	0.00303099	2.84E-05	0.000903741	0.000890591
0.226953	0.0127527	0.00277216	2.08E-05	0.000917459	0.000910893
0.210953	0.00634947	0.00216561	2.45E-05	0.000854126	0.000941252
0.211022	0.0133664	0.00200917	1.95E-05	0.000866473	0.000958815
0.194994	0.00690195	0.00174422	2.22E-05	0.00079349	0.000952844
0.19503	0.0139157	0.0019899	2.20E-05	0.000812009	0.000968304
0.179086	0.00746384	0.00127563	2.16E-05	0.000708204	0.000921293
0.187751	0.0142659	0.000731142	2.42E-05	0.000769623	0.000961137
0.18777	0.014294	0.000433083	2.51E-05	0.000746524	0.000954736
0.179139	0.0145221	0.00122661	2.65E-05	0.000712259	0.000928457
0.163188	0.00809864	5.85E-05	2.18E-05	0.000612216	0.000846363
0.163211	0.0151115	0.000508563	2.67E-05	0.000622625	0.000851549
0.147248	0.0086077	8.35E-05	2.24E-05	0.000505616	0.000742519
0.147344	0.0157773	-0.00075369	2.53E-05	0.000519752	0.000748851
0.131363	0.00919007	-0.000637978	2.30E-05	0.000397624	0.000612995
0.131425	0.0163698	-0.00137299	2.32E-05	0.000413008	0.000619707
0.115482	0.00981929	-0.00180874	2.41E-05	0.000288162	0.000472893
0.115537	0.017012	-0.00264129	2.09E-05	0.000304225	0.00047543
0.0995948	0.0103862	-0.00223388	2.64E-05	0.000194694	0.000328148
0.0996566	0.0177418	-0.00455584	2.55E-05	0.000202765	0.000330135
0.0837269	0.0111104	-0.00450431	3.13E-05	0.00010558	0.000191566
0.0837555	0.0182457	-0.00443475	3.03E-05	0.00011261	0.000192585
0.0678558	0.0115242	-0.00334116	3.53E-05	4.70E-05	8.29E-05
0.0678708	0.0188465	-0.00506	3.67E-05	4.79E-05	8.41E-05
0.0541391	0.0126361	-0.00420611	3.89E-05	3.05E-05	2.51E-05
0.0541339	0.0120815	-0.0046593	3.82E-05	3.21E-05	2.73E-05
0.0541115	0.0142921	-0.00595941	4.01E-05	2.78E-05	2.54E-05
0.054119	0.0158567	-0.00651511	4.03E-05	2.42E-05	2.54E-05
0.0541166	0.0173466	-0.0064737	3.94E-05	2.32E-05	2.54E-05
0.0541477	0.0187496	-0.00533467	3.90E-05	1.74E-05	2.55E-05
0.054139	0.0193807	-0.0058764	3.93E-05	1.33E-05	2.82E-05

Source File beam1lb_30deg_fast_48.13Hz
Name:
Signal: FFT - Vib 3D Velocity - Magnitude
dB-Reference: 0 dB = 1 m/s
Band No.: 1
Frequency: 48.13 Hz

Interpolated: Yes

Filtered: Yes

X	Y	Z	Mag X	Mag Y	Mag Z
0.0518091	0.00965715	-0.00646857	1.30E-06	6.06E-07	7.66E-06
0.0659021	0.00522006	-0.00610007	2.11E-06	7.49E-07	1.88E-05
0.0655194	0.00399632	-0.00673863	2.08E-06	1.49E-06	1.89E-05
0.0514515	0.00820225	-0.00592999	1.73E-06	1.36E-06	7.53E-06
0.0651674	0.00246775	-0.00580552	2.31E-06	9.60E-07	1.91E-05
0.0510676	0.00688512	-0.00607601	1.72E-06	5.55E-07	7.59E-06
0.0648068	0.0010546	-0.00556195	2.52E-06	1.43E-06	1.91E-05
0.0507038	0.00554413	-0.00612435	1.93E-06	1.85E-06	7.58E-06
0.064408	-0.000165377	-0.00619569	2.80E-06	1.78E-06	1.85E-05
0.0503316	0.00416883	-0.00597391	2.00E-06	8.92E-07	6.97E-06
0.0799879	0.000839931	-0.00609084	2.38E-06	1.07E-06	3.74E-05
0.0796013	-0.000307685	-0.00712181	2.59E-06	1.20E-06	3.70E-05
0.0792145	-0.00160449	-0.00736545	2.66E-06	2.02E-06	3.76E-05
0.0788548	-0.00314758	-0.00633172	3.30E-06	2.10E-06	3.75E-05
0.078493	-0.00452356	-0.0061813	3.28E-06	1.81E-06	3.68E-05
0.0940739	-0.0034878	-0.00623767	3.47E-06	6.92E-07	6.08E-05
0.093696	-0.00465577	-0.00717057	3.08E-06	2.72E-06	6.07E-05
0.093318	-0.00617434	-0.00633658	3.45E-06	3.56E-06	6.16E-05
0.0929274	-0.00739514	-0.00697158	3.44E-06	2.17E-06	6.20E-05
0.0925673	-0.00884422	-0.00642758	3.58E-06	2.50E-06	6.19E-05
0.108156	-0.00770449	-0.00703822	3.66E-06	1.01E-06	8.75E-05
0.107767	-0.00905324	-0.00708906	3.17E-06	2.52E-06	8.82E-05
0.107397	-0.0103346	-0.00743132	3.04E-06	2.58E-06	8.99E-05
0.107014	-0.0118144	-0.00669037	3.19E-06	3.02E-06	9.02E-05
0.106646	-0.0131872	-0.0065387	3.46E-06	2.39E-06	9.03E-05
0.122255	-0.011947	-0.00770389	3.05E-06	2.18E-06	0.000117669
0.121862	-0.0133501	-0.00745957	2.25E-06	2.61E-06	0.0001189
0.121478	-0.0145907	-0.00799748	2.01E-06	2.98E-06	0.000119867
0.121108	-0.0159271	-0.00804335	2.28E-06	3.79E-06	0.000120141
0.120715	-0.0173475	-0.00769688	2.75E-06	4.28E-06	0.000120085
0.136336	-0.0163535	-0.00754834	1.33E-06	2.82E-06	0.000150958
0.135954	-0.0176124	-0.00798897	1.08E-06	3.21E-06	0.00015324
0.135586	-0.0188745	-0.00853047	9.66E-07	3.58E-06	0.000153959
0.135187	-0.020331	-0.00788672	1.10E-06	3.21E-06	0.00015432
0.134801	-0.0216441	-0.00802872	1.25E-06	3.44E-06	0.000154234
0.150434	-0.0205451	-0.00853514	1.61E-06	2.26E-06	0.000190262
0.150071	-0.0218095	-0.00897618	2.25E-06	2.25E-06	0.000194331
0.149681	-0.0231407	-0.00902212	1.83E-06	2.13E-06	0.00019644
0.149294	-0.0245629	-0.00867664	1.53E-06	3.24E-07	0.000196826
0.148893	-0.025981	-0.00822796	3.29E-07	8.51E-07	0.000196127
0.150836	-0.019144	-0.00877881	2.27E-07	6.60E-07	0.000194788
0.164937	-0.0234881	-0.00894177	2.17E-06	1.67E-06	0.000228081
0.164582	-0.0246243	-0.0101736	4.47E-06	2.35E-06	0.000230524
0.164191	-0.0260478	-0.00972899	4.68E-06	1.89E-06	0.000235227
0.16379	-0.0274311	-0.00947956	4.10E-06	1.57E-06	0.000237648
0.163388	-0.0288127	-0.00933027	3.31E-06	3.24E-07	0.000238308
0.163	-0.0302166	-0.00898003	1.81E-06	1.54E-06	0.000236966
0.179037	-0.0277602	-0.0094602	4.03E-06	1.60E-06	0.000261241
0.178678	-0.0289514	-0.0103969	5.91E-06	2.21E-06	0.000264156

0.178273	-0.0304076	-0.00975502	6.40E-06	1.70E-06	0.000267191
0.177909	-0.0316173	-0.0105911	5.94E-06	2.16E-06	0.000268577
0.177475	-0.0331188	-0.00965116	5.66E-06	1.86E-06	0.000270461
0.177107	-0.0344195	-0.00989134	5.11E-06	2.01E-06	0.000271425
0.193181	-0.0319725	-0.010436	6.63E-06	1.69E-06	0.000294034
0.192827	-0.0331673	-0.0112713	7.78E-06	2.77E-06	0.000296872
0.192384	-0.0347227	-0.0101401	7.56E-06	3.35E-06	0.000299808
0.192015	-0.0359687	-0.0106778	7.09E-06	4.48E-06	0.000301964
0.191616	-0.037316	-0.0106237	7.30E-06	4.98E-06	0.000302244
0.191213	-0.038734	-0.0102759	7.41E-06	4.80E-06	0.000301963
0.207334	-0.0362097	-0.0112755	9.18E-06	2.16E-06	0.000328695
0.206962	-0.0374739	-0.0117171	9.68E-06	3.26E-06	0.000330995
0.206547	-0.0389098	-0.0111732	1.00E-05	3.39E-06	0.000333975
0.206158	-0.0402237	-0.0114186	9.85E-06	4.36E-06	0.000336309
0.205757	-0.0415709	-0.0113644	9.59E-06	4.32E-06	0.000336417
0.205401	-0.0428405	-0.0118012	9.85E-06	5.59E-06	0.000334132
0.221505	-0.0404009	-0.0122707	1.19E-05	3.86E-06	0.000360652
0.221182	-0.0416054	-0.013207	1.26E-05	3.90E-06	0.000363242
0.220681	-0.0431834	-0.0117778	1.31E-05	3.94E-06	0.000364878
0.220283	-0.0445143	-0.0118233	1.31E-05	4.09E-06	0.000366393
0.219952	-0.0457363	-0.0126577	1.28E-05	4.42E-06	0.000366942
0.21948	-0.0472452	-0.0116179	1.26E-05	5.17E-06	0.000365982
0.235712	-0.0445856	-0.0135289	1.55E-05	5.25E-06	0.000383807
0.235337	-0.0459066	-0.0136748	1.57E-05	4.69E-06	0.000386601
0.234844	-0.0474323	-0.0125411	1.58E-05	4.19E-06	0.000387272
0.23446	-0.0487317	-0.0127834	1.55E-05	4.94E-06	0.000388939
0.234073	-0.050084	-0.0128303	1.52E-05	4.09E-06	0.000390125
0.233643	-0.0514788	-0.0124796	1.49E-05	5.35E-06	0.000391028
0.249968	-0.0487339	-0.0149418	1.72E-05	8.39E-06	0.000403517
0.249497	-0.0501947	-0.0142033	1.72E-05	7.63E-06	0.000406014
0.249131	-0.0514643	-0.0146437	1.72E-05	5.89E-06	0.000406274
0.248655	-0.0529757	-0.0137081	1.71E-05	4.60E-06	0.000406519
0.248254	-0.0543078	-0.0137525	1.70E-05	5.39E-06	0.000407816
0.247878	-0.0556289	-0.0138935	1.72E-05	5.14E-06	0.000411754
0.264177	-0.0529647	-0.0158255	1.84E-05	1.08E-05	0.00041487
0.263785	-0.0543202	-0.0158761	1.83E-05	9.88E-06	0.00041728
0.263287	-0.0558098	-0.01494	1.83E-05	7.86E-06	0.000416475
0.262893	-0.0571277	-0.0150842	1.84E-05	7.15E-06	0.000415723
0.262592	-0.0583273	-0.0160132	1.89E-05	6.89E-06	0.000417946
0.262127	-0.0597692	-0.0154695	1.93E-05	7.53E-06	0.000424158
0.278353	-0.0573001	-0.016182	2.03E-05	8.85E-06	0.000438009
0.277959	-0.0586196	-0.0163287	2.00E-05	8.55E-06	0.000432933
0.277601	-0.0599134	-0.0166698	2.00E-05	8.44E-06	0.00043196
0.277077	-0.0614315	-0.0156378	2.03E-05	8.09E-06	0.000434119
0.276735	-0.0626749	-0.0162723	2.09E-05	8.49E-06	0.000432751
0.276315	-0.0640588	-0.0160199	2.12E-05	6.88E-06	0.000437834
0.29261	-0.0615337	-0.0171881	2.14E-05	7.16E-06	0.000443011
0.29217	-0.0629148	-0.0169422	2.11E-05	7.97E-06	0.00043702
0.291865	-0.0641156	-0.0178736	2.09E-05	9.18E-06	0.000437297
0.291395	-0.0655607	-0.0172311	2.13E-05	9.32E-06	0.000444965
0.290972	-0.0669274	-0.0171809	2.15E-05	9.84E-06	0.000448295
0.290577	-0.0682478	-0.0173229	2.25E-05	7.86E-06	0.000451275

0.306805	-0.0658453	-0.0176664	2.26E-05	8.13E-06	0.00045554
0.306397	-0.067182	-0.0177152	2.27E-05	8.82E-06	0.000453695
0.306127	-0.0683765	-0.0187431	2.28E-05	1.03E-05	0.000455826
0.305693	-0.0697429	-0.0185933	2.29E-05	1.14E-05	0.000461029
0.305187	-0.071196	-0.0178531	2.26E-05	1.26E-05	0.000461135
0.304795	-0.0725369	-0.0178957	2.29E-05	1.21E-05	0.000463549
0.321166	-0.0699883	-0.0192837	2.30E-05	1.10E-05	0.000458703
0.32082	-0.0712544	-0.0198232	2.33E-05	8.73E-06	0.000461857
0.320269	-0.0727708	-0.0186927	2.35E-05	9.17E-06	0.000465363
0.320002	-0.073951	-0.0198185	2.43E-05	9.22E-06	0.00047092
0.319526	-0.0753605	-0.0193735	2.40E-05	1.11E-05	0.000473772
0.319092	-0.0767457	-0.0191219	2.40E-05	1.13E-05	0.000474446
0.335451	-0.0742421	-0.0202781	2.34E-05	8.81E-06	0.000450416
0.335083	-0.0755585	-0.0205219	2.33E-05	8.01E-06	0.000454332
0.33467	-0.0768984	-0.0205702	2.38E-05	6.82E-06	0.000457973
0.334271	-0.0782241	-0.0207153	2.40E-05	7.61E-06	0.000463396
0.333805	-0.0796384	-0.0202693	2.47E-05	7.30E-06	0.000464911
0.333382	-0.080975	-0.0202129	2.51E-05	8.09E-06	0.000463166
0.349866	-0.078392	-0.0219161	2.24E-05	7.25E-06	0.000420366
0.349333	-0.0798453	-0.0211828	2.23E-05	6.68E-06	0.000424904
0.349023	-0.0811083	-0.0218171	2.21E-05	6.69E-06	0.000431237
0.348549	-0.0825048	-0.0214728	2.24E-05	6.03E-06	0.000432395
0.348165	-0.083837	-0.0216151	2.37E-05	6.26E-06	0.000429036
0.347632	-0.0852866	-0.0208763	2.48E-05	5.94E-06	0.000427747
0.364185	-0.0826645	-0.0228343	2.18E-05	4.83E-06	0.000392033
0.363642	-0.084117	-0.022102	2.09E-05	6.92E-06	0.000395414
0.363304	-0.0854104	-0.0225403	2.13E-05	5.22E-06	0.000398726
0.362798	-0.0868176	-0.021998	2.14E-05	6.11E-06	0.000404768
0.362538	-0.0880443	-0.0229232	2.23E-05	5.86E-06	0.000406048
0.361996	-0.0894935	-0.0221856	2.29E-05	6.08E-06	0.000404918
0.37856	-0.0869033	-0.0240087	2.05E-05	5.72E-06	0.000378058
0.378058	-0.0883154	-0.0235708	2.02E-05	6.22E-06	0.000376846
0.377627	-0.0896751	-0.0234196	2.02E-05	6.61E-06	0.000380308
0.377274	-0.0909669	-0.0238586	2.04E-05	6.28E-06	0.000384019
0.376888	-0.0923034	-0.0240012	2.03E-05	6.67E-06	0.000387536
0.376473	-0.0936315	-0.024044	2.01E-05	6.11E-06	0.000388853
0.392845	-0.0912296	-0.0245602	1.86E-05	4.18E-06	0.000361315
0.392528	-0.0924982	-0.0251967	1.76E-05	8.23E-06	0.000361493
0.392006	-0.0939245	-0.024558	1.75E-05	7.51E-06	0.000359678
0.391654	-0.0952195	-0.0249971	1.73E-05	7.73E-06	0.000361414
0.391185	-0.0965879	-0.0247486	1.74E-05	5.27E-06	0.000361941
0.390884	-0.0978627	-0.0253784	1.70E-05	5.22E-06	0.000367987
0.407354	-0.0954076	-0.0262452	1.59E-05	3.96E-06	0.000322302
0.406802	-0.0968462	-0.0256144	1.55E-05	5.20E-06	0.000321411
0.406402	-0.0981656	-0.0257591	1.51E-05	6.89E-06	0.000319293
0.406031	-0.099494	-0.0260008	1.54E-05	5.49E-06	0.000319892
0.405485	-0.100914	-0.025363	1.54E-05	4.62E-06	0.000320968
0.40528	-0.102112	-0.0265799	1.58E-05	3.97E-06	0.000336102
0.421715	-0.0997106	-0.0271184	1.26E-05	2.83E-06	0.000279197
0.421352	-0.101008	-0.0274594	1.27E-05	4.06E-06	0.00027908
0.420832	-0.102422	-0.0269204	1.24E-05	4.07E-06	0.000280763
0.42033	-0.103822	-0.0265804	1.26E-05	3.42E-06	0.000280228

0.420081	-0.105046	-0.0275022	1.33E-05	2.45E-06	0.00028162
0.419771	-0.106324	-0.0280309	1.32E-05	4.77E-06	0.000295728
0.436296	-0.103883	-0.0289239	7.51E-06	4.22E-06	0.000231389
0.435793	-0.10527	-0.0285846	8.79E-06	2.76E-06	0.000234511
0.435345	-0.106636	-0.0284358	9.13E-06	1.28E-06	0.00023704
0.434777	-0.108073	-0.0278052	9.76E-06	2.95E-06	0.000241166
0.434653	-0.10923	-0.0293099	8.85E-06	1.49E-06	0.000241578
0.434246	-0.110572	-0.029352	8.73E-06	2.03E-06	0.000254944
0.450746	-0.10815	-0.0300134	3.43E-06	5.09E-06	0.000189317
0.449982	-0.109697	-0.0285134	4.72E-06	2.03E-06	0.000191656
0.449782	-0.110922	-0.0295301	5.52E-06	1.48E-06	0.000196086
0.449293	-0.112296	-0.0292865	5.73E-06	2.11E-06	0.000197053
0.448867	-0.113635	-0.0293329	5.75E-06	2.92E-06	0.000203039
0.448541	-0.114932	-0.0297638	5.55E-06	4.11E-06	0.000214039
0.465067	-0.112509	-0.0304903	1.33E-06	3.02E-06	0.000149297
0.464786	-0.113787	-0.0311194	8.71E-07	1.68E-06	0.000152622
0.464423	-0.115094	-0.0314597	1.79E-06	1.48E-06	0.000156199
0.463707	-0.116602	-0.0301478	1.60E-06	1.86E-06	0.000159775
0.463431	-0.117863	-0.0308735	2.41E-06	3.19E-06	0.000165417
0.479626	-0.116764	-0.0318994	6.92E-07	4.80E-06	0.000107896
0.479151	-0.118131	-0.0317571	2.13E-06	3.91E-06	0.000109505
0.478894	-0.119401	-0.0324815	2.34E-06	1.74E-06	0.000113823
0.478423	-0.120752	-0.0323338	1.96E-06	1.62E-06	0.000118562
0.477948	-0.122118	-0.032188	1.78E-06	1.55E-06	0.000124496
0.494106	-0.121072	-0.0328869	2.76E-06	6.40E-06	6.83E-05
0.493678	-0.122402	-0.0329358	5.35E-06	3.83E-06	6.99E-05
0.493128	-0.123804	-0.0325034	5.14E-06	1.42E-06	7.47E-05
0.492735	-0.125144	-0.0326462	4.94E-06	1.66E-06	8.08E-05
0.492442	-0.126426	-0.0332743	4.15E-06	2.75E-06	8.70E-05
0.499317	-0.128488	-0.0335891	5.29E-06	2.53E-06	6.83E-05
0.498785	-0.129803	-0.0330357	5.43E-06	7.97E-07	7.07E-05
0.492037	-0.127671	-0.0333035	4.24E-06	8.67E-07	8.93E-05
0.499719	-0.12713	-0.0335473	5.50E-06	2.08E-06	6.36E-05
0.50021	-0.125746	-0.0338935	6.32E-06	1.06E-06	5.70E-05
0.500414	-0.12449	-0.0329771	5.69E-06	2.82E-06	5.19E-05
0.50072	-0.123175	-0.0325458	3.30E-06	5.94E-06	4.94E-05
0.494175	-0.120235	-0.0319453	1.35E-06	9.54E-06	6.96E-05
0.500989	-0.122216	-0.0324737	1.83E-06	9.82E-06	4.97E-05
0.477457	-0.123461	-0.0318351	1.43E-06	2.57E-06	0.00012702
0.47976	-0.115931	-0.0312529	1.69E-06	5.41E-06	0.000108211
0.46305	-0.119165	-0.0311104	1.69E-06	6.07E-06	0.000165207
0.465342	-0.111648	-0.0304277	2.38E-06	3.81E-06	0.000150971
0.458171	-0.117912	-0.029777	4.04E-06	5.42E-06	0.000195098
0.448531	-0.114965	-0.0297698	6.71E-06	1.99E-06	0.000217594
0.450949	-0.107359	-0.0297691	3.82E-06	6.00E-06	0.000189765
0.434088	-0.110722	-0.028683	9.89E-06	1.28E-06	0.000256909
0.436394	-0.103173	-0.0281966	7.75E-06	3.81E-06	0.000232985
0.419648	-0.106485	-0.0275618	1.42E-05	3.72E-06	0.000301159
0.421809	-0.0990373	-0.0263966	1.38E-05	2.31E-06	0.000278891
0.405224	-0.102258	-0.0265062	1.60E-05	5.67E-06	0.000340119
0.40742	-0.0948001	-0.0254344	1.74E-05	2.84E-06	0.000322489
0.390838	-0.0980285	-0.0254082	1.78E-05	5.88E-06	0.000368315

0.39303	-0.0905668	-0.0244377	1.99E-05	4.18E-06	0.000360522
0.376396	-0.0938595	-0.023985	2.08E-05	6.45E-06	0.000390006
0.378703	-0.0863015	-0.023697	2.09E-05	4.03E-06	0.000378487
0.361942	-0.0897277	-0.0223281	2.33E-05	5.43E-06	0.000411513
0.364398	-0.0820288	-0.0230175	2.18E-05	5.85E-06	0.000393812
0.347524	-0.0855938	-0.020731	2.48E-05	6.44E-06	0.000436064
0.349854	-0.0780022	-0.0207384	2.30E-05	6.28E-06	0.000418559
0.333276	-0.0813179	-0.0201744	2.47E-05	8.38E-06	0.000469184
0.335582	-0.0737655	-0.0199857	2.32E-05	9.83E-06	0.000449647
0.319082	-0.0770081	-0.0198744	2.40E-05	1.13E-05	0.000474553
0.32126	-0.0695557	-0.0189008	2.29E-05	1.08E-05	0.000458125
0.304825	-0.0727739	-0.0191487	2.34E-05	1.07E-05	0.000464103
0.306917	-0.0654174	-0.0174857	2.23E-05	8.08E-06	0.000452914
0.290401	-0.0687473	-0.016909	2.24E-05	7.31E-06	0.000452772
0.292686	-0.061186	-0.0168202	2.12E-05	7.04E-06	0.000446247
0.276151	-0.0645782	-0.0158114	2.06E-05	7.58E-06	0.000438458
0.278402	-0.0570174	-0.0156235	1.97E-05	9.02E-06	0.000435858
0.261999	-0.0602443	-0.0156573	1.90E-05	8.07E-06	0.000426599
0.264285	-0.0526425	-0.0157634	1.79E-05	9.43E-06	0.000414997
0.247796	-0.0560073	-0.0149766	1.65E-05	7.03E-06	0.00041217
0.250042	-0.0484559	-0.0147883	1.64E-05	7.06E-06	0.000401941
0.233562	-0.0518915	-0.0136698	1.43E-05	5.59E-06	0.000390825
0.235747	-0.0444432	-0.0127909	1.46E-05	4.35E-06	0.000383091
0.219367	-0.0477191	-0.0126174	1.21E-05	6.41E-06	0.000365072
0.221558	-0.0402057	-0.0121325	1.14E-05	4.10E-06	0.000359009
0.205177	-0.0435527	-0.011527	9.35E-06	5.68E-06	0.000332703
0.207384	-0.0360307	-0.0112418	8.73E-06	1.93E-06	0.000328372
0.191056	-0.0393006	-0.0110907	7.19E-06	4.73E-06	0.000301244
0.193232	-0.0317919	-0.0106052	6.23E-06	1.53E-06	0.000293135
0.176888	-0.0351297	-0.0101243	4.34E-06	2.10E-06	0.000270046
0.179039	-0.027767	-0.00885146	3.20E-06	1.88E-06	0.00026001
0.162761	-0.0310103	-0.00892354	1.43E-06	1.83E-06	0.000234156
0.164959	-0.0234054	-0.00902785	1.24E-06	1.68E-06	0.000226338
0.148675	-0.0267247	-0.00867007	6.46E-07	1.45E-06	0.000194379
0.150835	-0.0191832	-0.00837925	8.61E-07	7.43E-07	0.000195838
0.134559	-0.0225244	-0.00798791	1.33E-06	3.15E-06	0.000154577
0.139141	-0.0157262	-0.00769083	1.42E-06	1.32E-06	0.000180067
0.13674	-0.0148406	-0.00848311	2.01E-06	1.12E-06	0.000150705
0.120467	-0.0183346	-0.00716752	2.80E-06	3.41E-06	0.000120213
0.122607	-0.0107698	-0.00707397	3.19E-06	8.23E-07	0.000117471
0.106371	-0.0140376	-0.00700114	3.53E-06	2.40E-06	9.03E-05
0.108519	-0.00647182	-0.00690642	3.58E-06	1.48E-07	8.71E-05
0.0922843	-0.0098008	-0.00650293	3.61E-06	2.35E-06	6.19E-05
0.0944177	-0.00213556	-0.0068973	2.97E-06	1.34E-06	6.09E-05
0.0781988	-0.00554835	-0.00616768	3.36E-06	3.34E-06	3.67E-05
0.080319	0.00212408	-0.00655965	2.25E-06	2.45E-06	3.72E-05
0.0640985	-0.00113142	-0.00657789	2.79E-06	2.23E-06	1.84E-05
0.0662309	0.00634098	-0.0059892	1.74E-06	2.61E-06	1.88E-05
0.0500456	0.00303371	-0.00577843	2.00E-06	9.20E-07	6.97E-06
0.0521121	0.0107512	-0.00636205	1.36E-06	2.65E-06	7.56E-06
0.0456893	0.00531499	-0.00443386	1.32E-06	5.38E-07	3.97E-06
0.045296	0.00461118	-0.00639316	1.21E-06	7.06E-07	3.34E-06

0.0459978	0.00698273	-0.00605411	1.38E-06	1.68E-06	4.87E-06
0.0463818	0.00822609	-0.00551573	1.48E-06	1.71E-06	4.99E-06
0.0467738	0.0095038	-0.00517376	1.32E-06	6.69E-07	4.69E-06
0.0471127	0.0110382	-0.00610388	1.11E-06	1.46E-06	4.36E-06
0.0474359	0.0120331	-0.00550763	1.22E-06	2.25E-06	4.02E-06

Source File beam1lb_30deg_fast_147.5Hz
Name:
Signal: FFT - Vib 3D Velocity - Magnitude
dB-Reference: 0 dB = 1 m/s
Band No.: 1
Frequency: 147.5 Hz

Interpolated: Yes
Filtered: Yes

X	Y	Z	Mag X	Mag Y	Mag Z
0.0518091	0.00965715	-0.00646857	2.19E-05	1.47E-05	8.17E-06
0.0659021	0.00522006	-0.00610007	2.08E-05	1.41E-05	3.87E-05
0.0655194	0.00399632	-0.00673863	2.30E-05	1.44E-05	3.94E-05
0.0514515	0.00820225	-0.00592999	2.23E-05	1.56E-05	7.82E-06
0.0651674	0.00246775	-0.00580552	2.35E-05	1.45E-05	3.89E-05
0.0510676	0.00688512	-0.00607601	2.24E-05	1.70E-05	7.92E-06
0.0648068	0.0010546	-0.00556195	2.36E-05	1.35E-05	3.88E-05
0.0507038	0.00554413	-0.00612435	2.26E-05	1.72E-05	8.21E-06
0.064408	-0.000165377	-0.00619569	2.34E-05	1.37E-05	3.78E-05
0.0503316	0.00416883	-0.00597391	2.25E-05	1.62E-05	7.59E-06
0.0799879	0.000839931	-0.00609084	2.25E-05	1.24E-05	9.19E-05
0.0796013	-0.000307685	-0.00712181	2.55E-05	1.33E-05	9.32E-05
0.0792145	-0.00160449	-0.00736545	2.58E-05	1.29E-05	9.28E-05
0.0788548	-0.00314758	-0.00633172	2.52E-05	1.54E-05	9.26E-05
0.078493	-0.00452356	-0.0061813	2.55E-05	1.24E-05	9.19E-05
0.0940739	-0.0034878	-0.00623767	2.48E-05	1.72E-05	0.000159939
0.093696	-0.00465577	-0.00717057	2.77E-05	1.67E-05	0.000159636
0.093318	-0.00617434	-0.00633658	2.77E-05	1.81E-05	0.000158005
0.0929274	-0.00739514	-0.00697158	2.78E-05	1.88E-05	0.000157821
0.0925673	-0.00884422	-0.00642758	2.87E-05	1.45E-05	0.000157736
0.108156	-0.00770449	-0.00703822	2.99E-05	2.87E-05	0.000235845
0.107767	-0.00905324	-0.00708906	3.27E-05	2.63E-05	0.0002335
0.107397	-0.0103346	-0.00743132	3.27E-05	2.85E-05	0.000231394
0.107014	-0.0118144	-0.00669037	3.29E-05	2.92E-05	0.000233629
0.106646	-0.0131872	-0.0065387	3.35E-05	2.43E-05	0.00023239
0.122255	-0.011947	-0.00770389	3.80E-05	3.92E-05	0.000311069
0.121862	-0.0133501	-0.00745957	4.16E-05	3.67E-05	0.000307288
0.121478	-0.0145907	-0.00799748	4.28E-05	3.77E-05	0.000305363
0.121108	-0.0159271	-0.00804335	4.28E-05	3.83E-05	0.000305123
0.120715	-0.0173475	-0.00769688	4.29E-05	3.46E-05	0.000303694
0.136336	-0.0163535	-0.00754834	4.60E-05	5.11E-05	0.000378233
0.135954	-0.0176124	-0.00798897	4.92E-05	4.86E-05	0.000375524
0.135586	-0.0188745	-0.00853047	5.08E-05	5.22E-05	0.000373405
0.135187	-0.020331	-0.00788672	5.20E-05	5.21E-05	0.000374873

0.134801	-0.0216441	-0.00802872	5.22E-05	5.07E-05	0.000372532
0.150434	-0.0205451	-0.00853514	5.47E-05	6.29E-05	0.000436101
0.150071	-0.0218095	-0.00897618	5.80E-05	6.80E-05	0.000435969
0.149681	-0.0231407	-0.00902212	6.11E-05	7.07E-05	0.000436047
0.149294	-0.0245629	-0.00867664	6.16E-05	6.88E-05	0.000435129
0.148893	-0.025981	-0.00822796	6.24E-05	6.44E-05	0.000433517
0.150836	-0.019144	-0.00877881	5.30E-05	6.49E-05	0.000444801
0.164937	-0.0234881	-0.00894177	6.28E-05	8.13E-05	0.000482408
0.164582	-0.0246243	-0.0101736	6.58E-05	8.07E-05	0.000484171
0.164191	-0.0260478	-0.00972899	6.87E-05	8.38E-05	0.000484921
0.16379	-0.0274311	-0.00947956	7.09E-05	8.76E-05	0.00048529
0.163388	-0.0288127	-0.00933027	7.16E-05	8.41E-05	0.000483513
0.163	-0.0302166	-0.00898003	7.16E-05	8.19E-05	0.000481346
0.179037	-0.0277602	-0.0094602	7.21E-05	9.59E-05	0.000509417
0.178678	-0.0289514	-0.0103969	7.70E-05	9.80E-05	0.000514944
0.178273	-0.0304076	-0.00975502	7.89E-05	0.000100056	0.000515831
0.177909	-0.0316173	-0.0105911	8.08E-05	9.90E-05	0.000514905
0.177475	-0.0331188	-0.00965116	8.13E-05	9.91E-05	0.000513397
0.177107	-0.0344195	-0.00989134	8.20E-05	9.55E-05	0.000509993
0.193181	-0.0319725	-0.010436	8.21E-05	0.000109081	0.000517591
0.192827	-0.0331673	-0.0112713	8.62E-05	0.000117781	0.000521731
0.192384	-0.0347227	-0.0101401	8.81E-05	0.000117023	0.00052225
0.192015	-0.0359687	-0.0106778	8.85E-05	0.000111785	0.000519284
0.191616	-0.037316	-0.0106237	9.07E-05	0.000111197	0.000517554
0.191213	-0.038734	-0.0102759	9.20E-05	0.000110391	0.00051776
0.207334	-0.0362097	-0.0112755	9.27E-05	0.000132777	0.000513185
0.206962	-0.0374739	-0.0117171	9.56E-05	0.000141784	0.000512347
0.206547	-0.0389098	-0.0111732	9.62E-05	0.000140067	0.000510526
0.206158	-0.0402237	-0.0114186	9.71E-05	0.000131435	0.000507284
0.205757	-0.0415709	-0.0113644	9.98E-05	0.000126452	0.000506547
0.205401	-0.0428405	-0.0118012	0.000100894	0.000126017	0.000507441
0.221505	-0.0404009	-0.0122707	0.000100927	0.000154194	0.000490313
0.221182	-0.0416054	-0.013207	0.000101642	0.000159673	0.000484526
0.220681	-0.0431834	-0.0117778	0.000101093	0.000156478	0.000482914
0.220283	-0.0445143	-0.0118233	0.000103067	0.00015276	0.000480328
0.219952	-0.0457363	-0.0126577	0.000105801	0.000148657	0.000479454
0.21948	-0.0472452	-0.0116179	0.000106283	0.000145529	0.000479335
0.235712	-0.0445856	-0.0135289	0.000104857	0.00017329	0.000438895
0.235337	-0.0459066	-0.0136748	0.000103892	0.000171052	0.000433963
0.234844	-0.0474323	-0.0125411	0.00010573	0.000171335	0.000432717
0.23446	-0.0487317	-0.0127834	0.000107922	0.000170447	0.00043085
0.234073	-0.050084	-0.0128303	0.000110276	0.000169098	0.000431297
0.233643	-0.0514788	-0.0124796	0.000109728	0.000167403	0.000431056
0.249968	-0.0487339	-0.0149418	0.000104592	0.000183513	0.000369247
0.249497	-0.0501947	-0.0142033	0.0001056	0.000187453	0.000364018
0.249131	-0.0514643	-0.0146437	0.000107277	0.000187675	0.000363685
0.248655	-0.0529757	-0.0137081	0.000110638	0.000188411	0.000364102
0.248254	-0.0543078	-0.0137525	0.000111717	0.000189747	0.000366242
0.247878	-0.0556289	-0.0138935	0.000111758	0.000189594	0.000369086
0.264177	-0.0529647	-0.0158255	0.000104526	0.000200564	0.000290124
0.263785	-0.0543202	-0.0158761	0.000104666	0.000201789	0.000283697
0.263287	-0.0558098	-0.01494	0.000106634	0.000204701	0.000282882

0.262893	-0.0571277	-0.0150842	0.000108511	0.000203215	0.000282665
0.262592	-0.0583273	-0.0160132	0.000109928	0.000204169	0.000282964
0.262127	-0.0597692	-0.0154695	0.000110581	0.00020186	0.000282821
0.278353	-0.0573001	-0.016182	0.00010375	0.000214995	0.000198685
0.277959	-0.0586196	-0.0163287	0.000103882	0.000216846	0.000192568
0.277601	-0.0599134	-0.0166698	0.000104871	0.000216392	0.000192225
0.277077	-0.0614315	-0.0156378	0.000106991	0.000215942	0.000192563
0.276735	-0.0626749	-0.0162723	0.000107926	0.000214826	0.00018998
0.276315	-0.0640588	-0.0160199	0.000109515	0.000212026	0.000187718
0.29261	-0.0615337	-0.0171881	0.000102227	0.00022813	9.68E-05
0.29217	-0.0629148	-0.0169422	0.00010076	0.000230451	9.19E-05
0.291865	-0.0641156	-0.0178736	0.000101151	0.000232098	9.11E-05
0.291395	-0.0655607	-0.0172311	0.000102413	0.000233688	9.17E-05
0.290972	-0.0669274	-0.0171809	0.000105382	0.000234078	9.09E-05
0.290577	-0.0682478	-0.0173229	0.000107442	0.00023336	8.75E-05
0.306805	-0.0658453	-0.0176664	9.91E-05	0.000242068	3.30E-05
0.306397	-0.067182	-0.0177152	9.53E-05	0.000243565	3.44E-05
0.306127	-0.0683765	-0.0187431	9.41E-05	0.00024511	3.54E-05
0.305693	-0.0697429	-0.0185933	9.67E-05	0.000247648	3.53E-05
0.305187	-0.071196	-0.0178531	9.96E-05	0.000247	3.49E-05
0.304795	-0.0725369	-0.0178957	0.000101425	0.000246796	3.44E-05
0.321166	-0.0699883	-0.0192837	9.35E-05	0.000256664	0.000120891
0.32082	-0.0712544	-0.0198232	8.94E-05	0.000258071	0.000124433
0.320269	-0.0727708	-0.0186927	8.89E-05	0.000257276	0.000125904
0.320002	-0.073951	-0.0198185	9.08E-05	0.000258206	0.000125965
0.319526	-0.0753605	-0.0193735	9.27E-05	0.000256397	0.000126153
0.319092	-0.0767457	-0.0191219	9.19E-05	0.00025679	0.000127557
0.335451	-0.0742421	-0.0202781	8.65E-05	0.000263422	0.00021708
0.335083	-0.0755585	-0.0205219	8.33E-05	0.000263807	0.000221222
0.33467	-0.0768984	-0.0205702	8.22E-05	0.000263902	0.000224992
0.334271	-0.0782241	-0.0207153	8.33E-05	0.000265537	0.000226432
0.333805	-0.0796384	-0.0202693	8.39E-05	0.000264807	0.000226587
0.333382	-0.080975	-0.0202129	8.50E-05	0.000264135	0.000228205
0.349866	-0.078392	-0.0219161	7.86E-05	0.000266582	0.000305527
0.349333	-0.0798453	-0.0211828	7.62E-05	0.000266273	0.000309689
0.349023	-0.0811083	-0.0218171	7.46E-05	0.000264647	0.000316427
0.348549	-0.0825048	-0.0214728	7.51E-05	0.000268081	0.000319196
0.348165	-0.083837	-0.0216151	7.64E-05	0.000271073	0.00031803
0.347632	-0.0852866	-0.0208763	7.72E-05	0.000271382	0.000317591
0.364185	-0.0826645	-0.0228343	6.73E-05	0.000265362	0.000381711
0.363642	-0.084117	-0.022102	6.63E-05	0.000263362	0.00038474
0.363304	-0.0854104	-0.0225403	6.68E-05	0.000262575	0.000390786
0.362798	-0.0868176	-0.021998	6.72E-05	0.0002645	0.0003945
0.362538	-0.0880443	-0.0229232	6.72E-05	0.000270161	0.00039556
0.361996	-0.0894935	-0.0221856	6.70E-05	0.000272033	0.0003956
0.37856	-0.0869033	-0.0240087	5.85E-05	0.000263155	0.000441296
0.378058	-0.0883154	-0.0235708	5.72E-05	0.000261305	0.000444499
0.377627	-0.0896751	-0.0234196	5.71E-05	0.000260001	0.000448347
0.377274	-0.0909669	-0.0238586	5.70E-05	0.000260549	0.000451755
0.376888	-0.0923034	-0.0240012	5.65E-05	0.000264317	0.000453536
0.376473	-0.0936315	-0.024044	5.62E-05	0.000266743	0.000456189
0.392845	-0.0912296	-0.0245602	5.29E-05	0.000259077	0.000477732

0.392528	-0.0924982	-0.0251967	5.04E-05	0.000255022	0.000482247
0.392006	-0.0939245	-0.024558	4.83E-05	0.000254143	0.000485461
0.391654	-0.0952195	-0.0249971	4.80E-05	0.000254664	0.000488415
0.391185	-0.0965879	-0.0247486	4.77E-05	0.000259821	0.000492502
0.390884	-0.0978627	-0.0253784	4.78E-05	0.00026268	0.000496614
0.407354	-0.0954076	-0.0262452	4.69E-05	0.000248488	0.000491629
0.406802	-0.0968462	-0.0256144	4.42E-05	0.000244423	0.000496318
0.406402	-0.0981656	-0.0257591	4.16E-05	0.000243069	0.000497972
0.406031	-0.099494	-0.0260008	3.96E-05	0.000242841	0.000501928
0.405485	-0.100914	-0.025363	3.96E-05	0.000247502	0.000507642
0.40528	-0.102112	-0.0265799	3.99E-05	0.000249671	0.000511622
0.421715	-0.0997106	-0.0271184	4.02E-05	0.000232575	0.000487633
0.421352	-0.101008	-0.0274594	3.87E-05	0.00023334	0.000490192
0.420832	-0.102422	-0.0269204	3.58E-05	0.000232303	0.000491613
0.42033	-0.103822	-0.0265804	3.27E-05	0.000229376	0.000497358
0.420081	-0.105046	-0.0275022	3.14E-05	0.000230985	0.000501737
0.419771	-0.106324	-0.0280309	3.11E-05	0.000234049	0.000505291
0.436296	-0.103883	-0.0289239	3.65E-05	0.000215733	0.000461039
0.435793	-0.10527	-0.0285846	3.35E-05	0.000216424	0.000464344
0.435345	-0.106636	-0.0284358	3.11E-05	0.000213815	0.000467985
0.434777	-0.108073	-0.0278052	2.78E-05	0.000211689	0.000474614
0.434653	-0.10923	-0.0293099	2.70E-05	0.000213841	0.000478732
0.434246	-0.110572	-0.029352	2.65E-05	0.000218551	0.000478113
0.450746	-0.10815	-0.0300134	3.34E-05	0.000196101	0.000414004
0.449982	-0.109697	-0.0285134	3.09E-05	0.000194538	0.00041882
0.449782	-0.110922	-0.0295301	2.88E-05	0.000192303	0.000423485
0.449293	-0.112296	-0.0292865	2.55E-05	0.000189738	0.000428687
0.448867	-0.113635	-0.0293329	2.36E-05	0.000192264	0.000433666
0.448541	-0.114932	-0.0297638	2.29E-05	0.000195572	0.000441343
0.465067	-0.112509	-0.0304903	2.88E-05	0.000163704	0.000355193
0.464786	-0.113787	-0.0311194	2.80E-05	0.00016522	0.000358777
0.464423	-0.115094	-0.0314597	2.65E-05	0.000166805	0.000361782
0.463707	-0.116602	-0.0301478	2.35E-05	0.000168349	0.000365238
0.463431	-0.117863	-0.0308735	2.10E-05	0.000172096	0.000372791
0.479626	-0.116764	-0.0318994	2.36E-05	0.000127989	0.000281658
0.479151	-0.118131	-0.0317571	2.22E-05	0.000127886	0.00028317
0.478894	-0.119401	-0.0324815	2.02E-05	0.000130224	0.000285102
0.478423	-0.120752	-0.0323338	1.85E-05	0.000132845	0.00028776
0.477948	-0.122118	-0.032188	1.85E-05	0.000141122	0.000296401
0.494106	-0.121072	-0.0328869	2.15E-05	0.000102406	0.000201348
0.493678	-0.122402	-0.0329358	2.00E-05	0.000100031	0.000202544
0.493128	-0.123804	-0.0325034	1.73E-05	9.99E-05	0.000208386
0.492735	-0.125144	-0.0326462	1.69E-05	0.000101047	0.000212679
0.492442	-0.126426	-0.0332743	1.70E-05	0.000107577	0.000219431
0.499317	-0.128488	-0.0335891	1.61E-05	8.69E-05	0.000179261
0.498785	-0.129803	-0.0330357	1.61E-05	8.62E-05	0.00018358
0.492037	-0.127671	-0.0333035	1.66E-05	0.000111209	0.000223018
0.499719	-0.12713	-0.0335473	1.67E-05	8.86E-05	0.000174257
0.50021	-0.125746	-0.0338935	1.72E-05	9.09E-05	0.000170402
0.500414	-0.12449	-0.0329771	1.90E-05	9.04E-05	0.000164752
0.50072	-0.123175	-0.0325458	2.01E-05	8.70E-05	0.000162803
0.494175	-0.120235	-0.0319453	2.19E-05	0.000103327	0.000203863

0.500989	-0.122216	-0.0324737	2.03E-05	8.65E-05	0.000164501
0.477457	-0.123461	-0.0318351	1.81E-05	0.000145942	0.000299082
0.47976	-0.115931	-0.0312529	2.37E-05	0.000128459	0.000284404
0.46305	-0.119165	-0.0311104	2.01E-05	0.000173835	0.000369055
0.465342	-0.111648	-0.0304277	2.87E-05	0.000163299	0.000358045
0.458171	-0.117912	-0.029777	2.15E-05	0.000185254	0.000416027
0.448531	-0.114965	-0.0297698	2.29E-05	0.000197044	0.000444727
0.450949	-0.107359	-0.0297691	3.43E-05	0.000195278	0.000417404
0.434088	-0.110722	-0.028683	2.63E-05	0.000219768	0.000481478
0.436394	-0.103173	-0.0281966	3.71E-05	0.000216067	0.000463458
0.419648	-0.106485	-0.0275618	3.12E-05	0.000235358	0.000507647
0.421809	-0.0990373	-0.0263966	4.05E-05	0.000233479	0.000487331
0.405224	-0.102258	-0.0265062	3.99E-05	0.000250719	0.000514921
0.40742	-0.0948001	-0.0254344	4.75E-05	0.000251543	0.00049063
0.390838	-0.0980285	-0.0254082	4.81E-05	0.000263163	0.000497024
0.39303	-0.0905668	-0.0244377	5.42E-05	0.000261461	0.000475034
0.376396	-0.0938595	-0.023985	5.66E-05	0.000267554	0.00045548
0.378703	-0.0863015	-0.023697	5.93E-05	0.000263299	0.000439405
0.361942	-0.0897277	-0.0223281	6.72E-05	0.000271556	0.000394814
0.364398	-0.0820288	-0.0230175	6.80E-05	0.000265973	0.000381076
0.347524	-0.0855938	-0.020731	7.84E-05	0.000271236	0.000316845
0.349854	-0.0780022	-0.0207384	7.97E-05	0.000265701	0.000304206
0.333276	-0.0813179	-0.0201744	8.65E-05	0.000264002	0.000228351
0.335582	-0.0737655	-0.0199857	8.75E-05	0.000260289	0.000215665
0.319082	-0.0770081	-0.0198744	9.30E-05	0.000255144	0.000127754
0.32126	-0.0695557	-0.0189008	9.51E-05	0.000253207	0.000118553
0.304825	-0.0727739	-0.0191487	0.000101826	0.000243987	3.35E-05
0.306917	-0.0654174	-0.0174857	0.000100388	0.00023784	3.14E-05
0.290401	-0.0687473	-0.016909	0.000108565	0.000229476	8.78E-05
0.292686	-0.061186	-0.0168202	0.000102096	0.000224927	9.92E-05
0.276151	-0.0645782	-0.0158114	0.000110341	0.000211668	0.00018724
0.278402	-0.0570174	-0.0156235	0.000103895	0.000212423	0.000199693
0.261999	-0.0602443	-0.0156573	0.000110383	0.000200381	0.000283828
0.264285	-0.0526425	-0.0157634	0.000104764	0.000196289	0.000292309
0.247796	-0.0560073	-0.0149766	0.000110283	0.000187901	0.000368738
0.250042	-0.0484559	-0.0147883	0.000105328	0.000181377	0.000370579
0.233562	-0.0518915	-0.0136698	0.000108209	0.000165921	0.00043162
0.235747	-0.0444432	-0.0127909	0.000104136	0.000166351	0.000439526
0.219367	-0.0477191	-0.0126174	0.000104617	0.000144081	0.000478794
0.221558	-0.0402057	-0.0121325	9.92E-05	0.000148685	0.000492907
0.205177	-0.0435527	-0.011527	9.91E-05	0.000126351	0.000508902
0.207384	-0.0360307	-0.0112418	8.97E-05	0.00012299	0.000515701
0.191056	-0.0393006	-0.0110907	9.13E-05	0.000108696	0.000516312
0.193232	-0.0317919	-0.0106052	7.96E-05	0.000105534	0.000517583
0.176888	-0.0351297	-0.0101243	8.17E-05	9.34E-05	0.000508053
0.179039	-0.027767	-0.00885146	7.05E-05	9.42E-05	0.000507996
0.162761	-0.0310103	-0.00892354	7.17E-05	7.81E-05	0.000478711
0.164959	-0.0234054	-0.00902785	6.07E-05	8.11E-05	0.000480909
0.148675	-0.0267247	-0.00867007	6.13E-05	6.07E-05	0.000430968
0.150835	-0.0191832	-0.00837925	5.27E-05	6.58E-05	0.000445702
0.134559	-0.0225244	-0.00798791	5.15E-05	4.64E-05	0.00037082
0.139141	-0.0157262	-0.00769083	4.95E-05	5.93E-05	0.000424317

0.13674	-0.0148406	-0.00848311	4.48E-05	4.93E-05	0.000376935
0.120467	-0.0183346	-0.00716752	4.11E-05	3.15E-05	0.000300819
0.122607	-0.0107698	-0.00707397	3.70E-05	3.78E-05	0.000309975
0.106371	-0.0140376	-0.00700114	3.33E-05	2.02E-05	0.000231628
0.108519	-0.00647182	-0.00690642	2.95E-05	2.56E-05	0.000235629
0.0922843	-0.0098008	-0.00650293	2.84E-05	9.45E-06	0.000158045
0.0944177	-0.00213556	-0.0068973	2.45E-05	1.34E-05	0.000159948
0.0781988	-0.00554835	-0.00616768	2.47E-05	1.02E-05	9.20E-05
0.080319	0.00212408	-0.00655965	2.17E-05	1.00E-05	9.07E-05
0.0640985	-0.00113142	-0.00657789	2.34E-05	1.25E-05	3.77E-05
0.0662309	0.00634098	-0.0059892	2.06E-05	1.23E-05	3.82E-05
0.0500456	0.00303371	-0.00577843	2.31E-05	1.59E-05	7.23E-06
0.0521121	0.0107512	-0.00636205	2.17E-05	1.50E-05	7.50E-06
0.0456893	0.00531499	-0.00443386	2.24E-05	1.70E-05	1.09E-05
0.045296	0.00461118	-0.00639316	2.33E-05	1.59E-05	1.07E-05
0.0459978	0.00698273	-0.00605411	2.26E-05	1.77E-05	1.11E-05
0.0463818	0.00822609	-0.00551573	2.24E-05	1.70E-05	1.10E-05
0.0467738	0.0095038	-0.00517376	2.22E-05	1.62E-05	1.10E-05
0.0471127	0.0110382	-0.00610388	2.17E-05	1.78E-05	1.15E-05
0.0474359	0.0120331	-0.00550763	2.14E-05	1.88E-05	1.13E-05

Source File beam1lb_45deg_fastFixed_150Hz
Name:
Signal: FFT - Vib 3D Velocity - Magnitude
dB-Reference: 0 dB = 1 m/s
Band No.: 1
Frequency: 150.0 Hz

Interpolated: Yes
Filtered: Yes

X	Y	Z	Mag X	Mag Y	Mag Z
0.0583837	0.0206458	-0.0072461	6.66E-06	7.04E-05	0.00017363
0.0584315	0.0194134	-0.0074182	7.74E-06	7.34E-05	0.000164628
0.0585997	0.0178282	-0.006661	1.16E-05	7.26E-05	0.000161987
0.0585877	0.0167929	-0.0072866	1.76E-05	6.25E-05	0.00015809
0.058758	0.0152336	-0.0066255	2.54E-05	6.19E-05	0.000155847
0.0586861	0.0143666	-0.007716	2.76E-05	6.42E-05	0.000156383
0.0588427	0.0128084	-0.0070504	2.91E-05	7.34E-05	0.00015637
0.0589513	0.0113966	-0.0067527	2.90E-05	7.67E-05	0.000165578
0.0705702	0.0203592	-0.0069374	4.08E-06	9.48E-05	0.000281979
0.0705931	0.0192016	-0.007293	3.82E-06	9.53E-05	0.000279164
0.0706967	0.0178244	-0.0070948	1.09E-05	9.43E-05	0.000279894
0.0708199	0.016351	-0.0066111	1.57E-05	8.82E-05	0.000279354
0.0707765	0.0154129	-0.0075177	2.25E-05	8.76E-05	0.000280092
0.0708665	0.0140366	-0.0073139	2.59E-05	9.17E-05	0.000281263
0.0710372	0.0124438	-0.0065551	3.27E-05	0.000100225	0.000285771
0.0709941	0.0115045	-0.0074587	3.47E-05	0.00010714	0.000291488
0.0826862	0.0203511	-0.0073642	9.83E-06	0.000149555	0.000456972
0.082749	0.019047	-0.0073494	1.35E-05	0.000149734	0.000455271

0.0828222	0.0177067	-0.0072408	2.16E-05	0.000145974	0.000455372
0.0827832	0.016783	-0.0081431	2.55E-05	0.000138042	0.000454983
0.0828909	0.0153704	-0.0078484	3.00E-05	0.000134895	0.000456632
0.0830153	0.0138491	-0.0072731	3.23E-05	0.000134	0.000456745
0.0831296	0.0123655	-0.0067887	4.18E-05	0.000141516	0.000459612
0.0830707	0.0114996	-0.0078775	4.66E-05	0.000146713	0.000465709
0.0947553	0.0205235	-0.0082428	2.33E-05	0.000200106	0.000653457
0.0948229	0.0191827	-0.0081347	2.51E-05	0.000196759	0.000650606
0.094807	0.0181728	-0.0088583	3.35E-05	0.00019713	0.000651409
0.094898	0.0168097	-0.0086511	3.98E-05	0.00020193	0.000684367
0.0949937	0.0153604	-0.0082613	5.07E-05	0.000203684	0.000686946
0.0950431	0.0140945	-0.0083331	5.05E-05	0.000191461	0.000692909
0.0950647	0.0129247	-0.008687	5.66E-05	0.000192472	0.0006576
0.0952302	0.0112604	-0.0077377	5.85E-05	0.000194524	0.000660086
0.106978	0.0190707	-0.0082578	3.72E-05	0.000253335	0.000831408
0.106982	0.0179882	-0.0087958	4.51E-05	0.000269875	0.000901291
0.107016	0.0168323	-0.0091486	5.74E-05	0.00028353	0.000966646
0.107087	0.0154564	-0.008943	7.16E-05	0.000285196	0.00100751
0.107224	0.0137895	-0.007994	7.22E-05	0.000272362	0.000982476
0.107161	0.0129846	-0.0092748	7.31E-05	0.000270854	0.000918493
0.107263	0.0115382	-0.0088805	7.39E-05	0.000273171	0.000882187
0.119085	0.0192362	-0.0091173	5.48E-05	0.000337843	0.00110558
0.119141	0.0178965	-0.0090061	5.70E-05	0.000335886	0.00107909
0.119124	0.016924	-0.0098209	6.67E-05	0.000340085	0.00111441
0.119091	0.0160236	-0.0108206	7.99E-05	0.000335738	0.00112095
0.119237	0.0143194	-0.0097788	8.62E-05	0.000342182	0.00115491
0.119331	0.0127858	-0.0092034	9.53E-05	0.000334616	0.0010942
0.119306	0.0118481	-0.0101071	9.87E-05	0.000335552	0.00109392
0.131146	0.0196551	-0.0106146	7.59E-05	0.000443584	0.00133388
0.131211	0.0183283	-0.0104986	8.39E-05	0.000451236	0.00130289
0.131236	0.0171219	-0.0107621	9.36E-05	0.000437815	0.00128535
0.131268	0.0158921	-0.0109264	0.000100604	0.000426492	0.00131815
0.131345	0.0143935	-0.0104446	0.000111171	0.0004251	0.00134239
0.131398	0.0131284	-0.0105142	0.000120247	0.000411835	0.0013123
0.13143	0.0118996	-0.0106746	0.000121097	0.000399564	0.00128648
0.143336	0.0195916	-0.0108974	9.14E-05	0.000500605	0.00148584
0.143371	0.0183383	-0.0109655	9.89E-05	0.000502152	0.00145855
0.143377	0.017242	-0.0115071	0.000111539	0.000493506	0.00145991
0.143406	0.0160121	-0.011671	0.000116347	0.000480052	0.00146568
0.143461	0.0146962	-0.0116537	0.000124353	0.000494002	0.00149015
0.143484	0.0135031	-0.0119081	0.000132085	0.000482379	0.00145722
0.143569	0.0119101	-0.0111383	0.00013387	0.000482682	0.00145511
0.155513	0.0185644	-0.0119782	0.000109243	0.000556549	0.00158424
0.155553	0.0172109	-0.0118694	0.000122609	0.00056123	0.00160605
0.155607	0.0158715	-0.0117546	0.00012868	0.00055624	0.00159956
0.155638	0.0145923	-0.0118289	0.000135189	0.000560201	0.00159452
0.155641	0.0135452	-0.0124548	0.000145702	0.000556522	0.00158488
0.155681	0.0121933	-0.0123407	0.000151872	0.00056095	0.00159254
0.167681	0.0187492	-0.012887	0.000132151	0.000648049	0.00171464
0.167716	0.0173952	-0.0127779	0.000140169	0.000639217	0.00170749
0.167727	0.0164214	-0.0135924	0.00014588	0.00063764	0.0016996
0.16781	0.014593	-0.0122715	0.000150724	0.000641565	0.00169382

0.167838	0.0133273	-0.0123389	0.000164059	0.000638786	0.00169387
0.167875	0.0120851	-0.0125038	0.000172255	0.000643387	0.00170995
0.179864	0.0190395	-0.0140631	0.00014832	0.00072602	0.00176991
0.179899	0.0176247	-0.0137626	0.000153428	0.000726992	0.00177301
0.179928	0.0164539	-0.0141172	0.000159194	0.000724703	0.00177195
0.179957	0.0151001	-0.0140052	0.00016815	0.000728385	0.001768
0.179989	0.0137238	-0.0137934	0.000180289	0.000723386	0.00176518
0.180001	0.0125894	-0.0142372	0.000189809	0.000741838	0.00177856
0.192072	0.019435	-0.0155063	0.000156298	0.000800966	0.00175734
0.192078	0.0184227	-0.0162288	0.000158232	0.000806275	0.00176693
0.192105	0.0169935	-0.0159323	0.000165424	0.00081512	0.00177365
0.192171	0.0150907	-0.0144245	0.000177601	0.000817442	0.00178226
0.192178	0.0140786	-0.0151435	0.000189055	0.000810845	0.00177784
0.192188	0.0129795	-0.0156805	0.000195173	0.000810617	0.00178427
0.192217	0.0115307	-0.0152796	0.000198795	0.000806314	0.00178384
0.204305	0.0197518	-0.0167512	0.00016294	0.000863489	0.00171086
0.204326	0.0182617	-0.0162645	0.000164634	0.000873684	0.00171192
0.204338	0.0171253	-0.0167121	0.00016965	0.000894061	0.00172927
0.204375	0.0155871	-0.0161347	0.000182785	0.000895658	0.00173949
0.204386	0.0145007	-0.0166677	0.000189853	0.000885424	0.00174932
0.204405	0.0131096	-0.0164597	0.000195715	0.000876736	0.00174978
0.204434	0.0118777	-0.0166179	0.000199446	0.000874175	0.00174775
0.216586	0.0182786	-0.0167525	0.000166175	0.000927039	0.001648
0.216598	0.017398	-0.0178514	0.000172062	0.000953452	0.00163419
0.21661	0.0159816	-0.017548	0.000179476	0.000961635	0.00164106
0.216622	0.0148077	-0.0179002	0.000185753	0.00095461	0.00165177
0.216648	0.0135609	-0.018065	0.000192107	0.000947451	0.0016612
0.21666	0.0121464	-0.0177573	0.000194982	0.000944592	0.00166005
0.228854	0.0188767	-0.0187161	0.000154602	0.00101714	0.00149756
0.228876	0.0175917	-0.0187916	0.000157901	0.00102198	0.00149606
0.228884	0.016284	-0.0187675	0.000168733	0.00102044	0.00149947
0.228893	0.0150361	-0.0189336	0.000174312	0.00101994	0.00150828
0.228903	0.0137884	-0.0190985	0.000183625	0.00101805	0.00151719
0.228926	0.012554	-0.0192569	0.0001843	0.0010157	0.0015181
0.241166	0.0195419	-0.0208525	0.000129542	0.00108477	0.00130045
0.241154	0.017926	-0.0200911	0.000135673	0.00107925	0.00130451
0.241182	0.0168357	-0.0206257	0.000145269	0.00107904	0.00131159
0.241173	0.015295	-0.0200473	0.000158395	0.00107301	0.00131118
0.241173	0.0139009	-0.0198397	0.000167698	0.0010686	0.00131322
0.241174	0.0125572	-0.0197187	0.000167361	0.00107883	0.00127997
0.253509	0.0198346	-0.0220447	0.000115831	0.00113586	0.00106951
0.253502	0.0184502	-0.0218368	0.0001176	0.00113441	0.00107287
0.253486	0.0169437	-0.0213534	0.000124611	0.00113939	0.00108188
0.253468	0.0154022	-0.0207752	0.000136997	0.00113633	0.00108382
0.25351	0.0144923	-0.0217732	0.000149031	0.00113511	0.00108372
0.2535	0.0130608	-0.0214716	0.000151248	0.00113212	0.00109118
0.253492	0.0116665	-0.0212617	0.000153719	0.00113646	0.00109643
0.265797	0.0181877	-0.0216203	9.46E-05	0.00118639	0.000860656
0.265861	0.0175557	-0.0233703	9.22E-05	0.00119979	0.000824017
0.265858	0.016121	-0.0230717	0.000106811	0.00119409	0.00082525
0.265851	0.0148098	-0.0230462	0.000114838	0.00119319	0.000831728
0.265822	0.0132685	-0.0224657	0.00011823	0.00119242	0.000838619

0.265855	0.012211	-0.0230891	0.000120151	0.00119872	0.000844995
0.27828	0.0193792	-0.0251101	4.90E-05	0.00123923	0.000523452
0.278237	0.0177966	-0.0244422	5.24E-05	0.00123721	0.000524434
0.278249	0.0165557	-0.0246041	6.63E-05	0.0012363	0.000532686
0.278219	0.0150844	-0.0242121	7.39E-05	0.00123624	0.000545427
0.27824	0.0140252	-0.0248376	7.36E-05	0.00123143	0.000551971
0.278243	0.0128076	-0.0250948	7.00E-05	0.00124743	0.000505736
0.290708	0.0196875	-0.0263525	1.61E-05	0.00126834	0.000214521
0.290687	0.0183353	-0.026238	1.74E-05	0.00126417	0.000214152
0.290677	0.0170429	-0.0263135	2.33E-05	0.00125861	0.000215902
0.290666	0.0157507	-0.0263876	2.62E-05	0.00126865	0.000231384
0.290687	0.0145803	-0.0267338	2.85E-05	0.00126809	0.000237557
0.290604	0.0128199	-0.0255949	3.22E-05	0.00127602	0.000245593
0.290654	0.0119383	-0.0266843	2.92E-05	0.00128424	0.000194236
0.303136	0.0187449	-0.0277461	2.06E-05	0.00129289	4.97E-05
0.30313	0.0174139	-0.0277285	2.20E-05	0.0012956	0.000104652
0.303141	0.0162781	-0.0281701	2.11E-05	0.00129631	9.66E-05
0.303082	0.0147314	-0.0275925	1.97E-05	0.00129114	8.65E-05
0.303114	0.0136313	-0.0281239	1.72E-05	0.00128872	0.000129367
0.303099	0.0123379	-0.0281949	3.12E-05	0.00130414	0.000217788
0.315709	0.0195465	-0.0302602	7.65E-05	0.00132126	0.000434775
0.315639	0.0179363	-0.029495	7.39E-05	0.00132111	0.000435153
0.315643	0.0167485	-0.0298496	7.25E-05	0.00132416	0.000430376
0.315551	0.0151052	-0.028989	7.01E-05	0.0013136	0.000412715
0.315562	0.013954	-0.029434	6.42E-05	0.0013103	0.00040259
0.315632	0.0130308	-0.0304299	6.53E-05	0.00131923	0.000436066
0.315518	0.0112696	-0.0292907	7.12E-05	0.00132237	0.000442058
0.328149	0.0195557	-0.0307102	0.000114789	0.00131231	0.000756867
0.328136	0.0182935	-0.0308809	0.000114786	0.00131767	0.000757025
0.328162	0.0171528	-0.0313225	0.000121624	0.00132665	0.000757846
0.328165	0.0159626	-0.0316766	0.000125151	0.00132893	0.000738319
0.328143	0.0146779	-0.0317455	0.000118567	0.00133076	0.000725396
0.328037	0.0130349	-0.0308833	0.000105465	0.00133892	0.000706453
0.328029	0.0117376	-0.0309535	0.000123931	0.00133511	0.000748603
0.340769	0.019018	-0.0331727	0.000156418	0.00130822	0.00100103
0.340753	0.0177529	-0.0333433	0.000170915	0.00131647	0.0010461
0.340728	0.0164656	-0.0334144	0.000170469	0.00132617	0.00103699
0.340596	0.0147114	-0.0322757	0.000166535	0.00132833	0.00102914
0.34057	0.0134121	-0.0323492	0.000153046	0.00132814	0.00100427
0.340544	0.0121267	-0.0324161	0.000160352	0.00132569	0.000994625
0.340579	0.0110193	-0.0329453	0.000181511	0.00132591	0.00103576
0.353439	0.019721	-0.0354538	0.000219972	0.00130754	0.00132946
0.353342	0.0181419	-0.0347843	0.00021867	0.00131538	0.00132514
0.353354	0.0169962	-0.0352275	0.00021502	0.00132286	0.00131658
0.353192	0.0152269	-0.0340974	0.000211324	0.00132243	0.00130225
0.353152	0.013903	-0.0340738	0.000203892	0.00132005	0.00127823
0.353208	0.0128644	-0.0347905	0.000205961	0.00131844	0.00126393
0.353148	0.0114694	-0.0345787	0.000216851	0.00131832	0.00125938
0.353148	0.0102747	-0.0349283	0.00022634	0.00131029	0.00128351
0.366037	0.0200326	-0.0366931	0.000254105	0.00130538	0.00154978
0.365971	0.0186322	-0.0364898	0.000254311	0.00130373	0.00153971
0.365986	0.0174472	-0.0368396	0.000252468	0.001302	0.00153065

0.365964	0.0161774	-0.0370097	0.000252483	0.0012931	0.00151773
0.365886	0.0147428	-0.0367095	0.000250718	0.0012978	0.0015019
0.365852	0.0134516	-0.0367789	0.000253041	0.00130643	0.00149024
0.365789	0.0120179	-0.0364744	0.000260513	0.00130306	0.00151512
0.365788	0.0108341	-0.0368196	0.000276691	0.00128464	0.00156387
0.378608	0.0189699	-0.0378065	0.000279311	0.00128446	0.00168775
0.378631	0.0178412	-0.038349	0.000285239	0.00127593	0.00171121
0.378534	0.0163681	-0.0379591	0.0002862	0.00127091	0.00169818
0.378572	0.0152521	-0.0384925	0.000287849	0.00127382	0.0016898
0.378546	0.0139939	-0.0386558	0.000293036	0.00128428	0.0016736
0.378425	0.0124518	-0.0380762	0.000296482	0.00128114	0.00166673
0.378375	0.0111236	-0.0380514	0.000307041	0.00126316	0.00168885
0.378448	0.0101133	-0.0388586	0.000314019	0.00125588	0.00170008
0.391627	0.0203275	-0.041796	0.000318648	0.0012364	0.0018573
0.391407	0.0184911	-0.0404835	0.000319588	0.00123642	0.00185668
0.391379	0.0172294	-0.0406506	0.000319866	0.00123346	0.00184641
0.391248	0.0156828	-0.0400761	0.000320661	0.00123966	0.00183738
0.391259	0.0145286	-0.0405183	0.000327244	0.00124774	0.0018288
0.391219	0.0131961	-0.0404947	0.000330792	0.00124485	0.00181848
0.3911	0.0116878	-0.0400082	0.00034015	0.00123557	0.00181538
0.391201	0.0107807	-0.0410955	0.000349847	0.00120653	0.00181904
0.404153	0.0189902	-0.042233	0.000337436	0.00119176	0.00191788
0.404192	0.0178675	-0.0427691	0.000341135	0.0011824	0.00191852
0.404106	0.0164605	-0.0425667	0.000344128	0.00118264	0.00190554
0.404048	0.015139	-0.0425423	0.000349592	0.00118796	0.00189517
0.40403	0.0139103	-0.0427995	0.000352896	0.00118583	0.00187378
0.403847	0.0122218	-0.0418507	0.000357756	0.00118243	0.00186028
0.403816	0.0109589	-0.0420126	0.000365133	0.00117004	0.00185831
0.403798	0.00973122	-0.0422658	0.00036911	0.00114287	0.00185416
0.416988	0.0184047	-0.0445899	0.000348789	0.00113122	0.00192527
0.416881	0.0169594	-0.0442969	0.000353095	0.00112211	0.0019105
0.416832	0.0156205	-0.0442775	0.000357613	0.00112173	0.0018939
0.416754	0.0142475	-0.0441662	0.000360276	0.00111204	0.0018698
0.416719	0.0129809	-0.0443309	0.000363794	0.00110991	0.00185731
0.416685	0.0117144	-0.0444943	0.000370582	0.0011093	0.00184987
0.416694	0.0105312	-0.0448342	0.0003768	0.00109921	0.00184539
0.41691	0.00985987	-0.0465678	0.000376687	0.00108107	0.00182779
0.429788	0.0188122	-0.0461205	0.000348842	0.00105155	0.0018684
0.429751	0.0175416	-0.0462903	0.000350421	0.00105204	0.00185705
0.429527	0.0158468	-0.0453523	0.000353727	0.00104835	0.00184829
0.429802	0.0152607	-0.0472648	0.000358739	0.00103432	0.00183556
0.429718	0.0138842	-0.0471544	0.000362225	0.00103017	0.00182833
0.429493	0.0121924	-0.0462117	0.000370948	0.00103181	0.00181762
0.429487	0.0110069	-0.0465547	0.000382126	0.00102616	0.00179437
0.429434	0.00970256	-0.0466247	0.000382311	0.00100145	0.00176288
0.4427	0.0182356	-0.0485388	0.000340836	0.000980603	0.00178211
0.442625	0.0168548	-0.0484306	0.000342094	0.000965678	0.00175724
0.442635	0.0156867	-0.0488759	0.000348986	0.000958966	0.00175303
0.442596	0.0144268	-0.0490384	0.000352255	0.000957372	0.00174048
0.44244	0.0129077	-0.0485597	0.000361959	0.000951586	0.00173007
0.442267	0.0113689	-0.0479818	0.000375518	0.000954561	0.00172076
0.442423	0.0104794	-0.049158	0.00037818	0.000940136	0.00169983

0.442449	0.00934553	-0.04969	0.000376737	0.000920629	0.00165461
0.455593	0.0186943	-0.0502222	0.000322484	0.000865551	0.00161438
0.455533	0.0173958	-0.0502966	0.000323773	0.000864099	0.00160645
0.455522	0.016153	-0.0505567	0.000330611	0.000861931	0.00159495
0.455532	0.0149952	-0.0509967	0.000335359	0.000862821	0.0015807
0.455402	0.0135432	-0.0507046	0.000343259	0.000858581	0.00157319
0.45522	0.0120013	-0.0501295	0.000359079	0.000857139	0.00156124
0.455191	0.0107245	-0.0502924	0.000361352	0.000839289	0.00152488
0.455217	0.00960172	-0.0508198	0.000358884	0.000810215	0.00145798
0.468553	0.0180322	-0.0524175	0.00030846	0.000787934	0.00145903
0.468471	0.0166814	-0.052406	0.000311092	0.000773982	0.00142393
0.468463	0.0154851	-0.0527552	0.000315053	0.000776173	0.00141111
0.468325	0.0140441	-0.0524601	0.000325397	0.000775673	0.0013994
0.468239	0.0126587	-0.0523502	0.00033781	0.00077363	0.0013841
0.468156	0.0113236	-0.052328	0.000346888	0.000765768	0.00136822
0.46811	0.0100584	-0.0524885	0.000346739	0.000748535	0.0013338
0.468302	0.00922879	-0.0538493	0.000344407	0.000743029	0.00126961
0.481422	0.0183451	-0.0536992	0.00027567	0.000663595	0.00120003
0.481407	0.0170954	-0.0539619	0.000280828	0.000661741	0.0011951
0.481301	0.0157211	-0.0538538	0.000284515	0.000664475	0.00118565
0.481253	0.0144519	-0.0540195	0.000293964	0.00066549	0.00117233
0.481128	0.0130438	-0.053817	0.000306487	0.000665652	0.00115686
0.48104	0.0117058	-0.0537966	0.000318228	0.000663218	0.00114915
0.481121	0.01063	-0.0545122	0.000323652	0.000661838	0.00109907
0.480976	0.00918868	-0.0542138	0.000312608	0.000620228	0.00100355
0.494667	0.0192446	-0.0565195	0.000232926	0.000536003	0.000948228
0.494516	0.017796	-0.0562321	0.000235682	0.000536959	0.000947622
0.494318	0.0162426	-0.0556658	0.000244592	0.000542561	0.000939395
0.494408	0.0151992	-0.0564797	0.000256283	0.000544234	0.000920584
0.494396	0.0139955	-0.0568294	0.000264998	0.000543493	0.000909707
0.494144	0.0123763	-0.0560782	0.000282917	0.000544236	0.000899535
0.494026	0.0109648	-0.0558725	0.000288682	0.000543737	0.000889629
0.494155	0.0100029	-0.0568604	0.000288397	0.000523929	0.000836123
0.494203	0.00890227	-0.0574806	0.000271668	0.000479433	0.000787476
0.507701	0.0185069	-0.0585786	0.000212654	0.000462395	0.000796113
0.50764	0.0171935	-0.0586551	0.000216798	0.0004443	0.000739056
0.507461	0.015708	-0.0582762	0.000229628	0.00044545	0.00072272
0.507385	0.0143967	-0.0583529	0.000238662	0.000445152	0.000709655
0.507562	0.0135	-0.0595261	0.000256026	0.000447623	0.000701865
0.50713	0.0116027	-0.058045	0.000265921	0.000449502	0.000690411
0.507236	0.0105664	-0.0588472	0.000270851	0.000450642	0.000679454
0.507055	0.00908454	-0.0584611	0.000257149	0.000420498	0.000669686
0.507691	0.00893742	-0.061646	0.000238728	0.000408433	0.000675213

Source File beam1b_neg15deg_fast_47.5Hz
Name:
Signal: FFT - Vib 3D Velocity - Magnitude
dB-Reference: 0 dB = 1 m/s
Band No.: 1
Frequency: 47.50 Hz

Interpolated: Yes
Filtered: Yes

X	Y	Z	Mag X	Mag Y	Mag Z
0.0660169	0.0257304	-0.0055982	1.22E-06	9.01E-07	5.02E-06
0.0789819	0.0261021	-0.0042086	1.65E-06	1.34E-06	8.79E-06
0.0790156	0.0240105	-0.0049404	1.47E-06	4.63E-07	1.15E-05
0.0660401	0.0236369	-0.0063297	1.21E-06	1.04E-06	5.18E-06
0.0790153	0.0217801	-0.0060444	1.35E-06	9.17E-07	1.20E-05
0.0661633	0.0222611	-0.0050883	1.34E-06	8.81E-07	5.90E-06
0.0791653	0.020681	-0.0040503	1.35E-06	5.47E-07	1.12E-05
0.0661496	0.0200109	-0.0061834	1.46E-06	1.03E-06	5.47E-06
0.0792035	0.0186027	-0.0046751	1.19E-06	1.20E-06	1.08E-05
0.0662398	0.0183953	-0.0055952	1.55E-06	2.05E-06	5.91E-06
0.0918655	0.0259455	-0.0043309	1.79E-06	4.47E-07	1.48E-05
0.0919586	0.0243499	-0.0036473	1.87E-06	9.16E-07	1.85E-05
0.0919997	0.0222237	-0.0044707	2.09E-06	1.33E-06	2.07E-05
0.0920845	0.020749	-0.0035078	1.76E-06	1.80E-06	2.09E-05
0.0921227	0.0185857	-0.0044204	1.40E-06	1.88E-06	2.13E-05
0.104799	0.0262484	-0.003135	1.90E-06	8.09E-07	2.41E-05
0.104866	0.0243298	-0.0033968	2.21E-06	2.59E-06	2.64E-05
0.104958	0.0227358	-0.0027112	2.60E-06	2.96E-06	2.75E-05
0.105003	0.0207473	-0.0031563	2.48E-06	3.62E-06	2.87E-05
0.105078	0.0189297	-0.0031304	1.91E-06	1.92E-06	2.92E-05
0.117716	0.0263461	-0.0025059	2.34E-06	2.60E-06	3.43E-05
0.117779	0.0245655	-0.0023914	2.31E-06	3.37E-06	3.74E-05
0.11786	0.0227845	-0.0022753	3.10E-06	4.81E-06	3.88E-05
0.11794	0.0209513	-0.0022447	3.05E-06	4.46E-06	3.96E-05
0.117995	0.0186518	-0.0035323	2.59E-06	2.62E-06	3.78E-05
0.130705	0.0246294	-0.0018589	2.94E-06	4.33E-06	4.73E-05
0.13077	0.022815	-0.0018361	3.69E-06	6.05E-06	4.80E-05
0.130859	0.0211722	-0.001342	3.94E-06	6.01E-06	4.85E-05
0.130943	0.0193396	-0.0013091	3.76E-06	4.02E-06	4.82E-05
0.143603	0.0248299	-0.0009533	3.82E-06	4.66E-06	6.02E-05
0.143692	0.0230166	-0.0009302	4.46E-06	6.87E-06	6.25E-05
0.143781	0.0213405	-0.0005296	4.51E-06	7.36E-06	6.30E-05
0.14385	0.0193364	-0.0009654	4.61E-06	5.29E-06	6.35E-05
0.14394	0.0177119	-0.0004737	4.72E-06	3.95E-06	6.14E-05
0.131001	0.0172301	-0.0021312	4.12E-06	2.25E-06	5.06E-05
0.156599	0.0231832	-0.0001209	5.39E-06	7.53E-06	7.14E-05
0.156673	0.0214736	0.00018625	5.44E-06	7.38E-06	7.09E-05
0.156767	0.0195394	-6.14E-05	5.49E-06	7.06E-06	7.18E-05
0.156859	0.0178122	0.00014932	5.50E-06	5.95E-06	6.86E-05
0.169493	0.0234179	0.00087345	6.06E-06	8.11E-06	8.01E-05
0.169591	0.0216061	0.00089951	5.96E-06	8.64E-06	8.21E-05
0.169669	0.0198283	0.00102117	5.87E-06	8.53E-06	8.36E-05
0.169768	0.0179809	0.00095736	5.84E-06	9.44E-06	8.05E-05
0.182372	0.0237038	0.00195231	6.29E-06	9.56E-06	8.59E-05
0.182486	0.021669	0.00142214	6.30E-06	9.18E-06	8.68E-05
0.18258	0.0199953	0.00182621	6.33E-06	9.48E-06	9.12E-05
0.182668	0.018114	0.0016689	6.31E-06	9.27E-06	8.89E-05
0.182774	0.0162319	0.00151407	6.24E-06	9.68E-06	8.59E-05

0.169856	0.0164106	0.00164577	5.83E-06	9.42E-06	7.83E-05
0.195339	0.0222132	0.00325572	6.51E-06	9.75E-06	9.42E-05
0.195449	0.0203687	0.00319101	6.85E-06	8.81E-06	9.38E-05
0.195558	0.0185234	0.00312835	7.08E-06	9.49E-06	9.41E-05
0.195649	0.0166772	0.00306727	6.85E-06	9.95E-06	9.29E-05
0.208187	0.0225844	0.00461675	6.98E-06	9.95E-06	0.000101136
0.208283	0.0207408	0.00455202	7.72E-06	1.03E-05	0.000103044
0.208405	0.0188449	0.00429601	7.91E-06	1.07E-05	0.000101481
0.208534	0.0168436	0.00386764	7.56E-06	1.16E-05	9.86E-05
0.22114	0.0211124	0.00591095	8.66E-06	1.07E-05	0.000111535
0.221263	0.0191135	0.00537377	8.77E-06	1.20E-05	0.000112201
0.221383	0.0172519	0.005321	8.75E-06	1.29E-05	0.00011776
0.221464	0.0157204	0.00610668	9.03E-06	1.25E-05	0.000118736
0.208638	0.015102	0.00409091	7.74E-06	1.03E-05	9.82E-05
0.233946	0.0216208	0.00764077	9.69E-06	1.21E-05	0.000128708
0.234106	0.0195543	0.00691773	9.74E-06	1.21E-05	0.000133291
0.234228	0.0175896	0.0065838	9.65E-06	1.34E-05	0.000133918
0.234353	0.0157457	0.0065274	9.42E-06	1.38E-05	0.000132165
0.246775	0.0218864	0.00871112	9.98E-06	1.37E-05	0.000131599
0.246951	0.0197861	0.00789562	1.10E-05	1.50E-05	0.00015026
0.247011	0.0182558	0.00867943	1.13E-05	1.59E-05	0.000155074
0.24717	0.0162222	0.00816213	1.12E-05	1.69E-05	0.000153058
0.259762	0.0200855	0.00905657	1.19E-05	1.94E-05	0.000169104
0.259851	0.0184868	0.00965477	1.23E-05	1.99E-05	0.000169078
0.260058	0.0162451	0.00857756	1.25E-05	2.05E-05	0.000167005
0.260115	0.0148203	0.00964699	1.28E-05	1.98E-05	0.000167166
0.247271	0.0145534	0.00857616	1.14E-05	1.77E-05	0.000155394
0.272534	0.0206262	0.0108702	1.24E-05	2.05E-05	0.000179549
0.272576	0.019167	0.0118416	1.28E-05	2.10E-05	0.000178934
0.272767	0.0170836	0.0111133	1.30E-05	2.17E-05	0.00017572
0.272959	0.0149808	0.0104334	1.29E-05	2.10E-05	0.000172278
0.285458	0.0190828	0.0119679	1.29E-05	2.06E-05	0.000178965
0.285563	0.0174162	0.0123821	1.29E-05	2.17E-05	0.000176294
0.285717	0.0155406	0.0122378	1.29E-05	2.19E-05	0.000178473
0.298188	0.0196561	0.0138667	1.28E-05	2.03E-05	0.000176765
0.298338	0.0177468	0.0136265	1.28E-05	2.06E-05	0.000173775
0.298488	0.0159066	0.0135766	1.33E-05	2.15E-05	0.000182696
0.298577	0.0142929	0.0141883	1.36E-05	2.10E-05	0.000192397
0.285804	0.013856	0.0126608	1.30E-05	2.11E-05	0.000181539
0.31111	0.0180758	0.0148674	1.16E-05	1.94E-05	0.000160744
0.311256	0.016271	0.0149119	1.24E-05	2.00E-05	0.000173252
0.311317	0.0147094	0.0156094	1.31E-05	2.04E-05	0.000185109
0.323751	0.0188019	0.0171221	1.01E-05	1.84E-05	0.000140001
0.323901	0.0169811	0.0171739	1.04E-05	1.87E-05	0.00014226
0.324064	0.0150718	0.0169401	1.14E-05	1.90E-05	0.000159868
0.324225	0.0132321	0.0168964	1.23E-05	1.94E-05	0.000168069
0.311568	0.0125192	0.0146326	1.43E-05	2.13E-05	0.000192539
0.336579	0.017497	0.0188638	9.93E-06	1.79E-05	0.000143634
0.336722	0.0157287	0.0190053	1.06E-05	1.82E-05	0.000153734
0.336837	0.0139943	0.0192398	1.15E-05	1.87E-05	0.000164217
0.349499	0.0158768	0.0197665	9.89E-06	1.75E-05	0.000147807
0.349622	0.0141778	0.0200971	1.00E-05	1.77E-05	0.000147088

0.349798	0.0122679	0.01987	1.13E-05	1.89E-05	0.000165917
0.337068	0.0119277	0.0186475	1.20E-05	1.96E-05	0.000174233
0.362144	0.0163881	0.0214454	8.46E-06	1.76E-05	0.000124778
0.362219	0.0148292	0.0221484	9.03E-06	1.84E-05	0.000136544
0.36247	0.0127811	0.0215533	1.00E-05	1.85E-05	0.000149837
0.374869	0.0152507	0.0236421	8.64E-06	1.82E-05	0.000144999
0.375116	0.0132381	0.0231417	9.81E-06	1.96E-05	0.000157574
0.375257	0.0115044	0.0233853	1.01E-05	1.97E-05	0.000152306
0.362602	0.0110111	0.0217008	9.60E-06	1.72E-05	0.000138249
0.387481	0.0157919	0.0254033	8.42E-06	1.81E-05	0.000147555
0.387662	0.0139189	0.0252728	8.59E-06	1.90E-05	0.000148916
0.387918	0.0119057	0.0247765	8.98E-06	1.94E-05	0.00015122
0.400335	0.0142828	0.0265657	6.28E-06	1.78E-05	0.000130368
0.400419	0.012654	0.0270864	6.50E-06	1.80E-05	0.000134582
0.40055	0.0109563	0.0274264	6.96E-06	1.63E-05	0.000133255
0.388089	0.0101017	0.024838	8.88E-06	1.81E-05	0.000147317
0.412764	0.0151137	0.0291504	4.47E-06	1.73E-05	0.000119803
0.41291	0.0133633	0.0292954	4.73E-06	1.70E-05	0.000131431
0.413214	0.0112806	0.0286203	5.25E-06	1.68E-05	0.000130737
0.425444	0.0139289	0.0311267	3.36E-06	1.76E-05	0.000127739
0.425642	0.012056	0.0310046	3.90E-06	1.61E-05	0.00012359
0.425858	0.0101833	0.0308874	4.50E-06	1.66E-05	0.000125167
0.413266	0.00972229	0.02933	6.04E-06	1.61E-05	0.000135232
0.43781	0.0147688	0.0336846	1.62E-06	1.59E-05	0.000119936
0.438201	0.0125481	0.0326454	1.64E-06	1.47E-05	0.000113252
0.438337	0.0108322	0.0328888	2.11E-06	1.30E-05	0.000112264
0.438575	0.008924	0.0326833	2.38E-06	1.21E-05	0.000110437
0.426171	0.00811574	0.0302127	4.70E-06	1.66E-05	0.000123393
0.450731	0.0129994	0.0341807	6.12E-07	1.12E-05	9.73E-05
0.450728	0.0115998	0.0352562	5.22E-07	1.10E-05	9.75E-05
0.451061	0.00951677	0.0345927	5.61E-07	1.01E-05	9.69E-05
0.463199	0.0135876	0.0360791	1.64E-06	1.12E-05	8.40E-05
0.463395	0.0117666	0.0360495	1.79E-06	9.79E-06	8.14E-05
0.463738	0.00970036	0.0353823	1.63E-06	9.31E-06	8.35E-05
0.463565	0.00858103	0.0371924	1.66E-06	1.04E-05	8.66E-05
0.451217	0.00776508	0.0347491	3.36E-07	1.06E-05	9.82E-05
0.475838	0.0123669	0.0379311	3.30E-06	7.53E-06	6.03E-05
0.475904	0.0107733	0.0385535	3.20E-06	6.76E-06	6.02E-05
0.476161	0.00888264	0.0383492	3.00E-06	8.59E-06	6.20E-05
0.488054	0.0132934	0.0407231	5.14E-06	6.11E-06	4.77E-05
0.488319	0.0113678	0.0404237	5.28E-06	4.99E-06	4.46E-05
0.488443	0.00972301	0.040862	4.84E-06	6.65E-06	4.64E-05
0.488904	0.00748022	0.039747	3.82E-06	7.62E-06	5.16E-05
0.476494	0.00684997	0.0377806	2.35E-06	9.76E-06	6.45E-05
0.500746	0.0119054	0.0422004	6.53E-06	3.03E-06	3.02E-05
0.500812	0.0103465	0.0428124	6.31E-06	4.90E-06	3.17E-05
0.501163	0.00831524	0.0422488	5.18E-06	5.62E-06	3.61E-05
0.513236	0.0108428	0.0444864	7.78E-06	4.34E-06	2.23E-05
0.5136	0.00877514	0.0438308	6.94E-06	3.73E-06	2.47E-05
0.513853	0.00693538	0.0437217	6.56E-06	3.36E-06	2.68E-05
0.501578	0.00614	0.041319	5.01E-06	5.85E-06	3.95E-05
0.514135	0.00515327	0.0438181	6.75E-06	2.00E-06	2.53E-05

0.514077	0.00499455	0.0439758	6.52E-06	2.48E-06	2.58E-05
0.513978	0.00509773	0.0442418	6.57E-06	3.33E-06	2.67E-05
0.514003	0.00521712	0.043982	6.66E-06	2.79E-06	2.66E-05
0.51398	0.0073126	0.0447027	7.04E-06	2.59E-06	2.42E-05
0.514182	0.00870863	0.0436635	7.41E-06	3.47E-06	2.09E-05
0.514219	0.00804868	0.0438166	7.24E-06	3.76E-06	2.25E-05
0.513928	0.0105652	0.0437679	7.90E-06	3.30E-06	1.99E-05
0.513088	0.0124014	0.0441834	8.02E-06	3.25E-06	2.10E-05
0.513648	0.0123355	0.0441203	8.05E-06	2.11E-06	1.79E-05
0.511373	0.00525963	0.0440109	6.15E-06	4.21E-06	3.03E-05
0.50134	0.00576826	0.0429425	4.99E-06	6.10E-06	4.07E-05
0.511279	0.0124786	0.0439519	7.21E-06	2.79E-06	2.52E-05
0.500465	0.013052	0.0430118	6.92E-06	2.55E-06	2.66E-05
0.48969	0.00586305	0.0403224	4.46E-06	6.61E-06	4.87E-05
0.48895	0.00597365	0.0404467	3.49E-06	7.50E-06	5.62E-05
0.488054	0.0132934	0.0407231	4.95E-06	7.23E-06	4.80E-05
0.476529	0.00619029	0.0379326	2.25E-06	9.40E-06	6.62E-05
0.475614	0.013529	0.0384231	3.30E-06	8.42E-06	5.99E-05
0.467951	0.0064482	0.0364998	1.93E-06	1.08E-05	7.82E-05
0.463798	0.00696642	0.0368782	1.44E-06	1.11E-05	9.26E-05
0.465117	0.0136749	0.0363229	2.13E-06	1.10E-05	7.60E-05
0.463163	0.0137603	0.0361151	1.56E-06	1.15E-05	8.47E-05
0.451198	0.00745468	0.0350822	4.83E-07	1.11E-05	9.87E-05
0.450468	0.014405	0.0349006	5.40E-07	1.18E-05	9.78E-05
0.44583	0.00765272	0.0343075	1.24E-06	1.06E-05	0.000102527
0.438609	0.00790335	0.0331886	2.68E-06	1.18E-05	0.000111353
0.44194	0.0142607	0.0324716	8.64E-07	1.45E-05	0.000112759
0.437793	0.0150281	0.0335832	1.59E-06	1.63E-05	0.000123007
0.426155	0.00799464	0.0303645	4.59E-06	1.71E-05	0.000123549
0.425359	0.0150708	0.0307881	3.36E-06	1.75E-05	0.000128255
0.424228	0.00769906	0.0290543	5.47E-06	1.79E-05	0.000128819
0.413613	0.00824059	0.0278947	6.24E-06	1.62E-05	0.000134334
0.418446	0.015351	0.0299155	4.22E-06	1.73E-05	0.000118997
0.412775	0.0154064	0.0287172	4.83E-06	1.73E-05	0.000115444
0.401923	0.00910645	0.027376	6.56E-06	1.52E-05	0.000132245
0.400692	0.00927408	0.0275478	7.09E-06	1.63E-05	0.000131711
0.400044	0.0160524	0.0274731	6.33E-06	1.75E-05	0.000123617
0.388138	0.00978308	0.0258307	8.29E-06	1.90E-05	0.000148124
0.388025	0.00975916	0.0257147	9.17E-06	1.86E-05	0.000152897
0.395082	0.0160774	0.0263565	7.96E-06	1.77E-05	0.000138799
0.387516	0.0161369	0.0247394	8.20E-06	1.77E-05	0.000141652
0.379547	0.00962267	0.0233163	9.62E-06	1.82E-05	0.000152603
0.375446	0.00987179	0.0230598	1.01E-05	1.92E-05	0.000149073
0.374667	0.0169847	0.0240397	7.88E-06	1.76E-05	0.000136499
0.362637	0.0105612	0.0218758	9.43E-06	1.67E-05	0.000132525
0.371547	0.0170689	0.0235648	7.92E-06	1.72E-05	0.000122744
0.36187	0.0176901	0.0229658	8.46E-06	1.64E-05	0.000124287
0.356139	0.0109499	0.0214017	9.72E-06	1.67E-05	0.000135203
0.349892	0.0110369	0.0201312	1.12E-05	1.90E-05	0.000160319
0.349245	0.0178713	0.0204933	9.09E-06	1.54E-05	0.000138459
0.337009	0.0118959	0.0194051	1.22E-05	2.04E-05	0.000176733
0.347947	0.0181346	0.0208758	9.13E-06	1.63E-05	0.000138756

0.336566	0.0182077	0.0183822	9.33E-06	1.79E-05	0.00013761
0.332892	0.0116644	0.0178255	1.25E-05	2.00E-05	0.000177787
0.324381	0.011876	0.0163495	1.32E-05	2.05E-05	0.000179664
0.324368	0.0189816	0.01766	9.60E-06	1.90E-05	0.00013569
0.311577	0.0124157	0.0147797	1.43E-05	2.19E-05	0.000190867
0.311066	0.0189607	0.0144266	1.14E-05	2.00E-05	0.000164043
0.309488	0.0127165	0.0150974	1.42E-05	2.13E-05	0.000186786
0.301187	0.0131177	0.0142343	1.36E-05	2.03E-05	0.000181847
0.298674	0.0131282	0.0138835	1.35E-05	2.10E-05	0.000187532
0.300164	0.0198378	0.0144151	1.26E-05	2.03E-05	0.000176972
0.305573	0.019395	0.0143555	1.18E-05	2.08E-05	0.000170126
0.298117	0.0199851	0.0143804	1.27E-05	2.01E-05	0.000178419
0.285872	0.0133521	0.0124268	1.31E-05	2.13E-05	0.000181472
0.285358	0.0202632	0.0123777	1.25E-05	2.02E-05	0.00017913
0.277091	0.0138361	0.0123676	1.32E-05	1.94E-05	0.000178398
0.272993	0.013731	0.0114382	1.32E-05	1.84E-05	0.000172409
0.273635	0.0205144	0.0105702	1.23E-05	2.02E-05	0.000180898
0.272527	0.0207304	0.010938	1.22E-05	1.95E-05	0.000178741
0.260124	0.0140911	0.0103478	1.29E-05	1.83E-05	0.000167136
0.259693	0.0210929	0.00921384	1.15E-05	1.80E-05	0.000162286
0.247248	0.0144675	0.00935518	1.16E-05	1.72E-05	0.00015593
0.246913	0.0218199	0.00853073	9.98E-06	1.49E-05	0.000133213
0.246769	0.0219383	0.00879838	9.62E-06	1.42E-05	0.000126311
0.239868	0.0140824	0.00713341	1.01E-05	1.55E-05	0.000138895
0.234389	0.0146156	0.00769794	9.08E-06	1.31E-05	0.000125317
0.23392	0.0223344	0.00716327	9.62E-06	1.24E-05	0.00012626
0.221512	0.014798	0.00613164	9.24E-06	1.21E-05	0.000123989
0.221054	0.0226443	0.00523695	8.78E-06	1.08E-05	0.000112165
0.215526	0.0147685	0.00513129	8.29E-06	1.11E-05	0.000107993
0.208609	0.0151018	0.00494393	7.55E-06	9.89E-06	9.43E-05
0.220196	0.022857	0.00565301	7.84E-06	1.06E-05	0.000105793
0.208172	0.0229874	0.0038288	6.88E-06	1.11E-05	0.000104459
0.218211	0.0228311	0.00514771	7.74E-06	1.16E-05	0.000106275
0.202486	0.0151044	0.00397561	7.78E-06	9.67E-06	9.66E-05
0.195715	0.0154225	0.00374799	7.43E-06	1.02E-05	9.65E-05
0.195277	0.0235539	0.00308199	6.50E-06	1.06E-05	9.81E-05
0.182788	0.0158469	0.00283043	6.59E-06	9.67E-06	8.81E-05
0.187531	0.0239614	0.00282925	6.36E-06	1.01E-05	9.08E-05
0.182358	0.0238792	0.00167483	6.15E-06	8.60E-06	8.50E-05
0.169854	0.0162707	0.00191083	5.89E-06	9.27E-06	7.95E-05
0.169428	0.0246167	0.00139272	5.72E-06	6.95E-06	7.91E-05
0.165173	0.016083	0.00064336	5.72E-06	8.27E-06	7.42E-05
0.15693	0.0166247	0.00080174	5.34E-06	5.76E-06	6.45E-05
0.156502	0.0252166	0.00073291	5.10E-06	6.12E-06	7.24E-05
0.143974	0.016632	-0.0012476	4.51E-06	3.38E-06	5.63E-05
0.154314	0.0252343	0.00039687	4.20E-06	4.78E-06	6.56E-05
0.143586	0.025491	-0.0007684	3.74E-06	4.10E-06	5.94E-05
0.131025	0.0172978	-0.0015169	4.04E-06	2.81E-06	4.83E-05
0.130636	0.0258862	-0.0019965	2.70E-06	3.58E-06	4.71E-05
0.127786	0.0174174	-0.0016305	3.67E-06	2.50E-06	4.47E-05
0.118064	0.0177727	-0.0022507	2.63E-06	2.41E-06	3.58E-05
0.121074	0.0266484	-0.0016109	2.52E-06	3.20E-06	3.79E-05

0.117717	0.0268965	-0.0015354	3.08E-06	3.38E-06	3.60E-05
0.108243	0.0178197	-0.0036555	2.33E-06	1.91E-06	2.84E-05
0.105104	0.0180737	-0.0032426	2.05E-06	1.12E-06	2.65E-05
0.104778	0.0264945	-0.0033302	2.05E-06	7.83E-07	2.39E-05
0.117236	0.0267808	-0.0019099	3.21E-06	2.88E-06	3.30E-05
0.0921406	0.018095	-0.0042406	1.59E-06	1.41E-06	2.09E-05
0.0918475	0.0263136	-0.0044639	1.65E-06	7.56E-07	1.34E-05
0.0792112	0.0184263	-0.0043973	1.48E-06	1.87E-06	1.08E-05
0.0789579	0.0266779	-0.0040972	1.63E-06	1.30E-06	8.38E-06
0.0662397	0.0183778	-0.0055888	1.67E-06	2.89E-06	6.20E-06
0.0660325	0.0265304	-0.0051437	1.10E-06	1.41E-06	4.75E-06
0.0653553	0.0183935	-0.0056563	1.84E-06	2.77E-06	5.31E-06
0.0564487	0.0203434	-0.0055721	1.59E-06	1.75E-06	4.46E-06
0.0568426	0.0189314	-0.0048631	1.90E-06	2.65E-06	4.68E-06
0.0561142	0.022514	-0.0046408	1.38E-06	1.12E-06	4.25E-06
0.0556606	0.0240335	-0.0054887	1.29E-06	5.64E-07	3.90E-06
0.0552736	0.0258604	-0.0054913	1.14E-06	8.29E-07	3.64E-06
0.0550827	0.0263602	-0.0061942	9.71E-07	1.19E-06	3.29E-06

Source File beam1b_neg15deg_fast_146.3Hz

Name:

Signal: FFT - Vib 3D Velocity - Magnitude

dB-Reference: 0 dB = 1 m/s

Band No.: 1

Frequency: 146.3 Hz

Interpolated: Yes

Filtered: Yes

X	Y	Z	Mag X	Mag Y	Mag Z
0.0660169	0.0257304	-0.0055982	2.37E-05	2.30E-06	6.92E-05
0.0789819	0.0261021	-0.0042086	2.65E-05	1.90E-05	0.000125622
0.0790156	0.0240105	-0.0049404	2.71E-05	2.20E-05	0.000127681
0.0660401	0.0236369	-0.0063297	2.33E-05	3.03E-06	6.99E-05
0.0790153	0.0217801	-0.0060444	2.87E-05	1.99E-05	0.000129489
0.0661633	0.0222611	-0.0050883	2.45E-05	7.24E-06	7.24E-05
0.0791653	0.020681	-0.0040503	2.94E-05	1.88E-05	0.000127682
0.0661496	0.0200109	-0.0061834	2.50E-05	1.35E-05	7.35E-05
0.0792035	0.0186027	-0.0046751	3.03E-05	1.47E-05	0.000123065
0.0662398	0.0183953	-0.0055952	2.45E-05	2.70E-05	8.01E-05
0.0918655	0.0259455	-0.0043309	3.00E-05	2.59E-05	0.000195202
0.0919586	0.0243499	-0.0036473	3.19E-05	3.57E-05	0.000195742
0.0919997	0.0222237	-0.0044707	3.21E-05	3.57E-05	0.000199551
0.0920845	0.020749	-0.0035078	3.31E-05	2.87E-05	0.000197663
0.0921227	0.0185857	-0.0044204	3.28E-05	1.96E-05	0.000193361
0.104799	0.0262484	-0.003135	3.47E-05	2.90E-05	0.000270525
0.104866	0.0243298	-0.0033968	3.68E-05	4.05E-05	0.000271732
0.104958	0.0227358	-0.0027112	3.80E-05	4.49E-05	0.000273111
0.105003	0.0207473	-0.0031563	3.76E-05	4.25E-05	0.000272363
0.105078	0.0189297	-0.0031304	3.77E-05	3.82E-05	0.000270988
0.117716	0.0263461	-0.0025059	4.17E-05	4.02E-05	0.000339829

0.117779	0.0245655	-0.0023914	4.06E-05	5.50E-05	0.000354582
0.11786	0.0227845	-0.0022753	4.18E-05	6.02E-05	0.000358761
0.11794	0.0209513	-0.0022447	4.33E-05	5.68E-05	0.000353573
0.117995	0.0186518	-0.0035323	4.00E-05	5.27E-05	0.000348827
0.130705	0.0246294	-0.0018589	4.16E-05	6.84E-05	0.000432663
0.13077	0.022815	-0.0018361	4.40E-05	7.89E-05	0.000436325
0.130859	0.0211722	-0.001342	4.65E-05	7.62E-05	0.000432667
0.130943	0.0193396	-0.0013091	4.64E-05	7.29E-05	0.000429711
0.143603	0.0248299	-0.0009533	4.37E-05	7.65E-05	0.000487138
0.143692	0.0230166	-0.0009302	4.62E-05	8.73E-05	0.000500665
0.143781	0.0213405	-0.0005296	4.90E-05	8.94E-05	0.000498416
0.14385	0.0193364	-0.0009654	4.92E-05	8.79E-05	0.000499181
0.14394	0.0177119	-0.0004737	5.00E-05	8.62E-05	0.000498708
0.131001	0.0172301	-0.0021312	4.70E-05	7.14E-05	0.000439135
0.156599	0.0231832	-0.0001209	5.05E-05	0.000100684	0.000558892
0.156673	0.0214736	0.00018625	5.23E-05	9.91E-05	0.000558158
0.156767	0.0195394	-6.14E-05	5.33E-05	9.97E-05	0.000557793
0.156859	0.0178122	0.00014932	5.36E-05	0.000101483	0.000557107
0.169493	0.0234179	0.00087345	5.28E-05	0.000118821	0.000609049
0.169591	0.0216061	0.00089951	5.35E-05	0.000120724	0.000609609
0.169669	0.0198283	0.00102117	5.40E-05	0.000120145	0.000607676
0.169768	0.0179809	0.00095736	5.59E-05	0.000122397	0.000604966
0.182372	0.0237038	0.00195231	5.32E-05	0.000136214	0.000646975
0.182486	0.021669	0.00142214	5.29E-05	0.000139309	0.000648469
0.18258	0.0199953	0.00182621	5.39E-05	0.000139701	0.000645729
0.182668	0.018114	0.0016689	5.58E-05	0.000140024	0.00063899
0.182774	0.0162319	0.00151407	5.75E-05	0.000139161	0.000637537
0.169856	0.0164106	0.00164577	5.86E-05	0.000124462	0.000611615
0.195339	0.0222132	0.00325572	5.21E-05	0.00015118	0.000661315
0.195449	0.0203687	0.00319101	5.30E-05	0.000151553	0.000656138
0.195558	0.0185234	0.00312835	5.55E-05	0.000151948	0.000651669
0.195649	0.0166772	0.00306727	5.67E-05	0.0001518	0.000648652
0.208187	0.0225844	0.00461675	5.02E-05	0.000166831	0.000652689
0.208283	0.0207408	0.00455202	5.11E-05	0.000166751	0.000649587
0.208405	0.0188449	0.00429601	5.27E-05	0.00016624	0.000645657
0.208534	0.0168436	0.00386764	5.40E-05	0.000164568	0.000645461
0.22114	0.0211124	0.00591095	4.70E-05	0.000174997	0.000628367
0.221263	0.0191135	0.00537377	4.77E-05	0.000174176	0.000626987
0.221383	0.0172519	0.005321	4.97E-05	0.000175918	0.000626645
0.221464	0.0157204	0.00610668	5.11E-05	0.000174634	0.000627606
0.208638	0.015102	0.00409091	5.48E-05	0.000162465	0.000646749
0.233946	0.0216208	0.00764077	4.05E-05	0.000180379	0.000588148
0.234106	0.0195543	0.00691773	4.10E-05	0.000182505	0.000587299
0.234228	0.0175896	0.0065838	4.34E-05	0.00018317	0.000585112
0.234353	0.0157457	0.0065274	4.60E-05	0.000183393	0.000584933
0.246775	0.0218864	0.00871112	3.50E-05	0.00018894	0.000548573
0.246951	0.0197861	0.00789562	3.48E-05	0.000188395	0.000531947
0.247011	0.0182558	0.00867943	3.67E-05	0.000188211	0.00052557
0.24717	0.0162222	0.00816213	3.77E-05	0.000186613	0.000522503
0.259762	0.0200855	0.00905657	3.08E-05	0.000190247	0.000460135
0.259851	0.0184868	0.00965477	3.00E-05	0.000189422	0.00045436
0.260058	0.0162451	0.00857756	2.93E-05	0.000188514	0.000451339

0.260115	0.0148203	0.00964699	2.93E-05	0.000186026	0.000448851
0.247271	0.0145534	0.00857616	3.77E-05	0.000188036	0.000520358
0.272534	0.0206262	0.0108702	2.47E-05	0.000191571	0.000390595
0.272576	0.019167	0.0118416	2.27E-05	0.000192322	0.000366464
0.272767	0.0170836	0.0111133	2.26E-05	0.000189142	0.000362385
0.272959	0.0149808	0.0104334	2.29E-05	0.000185927	0.000358968
0.285458	0.0190828	0.0119679	1.69E-05	0.000192596	0.000268022
0.285563	0.0174162	0.0123821	1.74E-05	0.000194599	0.000266777
0.285717	0.0155406	0.0122378	1.74E-05	0.000193369	0.00026603
0.298188	0.0196561	0.0138667	1.69E-05	0.000190132	0.00018288
0.298338	0.0177468	0.0136265	1.74E-05	0.000192304	0.000162671
0.298488	0.0159066	0.0135766	1.84E-05	0.000191149	0.000159242
0.298577	0.0142929	0.0141883	1.80E-05	0.000188015	0.000155867
0.285804	0.013856	0.0126608	1.71E-05	0.000196152	0.000260346
0.31111	0.0180758	0.0148674	2.19E-05	0.000183302	6.24E-05
0.311256	0.016271	0.0149119	2.36E-05	0.000179387	5.88E-05
0.311317	0.0147094	0.0156094	2.36E-05	0.000178156	5.49E-05
0.323751	0.0188019	0.0171221	3.37E-05	0.00017636	6.38E-05
0.323901	0.0169811	0.0171739	3.68E-05	0.000173653	8.38E-05
0.324064	0.0150718	0.0169401	3.60E-05	0.000172453	8.91E-05
0.324225	0.0132321	0.0168964	3.46E-05	0.000174724	8.86E-05
0.311568	0.0125192	0.0146326	2.34E-05	0.000176325	4.71E-05
0.336579	0.017497	0.0188638	4.65E-05	0.000164524	0.000167784
0.336722	0.0157287	0.0190053	5.00E-05	0.000165077	0.000188592
0.336837	0.0139943	0.0192398	4.94E-05	0.00016644	0.000195721
0.349499	0.0158768	0.0197665	5.91E-05	0.000153942	0.000287862
0.349622	0.0141778	0.0200971	5.86E-05	0.000155776	0.000296841
0.349798	0.0122679	0.01987	5.76E-05	0.000159877	0.000302273
0.337068	0.0119277	0.0186475	5.06E-05	0.000172439	0.000210635
0.362144	0.0163881	0.0214454	6.90E-05	0.000148445	0.000368789
0.362219	0.0148292	0.0221484	6.90E-05	0.000142303	0.0003886
0.36247	0.0127811	0.0215533	6.68E-05	0.000143511	0.00039096
0.374869	0.0152507	0.0236421	7.53E-05	0.000138031	0.00046516
0.375116	0.0132381	0.0231417	7.39E-05	0.000137394	0.000470526
0.375257	0.0115044	0.0233853	7.28E-05	0.000136955	0.000477717
0.362602	0.0110111	0.0217008	6.69E-05	0.000141654	0.000403148
0.387481	0.0157919	0.0254033	7.90E-05	0.000130311	0.000527249
0.387662	0.0139189	0.0252728	7.93E-05	0.000128141	0.000538156
0.387918	0.0119057	0.0247765	7.79E-05	0.000127026	0.000540312
0.400335	0.0142828	0.0265657	8.24E-05	0.000115146	0.000580446
0.400419	0.012654	0.0270864	8.29E-05	0.000112429	0.000585714
0.40055	0.0109563	0.0274264	8.45E-05	0.000113722	0.000588327
0.388089	0.0101017	0.024838	7.88E-05	0.000126434	0.00054303
0.412764	0.0151137	0.0291504	8.30E-05	0.000105743	0.000610732
0.41291	0.0133633	0.0292954	8.37E-05	0.000101393	0.000613897
0.413214	0.0112806	0.0286203	8.58E-05	0.00010249	0.000621063
0.425444	0.0139289	0.0311267	8.29E-05	9.80E-05	0.000623781
0.425642	0.012056	0.0310046	8.38E-05	9.53E-05	0.000625063
0.425858	0.0101833	0.0308874	8.59E-05	9.26E-05	0.000629783
0.413266	0.00972229	0.02933	8.79E-05	0.000102581	0.000621689
0.43781	0.0147688	0.0336846	7.87E-05	9.43E-05	0.000619391
0.438201	0.0125481	0.0326454	7.85E-05	8.92E-05	0.000615197

0.438337	0.0108322	0.0328888	8.04E-05	8.57E-05	0.000618849
0.438575	0.008924	0.0326833	8.22E-05	8.69E-05	0.000625994
0.426171	0.00811574	0.0302127	8.69E-05	9.01E-05	0.000639585
0.450731	0.0129994	0.0341807	7.38E-05	8.42E-05	0.000588486
0.450728	0.0115998	0.0352562	7.44E-05	8.28E-05	0.0005942
0.451061	0.00951677	0.0345927	7.59E-05	8.42E-05	0.00059836
0.463199	0.0135876	0.0360791	6.81E-05	7.78E-05	0.000559228
0.463395	0.0117666	0.0360495	6.56E-05	7.55E-05	0.000546898
0.463738	0.00970036	0.0353823	6.72E-05	7.62E-05	0.000551977
0.463565	0.00858103	0.0371924	6.89E-05	7.49E-05	0.000558865
0.451217	0.00776508	0.0347491	7.62E-05	8.36E-05	0.00059961
0.475838	0.0123669	0.0379311	5.35E-05	7.26E-05	0.00048222
0.475904	0.0107733	0.0385535	5.53E-05	7.14E-05	0.000484829
0.476161	0.00888264	0.0383492	5.87E-05	6.95E-05	0.000495321
0.488054	0.0132934	0.0407231	4.14E-05	6.88E-05	0.000427006
0.488319	0.0113678	0.0404237	4.13E-05	6.67E-05	0.000412066
0.488443	0.00972301	0.040862	4.40E-05	6.62E-05	0.000417322
0.488904	0.00748022	0.039747	5.08E-05	6.47E-05	0.000428962
0.476494	0.00684997	0.0377806	6.25E-05	6.65E-05	0.000500347
0.500746	0.0119054	0.0422004	2.91E-05	5.95E-05	0.000343746
0.500812	0.0103465	0.0428124	3.22E-05	5.84E-05	0.000332824
0.501163	0.00831524	0.0422488	3.90E-05	5.52E-05	0.000343437
0.513236	0.0108428	0.0444864	2.09E-05	5.36E-05	0.000253641
0.5136	0.00877514	0.0438308	2.73E-05	4.78E-05	0.000261474
0.513853	0.00693538	0.0437217	2.86E-05	4.75E-05	0.00026359
0.501578	0.00614	0.041319	4.15E-05	5.23E-05	0.000343294
0.514135	0.00515327	0.0438181	2.77E-05	5.06E-05	0.000248709
0.514077	0.00499455	0.0439758	2.92E-05	4.68E-05	0.000253697
0.513978	0.00509773	0.0442418	2.82E-05	4.95E-05	0.000256666
0.514003	0.00521712	0.043982	2.78E-05	5.23E-05	0.000252163
0.51398	0.0073126	0.0447027	2.57E-05	4.80E-05	0.000243798
0.514182	0.00870863	0.0436635	2.28E-05	4.52E-05	0.00024094
0.514219	0.00804868	0.0438166	2.42E-05	4.41E-05	0.000241728
0.513928	0.0105652	0.0437679	1.94E-05	5.00E-05	0.000234639
0.513088	0.0124014	0.0441834	1.89E-05	5.34E-05	0.000254002
0.513648	0.0123355	0.0441203	1.82E-05	4.91E-05	0.000232347
0.511373	0.00525963	0.0440109	3.13E-05	5.35E-05	0.000278032
0.50134	0.00576826	0.0429425	4.18E-05	5.42E-05	0.000346943
0.511279	0.0124786	0.0439519	2.30E-05	5.69E-05	0.000310472
0.500465	0.013052	0.0430118	2.45E-05	5.86E-05	0.000328804
0.48969	0.00586305	0.0403224	4.74E-05	5.67E-05	0.00039391
0.48895	0.00597365	0.0404467	5.37E-05	6.43E-05	0.00044588
0.488054	0.0132934	0.0407231	4.26E-05	7.00E-05	0.000434742
0.476529	0.00619029	0.0379326	6.35E-05	6.58E-05	0.000500887
0.475614	0.013529	0.0384231	5.39E-05	7.39E-05	0.000484241
0.467951	0.0064482	0.0364998	6.81E-05	6.83E-05	0.000535727
0.463798	0.00696642	0.0368782	7.17E-05	7.50E-05	0.000572012
0.465117	0.0136749	0.0363229	6.46E-05	7.70E-05	0.00054079
0.463163	0.0137603	0.0361151	6.83E-05	8.04E-05	0.000560664
0.451198	0.00745468	0.0350822	7.63E-05	8.21E-05	0.000599823
0.450468	0.014405	0.0349006	7.36E-05	8.68E-05	0.00058734
0.44583	0.00765272	0.0343075	7.88E-05	8.51E-05	0.000611505

0.438609	0.00790335	0.0331886	8.29E-05	8.70E-05	0.000627304
0.44194	0.0142607	0.0324716	7.70E-05	9.24E-05	0.000613716
0.437793	0.0150281	0.0335832	7.89E-05	9.61E-05	0.000622747
0.426155	0.00799464	0.0303645	8.67E-05	9.05E-05	0.000642108
0.425359	0.0150708	0.0307881	8.27E-05	0.000100479	0.000624762
0.424228	0.00769906	0.0290543	8.79E-05	9.37E-05	0.000641828
0.413613	0.00824059	0.0278947	8.84E-05	0.000102353	0.000624599
0.418446	0.015351	0.0299155	8.34E-05	0.000105012	0.000619621
0.412775	0.0154064	0.0287172	8.30E-05	0.000110745	0.000607107
0.401923	0.00910645	0.027376	8.83E-05	0.000107908	0.000609539
0.400692	0.00927408	0.0275478	8.71E-05	0.000116431	0.00058841
0.400044	0.0160524	0.0274731	8.25E-05	0.000118386	0.000577294
0.388138	0.00978308	0.0258307	8.45E-05	0.000126695	0.000562072
0.388025	0.00975916	0.0257147	7.96E-05	0.000130024	0.000536601
0.395082	0.0160774	0.0263565	8.01E-05	0.000125302	0.000546634
0.387516	0.0161369	0.0247394	7.77E-05	0.00013058	0.00052264
0.379547	0.00962267	0.0233163	7.59E-05	0.000132315	0.0005134
0.375446	0.00987179	0.0230598	7.20E-05	0.000138509	0.000470323
0.374667	0.0169847	0.0240397	7.51E-05	0.000139535	0.000462345
0.362637	0.0105612	0.0218758	6.72E-05	0.000142965	0.000405524
0.371547	0.0170689	0.0235648	7.20E-05	0.000146707	0.000400993
0.36187	0.0176901	0.0229658	6.63E-05	0.000149834	0.000362821
0.356139	0.0109499	0.0214017	6.37E-05	0.000150067	0.000360263
0.349892	0.0110369	0.0201312	5.74E-05	0.000164453	0.000292848
0.349245	0.0178713	0.0204933	5.69E-05	0.00015485	0.000280869
0.337009	0.0118959	0.0194051	4.99E-05	0.000172347	0.000213378
0.347947	0.0181346	0.0208758	4.95E-05	0.000160549	0.000202562
0.336566	0.0182077	0.0183822	4.47E-05	0.000166341	0.000160893
0.332892	0.0116644	0.0178255	4.30E-05	0.000175321	0.000161958
0.324381	0.011876	0.0163495	3.17E-05	0.000175111	8.41E-05
0.324368	0.0189816	0.01766	4.05E-05	0.000173625	0.00010353
0.311577	0.0124157	0.0147797	2.36E-05	0.000176217	4.55E-05
0.311066	0.0189607	0.0144266	1.87E-05	0.000185617	7.47E-05
0.309488	0.0127165	0.0150974	2.10E-05	0.000179316	7.21E-05
0.301187	0.0131177	0.0142343	1.94E-05	0.000184563	0.000120823
0.298674	0.0131282	0.0138835	1.79E-05	0.000189793	0.000174623
0.300164	0.0198378	0.0144151	1.83E-05	0.000186884	0.000156135
0.305573	0.019395	0.0143555	1.85E-05	0.000187589	0.000111896
0.298117	0.0199851	0.0143804	1.66E-05	0.000188366	0.000189407
0.285872	0.0133521	0.0124268	1.75E-05	0.000197613	0.000259488
0.285358	0.0202632	0.0123777	1.67E-05	0.000193202	0.000271387
0.277091	0.0138361	0.0123676	1.92E-05	0.000195515	0.000312734
0.272993	0.013731	0.0114382	2.41E-05	0.000185757	0.0003719
0.273635	0.0205144	0.0105702	2.21E-05	0.000192595	0.000356943
0.272527	0.0207304	0.010938	2.51E-05	0.000188165	0.000394983
0.260124	0.0140911	0.0103478	2.95E-05	0.00018676	0.000448592
0.259693	0.0210929	0.00921384	3.02E-05	0.000186649	0.000461785
0.247248	0.0144675	0.00935518	3.76E-05	0.000189694	0.000520199
0.246913	0.0218199	0.00853073	3.34E-05	0.000189064	0.000526501
0.246769	0.0219383	0.00879838	3.52E-05	0.000186703	0.000552267
0.239868	0.0140824	0.00713341	4.33E-05	0.000188029	0.000557461
0.234389	0.0146156	0.00769794	4.82E-05	0.000181348	0.000595415

0.23392	0.0223344	0.00716327	4.07E-05	0.00017928	0.000590093
0.221512	0.014798	0.00613164	5.17E-05	0.000173923	0.00062604
0.221054	0.0226443	0.00523695	4.62E-05	0.000175889	0.000628334
0.215526	0.0147685	0.00513129	5.39E-05	0.000167407	0.000638867
0.208609	0.0151018	0.00494393	5.54E-05	0.000159566	0.000647117
0.220196	0.022857	0.00565301	4.77E-05	0.00017588	0.000640238
0.208172	0.0229874	0.0038288	5.06E-05	0.00016615	0.000651787
0.218211	0.0228311	0.00514771	4.76E-05	0.000175538	0.000638276
0.202486	0.0151044	0.00397561	5.66E-05	0.00015263	0.000651777
0.195715	0.0154225	0.00374799	5.75E-05	0.000144348	0.000650962
0.195277	0.0235539	0.00308199	5.24E-05	0.000149656	0.000659975
0.182788	0.0158469	0.00283043	5.78E-05	0.000136037	0.00064062
0.187531	0.0239614	0.00282925	5.33E-05	0.000139845	0.000656432
0.182358	0.0238792	0.00167483	5.29E-05	0.000133881	0.00064616
0.169854	0.0162707	0.00191083	5.92E-05	0.000122101	0.000617734
0.169428	0.0246167	0.00139272	5.18E-05	0.000118499	0.000608065
0.165173	0.016083	0.00064336	5.88E-05	0.000112019	0.000595038
0.15693	0.0166247	0.00080174	5.49E-05	9.73E-05	0.00055381
0.156502	0.0252166	0.00073291	4.94E-05	9.81E-05	0.000557954
0.143974	0.016632	-0.0012476	4.94E-05	8.32E-05	0.00049618
0.154314	0.0252343	0.00039687	4.56E-05	8.00E-05	0.00051059
0.143586	0.025491	-0.0007684	4.42E-05	7.18E-05	0.000484705
0.131025	0.0172978	-0.0015169	4.72E-05	6.86E-05	0.000438724
0.130636	0.0258862	-0.0019965	4.24E-05	6.41E-05	0.000430506
0.127786	0.0174174	-0.0016305	4.42E-05	6.19E-05	0.000404639
0.118064	0.0177727	-0.0022507	3.82E-05	5.19E-05	0.000346681
0.121074	0.0266484	-0.0016109	4.40E-05	4.90E-05	0.00036918
0.117717	0.0268965	-0.0015354	4.62E-05	3.88E-05	0.000350434
0.108243	0.0178197	-0.0036555	3.62E-05	4.70E-05	0.000298824
0.105104	0.0180737	-0.0032426	3.65E-05	3.58E-05	0.000257843
0.104778	0.0264945	-0.0033302	3.39E-05	2.67E-05	0.000267537
0.117236	0.0267808	-0.0019099	4.35E-05	3.19E-05	0.000326719
0.0921406	0.018095	-0.0042406	3.44E-05	1.02E-05	0.00018943
0.0918475	0.0263136	-0.0044639	2.86E-05	2.32E-05	0.000191295
0.0792112	0.0184263	-0.0043973	3.02E-05	1.10E-05	0.000121794
0.0789579	0.0266779	-0.0040972	2.61E-05	1.70E-05	0.00012457
0.0662397	0.0183778	-0.0055888	2.55E-05	2.44E-05	8.20E-05
0.0660325	0.0265304	-0.0051437	2.32E-05	4.99E-06	7.02E-05
0.0653553	0.0183935	-0.0056563	2.41E-05	2.22E-05	6.60E-05
0.0564487	0.0203434	-0.0055721	2.48E-05	5.21E-06	4.64E-05
0.0568426	0.0189314	-0.0048631	2.50E-05	5.65E-06	4.77E-05
0.0561142	0.022514	-0.0046408	2.41E-05	2.76E-06	4.50E-05
0.0556606	0.0240335	-0.0054887	2.26E-05	3.00E-06	4.46E-05
0.0552736	0.0258604	-0.0054913	2.22E-05	2.38E-06	4.40E-05
0.0550827	0.0263602	-0.0061942	2.16E-05	4.22E-06	4.48E-05

Source File

Name: beam1lb_neg30deg_fast_183.1Hz

Signal: FFT - Vib 3D Velocity - Magnitude

dB-Reference: 0 dB = 1 m/s

Band No.: 1
Frequency: 183.1 Hz

Interpolated: Yes
Filtered: Yes

X	Y	Z	Mag X	Mag Y	Mag Z
0.0536478	0.0221851	-0.0040288	6.84E-05	1.85E-05	0.000138617
0.068468	0.0225115	-0.0034252	9.92E-05	2.88E-05	0.000325645
0.0685666	0.0207059	-0.003944	9.87E-05	2.74E-05	0.000327542
0.0537013	0.0206187	-0.0039993	6.78E-05	1.80E-05	0.000139912
0.068622	0.019259	-0.0036368	9.61E-05	2.80E-05	0.000323387
0.053759	0.0191323	-0.0037844	6.89E-05	1.68E-05	0.000145738
0.068716	0.017586	-0.0038827	8.92E-05	2.75E-05	0.000313834
0.0538491	0.0174195	-0.0041228	6.55E-05	1.67E-05	0.000138424
0.0834405	0.0222253	-0.0042335	0.00011056	2.92E-05	0.000616577
0.0835065	0.0206575	-0.0042021	0.000112532	2.35E-05	0.000618555
0.0835878	0.0190755	-0.0041618	0.000110679	2.01E-05	0.000618858
0.0836235	0.0177617	-0.0035841	0.000110058	2.25E-05	0.000612963
0.0983621	0.0224255	-0.0038852	0.000121334	1.61E-05	0.000985404
0.0984838	0.0206988	-0.0042172	0.000126312	7.31E-06	0.000988639
0.098573	0.0190499	-0.0043656	0.000126997	5.25E-06	0.000988579
0.0985574	0.0179748	-0.0032395	0.000128547	1.03E-05	0.000982519
0.113346	0.0225852	-0.0036715	0.000137172	1.56E-05	0.00140106
0.113421	0.0210966	-0.0034544	0.000137142	2.61E-05	0.00140922
0.11347	0.0196325	-0.0031394	0.000138123	2.50E-05	0.0014055
0.113631	0.0177986	-0.003746	0.000147231	1.73E-05	0.00139464
0.128353	0.022809	-0.0033123	0.000138266	4.02E-05	0.00173966
0.128506	0.0210274	-0.003726	0.000133991	4.82E-05	0.00180733
0.128542	0.0196964	-0.0031413	0.000136352	5.15E-05	0.00181155
0.128648	0.0180461	-0.0032854	0.000144357	4.50E-05	0.00180438
0.143488	0.0215133	-0.0027633	0.000132559	7.34E-05	0.00215046
0.143699	0.0195714	-0.0035371	0.000131793	8.01E-05	0.00214946
0.143642	0.0185723	-0.0022285	0.00013897	7.91E-05	0.00214564
0.158581	0.0217321	-0.0023762	0.000133855	9.87E-05	0.00241203
0.158756	0.019963	-0.0027901	0.000130807	0.000105458	0.00242021
0.15878	0.0186698	-0.0021114	0.00013109	0.000107569	0.00241817
0.158917	0.0170186	-0.002249	0.000134963	0.000105824	0.0024155
0.143861	0.0165474	-0.0031816	0.000139082	7.67E-05	0.00217461
0.173706	0.0207616	-0.0010723	0.000117487	0.000124094	0.00256574
0.173907	0.0189664	-0.0015794	0.000116496	0.000126502	0.00256583
0.174024	0.0173389	-0.0016199	0.000115889	0.000128717	0.00255995
0.188872	0.0210185	-0.000674	9.54E-05	0.000137105	0.00261508
0.189027	0.0193526	-0.0008034	9.08E-05	0.000140564	0.0025924
0.18918	0.0176592	-0.0010297	8.93E-05	0.000142539	0.00258052
0.18926	0.0161907	-0.0007025	8.89E-05	0.000138411	0.00257529

0.174128	0.0158059	-0.0014817	0.000111642	0.00012579	0.00258008
0.204166	0.019737	-6.98E-05	5.94E-05	0.000145681	0.00251521
0.204218	0.0183472	0.00043772	5.57E-05	0.000148793	0.00250565
0.204364	0.0167192	0.00040442	5.47E-05	0.000147842	0.00250397
0.219193	0.0204889	0.00154221	2.21E-05	0.000143912	0.00235708
0.21938	0.0187818	0.0013284	1.11E-05	0.000143833	0.00230639
0.219466	0.0173262	0.0016516	7.17E-06	0.000143187	0.00228926
0.219704	0.0154982	0.00117112	8.85E-06	0.000148295	0.00227993
0.204463	0.0151835	0.00054517	4.97E-05	0.000153418	0.00249979
0.234564	0.0192558	0.00227057	4.11E-05	0.000132322	0.00195055
0.234564	0.0179829	0.00305185	4.46E-05	0.000126178	0.00192496
0.234867	0.0160502	0.00229765	4.74E-05	0.000131253	0.00191578
0.249582	0.0201498	0.00417051	9.29E-05	0.00011676	0.00158499
0.249773	0.0184399	0.00396073	0.000106915	0.000103533	0.00147159
0.250035	0.0166258	0.00347968	0.000112363	9.79E-05	0.00144987
0.250013	0.0153915	0.00435432	0.000115912	0.000102839	0.00144477
0.234994	0.0144579	0.00235971	5.08E-05	0.000138857	0.00190586
0.265049	0.0188436	0.00474963	0.000157865	6.17E-05	0.000932251
0.265164	0.0173307	0.00499557	0.000165965	5.56E-05	0.000908553
0.265537	0.0153168	0.00407175	0.000171086	5.58E-05	0.000889282
0.265572	0.0139613	0.00467982	0.00017361	6.13E-05	0.000890054
0.250123	0.0138941	0.0045953	0.000132166	9.83E-05	0.0013675
0.279986	0.0199271	0.0071246	0.000215774	2.15E-05	0.000444646
0.280356	0.0179551	0.00629186	0.000223309	9.80E-06	0.000316826
0.280559	0.0162828	0.00618352	0.000232071	6.02E-06	0.00029581
0.280656	0.0148222	0.00651762	0.000236102	9.69E-06	0.000284807
0.295337	0.0189972	0.00853738	0.000268811	2.93E-05	0.00019431
0.295767	0.0169305	0.0075391	0.000288042	3.95E-05	0.000306026
0.295692	0.015785	0.00858821	0.000296896	4.46E-05	0.000330863
0.296018	0.013872	0.00794809	0.000295091	3.69E-05	0.000341881
0.280716	0.0133999	0.00693971	0.000254652	1.60E-05	0.00020682
0.310695	0.018073	0.0100167	0.00033997	7.34E-05	0.000793697
0.310959	0.0163348	0.00973083	0.000348575	8.60E-05	0.00091473
0.311084	0.0148327	0.00998063	0.000356673	8.91E-05	0.000939669
0.326291	0.0168306	0.0107546	0.000398277	0.00013256	0.00144718
0.326493	0.0152084	0.0107404	0.000405958	0.00013658	0.00147219
0.32643	0.0140059	0.0117099	0.000401735	0.000137699	0.0014878
0.311463	0.01288	0.00926085	0.00035074	9.55E-05	0.000991681
0.341271	0.0179404	0.013166	0.000433883	0.000168609	0.00183654
0.34159	0.0161197	0.0127084	0.000446975	0.000178927	0.00192173
0.341723	0.0146144	0.0129639	0.000435922	0.000181665	0.00193618
0.342206	0.0125559	0.0119837	0.000430556	0.000180065	0.00194833
0.326928	0.0118665	0.0105437	0.000401226	0.000144453	0.00158928
0.356768	0.0169364	0.0144673	0.000469084	0.000214845	0.00224782
0.356957	0.0153513	0.0145485	0.000468896	0.000221784	0.00228962
0.35713	0.0137639	0.0146279	0.000469271	0.000221568	0.00230641
0.372149	0.0161627	0.0162656	0.000485068	0.000247063	0.00253504

0.3721	0.0149294	0.0171423	0.000485342	0.000250316	0.00256233
0.372414	0.0131442	0.0167862	0.000488073	0.000249713	0.00257491
0.357215	0.0123358	0.015065	0.000478773	0.000222466	0.00234395
0.387526	0.0153916	0.0181278	0.000486545	0.000270089	0.00265721
0.387417	0.0142495	0.0191749	0.000483271	0.00026752	0.00266485
0.388037	0.0120712	0.017953	0.000483487	0.000269018	0.00268663
0.372797	0.0112804	0.0162606	0.000489766	0.000251714	0.00262012
0.402668	0.0150231	0.0208284	0.000471102	0.000270303	0.00266746
0.402829	0.0134707	0.0210059	0.000459997	0.000270226	0.00265314
0.403034	0.0118807	0.021102	0.000462089	0.000273997	0.00266624
0.38818	0.0105601	0.0182219	0.000485304	0.000271328	0.00271354
0.418106	0.014224	0.0226263	0.000418166	0.000265828	0.00247338
0.418076	0.0129605	0.0234146	0.000414674	0.000270745	0.00248159
0.418511	0.0110526	0.0228154	0.000420539	0.000277122	0.00249433
0.403644	0.00975302	0.0199723	0.000461775	0.000278161	0.00265736
0.433191	0.0152465	0.0248124	0.000380394	0.000255154	0.00227295
0.433237	0.0138468	0.0253434	0.000366722	0.000253894	0.00221106
0.433576	0.0121119	0.0250937	0.000362328	0.00025074	0.00221652
0.433884	0.010415	0.0249326	0.000370636	0.000250417	0.00224183
0.41911	0.00896273	0.0217818	0.000428214	0.000281262	0.00249927
0.448466	0.0146918	0.0271471	0.000317025	0.000234257	0.00190449
0.448623	0.0131898	0.0274198	0.000295908	0.000219882	0.00183216
0.448716	0.0117659	0.0278667	0.000301186	0.00021345	0.00184934
0.463771	0.0141285	0.0294445	0.000241584	0.000187272	0.00146035
0.463931	0.0126245	0.0297213	0.000233312	0.000176166	0.00139526
0.464354	0.0108079	0.0293119	0.000246492	0.000185466	0.0014178
0.449433	0.00954135	0.0265917	0.000313299	0.00022467	0.00186838
0.479007	0.0136583	0.0319696	0.000175713	0.000143973	0.00100176
0.479324	0.0119555	0.0318174	0.000165417	0.000143868	0.000940047
0.47969	0.0102297	0.0315795	0.000180513	0.000158476	0.000951025
0.464498	0.00930057	0.0295875	0.00025788	0.000202488	0.00141493
0.494224	0.0132156	0.0345379	0.000100411	9.78E-05	0.000556581
0.49448	0.0115887	0.034562	0.000100942	9.96E-05	0.000504826
0.494716	0.0100172	0.0346714	0.000111579	0.00010359	0.000519061
0.480293	0.00821426	0.0307514	0.000191036	0.000167843	0.000936763
0.509711	0.01249	0.036469	6.37E-05	5.42E-05	0.000171726
0.509737	0.0111345	0.0370983	6.07E-05	4.89E-05	0.000141496
0.510177	0.0093252	0.0366981	5.89E-05	4.63E-05	0.000165558
0.495333	0.00800103	0.0338518	0.000105814	9.63E-05	0.000512568
0.524977	0.0120091	0.0389629	2.64E-05	2.22E-06	0.000119348
0.525149	0.0104961	0.0392567	2.77E-05	1.63E-06	0.000100418
0.525599	0.00868454	0.0388638	3.26E-05	4.58E-06	7.84E-05
0.510596	0.00754102	0.0363969	5.75E-05	4.26E-05	0.00014791
0.535021	0.00759397	0.040056	2.83E-05	2.16E-05	0.000156266
0.535267	0.0061928	0.0400988	2.93E-05	1.90E-05	0.000142362
0.526067	0.00643002	0.0386842	3.08E-05	3.21E-06	8.22E-05
0.52599	0.00695184	0.0386473	3.16E-05	2.80E-06	8.96E-05

0.534588	0.00938094	0.0403471	2.42E-05	2.45E-05	0.000176697
0.534243	0.0110777	0.0404838	1.78E-05	2.83E-05	0.000202813
0.533771	0.0128851	0.0408703	1.73E-05	2.78E-05	0.000211676
0.524567	0.0131882	0.0395469	2.71E-05	1.16E-05	8.22E-05
0.520135	0.00688575	0.0385143	3.68E-05	2.27E-05	7.54E-06
0.510636	0.00692613	0.0365785	5.77E-05	4.77E-05	0.000168405
0.517299	0.0132588	0.0381577	4.78E-05	3.75E-05	5.79E-05
0.509404	0.0134318	0.0368526	6.44E-05	5.54E-05	0.000182348
0.503513	0.00686047	0.0349245	7.86E-05	6.69E-05	0.000306386
0.4952	0.00743518	0.0345261	0.000112037	0.000100701	0.000545987
0.500504	0.0137517	0.0356995	8.29E-05	8.17E-05	0.00040673
0.4941	0.0138597	0.0345462	0.000103215	0.000101138	0.000572163
0.486517	0.00726657	0.0322609	0.000145622	0.000125514	0.00072032
0.480165	0.00751713	0.0314869	0.000204118	0.000170127	0.000988639
0.483669	0.0143232	0.0334032	0.000147529	0.000132195	0.00083804
0.478935	0.0141477	0.031953	0.000174269	0.000152686	0.00101744
0.469609	0.00759711	0.0294203	0.000236619	0.000193252	0.00118641
0.465181	0.00752036	0.0283329	0.000275753	0.000212104	0.00147885
0.467099	0.0145662	0.0304077	0.000215771	0.000180611	0.00129302
0.463439	0.014796	0.0301781	0.000250867	0.000198421	0.00147523
0.452281	0.00842384	0.0276945	0.00029641	0.000222667	0.00167121
0.449394	0.00850774	0.0272796	0.000331222	0.000234644	0.001943
0.450358	0.0150459	0.02792	0.000299026	0.000226821	0.00174729
0.448273	0.0151011	0.0275855	0.000323751	0.000238429	0.001913
0.435766	0.00827234	0.0238067	0.000360187	0.000241169	0.0021069
0.434377	0.0085689	0.0242139	0.000395584	0.00025881	0.00232029
0.433526	0.0156276	0.0256834	0.000357419	0.000245584	0.0021213
0.419111	0.00891886	0.0218019	0.000436264	0.000286204	0.00250172
0.417716	0.0159762	0.0230844	0.000435095	0.000263345	0.00252703
0.41869	0.00881706	0.0214726	0.000453887	0.000289691	0.00258404
0.403646	0.00957785	0.0200521	0.00046816	0.000281182	0.00266069
0.416907	0.0159799	0.0229191	0.000461779	0.000268065	0.00262762
0.40261	0.0162273	0.0203845	0.000472767	0.000272965	0.0026633
0.401309	0.00979995	0.0200934	0.00047584	0.000276586	0.00269607
0.388324	0.0100568	0.0179235	0.000486723	0.000272106	0.00271303
0.40013	0.0165708	0.0206687	0.000482357	0.000274108	0.00266452
0.387148	0.0169494	0.0187948	0.000485524	0.000268512	0.00266183
0.384353	0.0102648	0.0175921	0.000490364	0.00026648	0.00269383
0.373046	0.0104738	0.0156749	0.000490919	0.00025226	0.00261837
0.383336	0.0171891	0.0185014	0.000485339	0.000260604	0.00263116
0.371691	0.0176166	0.0172964	0.000486153	0.000248034	0.00251817
0.380418	0.0168063	0.0169545	0.000487033	0.000262479	0.00262271
0.36697	0.0113666	0.0164895	0.000490033	0.000240245	0.0025316
0.3573	0.0116362	0.0150635	0.000482561	0.00022587	0.00237222
0.364114	0.0178485	0.0164785	0.000478076	0.000226925	0.00235481
0.356537	0.0177858	0.0149286	0.000467613	0.000210929	0.00222368
0.348683	0.0112707	0.0127117	0.000457712	0.000203587	0.00218324

0.355085	0.0111742	0.0134834	0.00046767	0.000219098	0.00228436
0.342043	0.0118457	0.0130475	0.000425617	0.000174048	0.00191914
0.344457	0.0183698	0.0141067	0.000449279	0.000183495	0.00198332
0.341168	0.0183294	0.0134163	0.000430497	0.000165387	0.00181498
0.326881	0.0118588	0.0107602	0.000401681	0.00014481	0.0016057
0.326081	0.0184206	0.010895	0.000390334	0.000131638	0.0014313
0.325475	0.0118025	0.0104049	0.000385346	0.000126586	0.00139428
0.311539	0.0122253	0.00923508	0.000349592	9.51E-05	0.00099287
0.324996	0.0185955	0.0110875	0.000355968	9.24E-05	0.00099749
0.310704	0.0190177	0.00948932	0.000333399	7.52E-05	0.000771845
0.302298	0.0124096	0.00825554	0.000322333	7.16E-05	0.00069505
0.296069	0.0128508	0.00830292	0.000293547	3.91E-05	0.000343839
0.305317	0.0192359	0.00902319	0.0002945	5.77E-05	0.000434717
0.295482	0.0193724	0.00762347	0.000255905	2.63E-05	0.000164828
0.29685	0.0194692	0.00803063	0.000279165	5.33E-05	0.000323559
0.289498	0.0130021	0.0076402	0.000277178	9.87E-06	5.50E-05
0.280719	0.0132122	0.00702381	0.000258732	2.25E-05	0.000243995
0.282309	0.0198537	0.00692077	0.000234508	4.12E-06	0.000222655
0.279984	0.0200426	0.00707341	0.000213508	2.34E-05	0.000469438
0.276964	0.0132674	0.00668274	0.000231918	4.12E-05	0.000469567
0.265523	0.0133014	0.00529683	0.000173995	6.98E-05	0.000916054
0.264876	0.0200825	0.00505843	0.000158249	6.59E-05	0.000946001
0.250218	0.0136518	0.00416581	0.00012817	9.80E-05	0.00134863
0.256833	0.0204117	0.00471103	0.00011422	0.000104191	0.00140384
0.249596	0.020485	0.00391509	8.94E-05	0.000119334	0.00161299
0.249478	0.0135867	0.00392754	0.000102362	0.000116823	0.00156059
0.235037	0.0137857	0.00255452	5.11E-05	0.000143734	0.0019057
0.234245	0.0210813	0.00318269	3.74E-05	0.000134797	0.00193541
0.221809	0.0145092	0.00255833	2.30E-05	0.000150949	0.00213652
0.219772	0.0141414	0.00145068	6.51E-06	0.000150181	0.00232018
0.231463	0.0209074	0.00237738	5.38E-06	0.000143678	0.00219791
0.219133	0.0211827	0.00155985	2.58E-05	0.000146019	0.0023635
0.225028	0.02085	0.00137832	1.34E-05	0.000146095	0.00225025
0.211554	0.014778	0.00187535	2.63E-05	0.000147548	0.00243009
0.204407	0.0148832	0.00111068	5.01E-05	0.000151411	0.00252335
0.203928	0.0214143	0.0005921	5.97E-05	0.000147662	0.00251673
0.196225	0.0146825	-0.0005395	6.84E-05	0.000148679	0.00255915
0.189394	0.0149359	-0.0009014	9.16E-05	0.000136006	0.00258067
0.19966	0.0215465	0.00045852	8.46E-05	0.00014334	0.00260668
0.188792	0.0216327	-0.0004035	9.68E-05	0.000134096	0.00261482
0.174144	0.0156081	-0.0015024	0.000110748	0.000124859	0.00257887
0.173606	0.0219915	-0.0010731	0.000119326	0.000121748	0.00258094
0.171309	0.0158867	-0.0012801	0.000121064	0.000119491	0.00254938
0.15913	0.0164249	-0.001738	0.000134348	0.000114387	0.00247532
0.158915	0.0163846	-0.0018607	0.000136855	0.000102025	0.00238197
0.165678	0.0225302	-0.0006124	0.000133628	0.000113377	0.00252597
0.158499	0.0223138	-0.0019811	0.000134941	8.83E-05	0.0023713

0.143926	0.0161593	-0.0034426	0.000136732	7.60E-05	0.00218003
0.143424	0.0227321	-0.0028624	0.00013561	6.86E-05	0.00214554
0.136087	0.0167012	-0.0027948	0.000142468	6.01E-05	0.00203148
0.128649	0.0170501	-0.0025193	0.000148485	3.89E-05	0.00177509
0.137578	0.0231169	-0.0026677	0.000141266	4.81E-05	0.00187541
0.128293	0.0234508	-0.0030498	0.000144993	3.59E-05	0.0017335
0.113647	0.0171668	-0.0033577	0.000146132	1.73E-05	0.00146029
0.1132	0.0240899	-0.0030257	0.00013849	7.28E-06	0.00132801
0.115472	0.0241682	-0.0029287	0.000149809	1.63E-05	0.00152905
0.11121	0.0171417	-0.0036009	0.000137545	9.70E-06	0.00125401
0.0987267	0.016738	-0.0045445	0.000125101	1.21E-05	0.000972338
0.0983132	0.0235137	-0.0039243	0.00012091	1.68E-05	0.000985957
0.0837442	0.0166468	-0.004728	0.000102766	2.56E-05	0.000613876
0.0833523	0.0233569	-0.0038573	0.00010691	2.64E-05	0.000618082
0.0687557	0.0169145	-0.0041327	8.48E-05	2.62E-05	0.000313869
0.068403	0.0234487	-0.0031812	9.84E-05	2.62E-05	0.000328351
0.0538664	0.0169254	-0.0041239	5.99E-05	1.52E-05	0.000137829
0.0535797	0.0231022	-0.0035576	6.82E-05	2.14E-05	0.000144207
0.0522493	0.017499	-0.0039238	5.54E-05	1.09E-05	9.51E-05
0.0522708	0.0171	-0.0037477	4.73E-05	8.09E-06	8.45E-05
0.052139	0.0193714	-0.0032192	6.23E-05	1.38E-05	0.000103928
0.0521084	0.0206578	-0.0038915	6.15E-05	1.37E-05	9.92E-05
0.0520198	0.0222628	-0.0038306	5.85E-05	1.58E-05	9.48E-05
0.0519574	0.0232455	-0.0031693	5.59E-05	1.79E-05	9.58E-05

Scaled Y beam3lb_0deg_fast_55.63Hz
Signal: FFT - Vib 3D Velocity - Magnitude
dB-Reference: 0 dB = 1 m/s
Band No.: 1
Frequency: 55.63 Hz

Interpolated: Yes
Filtered: Yes

X	Y	Z	Mag X	Mag Y	Mag Z
0.0623665	0.0177938	-0.00748538	5.18E-06	1.14E-05	1.05E-05
0.0622184	0.0161708	-0.00737526	2.66E-06	5.11E-06	8.69E-06
0.0619647	0.0145356	-0.00825757	1.44E-06	2.12E-06	9.23E-06
0.0617985	0.0129117	-0.00834246	1.41E-06	5.17E-06	9.73E-06
0.0616469	0.0112888	-0.00812533	1.58E-06	2.30E-06	1.14E-05
0.061425	0.00964912	-0.00880342	1.73E-06	9.26E-06	1.28E-05
0.0785495	0.0161476	-0.00857111	2.49E-06	5.75E-06	1.98E-05
0.0783367	0.0145118	-0.0092583	1.11E-06	8.01E-07	1.92E-05
0.0781974	0.0128758	-0.00884575	1.42E-06	1.18E-06	1.97E-05
0.078017	0.0112523	-0.00913006	1.64E-06	4.69E-06	2.14E-05
0.0779177	0.00961912	-0.00821492	2.04E-06	4.18E-06	2.25E-05
0.0777456	0.00799609	-0.00839541	1.55E-06	1.44E-06	2.28E-05
0.0947353	0.0144877	-0.0105469	1.21E-06	1.18E-06	3.39E-05

0.094637	0.0128521	-0.00943767	9.33E-07	1.95E-06	3.29E-05
0.0944797	0.0112163	-0.00942486	5.96E-07	3.42E-06	3.47E-05
0.0942696	0.00957924	-0.0100078	4.84E-07	2.35E-06	3.66E-05
0.0941655	0.00794808	-0.00899207	7.67E-07	1.40E-06	3.81E-05
0.0939431	0.00632055	-0.00997088	3.57E-07	1.44E-06	3.80E-05
0.111048	0.0128132	-0.011314	1.52E-06	3.41E-06	5.42E-05
0.110904	0.0111781	-0.0108032	1.83E-06	1.85E-06	5.40E-05
0.110752	0.00954207	-0.0106905	1.59E-06	4.70E-06	5.32E-05
0.110577	0.00790613	-0.0107746	6.92E-07	1.61E-06	5.43E-05
0.110383	0.00626563	-0.0114565	1.32E-07	1.91E-06	5.43E-05
0.110266	0.00463642	-0.010438	6.56E-07	1.60E-06	5.46E-05
0.127453	0.0111408	-0.0110691	7.16E-07	3.13E-06	8.08E-05
0.127334	0.00951038	-0.00975868	6.43E-07	9.78E-07	8.00E-05
0.127138	0.00787156	-0.0107449	1.57E-06	3.94E-06	7.84E-05
0.126916	0.00622914	-0.0120282	1.35E-06	3.06E-06	7.78E-05
0.126754	0.00459436	-0.0118106	1.14E-06	3.67E-06	7.80E-05
0.126605	0.00295938	-0.0115915	1.26E-06	1.95E-06	7.82E-05
0.143843	0.0094669	-0.0120076	6.10E-07	1.72E-06	0.00010904
0.14367	0.00783089	-0.0120963	7.41E-07	3.76E-06	0.000108996
0.143521	0.00619634	-0.0117833	1.25E-06	3.17E-06	0.000107846
0.143329	0.00454154	-0.0125673	1.24E-06	5.08E-06	0.000107684
0.143186	0.00291392	-0.01155	1.35E-06	4.65E-06	0.000107765
0.142984	0.0012614	-0.0132299	1.90E-06	3.49E-06	0.000107582
0.160297	0.0077957	-0.0121299	1.92E-06	4.49E-06	0.000136131
0.160126	0.00615979	-0.0122186	1.82E-06	2.49E-06	0.00013631
0.159961	0.00451368	-0.0118052	2.06E-06	1.03E-06	0.000136093
0.159803	0.0028772	-0.0118899	1.89E-06	2.08E-06	0.000136225
0.159618	0.00121759	-0.012972	2.38E-06	2.79E-06	0.000136095
0.159455	-0.00041316	-0.0124523	2.81E-06	3.02E-06	0.000135442
0.176606	0.00447513	-0.0124225	3.63E-06	4.38E-06	0.000157822
0.176436	0.00282417	-0.0126091	4.27E-06	1.60E-06	0.000162485
0.176279	0.00118165	-0.0131936	4.12E-06	1.29E-06	0.000163338
0.176108	-0.000469686	-0.0132759	1.42E-05	2.12E-06	0.000163188
0.175939	-0.00209878	-0.0126563	4.29E-06	1.62E-06	0.000162305
0.193135	0.00277903	-0.0139068	5.71E-06	4.48E-06	0.000189472
0.192972	0.00112171	-0.0144933	5.86E-06	3.60E-06	0.000189416
0.192791	-0.000506442	-0.0135781	1.61E-05	2.78E-05	0.000188632
0.192641	-0.0021656	-0.0141602	2.70E-05	7.09E-07	0.000190645
0.192476	-0.00382276	-0.0145403	1.75E-05	4.20E-07	0.00019336
0.209704	0.00108663	-0.0146704	7.82E-06	3.81E-06	0.000216052
0.209549	-0.000567951	-0.0147566	8.99E-06	2.89E-05	0.000215401
0.209379	-0.00222077	-0.0147411	9.99E-06	5.26E-05	0.000215797
0.209222	-0.00386684	-0.0152234	1.73E-05	2.58E-05	0.000220695
0.209033	-0.00550959	-0.014504	8.07E-06	2.19E-06	0.000230432
0.226318	-0.000618912	-0.0151115	5.81E-05	0.000107673	0.000230841
0.226156	-0.00226176	-0.0152982	8.51E-06	3.36E-06	0.000231977
0.225982	-0.00391461	-0.0151828	9.67E-06	2.41E-05	0.000233938
0.225828	-0.00557094	-0.0152646	1.18E-05	7.28E-06	0.000239745
0.225654	-0.00722347	-0.0151449	9.15E-06	4.61E-06	0.000244743
0.225495	-0.00886913	-0.015423	9.90E-06	2.86E-06	0.000246504
0.242951	-0.00230944	-0.0153304	0.000109205	0.000323432	0.000253636
0.242807	-0.00397177	-0.0158164	5.04E-05	9.16E-05	0.000253274

0.24262	-0.0056231	-0.0155014	1.26E-05	9.15E-06	0.000257958
0.242552	-0.00729382	-0.0171808	1.63E-05	2.23E-05	0.000257359
0.242314	-0.00892823	-0.015863	1.39E-05	9.00E-06	0.000257619
0.242221	-0.0105992	-0.0173391	6.34E-05	0.000212862	0.000260152
0.259676	-0.00403121	-0.0167241	6.08E-05	0.000321351	0.000271248
0.259552	-0.00570037	-0.0174093	1.13E-05	8.85E-05	0.000272473
0.259414	-0.00735421	-0.0178929	1.19E-05	4.24E-06	0.000276764
0.259204	-0.00900047	-0.0170763	1.53E-05	1.00E-05	0.000280008
0.25902	-0.0106554	-0.016857	5.46E-05	0.000171484	0.000281256
0.258915	-0.0123069	-0.0178333	0.00012007	0.00042002	0.000283801
0.276402	-0.0057297	-0.017094	1.25E-05	0.000105588	0.00028103
0.276255	-0.00739517	-0.0173798	1.24E-05	4.36E-06	0.000280095
0.276147	-0.00907035	-0.0181618	1.30E-05	5.59E-06	0.000284601
0.275928	-0.0107206	-0.0175462	1.32E-05	7.03E-06	0.000285607
0.275811	-0.012365	-0.0180243	1.37E-05	6.91E-06	0.000286705
0.275671	-0.0140354	-0.0184012	6.55E-05	0.00020542	0.000289168
0.293059	-0.00912152	-0.0182224	1.35E-05	4.26E-06	0.00028602
0.29288	-0.0107696	-0.0181076	1.40E-05	5.69E-06	0.000288395
0.292703	-0.0124298	-0.0178897	1.40E-05	6.09E-06	0.000288489
0.292642	-0.0141055	-0.019065	1.44E-05	5.04E-06	0.000288028
0.292471	-0.0157565	-0.0190434	1.48E-05	6.44E-06	0.000291301
0.309933	-0.0108425	-0.019237	1.46E-05	7.36E-06	0.000290672
0.309761	-0.0125098	-0.0192217	1.46E-05	7.28E-06	0.00029085
0.309614	-0.0141661	-0.0193024	1.47E-05	7.46E-06	0.000289104
0.309464	-0.0158241	-0.0194818	1.52E-05	2.85E-06	0.000290033
0.309281	-0.0174892	-0.0193606	1.56E-05	4.41E-06	0.000292791
0.309123	-0.0191434	-0.0193355	1.58E-05	8.68E-06	0.000294197
0.326886	-0.0125885	-0.0205222	1.58E-05	1.06E-05	0.000291869
0.32655	-0.0142277	-0.019016	1.59E-05	1.12E-05	0.000291399
0.326462	-0.0158857	-0.0196939	1.57E-05	9.85E-06	0.000288036
0.326244	-0.0175323	-0.0192775	1.56E-05	6.30E-06	0.000287045
0.326179	-0.0192232	-0.0200483	1.59E-05	6.00E-06	0.000290058
0.325971	-0.0208719	-0.0197268	1.64E-05	1.02E-05	0.000289638
0.343489	-0.0159456	-0.0198783	1.64E-05	1.14E-05	0.000283901
0.343527	-0.0176441	-0.0214469	1.65E-05	1.19E-05	0.000278589
0.343197	-0.0192866	-0.020137	1.63E-05	1.18E-05	0.000279552
0.343208	-0.020984	-0.0215031	1.64E-05	1.22E-05	0.000283254
0.342957	-0.0226284	-0.0208848	1.68E-05	1.30E-05	0.000284514
0.34281	-0.0243065	-0.0209561	1.69E-05	1.24E-05	0.00028275
0.360363	-0.0176638	-0.0199202	1.71E-05	1.20E-05	0.000271451
0.360478	-0.0193917	-0.0218814	1.73E-05	1.26E-05	0.000269995
0.360132	-0.0210221	-0.020574	1.74E-05	1.45E-05	0.000269785
0.360031	-0.0226995	-0.0210471	1.71E-05	1.45E-05	0.000271596
0.36003	-0.0243988	-0.0222106	1.66E-05	1.48E-05	0.000270033
0.35974	-0.0260508	-0.0212923	1.66E-05	1.45E-05	0.00026757
0.377242	-0.0210928	-0.0209073	1.75E-05	1.43E-05	0.00026178
0.37727	-0.0227944	-0.0220706	1.77E-05	1.48E-05	0.000261152
0.37691	-0.0244273	-0.0208644	1.73E-05	1.50E-05	0.00026062
0.376939	-0.0261343	-0.0221243	1.68E-05	1.36E-05	0.000257646
0.376841	-0.0278162	-0.0224913	1.64E-05	1.35E-05	0.000253209
0.394363	-0.0228418	-0.0219813	1.71E-05	1.78E-05	0.000234772
0.394224	-0.0245196	-0.022159	1.74E-05	1.86E-05	0.000236178

0.394114	-0.0262016	-0.0224308	1.73E-05	1.72E-05	0.000238863
0.393957	-0.0278773	-0.0225057	1.72E-05	1.55E-05	0.000240856
0.393847	-0.0295605	-0.0227733	1.71E-05	1.41E-05	0.000240607
0.393773	-0.031254	-0.0233365	1.67E-05	1.41E-05	0.000240019
0.411384	-0.0245886	-0.0222402	1.64E-05	1.91E-05	0.000202915
0.411356	-0.0262894	-0.0230071	1.64E-05	1.86E-05	0.000202879
0.41125	-0.0279628	-0.0232783	1.64E-05	1.87E-05	0.000204768
0.411294	-0.0296802	-0.0244341	1.65E-05	1.75E-05	0.000206808
0.41095	-0.031325	-0.0234232	1.67E-05	1.72E-05	0.000206679
0.41081	-0.0330097	-0.023592	1.61E-05	1.77E-05	0.000203251
0.428429	-0.0280345	-0.0232364	1.59E-05	1.92E-05	0.000182415
0.428372	-0.0297219	-0.0238035	1.59E-05	1.98E-05	0.000179643
0.428099	-0.0313868	-0.0232899	1.60E-05	1.95E-05	0.000178876
0.428171	-0.033098	-0.0244382	1.61E-05	1.92E-05	0.000177551
0.427878	-0.0347586	-0.0238224	1.56E-05	1.94E-05	0.000178499
0.427987	-0.0364812	-0.0251625	1.55E-05	2.00E-05	0.000179556
0.445676	-0.0298118	-0.0242272	1.57E-05	2.12E-05	0.000151456
0.445439	-0.0314745	-0.0239129	1.58E-05	2.20E-05	0.000151737
0.445132	-0.0331228	-0.0232026	1.61E-05	2.11E-05	0.000153354
0.445121	-0.0348383	-0.0239592	1.62E-05	2.02E-05	0.000154645
0.444875	-0.0364962	-0.023538	1.58E-05	2.05E-05	0.000157112
0.444926	-0.0382119	-0.0245839	1.53E-05	2.18E-05	0.000151093
0.462652	-0.0332384	-0.0244844	1.55E-05	2.16E-05	0.000128382
0.462358	-0.0348949	-0.0238734	1.52E-05	2.09E-05	0.000124706
0.462269	-0.0365875	-0.0242382	1.54E-05	2.09E-05	0.000125068
0.462259	-0.0382936	-0.0248903	1.53E-05	2.10E-05	0.0001253
0.462016	-0.0399598	-0.0245685	1.46E-05	2.22E-05	0.000125508
0.461926	-0.0416546	-0.024927	1.43E-05	2.31E-05	0.000125556
0.479765	-0.0349887	-0.0244466	1.38E-05	1.98E-05	9.42E-05
0.479774	-0.0367023	-0.0252011	1.36E-05	1.98E-05	9.41E-05
0.479634	-0.0383909	-0.0252699	1.37E-05	1.99E-05	9.45E-05
0.479317	-0.0400361	-0.0246601	1.37E-05	2.04E-05	9.56E-05
0.479431	-0.0417704	-0.0257937	1.27E-05	2.09E-05	9.65E-05
0.479321	-0.043468	-0.0260539	1.23E-05	2.25E-05	9.17E-05
0.497173	-0.0367912	-0.0255552	1.24E-05	1.92E-05	6.55E-05
0.497034	-0.0384712	-0.0256261	1.21E-05	1.93E-05	6.56E-05
0.496856	-0.0401609	-0.0256011	1.24E-05	1.98E-05	6.64E-05
0.496814	-0.041858	-0.0260553	1.21E-05	1.93E-05	6.70E-05
0.496757	-0.0435698	-0.0265105	1.10E-05	1.93E-05	6.38E-05
0.496469	-0.0452246	-0.0259918	1.05E-05	2.00E-05	5.54E-05
0.514223	-0.0402327	-0.0256422	1.20E-05	1.79E-05	4.45E-05
0.514199	-0.0419389	-0.0261969	1.17E-05	1.94E-05	4.10E-05
0.513726	-0.0435693	-0.0250081	1.13E-05	1.98E-05	4.17E-05
0.514008	-0.0453294	-0.0267173	1.01E-05	1.90E-05	4.22E-05
0.513764	-0.0470128	-0.0263928	9.44E-06	2.03E-05	3.85E-05
0.513648	-0.0487045	-0.0265495	9.28E-06	1.90E-05	3.78E-05
0.53129	-0.0419669	-0.0251611	1.17E-05	1.55E-05	2.33E-05
0.531259	-0.0436752	-0.0256139	1.13E-05	1.77E-05	2.29E-05
0.531335	-0.0454024	-0.0264495	1.07E-05	1.85E-05	2.37E-05
0.531182	-0.0470946	-0.0265171	9.43E-06	1.85E-05	2.45E-05
0.531229	-0.0488204	-0.0272523	8.51E-06	1.83E-05	2.50E-05
0.531021	-0.0505042	-0.0271234	8.15E-06	1.72E-05	2.62E-05

Scaled Y beam3lb_0deg_fast_154.4Hz
Signal: FFT - Vib 3D Velocity - Magnitude
dB-Reference: 0 dB = 1 m/s
Band No.: 1
Frequency: 154.4 Hz

Interpolated: Yes
Filtered: Yes

X	Y	Z	Mag X	Mag Y	Mag Z
0.0623665	0.0177938	-0.00748538	1.63E-05	2.36E-05	0.000394349
0.0622184	0.0161708	-0.00737526	1.52E-05	2.50E-05	0.000373551
0.0619647	0.0145356	-0.00825757	1.31E-05	1.43E-05	0.000381102
0.0617985	0.0129117	-0.00834246	1.42E-05	1.52E-05	0.000383466
0.0616469	0.0112888	-0.00812533	1.28E-05	1.62E-05	0.000375086
0.061425	0.00964912	-0.00880342	9.55E-06	2.51E-05	0.000393316
0.0785495	0.0161476	-0.00857111	7.99E-06	2.23E-05	0.000791838
0.0783367	0.0145118	-0.0092583	9.70E-06	5.09E-05	0.000787644
0.0781974	0.0128758	-0.00884575	1.62E-05	5.23E-05	0.000791852
0.078017	0.0112523	-0.00913006	1.76E-05	5.09E-05	0.00079277
0.0779177	0.00961912	-0.00821492	2.34E-05	4.28E-05	0.000792102
0.0777456	0.00799609	-0.00839541	1.75E-05	2.88E-05	0.000796239
0.0947353	0.0144877	-0.0105469	2.88E-05	3.64E-05	0.00145569
0.094637	0.0128521	-0.00943767	1.63E-05	8.72E-05	0.00145177
0.0944797	0.0112163	-0.00942486	9.56E-06	0.000100364	0.00145487
0.0942696	0.00957924	-0.0100078	9.01E-06	0.000105823	0.00145565
0.0941655	0.00794808	-0.00899207	9.93E-06	8.77E-05	0.00145654
0.0939431	0.00632055	-0.00997088	1.47E-05	6.98E-05	0.0014626
0.111048	0.0128132	-0.011314	6.53E-05	4.34E-05	0.00223584
0.110904	0.0111781	-0.0108032	5.26E-05	9.60E-05	0.00223173
0.110752	0.00954207	-0.0106905	5.69E-05	9.83E-05	0.00222987
0.110577	0.00790613	-0.0107746	6.33E-05	7.81E-05	0.00223085
0.110383	0.00626563	-0.0114565	6.63E-05	6.67E-05	0.00223252
0.110266	0.00463642	-0.010438	6.93E-05	4.69E-05	0.00223452
0.127453	0.0111408	-0.0110691	9.00E-05	6.66E-05	0.00304892
0.127334	0.00951038	-0.00975868	8.65E-05	8.47E-05	0.00303372
0.127138	0.00787156	-0.0107449	0.000100337	5.25E-05	0.00304731
0.126916	0.00622914	-0.0120282	0.000112251	9.67E-06	0.0030438
0.126754	0.00459436	-0.0118106	0.000112072	8.87E-06	0.00304627
0.126605	0.00295938	-0.0115915	0.000115682	2.72E-06	0.00304544
0.143843	0.0094669	-0.0120076	0.000126796	3.34E-05	0.00377678
0.14367	0.00783089	-0.0120963	0.000127664	9.27E-06	0.00377241
0.143521	0.00619634	-0.0117833	0.000141121	9.80E-06	0.00379483
0.143329	0.00454154	-0.0125673	0.000141845	2.12E-05	0.00379977
0.143186	0.00291392	-0.01155	0.000149184	5.21E-06	0.00381881
0.142984	0.0012614	-0.0132299	0.000155437	1.30E-05	0.00381597
0.160297	0.0077957	-0.0121299	0.000148422	6.07E-05	0.00443088
0.160126	0.00615979	-0.0122186	0.000150649	4.89E-05	0.00442559
0.159961	0.00451368	-0.0118052	0.000156624	5.12E-05	0.00443564
0.159803	0.0028772	-0.0118899	0.000162563	4.75E-05	0.00442562

0.159618	0.00121759	-0.012972	0.000172295	3.79E-05	0.004444
0.159455	-0.00041316	-0.0124523	0.00018199	2.36E-05	0.00445445
0.176606	0.00447513	-0.0124225	0.00018834	8.62E-05	0.00480965
0.176436	0.00282417	-0.0126091	0.000206836	9.67E-05	0.00489616
0.176279	0.00118165	-0.0131936	0.000217534	9.83E-05	0.00490625
0.176108	-0.000469686	-0.0132759	0.000222168	8.76E-05	0.0049257
0.175939	-0.00209878	-0.0126563	0.000223275	7.71E-05	0.00491891
0.193135	0.00277903	-0.0139068	0.000254588	0.000134172	0.00505577
0.192972	0.00112171	-0.0144933	0.000263796	0.000136891	0.00508126
0.192791	-0.000506442	-0.0135781	0.00027341	0.000136675	0.00512456
0.192641	-0.0021656	-0.0141602	0.000275995	0.000133387	0.00515953
0.192476	-0.00382276	-0.0145403	0.000277549	0.000128082	0.00509741
0.209704	0.00108663	-0.0146704	0.000298737	0.000206868	0.00501426
0.209549	-0.000567951	-0.0147566	0.000303845	0.00020624	0.00503594
0.209379	-0.00222077	-0.0147411	0.00031276	0.000210002	0.00508112
0.209222	-0.00386684	-0.0152234	0.000318177	0.00020992	0.00507418
0.209033	-0.00550959	-0.014504	0.000333429	0.000222427	0.00499891
0.226318	-0.000618912	-0.0151115	0.00034344	0.000299835	0.00477487
0.226156	-0.00226176	-0.0152982	0.000346109	0.000296146	0.00480124
0.225982	-0.00391461	-0.0151828	0.000341802	0.000295143	0.00481155
0.225828	-0.00557094	-0.0152646	0.000351664	0.000295593	0.00483092
0.225654	-0.00722347	-0.0151449	0.000356399	0.000293109	0.00479074
0.225495	-0.00886913	-0.015423	0.000360408	0.00029289	0.00477434
0.242951	-0.00230944	-0.0153304	0.000370788	0.000397937	0.0042721
0.242807	-0.00397177	-0.0158164	0.000362647	0.00038933	0.00428309
0.24262	-0.0056231	-0.0155014	0.000349476	0.000394069	0.00427101
0.242552	-0.00729382	-0.0171808	0.000353027	0.000396704	0.00426489
0.242314	-0.00892823	-0.015863	0.000357973	0.000412402	0.00426378
0.242221	-0.0105992	-0.0173391	0.000358553	0.000413046	0.0042575
0.259676	-0.00403121	-0.0167241	0.000352189	0.00048877	0.00351377
0.259552	-0.00570037	-0.0174093	0.000345056	0.000490273	0.00351903
0.259414	-0.00735421	-0.0178929	0.000341179	0.000493572	0.00350885
0.259204	-0.00900047	-0.0170763	0.000356151	0.000511834	0.00350685
0.25902	-0.0106554	-0.016857	0.00035379	0.000539469	0.00350044
0.258915	-0.0123069	-0.0178333	0.000355237	0.000558481	0.00348905
0.276402	-0.0057297	-0.017094	0.000340742	0.000575297	0.00253697
0.276255	-0.00739517	-0.0173798	0.00034131	0.000578388	0.00253788
0.276147	-0.00907035	-0.0181618	0.000349201	0.000591338	0.00253859
0.275928	-0.0107206	-0.0175462	0.000348665	0.000595396	0.00253825
0.275811	-0.012365	-0.0180243	0.000332175	0.000619744	0.00253818
0.275671	-0.0140354	-0.0184012	0.000328416	0.000640852	0.00229473
0.293059	-0.00912152	-0.0182224	0.000324718	0.000653725	0.00162481
0.29288	-0.0107696	-0.0181076	0.000332965	0.000682275	0.00143876
0.292703	-0.0124298	-0.0178897	0.000328499	0.000703492	0.001433
0.292642	-0.0141055	-0.019065	0.000312044	0.000692576	0.0012316
0.292471	-0.0157565	-0.0190434	0.000303358	0.000707324	0.000831636
0.309933	-0.0108425	-0.019237	0.000279102	0.000755715	0.0002651
0.309761	-0.0125098	-0.0192217	0.000288258	0.00077145	0.000262926
0.309614	-0.0141661	-0.0193024	0.000295434	0.000781516	0.000254323
0.309464	-0.0158241	-0.0194818	0.000281658	0.000757112	0.000250189
0.309281	-0.0174892	-0.0193606	0.000283284	0.000746824	4.64E-05
0.309123	-0.0191434	-0.0193355	0.000284635	0.000752019	7.20E-06

0.326886	-0.0125885	-0.0205222	0.000239132	0.000823855	0.000920812
0.32655	-0.0142277	-0.019016	0.000250225	0.00082519	0.000927668
0.326462	-0.0158857	-0.0196939	0.000262657	0.000841642	0.00094241
0.326244	-0.0175323	-0.0192775	0.000246273	0.000826457	0.000948215
0.326179	-0.0192232	-0.0200483	0.000238987	0.000844069	0.000954933
0.325971	-0.0208719	-0.0197268	0.000227874	0.000849715	0.0011606
0.343489	-0.0159456	-0.0198783	0.000207736	0.000853969	0.0018711
0.343527	-0.0176441	-0.0214469	0.000216058	0.000857777	0.00206976
0.343197	-0.0192866	-0.020137	0.000180345	0.000864483	0.00208482
0.343208	-0.020984	-0.0215031	0.000173278	0.000876319	0.0020952
0.342957	-0.0226284	-0.0208848	0.000166354	0.000886295	0.00211506
0.34281	-0.0243065	-0.0209561	0.000173743	0.000897344	0.00211591
0.360363	-0.0176638	-0.0199202	0.000140058	0.000869174	0.00305237
0.360478	-0.0193917	-0.0218814	0.000144022	0.000862106	0.00305764
0.360132	-0.0210221	-0.020574	0.000125145	0.000846076	0.00305942
0.360031	-0.0226995	-0.0210471	0.000118421	0.000862902	0.00307756
0.36003	-0.0243988	-0.0222106	0.000107454	0.00087788	0.00310449
0.35974	-0.0260508	-0.0212923	0.000105811	0.000897776	0.00311579
0.377242	-0.0210928	-0.0209073	9.17E-05	0.000873188	0.00374268
0.37727	-0.0227944	-0.0220706	6.74E-05	0.000872044	0.00388617
0.37691	-0.0244273	-0.0208644	7.23E-05	0.000870445	0.00390182
0.376939	-0.0261343	-0.0221243	6.18E-05	0.000875106	0.00391684
0.376841	-0.0278162	-0.0224913	4.57E-05	0.000856475	0.0040406
0.394363	-0.0228418	-0.0219813	2.70E-05	0.000829178	0.00446855
0.394224	-0.0245196	-0.022159	2.09E-05	0.000832533	0.00449067
0.394114	-0.0262016	-0.0224308	1.32E-05	0.000841495	0.00451806
0.393957	-0.0278773	-0.0225057	1.41E-05	0.000843021	0.00453951
0.393847	-0.0295605	-0.0227733	4.41E-06	0.000832105	0.0045529
0.393773	-0.031254	-0.0233365	1.97E-06	0.00080001	0.00455472
0.411384	-0.0245886	-0.0222402	2.61E-05	0.000746843	0.00479125
0.411356	-0.0262894	-0.0230071	3.35E-05	0.00075209	0.00480518
0.41125	-0.0279628	-0.0232783	3.71E-05	0.000762017	0.0048393
0.411294	-0.0296802	-0.0244341	3.74E-05	0.000775813	0.00485651
0.41095	-0.031325	-0.0234232	4.52E-05	0.000768193	0.00487726
0.41081	-0.0330097	-0.023592	5.81E-05	0.00073269	0.00489405
0.428429	-0.0280345	-0.0232364	7.20E-05	0.000688031	0.0048366
0.428372	-0.0297219	-0.0238035	8.49E-05	0.000686915	0.00486181
0.428099	-0.0313868	-0.0232899	9.01E-05	0.000682784	0.00489114
0.428171	-0.033098	-0.0244382	9.91E-05	0.000685888	0.00489786
0.427878	-0.0347586	-0.0238224	0.000100202	0.000670546	0.00491395
0.427987	-0.0364812	-0.0251625	0.000103634	0.000667119	0.00491653
0.445676	-0.0298118	-0.0242272	0.000118726	0.000571672	0.00461414
0.445439	-0.0314745	-0.0239129	0.000124346	0.000568324	0.00464311
0.445132	-0.0331228	-0.0232026	0.000140571	0.000560962	0.0046673
0.445121	-0.0348383	-0.0239592	0.000148879	0.000556847	0.0046921
0.444875	-0.0364962	-0.023538	0.000148667	0.000569089	0.00470133
0.444926	-0.0382119	-0.0245839	0.000158199	0.00054236	0.00463009
0.462652	-0.0332384	-0.0244844	0.000147684	0.000454337	0.00425273
0.462358	-0.0348949	-0.0238734	0.000168944	0.000426588	0.00419564
0.462269	-0.0365875	-0.0242382	0.000176927	0.000440156	0.00421191
0.462259	-0.0382936	-0.0248903	0.000179032	0.000453709	0.00422306
0.462016	-0.0399598	-0.0245685	0.000182798	0.000437822	0.00423009

0.461926	-0.0416546	-0.024927	0.000185208	0.000428478	0.00422961
0.479765	-0.0349887	-0.0244466	0.000172322	0.000277224	0.00348859
0.479774	-0.0367023	-0.0252011	0.00018043	0.0002811	0.00349561
0.479634	-0.0383909	-0.0252699	0.000185417	0.000294657	0.00351127
0.479317	-0.0400361	-0.0246601	0.00018636	0.000305413	0.00352768
0.479431	-0.0417704	-0.0257937	0.000185911	0.000284596	0.00353893
0.479321	-0.043468	-0.0260539	0.000194465	0.000247531	0.00354152
0.497173	-0.0367912	-0.0255552	0.000181852	0.000144285	0.00267577
0.497034	-0.0384712	-0.0256261	0.000184689	0.000145412	0.00267825
0.496856	-0.0401609	-0.0256011	0.000188328	0.000150916	0.00268514
0.496814	-0.041858	-0.0260553	0.000189713	0.0001557	0.00270226
0.496757	-0.0435698	-0.0265105	0.000198144	0.000123007	0.00271246
0.496469	-0.0452246	-0.0259918	0.000204153	6.74E-05	0.00257067
0.514223	-0.0402327	-0.0256422	0.000196313	3.48E-05	0.00194668
0.514199	-0.0419389	-0.0261969	0.000196026	1.47E-05	0.00180933
0.513726	-0.0435693	-0.0250081	0.000199209	1.43E-05	0.00182634
0.514008	-0.0453294	-0.0267173	0.000200099	1.26E-05	0.00183595
0.513764	-0.0470128	-0.0263928	0.000205959	2.29E-05	0.00184433
0.513648	-0.0487045	-0.0265495	0.000209315	2.79E-05	0.00185197
0.53129	-0.0419669	-0.0251611	0.000208788	8.43E-05	0.00113459
0.531259	-0.0436752	-0.0256139	0.000200758	8.76E-05	0.00110511
0.531335	-0.0454024	-0.0264495	0.000192973	8.40E-05	0.00112777
0.531182	-0.0470946	-0.0265171	0.000198375	8.15E-05	0.00114072
0.531229	-0.0488204	-0.0272523	0.00019451	8.15E-05	0.00115274
0.531021	-0.0505042	-0.0271234	0.000205233	7.62E-05	0.00120628

Source File

Name: beam3lb_15deg_fast_39.38Hz
Signal: FFT - Vib 3D Velocity - Magnitude
dB-Reference: 0 dB = 1 m/s
Band No.: 1
Frequency: 39.38 Hz

Interpolated: Yes
Filtered: Yes

X	Y	Z	Mag X	Mag Y	Mag Z
0.0549392	0.0228373	-0.00629466	3.49E-05	1.77E-05	1.98E-05
0.0780733	0.0225747	-0.00487476	3.63E-05	2.30E-05	4.10E-05
0.0781382	0.0202145	-0.00469857	3.59E-05	2.23E-05	4.16E-05
0.0550104	0.0204406	-0.00592189	3.40E-05	1.64E-05	1.77E-05
0.0779724	0.0247563	-0.00447577	3.67E-05	2.15E-05	4.09E-05
0.101173	0.0246712	-0.00371792	3.97E-05	2.87E-05	7.97E-05
0.101215	0.0222476	-0.00325051	4.02E-05	3.03E-05	8.08E-05
0.101314	0.0200485	-0.00365014	3.96E-05	3.06E-05	8.18E-05
0.124387	0.0244582	-0.00245961	4.32E-05	3.66E-05	0.000129061
0.124461	0.0222313	-0.00276611	4.46E-05	3.99E-05	0.000131925
0.124456	0.0195503	-0.00143324	4.49E-05	4.00E-05	0.000133825

0.147741	0.0246739	-0.00282433	4.59E-05	4.73E-05	0.000172551
0.147738	0.0221136	-0.0018753	4.78E-05	5.20E-05	0.000183638
0.147823	0.0199391	-0.00237044	4.80E-05	5.44E-05	0.000189065
0.171161	0.0223856	-0.00240845	4.84E-05	5.99E-05	0.000229618
0.17112	0.0197544	-0.00126966	4.96E-05	6.42E-05	0.000241613
0.19461	0.0224297	-0.0021508	4.80E-05	6.66E-05	0.000260589
0.194665	0.0201694	-0.00235763	4.96E-05	7.22E-05	0.00028381
0.194668	0.0177415	-0.00188328	4.96E-05	7.30E-05	0.000289149
0.171213	0.0176048	-0.00185723	4.96E-05	6.53E-05	0.000248599
0.218089	0.020082	-0.00159716	4.96E-05	8.31E-05	0.000330446
0.218247	0.0180314	-0.00256512	4.95E-05	8.34E-05	0.000331755
0.241956	0.0183943	-0.00340054	4.90E-05	8.99E-05	0.000358171
0.241876	0.0158632	-0.00264566	4.88E-05	9.12E-05	0.000360197
0.218207	0.0155754	-0.00199472	4.92E-05	8.48E-05	0.000338308
0.265722	0.018688	-0.00401815	4.78E-05	9.44E-05	0.000372489
0.265652	0.0162051	-0.00345672	4.74E-05	9.71E-05	0.000376393
0.28958	0.0166345	-0.00461992	4.69E-05	0.00010069	0.000383076
0.289464	0.014096	-0.00386691	4.63E-05	9.81E-05	0.000384733
0.265859	0.0142477	-0.00480203	4.62E-05	9.59E-05	0.000379193
0.313814	0.0150406	-0.00689741	4.68E-05	9.96E-05	0.000378797
0.313679	0.0125148	-0.00613982	4.60E-05	9.76E-05	0.000382013
0.289654	0.0120719	-0.0049143	4.55E-05	9.66E-05	0.00039421
0.337932	0.0130928	-0.00789873	4.69E-05	9.82E-05	0.000364254
0.337778	0.0105627	-0.00714136	4.66E-05	9.77E-05	0.000364731
0.313662	0.0101279	-0.0059515	4.56E-05	9.83E-05	0.000386019
0.362157	0.0111824	-0.00905359	4.77E-05	9.64E-05	0.000336923
0.362159	0.00887783	-0.00914947	4.81E-05	9.66E-05	0.000334575
0.337965	0.00850441	-0.00818989	4.76E-05	9.96E-05	0.000367177
0.386671	0.00951085	-0.0111149	4.96E-05	9.06E-05	0.000297034
0.386707	0.00723082	-0.0114039	5.04E-05	8.92E-05	0.000294625
0.362083	0.00645367	-0.00886809	4.82E-05	9.55E-05	0.000336879
0.411435	0.00797711	-0.0137998	5.32E-05	8.07E-05	0.000246883
0.411135	0.00530185	-0.0125707	5.32E-05	8.25E-05	0.000244624
0.386617	0.00479156	-0.0110195	5.14E-05	9.07E-05	0.00029661
0.435783	0.00583216	-0.0141739	5.69E-05	7.34E-05	0.000195349
0.435922	0.00365325	-0.0148272	5.83E-05	7.41E-05	0.000189974
0.411123	0.00298242	-0.0126619	5.38E-05	8.31E-05	0.00024431
0.460883	0.00436749	-0.0171354	6.08E-05	6.48E-05	0.00013608
0.460662	0.00183041	-0.0164792	6.20E-05	6.26E-05	0.000131442
0.435996	0.00142436	-0.0152941	5.91E-05	7.33E-05	0.000188134
0.486066	0.00283029	-0.0199642	6.83E-05	5.28E-05	8.24E-05
0.485846	0.000302043	-0.0193009	6.81E-05	5.06E-05	8.23E-05
0.460808	-0.000333836	-0.0172259	6.29E-05	6.14E-05	0.000133959
0.511071	0.00100394	-0.0216114	7.20E-05	4.06E-05	3.88E-05
0.510763	-0.0015987	-0.020774	7.22E-05	3.89E-05	4.01E-05
0.485866	-0.00199664	-0.0195783	6.83E-05	4.96E-05	8.33E-05
0.521174	-0.00590469	-0.0222737	7.52E-05	3.41E-05	2.88E-05

0.532344	-0.00556036	-0.0234564	7.51E-05	3.09E-05	1.92E-05
0.53261	-0.00665513	-0.0235515	7.54E-05	3.08E-05	2.19E-05
0.531736	-0.00323504	-0.0232517	7.42E-05	3.22E-05	1.69E-05
0.510829	-0.00519119	-0.0212627	7.42E-05	4.06E-05	4.58E-05
0.511067	-0.00364639	-0.0219722	7.39E-05	3.91E-05	4.11E-05
0.531464	-0.000636824	-0.0241627	7.39E-05	2.97E-05	1.25E-05
0.513825	0.00126327	-0.0225661	7.32E-05	3.78E-05	2.23E-05
0.531034	-0.000243787	-0.0232202	7.40E-05	3.05E-05	9.13E-06
0.511338	0.00147453	-0.0224841	7.22E-05	4.34E-05	3.57E-05
0.497447	-0.00378757	-0.0216271	7.23E-05	4.45E-05	6.12E-05
0.48564	-0.0034438	-0.0188423	6.77E-05	5.17E-05	8.83E-05
0.490004	0.00289291	-0.0201401	7.07E-05	5.06E-05	6.19E-05
0.486291	0.00342667	-0.0207077	6.84E-05	5.48E-05	8.12E-05
0.472862	-0.00255002	-0.0176006	6.55E-05	5.64E-05	0.00010882
0.460595	-0.00168451	-0.0164635	6.28E-05	6.33E-05	0.000140998
0.466137	0.00434649	-0.0170395	6.30E-05	6.13E-05	0.000112535
0.460659	0.00467039	-0.0162594	6.01E-05	6.45E-05	0.000134575
0.449188	-0.000575854	-0.0164517	6.12E-05	6.79E-05	0.00016147
0.435889	0.000268215	-0.0148818	5.87E-05	7.44E-05	0.000193719
0.442648	0.00605576	-0.0149604	5.78E-05	6.83E-05	0.000170006
0.436054	0.00678882	-0.0152344	5.72E-05	6.99E-05	0.000185798
0.425215	0.000958775	-0.0136879	5.63E-05	7.89E-05	0.000217063
0.41122	0.002147	-0.0130734	5.28E-05	8.37E-05	0.000248867
0.41938	0.00768484	-0.0125442	5.47E-05	7.60E-05	0.000223968
0.428904	0.00731326	-0.01461	5.67E-05	7.20E-05	0.000201847
0.411291	0.00866179	-0.0131183	5.34E-05	7.98E-05	0.000241712
0.401491	0.00262331	-0.0114695	5.12E-05	8.63E-05	0.000266761
0.3863	0.00357309	-0.00961574	5.07E-05	9.10E-05	0.00029805
0.396898	0.00980834	-0.0120606	5.09E-05	8.68E-05	0.000273621
0.386574	0.0104333	-0.0106749	4.93E-05	9.06E-05	0.000293819
0.378167	0.00462462	-0.010556	5.04E-05	9.32E-05	0.000318004
0.36198	0.00558079	-0.00838478	4.82E-05	9.53E-05	0.000340787
0.374084	0.0114148	-0.0096955	4.83E-05	9.48E-05	0.00031953
0.362175	0.0124377	-0.00913116	4.81E-05	9.69E-05	0.000333705
0.35473	0.00640494	-0.0087758	4.75E-05	9.70E-05	0.000353769
0.337815	0.00764661	-0.00739672	4.79E-05	9.97E-05	0.000369834
0.351713	0.0134775	-0.00903954	4.80E-05	9.86E-05	0.000352242
0.338012	0.0146575	-0.00840444	4.79E-05	9.92E-05	0.00036016
0.331615	0.00846212	-0.00812342	4.75E-05	0.00010092	0.000375977
0.313588	0.00949077	-0.00561168	4.61E-05	0.000100784	0.000387339
0.329432	0.0155913	-0.00858525	4.77E-05	0.000101296	0.000368465
0.313854	0.0163786	-0.00715417	4.72E-05	0.000102285	0.000381844
0.325485	0.0151794	-0.00583818	4.74E-05	0.000103081	0.000372402
0.308278	0.0100475	-0.00574615	4.55E-05	0.000100416	0.000397443
0.289647	0.0116297	-0.00493111	4.55E-05	9.81E-05	0.000402307
0.299459	0.0168395	-0.00516243	4.68E-05	0.00010198	0.000385198
0.289624	0.0174539	-0.00491174	4.69E-05	0.000100404	0.000382816

0.285278	0.0120117	-0.00478451	4.56E-05	9.66E-05	0.000394293
0.265897	0.0139484	-0.00498314	4.59E-05	9.65E-05	0.000383148
0.268731	0.0187627	-0.00429145	4.73E-05	9.58E-05	0.000376394
0.265686	0.0188604	-0.00387085	4.78E-05	9.35E-05	0.000371541
0.260457	0.0137864	-0.0031919	4.69E-05	9.32E-05	0.000376983
0.263936	0.0137085	-0.00344818	4.64E-05	9.56E-05	0.000383033
0.241787	0.0142153	-0.00185587	4.85E-05	8.89E-05	0.00036068
0.241953	0.0204718	-0.00355704	4.89E-05	9.09E-05	0.000362302
0.218263	0.0153848	-0.00235368	4.93E-05	8.38E-05	0.000339497
0.238194	0.0207826	-0.0037487	4.92E-05	8.94E-05	0.000354474
0.218151	0.0214358	-0.00215331	4.91E-05	8.14E-05	0.000323447
0.234423	0.0207433	-0.00267125	4.96E-05	8.90E-05	0.000349309
0.212459	0.0153458	-0.00125628	4.92E-05	7.95E-05	0.000322739
0.19469	0.01629	-0.00186487	4.92E-05	7.15E-05	0.000287946
0.198332	0.0224927	-0.00227072	4.73E-05	7.03E-05	0.00027748
0.194626	0.0226806	-0.00228775	4.64E-05	6.53E-05	0.000258381
0.171236	0.0173359	-0.0019295	4.91E-05	6.59E-05	0.00025186
0.171133	0.0239267	-0.00239679	4.65E-05	5.76E-05	0.000228595
0.162563	0.0173338	-0.00100398	4.85E-05	5.94E-05	0.000218416
0.166008	0.0173863	-0.00132568	4.86E-05	6.13E-05	0.000230079
0.14772	0.0172699	-0.000308883	4.74E-05	5.23E-05	0.000182065
0.15763	0.0248285	-0.00316952	4.60E-05	5.00E-05	0.000191833
0.147677	0.0249057	-0.00193101	4.55E-05	4.51E-05	0.000169018
0.150646	0.0250053	-0.00251512	4.62E-05	4.79E-05	0.000182242
0.12452	0.0179058	-0.00188517	4.39E-05	4.01E-05	0.000133066
0.124385	0.0257206	-0.00304166	4.28E-05	3.65E-05	0.000126932
0.101337	0.0184941	-0.00324894	3.93E-05	2.97E-05	8.23E-05
0.101126	0.0265148	-0.00403403	4.04E-05	2.82E-05	7.88E-05
0.0781697	0.0190085	-0.00430513	3.50E-05	2.09E-05	4.19E-05
0.0811702	0.0274288	-0.00570081	3.90E-05	2.22E-05	4.62E-05
0.0779133	0.0271724	-0.00483803	3.76E-05	1.98E-05	3.44E-05
0.0779181	0.0272981	-0.00501033	3.86E-05	1.99E-05	3.40E-05
0.0550432	0.0197606	-0.0063174	3.11E-05	1.38E-05	1.75E-05
0.0550205	0.025345	-0.00704627	3.67E-05	1.90E-05	2.09E-05
0.0551976	0.0273597	-0.00595796	3.73E-05	1.79E-05	1.96E-05
0.0552652	0.0281038	-0.00605886	3.81E-05	1.84E-05	2.12E-05
0.0545915	0.0204364	-0.00593019	3.31E-05	1.50E-05	1.35E-05
0.0545443	0.0199602	-0.00699706	2.98E-05	1.26E-05	1.23E-05

Source File

Name: beam3lb_15deg_fast_149.4Hz
Signal: FFT - Vib 3D Velocity - Magnitude
dB-Reference: 0 dB = 1 m/s
Band No.: 1
Frequency: 149.4 Hz

Interpolated: Yes
Filtered: Yes

X	Y	Z	Mag X	Mag Y	Mag Z
0.0549392	0.0228373	-0.00629466	6.78E-05	1.18E-05	0.000298385
0.0780733	0.0225747	-0.00487476	3.18E-05	8.49E-05	0.000675117
0.0781382	0.0202145	-0.00469857	3.48E-05	8.31E-05	0.00066731
0.0550104	0.0204406	-0.00592189	7.01E-05	1.00E-05	0.000251805
0.0779724	0.0247563	-0.00447577	2.59E-05	7.86E-05	0.000680476
0.101173	0.0246712	-0.00371792	3.39E-05	0.000227296	0.00130988
0.101215	0.0222476	-0.00325051	2.67E-05	0.000228753	0.0013048
0.101314	0.0200485	-0.00365014	1.57E-05	0.000227512	0.00129683
0.124387	0.0244582	-0.00245961	8.72E-05	0.000388085	0.00197182
0.124461	0.0222313	-0.00276611	7.81E-05	0.000401856	0.00196738
0.124456	0.0195503	-0.00143324	6.45E-05	0.000403751	0.00196206
0.147741	0.0246739	-0.00282433	0.000105457	0.000545065	0.00247594
0.147738	0.0221136	-0.0018753	9.99E-05	0.000578765	0.00251401
0.147823	0.0199391	-0.00237044	8.74E-05	0.000586409	0.00250516
0.171161	0.0223856	-0.00240845	9.90E-05	0.000734452	0.0028289
0.17112	0.0197544	-0.00126966	8.97E-05	0.000742736	0.00282883
0.19461	0.0224297	-0.0021508	9.77E-05	0.00087154	0.00290049
0.194665	0.0201694	-0.00235763	8.45E-05	0.000883356	0.00283656
0.194668	0.0177415	-0.00188328	8.04E-05	0.000883926	0.00282906
0.171213	0.0176048	-0.00185723	8.46E-05	0.000757362	0.00286628
0.218089	0.020082	-0.00159716	7.24E-05	0.000959399	0.00255804
0.218247	0.0180314	-0.00256512	6.91E-05	0.00096488	0.00250055
0.241956	0.0183943	-0.00340054	6.60E-05	0.000993364	0.00187188
0.241876	0.0158632	-0.00264566	4.97E-05	0.000976978	0.00185508
0.218207	0.0155754	-0.00199472	5.22E-05	0.000958993	0.00245433
0.265722	0.018688	-0.00401815	6.86E-05	0.000985579	0.00116401
0.265652	0.0162051	-0.00345672	6.85E-05	0.00096122	0.000970606
0.28958	0.0166345	-0.00461992	7.63E-05	0.000912634	9.66E-05
0.289464	0.014096	-0.00386691	9.51E-05	0.000883503	0.000119819
0.265859	0.0142477	-0.00480203	7.83E-05	0.000952573	0.000825119
0.313814	0.0150406	-0.00689741	0.000135678	0.000820858	0.00112792
0.313679	0.0125148	-0.00613982	0.000134103	0.000814598	0.00122857
0.289654	0.0120719	-0.0049143	9.19E-05	0.000871041	0.000296905
0.337932	0.0130928	-0.00789873	0.00019081	0.000710506	0.00211445
0.337778	0.0105627	-0.00714136	0.000192943	0.000683199	0.00228993
0.313662	0.0101279	-0.0059515	0.000127703	0.000800771	0.00142219
0.362157	0.0111824	-0.00905359	0.000231955	0.000584761	0.00300259
0.362159	0.00887783	-0.00914947	0.000243489	0.000553656	0.00312521
0.337965	0.00850441	-0.00818989	0.000210643	0.00065496	0.00247533
0.386671	0.00951085	-0.0111149	0.00029068	0.0004827	0.00354599
0.386707	0.00723082	-0.0114039	0.000298414	0.000449974	0.00360665
0.362083	0.00645367	-0.00886809	0.000251826	0.000516617	0.00326614

0.411435	0.00797711	-0.0137998	0.000328328	0.000367158	0.00376216
0.411135	0.00530185	-0.0125707	0.000336073	0.000346003	0.0037696
0.386617	0.00479156	-0.0110195	0.000309284	0.000433517	0.00371613
0.435783	0.00583216	-0.0141739	0.000342087	0.000264484	0.00358392
0.435922	0.00365325	-0.0148272	0.000341193	0.000265101	0.00353261
0.411123	0.00298242	-0.0126619	0.000351441	0.000333181	0.00384435
0.460883	0.00436749	-0.0171354	0.000312983	0.000208519	0.00303149
0.460662	0.00183041	-0.0164792	0.00030343	0.000193991	0.00295766
0.435996	0.00142436	-0.0152941	0.000352125	0.000259202	0.00358743
0.486066	0.00283029	-0.0199642	0.000220582	0.000134787	0.00220749
0.485846	0.000302043	-0.0193009	0.000239531	9.98E-05	0.00208698
0.460808	-0.000333836	-0.0172259	0.000321826	0.000171872	0.00295337
0.511071	0.00100394	-0.0216114	0.000177235	6.32E-05	0.00124385
0.510763	-0.0015987	-0.020774	0.00017679	6.28E-05	0.00118269
0.485866	-0.00199664	-0.0195783	0.000259292	0.000113442	0.00208027
0.521174	-0.00590469	-0.0222737	0.000159937	2.93E-05	0.000807633
0.532344	-0.00556036	-0.0234564	0.00013462	6.05E-05	0.000564399
0.53261	-0.00665513	-0.0235515	0.000142472	8.67E-05	0.000603601
0.531736	-0.00323504	-0.0232517	0.000128923	1.02E-05	0.000585006
0.510829	-0.00519119	-0.0212627	0.000185941	6.61E-05	0.00127003
0.511067	-0.00364639	-0.0219722	0.000174094	6.92E-05	0.00116769
0.531464	-0.000636824	-0.0241627	0.00011928	5.11E-06	0.000537919
0.513825	0.00126327	-0.0225661	0.000140073	3.80E-05	0.000910151
0.531034	-0.000243787	-0.0232202	0.000108604	9.06E-06	0.000532831
0.511338	0.00147453	-0.0224841	0.000163964	7.31E-05	0.00124574
0.497447	-0.00378757	-0.0216271	0.000209872	0.00010425	0.00163385
0.48564	-0.0034438	-0.0188423	0.000273052	0.00013856	0.002201
0.490004	0.00289291	-0.0201401	0.000183856	0.000121644	0.00183085
0.486291	0.00342667	-0.0207077	0.000213495	0.000143875	0.00219908
0.472862	-0.00255002	-0.0176006	0.000311037	0.000154882	0.00255474
0.460595	-0.00168451	-0.0164635	0.000338923	0.000188265	0.00304846
0.466137	0.00434649	-0.0170395	0.00028197	0.000178497	0.00272109
0.460659	0.00467039	-0.0162594	0.000315279	0.000203917	0.00301568
0.449188	-0.000575854	-0.0164517	0.000344287	0.000221794	0.00331721
0.435889	0.000268215	-0.0148818	0.000355992	0.000266189	0.00365785
0.442648	0.00605576	-0.0149604	0.00033622	0.000232664	0.0033891
0.436054	0.00678882	-0.0152344	0.000336881	0.000261321	0.00354231
0.425215	0.000958775	-0.0136879	0.000358125	0.000290069	0.00379021
0.41122	0.002147	-0.0130734	0.000354047	0.000332685	0.00389226
0.41938	0.00768484	-0.0125442	0.000329335	0.000342852	0.00374035
0.428904	0.00731326	-0.01461	0.000332846	0.000308877	0.00364085
0.411291	0.00866179	-0.0131183	0.000322366	0.000374347	0.00373228
0.401491	0.00262331	-0.0114695	0.000341527	0.000368002	0.00386904
0.3863	0.00357309	-0.00961574	0.000309519	0.000430931	0.00373747
0.396898	0.00980834	-0.0120606	0.000304062	0.000448449	0.00363005
0.386574	0.0104333	-0.0106749	0.000285914	0.000494807	0.00350507
0.378167	0.00462462	-0.010556	0.000286952	0.000463659	0.00358361

0.36198	0.00558079	-0.00838478	0.000251039	0.00051646	0.00326501
0.374084	0.0114148	-0.0096955	0.000249805	0.000555936	0.0032111
0.362175	0.0124377	-0.00913116	0.000229693	0.000601519	0.0029379
0.35473	0.00640494	-0.0087758	0.000232368	0.000571572	0.00297301
0.337815	0.00764661	-0.00739672	0.000211448	0.000663865	0.00245196
0.351713	0.0134775	-0.00903954	0.000208565	0.000670627	0.00243225
0.338012	0.0146575	-0.00840444	0.000191829	0.000704852	0.00215784
0.331615	0.00846212	-0.00812342	0.000185186	0.000727055	0.00205848
0.313588	0.00949077	-0.00561168	0.000126917	0.000810601	0.00141017
0.329432	0.0155913	-0.00858525	0.000147255	0.000744218	0.00173749
0.313854	0.0163786	-0.00715417	0.000122905	0.000819594	0.00108527
0.325485	0.0151794	-0.00583818	0.00011656	0.000743112	0.0016081
0.308278	0.0100475	-0.00574615	0.000102242	0.000843827	0.000967453
0.289647	0.0116297	-0.00493111	8.93E-05	0.000877762	0.000290019
0.299459	0.0168395	-0.00516243	9.28E-05	0.000896876	0.000298062
0.289624	0.0174539	-0.00491174	7.51E-05	0.000932365	0.000148412
0.285278	0.0120117	-0.00478451	9.01E-05	0.000906739	0.000153177
0.265897	0.0139484	-0.00498314	8.59E-05	0.000958926	0.000795049
0.268731	0.0187627	-0.00429145	7.02E-05	0.00097456	0.000799498
0.265686	0.0188604	-0.00387085	7.20E-05	0.000990237	0.00120369
0.260457	0.0137864	-0.0031919	4.89E-05	0.00097623	0.00125433
0.263936	0.0137085	-0.00344818	5.39E-05	0.000978375	0.00105015
0.241787	0.0142153	-0.00185587	3.90E-05	0.000968876	0.00188076
0.241953	0.0204718	-0.00355704	7.21E-05	0.000998832	0.00179737
0.218263	0.0153848	-0.00235368	4.80E-05	0.000948949	0.00243595
0.238194	0.0207826	-0.0037487	6.59E-05	0.000988933	0.00220455
0.218151	0.0214358	-0.00215331	7.54E-05	0.000956397	0.00256678
0.234423	0.0207433	-0.00267125	6.20E-05	0.000987096	0.00227499
0.212459	0.0153458	-0.00125628	5.69E-05	0.000930592	0.00265482
0.19469	0.01629	-0.00186487	7.57E-05	0.00086868	0.00283682
0.198332	0.0224927	-0.00227072	9.42E-05	0.000912417	0.00284507
0.194626	0.0226806	-0.00228775	0.000102113	0.000864936	0.0029023
0.171236	0.0173359	-0.0019295	8.56E-05	0.000763134	0.0028721
0.171133	0.0239267	-0.00239679	0.000105688	0.000733593	0.00283519
0.162563	0.0173338	-0.00100398	8.58E-05	0.000682371	0.00276157
0.166008	0.0173863	-0.00132568	8.70E-05	0.000710121	0.00282553
0.14772	0.0172699	-0.000308883	8.22E-05	0.000571922	0.00247717
0.15763	0.0248285	-0.00316952	0.000107944	0.000612998	0.00266106
0.147677	0.0249057	-0.00193101	0.000105502	0.000525279	0.00245951
0.150646	0.0250053	-0.00251512	0.00010929	0.00058173	0.00260782
0.12452	0.0179058	-0.00188517	5.58E-05	0.000399875	0.00195579
0.124385	0.0257206	-0.00304166	8.63E-05	0.000374539	0.00196582
0.101337	0.0184941	-0.00324894	1.17E-05	0.000219904	0.00129466
0.101126	0.0265148	-0.00403403	3.55E-05	0.00021515	0.00131117
0.0781697	0.0190085	-0.00430513	3.68E-05	7.92E-05	0.000667886
0.0811702	0.0274288	-0.00570081	1.43E-05	8.84E-05	0.000778481
0.0779133	0.0271724	-0.00483803	3.31E-05	4.68E-05	0.000569574

0.0779181	0.0272981	-0.00501033	3.28E-05	4.27E-05	0.000553054
0.0550432	0.0197606	-0.0063174	7.36E-05	1.09E-05	0.000261109
0.0550205	0.025345	-0.00704627	5.32E-05	1.10E-05	0.000303308
0.0551976	0.0273597	-0.00595796	5.15E-05	9.44E-06	0.00028044
0.0552652	0.0281038	-0.00605886	4.92E-05	1.34E-05	0.000302072
0.0545915	0.0204364	-0.00593019	7.47E-05	8.33E-06	0.000163731
0.0545443	0.0199602	-0.00699706	8.02E-05	1.26E-05	0.000162458

Source File Name: beam3lb_30deg_fast_55Hz
Signal: FFT - Vib 3D Velocity - Magnitude
dB-Reference: 0 dB = 1 m/s
Band No.: 1
Frequency: 55.00 Hz

Interpolated: Yes
Filtered: Yes

X	Y	Z	Mag X	Mag Y	Mag Z
0.0617422	0.0229394	-0.0084412	3.42E-06	3.70E-06	4.72E-07
0.0615964	0.0215636	-0.00880869	3.06E-06	1.28E-06	2.90E-07
0.0614824	0.0201509	-0.00877738	2.80E-06	1.89E-07	2.15E-07
0.0614151	0.0186639	-0.00815103	2.81E-06	8.51E-07	2.52E-07
0.0613162	0.0172138	-0.00792039	2.69E-06	1.52E-06	2.20E-07
0.0610939	0.0159738	-0.00926962	3.07E-06	7.76E-07	4.18E-07
0.061042	0.0144506	-0.00844224	3.35E-06	4.76E-07	5.24E-07
0.0759574	0.0219937	-0.00838083	3.44E-06	3.91E-06	9.81E-07
0.0758206	0.0206065	-0.00864978	3.57E-06	2.57E-06	7.73E-07
0.075658	0.0192828	-0.00931153	2.81E-06	1.39E-06	8.54E-08
0.0755546	0.0178325	-0.00908254	2.35E-06	1.77E-06	1.36E-07
0.0754655	0.0163723	-0.00865223	2.05E-06	1.41E-06	5.05E-07
0.0753224	0.0149965	-0.00901421	2.20E-06	1.58E-06	8.30E-07
0.0752203	0.0135617	-0.00877882	2.37E-06	1.23E-06	8.43E-07
0.0899683	0.0197944	-0.00962192	3.44E-06	3.30E-06	1.68E-06
0.0897891	0.01852	-0.0106808	3.80E-06	1.99E-06	1.69E-06
0.0897147	0.0169958	-0.00985744	2.84E-06	1.55E-06	1.02E-06
0.0896293	0.0154979	-0.00923054	2.87E-06	1.53E-06	1.39E-06
0.0894893	0.0141364	-0.00959138	2.77E-06	9.31E-07	1.28E-06
0.0894043	0.0126405	-0.00896121	2.39E-06	1.61E-06	1.44E-06
0.104121	0.0190861	-0.0114315	2.82E-06	2.53E-06	3.14E-06
0.103987	0.0176974	-0.0117001	3.45E-06	1.27E-06	2.67E-06
0.103906	0.0161615	-0.0107774	2.51E-06	3.48E-07	2.10E-06
0.103808	0.0146901	-0.0102479	2.96E-06	1.58E-06	2.77E-06
0.103669	0.0133143	-0.010611	2.72E-06	1.52E-06	2.19E-06
0.103544	0.0119022	-0.010675	2.40E-06	1.37E-06	2.87E-06
0.118321	0.0183935	-0.0133839	4.03E-06	2.55E-06	6.15E-06
0.118228	0.016856	-0.0124629	4.40E-06	2.06E-06	5.48E-06
0.118094	0.0154668	-0.0127304	4.71E-06	1.05E-06	5.04E-06
0.117991	0.0139686	-0.0121036	4.54E-06	2.37E-06	5.85E-06

0.117851	0.0126035	-0.0125666	3.91E-06	1.11E-06	3.90E-06
0.117742	0.0111308	-0.012135	3.67E-06	1.49E-06	5.18E-06
0.132575	0.0176287	-0.014884	4.31E-06	2.06E-06	8.22E-06
0.132467	0.0161032	-0.0140624	4.79E-06	2.02E-06	6.73E-06
0.132348	0.0146402	-0.0137351	4.90E-06	3.01E-06	7.95E-06
0.132227	0.0132039	-0.0135038	4.52E-06	2.34E-06	7.47E-06
0.132095	0.0118139	-0.0137689	3.45E-06	1.23E-06	5.57E-06
0.13198	0.0103549	-0.0133359	3.17E-06	2.25E-06	6.23E-06
0.146883	0.016844	-0.0161261	4.48E-06	1.80E-06	8.50E-06
0.146748	0.0154883	-0.0166943	4.00E-06	2.21E-06	6.45E-06
0.146637	0.0138788	-0.0151764	4.05E-06	2.48E-06	7.89E-06
0.146497	0.0125828	-0.0162379	3.44E-06	2.12E-06	8.15E-06
0.146372	0.0111311	-0.0160072	3.25E-06	2.04E-06	6.54E-06
0.146247	0.00969401	-0.0157733	3.44E-06	1.90E-06	7.40E-06
0.161227	0.016122	-0.0180053	4.46E-06	2.93E-06	1.22E-05
0.161096	0.0147039	-0.0180778	3.91E-06	1.87E-06	9.69E-06
0.160966	0.0132978	-0.0182481	3.75E-06	1.75E-06	1.06E-05
0.160836	0.0119033	-0.0185161	3.92E-06	1.30E-06	9.89E-06
0.160706	0.0104262	-0.0180875	3.89E-06	1.47E-06	8.49E-06
0.160576	0.00898737	-0.0178542	4.59E-06	1.14E-06	1.10E-05
0.175643	0.0156099	-0.0215101	6.66E-06	3.08E-06	1.83E-05
0.175502	0.0140922	-0.0207893	5.67E-06	2.38E-06	1.42E-05
0.175365	0.0126098	-0.0204656	5.70E-06	1.74E-06	1.67E-05
0.175227	0.0111187	-0.01994	4.90E-06	2.34E-06	1.21E-05
0.175104	0.00979238	-0.0208029	5.97E-06	2.44E-06	1.47E-05
0.174967	0.00831636	-0.0202724	6.56E-06	2.72E-06	1.72E-05
0.190117	0.0148908	-0.0234663	7.47E-06	2.82E-06	2.03E-05
0.189963	0.0134319	-0.0232428	6.06E-06	2.64E-06	1.69E-05
0.189817	0.0119375	-0.0227197	4.78E-06	2.82E-06	1.40E-05
0.189695	0.0105732	-0.023287	4.50E-06	2.61E-06	1.45E-05
0.189554	0.00910344	-0.0229592	6.33E-06	2.70E-06	1.70E-05
0.189427	0.00771506	-0.0233249	7.95E-06	3.04E-06	2.18E-05
0.204651	0.0142581	-0.0261543	6.94E-06	2.86E-06	2.09E-05
0.204503	0.0127837	-0.0258323	6.36E-06	2.85E-06	1.60E-05
0.204365	0.0113455	-0.0258064	7.19E-06	3.28E-06	1.90E-05
0.204218	0.00987265	-0.0254811	5.59E-06	2.56E-06	1.53E-05
0.204077	0.00842372	-0.0253526	6.86E-06	2.37E-06	1.99E-05
0.203977	0.00712637	-0.0264125	6.97E-06	2.97E-06	1.94E-05
0.219314	0.0137439	-0.0298695	6.79E-06	2.37E-06	1.98E-05
0.219155	0.0122898	-0.0297476	8.04E-06	2.70E-06	2.37E-05
0.219006	0.0108238	-0.0295242	8.30E-06	4.09E-06	2.18E-05
0.218844	0.00932378	-0.0290016	7.36E-06	3.61E-06	2.17E-05
0.218712	0.00790522	-0.0291719	6.59E-06	3.43E-06	1.86E-05
0.218537	0.00638711	-0.0283465	5.93E-06	3.03E-06	1.73E-05
0.233856	0.0116527	-0.0325056	5.97E-06	2.08E-06	1.74E-05
0.23373	0.0102413	-0.0327792	5.46E-06	2.43E-06	1.58E-05
0.23356	0.00873777	-0.0322578	4.05E-06	1.69E-06	1.17E-05
0.233406	0.00726962	-0.0320323	4.43E-06	1.52E-06	1.38E-05
0.233308	0.00592893	-0.0327955	5.01E-06	1.96E-06	1.50E-05
0.233154	0.00446106	-0.0325669	6.09E-06	2.08E-06	1.81E-05
0.248678	0.0110845	-0.0358908	4.64E-06	2.22E-06	1.49E-05
0.248505	0.00958808	-0.0354715	2.44E-06	1.61E-06	7.36E-06

0.248414	0.00822956	-0.03624	2.69E-06	1.42E-06	8.14E-06
0.248249	0.00675955	-0.035915	3.36E-06	1.29E-06	1.10E-05
0.24815	0.00538811	-0.0365814	5.05E-06	1.54E-06	1.56E-05
0.247971	0.00388248	-0.0360565	5.98E-06	2.18E-06	1.66E-05
0.263491	0.00915416	-0.039977	3.88E-06	3.18E-06	1.35E-05
0.263311	0.00765354	-0.0395576	4.09E-06	3.31E-06	1.28E-05
0.263211	0.00628035	-0.0401254	4.84E-06	2.61E-06	1.58E-05
0.262985	0.00471424	-0.0391083	3.89E-06	1.16E-06	1.27E-05
0.262885	0.00334935	-0.039874	4.47E-06	1.40E-06	1.04E-05
0.262736	0.00188079	-0.039846	5.67E-06	3.21E-06	1.63E-05
0.278597	0.00871346	-0.044611	4.01E-06	3.97E-06	1.79E-05
0.278455	0.00726339	-0.0446881	5.67E-06	3.88E-06	2.04E-05
0.278265	0.005784	-0.0443672	5.78E-06	2.56E-06	1.78E-05
0.278069	0.0042683	-0.0438472	4.66E-06	8.42E-07	1.25E-05
0.277989	0.00289582	-0.0446125	2.59E-06	3.32E-07	1.05E-05
0.277714	0.00128407	-0.043198	2.80E-06	2.24E-06	7.10E-06
0.293566	0.00670116	-0.0483617	5.84E-06	2.14E-06	2.08E-05
0.293394	0.00522714	-0.0481401	6.91E-06	1.20E-06	2.16E-05
0.29326	0.00378321	-0.0483141	6.48E-06	2.23E-07	2.08E-05
0.293026	0.00223079	-0.0474974	4.93E-06	3.49E-07	1.46E-05
0.292853	0.000744685	-0.0472725	4.91E-06	1.29E-06	1.53E-05
0.292818	-0.000592079	-0.048431	6.93E-06	2.08E-06	2.04E-05
0.308949	0.0062892	-0.0534426	8.13E-06	2.47E-06	2.61E-05
0.30866	0.00469902	-0.0522349	8.69E-06	1.96E-06	2.80E-05
0.308634	0.00336948	-0.0534982	8.23E-06	7.47E-07	2.70E-05
0.308445	0.00187897	-0.0531763	7.48E-06	7.95E-07	2.40E-05
0.308266	0.000385587	-0.0529531	7.69E-06	1.27E-06	2.41E-05
0.308109	-0.00108604	-0.052926	9.64E-06	2.54E-06	2.80E-05
0.307886	-0.00261998	-0.0523042	1.02E-05	2.68E-06	2.87E-05
0.324223	0.00436688	-0.0580314	8.79E-06	2.81E-06	2.90E-05
0.324052	0.00287681	-0.057912	8.20E-06	2.10E-06	2.72E-05
0.323831	0.00134457	-0.0573962	6.12E-06	9.78E-07	1.93E-05
0.323672	-0.000133589	-0.0573721	7.50E-06	1.56E-06	2.38E-05
0.323403	-0.00169106	-0.0564564	7.14E-06	1.92E-06	2.19E-05
0.32339	-0.00304364	-0.0576136	6.79E-06	2.54E-06	2.04E-05
0.339554	0.00234287	-0.0621524	5.93E-06	2.18E-06	2.02E-05
0.339512	0.000967338	-0.0630167	4.82E-06	2.30E-06	1.45E-05
0.339244	-0.000602304	-0.0622058	4.67E-06	2.43E-06	1.50E-05
0.339055	-0.00210783	-0.0619845	5.01E-06	2.15E-06	1.57E-05
0.338866	-0.00359813	-0.0617599	4.84E-06	8.70E-07	1.54E-05
0.338783	-0.0050211	-0.0623241	4.52E-06	1.69E-06	1.49E-05
0.355091	0.000400512	-0.0670833	4.02E-06	2.17E-06	1.28E-05
0.354941	-0.00106668	-0.0671591	5.06E-06	2.77E-06	1.67E-05
0.354776	-0.00255871	-0.0671366	7.20E-06	1.50E-06	2.20E-05
0.354682	-0.00398503	-0.067603	7.86E-06	1.43E-06	2.44E-05
0.354431	-0.00553742	-0.0669866	6.33E-06	1.92E-06	1.95E-05
0.354294	-0.00699404	-0.0671545	5.14E-06	1.84E-06	1.60E-05
0.371046	1.90E-05	-0.0728382	3.69E-06	8.91E-07	1.23E-05
0.3708	-0.00153288	-0.0723277	5.00E-06	1.15E-06	1.57E-05
0.370833	-0.0028855	-0.0735827	7.37E-06	1.58E-06	2.33E-05
0.370496	-0.00448244	-0.0724777	8.76E-06	1.66E-06	2.75E-05
0.370327	-0.00598179	-0.0724536	6.90E-06	2.30E-06	2.22E-05

0.370251	-0.00740701	-0.0730161	4.62E-06	1.19E-06	1.55E-05
0.386968	-0.00187991	-0.0785901	4.17E-06	7.22E-07	1.35E-05
0.386828	-0.00336478	-0.0786652	6.71E-06	1.19E-06	2.12E-05
0.386624	-0.00487851	-0.0784468	7.94E-06	1.66E-06	2.56E-05
0.386452	-0.00638657	-0.0784245	7.04E-06	1.23E-06	2.28E-05
0.386347	-0.0078405	-0.0787916	4.81E-06	1.73E-06	1.60E-05
0.386093	-0.00938202	-0.0782738	3.23E-06	2.03E-06	9.81E-06
0.4029	-0.00387118	-0.0835688	3.76E-06	1.70E-06	1.22E-05
0.402762	-0.00535282	-0.0837442	4.04E-06	2.02E-06	1.28E-05
0.402552	-0.00687377	-0.0835262	4.78E-06	7.10E-07	1.61E-05
0.402484	-0.00831657	-0.0840903	3.63E-06	1.15E-06	1.15E-05
0.402327	-0.00980826	-0.084163	2.62E-06	1.13E-06	8.25E-06
0.401852	-0.0114852	-0.082472	3.35E-06	1.06E-06	1.11E-05
0.419128	-0.00578735	-0.0895425	3.75E-06	9.11E-07	1.08E-05
0.418913	-0.00731694	-0.0893268	3.95E-06	1.62E-06	1.17E-05
0.41868	-0.00885544	-0.0890117	2.01E-06	1.53E-06	8.71E-06
0.418521	-0.0103551	-0.089086	2.49E-06	2.42E-06	8.02E-06
0.418381	-0.0118453	-0.0892565	3.91E-06	1.51E-06	1.22E-05
0.418315	-0.0132836	-0.0898152	3.81E-06	1.69E-06	1.26E-05
0.435763	-0.00615928	-0.0959324	6.90E-06	1.39E-06	1.27E-05
0.435504	-0.00771756	-0.095524	5.20E-06	9.31E-07	9.81E-06
0.435363	-0.00921774	-0.0956994	2.09E-06	1.86E-06	8.76E-06
0.434985	-0.0108308	-0.0947022	1.85E-06	1.75E-06	7.16E-06
0.434884	-0.0122964	-0.0950678	3.35E-06	1.98E-06	8.45E-06
0.43486	-0.0137409	-0.095824	2.94E-06	1.58E-06	7.58E-06
0.452116	-0.00818609	-0.101144	5.52E-06	1.41E-06	9.39E-06
0.452141	-0.00962025	-0.1021	2.56E-06	1.98E-06	8.31E-06
0.451542	-0.0113201	-0.100132	2.13E-06	8.81E-07	6.29E-06
0.451518	-0.0127835	-0.100789	2.08E-06	1.52E-06	5.36E-06
0.451521	-0.0142288	-0.101643	2.03E-06	2.63E-06	5.70E-06
0.451233	-0.0157863	-0.10113	1.87E-06	2.43E-06	5.52E-06
0.468979	-0.0100824	-0.108016	2.48E-06	1.16E-06	5.65E-06
0.468508	-0.0117254	-0.106734	1.42E-06	1.93E-06	3.61E-06
0.468518	-0.0131804	-0.107589	1.21E-06	2.80E-06	3.01E-06
0.468353	-0.0146937	-0.107664	1.09E-06	2.86E-06	2.71E-06
0.468057	-0.0162603	-0.107155	1.07E-06	2.78E-06	3.12E-06
0.467847	-0.0178057	-0.107034	1.01E-06	3.35E-06	3.63E-06
0.485926	-0.0105641	-0.113842	6.35E-07	8.31E-07	3.45E-06
0.485851	-0.0120514	-0.11431	5.20E-07	1.08E-06	3.35E-06
0.485661	-0.0135845	-0.114291	6.25E-07	2.12E-06	2.53E-06
0.485463	-0.0151274	-0.114171	6.66E-07	2.37E-06	3.72E-06
0.485227	-0.0166775	-0.113956	5.33E-07	2.68E-06	2.57E-06
0.484807	-0.0183117	-0.112964	5.60E-07	3.01E-06	2.98E-06
0.484594	-0.019851	-0.112843	7.55E-07	4.22E-06	3.00E-06
0.503093	-0.0124856	-0.120718	2.85E-07	2.12E-06	3.29E-06
0.502723	-0.0141016	-0.119925	3.63E-07	1.92E-06	2.93E-06
0.502411	-0.015688	-0.119423	4.79E-07	1.35E-05	2.57E-06
0.502313	-0.0171948	-0.119791	7.70E-07	2.48E-06	1.52E-06
0.502263	-0.0186849	-0.12035	9.29E-07	3.89E-06	8.79E-07
0.501973	-0.020261	-0.119941	1.87E-06	8.83E-06	1.96E-06
0.520402	-0.014452	-0.127495	4.14E-07	5.77E-06	3.51E-06
0.52018	-0.0160149	-0.127384	5.18E-07	1.89E-05	2.06E-06

0.51966	-0.0176806	-0.126113	9.42E-07	1.20E-05	1.06E-06
0.519827	-0.0190995	-0.127439	1.63E-06	5.81E-06	8.12E-07
0.519406	-0.0207285	-0.126551	2.72E-06	1.37E-05	1.87E-06
0.519382	-0.0222226	-0.127204	3.31E-06	1.53E-05	2.81E-06

Source File Name: beam3lb_30deg_fast_148.8Hz
Signal: FFT - Vib 3D Velocity - Magnitude
dB-Reference: 0 dB = 1 m/s
Band No.: 1
Frequency: 148.8 Hz

Interpolated: Yes
Filtered: Yes

X	Y	Z	Mag X	Mag Y	Mag Z
0.0617422	0.0229394	-0.0084412	7.07E-05	3.61E-05	0.00028053
0.0615964	0.0215636	-0.00880869	7.41E-05	2.92E-05	0.000262111
0.0614824	0.0201509	-0.00877738	7.77E-05	2.65E-05	0.000242664
0.0614151	0.0186639	-0.00815103	7.57E-05	2.68E-05	0.000244112
0.0613162	0.0172138	-0.00792039	7.49E-05	2.32E-05	0.000243925
0.0610939	0.0159738	-0.00926962	7.74E-05	2.86E-05	0.000241132
0.061042	0.0144506	-0.00844224	8.17E-05	4.22E-05	0.000255247
0.0759574	0.0219937	-0.00838083	7.35E-05	5.72E-05	0.000558183
0.0758206	0.0206065	-0.00864978	7.55E-05	5.64E-05	0.000543419
0.075658	0.0192828	-0.00931153	8.01E-05	5.43E-05	0.000507449
0.0755546	0.0178325	-0.00908254	8.24E-05	4.81E-05	0.000490057
0.0754655	0.0163723	-0.00865223	7.89E-05	4.09E-05	0.000489999
0.0753224	0.0149965	-0.00901421	7.72E-05	3.80E-05	0.000490363
0.0752203	0.0135617	-0.00877882	8.03E-05	4.48E-05	0.000494972
0.0899683	0.0197944	-0.00962192	0.000104622	7.10E-05	0.000855409
0.0897891	0.01852	-0.0106808	0.00011273	7.10E-05	0.000885942
0.0897147	0.0169958	-0.00985744	0.000113663	7.50E-05	0.00088556
0.0896293	0.0154979	-0.00923054	9.99E-05	6.95E-05	0.000886867
0.0894893	0.0141364	-0.00959138	9.39E-05	6.52E-05	0.000886113
0.0894043	0.0126405	-0.00896121	9.76E-05	6.71E-05	0.000895548
0.104121	0.0190861	-0.0114315	0.000158291	9.25E-05	0.00136506
0.103987	0.0176974	-0.0117001	0.000154621	9.77E-05	0.00136451
0.103906	0.0161615	-0.0107774	0.00014881	0.000106884	0.00136676
0.103808	0.0146901	-0.0102479	0.000140364	0.000115356	0.00137037
0.103669	0.0133143	-0.010611	0.000136851	0.000113642	0.00137607
0.103544	0.0119022	-0.010675	0.000143971	0.000116906	0.00138121
0.118321	0.0183935	-0.0133839	0.00021663	0.000124035	0.00186394
0.118228	0.016856	-0.0124629	0.000209477	0.000126239	0.00186571
0.118094	0.0154668	-0.0127304	0.000205482	0.000132445	0.00186743
0.117991	0.0139686	-0.0121036	0.000201336	0.000137931	0.00187003
0.117851	0.0126035	-0.0125666	0.000203976	0.000143598	0.00187383
0.117742	0.0111308	-0.012135	0.000206819	0.000146023	0.00187866
0.132575	0.0176287	-0.014884	0.000266461	0.000138908	0.00232453
0.132467	0.0161032	-0.0140624	0.000262267	0.000141572	0.00233068
0.132348	0.0146402	-0.0137351	0.000254341	0.000144402	0.00233543

0.132227	0.0132039	-0.0135038	0.000255242	0.000150819	0.00234297
0.132095	0.0118139	-0.0137689	0.000255786	0.000151264	0.00235288
0.13198	0.0103549	-0.0133359	0.000256912	0.000153265	0.00235227
0.146883	0.016844	-0.0161261	0.000318447	0.000144679	0.00271463
0.146748	0.0154883	-0.0166943	0.000316781	0.000150092	0.00272118
0.146637	0.0138788	-0.0151764	0.000316054	0.000152741	0.00272657
0.146497	0.0125828	-0.0162379	0.000318104	0.000156472	0.00273139
0.146372	0.0111311	-0.0160072	0.000318104	0.000158725	0.00273739
0.146247	0.00969401	-0.0157733	0.000317769	0.000156225	0.00273787
0.161227	0.016122	-0.0180053	0.000372013	0.000149319	0.00299602
0.161096	0.0147039	-0.0180778	0.000370879	0.000154783	0.00300836
0.160966	0.0132978	-0.0182481	0.000373158	0.000157903	0.0030171
0.160836	0.0119033	-0.0185161	0.000374759	0.000161951	0.003027
0.160706	0.0104262	-0.0180875	0.000376374	0.000163359	0.00303225
0.160576	0.00898737	-0.0178542	0.000376227	0.000163073	0.00303012
0.175643	0.0156099	-0.0215101	0.000410818	0.000140687	0.00314176
0.175502	0.0140922	-0.0207893	0.000412133	0.000145427	0.0031563
0.175365	0.0126098	-0.0204656	0.000413176	0.000148394	0.00316917
0.175227	0.0111187	-0.01994	0.000417426	0.000160935	0.00318377
0.175104	0.00979238	-0.0208029	0.000418954	0.000159933	0.00319185
0.174967	0.00831636	-0.0202724	0.000418914	0.000159203	0.00318855
0.190117	0.0148908	-0.0234663	0.000419067	0.000120931	0.00312321
0.189963	0.0134319	-0.0232428	0.000421177	0.000121134	0.00313308
0.189817	0.0119375	-0.0227197	0.000424337	0.000126202	0.00314393
0.189695	0.0105732	-0.023287	0.000428074	0.000140332	0.00316199
0.189554	0.00910344	-0.0229592	0.000429869	0.000138974	0.00317652
0.189427	0.00771506	-0.0233249	0.000427511	0.000136143	0.00317803
0.204651	0.0142581	-0.0261543	0.000394473	9.98E-05	0.00293973
0.204503	0.0127837	-0.0258323	0.000397333	0.00010289	0.00294978
0.204365	0.0113455	-0.0258064	0.000396978	0.00010458	0.00296436
0.204218	0.00987265	-0.0254811	0.000401086	0.000117776	0.00297822
0.204077	0.00842372	-0.0253526	0.000404137	0.000116238	0.00299352
0.203977	0.00712637	-0.0264125	0.00038196	0.000110919	0.00289484
0.219314	0.0137439	-0.0298695	0.00032829	7.40E-05	0.00258947
0.219155	0.0122898	-0.0297476	0.000328826	7.81E-05	0.00259863
0.219006	0.0108238	-0.0295242	0.000330874	8.00E-05	0.00261745
0.218844	0.00932378	-0.0290016	0.000335891	8.29E-05	0.00263464
0.218712	0.00790522	-0.0291719	0.000329279	7.12E-05	0.00256961
0.218537	0.00638711	-0.0283465	0.000292143	6.54E-05	0.00241309
0.233856	0.0116527	-0.0325056	0.000251874	5.33E-05	0.00218327
0.23373	0.0102413	-0.0327792	0.000235386	5.10E-05	0.00211349
0.23356	0.00873777	-0.0322578	0.000238841	4.56E-05	0.00212648
0.233406	0.00726962	-0.0320323	0.0002414	3.58E-05	0.00214309
0.233308	0.00592893	-0.0327955	0.000219869	3.53E-05	0.00206937
0.233154	0.00446106	-0.0325669	0.000208991	3.66E-05	0.00190604
0.248678	0.0110845	-0.0358908	9.40E-05	1.82E-05	0.00144287
0.248505	0.00958808	-0.0354715	9.17E-05	1.87E-05	0.00145553
0.248414	0.00822956	-0.03624	8.24E-05	1.50E-05	0.00147136
0.248249	0.00675955	-0.035915	8.34E-05	5.30E-06	0.00149386
0.24815	0.00538811	-0.0365814	7.18E-05	7.01E-06	0.00138209
0.247971	0.00388248	-0.0360565	4.44E-05	4.44E-06	0.00113565
0.263491	0.00915416	-0.039977	7.73E-05	1.48E-05	0.000802051

0.263311	0.00765354	-0.0395576	0.000108927	1.88E-05	0.000686664
0.263211	0.00628035	-0.0401254	0.000105026	1.88E-05	0.000711438
0.262985	0.00471424	-0.0391083	0.000108552	1.83E-05	0.000732297
0.262885	0.00334935	-0.039874	0.000107576	1.90E-05	0.000617146
0.262736	0.00188079	-0.039846	0.000117213	1.82E-05	0.000596613
0.278597	0.00871346	-0.044611	0.000361413	5.47E-05	0.000191043
0.278455	0.00726339	-0.0446881	0.000360646	5.40E-05	0.000187494
0.278265	0.005784	-0.0443672	0.000348989	5.19E-05	0.000165912
0.278069	0.0042683	-0.0438472	0.000347612	5.09E-05	0.000142138
0.277989	0.00289582	-0.0446125	0.000345867	4.85E-05	0.0001285
0.277714	0.00128407	-0.043198	0.000439062	4.92E-05	0.000263966
0.293566	0.00670116	-0.0483617	0.000575522	7.75E-05	0.000935011
0.293394	0.00522714	-0.0481401	0.000612783	8.23E-05	0.00107102
0.29326	0.00378321	-0.0483141	0.00061258	7.96E-05	0.00105451
0.293026	0.00223079	-0.0474974	0.000612549	7.28E-05	0.00103784
0.292853	0.000744685	-0.0472725	0.000660653	7.06E-05	0.00102031
0.292818	-0.000592079	-0.048431	0.000748088	7.30E-05	0.00115973
0.308949	0.0062892	-0.0534426	0.000912644	0.000105135	0.0020025
0.30866	0.00469902	-0.0522349	0.000916097	0.000107062	0.00199727
0.308634	0.00336948	-0.0534982	0.000915122	0.000103432	0.00198804
0.308445	0.00187897	-0.0531763	0.000914093	9.80E-05	0.00196688
0.308266	0.000385587	-0.0529531	0.000903038	9.48E-05	0.0019468
0.308109	-0.00108604	-0.052926	0.00093621	9.41E-05	0.00192449
0.307886	-0.00261998	-0.0523042	0.000945543	9.40E-05	0.00206402
0.324223	0.00436688	-0.0580314	0.00115215	0.00011943	0.00272663
0.324052	0.00287681	-0.057912	0.00119553	0.000120394	0.00286213
0.323831	0.00134457	-0.0573962	0.0011887	0.000115265	0.00283903
0.323672	-0.000133589	-0.0573721	0.00117173	0.000116714	0.00282073
0.323403	-0.00169106	-0.0564564	0.00115863	0.000113355	0.0029277
0.32339	-0.00304364	-0.0576136	0.00124513	0.00011703	0.00327155
0.339554	0.00234287	-0.0621524	0.00140803	0.000129499	0.00350512
0.339512	0.000967338	-0.0630167	0.00145038	0.000130546	0.00361585
0.339244	-0.000602304	-0.0622058	0.00143602	0.000128933	0.00360822
0.339055	-0.00210783	-0.0619845	0.00142252	0.000126575	0.0035891
0.338866	-0.00359813	-0.0617599	0.00145771	0.000124871	0.00379258
0.338783	-0.0050211	-0.0623241	0.00153508	0.000120389	0.0039856
0.355091	0.000400512	-0.0670833	0.0016318	0.000131338	0.00416768
0.354941	-0.00106668	-0.0671591	0.001667	0.000128765	0.00426707
0.354776	-0.00255871	-0.0671366	0.00166068	0.000120127	0.00424623
0.354682	-0.00398503	-0.067603	0.00165954	0.000120373	0.00420628
0.354431	-0.00553742	-0.0669866	0.00169628	0.000116855	0.00428773
0.354294	-0.00699404	-0.0671545	0.00169673	0.000117586	0.00429529
0.371046	1.90E-05	-0.0728382	0.00185785	0.000124967	0.00473914
0.3708	-0.00153288	-0.0723277	0.00185945	0.000120939	0.00473989
0.370833	-0.0028855	-0.0735827	0.00185494	0.000114172	0.00472107
0.370496	-0.00448244	-0.0724777	0.00184865	0.000111799	0.00468845
0.370327	-0.00598179	-0.0724536	0.00185014	0.000114387	0.00467084
0.370251	-0.00740701	-0.0730161	0.00186891	0.000106418	0.00470236
0.386968	-0.00187991	-0.0785901	0.00195435	0.000115336	0.00494136
0.386828	-0.00336478	-0.0786652	0.00197032	0.000109944	0.00497346
0.386624	-0.00487851	-0.0784468	0.001967	0.000102485	0.00495271
0.386452	-0.00638657	-0.0784245	0.00196732	0.000103577	0.00493958

0.386347	-0.0078405	-0.0787916	0.0019647	9.29E-05	0.00491913
0.386093	-0.00938202	-0.0782738	0.00195773	7.37E-05	0.00487057
0.4029	-0.00387118	-0.0835688	0.00199036	8.80E-05	0.00497968
0.402762	-0.00535282	-0.0837442	0.00199336	7.15E-05	0.00496634
0.402552	-0.00687377	-0.0835262	0.00199299	6.01E-05	0.004936
0.402484	-0.00831657	-0.0840903	0.00198543	5.88E-05	0.00492486
0.402327	-0.00980826	-0.084163	0.00197468	4.66E-05	0.00486969
0.401852	-0.0114852	-0.082472	0.0019493	3.67E-05	0.00479879
0.419128	-0.00578735	-0.0895425	0.00195545	4.31E-05	0.0047835
0.418913	-0.00731694	-0.0893268	0.00195062	4.69E-05	0.00472393
0.41868	-0.00885544	-0.0890117	0.00195045	4.86E-05	0.00471201
0.418521	-0.0103551	-0.089086	0.00194097	4.90E-05	0.00470467
0.418381	-0.0118453	-0.0892565	0.00190649	1.84E-05	0.00465311
0.418315	-0.0132836	-0.0898152	0.00189561	1.45E-05	0.00464065
0.435763	-0.00615928	-0.0959324	0.00182261	4.20E-05	0.00433466
0.435504	-0.00771756	-0.095524	0.00183008	6.46E-05	0.00432688
0.435363	-0.00921774	-0.0956994	0.00184062	8.17E-05	0.00433041
0.434985	-0.0108308	-0.0947022	0.00182013	5.91E-05	0.00429913
0.434884	-0.0122964	-0.0950678	0.0017847	1.13E-05	0.00427943
0.43486	-0.0137409	-0.095824	0.0017373	4.09E-06	0.0041664
0.452116	-0.00818609	-0.101144	0.00166522	4.49E-05	0.00382536
0.452141	-0.00962025	-0.1021	0.00163842	5.96E-05	0.00370844
0.451542	-0.0113201	-0.100132	0.00163087	8.10E-05	0.00369688
0.451518	-0.0127835	-0.100789	0.00158855	5.89E-06	0.00366451
0.451521	-0.0142288	-0.101643	0.00157965	1.37E-05	0.00364841
0.451233	-0.0157863	-0.10113	0.00151401	4.51E-05	0.00351006
0.468979	-0.0100824	-0.108016	0.0014137	1.77E-05	0.0030828
0.468508	-0.0117254	-0.106734	0.00135133	3.52E-05	0.00294667
0.468518	-0.0131804	-0.107589	0.00132397	3.84E-05	0.00291764
0.468353	-0.0146937	-0.107664	0.00129906	7.62E-05	0.00287136
0.468057	-0.0162603	-0.107155	0.00128628	4.34E-05	0.00285658
0.467847	-0.0178057	-0.107034	0.00122773	9.48E-05	0.00272366
0.485926	-0.0105641	-0.113842	0.00102819	8.44E-05	0.00209853
0.485851	-0.0120514	-0.11431	0.0010257	4.18E-05	0.00210474
0.485661	-0.0135845	-0.114291	0.00100749	7.29E-05	0.00208497
0.485463	-0.0151274	-0.114171	0.000996053	5.76E-05	0.00201669
0.485227	-0.0166775	-0.113956	0.0009877	4.73E-05	0.002037
0.484807	-0.0183117	-0.112964	0.000979767	4.29E-05	0.00201216
0.484594	-0.019851	-0.112843	0.000925388	4.35E-05	0.00188839
0.503093	-0.0124856	-0.120718	0.000819142	7.11E-05	0.00144076
0.502723	-0.0141016	-0.119925	0.000771349	6.24E-05	0.00126345
0.502411	-0.015688	-0.119423	0.000703026	6.16E-05	0.00117877
0.502313	-0.0171948	-0.119791	0.000680148	6.06E-05	0.00117727
0.502263	-0.0186849	-0.12035	0.000620566	3.18E-05	0.0010337
0.501973	-0.020261	-0.119941	0.000516224	7.58E-05	0.000794853
0.520402	-0.014452	-0.127495	0.000656131	6.02E-05	0.000882322
0.52018	-0.0160149	-0.127384	0.000512199	4.90E-05	0.000659351
0.51966	-0.0176806	-0.126113	0.000428038	4.56E-05	0.000653045
0.519827	-0.0190995	-0.127439	0.000420275	2.97E-05	0.00058377
0.519406	-0.0207285	-0.126551	0.000352131	8.77E-05	0.000424882
0.519382	-0.0222226	-0.127204	0.000340866	0.000145053	0.000403588

Source File Name: beam3lb_neg15deg_fast_66.88Hz
Signal: FFT - Vib 3D Velocity - Magnitude
dB-Reference: 0 dB = 1 m/s
Band No.: 1
Frequency: 66.88 Hz

Interpolated: Yes
Filtered: Yes

X	Y	Z	Mag X	Mag Y	Mag Z
0.0569227	0.0173992	-0.00785436	1.69E-05	1.38E-05	2.52E-06
0.0567683	0.0158982	-0.00775792	1.72E-05	1.30E-05	2.64E-06
0.0566395	0.014118	-0.00861976	1.74E-05	1.12E-05	2.92E-06
0.0564807	0.0126424	-0.00842301	1.68E-05	1.21E-05	3.14E-06
0.0563842	0.0107221	-0.00976022	1.75E-05	1.31E-05	3.10E-06
0.0561617	0.00961127	-0.00831356	2.15E-05	2.08E-05	3.52E-06
0.0560127	0.00804088	-0.00839616	2.45E-05	3.56E-05	6.28E-06
0.0711738	0.0136548	-0.00831102	1.65E-05	1.58E-05	4.65E-06
0.0710695	0.011909	-0.00907696	1.69E-05	1.46E-05	5.45E-06
0.070867	0.010582	-0.00829981	1.73E-05	1.66E-05	5.58E-06
0.0707241	0.00901078	-0.00838508	1.65E-05	1.53E-05	5.59E-06
0.0705869	0.00738417	-0.00876471	1.58E-05	1.64E-05	6.10E-06
0.0703713	0.00619431	-0.0075012	1.29E-05	2.43E-05	6.20E-06
0.0856788	0.0114062	-0.00888613	1.52E-05	2.12E-05	9.68E-06
0.0853822	0.0104567	-0.00676562	1.64E-05	2.14E-05	9.89E-06
0.0853091	0.00861401	-0.00781223	1.72E-05	2.31E-05	1.00E-05
0.0851162	0.00724628	-0.00722899	1.46E-05	2.23E-05	9.90E-06
0.0850504	0.00538509	-0.00837034	1.39E-05	2.04E-05	1.01E-05
0.084862	0.00403047	-0.00768267	1.31E-05	2.20E-05	1.04E-05
0.100024	0.00996901	-0.006501	1.66E-05	2.30E-05	1.66E-05
0.0998649	0.00851797	-0.00620758	2.03E-05	2.25E-05	1.68E-05
0.0997965	0.0066736	-0.00725298	1.60E-05	2.56E-05	2.09E-05
0.0996499	0.00515385	-0.00714384	1.33E-05	2.69E-05	1.56E-05
0.0994448	0.00386692	-0.00626958	1.21E-05	2.79E-05	1.52E-05
0.0994201	0.00185157	-0.00788289	1.38E-05	2.82E-05	1.48E-05
0.114577	0.00796509	-0.00615468	2.19E-05	2.50E-05	2.52E-05
0.114443	0.00641769	-0.00614415	2.41E-05	2.15E-05	2.93E-05
0.114301	0.00489729	-0.00603587	2.16E-05	2.71E-05	3.34E-05
0.114101	0.00351575	-0.00544857	1.52E-05	2.70E-05	2.76E-05
0.114107	0.00153816	-0.00696717	1.45E-05	2.85E-05	2.32E-05
0.113873	0.000267096	-0.00599332	1.40E-05	2.94E-05	2.28E-05
0.129086	0.00626238	-0.00467162	1.72E-05	2.73E-05	3.65E-05
0.128917	0.00482391	-0.0042773	2.05E-05	2.77E-05	3.43E-05
0.128834	0.00311161	-0.00483913	1.74E-05	2.42E-05	3.83E-05
0.128714	0.00153461	-0.00491899	1.70E-05	2.82E-05	3.34E-05
0.128556	8.09E-05	-0.00461815	1.59E-05	3.14E-05	3.18E-05
0.128421	-0.00150843	-0.00469224	1.40E-05	2.78E-05	3.53E-05
0.143691	0.00442551	-0.00368765	1.97E-05	3.12E-05	4.86E-05
0.143563	0.00283645	-0.0037683	1.95E-05	3.14E-05	4.61E-05
0.143516	0.00109223	-0.00442124	1.87E-05	3.13E-05	4.51E-05
0.143335	-0.000320414	-0.00392677	1.87E-05	3.48E-05	4.28E-05

0.143219	-0.00192649	-0.00410021	1.81E-05	3.65E-05	4.35E-05
0.143016	-0.00328241	-0.00341151	1.81E-05	3.85E-05	4.74E-05
0.158131	0.00119514	-0.00203119	2.19E-05	3.37E-05	5.54E-05
0.157987	-0.0003006	-0.00182412	2.16E-05	3.70E-05	5.48E-05
0.157902	-0.00196263	-0.00218865	1.90E-05	6.33E-05	5.12E-05
0.15772	-0.00337486	-0.0016921	1.99E-05	3.98E-05	5.26E-05
0.157635	-0.00501157	-0.00195529	1.77E-05	3.59E-05	5.62E-05
0.172891	-0.000788349	-0.00145267	3.74E-05	7.73E-05	5.22E-05
0.172587	-0.00195125	-0.000103254	2.25E-05	0.000100099	5.65E-05
0.172498	-0.0035869	-0.000370657	2.10E-05	9.75E-05	5.77E-05
0.172409	-0.00519665	-0.000538737	1.93E-05	6.67E-05	6.20E-05
0.172426	-0.00703341	-0.00146456	1.84E-05	3.76E-05	6.75E-05
0.187421	-0.00222479	0.00101309	5.22E-05	0.000148265	4.71E-05
0.187441	-0.00403146	0.000178977	3.33E-05	0.000128361	5.49E-05
0.187246	-0.00543247	0.000669224	1.98E-05	9.80E-05	6.63E-05
0.187132	-0.00700091	0.000696508	1.94E-05	4.20E-05	7.62E-05
0.187078	-0.00867044	0.000343121	1.85E-05	4.10E-05	8.15E-05
0.202225	-0.00411699	0.00194661	3.61E-05	8.21E-05	7.67E-05
0.202023	-0.00550488	0.00253611	2.01E-05	7.21E-05	8.37E-05
0.201935	-0.00711685	0.00236783	2.00E-05	4.52E-05	8.71E-05
0.20178	-0.00858886	0.00267699	2.01E-05	4.56E-05	8.65E-05
0.201797	-0.0103869	0.00195148	1.96E-05	4.51E-05	8.93E-05
0.201597	-0.0118013	0.00245112	1.86E-05	4.49E-05	9.08E-05
0.216671	-0.00706992	0.00459223	2.10E-05	4.81E-05	9.77E-05
0.216585	-0.00865612	0.00452294	2.11E-05	4.94E-05	9.90E-05
0.216487	-0.0102419	0.00445305	2.15E-05	5.12E-05	9.96E-05
0.216331	-0.0117279	0.00476864	2.13E-05	5.28E-05	9.80E-05
0.216583	-0.0138898	0.00281969	2.00E-05	5.32E-05	0.000100107
0.231273	-0.00852939	0.00700993	2.20E-05	5.27E-05	0.000105203
0.231199	-0.0101443	0.00684567	2.19E-05	5.35E-05	0.000105831
0.231082	-0.0116752	0.00696854	2.22E-05	5.47E-05	0.000108002
0.230878	-0.0131034	0.00747037	2.18E-05	5.58E-05	0.000108815
0.23105	-0.0150953	0.00609242	2.05E-05	5.55E-05	0.000107571
0.230659	-0.016207	0.00763496	2.03E-05	5.53E-05	0.000107961
0.24594	-0.0117564	0.00878349	2.24E-05	5.66E-05	0.00011142
0.245794	-0.0132595	0.00899896	2.23E-05	5.79E-05	0.000115056
0.245833	-0.0150356	0.00837856	2.20E-05	5.73E-05	0.000116167
0.245571	-0.0163661	0.00916058	2.13E-05	5.69E-05	0.000116407
0.245628	-0.0181734	0.00845082	2.09E-05	5.74E-05	0.000117228
0.260428	-0.0130029	0.0119208	2.31E-05	6.00E-05	0.000120576
0.260523	-0.0148239	0.0111112	2.31E-05	6.03E-05	0.000121687
0.260411	-0.0163713	0.011243	2.29E-05	5.95E-05	0.000121617
0.260246	-0.0178471	0.0115569	2.21E-05	5.97E-05	0.000120766
0.260398	-0.0197732	0.0104774	2.16E-05	5.99E-05	0.000121185
0.260335	-0.0213962	0.0103282	2.11E-05	6.08E-05	0.000121533
0.275255	-0.0146876	0.0136415	2.32E-05	6.30E-05	0.00012721
0.275213	-0.0163098	0.0134896	2.31E-05	6.34E-05	0.000127599
0.275255	-0.0180617	0.0129704	2.29E-05	6.32E-05	0.000127054
0.275005	-0.0194233	0.0136583	2.24E-05	6.36E-05	0.000127109
0.275134	-0.0212812	0.0127672	2.19E-05	6.38E-05	0.000125749
0.274902	-0.0226846	0.0133692	2.15E-05	6.36E-05	0.000124551
0.274901	-0.0243693	0.0130413	2.13E-05	6.35E-05	0.000123989

0.289471	-0.0172245	0.017713	2.29E-05	6.40E-05	0.000129155
0.28974	-0.0192664	0.0162645	2.28E-05	6.38E-05	0.000128984
0.289499	-0.0206291	0.0169553	2.22E-05	6.46E-05	0.000128492
0.289735	-0.0226057	0.0156975	2.19E-05	6.54E-05	0.000127778
0.289341	-0.023804	0.0169493	2.17E-05	6.48E-05	0.000126292
0.289508	-0.0256962	0.0159747	2.15E-05	6.58E-05	0.000125402
0.304341	-0.0205824	0.0191689	2.22E-05	6.50E-05	0.000129199
0.304392	-0.0223386	0.0186561	2.18E-05	6.60E-05	0.000129446
0.304266	-0.0238492	0.018886	2.16E-05	6.68E-05	0.000129796
0.304139	-0.0253598	0.0191176	2.18E-05	6.67E-05	0.000128985
0.304286	-0.0272249	0.0182378	2.14E-05	6.73E-05	0.000126745
0.304157	-0.0287496	0.0184772	2.08E-05	6.79E-05	0.000125223
0.319062	-0.0237225	0.0213613	2.16E-05	6.71E-05	0.000129358
0.318799	-0.0250869	0.0220501	2.16E-05	6.82E-05	0.000130021
0.318648	-0.026582	0.022379	2.13E-05	6.83E-05	0.00012954
0.318773	-0.0283904	0.0216923	2.08E-05	6.89E-05	0.0001264
0.31871	-0.0299917	0.0216492	2.02E-05	6.92E-05	0.000124751
0.318608	-0.0315344	0.021796	2.01E-05	6.89E-05	0.000123789
0.333427	-0.0264343	0.0249263	2.12E-05	6.87E-05	0.000129463
0.333449	-0.028125	0.024606	2.10E-05	6.90E-05	0.00012869
0.333587	-0.0299365	0.0239245	2.04E-05	6.99E-05	0.000125644
0.333489	-0.0314815	0.0240715	1.99E-05	7.00E-05	0.000123749
0.333326	-0.032966	0.0244	2.00E-05	6.96E-05	0.000122428
0.333567	-0.0349023	0.0233584	1.95E-05	6.90E-05	0.000122
0.348064	-0.0294398	0.0275534	2.03E-05	7.00E-05	0.000127463
0.347833	-0.0308364	0.0281575	1.98E-05	7.09E-05	0.000125056
0.347862	-0.0325307	0.0278448	1.94E-05	7.08E-05	0.000122428
0.347931	-0.034257	0.027447	1.93E-05	7.04E-05	0.000121262
0.347698	-0.0356529	0.0280564	1.90E-05	6.96E-05	0.000120227
0.347861	-0.0375014	0.0272934	1.83E-05	6.95E-05	0.000118306
0.36231	-0.0320119	0.0315404	1.89E-05	6.99E-05	0.000122415
0.362645	-0.0340087	0.030325	1.84E-05	6.98E-05	0.000120211
0.362397	-0.0354062	0.0309287	1.85E-05	6.96E-05	0.000118716
0.362278	-0.0369111	0.0311704	1.80E-05	6.96E-05	0.000116127
0.362625	-0.0389442	0.0298672	1.75E-05	6.99E-05	0.000114486
0.36236	-0.0403116	0.0305714	1.70E-05	7.06E-05	0.000112403
0.376935	-0.0349848	0.0343274	1.70E-05	6.84E-05	0.000114988
0.377041	-0.036732	0.0338394	1.66E-05	6.81E-05	0.000112657
0.376921	-0.0382522	0.0340866	1.65E-05	6.84E-05	0.000110639
0.376937	-0.0399107	0.0338746	1.63E-05	6.95E-05	0.000109307
0.376993	-0.0416144	0.0335823	1.62E-05	7.12E-05	0.000108595
0.377225	-0.043503	0.0327491	1.58E-05	7.17E-05	0.000104536
0.391576	-0.0379598	0.037097	1.50E-05	6.76E-05	0.000106016
0.39146	-0.0394689	0.0373422	1.46E-05	6.76E-05	0.000103192
0.391452	-0.0410993	0.0372239	1.48E-05	6.83E-05	0.000103025
0.391149	-0.0424384	0.0380175	1.48E-05	6.99E-05	0.000102715
0.391569	-0.0444988	0.0366412	1.49E-05	7.07E-05	9.94E-05
0.39258	-0.0471616	0.0335644	1.41E-05	7.07E-05	9.38E-05
0.40587	-0.0405737	0.0409326	1.32E-05	6.65E-05	9.71E-05
0.405679	-0.0420231	0.0413562	1.28E-05	6.60E-05	9.54E-05
0.405848	-0.0438091	0.0407986	1.28E-05	6.61E-05	9.46E-05
0.406002	-0.0456097	0.0402427	1.28E-05	6.59E-05	9.17E-05

0.405948	-0.0471837	0.0403177	1.27E-05	6.82E-05	8.74E-05
0.409632	-0.05241	0.0298152	1.20E-05	6.81E-05	8.66E-05
0.42038	-0.0434143	0.0441159	1.15E-05	6.29E-05	8.73E-05
0.420265	-0.0449278	0.0443682	1.12E-05	6.11E-05	8.47E-05
0.420531	-0.04681	0.0435457	1.14E-05	6.05E-05	8.20E-05
0.420513	-0.0484173	0.0435341	1.08E-05	6.33E-05	8.10E-05
0.420396	-0.0499322	0.0437922	9.94E-06	6.33E-05	7.74E-05
0.434989	-0.0463203	0.0471074	9.12E-06	5.80E-05	7.52E-05
0.434591	-0.0475901	0.0480698	8.42E-06	5.55E-05	7.13E-05
0.434782	-0.049384	0.0475277	8.40E-06	5.63E-05	7.08E-05
0.43469	-0.0509181	0.0476898	8.29E-06	5.72E-05	6.89E-05
0.434709	-0.0525592	0.0475961	8.14E-06	5.73E-05	6.27E-05
0.449322	-0.0489841	0.0507811	6.73E-06	5.37E-05	6.33E-05
0.449103	-0.0504103	0.0513062	6.39E-06	5.28E-05	6.09E-05
0.449234	-0.0521464	0.0509489	6.70E-06	5.26E-05	5.91E-05
0.449179	-0.0537146	0.0510266	6.81E-06	5.29E-05	5.43E-05
0.448959	-0.0551401	0.0515568	6.66E-06	5.03E-05	5.00E-05
0.463572	-0.0515723	0.0547054	5.09E-06	4.88E-05	5.19E-05
0.463447	-0.0530934	0.0549636	4.98E-06	4.77E-05	4.86E-05
0.46366	-0.0548823	0.0544337	5.15E-06	4.76E-05	4.72E-05
0.463715	-0.0565477	0.0542523	5.44E-06	4.64E-05	4.47E-05
0.46389	-0.0583085	0.0538147	5.33E-06	4.36E-05	4.09E-05
0.477848	-0.0541952	0.0585078	3.77E-06	4.27E-05	4.00E-05
0.477837	-0.0557995	0.0585033	3.76E-06	4.18E-05	3.75E-05
0.47806	-0.0575926	0.0579815	4.16E-06	4.17E-05	3.66E-05
0.478418	-0.0595132	0.0571071	4.44E-06	4.03E-05	3.45E-05
0.477639	-0.0604582	0.0589487	4.33E-06	3.75E-05	3.00E-05
0.492731	-0.0573232	0.0608851	2.58E-06	3.57E-05	2.90E-05
0.492087	-0.0583995	0.0623701	2.69E-06	3.47E-05	2.69E-05
0.49246	-0.0603222	0.0615033	3.10E-06	3.42E-05	2.60E-05
0.492539	-0.0619952	0.0613396	3.42E-06	3.29E-05	2.31E-05
0.492303	-0.0634022	0.0618634	3.78E-06	3.05E-05	2.06E-05
0.506834	-0.0598159	0.0650718	1.64E-06	3.00E-05	2.12E-05
0.506726	-0.0613205	0.065339	1.85E-06	2.86E-05	1.88E-05
0.5068	-0.0629962	0.0651741	2.61E-06	2.74E-05	1.72E-05
0.506495	-0.0643426	0.0658767	3.39E-06	2.62E-05	1.62E-05
0.506697	-0.0661147	0.065462	3.67E-06	2.61E-05	1.61E-05

Source File Name: beam3lb_neg15deg_fast_150Hz
Signal: FFT - Vib 3D Velocity - Magnitude
dB-Reference: 0 dB = 1 m/s
Band No.: 1
Frequency: 150.0 Hz

Interpolated: Yes
Filtered: Yes

X	Y	Z	Mag X	Mag Y	Mag Z
0.0569227	0.0173992	-0.00785436	2.91E-05	3.91E-05	0.000118031
0.0567683	0.0158982	-0.00775792	2.96E-05	4.37E-05	0.000110279
0.0566395	0.014118	-0.00861976	3.47E-05	4.94E-05	0.000113216

0.0564807	0.0126424	-0.00842301	3.84E-05	3.72E-05	0.000113694
0.0563842	0.0107221	-0.00976022	3.60E-05	3.24E-05	0.000117901
0.0561617	0.00961127	-0.00831356	4.73E-05	2.68E-05	0.000127712
0.0560127	0.00804088	-0.00839616	7.81E-05	6.00E-05	0.000140407
0.0711738	0.0136548	-0.00831102	3.63E-05	3.90E-05	0.000239895
0.0710695	0.011909	-0.00907696	4.10E-05	4.20E-05	0.000268897
0.070867	0.010582	-0.00829981	4.37E-05	2.92E-05	0.000268349
0.0707241	0.00901078	-0.00838508	3.84E-05	4.10E-05	0.000270338
0.0705869	0.00738417	-0.00876471	4.10E-05	4.25E-05	0.000275853
0.0703713	0.00619431	-0.0075012	5.53E-05	3.27E-05	0.000279783
0.0856788	0.0114062	-0.00888613	6.72E-05	3.97E-05	0.000529468
0.0853822	0.0104567	-0.00676562	6.36E-05	3.98E-05	0.000523605
0.0853091	0.00861401	-0.00781223	8.69E-05	0.000114044	0.000492482
0.0851162	0.00724628	-0.00722899	8.59E-05	0.00013123	0.000496114
0.0850504	0.00538509	-0.00837034	5.50E-05	0.000103944	0.000536122
0.084862	0.00403047	-0.00768267	8.12E-05	0.000105672	0.000539961
0.100024	0.00996901	-0.006501	0.000108047	2.92E-05	0.000841691
0.0998649	0.00851797	-0.00620758	0.000127973	9.95E-05	0.000792875
0.0997965	0.0066736	-0.00725298	0.000172984	0.000238142	0.000753301
0.0996499	0.00515385	-0.00714384	0.000167549	0.00027085	0.000755307
0.0994448	0.00386692	-0.00626958	0.000140086	0.000197778	0.000833745
0.0994201	0.00185157	-0.00788289	0.00013702	0.000146859	0.000862143
0.114577	0.00796509	-0.00615468	0.000163834	8.20E-05	0.001178
0.114443	0.00641769	-0.00614415	0.000137929	2.35E-05	0.0011959
0.114301	0.00489729	-0.00603587	0.000138567	8.59E-05	0.00117554
0.114101	0.00351575	-0.00544857	0.00014352	7.93E-05	0.00118836
0.114107	0.00153816	-0.00696717	0.00013003	4.33E-05	0.00121095
0.113873	0.000267096	-0.00599332	0.000162691	4.83E-05	0.00120687
0.129086	0.00626238	-0.00467162	0.000277013	0.000261543	0.0014966
0.128917	0.00482391	-0.0042773	0.000298054	0.00031349	0.00143915
0.128834	0.00311161	-0.00483913	0.000177778	6.64E-05	0.00151988
0.128714	0.00153461	-0.00491899	0.000253427	0.000261962	0.00147385
0.128556	8.09E-05	-0.00461815	0.000262	0.00026063	0.00145931
0.128421	-0.00150843	-0.00469224	0.000282738	0.000304797	0.00142324
0.143691	0.00442551	-0.00368765	0.000503465	0.00073956	0.00160479
0.143563	0.00283645	-0.0037683	0.000501824	0.000734154	0.00154974
0.143516	0.00109223	-0.00442124	0.000481021	0.000721531	0.00151331
0.143335	-0.000320414	-0.00392677	0.000625484	0.00105692	0.00147261
0.143219	-0.00192649	-0.00410021	0.000717533	0.00127545	0.00141528
0.143016	-0.00328241	-0.00341151	0.000700304	0.00123396	0.00142513
0.158131	0.00119514	-0.00203119	0.000832693	0.00145296	0.00150614
0.157987	-0.0003006	-0.00182412	0.000799976	0.00137316	0.00154228
0.157902	-0.00196263	-0.00218865	0.000950044	0.0017318	0.00149971
0.15772	-0.00337486	-0.0016921	0.000998509	0.00184057	0.00148986
0.157635	-0.00501157	-0.00195529	0.00101066	0.00186762	0.0014763
0.172891	-0.000788349	-0.00145267	0.00138984	0.00267567	0.00129894
0.172587	-0.00195125	-0.000103254	0.00133291	0.00254354	0.0013502
0.172498	-0.0035869	-0.000370657	0.00112039	0.00206216	0.00148923
0.172409	-0.00519665	-0.000538737	0.00114737	0.00244151	0.0014346
0.172426	-0.00703341	-0.00146456	0.00130941	0.00247567	0.00141487
0.187421	-0.00222479	0.00101309	0.00123076	0.00229431	0.00149074
0.187441	-0.00403146	0.000178977	0.00101384	0.00180247	0.00161115

0.187246	-0.00543247	0.000669224	0.000620947	0.0012499	0.00172756
0.187132	-0.00700091	0.000696508	0.000768269	0.00161031	0.00167737
0.187078	-0.00867044	0.000343121	0.000844037	0.00160775	0.00163296
0.202225	-0.00411699	0.00194661	0.000520587	0.000719606	0.00191303
0.202023	-0.00550488	0.00253611	0.000481308	0.000630036	0.00192965
0.201935	-0.00711685	0.00236783	0.000415947	0.000156128	0.00202626
0.20178	-0.00858886	0.00267699	0.000546046	0.000419075	0.00192788
0.201797	-0.0103869	0.00195148	0.000620826	0.000398683	0.00188897
0.201597	-0.0118013	0.00245112	0.000557827	0.000488394	0.00185287
0.216671	-0.00706992	0.00459223	0.000236191	0.000131939	0.00195581
0.216585	-0.00865612	0.00452294	0.000204609	4.78E-05	0.00191076
0.216487	-0.0102419	0.00445305	0.00034069	4.94E-05	0.00186351
0.216331	-0.0117279	0.00476864	0.00024792	2.39E-05	0.001841
0.216583	-0.0138898	0.00281969	0.000259849	2.99E-05	0.00175012
0.231273	-0.00852939	0.00700993	0.000108348	2.22E-05	0.00166655
0.231199	-0.0101443	0.00684567	0.000117427	9.85E-06	0.00166027
0.231082	-0.0116752	0.00696854	0.000100676	2.32E-05	0.00163871
0.230878	-0.0131034	0.00747037	0.000107562	1.05E-05	0.00167585
0.23105	-0.0150953	0.00609242	0.000131832	1.39E-05	0.00157649
0.230659	-0.016207	0.00763496	0.000136612	1.77E-05	0.00146421
0.24594	-0.0117564	0.00878349	4.66E-05	5.42E-05	0.00140837
0.245794	-0.0132595	0.00899896	3.17E-05	1.10E-05	0.0013769
0.245833	-0.0150356	0.00837856	3.10E-05	1.31E-05	0.00141353
0.245571	-0.0163661	0.00916058	2.32E-05	1.44E-05	0.00130713
0.245628	-0.0181734	0.00845082	1.12E-05	1.33E-05	0.00117142
0.260428	-0.0130029	0.0119208	6.30E-05	0.000151116	0.000936329
0.260523	-0.0148239	0.0111112	6.27E-05	6.68E-05	0.000947299
0.260411	-0.0163713	0.011243	5.85E-05	3.34E-05	0.00098228
0.260246	-0.0178471	0.0115569	5.18E-05	2.94E-05	0.000991652
0.260398	-0.0197732	0.0104774	5.61E-05	2.08E-05	0.00095598
0.260335	-0.0213962	0.0103282	6.24E-05	2.39E-05	0.000875236
0.275255	-0.0146876	0.0136415	0.000158641	0.00013157	0.000447283
0.275213	-0.0163098	0.0134896	0.000155626	6.66E-05	0.000475811
0.275255	-0.0180617	0.0129704	0.000150718	5.78E-05	0.000494407
0.275005	-0.0194233	0.0136583	0.000139705	5.02E-05	0.000517212
0.275134	-0.0212812	0.0127672	0.000141932	4.89E-05	0.000525672
0.274902	-0.0226846	0.0133692	0.00013638	4.85E-05	0.000532905
0.274901	-0.0243693	0.0130413	0.000137735	5.44E-05	0.000538335
0.289471	-0.0172245	0.017713	0.000259145	0.000101835	4.49E-05
0.28974	-0.0192664	0.0162645	0.000281566	9.57E-05	3.02E-05
0.289499	-0.0206291	0.0169553	0.000269704	8.84E-05	2.49E-05
0.289735	-0.0226057	0.0156975	0.000268866	8.77E-05	2.13E-05
0.289341	-0.023804	0.0169493	0.000269659	9.57E-05	2.09E-05
0.289508	-0.0256962	0.0159747	0.000302967	0.000101514	0.000172844
0.304341	-0.0205824	0.0191689	0.000365502	0.000128759	0.000482438
0.304392	-0.0223386	0.0186561	0.000371733	0.000127281	0.000570803
0.304266	-0.0238492	0.018886	0.000374006	0.000133752	0.000566065
0.304139	-0.0253598	0.0191176	0.000376412	0.000132646	0.000557272
0.304286	-0.0272249	0.0182378	0.000391337	0.000130628	0.000630047
0.304157	-0.0287496	0.0184772	0.000438643	0.000136168	0.000804795
0.319062	-0.0237225	0.0213613	0.000461673	0.000159476	0.00101546
0.318799	-0.0250869	0.0220501	0.000485138	0.000167747	0.001103

0.318648	-0.026582	0.022379	0.000487848	0.00017238	0.00109695
0.318773	-0.0283904	0.0216923	0.000482847	0.000173821	0.00108532
0.31871	-0.0299917	0.0216492	0.00050613	0.000168934	0.00116823
0.318608	-0.0315344	0.021796	0.000543179	0.000174395	0.00124556
0.333427	-0.0264343	0.0249263	0.000571908	0.000198608	0.00151199
0.333449	-0.028125	0.024606	0.000592149	0.000211824	0.00159544
0.333587	-0.0299365	0.0239245	0.000587532	0.000225362	0.00159843
0.333489	-0.0314815	0.0240715	0.000580515	0.000220893	0.00158849
0.333326	-0.032966	0.0244	0.000600044	0.000208883	0.00157609
0.333567	-0.0349023	0.0233584	0.00064365	0.000221926	0.00164662
0.348064	-0.0294398	0.0275534	0.00067542	0.000255424	0.00197047
0.347833	-0.0308364	0.0281575	0.000697666	0.000286305	0.0020512
0.347862	-0.0325307	0.0278448	0.000699505	0.000278175	0.00204351
0.347931	-0.034257	0.027447	0.000695235	0.000268114	0.00202784
0.347698	-0.0356529	0.0280564	0.000715415	0.000336969	0.00202589
0.347861	-0.0375014	0.0272934	0.000754525	0.000278571	0.0021441
0.36231	-0.0320119	0.0315404	0.000754249	0.000295921	0.00237649
0.362645	-0.0340087	0.030325	0.000770193	0.00030039	0.00243793
0.362397	-0.0354062	0.0309287	0.000786794	0.000370726	0.00243625
0.362278	-0.0369111	0.0311704	0.000791765	0.000472994	0.00243879
0.362625	-0.0389442	0.0298672	0.000825871	0.00045882	0.00249184
0.36236	-0.0403116	0.0305714	0.000828348	0.000380402	0.00257618
0.376935	-0.0349848	0.0343274	0.000824922	0.000326851	0.0027074
0.377041	-0.036732	0.0338394	0.000856639	0.000352388	0.00276531
0.376921	-0.0382522	0.0340866	0.000869993	0.000518296	0.00277216
0.376937	-0.0399107	0.0338746	0.000885612	0.000556251	0.00276666
0.376993	-0.0416144	0.0335823	0.000875597	0.000528015	0.00278574
0.377225	-0.043503	0.0327491	0.000831436	0.00041991	0.0027705
0.391576	-0.0379598	0.037097	0.000869419	0.000393116	0.00291394
0.39146	-0.0394689	0.0373422	0.00087573	0.000433847	0.00294521
0.391452	-0.0410993	0.0372239	0.000884337	0.000466567	0.00293613
0.391149	-0.0424384	0.0380175	0.000875312	0.000479025	0.00288307
0.391569	-0.0444988	0.0366412	0.00083375	0.000386294	0.00284205
0.39258	-0.0471616	0.0335644	0.000805496	0.000352262	0.00281913
0.40587	-0.0405737	0.0409326	0.000861853	0.00039985	0.00296806
0.405679	-0.0420231	0.0413562	0.000859436	0.000400331	0.00295507
0.405848	-0.0438091	0.0407986	0.000857134	0.000411499	0.00291601
0.406002	-0.0456097	0.0402427	0.00083309	0.000376226	0.00287987
0.405948	-0.0471837	0.0403177	0.000808812	0.000320108	0.00285697
0.409632	-0.05241	0.0298152	0.000799179	0.000316808	0.00280857
0.42038	-0.0434143	0.0441159	0.000824412	0.000346948	0.0029073
0.420265	-0.0449278	0.0443682	0.000814139	0.000362567	0.00286536
0.420531	-0.04681	0.0435457	0.000809562	0.000322631	0.00284187
0.420513	-0.0484173	0.0435341	0.000796919	0.000323508	0.00279761
0.420396	-0.0499322	0.0437922	0.000768126	0.000313713	0.00268781
0.434989	-0.0463203	0.0471074	0.000769705	0.000324698	0.0027536
0.434591	-0.0475901	0.0480698	0.000758287	0.000322373	0.00270865
0.434782	-0.049384	0.0475277	0.000748035	0.000317246	0.00269025
0.43469	-0.0509181	0.0476898	0.000722165	0.000311328	0.00259499
0.434709	-0.0525592	0.0475961	0.000679561	0.000301986	0.00244501
0.449322	-0.0489841	0.0507811	0.00069441	0.000310236	0.00250811
0.449103	-0.0504103	0.0513062	0.000669125	0.000302067	0.00244909

0.449234	-0.0521464	0.0509489	0.000658206	0.000298043	0.00242115
0.449179	-0.0537146	0.0510266	0.000626637	0.000291867	0.00230393
0.448959	-0.0551401	0.0515568	0.000584525	0.000284017	0.00217419
0.463572	-0.0515723	0.0547054	0.000591593	0.000286539	0.00217539
0.463447	-0.0530934	0.0549636	0.000567616	0.000278728	0.00209647
0.46366	-0.0548823	0.0544337	0.000568156	0.000281401	0.00207102
0.463715	-0.0565477	0.0542523	0.000540114	0.000276515	0.00198448
0.46389	-0.0583085	0.0538147	0.000488112	0.000261799	0.00183448
0.477848	-0.0541952	0.0585078	0.000474242	0.000259641	0.00178014
0.477837	-0.0557995	0.0585033	0.000455928	0.000257817	0.00169471
0.47806	-0.0575926	0.0579815	0.000450454	0.00025883	0.00166518
0.478418	-0.0595132	0.0571071	0.000417776	0.000244805	0.00156453
0.477639	-0.0604582	0.0589487	0.000388848	0.000228435	0.00140385
0.492731	-0.0573232	0.0608851	0.000355653	0.000221879	0.00134992
0.492087	-0.0583995	0.0623701	0.000334326	0.000212225	0.00125038
0.49246	-0.0603222	0.0615033	0.000319307	0.000205906	0.00121362
0.492539	-0.0619952	0.0613396	0.000313361	0.000199915	0.00111851
0.492303	-0.0634022	0.0618634	0.000286395	0.000197769	0.00103611
0.506834	-0.0598159	0.0650718	0.000272343	0.000188102	0.00100974
0.506726	-0.0613205	0.065339	0.000246332	0.000178664	0.000893996
0.5068	-0.0629962	0.0651741	0.000231386	0.000181338	0.00086897
0.506495	-0.0643426	0.0658767	0.00021957	0.000183848	0.000844811
0.506697	-0.0661147	0.065462	0.00021971	0.00018547	0.000847297

Source File Name: beam3lb_neg30deg_fast_60H
z
Signal: FFT - Vib 3D Velocity - Magnitude
dB-Reference: 0 dB = 1 m/s
Band No.: 1
Frequency: 60.00 Hz

Interpolated: Yes
Filtered: Yes

X	Y	Z	Mag X	Mag Y	Mag Z
0.0685788	0.0181916	-0.00286927	1.86E-06	1.58E-06	1.30E-06
0.0836412	0.0166094	-0.0030387	1.83E-06	1.49E-06	1.55E-06
0.0835434	0.0153833	-0.00236822	1.93E-06	1.69E-06	8.67E-07
0.0684804	0.0169183	-0.00228714	1.89E-06	1.02E-06	1.30E-06
0.0834515	0.0135322	-0.00283605	2.07E-06	6.25E-07	1.52E-06
0.0683762	0.0152471	-0.00239778	2.03E-06	3.30E-07	2.21E-06
0.0987412	0.015019	-0.00325087	1.98E-06	2.29E-06	2.47E-06
0.0986513	0.0134896	-0.00309802	2.31E-06	2.10E-06	1.90E-06
0.0985669	0.011829	-0.00321379	1.80E-06	1.05E-06	2.40E-06
0.113772	0.0123441	-0.00245987	2.45E-06	1.95E-06	2.30E-06
0.113725	0.0101517	-0.00353766	2.00E-06	1.16E-06	3.04E-06
0.113628	0.00886169	-0.0029425	1.88E-06	7.13E-07	3.39E-06
0.0984872	0.00996064	-0.0036702	1.40E-06	7.72E-07	3.02E-06
0.128946	0.0107918	-0.00255624	2.42E-06	1.75E-06	3.02E-06
0.128895	0.00893562	-0.00301952	2.08E-06	2.26E-06	3.55E-06

0.128804	0.00761053	-0.00251883	1.99E-06	1.54E-06	3.96E-06
0.128737	0.00593242	-0.00262079	2.09E-06	4.40E-07	3.87E-06
0.113563	0.00700464	-0.00340303	2.08E-06	5.21E-07	3.09E-06
0.144039	0.00813491	-0.00174914	1.09E-06	2.46E-06	3.59E-06
0.143973	0.0065675	-0.00168482	1.45E-06	1.34E-06	4.10E-06
0.143925	0.00479152	-0.00196024	1.44E-06	1.04E-06	4.37E-06
0.159115	0.00584412	-0.00027431	1.91E-06	6.69E-07	4.24E-06
0.15909	0.00397052	-0.000722973	2.05E-06	7.75E-07	5.16E-06
0.159065	0.00210922	-0.00117689	1.80E-06	1.07E-06	4.80E-06
0.143831	0.00351464	-0.00136863	1.29E-06	7.81E-07	4.25E-06
0.17434	0.00451817	5.54E-05	2.07E-06	6.46E-07	5.11E-06
0.174221	0.00342163	0.00100245	1.99E-06	1.37E-06	6.05E-06
0.174223	0.00146258	0.000375799	1.88E-06	1.18E-06	5.99E-06
0.17415	2.50E-05	0.000716455	1.95E-06	1.87E-06	5.44E-06
0.158988	0.000671656	-0.000836795	1.75E-06	1.94E-06	4.70E-06
0.189384	0.000796108	0.0018939	2.05E-06	2.26E-06	6.91E-06
0.189315	-0.000641573	0.00223525	2.15E-06	2.45E-06	6.67E-06
0.189247	-0.00206546	0.00257048	1.99E-06	2.65E-06	7.18E-06
0.174129	-0.00188742	0.000179925	1.60E-06	2.10E-06	5.71E-06
0.204487	-0.00132834	0.00372012	2.60E-06	2.79E-06	7.04E-06
0.204511	-0.00324243	0.00318884	2.41E-06	3.08E-06	7.46E-06
0.204314	-0.00394508	0.00483488	2.31E-06	3.33E-06	8.08E-06
0.189278	-0.00414066	0.00178645	1.87E-06	2.58E-06	7.64E-06
0.219595	-0.00345979	0.00550683	2.49E-06	3.60E-06	8.26E-06
0.219514	-0.00479996	0.00602617	2.47E-06	3.71E-06	8.20E-06
0.219523	-0.00656871	0.00576057	2.65E-06	3.17E-06	8.86E-06
0.204418	-0.00640089	0.0033526	2.41E-06	2.84E-06	7.57E-06
0.234612	-0.00685488	0.00795669	2.65E-06	3.13E-06	9.16E-06
0.234512	-0.0080825	0.00864448	3.02E-06	2.44E-06	9.36E-06
0.219422	-0.00781042	0.00645598	2.70E-06	2.96E-06	9.17E-06
0.234552	-0.00996522	0.00821953	3.30E-06	2.49E-06	1.01E-05
0.21944	-0.00962994	0.00610781	2.96E-06	3.62E-06	1.07E-05
0.249582	-0.0100113	0.0108042	3.35E-06	2.95E-06	1.15E-05
0.249588	-0.0116973	0.0107278	2.72E-06	2.21E-06	9.85E-06
0.234527	-0.0115388	0.00830661	3.44E-06	1.97E-06	9.10E-06
0.264531	-0.0114674	0.0137918	2.48E-06	1.46E-06	8.84E-06
0.264573	-0.0132388	0.0135391	2.95E-06	3.32E-06	1.14E-05
0.249487	-0.0129242	0.0114201	2.47E-06	3.92E-06	1.04E-05
0.264509	-0.0146279	0.013983	3.05E-06	3.43E-06	1.19E-05
0.249481	-0.0145477	0.0114255	2.13E-06	3.69E-06	1.05E-05
0.279496	-0.014617	0.0166669	3.55E-06	4.15E-06	1.26E-05
0.279547	-0.0163898	0.0164201	2.80E-06	3.84E-06	1.07E-05
0.264563	-0.0164508	0.0136485	2.86E-06	3.18E-06	1.11E-05
0.279377	-0.0173664	0.0175446	2.24E-06	3.63E-06	9.55E-06
0.29428	-0.0171782	0.0205313	2.10E-06	3.34E-06	9.78E-06
0.294253	-0.018652	0.0208021	2.14E-06	4.06E-06	9.62E-06
0.279413	-0.0191041	0.0173947	1.90E-06	2.53E-06	9.11E-06
0.294329	-0.020476	0.0204772	2.36E-06	3.63E-06	9.32E-06
0.309137	-0.0200603	0.0238514	2.19E-06	3.36E-06	9.80E-06
0.309114	-0.0215342	0.0241263	2.86E-06	4.38E-06	1.04E-05
0.29439	-0.0222649	0.0202478	3.08E-06	3.84E-06	1.07E-05
0.309314	-0.0237106	0.0232125	2.97E-06	3.87E-06	1.12E-05

0.324024	-0.0230531	0.0269642	2.37E-06	2.57E-06	1.17E-05
0.323988	-0.0244771	0.0273284	2.43E-06	3.34E-06	1.04E-05
0.309338	-0.0253367	0.0232364	2.95E-06	3.87E-06	1.00E-05
0.323988	-0.0260525	0.0274371	2.43E-06	3.53E-06	1.01E-05
0.338576	-0.025153	0.0315602	2.64E-06	3.01E-06	8.62E-06
0.338848	-0.0274327	0.0304915	2.27E-06	3.08E-06	8.92E-06
0.323901	-0.0273255	0.0280585	2.50E-06	3.04E-06	1.04E-05
0.338869	-0.0290085	0.0306081	2.05E-06	2.84E-06	9.81E-06
0.353269	-0.0277292	0.0353602	1.82E-06	3.63E-06	1.02E-05
0.353315	-0.0293542	0.035395	1.77E-06	3.70E-06	9.67E-06
0.338926	-0.0306858	0.0305577	2.04E-06	2.89E-06	8.61E-06
0.353324	-0.0308785	0.0356	2.06E-06	3.47E-06	8.77E-06
0.367997	-0.030419	0.0389526	1.80E-06	2.35E-06	6.47E-06
0.36803	-0.0319939	0.0390767	1.74E-06	2.18E-06	6.17E-06
0.353578	-0.0330485	0.0347055	2.15E-06	3.23E-06	8.16E-06
0.367989	-0.0334039	0.0394428	2.05E-06	1.88E-06	7.21E-06
0.382403	-0.032414	0.0436711	2.05E-06	2.41E-06	7.32E-06
0.38261	-0.0343949	0.0431313	1.91E-06	3.08E-06	6.32E-06
0.368101	-0.0351828	0.0392353	2.00E-06	3.23E-06	7.84E-06
0.382483	-0.0355496	0.0439221	1.25E-06	2.72E-06	5.95E-06
0.368034	-0.0365045	0.0397835	2.17E-06	3.17E-06	8.65E-06
0.397014	-0.0349949	0.0474316	7.74E-07	1.63E-06	5.07E-06
0.396995	-0.0364033	0.0478072	8.96E-07	2.50E-06	5.85E-06
0.382521	-0.0371249	0.0440544	8.90E-07	2.88E-06	6.82E-06
0.396866	-0.0375566	0.0486	1.03E-06	2.72E-06	5.68E-06
0.382707	-0.0390443	0.0435965	6.94E-07	3.60E-06	7.61E-06
0.397041	-0.0394381	0.0482382	9.51E-07	2.94E-06	4.89E-06
0.41118	-0.0380168	0.0531004	6.47E-07	2.15E-06	3.73E-06
0.411354	-0.039885	0.0527315	7.45E-07	2.28E-06	3.65E-06
0.397217	-0.0413074	0.0478705	1.13E-06	3.86E-06	4.26E-06
0.411519	-0.0417026	0.0524514	2.84E-07	2.46E-06	3.73E-06
0.425603	-0.0403112	0.0572587	8.59E-08	2.19E-06	3.03E-06
0.425779	-0.0421283	0.0569832	4.42E-07	1.39E-06	3.17E-06
0.411569	-0.0432786	0.0525954	5.38E-07	2.12E-06	3.69E-06
0.42586	-0.0437414	0.0570397	5.90E-07	1.31E-06	3.43E-06
0.411825	-0.0453038	0.0519888	1.01E-06	1.79E-06	4.29E-06
0.425797	-0.0450465	0.0575924	2.89E-07	1.67E-06	3.04E-06
0.440026	-0.0440827	0.0616782	6.65E-07	1.39E-06	2.07E-06
0.440039	-0.0455414	0.0619862	9.32E-07	1.47E-06	1.26E-06
0.425877	-0.0466603	0.0576523	9.15E-07	1.29E-06	1.95E-06
0.440051	-0.0470002	0.0622958	1.13E-06	1.22E-06	1.68E-06
0.454122	-0.0457983	0.0667326	6.34E-07	1.65E-06	1.48E-06
0.454319	-0.0476171	0.0664725	8.11E-07	5.77E-07	1.63E-06
0.440113	-0.0485623	0.062443	9.60E-07	1.17E-06	1.84E-06
0.468569	-0.052554	0.0716063	1.08E-06	8.47E-07	1.84E-06
0.482353	-0.0510472	0.0764888	8.68E-07	7.51E-07	9.65E-07
0.48257	-0.052854	0.0762362	1.05E-06	1.71E-06	5.28E-07
0.468589	-0.0539994	0.0719196	1.16E-06	1.53E-06	1.43E-06
0.485218	-0.0573213	0.0774144	6.04E-07	4.31E-07	1.32E-07
0.490938	-0.0564463	0.0798234	3.07E-07	1.77E-07	4.21E-07
0.491332	-0.0585409	0.0790802	1.51E-07	9.79E-07	4.74E-07
0.490913	-0.0550015	0.0795037	6.65E-07	1.58E-06	3.14E-07

0.482933	-0.057194	0.0761784	1.25E-06	3.21E-07	5.57E-07
0.482838	-0.0561596	0.0762228	1.33E-06	1.77E-06	6.86E-07
0.491028	-0.0538162	0.0787819	4.56E-07	1.36E-06	2.84E-07
0.482704	-0.0545064	0.0762286	1.51E-06	2.12E-06	8.36E-07
0.490946	-0.0522678	0.0786266	1.27E-06	1.57E-06	1.88E-07
0.48522	-0.0505607	0.0777773	4.76E-07	3.69E-07	7.30E-07
0.482441	-0.050472	0.0760282	5.25E-07	4.05E-08	7.90E-07
0.479424	-0.0569439	0.0743309	1.06E-06	7.13E-07	8.82E-07
0.472994	-0.055371	0.0731425	1.30E-06	1.22E-06	1.30E-06
0.468633	-0.0545231	0.0718995	1.24E-06	1.26E-06	1.46E-06
0.479719	-0.0499443	0.0751374	3.63E-07	7.02E-07	7.92E-07
0.468335	-0.0506951	0.0719452	6.44E-07	8.21E-07	9.18E-07
0.473857	-0.0486443	0.073574	8.71E-07	1.80E-06	6.52E-07
0.468076	-0.0487722	0.0723595	8.99E-07	1.21E-06	1.10E-06
0.46808	-0.0473938	0.0719785	8.18E-07	1.67E-06	7.75E-07
0.467166	-0.054953	0.0700935	1.10E-06	1.18E-06	1.71E-06
0.461021	-0.0539648	0.0679663	7.51E-07	9.40E-07	2.12E-06
0.454717	-0.0526385	0.066346	2.15E-07	6.29E-07	1.04E-06
0.454738	-0.0527441	0.0661747	3.53E-07	2.77E-07	1.81E-06
0.454259	-0.050367	0.0673347	2.19E-07	3.89E-07	1.89E-06
0.468033	-0.0474374	0.0718678	6.60E-07	9.13E-07	1.37E-06
0.454372	-0.0491665	0.0666108	6.68E-07	1.62E-07	1.56E-06
0.462378	-0.0465669	0.069602	7.45E-07	1.01E-06	1.60E-06
0.456649	-0.0455959	0.0675255	4.06E-07	2.05E-06	1.42E-06
0.454146	-0.0452147	0.0664953	5.65E-07	2.16E-06	1.30E-06
0.44856	-0.0516769	0.0641813	3.39E-07	2.01E-07	1.71E-06
0.442275	-0.0504158	0.0624352	6.70E-07	3.83E-07	1.36E-06
0.440284	-0.0498976	0.0621158	7.52E-07	1.02E-06	1.52E-06
0.450813	-0.0443935	0.0657909	3.60E-07	1.79E-06	1.30E-06
0.444986	-0.0432317	0.0639939	4.38E-07	1.45E-06	1.74E-06
0.439927	-0.0425933	0.0616916	3.77E-07	1.31E-06	1.96E-06
0.436241	-0.0497236	0.0598178	6.47E-07	9.35E-07	2.14E-06
0.42991	-0.0483844	0.0582029	9.09E-07	5.92E-07	2.20E-06
0.425881	-0.0472414	0.057774	1.11E-06	9.75E-07	2.41E-06
0.439183	-0.0420957	0.0621302	4.66E-07	9.46E-07	2.63E-06
0.433604	-0.0414746	0.0594704	4.14E-07	1.54E-06	2.45E-06
0.427881	-0.0405716	0.0572316	1.19E-07	2.68E-06	2.39E-06
0.425618	-0.0398365	0.0570899	3.93E-07	2.05E-06	2.68E-06
0.423822	-0.0476129	0.0557137	1.21E-06	1.99E-06	2.75E-06
0.41792	-0.0472769	0.052494	8.14E-07	2.90E-06	3.91E-06
0.411953	-0.0457079	0.0515497	1.22E-06	2.34E-06	4.77E-06
0.422009	-0.0393492	0.0555107	6.18E-07	1.13E-06	2.98E-06
0.416143	-0.0381668	0.0537272	3.08E-07	1.34E-06	3.29E-06
0.411154	-0.0367774	0.0529335	6.22E-07	1.77E-06	3.74E-06
0.41128	-0.0453194	0.0518482	1.12E-06	1.61E-06	4.30E-06
0.404828	-0.043774	0.0505791	7.01E-07	2.46E-06	3.63E-06
0.406043	-0.0441918	0.050563	1.26E-06	1.68E-06	3.61E-06
0.398766	-0.0431772	0.0477465	3.22E-07	3.35E-06	3.74E-06
0.397548	-0.0432253	0.0468526	8.95E-07	4.29E-06	3.99E-06
0.410421	-0.0373161	0.0513749	1.12E-06	1.56E-06	4.15E-06
0.404322	-0.0359122	0.0499377	9.48E-07	1.50E-06	5.20E-06
0.405065	-0.035725	0.0507458	1.23E-06	9.36E-07	3.78E-06

0.397541	-0.0347097	0.0479966	7.67E-07	1.29E-06	5.74E-06
0.397067	-0.0349871	0.0472007	1.18E-06	1.37E-06	5.36E-06
0.392434	-0.0419504	0.0459353	1.13E-06	4.12E-06	4.43E-06
0.386083	-0.0407102	0.0441479	8.87E-07	3.58E-06	5.74E-06
0.38278	-0.0399399	0.0434437	5.56E-07	4.19E-06	7.70E-06
0.390789	-0.0336585	0.0458372	1.88E-06	2.27E-06	6.00E-06
0.384054	-0.0326277	0.0436165	2.21E-06	1.98E-06	8.08E-06
0.382511	-0.0323429	0.0431764	1.91E-06	2.01E-06	8.39E-06
0.379611	-0.0392013	0.0428017	5.04E-07	4.03E-06	7.72E-06
0.373385	-0.038277	0.040473	1.07E-06	3.02E-06	8.23E-06
0.368034	-0.0367884	0.0398366	2.14E-06	3.29E-06	9.22E-06
0.377132	-0.0311752	0.0420923	1.51E-06	1.47E-06	6.48E-06
0.370433	-0.0302497	0.0396699	1.48E-06	1.50E-06	5.59E-06
0.367895	-0.0296262	0.0392847	1.65E-06	2.44E-06	6.65E-06
0.366856	-0.0366388	0.039347	2.24E-06	3.16E-06	8.68E-06
0.360565	-0.035584	0.0372358	2.14E-06	2.28E-06	8.57E-06
0.354101	-0.0341084	0.0358199	2.31E-06	1.12E-06	7.39E-06
0.353502	-0.0341971	0.0352626	2.40E-06	2.21E-06	8.47E-06
0.363453	-0.0286643	0.0383741	1.62E-06	3.64E-06	9.22E-06
0.356577	-0.0273528	0.0365954	2.00E-06	3.86E-06	1.05E-05
0.353226	-0.0268735	0.0354317	2.26E-06	3.68E-06	9.59E-06
0.34786	-0.0332275	0.0334225	2.09E-06	3.38E-06	9.15E-06
0.341468	-0.0319632	0.0316295	2.21E-06	3.38E-06	9.45E-06
0.339042	-0.0319199	0.0301372	2.40E-06	2.73E-06	8.51E-06
0.349829	-0.0263775	0.0342581	2.31E-06	3.21E-06	8.25E-06
0.342948	-0.0250832	0.0324543	2.44E-06	2.88E-06	8.23E-06
0.338552	-0.0241329	0.0315397	2.48E-06	2.94E-06	8.56E-06
0.335097	-0.0307499	0.0297894	2.50E-06	2.58E-06	8.69E-06
0.328556	-0.0291018	0.0286381	2.41E-06	2.36E-06	1.07E-05
0.323938	-0.0278843	0.0279264	2.50E-06	2.56E-06	1.14E-05
0.336101	-0.0239232	0.0304252	2.12E-06	2.95E-06	1.00E-05
0.32918	-0.0225454	0.0287661	2.03E-06	2.28E-06	1.21E-05
0.324052	-0.0219679	0.0266822	2.15E-06	3.05E-06	1.19E-05
0.322058	-0.0275423	0.0273487	2.04E-06	2.96E-06	1.05E-05
0.315611	-0.0261704	0.025746	2.23E-06	3.70E-06	1.05E-05
0.309533	-0.0253239	0.0233831	2.90E-06	3.83E-06	1.09E-05
0.309337	-0.0253504	0.0232443	3.02E-06	3.57E-06	1.03E-05
0.322292	-0.0212373	0.0269612	2.44E-06	4.92E-06	9.94E-06
0.314975	-0.0200716	0.0248471	2.07E-06	3.15E-06	9.44E-06
0.317715	-0.0203189	0.0258749	2.18E-06	4.52E-06	8.64E-06
0.309066	-0.0187443	0.0241227	2.05E-06	3.42E-06	1.08E-05
0.30923	-0.0252375	0.0233928	3.03E-06	3.29E-06	1.04E-05
0.300248	-0.0232772	0.0223515	3.21E-06	3.49E-06	1.12E-05
0.294313	-0.0224999	0.0207244	3.23E-06	3.32E-06	1.12E-05
0.306654	-0.0185377	0.0232006	2.16E-06	4.15E-06	1.14E-05
0.298349	-0.0170302	0.0215141	2.34E-06	3.20E-06	1.10E-05
0.294211	-0.0161743	0.0208703	2.48E-06	3.06E-06	1.07E-05
0.291494	-0.0221573	0.0199165	2.80E-06	3.16E-06	1.00E-05
0.282814	-0.0212954	0.0170098	2.25E-06	2.93E-06	8.92E-06
0.279598	-0.0207744	0.0162956	2.03E-06	1.90E-06	8.81E-06
0.290055	-0.0156487	0.0196114	3.07E-06	3.40E-06	1.13E-05
0.281787	-0.0142788	0.0176623	3.76E-06	4.07E-06	1.27E-05

0.279386	-0.0137623	0.0173209	3.81E-06	4.44E-06	1.27E-05
0.27375	-0.0191064	0.0163731	2.25E-06	2.36E-06	8.80E-06
0.265022	-0.0181383	0.0136478	2.67E-06	3.73E-06	9.61E-06
0.264466	-0.0176219	0.0143138	2.92E-06	3.32E-06	1.08E-05
0.273471	-0.0128351	0.0158386	3.14E-06	3.37E-06	1.05E-05
0.265177	-0.0114303	0.0139838	2.44E-06	1.43E-06	7.23E-06
0.264526	-0.0113214	0.0138233	2.58E-06	1.41E-06	7.57E-06
0.256042	-0.0162319	0.012506	2.57E-06	3.01E-06	1.11E-05
0.249585	-0.0154248	0.010667	1.95E-06	3.51E-06	1.07E-05
0.256837	-0.00993788	0.0122475	3.28E-06	3.27E-06	1.08E-05
0.249538	-0.00840672	0.0111555	3.34E-06	3.57E-06	1.16E-05
0.247134	-0.0146606	0.0108208	1.94E-06	3.93E-06	1.08E-05
0.238305	-0.0133594	0.00867188	2.54E-06	4.05E-06	1.06E-05
0.234501	-0.0124045	0.00845227	3.48E-06	2.77E-06	9.34E-06
0.248533	-0.0085198	0.010386	2.71E-06	2.97E-06	9.53E-06
0.240108	-0.00663395	0.00934374	2.46E-06	2.51E-06	9.25E-06
0.234494	-0.00537819	0.00895318	2.48E-06	3.08E-06	8.06E-06
0.239434	-0.00660367	0.00900729	2.30E-06	2.10E-06	7.90E-06
0.229238	-0.0110759	0.00820008	3.71E-06	2.40E-06	8.87E-06
0.219467	-0.00997916	0.00584745	2.77E-06	4.47E-06	1.08E-05
0.229908	-0.00468051	0.008105	2.44E-06	3.86E-06	7.95E-06
0.219619	-0.00311785	0.00612422	2.32E-06	3.68E-06	7.91E-06
0.219567	-0.00329891	0.00575896	2.35E-06	3.52E-06	8.39E-06
0.218035	-0.00989231	0.00540507	2.71E-06	4.14E-06	1.02E-05
0.206421	-0.00741449	0.00482543	2.59E-06	3.14E-06	8.95E-06
0.204372	-0.00760551	0.00357022	2.48E-06	2.66E-06	7.59E-06
0.209328	-0.00148305	0.00430685	2.46E-06	3.01E-06	7.78E-06
0.20441	-6.43E-05	0.00461343	2.31E-06	2.62E-06	7.31E-06
0.194937	-0.00549833	0.00330199	2.54E-06	1.82E-06	7.09E-06
0.190106	-0.00474637	0.00254851	2.35E-06	1.17E-06	6.98E-06
0.189234	-0.00482477	0.00205405	2.03E-06	1.97E-06	7.52E-06
0.198952	0.000593306	0.00324247	1.99E-06	2.57E-06	7.31E-06
0.189459	0.00202589	0.0014412	2.01E-06	2.40E-06	7.12E-06
0.182209	-0.00347789	0.00172394	1.71E-06	2.15E-06	7.16E-06
0.174043	-0.00204183	0.00106515	1.57E-06	2.01E-06	5.81E-06
0.188544	0.00283761	0.00251477	2.18E-06	1.63E-06	6.83E-06
0.178235	0.00464398	0.000980179	4.05E-06	3.26E-06	4.37E-06
0.174344	0.00495388	0.000157	3.91E-06	2.36E-06	4.25E-06
0.176751	0.00492706	0.000818917	6.94E-06	5.48E-06	3.30E-06
0.168602	-0.00145957	-1.40E-05	1.74E-06	2.19E-06	5.25E-06
0.158942	0.000459184	-0.000376321	1.75E-06	2.21E-06	4.76E-06
0.159203	0.00681699	-0.000923898	2.03E-06	7.59E-07	4.77E-06
0.154955	0.00110895	-0.000763138	1.31E-06	1.85E-06	4.46E-06
0.148834	0.00217507	-0.00126347	9.69E-07	1.42E-06	4.17E-06
0.143825	0.00279489	-0.00165527	1.14E-06	8.34E-07	4.00E-06
0.155044	0.00770597	-0.000535703	1.24E-06	2.29E-06	3.67E-06
0.14409	0.00856271	-0.0022121	1.21E-06	2.09E-06	3.28E-06
0.13507	0.00399274	-0.0020684	1.39E-06	1.85E-07	3.95E-06
0.128671	0.00492468	-0.00229252	1.95E-06	5.30E-07	3.48E-06
0.129742	0.0109836	-0.00205762	1.94E-06	1.28E-06	3.12E-06
0.113547	0.00688752	-0.00322423	2.09E-06	9.27E-07	2.87E-06
0.113828	0.0132126	-0.0027075	2.55E-06	2.40E-06	2.32E-06

0.110079	0.00766777	-0.00283745	1.86E-06	5.29E-07	3.03E-06
0.0984324	0.00940913	-0.00313831	1.38E-06	7.45E-07	2.95E-06
0.104485	0.0145827	-0.00301336	2.21E-06	2.50E-06	2.56E-06
0.0987602	0.0153908	-0.00322614	1.86E-06	1.93E-06	2.36E-06
0.085164	0.0122065	-0.00198283	1.71E-06	7.53E-07	2.28E-06
0.0833647	0.0119069	-0.00308418	2.37E-06	4.21E-07	2.22E-06
0.0837173	0.0181562	-0.0026297	1.62E-06	8.75E-07	1.75E-06
0.0683454	0.0148617	-0.00218628	2.51E-06	4.66E-07	2.49E-06
0.0793178	0.018888	-0.00258962	1.56E-06	1.72E-06	1.11E-06
0.0686845	0.0200051	-0.00249149	1.61E-06	2.28E-06	1.20E-06
0.0687268	0.0206579	-0.00250536	1.50E-06	2.63E-06	1.00E-06
0.0650009	0.0155212	-0.00252105	2.03E-06	2.25E-07	1.83E-06
0.0649292	0.0157374	-0.00161259	2.61E-06	7.39E-07	1.78E-06
0.0653679	0.0172093	-0.00230807	1.79E-06	8.32E-07	1.75E-06
0.0657505	0.0189433	-0.00200478	1.88E-06	9.58E-07	1.30E-06
0.0661355	0.0208674	-0.00134794	1.62E-06	2.23E-06	9.79E-07
0.066321	0.0213002	-0.00204018	1.55E-06	2.81E-06	1.21E-06

Source File Name: beam3lb_neg30deg_fast_160Hz
Signal: FFT - Vib 3D Velocity - Magnitude
dB-Reference: 0 dB = 1 m/s
Band No.: 1
Frequency: 160.0 Hz

Interpolated: Yes
Filtered: Yes

X	Y	Z	Mag X	Mag Y	Mag Z
0.0685788	0.0181916	-0.00286927	0.000357398	0.000227167	0.000505639
0.0836412	0.0166094	-0.0030387	0.000384395	0.000309527	0.00095449
0.0835434	0.0153833	-0.00236822	0.00038854	0.000310836	0.000963508
0.0684804	0.0169183	-0.00228714	0.00036481	0.000231876	0.000508905
0.0834515	0.0135322	-0.00283605	0.000387426	0.000311338	0.000970347
0.0683762	0.0152471	-0.00239778	0.000361371	0.0002307	0.000509918
0.0987412	0.015019	-0.00325087	0.000382826	0.000387179	0.0014653
0.0986513	0.0134896	-0.00309802	0.000384489	0.000407092	0.00158378
0.0985669	0.011829	-0.00321379	0.00037905	0.00040858	0.00161591
0.113772	0.0123441	-0.00245987	0.000363028	0.000504388	0.0022643
0.113725	0.0101517	-0.00353766	0.000347449	0.000504948	0.00229693
0.113628	0.00886169	-0.0029425	0.000347669	0.000497884	0.00227984
0.0984872	0.00996064	-0.0036702	0.000379474	0.000406887	0.00160668
0.128946	0.0107918	-0.00255624	0.000318587	0.000575848	0.00274794
0.128895	0.00893562	-0.00301952	0.000286899	0.000580964	0.00288535
0.128804	0.00761053	-0.00251883	0.000279658	0.000587439	0.00287393
0.128737	0.00593242	-0.00262079	0.000288605	0.000602223	0.00287548
0.113563	0.00700464	-0.00340303	0.000351312	0.000523319	0.00236879
0.144039	0.00813491	-0.00174914	0.000232652	0.000648572	0.00332617
0.143973	0.0065675	-0.00168482	0.000220132	0.00065656	0.00340715
0.143925	0.00479152	-0.00196024	0.000220071	0.000662473	0.00341164
0.159115	0.00584412	-0.00027431	0.000132699	0.000709163	0.00380006
0.15909	0.00397052	-0.000722973	0.000127696	0.000706417	0.00380354

0.159065	0.00210922	-0.00117689	0.00012195	0.000708896	0.00380648
0.143831	0.00351464	-0.00136863	0.000214772	0.000659707	0.00346057
0.17434	0.00451817	5.54E-05	6.10E-05	0.000737416	0.00402997
0.174221	0.00342163	0.00100245	5.01E-05	0.000743661	0.00402138
0.174223	0.00146258	0.000375799	2.84E-05	0.000755769	0.00401904
0.17415	2.50E-05	0.000716455	2.22E-05	0.000759326	0.00400619
0.158988	0.000671656	-0.000836795	0.00011075	0.000719333	0.00384978
0.189384	0.000796108	0.0018939	5.46E-05	0.000773923	0.00404682
0.189315	-0.000641573	0.00223525	8.69E-05	0.000777389	0.00400441
0.189247	-0.00206546	0.00257048	0.000101456	0.000773759	0.00399588
0.174129	-0.00188742	0.000179925	9.62E-06	0.000753398	0.00402092
0.204487	-0.00132834	0.00372012	0.000188421	0.000786303	0.00385661
0.204511	-0.00324243	0.00318884	0.000226743	0.000782456	0.0037771
0.204314	-0.00394508	0.00483488	0.000238309	0.000781343	0.00377793
0.189278	-0.00414066	0.00178645	0.000115939	0.000776272	0.00400252
0.219595	-0.00345979	0.00550683	0.000318183	0.000775846	0.00343297
0.219514	-0.00479996	0.00602617	0.000338126	0.000773391	0.0034365
0.219523	-0.00656871	0.00576057	0.000371502	0.000769566	0.00332539
0.204418	-0.00640089	0.0033526	0.000242514	0.000781272	0.00376367
0.234612	-0.00685488	0.00795669	0.000511227	0.000749639	0.00280216
0.234512	-0.0080825	0.00864448	0.000520376	0.000744776	0.00276142
0.219422	-0.00781042	0.00645598	0.000385058	0.000761408	0.00330511
0.234552	-0.00996522	0.00821953	0.000552721	0.000739057	0.00266132
0.21944	-0.00962994	0.00610781	0.000406953	0.000760214	0.00323931
0.249582	-0.0100113	0.0108042	0.000702885	0.000711108	0.00201884
0.249588	-0.0116973	0.0107278	0.000749335	0.000700733	0.00184709
0.234527	-0.0115388	0.00830661	0.000596725	0.000735096	0.00258229
0.264531	-0.0114674	0.0137918	0.000896913	0.000662129	0.00107458
0.264573	-0.0132388	0.0135391	0.000925315	0.000646999	0.00106175
0.249487	-0.0129242	0.0114201	0.000774242	0.000685102	0.00180182
0.264509	-0.0146279	0.013983	0.000978917	0.000628003	0.000881469
0.249481	-0.0145477	0.0114255	0.000803616	0.000669425	0.00171162
0.279496	-0.014617	0.0166669	0.00113602	0.000579148	5.40E-05
0.279547	-0.0163898	0.0164201	0.00114982	0.000587741	2.09E-05
0.264563	-0.0164508	0.0136485	0.000999667	0.00063191	0.000784294
0.279377	-0.0173664	0.0175446	0.00119131	0.000576386	0.000180374
0.29428	-0.0171782	0.0205313	0.00138422	0.000524284	0.00103507
0.294253	-0.018652	0.0208021	0.00141102	0.00050668	0.00110555
0.279413	-0.0191041	0.0173947	0.00123374	0.000557242	0.000300166
0.294329	-0.020476	0.0204772	0.00145929	0.000485051	0.00128992
0.309137	-0.0200603	0.0238514	0.00163758	0.000427308	0.00208206
0.309114	-0.0215342	0.0241263	0.00166978	0.000413216	0.00219302
0.29439	-0.0222649	0.0202478	0.00149736	0.000474732	0.00141026
0.309314	-0.0237106	0.0232125	0.00169079	0.000397786	0.00236229
0.324024	-0.0230531	0.0269642	0.00182058	0.000357344	0.00310812
0.323988	-0.0244771	0.0273284	0.00185084	0.000345237	0.00317656
0.309338	-0.0253367	0.0232364	0.00171018	0.000399854	0.00251474
0.323988	-0.0260525	0.0274371	0.00193153	0.000333951	0.00335277
0.338576	-0.025153	0.0315602	0.00204856	0.000271161	0.00395061
0.338848	-0.0274327	0.0304915	0.00205694	0.000276857	0.0040255
0.323901	-0.0273255	0.0280585	0.0019484	0.000316508	0.00343695
0.338869	-0.0290085	0.0306081	0.0020829	0.000271341	0.00416779

0.353269	-0.0277292	0.0353602	0.00218131	0.000199674	0.00462714
0.353315	-0.0293542	0.035395	0.00219605	0.000190306	0.00467121
0.338926	-0.0306858	0.0305577	0.0021027	0.00025613	0.00425876
0.353324	-0.0308785	0.0356	0.00222754	0.00018471	0.0047828
0.367997	-0.030419	0.0389526	0.00229081	0.000152842	0.00513217
0.36803	-0.0319939	0.0390767	0.00231052	0.000150583	0.00515962
0.353578	-0.0330485	0.0347055	0.00225213	0.000178209	0.00485113
0.367989	-0.0334039	0.0394428	0.00232641	0.000134456	0.00522039
0.382403	-0.032414	0.0436711	0.00234743	0.000108169	0.00541135
0.38261	-0.0343949	0.0431313	0.00234696	9.63E-05	0.00543215
0.368101	-0.0351828	0.0392353	0.00233411	0.000120938	0.0052713
0.382483	-0.0355496	0.0439221	0.00235085	8.48E-05	0.00544123
0.368034	-0.0365045	0.0397835	0.00235145	0.000111784	0.00531384
0.397014	-0.0349949	0.0474316	0.00232138	7.34E-05	0.00543879
0.396995	-0.0364033	0.0478072	0.00231237	7.09E-05	0.00544769
0.382521	-0.0371249	0.0440544	0.00235636	8.16E-05	0.00549155
0.396866	-0.0375566	0.0486	0.00231	6.85E-05	0.00546341
0.382707	-0.0390443	0.0435965	0.00236595	7.40E-05	0.00553179
0.397041	-0.0394381	0.0482382	0.0022929	7.65E-05	0.00547277
0.41118	-0.0380168	0.0531004	0.00220283	8.01E-05	0.00528216
0.411354	-0.039885	0.0527315	0.00220474	6.81E-05	0.00529937
0.397217	-0.0413074	0.0478705	0.00230474	6.24E-05	0.00550445
0.411519	-0.0417026	0.0524514	0.00218028	6.57E-05	0.00527487
0.425603	-0.0403112	0.0572587	0.00203564	6.49E-05	0.00492669
0.425779	-0.0421283	0.0569832	0.00203492	6.05E-05	0.00491333
0.411569	-0.0432786	0.0525954	0.00216511	5.30E-05	0.00526178
0.42586	-0.0437414	0.0570397	0.00201466	6.01E-05	0.00488158
0.411825	-0.0453038	0.0519888	0.00216077	5.34E-05	0.00525162
0.425797	-0.0450465	0.0575924	0.00198636	6.49E-05	0.00482813
0.440026	-0.0440827	0.0616782	0.00178589	7.97E-05	0.00436776
0.440039	-0.0455414	0.0619862	0.00175828	7.48E-05	0.00434938
0.425877	-0.0466603	0.0576523	0.00195186	5.81E-05	0.004804
0.440051	-0.0470002	0.0622958	0.00169922	8.30E-05	0.00426331
0.454122	-0.0457983	0.0667326	0.00149588	0.000101745	0.003666
0.454319	-0.0476171	0.0664725	0.00146978	0.00010773	0.00365291
0.440113	-0.0485623	0.062443	0.00166509	8.95E-05	0.00421797
0.468569	-0.052554	0.0716063	0.0010927	0.000118772	0.00274017
0.482353	-0.0510472	0.0764888	0.000868551	0.000131793	0.00210212
0.48257	-0.052854	0.0762362	0.000833461	0.000126035	0.00203772
0.468589	-0.0539994	0.0719196	0.00105264	0.000113063	0.00269689
0.485218	-0.0573213	0.0774144	0.000676517	0.000114208	0.00176372
0.490938	-0.0564463	0.0798234	0.000620607	0.000114208	0.00159896
0.491332	-0.0585409	0.0790802	0.000620253	0.000112255	0.00161783
0.490913	-0.0550015	0.0795037	0.000664505	0.000122803	0.00161963
0.482933	-0.057194	0.0761784	0.000787801	0.000122448	0.00201825
0.482838	-0.0561596	0.0762228	0.000775281	0.000125735	0.00195581
0.491028	-0.0538162	0.0787819	0.000704424	0.000130239	0.00160206
0.482704	-0.0545064	0.0762286	0.00080903	0.000124899	0.00200734
0.490946	-0.0522678	0.0786266	0.000723841	0.000132852	0.0016182
0.48522	-0.0505607	0.0777773	0.000817562	0.0001404	0.00195419
0.482441	-0.050472	0.0760282	0.000861411	0.00013396	0.00205085
0.479424	-0.0569439	0.0743309	0.000861721	0.000125739	0.0021927

0.472994	-0.055371	0.0731425	0.000943797	0.000121985	0.00242777
0.468633	-0.0545231	0.0718995	0.00107791	0.000112736	0.00279232
0.479719	-0.0499443	0.0751374	0.00100799	0.00011619	0.00247705
0.468335	-0.0506951	0.0719452	0.0011463	9.96E-05	0.00286816
0.473857	-0.0486443	0.073574	0.00108177	0.000110242	0.00270359
0.468076	-0.0487722	0.0723595	0.00116068	0.000100145	0.00292024
0.46808	-0.0473938	0.0719785	0.00114297	0.000111384	0.00283717
0.467166	-0.054953	0.0700935	0.00116306	0.000112258	0.0029446
0.461021	-0.0539648	0.0679663	0.00126667	0.000102408	0.00315357
0.454717	-0.0526385	0.066346	0.00134057	7.97E-05	0.0033494
0.454738	-0.0527441	0.0661747	0.00143641	6.08E-05	0.00363688
0.454259	-0.050367	0.0673347	0.00138046	7.48E-05	0.00350188
0.468033	-0.0474374	0.0718678	0.00130101	0.000109928	0.00318184
0.454372	-0.0491665	0.0666108	0.00143762	9.70E-05	0.00360165
0.462378	-0.0465669	0.069602	0.00139278	0.000109968	0.00338737
0.456649	-0.0455959	0.0675255	0.00144593	0.000110106	0.00350072
0.454146	-0.0452147	0.0664953	0.00149571	0.000103561	0.003627
0.44856	-0.0516769	0.0641813	0.00149357	7.54E-05	0.00382999
0.442275	-0.0504158	0.0624352	0.00158021	9.48E-05	0.00404372
0.440284	-0.0498976	0.0621158	0.00170374	8.77E-05	0.00433098
0.450813	-0.0443935	0.0657909	0.00163947	8.86E-05	0.0040204
0.444986	-0.0432317	0.0639939	0.00172522	8.47E-05	0.00419884
0.439927	-0.0425933	0.0616916	0.00177505	8.02E-05	0.00430525
0.436241	-0.0497236	0.0598178	0.00178476	7.70E-05	0.00447908
0.42991	-0.0483844	0.0582029	0.00186337	5.91E-05	0.00465287
0.425881	-0.0472414	0.057774	0.00197045	5.05E-05	0.00488144
0.439183	-0.0420957	0.0621302	0.00190514	6.60E-05	0.00458233
0.433604	-0.0414746	0.0594704	0.00197535	6.36E-05	0.00474687
0.427881	-0.0405716	0.0572316	0.00200418	6.45E-05	0.00482939
0.425618	-0.0398365	0.0570899	0.00203731	6.61E-05	0.00490976
0.423822	-0.0476129	0.0557137	0.00203476	6.11E-05	0.00497789
0.41792	-0.0472769	0.052494	0.00210216	6.85E-05	0.00511917
0.411953	-0.0457079	0.0515497	0.00218034	5.95E-05	0.00531579
0.422009	-0.0393492	0.0555107	0.0021373	7.12E-05	0.00512987
0.416143	-0.0381668	0.0537272	0.00217337	8.34E-05	0.00520614
0.411154	-0.0367774	0.0529335	0.00220114	8.31E-05	0.00524177
0.41128	-0.0453194	0.0518482	0.00219903	5.87E-05	0.00536677
0.404828	-0.043774	0.0505791	0.00224204	6.21E-05	0.00545197
0.406043	-0.0441918	0.050563	0.00222433	6.33E-05	0.00542951
0.398766	-0.0431772	0.0477465	0.00227508	7.31E-05	0.00550043
0.397548	-0.0432253	0.0468526	0.00233107	6.77E-05	0.00556866
0.410421	-0.0373161	0.0513749	0.00226747	6.80E-05	0.00532782
0.404322	-0.0359122	0.0499377	0.00229526	6.61E-05	0.0053947
0.405065	-0.035725	0.0507458	0.00228619	5.90E-05	0.0053353
0.397541	-0.0347097	0.0479966	0.00231318	7.41E-05	0.00542218
0.397067	-0.0349871	0.0472007	0.00232626	7.97E-05	0.00544195
0.392434	-0.0419504	0.0459353	0.00233838	6.98E-05	0.00556809
0.386083	-0.0407102	0.0441479	0.00234467	8.41E-05	0.00556113
0.38278	-0.0399399	0.0434437	0.00237618	8.24E-05	0.00555498
0.390789	-0.0336585	0.0458372	0.00234139	9.17E-05	0.00545697
0.384054	-0.0326277	0.0436165	0.00234633	0.000101517	0.00544526
0.382511	-0.0323429	0.0431764	0.00234298	0.000111283	0.00539997

0.379611	-0.0392013	0.0428017	0.0023799	8.56E-05	0.00550824
0.373385	-0.038277	0.040473	0.00236923	0.000104341	0.0054313
0.368034	-0.0367884	0.0398366	0.00235681	0.000120298	0.00531385
0.377132	-0.0311752	0.0420923	0.00232302	0.00013489	0.00527033
0.370433	-0.0302497	0.0396699	0.00230213	0.00014365	0.00519825
0.367895	-0.0296262	0.0392847	0.00228341	0.000149444	0.00511195
0.366856	-0.0366388	0.039347	0.00234216	0.000123377	0.00523726
0.360565	-0.035584	0.0372358	0.0023103	0.000134352	0.00511818
0.354101	-0.0341084	0.0358199	0.00228671	0.000150076	0.00498122
0.353502	-0.0341971	0.0352626	0.00224772	0.000174118	0.00479242
0.363453	-0.0286643	0.0383741	0.00223974	0.000157364	0.0048586
0.356577	-0.0273528	0.0365954	0.00221003	0.000175276	0.00473659
0.353226	-0.0268735	0.0354317	0.00218242	0.000200069	0.0046246
0.34786	-0.0332275	0.0334225	0.00221076	0.000201256	0.00465371
0.341468	-0.0319632	0.0316295	0.00215835	0.0002318	0.00446991
0.339042	-0.0319199	0.0301372	0.00209262	0.000266309	0.00420122
0.349829	-0.0263775	0.0342581	0.00211662	0.000243492	0.00430111
0.342948	-0.0250832	0.0324543	0.00208471	0.000247736	0.00411004
0.338552	-0.0241329	0.0315397	0.00204669	0.000261658	0.00395144
0.335097	-0.0307499	0.0297894	0.00206521	0.000274241	0.00403377
0.328556	-0.0291018	0.0286381	0.00201851	0.000290448	0.00376169
0.323938	-0.0278843	0.0279264	0.00194217	0.000312169	0.00336058
0.336101	-0.0239232	0.0304252	0.00194694	0.000305925	0.0035405
0.32918	-0.0225454	0.0287661	0.00187896	0.000337263	0.00332892
0.324052	-0.0219679	0.0266822	0.00184615	0.000363361	0.00318705
0.322058	-0.0275423	0.0273487	0.00191444	0.000334843	0.00318777
0.315611	-0.0261704	0.025746	0.00183344	0.000400567	0.00293719
0.309533	-0.0253239	0.0233831	0.00168004	0.000468633	0.00254396
0.309337	-0.0253504	0.0232443	0.00165755	0.000435864	0.00239714
0.322292	-0.0212373	0.0269612	0.0018082	0.000374563	0.00282209
0.314975	-0.0200716	0.0248471	0.00171014	0.000401092	0.00237513
0.317715	-0.0203189	0.0258749	0.00180082	0.000366692	0.00271637
0.309066	-0.0187443	0.0241227	0.00162634	0.000428414	0.00208987
0.30923	-0.0252375	0.0233928	0.00166308	0.000415608	0.00224693
0.300248	-0.0232772	0.0223515	0.00160785	0.000430981	0.00188111
0.294313	-0.0224999	0.0207244	0.00148847	0.000475796	0.00134023
0.306654	-0.0185377	0.0232006	0.00150327	0.000468528	0.00153034
0.298349	-0.0170302	0.0215141	0.00143453	0.000498257	0.00126033
0.294211	-0.0161743	0.0208703	0.00137656	0.000523512	0.00101124
0.291494	-0.0221573	0.0199165	0.00141369	0.000503275	0.00104972
0.282814	-0.0212954	0.0170098	0.00131826	0.000526182	0.000705387
0.279598	-0.0207744	0.0162956	0.00119918	0.000559991	0.000177955
0.290055	-0.0156487	0.0196114	0.00123983	0.000552074	0.000399423
0.281787	-0.0142788	0.0176623	0.00117797	0.000555268	0.00014257
0.279386	-0.0137623	0.0173209	0.00112565	0.000578176	0.000100142
0.27375	-0.0191064	0.0163731	0.00115812	0.000582693	0.000159762
0.265022	-0.0181383	0.0136478	0.00108501	0.00060818	0.000499829
0.264466	-0.0176219	0.0143138	0.000976483	0.000637034	0.000954992
0.273471	-0.0128351	0.0158386	0.0010022	0.000621653	0.000705713
0.265177	-0.0114303	0.0139838	0.000920743	0.000650787	0.000918249
0.264526	-0.0113214	0.0138233	0.000865107	0.000670512	0.00111886
0.256042	-0.0162319	0.012506	0.000906263	0.000655088	0.00127043

0.249585	-0.0154248	0.010667	0.000800091	0.00067119	0.00177859
0.256837	-0.00993788	0.0122475	0.000754095	0.000697675	0.00170068
0.249538	-0.00840672	0.0111555	0.000690549	0.000712905	0.00200425
0.247134	-0.0146606	0.0108208	0.000746244	0.000682278	0.00202035
0.238305	-0.0133594	0.00867188	0.000665242	0.00070993	0.00229101
0.234501	-0.0124045	0.00845227	0.000572907	0.000736826	0.00268524
0.248533	-0.0085198	0.010386	0.000598387	0.000733082	0.00238969
0.240108	-0.00663395	0.00934374	0.000562687	0.000739704	0.00252433
0.234494	-0.00537819	0.00895318	0.000500481	0.000749356	0.00284571
0.239434	-0.00660367	0.00900729	0.000557137	0.000733595	0.0025698
0.229238	-0.0110759	0.00820008	0.000555719	0.000741438	0.0027984
0.219467	-0.00997916	0.00584745	0.000380734	0.000760337	0.00335304
0.229908	-0.00468051	0.008105	0.000386462	0.000767361	0.00325354
0.219619	-0.00311785	0.00612422	0.000331289	0.000773265	0.00336015
0.219567	-0.00329891	0.00575896	0.000299452	0.000780291	0.0034519
0.218035	-0.00989231	0.00540507	0.000354382	0.000762162	0.00343242
0.206421	-0.00741449	0.00482543	0.000300081	0.00076758	0.00359778
0.204372	-0.00760551	0.00357022	0.000222523	0.000776736	0.00382568
0.209328	-0.00148305	0.00430685	0.00022401	0.000789141	0.00373075
0.20441	-6.43E-05	0.00461343	0.000171322	0.000786519	0.00386797
0.194937	-0.00549833	0.00330199	0.000180191	0.000784722	0.00392179
0.190106	-0.00474637	0.00254851	0.000126074	0.000785363	0.00402223
0.189234	-0.00482477	0.00205405	9.39E-05	0.000776478	0.0040363
0.198952	0.000593306	0.00324247	9.13E-05	0.000778266	0.00400107
0.189459	0.00202589	0.0014412	4.61E-05	0.000773488	0.00404685
0.182209	-0.00347789	0.00172394	5.69E-05	0.000768087	0.00403324
0.174043	-0.00204183	0.00106515	1.41E-05	0.000747943	0.00401578
0.188544	0.00283761	0.00251477	1.27E-05	0.000761468	0.00406134
0.178235	0.00464398	0.000980179	3.19E-05	0.000762803	0.00411714
0.174344	0.00495388	0.000157	7.05E-05	0.000740113	0.00405336
0.176751	0.00492706	0.000818917	3.98E-05	0.000773028	0.00417054
0.168602	-0.00145957	-1.40E-05	5.71E-05	0.000730765	0.00396537
0.158942	0.000459184	-0.000376321	0.000116774	0.000711579	0.00383821
0.159203	0.00681699	-0.000923898	0.000137815	0.000706359	0.00378654
0.154955	0.00110895	-0.000763138	0.000151921	0.000697506	0.00374375
0.148834	0.00217507	-0.00126347	0.000196187	0.00067176	0.00359085
0.143825	0.00279489	-0.00165527	0.000226517	0.000653513	0.00341528
0.155044	0.00770597	-0.000535703	0.000203278	0.000671246	0.00349406
0.14409	0.00856271	-0.0022121	0.000243151	0.0006472	0.00330855
0.13507	0.00399274	-0.0020684	0.000253102	0.00064162	0.00321953
0.128671	0.00492468	-0.00229252	0.000304994	0.000606016	0.00281994
0.129742	0.0109836	-0.00205762	0.000296558	0.000613273	0.00301723
0.113547	0.00688752	-0.00322423	0.00036056	0.00052824	0.00239201
0.113828	0.0132126	-0.0027075	0.000378635	0.000479914	0.00207883
0.110079	0.00766777	-0.00283745	0.000376109	0.000483031	0.00212819
0.0984324	0.00940913	-0.00313831	0.000385361	0.000406566	0.00160905
0.104485	0.0145827	-0.00301336	0.000382478	0.000422624	0.00170782
0.0987602	0.0153908	-0.00322614	0.000387774	0.00038297	0.0014434
0.085164	0.0122065	-0.00198283	0.000390303	0.000347514	0.00123634
0.0833647	0.0119069	-0.00308418	0.000387617	0.000290102	0.000862826
0.0837173	0.0181562	-0.0026297	0.000385958	0.000308213	0.000954907
0.0683454	0.0148617	-0.00218628	0.000366688	0.000230233	0.000522755

0.0793178	0.018888	-0.00258962	0.000361476	0.000233931	0.000524241
0.0686845	0.0200051	-0.00249149	0.000356475	0.000217195	0.000424983
0.0687268	0.0206579	-0.00250536	0.00038643	0.000257829	0.000393989
0.0650009	0.0155212	-0.00252105	0.000355809	0.000204998	0.000381724
0.0649292	0.0157374	-0.00161259	0.000359309	0.000200617	0.000382571
0.0653679	0.0172093	-0.00230807	0.000359527	0.000207581	0.000388978
0.0657505	0.0189433	-0.00200478	0.000370656	0.000210742	0.000402542
0.0661355	0.0208674	-0.00134794	0.000411565	0.000261307	0.000386803
0.066321	0.0213002	-0.00204018	0.000454878	0.000326735	0.000350275

Appendix B: MathCad File for Linear Theory [8]

Cantilever Beam with a Tip Weight

Characteristic Equation for Bending

$$D_2(\zeta, \alpha l) := \frac{\alpha l^3 \cdot \zeta \cdot (\cos(\alpha l) - \cosh(\alpha l)) + (\sin(\alpha l) + \sinh(\alpha l))}{\alpha l^3 \cdot \zeta \cdot (\sin(\alpha l) + \sinh(\alpha l)) - (\cos(\alpha l) + \cosh(\alpha l))}$$

$$CEqnB(\lambda, \zeta, \alpha l) := \alpha l \cdot \lambda \cdot (\sin(\alpha l) - \sinh(\alpha l)) - (\cos(\alpha l) + \cosh(\alpha l)) \dots \\ + D_2(\zeta, \alpha l) \cdot [\alpha l \cdot \lambda \cdot (\cos(\alpha l) - \cosh(\alpha l)) + (\sin(\alpha l) - \sinh(\alpha l))]$$

Characteristic Equation for Torsion

$$CEqnT(\zeta, \alpha l) := \alpha l \cdot \zeta \cdot \sin(\alpha l) - \cos(\alpha l)$$

Beam Properties (Given)

$$b := 0.125 \cdot \text{in}$$

$$h := 0.5 \cdot \text{in}$$

$$l_w := 20 \cdot \text{in}$$

$$\rho_{Al} := 175 \cdot \frac{\text{lb}}{\text{ft}^3}$$

$$E_{Al} := 10.4 \cdot 10^6 \cdot \frac{\text{lb}f}{\text{in}^2}$$

$$G_{Al} := 3.9 \cdot 10^6 \cdot \frac{\text{lb}f}{\text{in}^2}$$

Tip Weight Properties (Given)

$$TipWt_{lb.in} :=$$

	1	2	3
1	0.0000	0.0000	0.0000
2	0.8170	0.4280	0.2980
3	1.0040	0.5280	0.3790
4	2.9810	1.5820	3.8520
5	2.0090	3.1200	1.6590
6	3.0150	4.6950	2.6580
7	4.0190	8.1420	4.6360
8	4.5200	9.1600	5.3590

$$m_w := TipWt_{lb.in} \langle 1 \rangle \cdot \text{lb}$$

$$I_{w.xx} := TipWt_{lb.in} \langle 2 \rangle \cdot \text{lb} \cdot \text{in}^2$$

$$I_{w.zz} := TipWt_{lb.in} \langle 3 \rangle \cdot \text{lb} \cdot \text{in}^2$$

$$nRow := 6$$

$$m_{tip} := m_w_{nRow}$$

$$I_{xx} := I_{w.xx}_{nRow}$$

$$I_{zz} := I_{w.zz}_{nRow}$$

Beam Properties (Calculated)

$$m := \rho_{Al} \cdot b \cdot h \qquad m = 6.33 \times 10^{-3} \frac{lb}{in}$$

$$EI_w := E_{Al} \cdot \left(\frac{b^3 \cdot h}{12} \right) \qquad EI_w = 846.354 \text{ lbf} \cdot \text{in}^2$$

$$EI_v := E_{Al} \cdot \left(\frac{b \cdot h^3}{12} \right) \qquad EI_v = 1.354 \times 10^4 \text{ lbf} \cdot \text{in}^2$$

$$I_p := \left[\frac{b \cdot h \cdot (b^2 + h^2)}{12} \right] \qquad I_p = 1.383 \times 10^{-3} \text{ in}^4$$

$$GJ := G_{Al} \cdot I_p \qquad GJ = 5.396 \times 10^3 \text{ lbf} \cdot \text{in}^2$$

Tip Weight Properties (Calculated)

$$\lambda_b := \frac{m_{tip}}{m \cdot l} \qquad \lambda_b = 23.817$$

$$\zeta_b := \frac{I_{zz}}{m \cdot l^3} \qquad \zeta_b = 0.052$$

$$\zeta_t := \frac{I_{xx}}{\rho_{Al} \cdot I_p \cdot l} \qquad \zeta_t = 1.675 \times 10^3$$

$\xi := 0, 0.1 \dots 20$

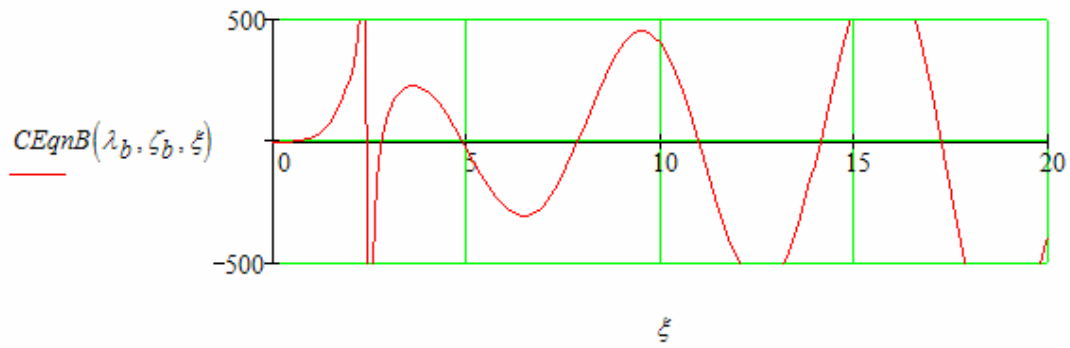

$x := 1$

Given

$$CEqnB(\lambda_b, \zeta_b, x) = 0$$

$\alpha l := \text{Find}(x)$

$\alpha l = 0.59355$

$$\omega_w := \alpha l^2 \cdot \sqrt{\frac{EI_w}{m \cdot l^4}} \quad \omega_w = 1.0072 \text{ Hza}$$

$$\omega_v := \alpha l^2 \cdot \sqrt{\frac{EI_v}{m \cdot l^4}} \quad \omega_v = 4.0287 \text{ Hza}$$

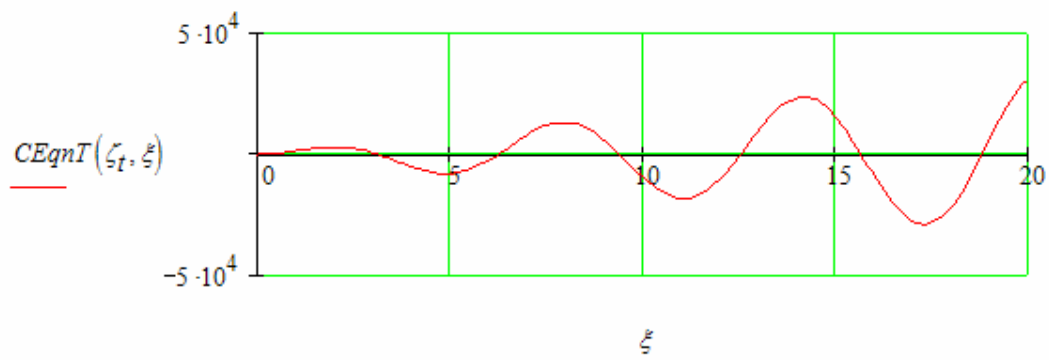

$$x' := 1$$

Given

$$CEqnT(\zeta_t, x') = 0$$

$$\beta l := \text{Find}(x')$$

$$\beta l = 0.02442$$

$$\omega_t := \beta l \cdot \sqrt{\frac{GJ}{\rho_{Al} I_p \cdot l^2}} \quad \omega_t = 23.6944 \text{ Hza}$$

Appendix C: Nastran Input Files

```

ECHO = SORT
DISPLACEMENT(PRINT) = ALL
METHOD = 1
SPC = 1
BEGIN BULK
$ *****
$   Written by : Femap with NX Nastran
$   Version   : 9.10
$   Translator : NX Nastran
$   From Model : D:\DOCUME~1\dmarquez\Desktop\FEMAPM~1\beam.mod
$   Date      : Fri Aug 25 14:05:36 2006
$ *****
$
PARAM, POST, -1
PARAM, OGEOM, NO
PARAM, AUTOSPC, YES
PARAM, MAXRATIO, 1.E+8
PARAM, GRDPNT, 0
PARAM, COUPMASS, 1
EIGRL
CORD2C
CORD2S
+FEMAPC1
+FEMAPC2
$ Femap with NX Nastran Constraint Set 1 : bc
SPC
$ Femap with NX Nastran Property 1 : Untitled
PBEAM
+PR
+PA
+PC
$ Femap with NX Nastran Material 1 : Untitled
MAT1
GRID

```

CORD2C	1	0	0.	10	0	0.	0.	0.	0.	MASS
+FEMAPC1	1.	0.	1.	0.	0.	0.	0.	0.	0.	1.+FEMAPC1
CORD2S	2	0	0.	0.	0.	0.	0.	0.	0.	1.+FEMAPC2
+FEMAPC2	1.	0.	1.	0.	0.	0.	0.	0.	0.	
SPC	1	1	123456	0.						
PBEAM	1	1	0.06250.001302	8.E-5		0.0.001383		0.0.001383	0.0.001383	0.+PR 1
+PR	1	0.	0.	0.	0.	0.	0.	0.	0.	0.+PA 1
+PA	1	YESA	1.							+PC 1
+PC	1	0.	0.							
MAT1	1	1.04E+7	3900000.	0.332.640E-4		0.		0.		
GRID	1	0	0.	0.	0.	0.		0.		
GRID	2	0	5.	0.	0.	0.		0.		
GRID	3	0	10.	0.	0.	0.		0.		
GRID	4	0	15.	0.	0.	0.		0.		
GRID	5	0	20.	0.	0.	0.		0.		
GRID	6	0	2.5	0.	0.	0.		0.		
GRID	7	0	7.5	0.	0.	0.		0.		
GRID	8	0	12.5	0.	0.	0.		0.		
GRID	9	0	17.5	0.	0.	0.		0.		
GRID	10	0	0.025	0.	0.	0.		0.		
GRID	11	0	0.05	0.	0.	0.		0.		
GRID	12	0	0.075	0.	0.	0.		0.		
GRID	13	0	0.1	0.	0.	0.		0.		
GRID	14	0	0.125	0.	0.	0.		0.		
GRID	15	0	0.15	0.	0.	0.		0.		
GRID	16	0	0.175	0.	0.	0.		0.		
GRID	17	0	0.2	0.	0.	0.		0.		
GRID	18	0	0.225	0.	0.	0.		0.		
GRID	19	0	0.25	0.	0.	0.		0.		
GRID	20	0	0.275	0.	0.	0.		0.		
GRID	21	0	0.3	0.	0.	0.		0.		
GRID	22	0	0.325	0.	0.	0.		0.		
GRID	23	0	0.35	0.	0.	0.		0.		
GRID	24	0	0.375	0.	0.	0.		0.		
GRID	25	0	0.4	0.	0.	0.		0.		
GRID	26	0	0.425	0.	0.	0.		0.		
GRID	27	0	0.45	0.	0.	0.		0.		
GRID	28	0	0.475	0.	0.	0.		0.		
GRID	29	0	0.5	0.	0.	0.		0.		
GRID	30	0	0.525	0.	0.	0.		0.		
GRID	31	0	0.55	0.	0.	0.		0.		
GRID	32	0	0.575	0.	0.	0.		0.		
GRID	33	0	0.6	0.	0.	0.		0.		
GRID	34	0	0.625	0.	0.	0.		0.		
GRID	35	0	0.65	0.	0.	0.		0.		
GRID	36	0	0.675	0.	0.	0.		0.		
GRID	37	0	0.7	0.	0.	0.		0.		
GRID	38	0	0.725	0.	0.	0.		0.		
GRID	39	0	0.75	0.	0.	0.		0.		
GRID	40	0	0.775	0.	0.	0.		0.		
GRID	41	0	0.8	0.	0.	0.		0.		
GRID	42	0	0.825	0.	0.	0.		0.		
GRID	43	0	0.85	0.	0.	0.		0.		
GRID	44	0	0.875	0.	0.	0.		0.		
GRID	45	0	0.9	0.	0.	0.		0.		
GRID	46	0	0.925	0.	0.	0.		0.		
GRID	47	0	0.95	0.	0.	0.		0.		
GRID	48	0	0.975	0.	0.	0.		0.		
GRID	49	0	1.	0.	0.	0.		0.		

Bibliography

- [1] Dowell, E. H. and Traybar, J. *An Experimental Study of the Nonlinear Stiffness of a Rotor Blade Undergoing Flap, Lag, and Twist Deformations*, AMS Report No. 1194, January 1975. Contract NAS 2-7615. U.S. Army Air Mobility Research and Development Laboratory: Ames Research Center, January 1975 (NASA CR-137968).
- [2] Dowell, E. H. and Traybar, J. *An Addendum to AMS Report No 1194 Entitled An Experimental Study of the Nonlinear Stiffness of a Rotor Blade Undergoing Flap, Lag, and Twist Deformations*, AMS Report No. 1257, December 1975. U.S. Army Air Mobility Research and Development Laboratory: Ames Research Center, December 1975 (NASA CR-137969).
- [3] Dowell, E. H., Traybar, J., and Hodges, D. H. "An Experimental-Theoretical Correlation Study of Nonlinear Bending and Torsion Deformation of a Cantilever Beam," *Journal of Sound and Vibration*, vol. 50, no. 4, Feb. 22, 1977, pp. 533 - 544.
- [4] Hodges, Dewey H., *Rotor Blades & Beam Theory: Past, Present, and Future*. The Daniel Guggenheim School of Aerospace Engineering: Boca Raton, Florida, October 2005.
- [5] Hodges, Dewey H., Hopkins, Stewart A., Kunz, Donald L., Hinnant, Howard E., *Introduction to GRASP-General Rotorcraft Aeromechanical Stability Program-A Modern Approach to Rotorcraft Modeling*. Rotorcraft Dynamics Division, April 1987.

- [6] Hodges, Dewey H., Pierce, Alvin G. *Introduction to Structural Dynamics and Aeroelasticity*. United States of America: The Press Syndicate of the University of Cambridge, 2002.
- [7] Hopkins, A. Stewart and Ormiston, Robert A. “An Examination of Selected Problems in Rotor Blade Structural mechanics and Dynamics,” *Presented at the American Helicopter Society 59th Annual Forum, Phoenix, Arizona*. May, 2003.
- [8] Kunz, Donald L. Associate Professor of Aerospace Engineering, Air Force Institute of Technology “Cantilever Beam with Tip Mass.” Electronic Message. 4 August 2006.
- [9] Laulusa, A., Bauchau, O.A., Theron, N.J. “Theoretical and experimental investigation of the nonlinear behavior of composite beams,” *La Recherche aerospaciale*, issue 4, 1995.
- [10] Matweb material property Data.
<http://www.matweb.com/search/SpecificMaterial.asp?bassnum=MA7075T6> 27 June 2006.
- [11] McGraw, Robert J. Masters Student, Air Force Institute of Technology “An Analysis of Nonlinear Elastic Deformation for a Homogeneous Beam at Varying Tip Loads and Pitch Angles.” June 2006.
- [12] MSC Software. *Handbook For Nonlinear Analysis, versions 67*. Los Angeles, CA: The MacNeal-Schwendler Corporation, 1992.
- [13] Polytec Inc., *Polytec Scanning Vibrometer*. Tustin, Ca.
- [14] Structural Dynamics Research Corp. *FEMAP User Guide Version 8.1*. Spatial Technologies Inc., 2001.

[15] Whiting, Michael S. Masters Student, Air Force Institute of Technology

“Dynamic Nonlinear Bending and Torsion of a Cantilever Beam.” March 2006.

REPORT DOCUMENTATION PAGE

*Form Approved
OMB No. 074-0188*

The public reporting burden for this collection of information is estimated to average 1 hour per response, including the time for reviewing instructions, searching existing data sources, gathering and maintaining the data needed, and completing and reviewing the collection of information. Send comments regarding this burden estimate or any other aspect of the collection of information, including suggestions for reducing this burden to Department of Defense, Washington Headquarters Services, Directorate for Information Operations and Reports (0704-0188), 1215 Jefferson Davis Highway, Suite 1204, Arlington, VA 22202-4302. Respondents should be aware that notwithstanding any other provision of law, no person shall be subject to a penalty for failing to comply with a collection of information if it does not display a currently valid OMB control number.

PLEASE DO NOT RETURN YOUR FORM TO THE ABOVE ADDRESS.

1. REPORT DATE (DD-MM-YYYY) 08-09-2006		2. REPORT TYPE Master's Thesis		3. DATES COVERED (From - To) Aug 2005 - Sep 2006	
4. TITLE AND SUBTITLE NATURAL FREQUENCES AND MODE SHAPES OF A NONLINEAR, UNIFORM CANTILEVERED BEAM				5a. CONTRACT NUMBER	
				5b. GRANT NUMBER	
				5c. PROGRAM ELEMENT NUMBER	
6. AUTHOR(S) Marquez-Chisolm, Daniel J., Lieutenant, USAF				5d. PROJECT NUMBER	
				5e. TASK NUMBER	
				5f. WORK UNIT NUMBER	
7. PERFORMING ORGANIZATION NAMES(S) AND ADDRESS(S) Air Force Institute of Technology Graduate School of Engineering and Management (AFIT/EN) 2950 Hobson Way WPAFB OH 45433-7765				8. PERFORMING ORGANIZATION REPORT NUMBER AFIT/GAE/ENY/06-S06	
9. SPONSORING/MONITORING AGENCY NAME(S) AND ADDRESS(ES) Dr. Robert A. Ormiston U.S. Army Aeroflightdynamics Directorate NASA Ames Research Center, MS 215-1 Moffett Field, CA 94035-1000 Phone: 650-604-5000				10. SPONSOR/MONITOR'S ACRONYM(S)	
				11. SPONSOR/MONITOR'S REPORT NUMBER(S)	
12. DISTRIBUTION/AVAILABILITY STATEMENT APPROVED FOR PUBLIC RELEASE; DISTRIBUTION UNLIMITED.					
13. SUPPLEMENTARY NOTES					
14. ABSTRACT A series of experiments in 1975, referred to as the Princeton Beam Experiments, were performed to measure natural frequencies and create a nonlinear elastic deformation model to improve helicopter main beam designs. These experiments used a homogeneous 7075 aluminum beam and have been referenced as a baseline for the past thirty years to validate computer models and theories in an effort to build beams capable of withstanding aero elastic, static, and dynamic loading. The purpose of this study is to measure the dynamic nonlinear bending and torsion response of a cantilever beam. The natural frequencies are measured in the flatwise and edgewise directions at different static root pitch angles with varying levels of tip weights. The measured natural frequencies were compared to linear equations of motion, a nonlinear computer model and previous experiments to verify the nonlinear effects of root pitch angle and tip weights. The experiment produced promising results in that the first mode in the edgewise and flatwise directions were within the error bands of the Princeton Beam Experiment and that the linear model matched the experimental case with no tip weights. Further experimentation is needed in order to properly calculate the edgewise frequencies and estimate mode shapes.					
15. SUBJECT TERMS Cantilever Beam, Modal Analysis, Natural Frequency, Tip Load, Nonlinear Frequency Response, Root Pitch Angle					
16. SECURITY CLASSIFICATION OF:			17. LIMITATION OF ABSTRACT	18. NUMBER OF PAGES	19a. NAME OF RESPONSIBLE PERSON
REPORT	ABSTRACT	c. THIS PAGE			Donald L. Kunz
U	U	U	UU	207	19b. TELEPHONE NUMBER (Include area code) (937) 785-3636, ext 4320; e-mail: Donald.Kunz@afit.edu

Standard Form 298 (Rev: 8-98)

Prescribed by ANSI Std. Z39-18