

SHIP PRODUCTION COMMITTEE  
FACILITIES AND ENVIRONMENTAL EFFECTS  
SURFACE PREPARATION AND COATINGS  
DESIGN/PRODUCTION INTEGRATION  
HUMAN RESOURCE INNOVATION  
MARINE INDUSTRY STANDARDS  
WELDING  
INDUSTRIAL ENGINEERING  
EDUCATION AND TRAINING

August 1988  
NSRP 0298

# **THE NATIONAL SHIPBUILDING RESEARCH PROGRAM**

## **1988 Ship Production Symposium**

**Paper No. 4B:  
Infusing Producibility into  
Advanced Submarine Design**

U.S. DEPARTMENT OF THE NAVY  
CARDEROCK DIVISION,  
NAVAL SURFACE WARFARE CENTER

# Report Documentation Page

*Form Approved*  
*OMB No. 0704-0188*

Public reporting burden for the collection of information is estimated to average 1 hour per response, including the time for reviewing instructions, searching existing data sources, gathering and maintaining the data needed, and completing and reviewing the collection of information. Send comments regarding this burden estimate or any other aspect of this collection of information, including suggestions for reducing this burden, to Washington Headquarters Services, Directorate for Information Operations and Reports, 1215 Jefferson Davis Highway, Suite 1204, Arlington VA 22202-4302. Respondents should be aware that notwithstanding any other provision of law, no person shall be subject to a penalty for failing to comply with a collection of information if it does not display a currently valid OMB control number.

1. REPORT DATE <b>AUG 1988</b>	2. REPORT TYPE <b>N/A</b>	3. DATES COVERED <b>-</b>		
4. TITLE AND SUBTITLE <b>The National Shipbuilding Research Program: 1988 Ship Production Symposium Paper No. 4B: Infusing Producibility Into Advanced Submarine Design</b>		5a. CONTRACT NUMBER		
		5b. GRANT NUMBER		
		5c. PROGRAM ELEMENT NUMBER		
6. AUTHOR(S)		5d. PROJECT NUMBER		
		5e. TASK NUMBER		
		5f. WORK UNIT NUMBER		
7. PERFORMING ORGANIZATION NAME(S) AND ADDRESS(ES) <b>Naval Surface Warfare Center CD Code 2230 - Design Integration Tools Building 192 Room 128 9500 MacArthur Blvd Bethesda, MD 20817-5700</b>		8. PERFORMING ORGANIZATION REPORT NUMBER		
9. SPONSORING/MONITORING AGENCY NAME(S) AND ADDRESS(ES)		10. SPONSOR/MONITOR'S ACRONYM(S)		
		11. SPONSOR/MONITOR'S REPORT NUMBER(S)		
12. DISTRIBUTION/AVAILABILITY STATEMENT <b>Approved for public release, distribution unlimited</b>				
13. SUPPLEMENTARY NOTES				
14. ABSTRACT				
15. SUBJECT TERMS				
16. SECURITY CLASSIFICATION OF:			17. LIMITATION OF ABSTRACT	
a. REPORT <b>unclassified</b>	b. ABSTRACT <b>unclassified</b>	c. THIS PAGE <b>unclassified</b>	<b>SAR</b>	18. NUMBER OF PAGES <b>14</b>
			19a. NAME OF RESPONSIBLE PERSON	

## DISCLAIMER

These reports were prepared as an account of government-sponsored work. Neither the United States, nor the United States Navy, nor any person acting on behalf of the United States Navy (A) makes any warranty or representation, expressed or implied, with respect to the accuracy, completeness or usefulness of the information contained in this report/manual, or that the use of any information, apparatus, method, or process disclosed in this report may not infringe privately owned rights; or (B) assumes any liabilities with respect to the use of or for damages resulting from the use of any information, apparatus, method, or process disclosed in the report. As used in the above, "Persons acting on behalf of the United States Navy" includes any employee, contractor, or subcontractor to the contractor of the United States Navy to the extent that such employee, contractor, or subcontractor to the contractor prepares, handles, or distributes, or provides access to any information pursuant to his employment or contract or subcontract to the contractor with the United States Navy. ANY POSSIBLE IMPLIED WARRANTIES OF MERCHANTABILITY AND/OR FITNESS FOR PURPOSE ARE SPECIFICALLY DISCLAIMED.

# THE NATIONAL SHIPBUILDING RESEARCH PROGRAM 1988 SHIP PRODUCTION SYMPOSIUM

0298

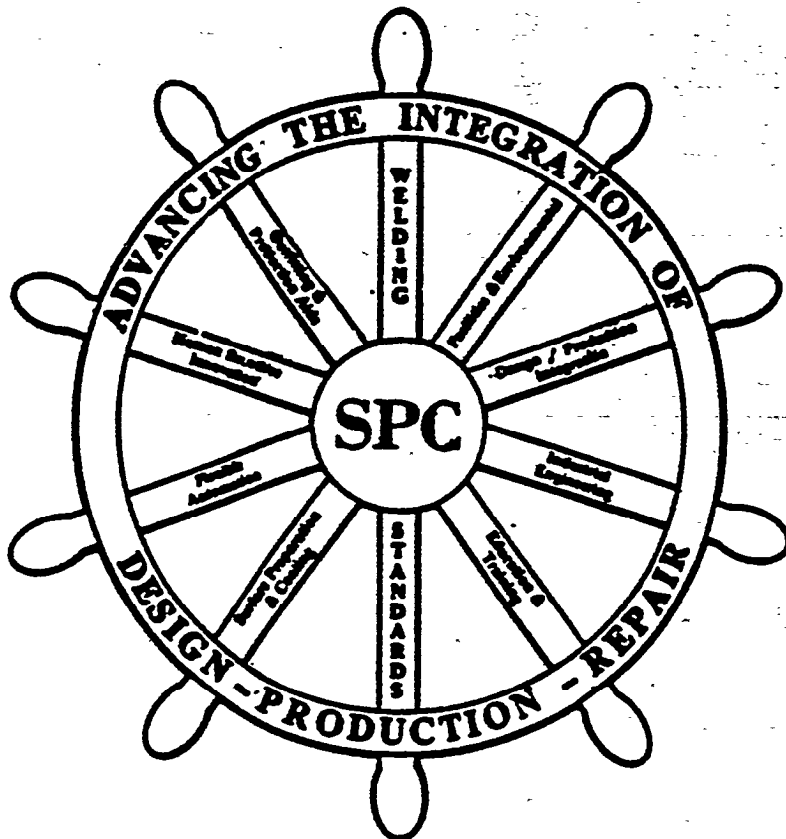

August 24-26, 1988  
Edgewater Inn  
Seattle, Washington

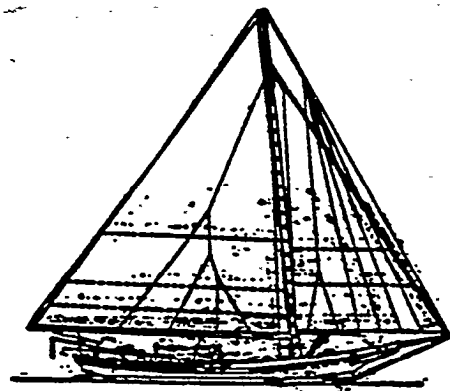

SPONSORED BY THE SHIP PRODUCTION COMMITTEE  
AND HOSTED BY THE CHESAPEAKE SECTION OF  
THE SOCIETY OF NAVAL ARCHITECTS AND MARINE ENGINEERS



# Infusing Producibility Into Advanced Submarine Design

No. 4B

LCDR B. R. Brucker, USN, Member, Naval Sea Systems Command, Washington, D.C.

## ABSTRACT

The SEAWOLF submarine design is promoting the employment of a variety of advanced ship design and production techniques. Major goals of the design are to fully support a zone construction program, capture the data base in a digital format, provide digital products for construction and logistics support and to simplify, as much as possible, the construction effort. Four innovations that support these goals include:

- o Producibility Steering Group
- o Improved drawings
- o Planning and Sequence Documents
- o Producibility Review Process

The implementation of these producibility tasks into a new submarine acquisition has required extensive development by a creative group of designer's and a contingent of production planners. The SEAWOLF Producibility team has undertaken the task to understand and apply the advancements in shipbuilding technology that are in place and are being implemented today. The infusion of producibility is the result of this knowledge being reflected in SEAWOLF Design products.

## INTRODUCTION

The SEAWOLF Advanced Submarine Program is presently in the detail design phase of acquisition. SEAWOLF is advancing technology in many areas. Admiral W.H. Rowden, Commander Naval Sea Systems Command, in a statement to congress, in March 1988 described the SEAWOLF as a ship that is "...designed to counter the rapidly increasing capabilities of the Soviet submarine force projected for the 1990's and beyond. SEAWOLF will be quiet, fast, and well armed with advanced sensors." In addition to the advances that make SEAWOLF a superior warship, the program strongly advocates the infusion of new technology in the design and construction phases of acquisition.

Producibility is the effort to make ships more affordable. Navsea, in cooperation with General Dynamics Electric Boat Division and Newport News Shipbuilding, is leading this part of the SEAWOLF detail design. Shipyard modernization programs at both Electric Boat and Newport News have dictated the need to change the philosophy and products of submarine design. The Producibility Program is responsible for assuring that the SEAWOLF design is optimized for production as well as performance. The Producibility team is working to review the design, create the right design products and infuse the needs of the construction effort into the SEAWOLF program.

Departing from previous submarine designs, SEAWOLF is being designed in a team effort. Newport News Shipbuilding is the Lead Design Yard and has responsibility for hull and all non-propulsion plant systems. Electric Boat Division is the Propulsion Plant Design Yard and through a sub-contract from Newport News is also responsible for the non-propulsion plant systems located in the engineroom. The team arrangement is an outstanding asset from the standpoint of producibility. The discussion and integration of producibility issues by two experienced groups of submarine designers and planners has led to improved design products.

Infusing producibility into a submarine design requires the design yard to understand the New Technology in place and under development in the shipyards. The designer must have a working knowledge of Zone Oriented Construction and Interim Products in order to create the most useful construction drawings. The primary tool of the SEAWOLF designer is the Computer Aided Design workstation, which not only improves the designers capability, but also represents the front end of the Computer aided design and manufacturing (CAD/CAM) system.

Setting the goals and committing the resources to achieve a producible design is an important step. Implementation of the program requires a well structured effort by the design yards, augmented by construction personnel, and the customer. The SEAWOLF Detail Design Team is making the effort and has produced a variety of products that may provoke thought in future programs. Some of the products of the SEAWOLF Producibility program are the Producibility Forum, improved construction drawings, upfront planning effort, Producibility Design Review, and Digital Data Transfer. The Digital Data Transfer Project has been well documented in other papers and will not be re-presented. The remaining products are the result of infusing producibility into the SEAWOLF submarine design.

#### NEW TECHNOLOGY

The U.S. Navy is often involved in developing New Technology to improve the performance of its ships. American Shipbuilders have also been developing New Technology by bringing new hardware, software and method into the shipyard to solve construction problems.

Problem solving through the implementation of New Technology is a process that acquires a specific technology to fulfill a need. The shipyard then develops the required internal procedures and accomplishes the necessary training in order to utilize the new technology in the workplace. The development phase of implementation is critical for insuring that the new technology to achieves management's goals of improving the operation of their company. New Technology programs are an important part of the SEAWOLF Design, not only to improve performance as a warship, but also in the accomplishment of the goal to design a producible submarine.

The SEAWOLF Producibility effort primarily supports two important technologies; Zone Oriented Construction and Computer Aided Manufacturing (CAM). Zone Oriented Construction and CAM have been the focus of shipyard improvement programs for a number of years. However, a submarine design that is dedicated to more fully implementing these technologies is a first.

Computer Aided Design is the tool that has facilitated the Design Yard's task in creating the variety of products required in the SEAWOLF effort. Approximately four hundred CAD workstations are in daily use by the Design Yards to create three dimensional product models that are captured in the SEAWOLF Data Base. The Digital Data Base is a tremendous asset in supporting the iterative nature of the ship design process and is an essential element for the utilization of CAM technology. additionally, its future utilization in the life cycle support of the ship will be substantial.

Zone Oriented Construction is a variant of group technology that has been developed for shipbuilding. Zone Oriented Construction divides the ship into modules that are defined on an arrangement basis or zone of the ship rather than a system basis. Electric Boat and Newport News have integrated zone construction into their submarine construction programs. The investment in bringing this new technology into the shipyards and developing it have been significant. Land Level Facilities have been built at both shipyards to assemble the large modules that are fabricated in shops. Previous submarine designs created a system oriented data base. For a shipbuilder to utilize a zone construction method, the system design had to be translated to define the module arrangement. Although the translation was a significant effort, the benefits of utilizing zone construction by better organizing the flow of work and also reducing the amount of work required within the fully assembled ship's hull made it worthwhile. Since SEAWOLF has been conceived from the outset with the requirement that its design fully support zone construction, the goal of maximum outfitting of modules prior to endloading into hull sections will be achieved. Figure 1 depicts the SEAWOLF structure of submarine zone oriented construction.

Interim Products are the units of work or product structure that supports zone oriented construction. The SEAWOLF product structure is divided into five increasingly complex levels:

1. Piece Parts
2. Items and Packages
3. Sub-Modules
4. Modules
5. Sections

The SEAWOLF hull is divided into eleven sections that receive parts, items, packages, sub-modules and modules directly. After a section is loaded to the maximum extent, it is moved next to its adjacent section and joined. Although all levels of product structure can go directly into the hull sections, in practice most of the volume and weight are loaded at the module and sub-module level. SEAWOLF is designed with twenty module size units. The modules are defined so that they are contained within a particular section without overlap. Each level of product structure, for some period of time, has a unique identity. Figure 2 depicts an example of an interim product. In Figure 2, a foundation is created and identified, for example, as item #1. Sometime later item #1 is joined to a deck with other items and packages to form sub-module #1. The uniqueness of foundation #1 is lost and sub-module #1 assumes an interim identity until it is joined to some other piece of the ship to form a higher tier of product structure (module or section). Each piece of assembly

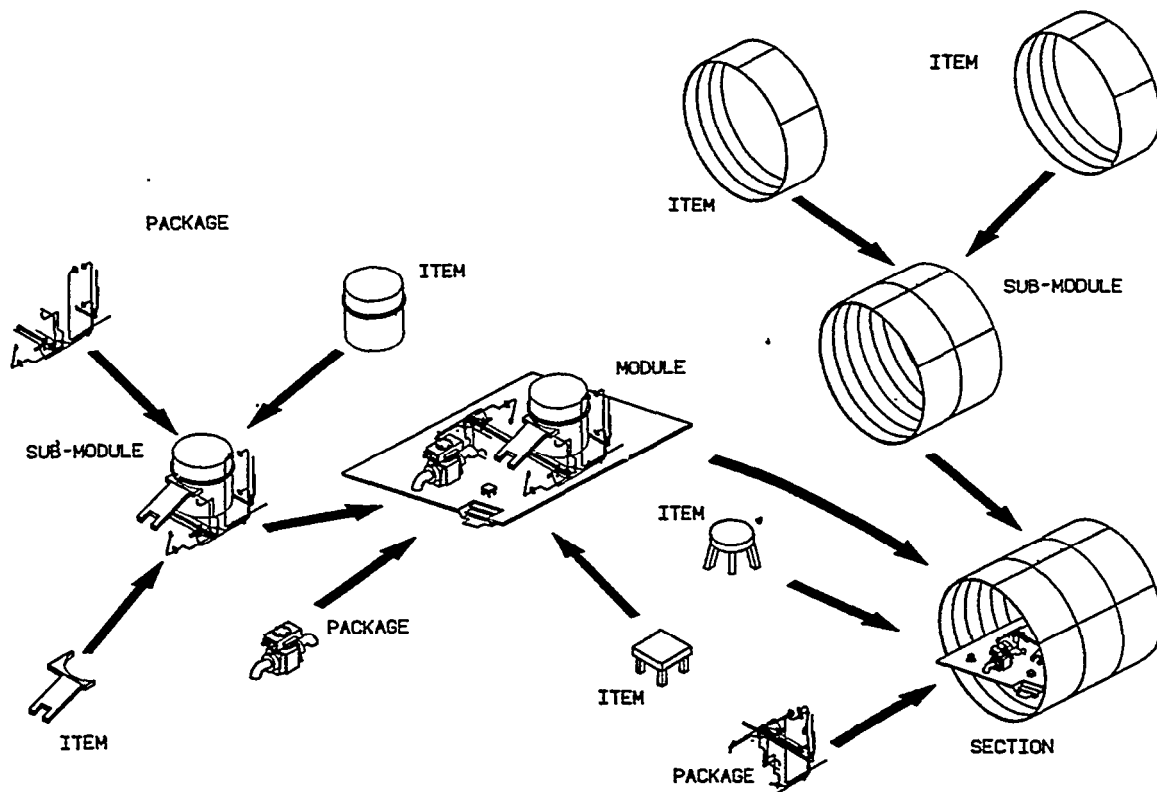

Figure 1. SEAWOLF Zone Construction Product Structure

is defined as an "Interim Product" and becomes important from the aspect of structuring worksite, and organizing construction drawings. Sectional Construction Drawings are based on this product structure and will be discussed later.

Computer Aided Manufacturing is a rapidly progressing technology that is being widely implemented today. Efforts to eliminate manual steps in manufacturing processes are being taken by shipyards as the capability of computer technology improves. Today's computer technology implementation at submarine shipyards is primarily being accomplished at the shop level to improve specific manufacturing processes. As the capability of today's computer expands, their application in manufacturing will follow closely. However, implementing CAM technology into the manufacturing scheme requires more than the investment in the necessary hardware. The shipbuilder must have available or create data that is in a computer usable form. The SEAWOLF Program has the goal of providing, design information in a digital form in

parallel with construction drawings in order to facilitate the use of Numerical Control machines.

The future of manufacturing is involved in the effort to bring Computer Integrated Manufacturing (CIM) to maturity. Manufacturing the thousands of pieces necessary to build a submarine is a complex process that encompasses far more than the actual cutting, bending or machining of parts. The material requirements, schedule of manufacture, storage and retrieval of the product and progressing of work are all part of the manufacturing process. The task for people working in the various functions of manufacturing is to support the process so that each piece needed can be produced on time. Every part is touched in some way by the material, fabrication, scheduling and possibly storage systems of the manufacturing department. The task of constantly updating large amounts of information so the manufacturing will support the construction schedule is a tremendous undertaking and is usually handled by a semi-automated paper tracking system. The evolution of the computer network allows the manufacturer to set the goal of creating a paperless manufacturing effort.

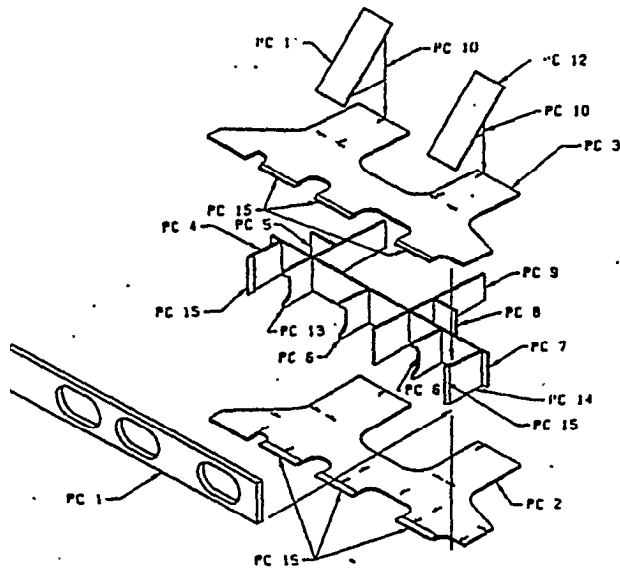

a. Piece Parts

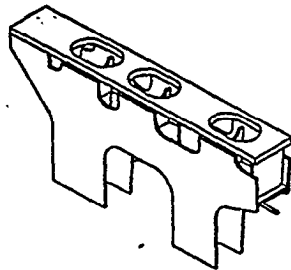

b. Item

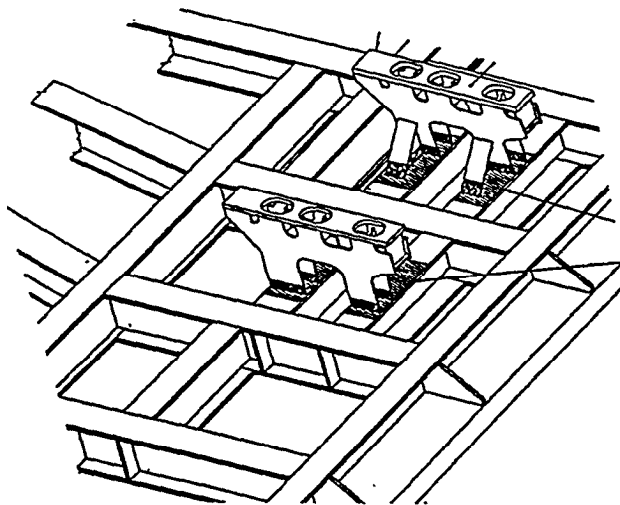

c. Sub-module

Figure 2. Transition of a foundation from an item to part of a sub-module.

The SEAWOLF Digital Data Base and digital data transfer project are important steps in facilitating the Computer Integrated Manufacturing effort. The knowledge that a large amount of the SEAWOLF geometry will be available digitally has helped spur the computer integrated manufacturing programs at both submarine shipyards. The resources required to bring CIM to reality should not be understated; however, the effort by the design yards, in cooperation with their CAD software vendors and the IGES Committee, has crossed a significant boundary in providing a data base in digital form.

#### PRODUCIBILITY STEERING GROUP

In April 1987, the SEAWOLF Program transitioned from competing contract designs between Electric Boat and Newport News into a dual design yard arrangement. Part of the transition process was to formalize the recognized need to create a forum to address Producibility issues. The result was the creation of the SEAWOLF Producibility Steering Group (PSG).

The Steering Group is composed of Design Yard personnel from Electric Boat and Newport News Shipbuilding, with representation from NAVSEA. The group is sub-divided into working groups along the following design and construction functions:

- A. Piping/Ventilation
- B. Machinery
- C. Structure
- D. Electrical
- E. Drawings
- F. Construction Planning

The producibility ideas that had evolved during Contract Design were formalized into action items to be investigated, and new items were added as they were identified. Each item was assigned to a particular working group with lead roles alternated between design yards. The working groups exchange ideas and technical concerns on assigned action items and report the results of their effort at steering group meetings which occur on a regular schedule. The item is considered closed when the design yards reach a formal agreement describing the item and the resolution.

The Producibility Steering Group has handled a wide range of issues, including standardization of high use items, reviewing design standards to improve the utilization of automated processes, applying uniform references and tolerances, and creating uniform design products. The need to apply uniform standards to a ship design utilizing a dual design yard concept is apparent, since a single shipbuilder will use the products of both designers. However, their



is an additional benefit to the SEAWOLF Program. The starting point for the standards is usually each yards present method of doing business, which rarely coincide. After exploration and negotiation, these starting positions evolve into an agreement that embodies a better means to design a producible ship. Examples include the effort to minimize pipe joints, and the development of products that improve the zone oriented construction planning effort, such as the Planning and Sequence Documents.

THE SEAWOLF Producibility Steering Group was a necessary element of a dual design yard effort. However, the need for a producibility forum between design yard, shipbuilder and customer also exists in a single design yard arrangement. The need to deliver the best possible construction scheme coupled with the many items that can reduce the shipbuilder's effort can yield savings that far surpass any additional time in the design phase.

#### SEAWOLF DRAWINGS

A special effort of the steering group was the redefinition of the types, formats and levels of detail of SEAWOLF drawings. This redefinition was required because of the desire to improve construction drawings and support zone construction while recognizing the need to design and approve drawings by system. The SEAWOLF Ship Specification defines three general types of drawings to be created at the design yards:

- o Configuration
- o Sectional Construction
- o Ship Support

Configuration Drawings are system oriented drawings that are the framework of the data base. Many Configuration Drawings require approval from government agencies such as NAVSEA or the cognizant Supervisor of Shipbuilding. Configuration Drawings that require Navy approval are mostly diagrams or arrangement drawings that depict significant portions or critical elements of the ship. In addition, the design yard creates another group of more detailed configuration drawings as a means of gaining internal approval of smaller portions of the design. The Format of the Configuration Drawings has changed little from the "Class" Drawings that are common to all ship designs. The Level of Detail is reduced, since any detail that is required only for construction is unnecessary for approval is removed and placed on construction drawings. This change has caused some additional dialogue between design yard and customer, but the impact has been small. The greatest effort has been in the training of personnel to deal with the somewhat different SEAWOLF design products.

Sectional Construction Drawings (SCD'S) are a translation of the data base developed by the Configuration Drawings to support zone oriented construction. The intent of the SCD is to provide the shipbuilder with all the information needed to construct the ship in the most useful format possible. The structure of the SCD is discussed below.

Ship Support Drawings will be used in the life cycle support of the SEAWOLF and are composed of Configuration and selected Sectional Construction Drawings. Additional Logistic information is provided by a special group of drawings created for logistics support such as drydocking drawings, equipment removal flowpath drawings and selected record drawings.

#### SECTIONAL CONSTRUCTION DRAWINGS

The SEAWOLF Ship Specification defined the purpose of a Sectional Construction Drawing, but it was left to the Producibility Steering Group to structure this new type of drawing. the goals in creating the sectional construction drawing were:

- o Support zone oriented construction
- o Create logical work packages
- o Insure the drawing could stand alone in the work place
- o Minimize additional planning by the shipbuilder

Supporting the construction scheme through the SCD'S was accomplished by designing each drawing to create an interim product, whether the product be an item or a large module. The SCD identifies a list of material (Engineering Parts List) and goes through the necessary sequential steps that build the product. In the case of an item, the Engineering Parts List starts with raw material, consumes it in a manufacturing process and prepares the item for joining with other products. A module SCD would start with previously assembled interim products, such as items, packages, and sub-modules and then work through the required sequence to put the module together.

In order to aid the shipbuilder, a system to "intelligently" number the SCD'S was created. The eight digit SCD number was constructed with fields that indicate in what section, module and sub-module the drawing's interim product would be located. For Example, all SCD'S numbered between 40000000 and 49999999 cover work only in Section 4. more specifically the 42000000 series of drawings builds the fan room module (module #2) of Section 4. The usefulness of the numbering system extends beyond construction. During the life of the ship, knowing that the SCD number is tied to a specific area in the ship will be an aid in finding detailed logistics support information. Figure 3 shows the SCD numbering system.

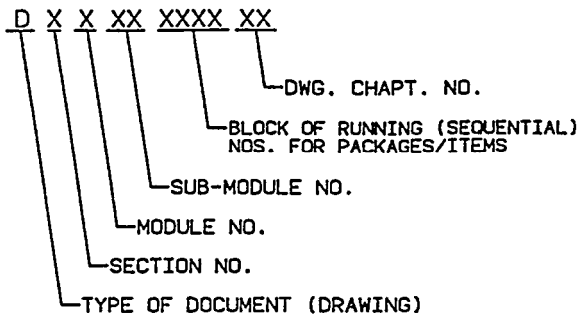

**EXAMPLE:**

FAN ROOM MODULE (MODULE NO.2  
IN SECTION 4)  
D42XXXXXXXXX  
PIPING PACKAGE NO. 26  
D4200002630  
D4200002631  
D4200002632  
D4200002633  
D4200002639

Figure 3. Sectional Construction Drawing Numbering System.

Constructing an interim product is in most instances a multi-skill endeavor. Figure 4 depicts the assembly of a simple package of pipe that will require cutting and bending the pipe, welding fittings and valves, adding pipe hangers and assembling the package into a fixture. Outfitting a module would normally involve a variety of operations from Structural, Mechanical, Piping, Ventilation and Electrical trades. To make the SCD more useful it is broken into functional trade work packages called

chapters. The numbering of the chapters is uniform; for example, in a SEAWOLF SCD chapter 04 always assembles structural piece parts and chapter 80 always involves painting. Therefore, the painting supervisor will know that his share of the work load will always be found in chapter 80, no matter which drawing is involved. The breakdown of the SEAWOLF chapter numbering system is shown in Figure 5. The chaptering system not only provides a logical breakdown of work, but allows the central planner to distribute to the work centers only the chapters they need. The drawing chapters are tied together by chapter 00, the control chapter. This chapter lists all other chapters and keeps track of the overall revision history of the drawing.

Each chapter of the SCD is structured so that as a work package it can stand alone without other documentation. If a reference provides essential information, then that reference information must be extracted and placed on the SCD. The reference information is normally available to the designer as he is creating the design, but becomes a burden on the planner and tradesman to find, interpret and apply during construction. The chapters also stand alone from the viewpoint that they can be detached from the overall drawing and be sent to the work center that requires the information.

The SCD format must extend beyond the task of creating interim products if they are to be the vehicle for the entire construction process. The joining of sections and the outfitting operations that cover more than one section after joining must be addressed. The joining operation consists primarily of making the circumferential joint between two sections

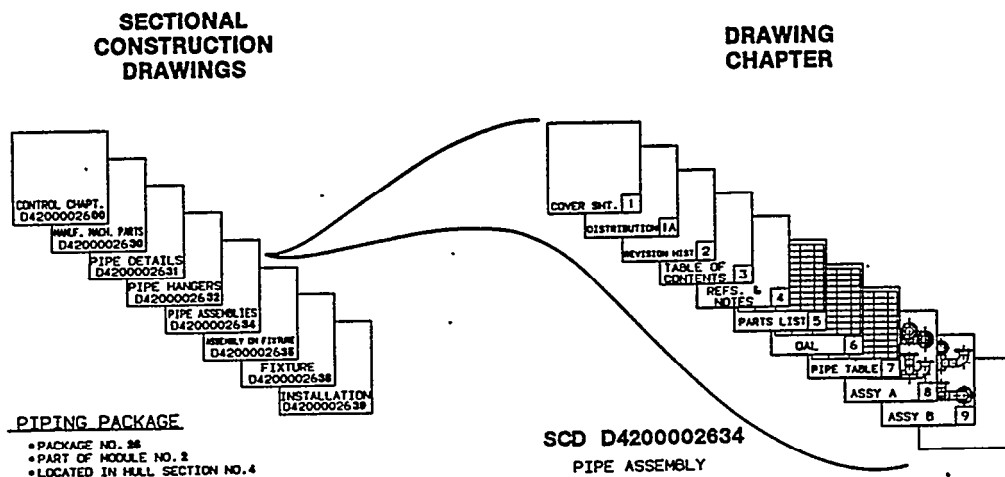

Figure 4. Chapter Structure of a Sectional Construction Drawing.

	DWG. CHAPTS .	TYPE		DWG. CHAPTS .	TYPE
STRUCTURAL	00	CONTROL	MACHINERY	20	MANUF. DETAILS
	01	DESIGN PART DETAILS		21	PRE-ASSEMBLY
	02	MANUF. DETAILS		22	ASSEMBLY
	03	PRE-ASSEMBLY		23	
	04	ASSEMBLY		24	
	05			25	
	06			26	
	07			27	CASTING/FORGING
	08	FIXTURES		28	FIXTURES
	09	INSTALLATION	29	INSTALLATION	
FITTINGS	10	DESIGN PART DETAILS	PIPING	30	MANUF. DETAILS (MACH. PARTS)
	11	MANUF. DETAILS		31	PIPE DETAILS
	12	PRE-ASSEMBLY		32	HANGERS
	13	ASSEMBLY		33	PRE-ASSEMBLY
	14			34	ASSEMBLY
	15			35	ASSEMBLY ON FIXTURE
	16			36	
	17			37	
	18	FIXTURES		38	FIXTURES
	19	INSTALLATION	39	INSTALLATION	
HVAC	40	DUCT DETAILS	ELECTRICAL	60	CABLE PRE-ASSY
	41	HANGER DETAILS, MANUF.		61	WIREWAY MANUF.
	42	FITTINGS, MANUF.		62	LIGHTING MANUF.
	43	PRE-ASSEMBLY		63	SPEC. MISC. ELECTRONICS COMP. INSTALL
	44	ASSEMBLY		64	EQUIPMENT CABLE ENTRANCE
	45	ASSEMBLY ON FIXTURE		65	FIXTURES
	46			66	CABLE TERMINATION & HOOK-U'
	47			67	CABLE INSTALLATION
	48	FIXTURES		68	WIREWAY INSTALLATION
	49	INSTALLATION	69	LIGHTING INSTALLATION	
ELECTRICAL	50	ENCLOSURE (OR CHASSIS) MFG.	MULTISYSTEMS	70	PRE-ASSEMBLY
	51	MISCELLANEOUS MANUF.		71	ASSEMBLY
	52	PRINTED/ACTIVE CIRCUIT FAB.		72	
	53	FINAL ASSY & WIRING		73	
	54			74	
	55			75	
	56			76	
	57			77	
	58	FIXTURES		78	FIXTURES
	59		79	EQUIP. INSTALL	
SERVICES				80	PAINTING
				81	THERMAL INSUL./LAGGING
				82	SOUND INSULATION
				83	DRIP/SPRAY SHIELDS
				84	TRANS. LOSS TREATMENT
				85	STAVE DAMPING
				86	LABEL PLATES
				87	INSTRUMENTATION
				88	INSPECTION
				89	TESTING
				90	MACHINING
		91	ALIGNMENT PROCEDURE		

Figure 5. Sectional Construction Drawing Chapter Numbering System.

followed by the tying together of the distributed systems (piping and ventilation) and the pulling of electrical cable across the interface. The "J" drawing has been developed to meet this need. The drawing number will contain a "J" followed by the numerical designator of the two sections involved; ie, the SCD joining sections 1 and 2 will be number J12000001 (or higher if more than one drawing is used). The multi-section drawing is an "M" series drawing that will cover work that follows after the joining phase. This drawing will have a numbering scheme containing the designator "M" and the first and last sections involved. In the case of a forward ship task the number could be M13000001, indicating sections 1, 2 and 3 would be involved.

The complexity of Nuclear submarines has increased dramatically over the years, and SEAWOLF will continue that trend. The Sectional Construction Drawing provides the shipbuilder a tool to handle the complexity by presenting detailed yet simplified views of what is to be built, without extraneous information. The SCD presents the shipbuilder logical work packages that reduce the need for detailed waterfront engineering and planning. The completion by a shop of a drawing chapter will indicate that a product has been built, or a specific value added to a product, such as painting. The SEAWOLF Sectional Construction Drawing achieves the goals that are requirements of the ship's specification. It is a measurable achievement in zone oriented ship construction.

#### PLANNING AND SEQUENCE DOCUMENTS:

The process of creating interim products from the item level up to the section level evolves a logical sequence of assembly. As the design is iterated and the design spiral tightens, the assembly sequence becomes a parameter affecting design decisions because the changes may affect how work is packaged. To assist designers' in understanding the construction process, knowledgeable waterfront planners are brought into the SEAWOLF Detail Design effort. One of their tasks is to arrange the fabrication and assembly of interim products into a scheme that fits into the facilities and practice of submarine shipbuilders. The planning group utilizes a computer based scheduling system to produce a variety of networks. All the SCD's necessary to produce an interim product at the module or section level are networked together to permit analysis of the proposed construction sequence. these networks are titled "Sequence" documents and are the foundation for creating many useful products. An example of a sequence document is illustrated in Figure 6. The first

by-product is created by the addition of a timeframe to each event of the sequence network yielding the "planning" document. The utility of the planning document is the ability to capture information necessary to work out a finite construction period. A planning document example is depicted in Figure 7. Study of the planning and sequence networks will indicate the key points in the construction that are summarized to produce the Master Construction Schedule (MCS). Figure 8 illustrates the evolution of a MCS activity from the Planning and Sequence documents. Since the MCS is produced from a "bottom-up" approach based on a drawing by drawing evaluation, it is a valid scheduling tool that is available during the Detail Design process. From the MCS other products fall out, such as the drawing issue schedule and material ordering schedule. The products needed by the shipbuilder become the driving force in meeting schedules to provide design products, especially on the lead ship.

#### PRODUCIBILITY REVIEW

The role of NAVSEA and the engineering offices at the Supervisors of Shipbuilding is to review the work of the Design Yards from the standpoint of technical adequacy. Their responsibility does not extend into the arena of producibility. The technical reviewer does not pose the question "can the design be efficiently produced?". A major benefit of the dual design yard arrangement is the capability for review of the design products of the other team member by knowledgeable designers and shipbuilders. It is necessary to set producibility goals and standardize high usage items; however, a drawing by drawing review presents the opportunity to validate the SEAWOLF Design as a truly producible one. The SEAWOLF Program has formally involved both team members in a producibility review of design products. The "Producibility Review Procedure" was developed by the Steering Group to ensure that every SCD developed is reviewed not only in house, but also by an independent and highly interested second party. The original concept was to submit only SCD'S, regardless of content, to the other design yard. During the development of the procedure it was noted that many other documents being created or in review at the design yards, such as mockup drawings and specific process instructions, have producibility implications, and the procedure was modified to permit any document to be included in the review process.

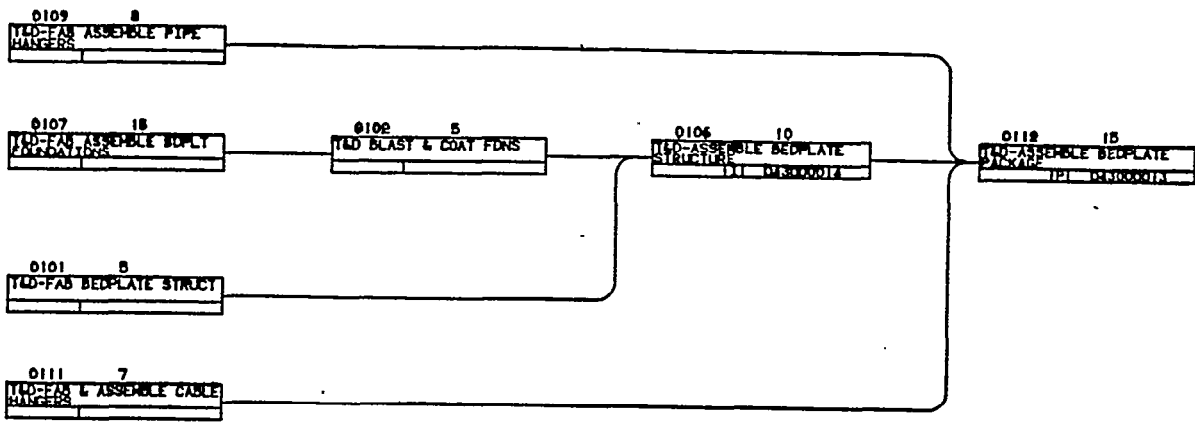
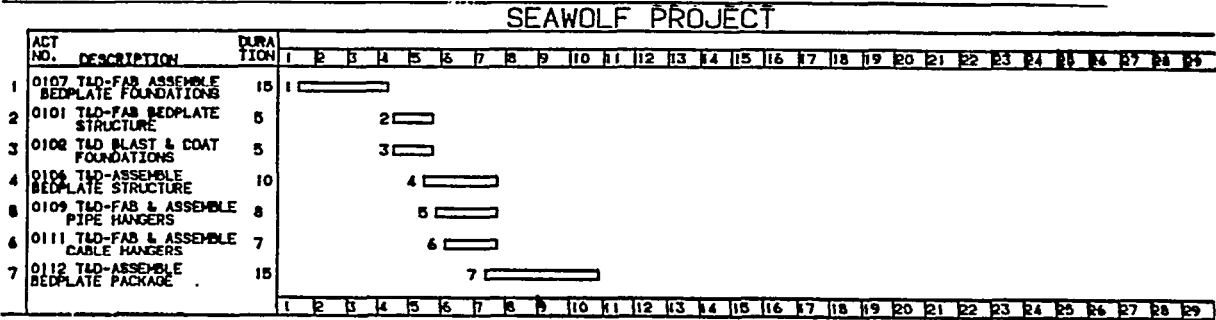

Figure 6. SEAWOLF Planning Document



TRIM PUMP MOD PLAN DOC  
DOCUMENT NO. PL4300000002

Figure 7. SEAWOLF Sequence Document

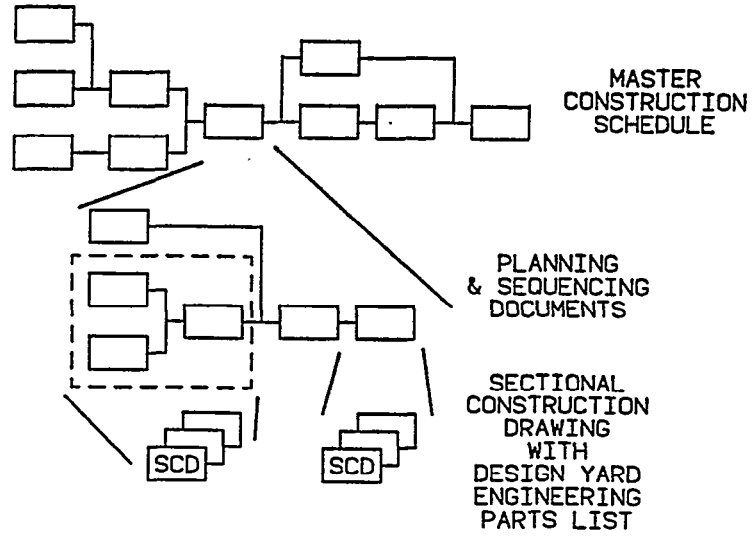

Figure 8. Evolution of the Master Construction Schedule

Implementation of the review process required the formation of a team to conduct the review. This review team is a combination of design, construction, planning, manufacturing engineering and quality assurance (NDP) personnel. The team can serve to review documents produced by its own design yard and also the documents received from the other design yard. The review primarily involves the comparison of construction experience to the design presented. Each member of the review team applies his own expertise and comments on changes that would improve the producibility of the design at hand. Review comments are formally transmitted to the design yard and they are incorporated into the drawing, or discussed with the reviewer if a difference of opinion exists.

The Producibility Review process has elicited a wide variety of comments from both shipyards. Examples of producibility issues include:

- o Replacement of welded fittings with pipe bends
- o Recommendations to improve machining
- o Alternate materials to improve fabrication
- o Addition of notes to improve clarity of drawings
- o Recommendations on tolerances and reference lines
- o Recommendations on welding sequence to reduce distortion
- o Improving the access for welding and installing mechanical joints
- o Improving clarity of welding information
- o Replacing structure composed of welded pieces with a single cold formed item

In some cases the desired improvement in producibility is offset by technical design requirements and the comment can not be incorporated. However, in most cases producibility comments can be accommodated and they are reflected in changes to SCD's.

The Producibility Review allows experienced construction personnel an opportunity to apply their hard learned lessons to the design process. This opportunity occurs at a point in the design when the comments can be acted upon with a minimum of disruption.

#### SUMMARY

The SEAWOLF Producibility effort has been successful in focusing energy to facilitate a zone oriented construction plan and to improve the manufacture of the ship. Completely capturing the design in an electronic data base is a major step toward the automation of the work place from the fabrication, material handling and production management functions. The philosophy is, that designing for production is an

investment with a tremendous potential for a substantial cost reduction for the Navy and its shipbuilders.

SEAWOLF Program experience has shown that when the appropriate resources are dedicated to creating a producible design, that it will succeed. A working forum, such as the SEAWOLF Producibility Steering Group is a necessary focal point to guide the effort. Complex projects such as creating the right drawings and facilitating a Producibility Review can be accomplished with the support of management and the enthusiastic cooperation of skilled engineers and designers. The Design Yard must maintain a constant dialogue with the shipbuilders to ensure that the output of the design meets his needs. The trade-offs between technical adequacy and ease of construction must be constantly evaluated so that the specifications are met and the results of the producibility effort are incorporated.

The shipbuilding environment of today necessitates that, for a shipbuilder to remain competitive, a continuous injection of new technology into the shipyard must occur. The desired cost reduction can be severely hampered when the design products do not support the shipyard's construction philosophy or facilities. Infusing Producibility into ship design is a major feature of the SEAWOLF Program. The potential for improving the construction of the U.S. Navy's advanced submarine is real, and future ship designs should consider building on the products of the SEAWOLF Producibility effort.

#### ACKNOWLEDGMENTS

The author wishes to express appreciation to those who have been the foundation of the SEAWOLF Producibility Team; the talented designers, engineers and planners of Newport News Shipbuilding and Electric Boat Division.

The considerable vision of the leadership of the U.S. Navy's SEAWOLF Advanced Submarine Acquisition Project in staying the course of a submarine designed not only for top performance, but also optimized for construction deserves to be recognized.

#### REFERENCES

1. "Statement of Vice Admiral William H. Rowden, U.S. Navy; Commander, Naval Sea Systems Command; Before the Seapower subcommittee of the House Armed Services Committee on Shipbuilding and Conversion" on 3 March 1988.
2. Bunch, H., R. Storch, C. Hamon, Ship Production, first edition, Cornell Maritime Press, 1988.
3. Maritime Administration, NSRP, Product Work Breakdown Structure, Seattle, 1980.
4. National Academy Press, Toward More Productive Naval Shipbuilding, Washington, D.C., 1984.

Additional copies of this report can be obtained from the  
National Shipbuilding Research and Documentation Center:

**<http://www.nsnet.com/docctr/>**

Documentation Center  
The University of Michigan  
Transportation Research Institute  
Marine Systems Division  
2901 Baxter Road  
Ann Arbor, MI 48109-2150

Phone: 734-763-2465  
Fax: 734-763-4862  
E-mail: [Doc.Center@umich.edu](mailto:Doc.Center@umich.edu)