

AFRL-SN-WP-TP-2006-112

**SENSITIVITY IMPROVEMENT OF A
LOW COST COMMERCIAL GPS
RECEIVER THROUGH SOFTWARE
APPROACH (PREPRINT)**



David M. Lin, James B.Y. Tsui, Lee Liou, and John Schamus

JANUARY 2004

Approved for public release; distribution is unlimited.

STINFO COPY

This work has been submitted for publication in 2004 Proceedings of Institute of Navigation (ION) National Technical Meeting. One or more of the authors is a U.S. Government employee working within the scope of their Government job; therefore, the U.S. Government is joint owner of the work. If published, the publisher may assert copyright. The Government has the right to copy, distribute, and use the work. All other rights are reserved by the copyright owner.

**SENSORS DIRECTORATE
AIR FORCE RESEARCH LABORATORY
AIR FORCE MATERIEL COMMAND
WRIGHT-PATTERSON AIR FORCE BASE, OH 45433-7320**

NOTICE

Using Government drawings, specifications, or other data included in this document for any purpose other than Government procurement does not in any way obligate the U.S. Government. The fact that the Government formulated or supplied the drawings, specifications, or other data does not license the holder or any other person or corporation; or convey any rights or permission to manufacture, use, or sell any patented invention that may relate to them.

This report was cleared for public release by the Aeronautical Systems Center (ASC) Public Affairs Office (PAO) and is releasable to the National Technical Information Service (NTIS). It will be available to the general public, including foreign nationals.

PAO Case Number: ASC 04-0130, 16 Jan 2004.

THIS TECHNICAL REPORT IS APPROVED FOR PUBLICATION.

//Signature//

David M. Lin, Electronic Engineer
Reference Sensors and Receiver
Applications Branch
RF Sensors Technology Division
Sensors Directorate

//Signature//

Boyd E. Holsapple, Chief
Reference Sensors and Receiver
Applications Branch
RF Sensors Technology Division
Sensors Directorate

//Signature//

William E. Moore, Chief
RF Sensors Technology Division
Sensors Directorate

This report is published in the interest of scientific and technical information exchange and its publication does not constitute the Government's approval or disapproval of its ideas or findings.

REPORT DOCUMENTATION PAGE

Form Approved
OMB No. 0704-0188

The public reporting burden for this collection of information is estimated to average 1 hour per response, including the time for reviewing instructions, searching existing data sources, gathering and maintaining the data needed, and completing and reviewing the collection of information. Send comments regarding this burden estimate or any other aspect of this collection of information, including suggestions for reducing this burden, to Department of Defense, Washington Headquarters Services, Directorate for Information Operations and Reports (0704-0188), 1215 Jefferson Davis Highway, Suite 1204, Arlington, VA 22202-4302. Respondents should be aware that notwithstanding any other provision of law, no person shall be subject to any penalty for failing to comply with a collection of information if it does not display a currently valid OMB control number. **PLEASE DO NOT RETURN YOUR FORM TO THE ABOVE ADDRESS.**

1. REPORT DATE (DD-MM-YY) January 2004		2. REPORT TYPE Conference Paper Preprint		3. DATES COVERED (From - To) 11/01/2002 – 01/01/2004	
4. TITLE AND SUBTITLE SENSITIVITY IMPROVEMENT OF A LOW COST COMMERCIAL GPS RECEIVER THROUGH SOFTWARE APPROACH (PREPRINT)				5a. CONTRACT NUMBER In-house	
				5b. GRANT NUMBER	
				5c. PROGRAM ELEMENT NUMBER 62204F	
6. AUTHOR(S) David M. Lin, Lee Liou, and James B.Y. Tsui (AFRL/SNRP) John Schamus (General Dynamics, Inc.)				5d. PROJECT NUMBER 7622	
				5e. TASK NUMBER 11	
				5f. WORK UNIT NUMBER 08	
7. PERFORMING ORGANIZATION NAME(S) AND ADDRESS(ES) Reference Sensors and Receiver Applications Branch (AFRL/SNRP) General Dynamics, Inc. RF Sensors Technology Division Sensors Directorate Air Force Research Laboratory, Air Force Materiel Command Wright-Patterson AFB, OH 45433-7320				8. PERFORMING ORGANIZATION REPORT NUMBER AFRL-SN-WP-TP-2006-112	
9. SPONSORING/MONITORING AGENCY NAME(S) AND ADDRESS(ES) Sensors Directorate Air Force Research Laboratory Air Force Materiel Command Wright-Patterson Air Force Base, OH 45433-7320				10. SPONSORING/MONITORING AGENCY ACRONYM(S) AFRL-SN-WP	
				11. SPONSORING/MONITORING AGENCY REPORT NUMBER(S) AFRL-SN-WP-TP-2006-112	
12. DISTRIBUTION/AVAILABILITY STATEMENT Approved for public release; distribution is unlimited.					
13. SUPPLEMENTARY NOTES This paper contains color. This work has been submitted for publication in 2004 Proceedings of Institute of Navigation (ION) National Technical Meeting. One or more of the authors is a U.S. Government employee working within the scope of their Government job; therefore, the U.S. Government is joint owner of the work. If published, the publisher may assert copyright. The Government has the right to copy, distribute, and use the work. All other rights are reserved by the copyright owner. PAO Case Number: ASC 04-0130, 16 Jan 2004.					
14. ABSTRACT This paper reports sensitivity improvement of a stationary GPS receiver using software GPS approach. The experiments were conducted using both simulated and real GPS signals. The sensitivity improvement can be as much as 10 dB. This paper discusses the software algorithms developed to perform the code acquisition and tracking that enabled the sensitivity improvement. The commercial GPS receiver has an unusual sampling frequency of 5.455657×106 Hz. The paper will discuss techniques used to handle such odd sampling rate in the software algorithms, also, the determination of the time skew (fine time) between clock phase and initial phase of C/A code when working with this odd sampling rate. The techniques discussed in this paper is not only limited to work with the specific commercial receiver. They can be applied to software receiver with any sampling frequency. Experimental set up and procedures used to evaluate the sensitivity improvements are also discussed.					
15. SUBJECT TERMS Software GPS receiver, sensitivity improvement, in-house					
16. SECURITY CLASSIFICATION OF:			17. LIMITATION OF ABSTRACT: SAR	18. NUMBER OF PAGES 14	19a. NAME OF RESPONSIBLE PERSON (Monitor) David M. Lin 19b. TELEPHONE NUMBER (Include Area Code) N/A
a. REPORT Unclassified	b. ABSTRACT Unclassified	c. THIS PAGE Unclassified			

Sensitivity improvement of a low cost commercial GPS receiver through software approach

David M. Lin,
Receiver and Referencing Technology Branch
RF Technology Division,
Sensors Directorate,
Air Force Research Laboratory
U. S. Air Force

James B.Y. Tsui,
Receiver and Referencing Technology Branch,
RF Technology Division,
Sensors Directorate,
Air Force Research Laboratory
U. S. Air Force

Lee Liou,
Receiver and Referencing Technology Branch
Device Technology Division,
Sensors Directorate,
Air Force Research Laboratory
U. S. Air Force

John Schamus
General Dynamics Inc,

BIOGRAPHY

David M. Lin received the B.S.E.E. from Tatung Institute of Technology, Taiwan, 1970, the M.S.E.E. and the M.E.M.E. from Tennessee Technological University Cookeville, Tennessee, 1977, 1978 respectively and the M.S.C.S. from Wright State University, Dayton, Ohio, 1984. From 1979 to 1985, he was a software Engineer at System Research Laboratories, Inc. Dayton OH. Since 1985 he has been an Electronics Engineer at the Air Force Research Laboratory, Wright Patterson Air Force Base, OH. His work involves Electronic Warfare, radar and GPS receivers. He has received 10 patents.

James B.Y. Tsui was born in Shantung, China. He received the B.S.E.E. degree from National Taiwan University, Taiwan, the M.S.E.E. degree from Marquette University, Milwaukee, WI, and the Ph.D. degree in electrical engineering from the University of Illinois at Urbana, in 1957, 1961 and 1965 respectively. From 1965 to 1973, he was an Assistant Professor and then Associate Professor in the Electrical Engineering Department of the University of Dayton, Dayton, OH. Since 1973 he has been an Electronics Engineer at the Air Force Research Laboratory, Wright Patterson Air Force Base, OH. His work is mainly involved with microwave receivers and his recent research is on digital microwave

receivers and global positioning system (GPS) receivers. He has written four books on microwave and digital receivers, two chapters for two books and published over 70 technical papers. He has received about 30 patents.

Lee L. Liou received a B. S. degree in physics, a M. S. degree in geophysics, and a Ph. D. degree in physics from University of Southern California, Los Angeles, in 1985. He worked for Hewlett-Packard during 1985 and 1986. Since then he worked for Air Force Research Laboratory in Wright-Patterson Air Force Base, OH. His work includes the modeling of semiconductor devices, electromagnetic simulations and signal processing.

John J. Schamus received the BSEE in 1994 and MSEE in 1998 from Wright State University, Dayton, OH. He has worked for Wright Laboratory, Wright Patterson Air Force Base as a contractor with SAIC and SRL/Veridian/GD-AIS since 1988. His work has been in the areas of electronic warfare analysis, infrared missile countermeasures simulation, and digital receivers.

ABSTRACT

This paper reports sensitivity improvement of a stationary GPS receiver using software GPS approach. The experiments were conducted using both simulated and real GPS signals. The sensitivity improvement can be as much as 10 dB. This paper discusses the software algorithms developed to perform the code acquisition and tracking that enabled the sensitivity improvement. The commercial GPS receiver has an unusual sampling frequency of 5.455657×10^6 Hz. The paper will discuss techniques used to handle such odd sampling rate in the software algorithms, also, the determination of the time skew (fine time) between clock phase and initial phase of C/A code when working with this odd sampling rate. The techniques discussed in this paper is not only limited to work with the specific commercial receiver. They can be applied to software receiver with any sampling frequency. Experimental set up and procedures used to evaluate the sensitivity improvements are also discussed.

INTRODUCTION

There are several GPS manufactures that provide GPS OEM (Original Equipment Manufacture) modules with a RF front end, A/D converters, channels of correlator, and a postprocessor. These modules can be connected to a portable or a desk top computer. The computer can process information provided by the GPS module for a variety of applications. Due to the ever increasing computational power of personal computers, for those applications that require the use of a personal computer, we may take one step further in exploiting the use of the computer. That is, we can simplify the GPS module and move GPS receiver functions to the PC to implement a software GPS receiver. This can be achieved by using the RF front end chips on these OEM modules to down convert the input signal to the IF (Intermediate Frequency) band and then digitize the signal. The rest of a GPS receiver functions can all be accomplished by software on the computer. Not only does this approach require less hardware components, it also has better performance in the code initial phase acquisition because the frequency domain block processing can be used. The tracking loop can also be more adaptive to signal strength, noise condition, and application dynamics.

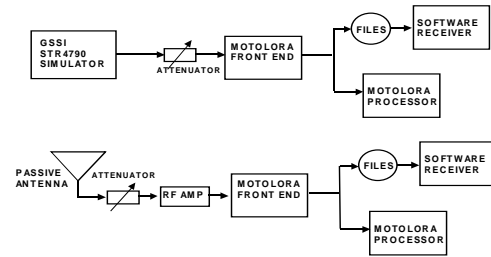

Figure 1. Hardware setup for receiver sensitivity evaluation.

SENSITIVITY COMPARISON

The front end used in this study is a part of Motorola Model M12 Oncore GPS receiver. The sampling frequency is 5.455657×10^6 Hz. We modified this front-end so that IF output could be tapped and digitized. The experimental set-up is shown in Figure 1. The top portion of Figure 1 shows the setup of experimenting with simulator data. A hardware GPS simulator (Model STR4790 from Global Simulation System, Inc.) was connected to the input of the receiver. Eight satellite signals were programmed, and the signal strength in five of them are very close. The power level of the signal could be varied by an attenuator. We found that the Motorola receiver stopped tracking signals when the attenuator was set at 71 dB. The receiver could not be cold started until the attenuator setting was reduced to 61 dB. Digitized signals were collected with the attenuator settings from 61 to 73 dB. The software approach could acquire and track the signal at 72~73 dB, demonstrating that the sensitivity of the receiver was improved by about 10 dB while the same hardware front end was used.

The bottom portion of Figure 1 shows the setup of working with real data. A special front-end arrangement was made for this purpose. A passive antenna followed by an attenuator was placed before the first RF amplifier. With this set-up, when the attenuator was changed one dB, the signal-to-noise ratio of the receiver is also changed one dB. Therefore, the amount of improvement could be determined. Similar results were obtained as in the case of using the simulator. The minimum attenuator setting was recorded before the Motorola receiver could cool start. From this minimum setting, the attenuation

was increased to 10 dB while the software approach could still acquire and track the signals. Thus, the sensitivity improvement of software receiver was about 10 dB when working with real data.

C/A CODE INITIAL PHASE AND FREQUENCY ACQUISITION

In the software approach, an initial processing is to further down convert the digitized data from IF to base band. The base band frequency can vary ± 5 kHz due to satellite Doppler shifts even when GPS receiver is stationary. It is well understood that one ms of coherent data processing can provide 1 kHz frequency resolution while 10 ms of coherent data processing can provide 100 Hz frequency resolution. This paper uses one ms coherent data processing to perform the circular correlation. Ten consecutive 1-ms coherent correlation results from the same time bin can be used to perform 10-point FFT (Fast Fourier Transform) to coherently integrate 10 ms of data^[1].

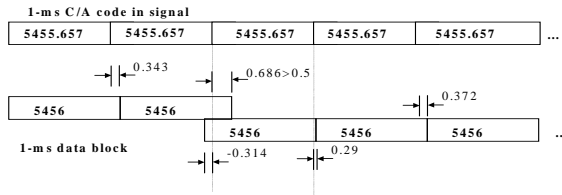

Figure 2. Signal C/A code and data block alignment

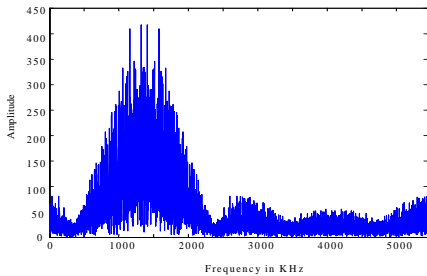

Figure 3 C/A code spectrum (with carrier)

Since the sampling frequency is 5.455657 MHz, the number of samples in one period of Doppler free C/A code is 5455.657. If Doppler shift is present, the number of samples in one period of C/A code will change by this amount:

$$m = 5455.657 \left(\frac{f_l}{f_l + f_d} \right) \quad (1)$$

where $f_l = 1575.42$ MHz is the L1 frequency and f_d is the Doppler frequency. According to (1), Doppler frequency of ± 5 kHz correspond to m values of 5455.657 ± 0.0173 point. It is not a significant change. Therefore, the number of data in one C/A code period is very close to 5455.657. But it is not an integer. In order to perform the block circular correlation, we have to make data block size an integer. As a result, 5456 data points are taken as a block for frequency domain processing. For every millisecond, 5456 data are read in and down-converted. As shown in Figure 2, assuming the first point of the first data block is coincidentally lined up with the initial phase of the C/A code in input signal. The first point in the second data block is 0.343 point off the initial phase of the second C/A code in the signal. If we continue taking data in this way, the first point of the third data block will be 0.686 point off the initial phase of the third C/A code in the signal. This offset is greater than 0.5 point. To ensure the offset to be less than half of a sample interval, the first point of the third data block is taken from the last point of the previous block. Now, the first point of the third data block is -0.314 point off the initial phase of third C/A code in the signal. The following data blocks are taken based on the same principle to ensure the first point of a data block and the initial phase of C/A code of the signal are within ± 0.5 sample point. After data are taken, a 5456-point FFT (Fast Fourier Transform) is applied to them. Figure 3 is a FFT spectrum of C/A code with IF at 1.364 MHz. It shows that less than half of the spectrum contains significant information. Therefore, only half of the spectrum is kept. The other half is casted out since it contains half of the total noise and only a small portion of the useful information^[2]. Keeping only half of the spectrum also reduces the computation time. The local C/A code reference is also digitized into 5456 points and applied the FFT. The same half of the complex conjugate spectrum is stored for repetitive use. The acquisition uses 10 ms coherent integration and then uses as many as non-coherent integrations needed to acquire the initial phase of C/A code and the Doppler frequency.

Due to the Doppler effect, the location of the initial phase of C/A code in each data block is different. In order to non-coherently integrate

tens of blocks of data together, the C/A code of the input data in each block has to line up with the initial phase of C/A code in the first block. Time shift needed for each block of data can be computed as following:

$$T_D = \frac{f_D \times T}{f_L + f_D} \quad S_D = \exp(-j2\pi f_n \times T_D) \quad (2)$$

T_D is the time shift needed and f_D is the Doppler frequency. T is time delay between the initial time of the current data block and the initial time of the first block of integration. S_D is the frequency domain equivalent of T_D . f_n is the frequency of kernel function of the FFT. For easier Matlab implementation, this time shift is handled in the frequency domain. To obtain correlation result of a 1 ms data block, a circular correlation is performed. This is done by performing the inverse FFT of the product of S_D , the spectrum of the data block, and the stored complex conjugate of the C/A code spectrum. After 10 sets of circular correlation are performed, the results of the same time bin are coherently integrated through a 10-point FFT. There are 2728 10-point FFT results after this process. They form a 2728×10 time frequency spectrum matrix. This matrix covers the Doppler frequency range of ± 500 Hz. The detailed approaches have been discussed in a previous paper^[2]. In order to cover $\pm 500 + n \times 1000$ Hz, the input data have to be multiplied by $\exp(-j2\pi n 1000t)$. The result is then applied to FFT to get new spectrum and undergo the same process mentioned above. Another approach is to rotate the spectrum of input data left for n bins. In order to cover all possible Doppler frequencies, as many as 11 ($n = -5, -4, \dots, 0, \dots, 4, 5$) matrices have to be created. The result is a $2728 \times 10 \times 11$ matrix. However, if Doppler of satellite can be estimated through the ephemeris data from external sources, the size of the matrix can be greatly reduced.

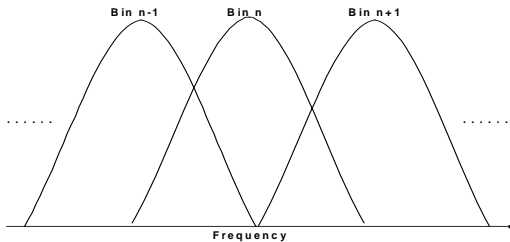

Figure 4. Filter shape for Fourier Transform based filter bands (or bins)

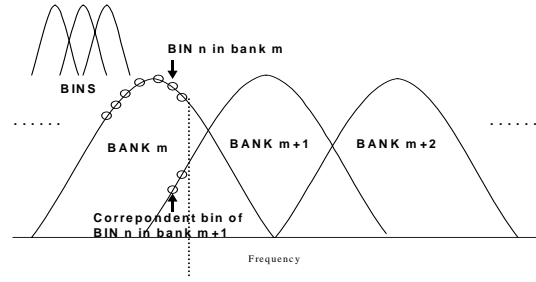

Figure 5. Definition of the correspondent bin

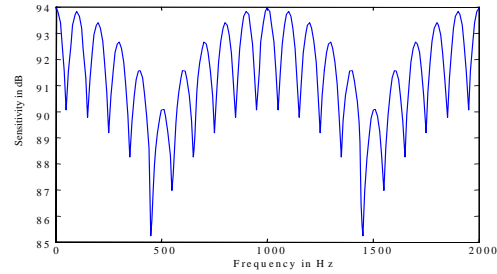

Figure 6. The sensitivity of the original matrix.

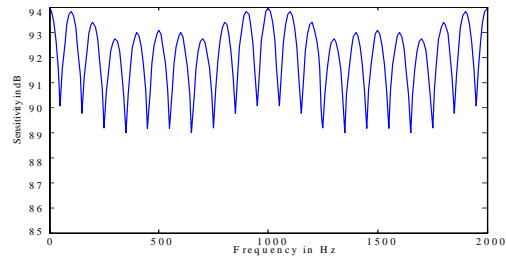

Figure 7. The sensitivity after the deficiency fix between bands

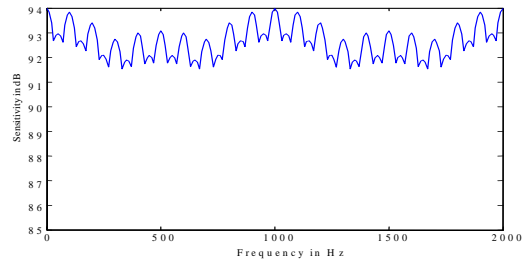

Figure 8 The sensitivity after all deficiency fix

There is one deficiency associated with the above approach and needs compensation techniques to overcome it. Lets use filter bands as a series of 1 KHz filters and use filter bins as a

series of 100 Hz filters. Figure 4 shows the filter shape for the Fourier transformation based filter bands (or bins). If a signal with the Doppler frequency falls between the frequency bins, the signal power will be split into two bins and phases of the components in two bins are almost inverted when integration length as large as 10 data points or more. The splitting of the signal into two separate bins leads to 3.92 dB sensitivity degradation. Figure 4 can also represent the filter shape between two 1 KHz bands. Therefore, the receiver will experience 3.92 dB loss if this Doppler frequency is between two 1kHz bands. As a result, if a signal's Doppler frequency happens to fall between frequency bins and between two 1kHz bands, the loss can be 7.84 dB. The combined result is shown in Figure 6.

Our software receiver uses an efficient way to reduce the loss between the 1kHz bands. This is achieved by creating a $2728 \times 10 \times 10$ time-frequency spectrum matrix. The matrix is obtained by computing the difference between the same two bins in filter bank m and $m+1$, scaled by a factor of 1.414. Figure 5 can be used to explain how this matrix is obtained. The first 5 bins of bank 1 and last 5 bins of bank 11 have no correspondent bins. They are ignored from now on. The scale factor is used to counter the increase of the noise power (3 dB) during the differencing operation. If the signal frequency falls between bands, the improvement of sensitivity is 3 dB using this new time-frequency spectrum matrix. But the sensitivity for signals with the frequencies at the center of the band will be reduced by 3 dB. This is if a signal frequency falls at the center of band m , then the signal level at band $m+1$ is near 0, resulting in no improvement in the differencing signal power. The noise power, however, will be increased by 3 dB during the differencing operation. Therefore, the signal to noise ration will be degraded by 3dB. In order to avoid this 3 dB loss, the differencing and scaling operation is only applied to the 5 bins that falls between two adjacent bands of the original spectrum matrix. Figure 7 shows the result obtained from the matrix created in this way.

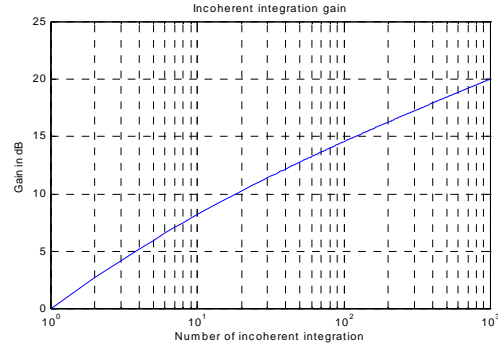

Figure 9. Gain improvement verse Non-coherent integration number

In our implementation, No second matrix is created. We only use the above principle to modify all 5 bins falling between bands in the original matrix.

In order to reduce the loss between bins, a new modified $2728 \times 10 \times 10$ time-frequency spectrum matrix is created by subtracting each bin with its' adjacent bin and scaling with 1.414. Now we have two $2728 \times 10 \times 10$ time frequency spectrum matrix waiting for following 10-ms coherent integration result to non-coherently add on. After all required integrations, the maximum of two matrices are detected and its' time and frequency are selected as initial phase of C/A code and coarse Doppler frequency which has accuracy within ± 50 Hz. Figure 8 shows the result of the sensitivity improvement combining two matrix. The number of non-coherent integration is determined based on the desired sensitivity of the receiver. Figure 9 is used to determine the number^[6].

Because we want to use one second coherent integration for weak signal tracking, the Doppler frequency has to be accurate within ± 0.5 Hz. Since the initial phase of the C/A code and coarse carrier frequency have been determined, the carrier frequency of data in each block can be down converted to ± 50 Hz. The C/A code of the signal can be stripped off by multiplying the down-converted signal with local reference C/A code. One block of data can be integrated into one point. After one second, 1000 integrated data can be obtained. By performing FFT on the squared integrated data, we can achieve Doppler frequency accuracy of within ± 0.5 Hz. To begin weak signal tracking, we also need to determine the initial phase of navigation code. The

algorithm to find the initial phase of navigation code has been discussed in a previous paper^[3].

LOW DYNAMIC AND HIGH SENSITIVITY C/A CODE AND FREQUENCY TRACKING

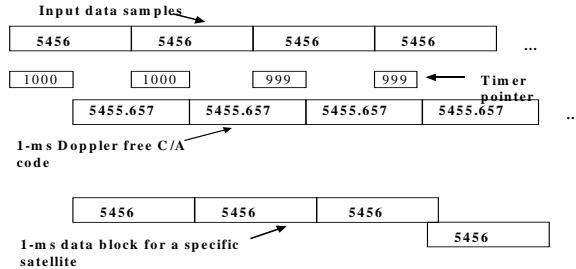

Figure 10. Satellite specific data block for tracking

In order to maintain the phase continuity of the carrier, 5456 points of data have to be read in continuously. There is a pointer and a mismatch accumulator associated with each satellite signal. Assuming there is no Doppler shift, and the initial phase of the C/A code of a satellite in the signal is 1000 points off from the beginning of the first data block. The pointer is pointing at 1000. This is shown in Figure 10. The mismatch between 1 period of code length in the signal and the data block is 0.343 sample. After two blocks, the mismatch is 0.686 which is greater than 0.5 point. The pointer is updated to 999 which is the closest integer point to the real initial phase of code in the signal and the mismatch accumulator is updated to -0.314 . Let's also look at a different scenario. The initial phase of the C/A code of a satellite in the signal is 1 point off the beginning of the first data block and the pointer update is needed. The pointer is supposed to be updated to 0, but there is no 0 point in the block. Under this circumstance, the pointer is updated to 5456 and the pointer is tracking the initial phase of C/A code of the following period. In the program, the pointer and the mismatch accumulator are constantly updated to maintain the mismatch between the timer pointer and the real initial phase of code in the signal to within ± 0.5 point. The mismatch due to Doppler is important in this process and can not be ignored because the mismatch update is an accumulative process. Every second a 5456-point digitized Doppler free C/A code with a proper initial phase offset is generated as local reference to 'perfectly' strip off C/A code in the signal in the following second. As shown in Figure 11, the

initial phase offset is defined as the offset between the initial phase of C/A code and the first sample of data in the data block. The initial phase offset measurement will be discussed later.

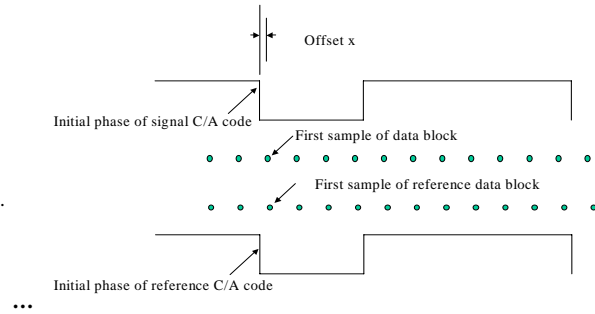

Figure 11. Definition of offset

The high sensitivity tracking algorithm uses 1-second coherent integration. The integration starts at the initial phase of any navigation bit. Each millisecond, the data is read in and multiplied by a locally generated C/A code and a locally generated complex IF carrier signal (within 1 Hz accuracy). The multiplication results are added together to generate one complex data point. Twenty 1-ms data are added together to generate one navigation data. The algorithm to decode the weak navigation data has been discussed in a previous paper^[4]. After the navigation data is decoded, the navigation data are multiplied with the navigation code and then added to produce 1-second coherent integration result. The amplitude of the 1-second coherent integration is called the 1-second prompt gate result. The same procedure can be used to produce early and late gate results. The early gate result is generated by using C/A code in the signal that is one sample ahead of the locally generated C/A code reference, while the late gate result uses the signal that is one sample later.

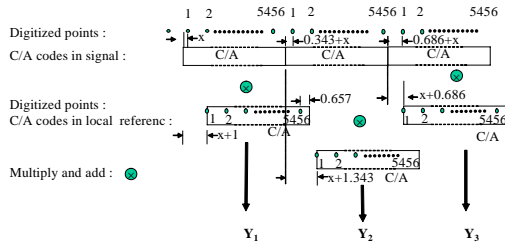

Figure 12 Late gate satellite data and C/A reference alignment.

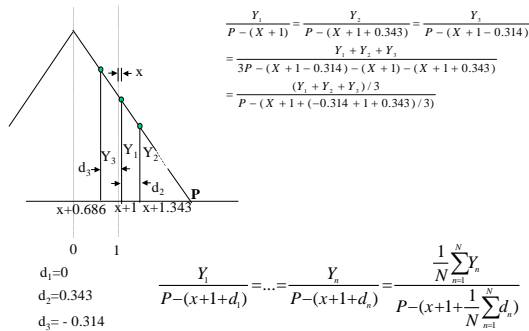

Figure 13 Late gate results from figure 12 in correlation function

For the ease of illustration, the local reference is generated without offset in Figure 12. Figure 13 shows the late gate results of the first three milliseconds on the correlation triangle. They are located around $1+x$ and based on the mismatches, d 's, which we have discussed before. The averaged late gate correlation result is $(Y1+Y2+Y3)/3$ at $x+1+(-0.314+0+0.343)/3$. From this figure, we can derive the 1000-point averaged late gate result and its' location as

$$Y_{al} = \frac{1}{1000} \sum_{n=1}^{1000} Y_n \text{ at } 1+x + \frac{1}{1000} \sum_{n=1}^N d_n \quad (3)$$

if we denote

$$X_a = x + \frac{1}{1000} \sum_{n=1}^N d_n \quad (4)$$

The point (X_a+1, Y_{al}) is still on the right side of the triangle. By the same approach, we can derive that the early gate result will be (X_a-1, Y_{ae}) and also on the right side of the triangle. Therefore, X_a can be calculated by using following method^[5].

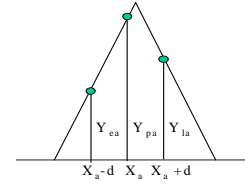

Figure 14. Correlation function and early, prompt, and late gate

$$r \equiv \frac{Y_{al}}{Y_{ae}} = \frac{1 - X_a - d}{1 + X_a - d} \quad (5)$$

$$X_a = \frac{(1 - r)(1 - d)}{1 + r}$$

Here Y_{ae} and Y_{al} are the 1-sec early and late gates respectively and d and X_a are in unit of chip. For our case, d is equal to $183.3/977.5$. After calculation, X_a has to be converted back to unit of sample. The C/A code initial phase offset x can be derived from

$$x = X_a - \frac{1}{1000} \sum_{n=1}^{1000} d_n \quad (\text{in unit of sample}) \quad (6)$$

This offset is important for the pseudo range calculation and the generation of C/A code reference for the next second of data. This completes the C/A code tracking process.

In frequency domain, a 50-point FFT are applied to the navigation-code-stripped complex navigation data as mentioned above. By comparing the amplitude of the peak and the amplitude of its two neighbor frequency bins, the frequency offset can be calculated^[4]. The frequency of the peak and frequency offset are added to the IF carrier frequency to generate the locally generated IF carrier signal for next second. This completes the frequency tracking process.

TRACKING PERFORMANCE EVALUATION

8 Seconds of Simulated data were used to evaluate the tracking performance. At each C/N_0 , 100 runs with different noise distributions are performed. The results are listed in Table 1. The software receiver can track the C/A code and frequency but navigation code starts appear error after $C/N_0 < 24\text{dB}$. Since the number of runs is rather small, it is difficult to draw a firm conclusion.

Table 1 Tracking performance

C/N ₀ (dB)	Mean error(ns)	Standard deviation(ns)
25	-1.1	14
24	-2.1	16
23	-2.9	18
22	-7.5	20
21	-6.5	22
20	-3.2	27
19	1.3	30
18	4.3	35

CONCLUSION

This software receiver has demonstrated a 10dB sensitivity improvement for stationary receivers. This means that in a very weak signal environment, it can acquire satellite C/A code and carrier frequency and smoothly transfer from acquisition mode into tracking mode. This receiver is not limited to weak signal environment. With very minor software code changes, a phase lock loop can be implemented for strong signals under high dynamic conditions. This receiver with the carrier phase tracking loop can track 2 minutes of a hardware simulator generated data with GPS receiver on an airplane pulling 8 G S-turn at the speed of 400m/s. The details of the high-dynamic application are beyond the scope of this paper.

REFERENCE

- (1) DAVID M LIN and JAMES B.Y. TSUI “Direct P(Y)-Code Acquisition Algorithm for Software GPS Receivers”, Proceedings of ION GPS 99” September 14-17, 1999, Part 1, pp. 363-368
- (2) DAVID M LIN and JAMES B.Y. TSUI “Acquisition Schemes for Software GPS Receiver”, Proceedings of ION GPS 98” September 15-18, 1998, Part 1, pp. 317-326
- (3) DAVID M LIN and JAMES B. Y. TSUI “ A Software Receiver for Weak Signals”, IEEE International Microwave Symposium, May 20-25, 2001,
- (4) DAVID M LIN and JAMES B.Y. TSUI “A Weak Signal Tracking Technique for a Stand-Alone Software GPS Receiver”, Proceedings of ION GPS 02” September 24-27, 2002
- (5) JAMES B. Y. TSUI “ Fundamentals of Global Positioning System Receivers”, John Wiley & Sons, INC, pp 182-183
- (6) Lin, D. M., Tsui, J. B. Y., Liou, L., and Morton, Y. T., “Sensitivity limit of a stand-alone GPS receiver”, Proceedings of 2002 ION GPS conference, Portland, Oregon, Sept. 2002.