

NASA TECHNICAL NOTE

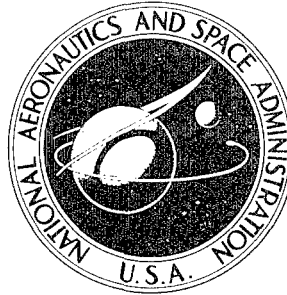

NASA TN D-3194

NASA TN D-3194

AMPTIAC

DISTRIBUTION STATEMENT A  
Approved for Public Release  
Distribution Unlimited

# MANNED MARS LANDING MISSIONS USING ELECTRIC PROPULSION

*by John S. MacKay, Charles L. Zola, Leonard G. Rossa,  
Laurence H. Fishbach, William C. Strack, and Frank J. Hrach*

*Lewis Research Center  
Cleveland, Ohio*

**20060516163**

MANNED MARS LANDING MISSIONS USING ELECTRIC PROPULSION

By John S. MacKay, Charles L. Zola, Leonard G. Rossa,  
Laurence H. Fishbach, William C. Strack, and Frank J. Hrach

Lewis Research Center  
Cleveland, Ohio

NATIONAL AERONAUTICS AND SPACE ADMINISTRATION

---

For sale by the Clearinghouse for Federal Scientific and Technical Information  
Springfield, Virginia 22151 - Price \$2.00

# MANNED MARS LANDING MISSIONS USING ELECTRIC PROPULSION

by John S. MacKay, Charles L. Zola, Leonard G. Rossa, Laurence H. Fishbach,  
William C. Strack, and Frank J. Hrach

Lewis Research Center

## SUMMARY

Estimates of initial mass required in low Earth orbit to land four men of a seven-man crew on Mars are presented for a variety of mission profiles. The exploration time is 40 days, while the mission time is varied between 400 and 700 days. The initial mass is used as the main criterion of merit and is presented as a function of mission time. Payload estimates include weight allowances for shielding the crew against solar flares, cosmic rays, and the Earth's inner Van Allen belt.

Of the various mission profiles studied, it appears essential that an initial high-altitude rendezvous maneuver be used prior to Earth escape in order to avoid a slow manned traversal of the inner Van Allen belt. This procedure reduces the required crew shield weight, and also shortens the time that the crew is away from Earth. Atmospheric braking at Earth return can also give a large weight saving, particularly for the higher entry velocities.

A profile with atmospheric braking at Earth return coupled with unmanned traversal of the Van Allen belts was used for several sensitivity studies. These studies show that the ability of the crew to recover from a given radiation dose is as important as the maximum allowable dose. Rapid weight increases were also noted as a result of changes in specific impulse at high values of powerplant specific mass or reductions in power below the optimum design value. As part of the sensitivity study the thruster efficiency is varied for constant thrust. Also, a comparison is made with the ideal variable thrust. A study of these results shows that most of the weight penalty associated with constant-thrust operation is due to thruster inefficiency rather than the inability to vary the thrust.

Finally, a comparison is made between the all-electric rocket system and two alternative systems. One of these systems is a typical high-thrust nuclear-rocket system. The other is a combined system that uses high-thrust chemical or nuclear rockets to depart Earth and an electric rocket for the rest of the mission. This comparison shows that a combined system of a nuclear rocket to assist an electric system that requires 7 kilograms per kilowatt of power is superior to both the all-nuclear and all-electric systems over the entire range of mission times studied. Also, a comparison of the power and mass requirements for the combined system shows that the electric portion could also serve as an all-electric system at a longer mission time.

## INTRODUCTION

In order to evaluate the utility of electric propulsion for space missions, it is necessary to determine the performance capabilities for many different missions and to compare these results with similar ones for other systems. Of the various missions to be considered, the exploration of Mars is perhaps the most interesting. Although it may be expected that electric propulsion is better suited to more difficult missions such as a journey to Pluto, many studies have been made of the Mars mission for other propulsion systems (refs. 1 and 2), which makes it a convenient reference point for the systems comparisons.

In mission analyses for high-thrust systems, such as those presented in reference 1, it has been made clear that a wide range of mission-profile variations are possible and warrant investigation; it is also pointed out that manned missions may require shield weights that are a large part of the mission payload. These same statements will also be equally true for electric-propulsion systems. Unfortunately, similar studies for electric propulsion could be very difficult if the trajectory work is to be of the same caliber as current nuclear-rocket studies. Three-dimensional, numerical integration would be required preferably using the calculus of variations for thrust-vector orientation. The time and complexity associated with such calculations would severely limit the scope of a mission analysis, particularly for constant thrust and specific impulse. Thus low-thrust mission studies have tended to cover a limited number of mission profiles in an effort to gain comparable detail. References 3 to 5 are excellent examples of existing low-thrust mission studies.

Recent trajectory simplifications, introduced in reference 6, allow low-thrust trajectories to be computed as rapidly as the high-thrust solutions, and a reasonable degree of accuracy was obtained for preliminary calculations (about 5 percent or less error in estimating the final to initial mass ratio  $M_f/M_0$  based on numerous comparisons with numerically integrated trajectories). Reference 4 contains some preliminary results using this method. Consequently, it was possible to make a relatively broad survey of various mission-profile changes and other interesting modifications within a reasonable span of time. This report, then, contains the results of such a survey for the manned Mars mission and is intended both to present preliminary results and to indicate interesting areas for future, more precise calculations.

The main criterion of performance used in this work is the initial mass of the vehicle in a low, circular Earth orbit. Although this may not be the best single criterion, it is at least a tangible one that is relatively easy to calculate. A study of initial gross weights can define future booster requirements and, to some degree, the cost of the mission.

In general, the initial-mass estimates are presented as a function of the mission time, which is varied between 300 and 700 days. The various mission profiles investi-

gated include atmospheric braking possibilities at Earth return, initial rendezvous with the vehicle beyond the Van Allen belts, and sending propellant, supplies, and equipment ahead for exploration and the return trip. A perturbation of various inputs is also made in which the thruster performance, specific powerplant mass, Mars parking orbit radius, allowable crew dosage, and other factors are varied. Finally, a fairly consistent comparison is made of the all-electric system of the present analysis, the high-thrust nuclear rocket system, and a combined system that uses the previous two in different parts of the mission. In order to facilitate the comparisons between alternative systems, many of the design inputs have been taken directly from reference 2, which is a more detailed study of nuclear rocket systems. Consequently, a more complete description of such subsystems as atmospheric entry vehicles and life support is given in reference 2.

## ANALYSIS

For this study, the vehicle mass is subdivided as follows:

$$M_o = M_{pl} + M_{pp} + M_{th} + M_p \quad (1)$$

where

$M_o$  initial vehicle mass

$M_{pl}$  payload mass

$M_{pp}$  powerplant mass

$M_{th}$  thruster mass

$M_p$  propellant mass

The payload mass is considered to consist of two parts: (1) the Earth return payload and (2) the Mars exploration payload.

The powerplant mass is assumed to consist of the equipment necessary to generate and convert the electric power into a condition suitable for consumption by the thrusters. For simplicity, this mass is assumed to be directly proportional to the generated power. The constant of proportionality, the specific powerplant mass, is treated as a parameter in the calculations. A nominal value of 7 kilograms per kilowatt is used for most of this work.

The thruster mass is estimated by assuming that it is directly proportional to the thruster beam exit area. The constant of proportionality is assumed to be equal to 300 kilograms per square meter unless otherwise specified. The details of computing

the thruster exit area are more complex and are discussed in greater detail in the section Electric Thrusters.

Finally, the estimation of propellant mass is closely associated with the trajectory calculations and is expanded in the section Trajectory Methods. As indicated previously, the approximation method of reference 6 will be used almost exclusively. In addition, these computations will generally neglect the ellipticity of both Earth and Mars as well as the inclination of the Martian orbit to the ecliptic plane.

## Earth Return Payload

This segment of the vehicle, defined as that part of the total payload actually returned to the vicinity of Earth, includes

- (1) Biological shield mass
- (2) Crew cabin structure and fixed life-support equipment
- (3) Atmospheric entry vehicle, if any

Biological shielding. - In some cases, a large fraction of the Earth return payload consists of the protective shielding needed for the crew. This will depend, in part, on the size and frequency assumed for solar flares, the shield material used, the dose tolerance allowed per crew member, and the size of the crew. Similar to reference 1, a crew of seven is chosen, and a statistical analysis is made of the occurrence of two types of large solar flares. One large flare type, the "envelope" flare of reference 7, includes all the adverse features of past large solar flares. The second type is half the intensity of the envelope flare, referred to herein as the half-envelope flare. If one envelope flare is assumed to occur on the average of once every 4 years and a half-envelope flare to occur every year, the statistical analysis gives the frequency schedule shown in

TABLE I. - ASSUMED FREQUENCY OF  
SOLAR FLARES (1.0 PERCENT RISK  
OF EXCEEDING EACH TYPE)

Exposure time, days	Flare	
	Half-envelope, 1/yr	Envelope, 1/4 yr
160 to 210	2	1
210 to 300	2	2
300 to 462	3	2
462 to 630	4	2
630 to 654	4	3
654 to 800	5	3

table I. The risk of exceeding the given numbers of each type of flare is 1 percent.

The maximum number of flares indicated in the table are assumed to be distributed along the mission trajectory as follows:

(1) The first of the envelope flares is assumed to occur at the mission perihelion with the flare intensity varying inversely as the square of the heliocentric radius. The second flare of this type is assumed to occur just prior to the terminal propulsive phase and the third just before Mars departure at 1.5 astronomical units.

(2) One half-envelope flare erupts at the

mission perihelion with three others occurring during the coast and waiting phases at a distance of 1 astronomical unit. Additional flares are equally distributed in time along the trajectory.

For mission times less than the maximum considered in table I, the flares are included in the order mentioned in (1) and (2) preceding until all the flares for that particular mission time are used up. Note that the assumption of flare occurrences at mission perihelion with an inverse-square amplification is a conservative assumption due to the small likelihood of such a chain of events.

In addition to the solar-flare environment, it is also necessary to choose an accurate model for the inner Van Allen belt for electric-propulsion missions. This model, taken from reference 8, assumes the Frieden and White spectrum (ref. 9) to apply throughout the belt and presents a simplified method of evaluating the dose accumulated during low-thrust spirals through the belts.

The final natural radiation source assumed is a fixed, unshieldable 1.4 rems per week resulting from cosmic rays plus low-level solar activity (refs. 7 and 10). For both the Van Allen belt and solar flare radiations, the shield computation scheme is that described in reference 11. This method accounts for the production of both secondary neutrons and protons in a variety of basic materials. The electric-rocket propellant, mercury, can be used as a shield. The shielding properties are then assumed to be duplicated by tungsten. Either polyethylene or a chemical propellant combination such as diborane ( $B_2H_6$ ) plus oxygen fluoride ( $OF_2$ ) can be used for shielding, and the shielding properties of both are assumed to be those of water.

The usual method of computing the radiation dose is to sum up the doses from the various sources without regard to the rate at which the dose is accumulated from each source. As suggested in reference 12, however, only 22 percent of the incident radiation is accumulated in this nonrecoverable fashion. The remainder of the radiation may be reduced exponentially with a half-time of 25 days. This recovery phenomenon has been assumed herein along with a maximum equivalent acute dose of 100 rems per crew member. This limit is obtained from examination of reference 13 but is later varied as part of a general sensitivity study.

Crew cabin volume. - Figure 1 (p. 6) shows the location of the crew cabin relative to the nuclear reactor. A separation distance of 300 feet has been estimated as sufficient to reduce the dose rate from this source to a negligible level. Figure 2 (p. 6) shows a typical design for the crew cabin. The upper part is a storage area for such items as the Earth entry and Mars landing vehicles, which must be detached during the mission. Below this storage volume is a total enclosed volume of 5600 cubic feet ( $800 \text{ ft}^3/\text{man}$ ), which is divided into a living volume of 5150 cubic feet and a solar flare shelter of 450 cubic feet ( $50 \text{ ft}^3/\text{man}$  plus  $100 \text{ ft}^3$  for equipment). In the particular design shown in figure 2, it is also possible to slide part of the basic flare protection up to the ceiling of the

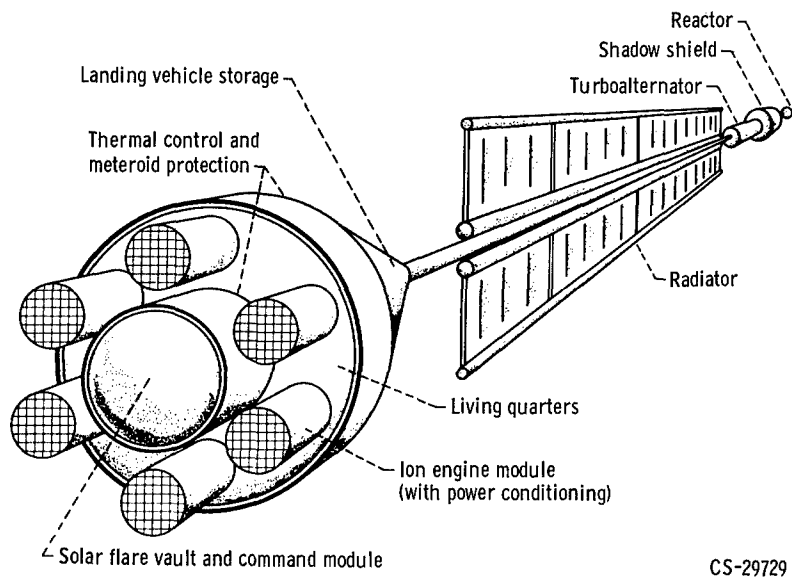

Figure 1. - Conceptual design of electric-propulsion system for manned Mars mission.

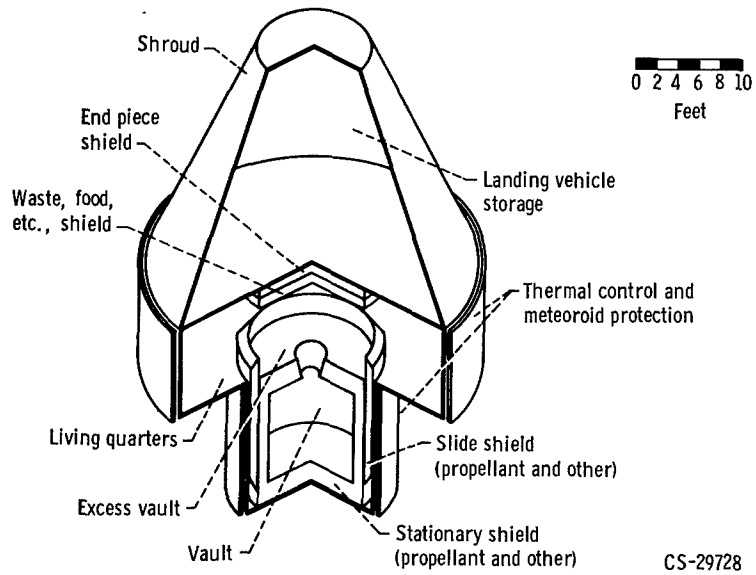

Figure 2. - Typical crew-cabin living-quarters configuration for seven-man Mars mission.



living quarters to form an additional 550 cubic feet for the long-duration spirals through the Van Allen belts. This is a possible unique feature of a low-thrust cabin design not required in typical high-thrust designs.

The outer wall of the living volume is assumed to have a shielding density of 3 grams per square centimeter of aluminum, which is sufficient, according to reference 7, to reduce effects of daily and monthly solar-flare activity to about 20 rems per year.

Life-support equipment. - Mass estimates for this system are based on a closed water and open air supply system. In addition to the fixed mass at 1600 kilograms, there are also major time-variant masses based on 0.95 kilogram of oxygen and 1.05 kilograms of food per man per day. All these assumptions (plus air leakage and other time-dependent weights) lead to the expression for the life support system weight

$$W_{LS} = 1600 + 21T_M \text{ kg} \quad (2)$$

where  $T_M$  is the total mission time in days. In order to reprocess the total water supply (11 kg/man/day) an additional power requirement of 260 watts per man is needed. The total mass of the crew cabin including only the fixed mass of the life-support system is 12 000 kilograms.

Earth entry vehicles. - In some of the mission profiles to be investigated, it will be assumed that the entire crew enters the Earth's atmosphere at the end of the mission in a separate vehicle. Mass estimates for such vehicles are shown in figure 3 as a function of entry velocity. For more details on the design philosophy used, the reader is referred to reference 2.

## Mars Payload

In this analysis, the Mars payload is that part of the vehicle left at Mars for the exploration maneuver. Consequently, weight estimates for this part of the vehicle will depend on the detailed operations to be carried out during the 40-day exploration period. In general, four members of the crew will descend to the surface of Mars, while the other

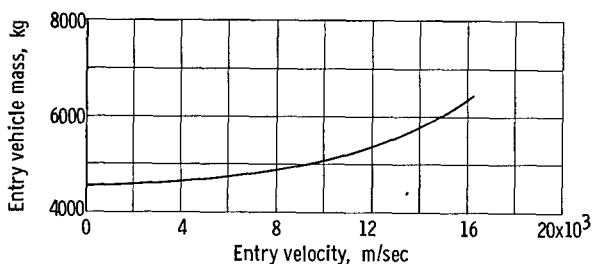

Figure 3. - Estimated Earth atmospheric entry vehicle mass for seven-man crew.

three will remain in the vehicle to be joined later. Specifically, this goal may be accomplished in a number of different ways (as indicated in ref. 2). However, only one representative sequence of operations will be chosen for use here.

Main spacecraft orbit. - Perhaps one of the first considerations is the choice of the

main spacecraft orbit around Mars. Methods for computing maneuvers into and out of elliptic parking orbits have not been worked out in great detail for electric-propulsion systems. Consequently, a circular parking orbit is assumed with the orbit altitude left open for consideration. A low-orbit height would use up valuable time during the spiral maneuvers that may increase the heliocentric propellant requirements due to shortened time for such maneuvers. At the other extreme, the orbit height should not be so high as to have a period of revolution greater than the stay time of 40 days. As a compromise, an orbit with a period of 10 days (27 Mars radii) is chosen as a nominal value. Later, as part of a sensitivity analysis, this altitude will be varied and its effect more completely discussed.

Landing operations. - Once the main vehicle is established in a parking orbit around Mars, the following landing sequence is assumed to occur:

(1) An unmanned tanker vehicle is transferred down to a circular orbit at 1.10 Mars radii.

(2) Two unmanned equipment landers that use a combination of propulsive and atmospheric braking are sent to the surface.

(3) Two manned landers are brought to the surface, as in (2).

The purpose of the tanker vehicle is to avoid bringing all the propellant required for the return transfer to the surface.

Mars takeoff. - The first part of the trajectory is assumed to follow a zero-angle-of-attack path until the drag becomes a small fraction of the thrust. This maneuver is designed to circumvent aerodynamic load problems. From this low drag point onward, thrust control is determined by the calculus of variations with atmospheric effects neglected and no intermediate coasting allowed. (Typical trajectories are given in ref. 14.) The final goal of the takeoff trajectory is the tanker vehicle orbit at 1.10 Mars radii. After rendezvous with the tanker, the tanker propellant is transferred to the manned craft, and an orbit transfer is made to join with the main spacecraft prior to Mars departure. The total mass of the Mars exploration system (i. e., the mass left at Mars) is 44 000 kilograms.

## Electric Thrusters

Thruster performance can have a strong influence on system weight through its efficiency, which may vary considerably with specific impulse. Fortunately, a significant amount of experimental performance data are available (ref. 15) in this area so that a current technology can be identified. Also, sufficient information exists to make crude estimates of the thruster weight (ref. 16).

Performance. - The performance characteristics assumed for a nominal thruster are shown in figure 4. The quantities shown are related through the equation

$$\eta = \frac{\eta_u}{1 + \frac{2 \left( \frac{eV}{\text{ion}} \right) \eta_u^2 \left( \frac{q}{m} \right)}{(I \times 9.80665)^2}}$$

where

- $\eta$  thruster efficiency
- $\eta_u$  fraction of propellant ionized
- eV/ion energy required to produce a singly charged ion, V
- q/m charge-to-mass ratio of ions, C/kg
- I specific impulse, sec

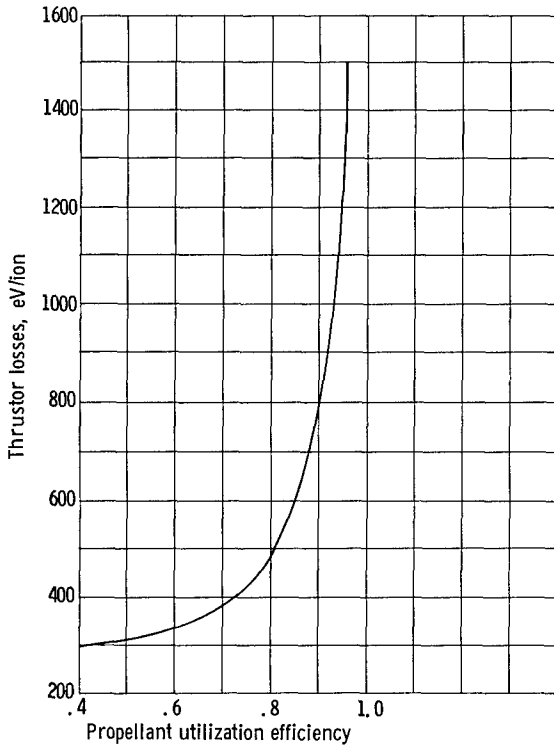

(a) Thruster losses (discharge only).

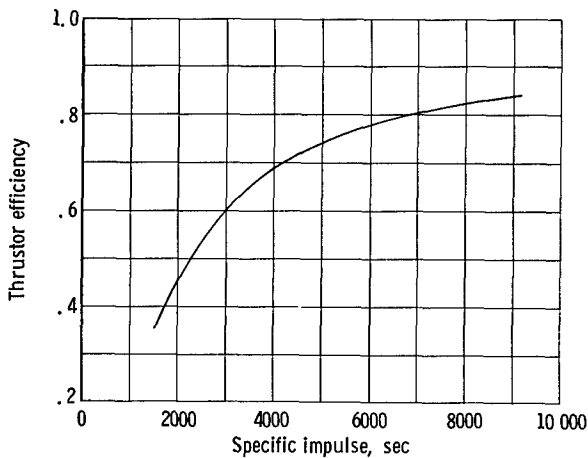

(b) Maximum thruster efficiency.

Figure 4. - Thruster performance characteristics for mercury electron-bombardment thruster.

These particular curves are based on a modified version of current electron-bombardment-thruster performance that uses mercury propellant. Specifically, some of the losses in the current thruster, which will probably be significantly reduced, were removed completely in order to estimate the advanced loss curve for this type of thruster, as shown in figure 4(a). Figure 4(b) then follows from 4(a) after the propellant utilization efficiency is optimized. (In general, propellant utilization efficiency should be chosen to minimize initial mass, but this leads to little improvement over the results with data such as shown in fig. 4(b).) Each point that constitutes figure 4 must be thought of as a special thruster designed for maximum overall efficiency at the indicated specific impulse.

Propellants. - As indicated in reference 15, it is possible to use propellants other than mercury for the nominal thruster. Experimental data have shown that cesium may also be used to give nearly the same performance as mercury (fig. 4(b)). Thus the choice between these two propellants must be made on other grounds such as possible use as a radiation shield, ease of storing and handling, etc. For simplicity, mercury was used as the propellant throughout this report.

Weight. - A simple estimate of the thruster weight is made by assuming a constant weight per unit of exit or beam area. For the nominal thruster, 300 kilograms per square meter is used. The weight then follows directly from an accompanying estimate of the exit area. It is assumed herein, as in reference 16, that the thruster current density is limited by the charge-exchange phenomenon for a given grid lifetime. As indicated in reference 16, this may not be the only contributor to current-density limits, but at least it allows a direct calculation of the required exit area for a given thrust and grid lifetime.

## Trajectory Methods

The long propulsion periods associated with electric propulsion make it desirable to schedule the thrust vector with the aid of variational methods. As a result a considerable propellant saving is possible. Unfortunately, this method is time consuming and would restrict the scope of this analysis if adhered to rigidly. As a compromise, a certain degree of approximation has been allowed in order to investigate other aspects of this mission.

The first approximation made is to treat what is actually a multibody problem as a series of two-body problems. This approach is a rather common assumption that is almost identical with the sphere-of-influence method used in high-thrust analysis. The basic difference here is that the planetocentric phase of the trajectory is terminated at escape energy rather than at the sphere of influence. For some of the higher accelerations, escape energy is reached some distance inside the sphere of influence. For these conditions, the time it would take to coast to the sphere of influence is neglected. If the calculation is not done in this fashion, it is advantageous to continue propulsion to the correct radius and account for the additional velocity accumulated in the initial conditions of the heliocentric phase. Thus, the calculations, as performed, contain a certain amount of conservatism.

Throughout this analysis, the planet Mars is assumed to be in a circular orbit around the sun. The effect of this assumption is shown in figure 5 where the 1979-1980 synodic period is chosen for comparison with the circular-orbit results. These data are obtained by first-order correction of exact calculus-of-variation solutions in two dimensions between circular orbits. As indicated, a decrease in final mass of about 5 percent

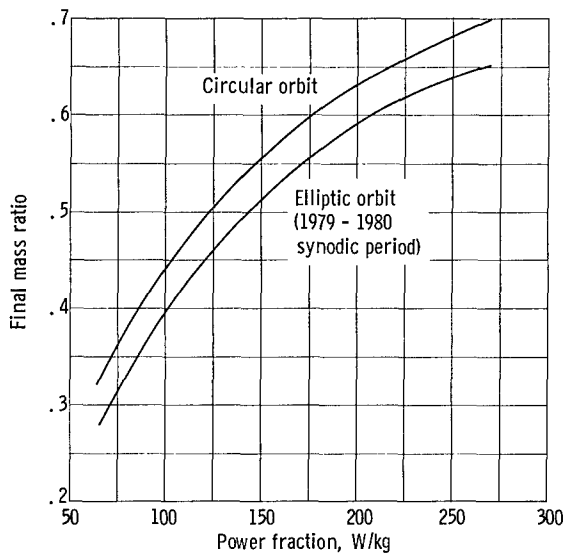

Figure 5. - Noncircular orbit effects on typical round-trip mass ratios. Mission time, 420 days (including four spiral maneuvers); wait time, 30 days (no exploration assumed).

of the initial mass would result for this synodic period.

Planetocentric phase. - A low-acceleration trajectory during this phase is assumed to be propelled by a constant, tangentially directed thrust. This type of path differs only slightly from the best possible, even when variable thrust is allowed. The method used is similar to the semiempirical scheme recommended in reference 17.

Heliocentric phase. - The heliocentric trajectory computation is made by using the approximate method of reference 6. This method systematically increases the high-thrust  $\Delta V$  to account for the low initial acceleration. The computation, therefore, is performed at the speed of the high-thrust solution.

As shown in reference 6, this method is accurate for orbiter-type trajectories to Mars, the error being about 5 percent of the initial mass.

Most doubtful at this time are the accuracies of the planet approach velocity and perihelion radius values as taken unchanged from the companion high-thrust solution. A comparison of high- and low-thrust trajectory-perihelion radii shows the high-thrust values (used herein) to be lower, which results in higher radiation dosages at this point than actually would exist. No detailed check has yet been made on the corresponding planet approach velocities.

In some of the system comparisons made near the end of this study, it was necessary to evaluate the performance of an electric rocket with a high-thrust stage for Earth escape. In order to calculate this effect properly, the previously described procedure was modified to account for the initial velocity at the sphere of influence. The amount of high-thrust  $\Delta V$  was then chosen on the basis of minimum initial mass in Earth orbit.

## Vehicle Design Optimization

For each of the mission profiles considered, total power, specific impulse, Earth-Mars travel time and travel angle, and propellant utilization efficiency were all varied to achieve minimum initial mass in Earth orbit. In the special case of high-thrust boost away from Earth, the velocity at the sphere of influence (hyperbolic velocity) was also varied, as indicated previously.

## RESULTS AND DISCUSSION

The computational results of this study will be presented, as indicated earlier, primarily in the form of initial mass required in low Earth orbit for a variety of different mission times and mission profiles. This constitutes the main part of this presentation and is preceded by a discussion of the considerations that were given to the choice of a nominal mission profile. Later, a sensitivity study is discussed that was made to test the effects of changing some of the basic assumptions made in the section ANALYSIS. Finally, a comparison is made of the all-nuclear, all-electric, and a combined system for a typical mission profile.

### Mission-Profile Variations

One of the most important aims of this study is to indicate the relative advantages of different methods of accomplishing the mission (mission profiles) with electric propulsion. This discussion includes examination of such techniques as atmospheric braking at Earth return and sending propellant and supplies ahead needed for exploration of Mars and the return journey, which have been studied in conjunction with high-thrust systems. Also included are special procedures to avoid the Van Allen belt radiation hazard. This is not to imply that all conceivable profiles will be studied. Rather, a limited number of those profiles possible are studied with a view toward locating those that give a large initial mass saving. Whenever possible, the areas of risk associated with the different

profiles are noted and discussed.

Nominal mission profile. - A mission profile of the type usually considered for electric-propulsion systems is shown in figure 6. Here the mission begins in a polar circular orbit at 1.10 Earth radii and spirals out to escape energy with constant, tangentially directed thrust. (A polar orbit helps reduce the time spent in the main portions of the Earth's Van Allen radiation belts.) After completion of the Earth escape maneuver, the vehicle continues operating at constant thrust and performs an optimum transfer to the vicinity of Mars. During this portion of the

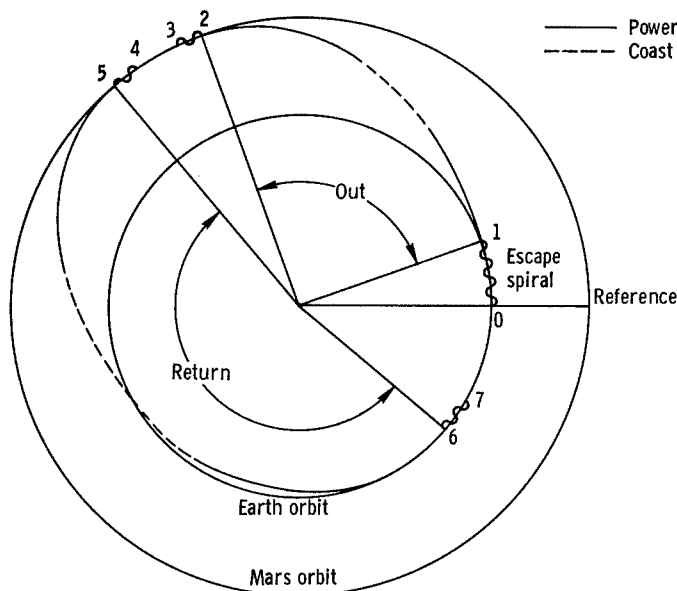

Figure 6. - Nominal mission profile for manned Mars mission using electric propulsion.

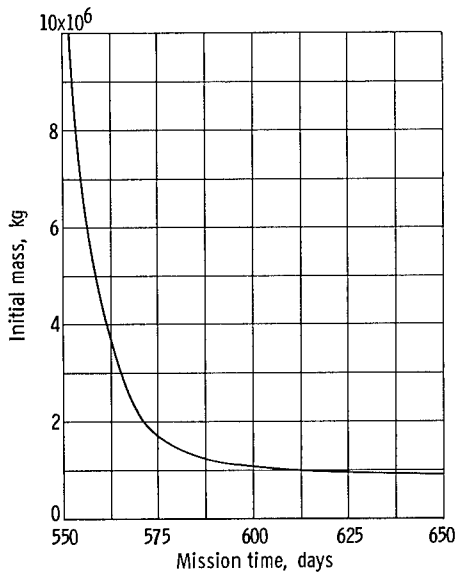

Figure 7. - Initial mass using nominal mission profile. Seven-man Mars mission; wait time, 40 days; specific powerplant mass, 7 kilograms per kilowatt.

trip, the thrust angle is directed to minimize propellant consumption. Also, the thrust is turned off and on to allow for an optimum intermediate coast phase whenever advantageous. The vehicle then spirals down to a circular parking orbit at 27 Mars radii from which the previously described landing and exploration are performed. After the 40-day stay has ended, a return trip to Earth is made, which proceeds very much like the departure transfer in reverse with the exception that flight is terminated at 3.0 Earth radii just outside the Van Allen belt. The crew is then picked up by another craft that arrives from Earth. Thus, no special Earth atmospheric entry vehicle needs to be carried throughout the mission.

The initial mass required to perform the mission with the nominal profile just described is shown in figure 7 as a function of the total mission time.

From this figure it is possible, apparently, to achieve initial masses as low as 900 000 kilograms at a mission time of about 650 days. Shorter trips are, of course, possible, but the mass tends to increase very rapidly as the time is reduced.

Propellant shielding. - As shown in reference 8, an electric-propulsion system with an initial thrust acceleration of  $1 \times 10^{-3}$  meter per second squared and a shield thickness equal to 100 grams per square centimeter of aluminum could accumulate 60 rems while traversing the inner proton belt. This result also assumes the use of a polar orbit as was done in the nominal profile just described. Also, if the crew were confined during the entire traversal, they would spend a total time of about 30 days in restricted quarters. Thus, the Van Allen belts can represent a severe hazard, particularly if it is assumed that no recovery from radiation dose is possible.

In order to study the importance of the Van Allen belt radiation, the vehicle for the nominal profile has been redesigned to surround the crew with the mercury propellant on board. This second vehicle concept is compared with the nominal design in figure 8(a) (p. 14). As indicated, the initial mass is reduced almost by a factor of 2 relative to the nominal profile.

Although the method of propellant shielding shown in figure 8(a) is very effective, it will be pointed out later that more sophisticated profiles (e.g., those that use atmospheric braking at Earth return) give much lower initial propellant mass values. In these cases, propellant shielding will, of course, be much less effective.

Unmanned belt traversal. - A second modification of the nominal profile is a high-altitude rendezvous performed at the start of the mission. This procedure requires that

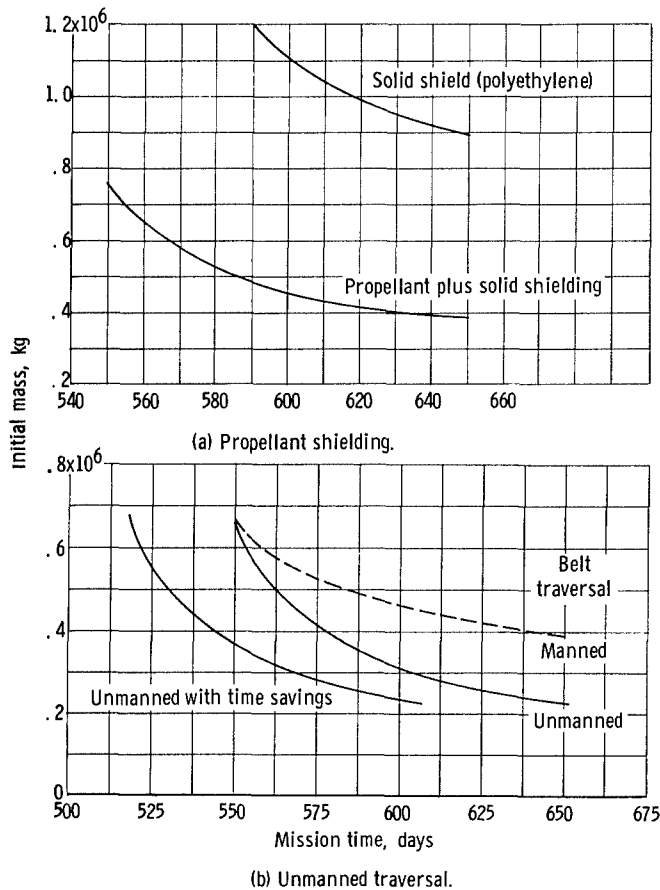

Figure 8. - Comparison of various methods of reducing Van Allen belt radiation. Wait time, 40 days; specific powerplant mass, 7 kilograms per kilowatt.

the vehicle make an unmanned trip through the belts during which time the crew may still be on Earth. After the vehicle has reached the outer edge of the radiation belts, the crew is transferred by a faster high-thrust trajectory maneuver in a small shuttle vehicle (this may, indeed, be the same vehicle that returns them to Earth at the end of their journey). The saving in initial mass associated with this profile modification is displayed in figure 8(b) as a function of mission time. The upper solid curve includes the unmanned vehicle spiral time in the total mission time. Even with this inclusion, a considerable saving relative to the dashed curve is possible at the longer mission times. At the shorter times, the curves for manned and unmanned missions join because the shorter times require simultaneously higher initial thrust acceleration and more mercury propellant. As a result, the belt traversal time is lowered, which

reduces the accumulated dose and also gives sufficient propellant for shielding the crew.

The mission time for the upper two curves includes the Earth escape propulsion time. Actually, the mission time could be defined as the time the crew spends away from Earth. Thus, the unmanned belt traversal does not need to be included in the mission time, as shown by the lowest curve in figure 8.

On the basis of these results, the additional complication of an initial rendezvous, with the latter definition of mission time, seems worthwhile and will be included in all further mission-profile changes where applicable.

**Perihelion placement.** - The preceding discussion introduced the possibility of propellant protection of the crew from radiation. In the section ANALYSIS, it was assumed that a large flare would occur as the vehicle passed through the mission perihelion. It was also assumed that the intensity of the flare would vary inversely as the square of the distance from the sun. Thus, it would be helpful to have a considerable amount of propellant on board at the time of perihelion passage. This can be arranged by choosing a round-trip trajectory that passes through the perihelion during the Earth-to-Mars part of



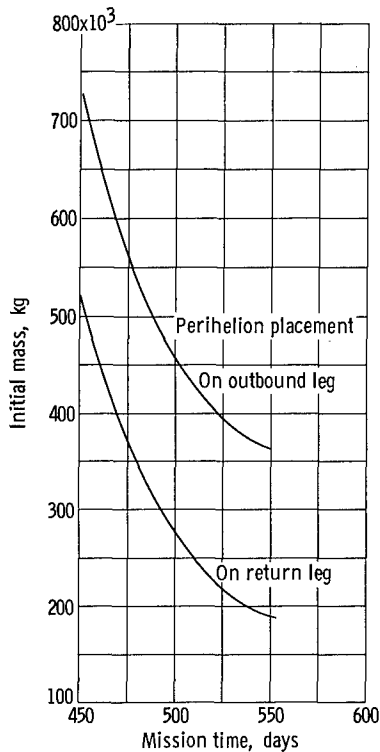

Figure 9. - Comparison of perihelion placement technique. Seven-man Mars mission; wait time 40 days; specific powerplant mass, 4 kilograms per kilowatt.

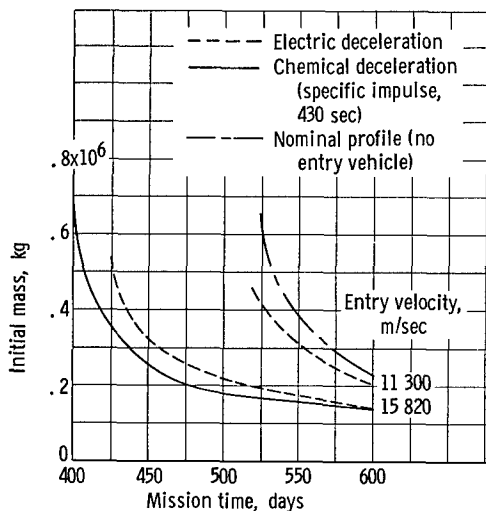

Figure 10. - Effect of atmospheric braking. Seven-man Mars mission; wait time, 40 days; specific powerplant mass, 7 kilograms per kilowatt; unmanned belt traversal.

the journey rather than on the return leg when the propellant weight is lower. However, there is an increase in overall propellant fraction associated with this placement of the perihelion that may or may not balance the reduction in fixed (nonpropellant) crew shield mass. This propellant increase is the result of the high propulsive effort (usually associated with the low perihelion transfer leg) placed on the outbound leg where both the Mars landing system and Earth return payload are accelerated toward Mars. The net effect of both these changes (in propellant and shielding) on initial mass is illustrated in figure 9, where it can be seen that there is a disadvantage of about 175 000 kilograms to placing the perihelion on the outbound phase of the 550-day round trip. Similar disadvantages also are apparent for the shorter times. Thus, the mission perihelion will be placed on the return leg in all subsequent profiles.

Atmospheric braking. - A common modification of mission profiles is to introduce atmospheric braking maneuvers at Earth return. In this study, two different levels of atmospheric braking have been investigated. The first level is 11 300 meters per second, which corresponds to entry from parabolic energy relative to Earth, and the second level is 15 820 meters per second, which corresponds to twice the local circular velocity. Higher entry velocities were not considered because they would then equal or exceed present practical estimates (ref. 18) of the limiting entry velocity. These entry velocities are maintained by the application of propulsion with either the electric system, applied to the whole vehicle, or by an additional chemical-rocket system applied to the entry vehicle only. This is necessary only when the approach velocity exceeds the desired velocity. For all missions, the propellant required is used as a radiation shield for the crew earlier in the mission.

The two atmospheric braking levels are compared with the nominal profile in figure 10. Generally, it is clear that increased amounts of atmospheric braking are helpful. It should be recalled, however, that the nominal profile uses no entry vehicle. Thus sufficient braking must be done in order to compensate for the additional weight of the atmospheric entry vehicle. This explains the small gain over the nominal profile at an atmospheric braking level of 11 300 meters per second.

Since some of the deceleration must be aided with propulsion, it is informative to ask whether the chemical system or the electric system (or a combination of these two) should be used. The amount of braking desired is the determining factor. For example, at entry from 11 300 meters per second, the chemical system (not shown) requires far too much propellant relative to the electric system. For higher speed braking, the chemical system ( $I = 430$  sec) yields lower initial masses. Part of this gain results from the fact that only the entry vehicle and not the command module needs to be decelerated. Also, the chemical braking system has the unique feature that the propellant required for deceleration occasionally exceeds that needed for radiation protection. Therefore, the dose to the crew is less than 100 rem. (This area is not indicated in fig. 10 because the entry velocities were not sufficiently accurate to give the precise boundaries to the region.) For electric system braking the dose is always 100 rems because the propellant on board approaches zero near the end of the mission, just as a terminal flare is assumed to occur. For the chemical system, the propellant is retained almost until Earth perigee encounter.

Two-phase missions. - The next feature to be added to the mission profile involves sending ahead to Mars various amounts of material including equipment needed at Mars and/or the propellant needed for the return trip. This is done to avoid sending the stated materials to Mars on the relatively short, high-propellant-fraction Earth-to-Mars transfer associated with the manned vehicle. If a separate, unmanned vehicle is used, a much longer transfer time can be used that has a lower propellant fraction.

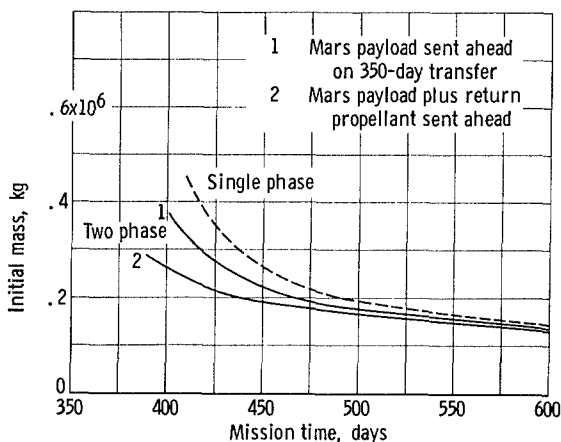

Figure 11. - Comparison of one- and two-phase mission profiles. Seven-man Mars mission; wait time, 40 days; specific powerplant mass, 7 kilograms per kilowatt; unmanned belt traversal; Earth atmospheric entry velocity, 15 820 meters per second.

System weights for such cases are shown in figure 11 with all profiles using atmospheric braking from 15 820 meters per second. In one case, only the Mars payload is sent ahead by a 350-day flight with the same specific powerplant weight and the best travel angle for the chosen time. In the second case, both the Mars payload and the return propellant are sent ahead on a similar one-way transfer.

Although the second case gives the best performance, it is also more hazardous. If only the Mars payload is sent ahead, the ex-

ploration can always be abandoned if the equipment is faulty. The first method can, therefore, be an effective way of reducing initial mass at short trip times. On the other hand, this technique does not seem worth the added complexity of the separate system for the longer trip times.

## Sensitivity Analysis

In addition to the study of various profiles, it is important also to determine how sensitive the resultant mass estimates are to the various assumptions described in the section ANALYSIS. This will be done by covering a representative range in the parameter under investigation and presenting the results, for the most part, as a function of mission time.

Thrustor assumptions. - Up to this point, only the nominal performance for constant thrust and specific impulse has been considered, using the thrustor performance curves given in figure 4 (p. 9). In order to illustrate the effect of changes in thrustor performance, the thrustor is first assumed to be 100 percent efficient and is then allowed to have variable thrust magnitude and constant jet power. Both of the changes are shown separately in figure 12. (Note that these results differ from the preceding data in wait time and initial orbit radius, 48 days and 1.0471 Earth radii, respectively, to be consistent with the variable-thrust-trajectory data taken from ref. 5. For this same reason it was also necessary to revert to the mission profile without atmospheric braking (fig. 10).) The upper curve contains the nominal thrustor results, whereas the middle curve uses constant thrust with the ideal thrustor efficiency. The figure indicated a 25-percent reduction in initial mass at 700 days and reduces the minimum mission time by about 100 days. (Nominal thrustor efficiency, fig. 4(b), varies from 77 percent at 550 days to 82 percent at 700 days.)

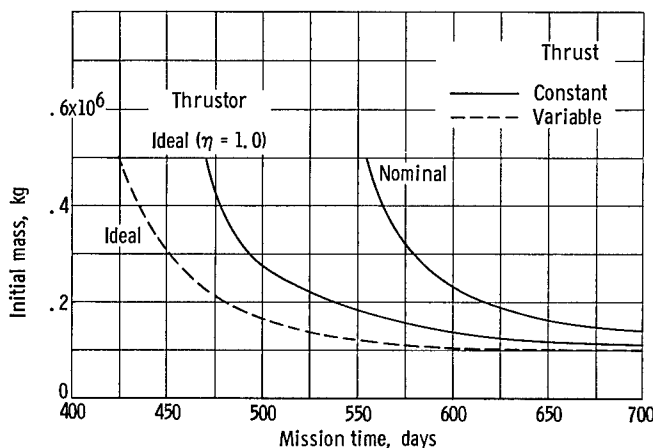

Figure 12. - Effect of thrustor type and efficiency. Wait time, 48 days; specific powerplant mass, 7 kilograms per kilowatt; unmanned belt traversal.

For the lowest curve, a variable-thrust operation in addition to the 100-percent efficiency is assumed. Here, the performance advantage at the longer mission time is almost negligible. For the shorter missions, however, there is a considerable reduction in the mission time at a given initial mass by about 50 days or half that due to thrustor-efficiency improvements. This may also be interpreted as a large initial mass saving at fixed mission time, which approaches

infinity as the mission time is reduced.

It appears, therefore, that a major portion of possible initial mass saving can be achieved by improving the efficiency of existing constant-thrust rockets as opposed to incorporating variable-thrust features. However, it may be easier to use several different thrusters in steps to approximate the variable thrust than to improve the thruster efficiency at any specific impulse.

Radiation protection. - Perhaps one of the most uncertain aspects of an analysis of this type is the entire area of biological radiation protection requirements. In this analysis, it is most convenient to vary the maximum equivalent acute dose and the rate of recovery from the effects of a given dose. As pointed out in the section ANALYSIS, a nominal value of 100 rems was chosen for the maximum equivalent acute dose to the crew members. Increased protection (e.g., a lower dose) will, in general, require some increase in the crew cabin mass. The effect of this increase in cabin mass is shown in figure 13 for a typical mission profile that bypasses the Van Allen belts at the start of the mission with a high-altitude rendezvous and uses all on-board propellants as a crew shield. In general, there is not a large change due to lowered dose limit until about 50 rems are used. At this level and for a mission time of 600 days, there is an increase of about 14 percent in the required initial mass over the nominal mission profile. Also, shorter mission times have a less severe increase because fewer flares are assumed to

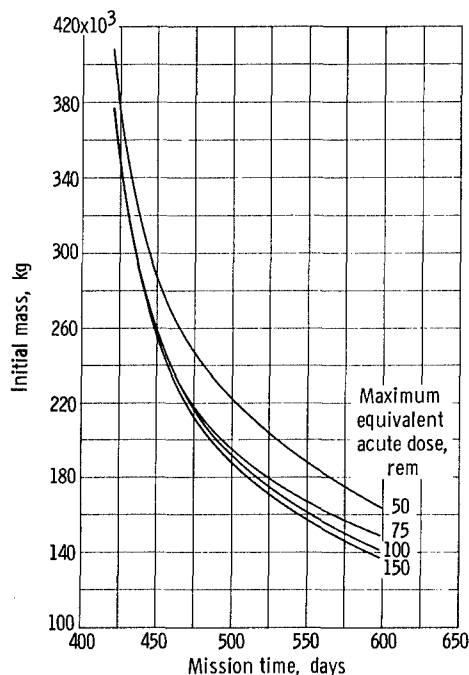

Figure 13. - Effect of maximum allowable dose on initial mass. Wait time, 40 days; specific powerplant mass, 7 kilograms per kilowatt; Earth atmospheric entry velocity, 15 820 meters per second.

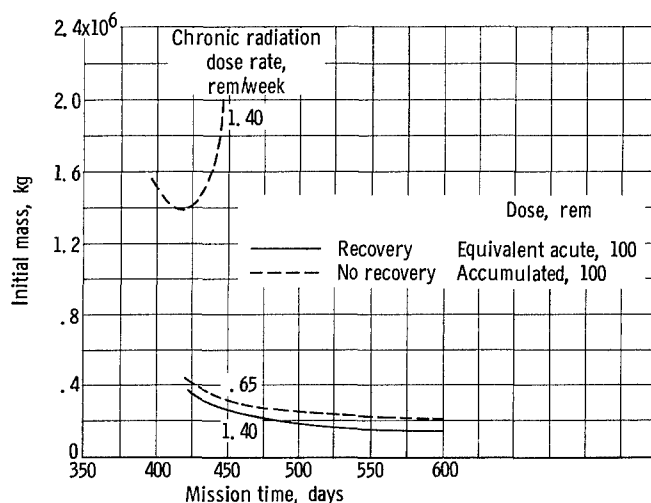

Figure 14. - Effect of dose recovery on initial mass for 100-rem maximum equivalent acute or accumulated dose. Wait time, 40 days; specific powerplant mass, 7 kilograms per kilowatt; Earth atmospheric entry velocity, 15 820 meters per second.

occur, and much more mercury propellant is available for shielding.

In order to measure the effect of the rate of recovery from a given dose, the extreme case of no recovery has been computed and is compared with the nominal results in figure 14. This calculation shows a threefold or fourfold increase in initial mass due to no recovery resulting from the continual buildup of the assumed chronic dose at 1.4 rems per week. At this rate, the total dose of 100 rems is accumulated in 500 days. Thus, the upper curve has a vertical asymptote at 500 days due to the increasing weight of the solar-flare shelter. Since part of the chronic dose, 20 rems per year, is due to low-level solar activity, it may be possible to eliminate this part of the chronic dose by a moderate increase in the wall thickness of the living quarters. Then only the cosmic ray dose rate, which is estimated in reference 10 as 0.65 rem per week, is left unshielded. This is the case shown by the lower dashed curve in figure 14 labeled 0.65 rems per week, which assumes a doubled-wall thickness of 6 grams per square centimeter in the living quarters only (about 5000 kg extra mass). Almost all the previous increases can possibly be eliminated by special design procedures; however, there still remains a significant increase over the nominal mission, amounting to about 43 percent at 600 days.

In general, then, it appears that the weight penalties associated with lower values of

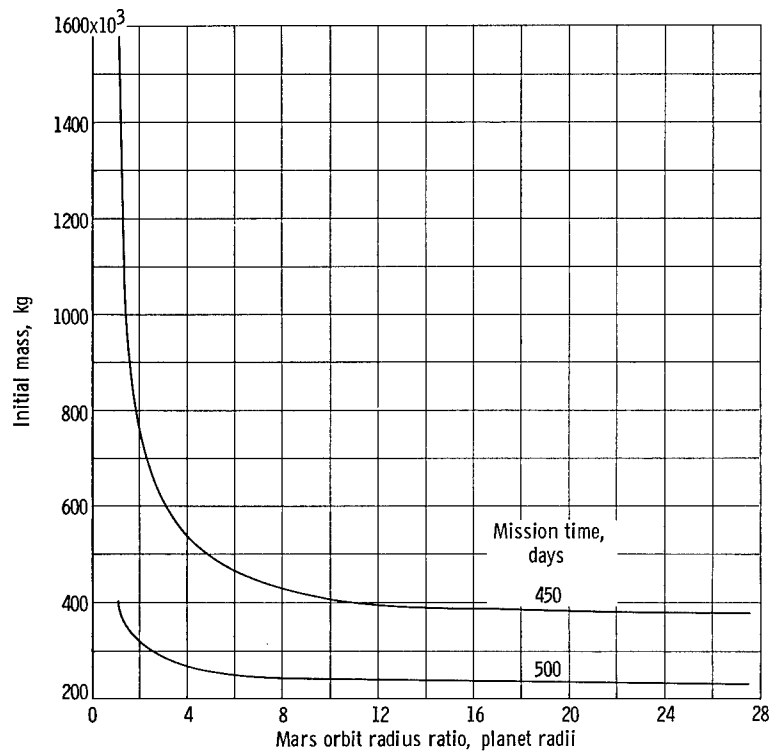

Figure 15. - Effect of Mars orbit radius on initial mass. Wait time, 40 days; specific powerplant mass, 7 kilograms per kilowatt; Earth atmospheric entry velocity, 15 820 meters per second.

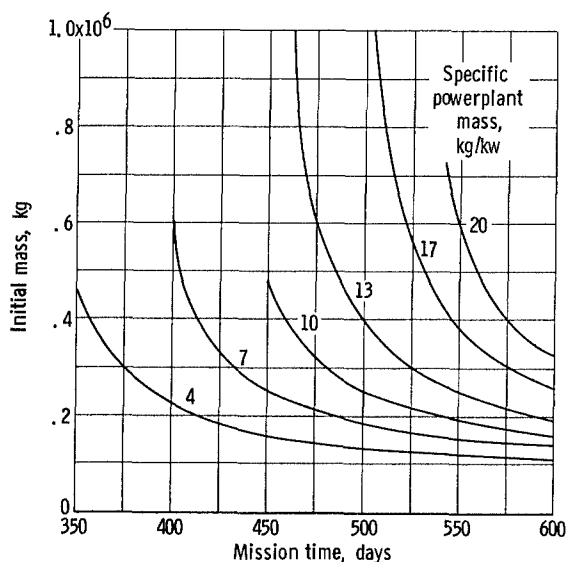

Figure 16. - Effect of specific powerplant mass. Wait time, 40 days; unmanned belt traversal; chemical plus electric braking, to 15 820 meters per second.

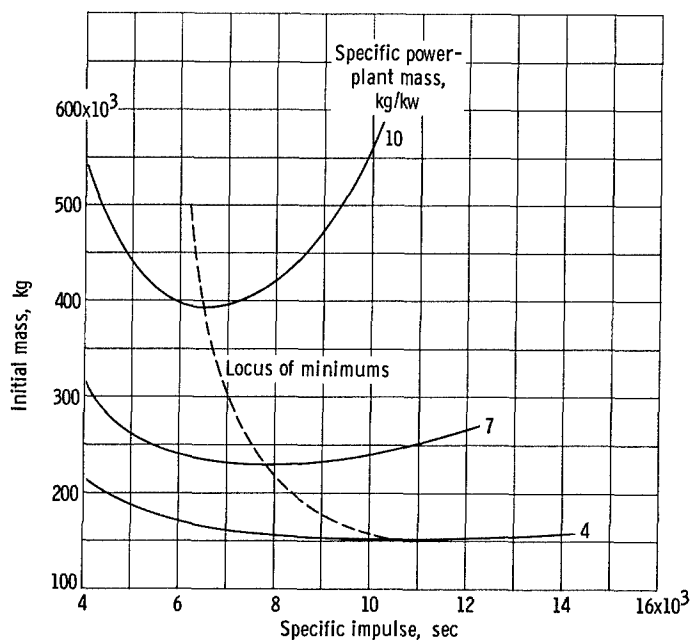

Figure 17. - Effect of specific impulse on initial mass. Mission time, 500 days; wait time, 40 days; Earth atmospheric entry velocity, 15 820 meters per second.

dose level are not large provided that some recovery is possible. If not, then threefold or fourfold increases in initial mass may be required unless special design modifications are made to reduce the chronic radiation dosage.

Mars orbit radius. - As pointed out in the section ANALYSIS, a compromise radius of 27 planet radii was chosen for the Mars circular parking orbit based mainly on the assumption that low parking-orbit radii would cause a large increase in the propellant consumption for the heliocentric portion of the mission. This is true, as indicated in figure 15 (p. 19), but only for the shorter mission times. For the longer mission times, the orbit radius could be lowered to perhaps 8 to 10 planet radii before any large increase in initial mass would occur.

Variation of specific powerplant mass. - No study of electric-propulsion systems is complete without consideration of one of its major unknowns - specific powerplant mass. The nominal value of 7 kilograms per kilowatt used here is based on current estimates (ref. 19) that range between 4 and 20 kilograms per kilowatt; however, it must be recalled that such systems have never been built.

Figure 16 shows how the relation of initial mass to mission time is affected by specific powerplant mass. At the very long mission times, around 600 days, the impact of this parameter on initial mass is relatively small but becomes exceedingly important as the

mission time is reduced.

Specific-impulse variations. - In all the data displayed so far, the thruster specific impulse was chosen to minimize initial mass. In some cases, it may not be desirable to operate at this optimum value of specific impulse. For example, reliable thrusters may not be available at that particular value. Also, high specific impulses may increase the mass of the power-conditioning system. Thus, it is of interest to examine the effect of specific impulse on initial mass, as shown in figure 17. As indicated in the figure, the shape of the curves depends strongly on specific powerplant mass. For example, there is a very sharp minimum for an  $\alpha$  of 10 kilograms per kilowatt and, on the other hand, a very flat minimum at  $\alpha$  equal to 4 kilograms per kilowatt. The sharp minimum at  $\alpha = 10$  may be attributed to the marginal performance associated with the high value of powerplant mass; that is, there is apparently a relatively small region in the specific-impulse spectrum over which positive payload ratios exist.

Figure 17 illustrates the effect of specific impulse on initial mass at assumed constant values for specific powerplant mass, however, and also may be used to include the additional effect of specific impulse on powerplant weight. Of course, knowledge of  $\alpha$  as a function of  $I$  would be required, which is beyond the scope of this report.

Total power variations. - In most cases of practical interest, it will be necessary to operate at some total power other than that computed as optimum for the chosen mission. Rarely will the power level available be precisely mated to the mission demands. The effect of operation at off-design power levels is shown in figure 18 (p. 22) for a total mission time of 450 days. This figure shows that the penalty paid for off-design power operation is unsymmetrical. For example, an increase in power of 30 percent causes an increase in initial mass of only 6 percent. In contrast, this same percentage increase in initial mass could have been caused by a decrease in power of only 11 percent. This behavior results because of the inclusion of such realistic effects as thruster mass and efficiency. Under more ideal assumptions, the values of payload and power vanish simultaneously. As shown in figure 18, however, the value of payload vanishes prior to that of power as indicated in the sketch in figure 18. Thus, it is evident that two solutions are possible at any given power and payload. In general, the sensitivity to off-design operation is not symmetrical and can be very serious if the power is much below the optimal value.

## Comparison with Other Systems

One method of avoiding the long-duration spiral and the associated Van Allen belt hazard is to accomplish the Earth escape phase with a high-thrust stage added to the basic electric system. Use of a nuclear rocket for this purpose corresponds to the com-

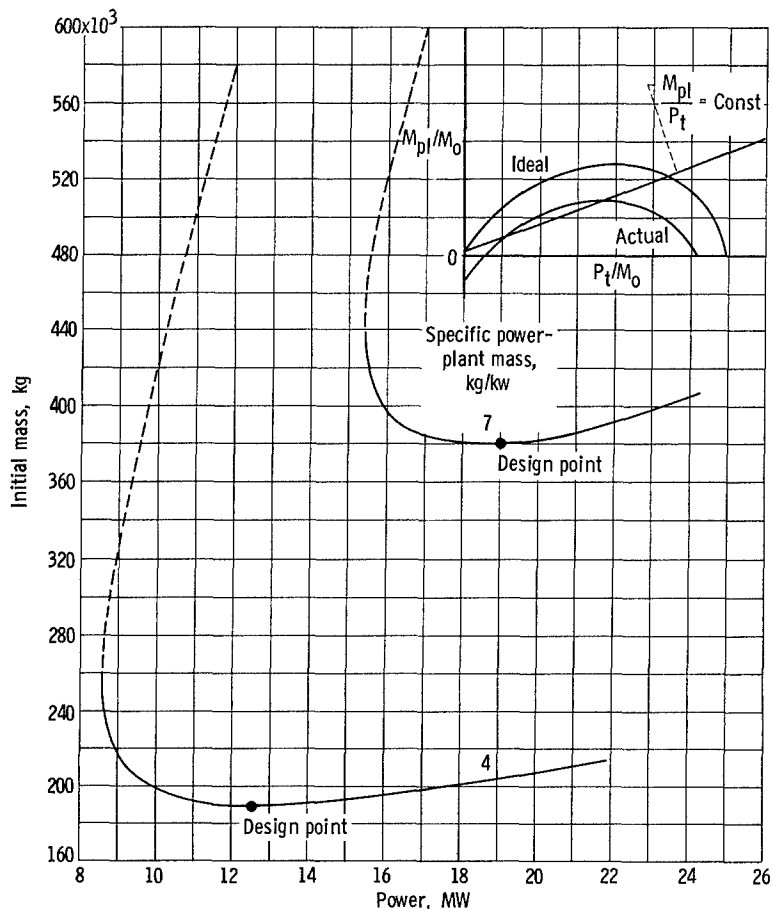

Figure 18. - Effect of off-design power variations. Seven-man Mars mission; mission time, 450 days; wait time, 40 days; Earth atmospheric entry velocity, 15 820 meters per second.

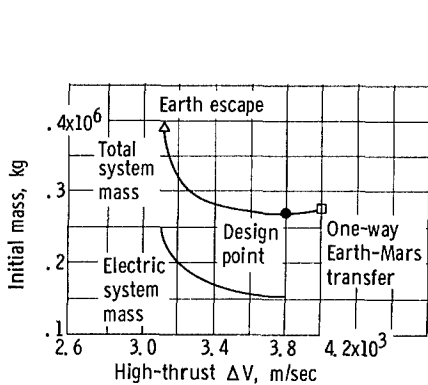

Figure 19. - Effect of high-thrust propulsion on combined system mass. Mission time, 400 days; wait time 40 days; specific power-plant mass, 7 kilograms per kilowatt; Earth atmospheric entry velocity, 15 820 meters per second; high-thrust specific impulse, 850 seconds.

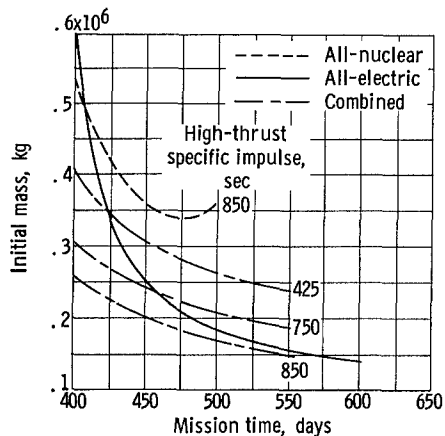

Figure 20. - Comparison of all-nuclear, all-electric, and combined systems. Wait time, 40 days; specific powerplant mass, 7 kilograms per kilowatt; Earth atmospheric entry velocity, 15 820 meters per second.



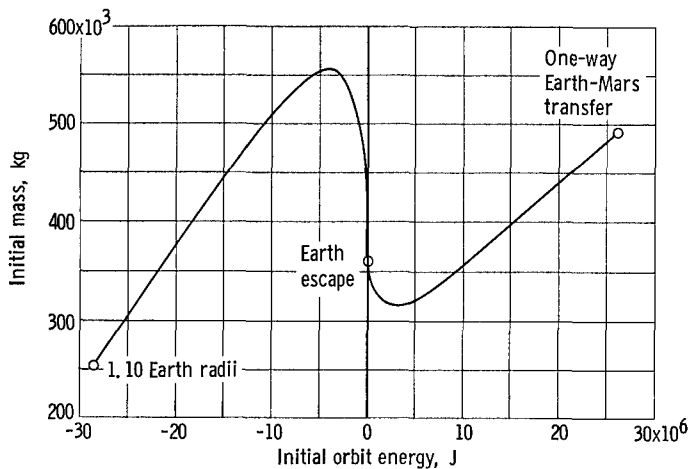

Figure 21. - Nature of optimums obtained with initial high-thrust assist. Mission time, 450 days; wait time, 40 days; specific powerplant mass, 7 kilograms per kilowatt; Earth atmospheric entry velocity, 15 820 meters per second; specific impulse, 425 seconds.

bined high- and low-thrust system studied in references 20 and 21. For this type of vehicle, the optimum amount of high-thrust assist is determined, as shown in figure 19, for the mission time of 400 days. Also shown is the separate mass of the electric-rocket portion. The remaining propulsive phases (Mars arrival and departure) are then supplied by the electric rocket. Typical initial masses for a system of this type are shown in figure 20. Also shown are the all-electric system discussed previously and an all-

nuclear system (taken from ref. 2) all for the same type of mission profile and an  $\alpha$  of 7 kilograms per kilowatt.

A comparison of the three systems (for  $I = 850$  sec) shows that the combined system gives lower weights over the entire range of mission times considered with a much larger advantage at the shorter mission times. Beyond about 450 days, however, there does not appear to be a sufficient weight saving to warrant the complication of an added nuclear stage. Below 400 days, the all-nuclear system surpasses the electric system, which, however, occurs in an area of great superiority for the combined system over both competing systems.

Figure 20 also shows combined system performances for other values of high-thrust specific impulse. The lower level of 425 seconds is included here to show that initial boost with chemical systems may be of interest for short mission times. In general, at lower specific impulse there exists a point of intersection beyond which the all-electric system shows superior performance. The minimized combined system masses computed beyond the intersection are local minimums associated only with boosting to energies above escape, as shown clearly in figure 21. Here, the high-thrust system is also used to increase the initial orbit radius while the total mission time is held fixed at 450 days. This figure reflects the characteristic maximum associated with high-thrust orbit transfers to large radius ratios. The all-electric point is shown at the far left and, for certain conditions, becomes less than the zero slope minimum beyond the escape point. Consequently, there is an abrupt transition in the curves for minimum initial mass from the combined system to the all-electric system. A less sharp transition may be possible by consideration of a high-thrust transfer to initial elliptic orbits. This situation has not been considered here, but it is not expected to alter significantly the results shown.

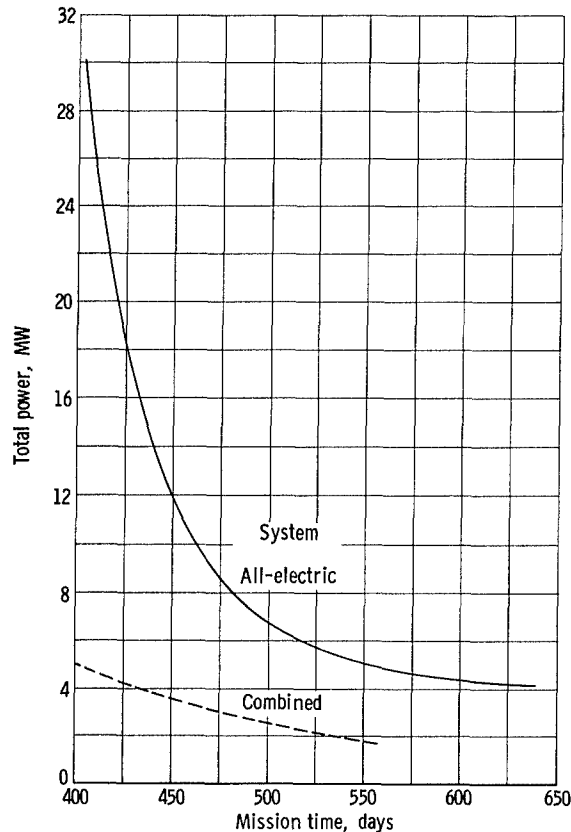

Figure 22. - Comparison of total power required for all-electric and combined systems. Seven-man Mars mission; wait time, 40 days; specific powerplant mass, 7 kilograms per kilowatt; Earth atmospheric entry velocity, 15 820 meters per second; nuclear rocket specific impulse, 850 seconds.

In addition to the weight saving shown for the combined system, there are also the associated reductions in power requirements shown in figure 22. For a typical mission ( $T_M = 550$  days) a reduction in power from 5 to 1.8 megawatts is shown with an even larger saving possible at the shorter mission times. Also, it can be seen that the power required for the 400-day combined system is just that needed to make the 550-day all-electric mission. Furthermore, figure 19 indicates that the initial mass of the electric part of the combined system is also equal to that for the 550-day all-electric system. A more detailed comparison of these two electric systems is given in table II, where it is shown that the mass and power requirements are nearly identical. It can also be seen, however, that the short propulsion time available to the hybrid vehicle leads to a lower specific impulse thruster system.

Thus it appears at least initially feasible to develop a 5-megawatt all-electric system that may accomplish the manned Mars mission in either 550 or 400 days, depending on the availability of a nuclear-rocket stage to perform the Earth escape phase of the mission.

TABLE II. - COMPARISON OF ELECTRIC SYSTEMS FOR 400-DAY HYBRID AND 550-DAY ALL-ELECTRIC MISSIONS

[Wait time, 40 days; specific powerplant mass, 7 kilograms per kilowatt; Earth atmospheric entry speed, 15 820 meters per second.]

System	Hybrid	All-electric
Mission time, days	400	550
Initial mass, kg	157 032	164 190
Supplies, kg	8 200	12 300
Powerplant mass, kg	36 800	37 600
Propellant mass, kg	39 500	40 600
Thruster mass, kg	2 870	2 640
Thruster structure, kg	287	264
Propellant tank, kg	395	406
Mars payload, kg	44 000	44 000
Earth entry vehicle, kg	6 280	6 280
Shield mass, kg	6 700	8 100
Cabin and life support, kg	12 000	12 000
Power, MW	5.27	5.38
Thrust, N	128.5	107.5
Specific impulse, sec	6 360	8 150

## CONCLUDING REMARKS

This report has estimated the initial gross weights for several mission profiles for a seven-man Mars mission. A nominal profile, with four spiral-type propulsion phases, can achieve weights as low as 400 000 kilograms for mission times of about 650 days. Use of an unmanned Van Allen belt traversal can reduce these weights to about 250 000 kilograms while saving about 40 days of the mission time. The introduction of atmospheric braking at Earth return can give further reductions to about 140 000 kilograms at 600 days or reduce the minimum possible mission time from 500 to 400 days. Finally, further but smaller reductions are possible by using two-phase profiles; however, these do not appear worth the concomitant risk and complexity except possibly for short trip times.

A sensitivity study has shown that the estimated values of initial mass are strongly dependent on the assumed rate of dose recovery rather than on the maximum allowable dose. (This has been shown for a range of maximum doses from 150 to 50 rems only.) This study has also shown that an operation at off-design values of power and specific impulse can be a serious problem at high values of specific powerplant mass. Perhaps the most important parameter for electric-propulsion systems is the powerplant specific mass that was varied from 4 to 20 kilograms per kilowatt in this part of the study. These results showed that this parameter mainly sets the minimum mission time possible for a given initial mass. At mission times of 600 days and more, powerplant mass has little effect on initial mass relative to shorter mission times. Finally, an investigation of the effects of thruster characteristics suggests that significantly larger improvements can be achieved by increasing thruster efficiency than by adding variable-thrust features.

Comparisons with the all-nuclear rocket and combined systems show that the combined system is lighter over a wide range of mission times at a specific powerplant mass of 7 kilograms per kilowatt and a high-thrust specific impulse of 850 seconds. The electric system becomes equivalent to the combined system at the longer mission times, but it is lighter than the nuclear-rocket system. For the shorter mission times, however, the combined system is far below the others in initial mass and may even permit the use of chemical propulsion in the initial high-thrust portion. These comparisons depend in detail on the particular choice of specific powerplant mass. Increases in powerplant mass will make both the all-electric and combined systems less attractive but will have a lesser effect on the combined system. However, the general area of applicability for each type of system has been indicated.

An examination of the power and mass requirements of the all-electric and the combined systems strongly suggests that the all-electric system developed for a mission time of 550 days (requiring 5 MW of power) also meets the requirements of the upper electric part of the 400-day combined system. Thus the all-electric system can be de-

signed for the 500- to 700-day mission-time area and available high-thrust systems used as assist stages to accomplish the shorter missions. Finally, it should be noted that the separate masses of the nuclear rocket and electric stages (109 000 and 157 000 kg, respectively) may be within the low Earth orbit launch capability of future booster systems.

Considering all-electric systems alone indicates that they have a possible role in the long mission time area regardless of specific power plant weight. If lightweight power-plants become available in the future, all-electric propulsion could be a very economical way to make manned Mars trips over a wide range of mission times.

Lewis Research Center,  
National Aeronautics and Space Administration,  
Cleveland, Ohio, June 14, 1965.

## REFERENCES

1. Himmel, S.C.; Dugan, J.F., Jr.; Luidens, R.W.; and Weber, R.J.: A Study of Manned Nuclear-Rocket Missions to Mars. *Aerospace Eng.*, vol. 20, no. 7, July 1961, pp. 18-19; 51-58.
2. Luidens, Roger W.; Burley, Richard R.; Eisenberg, Joseph D.; Kappraff, Jay M.; Miller, Brent A.; Shovlin, Michael D.; Willis, Edward A., Jr.: Manned Mars Landing Mission by Means of High-Thrust Rockets. NASA TN D-3181, 1966.
3. Pinkel, Benjamin: Electrical Propulsion for Space Missions - Planning Considerations. Paper No. 64-715, AIAA, 1964.
4. Coates, G.; and Brown, H.: Study of Low Acceleration Space Transportation Systems. General Electric Missile and Space Div., Oct. 28, 1964.
5. Sauer, Carl G., Jr.; and Melbourne, William G.: Optimum Earth-to-Mars Roundtrip Trajectories Utilizing a Low-Thrust Power-Limited Propulsion System. Rept. No. TR 32-376, Jet Prop. Lab., C.I.T., Mar. 29, 1963.
6. Zola, Charles L.: Trajectory Methods in Mission Analysis for Low-Thrust Vehicles. Preprint No. 64-51, AIAA, 1964.
7. McDonald, Frank B., ed. (C.E. Fichtel, D.E. Guss, H.H. Malitson, K.G. McCracken, K.W. Ogilvie, and W.R. Webber, contributors): Solar Proton Manual. NASA TR R-169, 1963.
8. Hrach, Frank J.: Proton Fluxes Along Low-Acceleration Trajectories Through the Inner Van Allen Belt. *AIAA J.*, vol. 2, no. 4, Apr. 1964, pp. 762-764.

9. Beck, Andrew J.; and Divita, Edward L.: Evaluation of Space Radiation Doses Received Within a Typical Spacecraft. ARS J., vol. 32, no. 11, Nov. 1962, pp. 1668-1676.
10. Wallner, Lewis E.; and Kaufman, Harold R.: Radiation Shielding for Manned Space Flight. NASA TN D-681, 1961.
11. Schofield, W.M.; Smith, E. C.; and Hill, C.W.: Shielding Problems in Manned Space Vehicles. Rept. No. ER-5997, Lockheed Nuclear Products, Lockheed Georgia Co., Dec. 1962.
12. Schaefer, Hermann J.: Radiation Tolerance Criteria in Space Operations. ARS J., vol. 32, no. 5, May 1962, pp. 771-773.
13. Anon.: The Effects of Nuclear Weapons. Pamphlet No. 39-3, Dept. Army, May 1957.
14. Helgostam, Lars F.: The Requirements for Efficient Mars Launch Trajectories. Preprint No. 64-15, AIAA, 1964.
15. Mickelsen, William R.: NASA Research on Heavy-Particle Electrostatic Thrustors. Paper No. 63-19, IAS, 1963.
16. Kerslake, William R.: Charge-Exchange Effects on the Accelerator Impingement of an Electron-Bombardment Ion Rocket. NASA TN D-1657, 1963.
17. Melbourne, W.G.: Interplanetary Trajectories and Payload Capabilities of Advanced Propulsion Vehicles. Rept. No. TR 32-68, Jet. Prop. Lab., C.I.T., Mar. 31, 1961.
18. Seiff, Alvin: Atmosphere Entry Problems of Manned Interplanetary Flight. Proc. AIAA and NASA Conf. on Eng. Problems of Manned Interplanetary Exploration, Palo Alto (Calif.), Sept. 30-Oct. 1, 1963, AIAA, 1963, pp. 19-33.
19. Denington, Robert J.; LeGray, William J.; and Shattuck, Russell D.: Electric Propulsion for Manned Missions. Proc. AIAA and NASA Conf. on Eng. Problem of Manned Interplanetary Exploration, Palo Alto (Calif.), Sept. 30-Oct. 1, 1963, AIAA, pp. 145-159.
20. Levoy, Myron: Dual Electric-Nuclear Engine. AIAA J., vol. 1, no. 6, June 1963, pp. 1298-1302.
21. Edelbaum, Theodore N.: The Use of High- and Low-Thrust Propulsion in Combination for Space Missions. J. Astronaut. Sci., vol. 9, no. 2, 1962, pp. 49-62.

*"The aeronautical and space activities of the United States shall be conducted so as to contribute . . . to the expansion of human knowledge of phenomena in the atmosphere and space. The Administration shall provide for the widest practicable and appropriate dissemination of information concerning its activities and the results thereof."*

—NATIONAL AERONAUTICS AND SPACE ACT OF 1958

## NASA SCIENTIFIC AND TECHNICAL PUBLICATIONS

**TECHNICAL REPORTS:** Scientific and technical information considered important, complete, and a lasting contribution to existing knowledge.

**TECHNICAL NOTES:** Information less broad in scope but nevertheless of importance as a contribution to existing knowledge.

**TECHNICAL MEMORANDUMS:** Information receiving limited distribution because of preliminary data, security classification, or other reasons.

**CONTRACTOR REPORTS:** Technical information generated in connection with a NASA contract or grant and released under NASA auspices.

**TECHNICAL TRANSLATIONS:** Information published in a foreign language considered to merit NASA distribution in English.

**TECHNICAL REPRINTS:** Information derived from NASA activities and initially published in the form of journal articles.

**SPECIAL PUBLICATIONS:** Information derived from or of value to NASA activities but not necessarily reporting the results of individual NASA-programmed scientific efforts. Publications include conference proceedings, monographs, data compilations, handbooks, sourcebooks, and special bibliographies.

*Details on the availability of these publications may be obtained from:*

SCIENTIFIC AND TECHNICAL INFORMATION DIVISION  
NATIONAL AERONAUTICS AND SPACE ADMINISTRATION

Washington, D.C. 20546