

PROTECTING SATELLITES FROM THE DYNAMICS OF THE LAUNCH ENVIRONMENT

Conor D. Johnson†
Paul S. Wilke*
CSA Engineering, Inc.
2565 Leghorn Road
Mountain View, CA 94043
(650) 210-9000

cjohnson@csaengineering.com and wilke@csaengineering.com

Abstract. Reduction of the vibration and shock loads seen by spacecraft during launch would greatly reduce the risk that the spacecraft and its instruments will be damaged during their ascent into orbit, and would also allow more sensitive equipment to be included in missions. As the severe launch environment also accounts for much of the expense of designing, qualifying, and testing spacecraft components, significant cost can also be saved if dynamic responses seen by the spacecraft are reduced. The launch events include low frequency dynamic loads such as lift-off, motor excitation, buffet, motor starts and shutoffs. Spacecraft are also subjected to shock loads in the several thousands of g's level during their trip to orbit. These high shock loads usually result from some separation event, such as staging, spacecraft separation, and fairing separation. Protecting the satellite from these loads by whole-spacecraft vibration and shock isolation systems has now been demonstrated. The basic concept of whole-spacecraft isolation is to isolate the entire spacecraft from the dynamics of the launch vehicle. This paper discusses two different systems: the SoftRide system, which is a lower frequency (10 – 50 Hz) isolation system and the ShockRing system, this is designed to attenuate higher frequency loads (70 Hz and above), including shock. All seven flights of CSA's SoftRide systems have shown excellent loads reductions in the coupled loads analyses and verified in the flight telemetry data. Component tests have been performed on the ShockRing using a specially built pneumatic gun that can generate 10,000 g's on the test article. Results from these tests demonstrate substantial reductions of the shock being transmitted to the payload. Results from a system test consisting of a spacecraft simulator, payload attachment fittings, avionics section, and shock plate will be discussed. In the system tests, pyrotechnic devices were used to obtain the high levels of shock for the tests. Finally, flight data from the first flight will be discussed.

INTRODUCTION

Satellites are perhaps among the most amazing products in use today, used for many purposes from communications to reconnaissance to weather prediction, and much more. Like all other products, satellites undergo design, fabrication, test, and shipment. However, the shipment of a satellite to its destination is far more complicated than for all other products. Since the launch of the world's first satellite in 1957, the capability and reliability of launch vehicles have improved dramatically. What has not improved in 45 years of launching satellites is the launch vehicle-induced shock environment that a satellite must endure on its trip to orbit. Excessive dynamic and shock loads can be a satellite killer causing permanent damage to electronics, optics, and other sensitive equipment. To compensate for the harsh dynamic environment, payloads must be designed and tested to very high dynamic levels, greatly increasing the cost of many payload components. An excellent alternative is to reduce the launch dynamic loads through the use of whole-spacecraft passive vibration isolation.

† Senior Member AIAA, President

* Member AIAA, Associate Principal Engineer

Whole-spacecraft vibration isolation has been developed to attenuate dynamic loads for some launch vehicles^{1,2}, has been successfully flown several times³, and is still in development for other vehicles and loading conditions. Whole-spacecraft vibration isolation systems can be discussed as systems that significantly reduce the dynamic loads in both the low frequency range (coupled loads analysis range) and in the high frequency range (shock loading range) or systems that only reduce the high frequency shock loads (Figure 1).

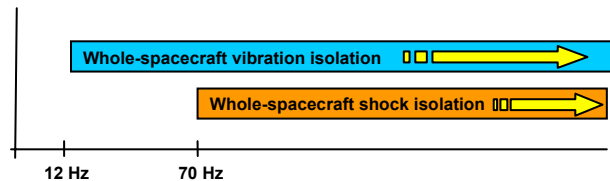

Figure 1 Frequency ranges for attenuation for shock and vibration isolation systems

Whole-spacecraft vibration isolation systems have typically been designed to date to attenuate launch dynamic loads from about 12 Hz and upward. This is very useful for mitigation of vibration loads on launch

Report Documentation Page

Form Approved
OMB No. 0704-0188

Public reporting burden for the collection of information is estimated to average 1 hour per response, including the time for reviewing instructions, searching existing data sources, gathering and maintaining the data needed, and completing and reviewing the collection of information. Send comments regarding this burden estimate or any other aspect of this collection of information, including suggestions for reducing this burden, to Washington Headquarters Services, Directorate for Information Operations and Reports, 1215 Jefferson Davis Highway, Suite 1204, Arlington VA 22202-4302. Respondents should be aware that notwithstanding any other provision of law, no person shall be subject to a penalty for failing to comply with a collection of information if it does not display a currently valid OMB control number.

1. REPORT DATE 2003	2. REPORT TYPE	3. DATES COVERED 00-00-2003 to 00-00-2003			
4. TITLE AND SUBTITLE Protecting Satellites from the Dynamics of the Launch Environment		5a. CONTRACT NUMBER			
		5b. GRANT NUMBER			
		5c. PROGRAM ELEMENT NUMBER			
6. AUTHOR(S)		5d. PROJECT NUMBER			
		5e. TASK NUMBER			
		5f. WORK UNIT NUMBER			
7. PERFORMING ORGANIZATION NAME(S) AND ADDRESS(ES) CSA Engineering, 2565 Leghorn Street, Mountain View, CA, 94043		8. PERFORMING ORGANIZATION REPORT NUMBER			
9. SPONSORING/MONITORING AGENCY NAME(S) AND ADDRESS(ES)		10. SPONSOR/MONITOR'S ACRONYM(S)			
		11. SPONSOR/MONITOR'S REPORT NUMBER(S)			
12. DISTRIBUTION/AVAILABILITY STATEMENT Approved for public release; distribution unlimited					
13. SUPPLEMENTARY NOTES The original document contains color images.					
14. ABSTRACT see report					
15. SUBJECT TERMS					
16. SECURITY CLASSIFICATION OF:			17. LIMITATION OF ABSTRACT	18. NUMBER OF PAGES	19a. NAME OF RESPONSIBLE PERSON
a. REPORT unclassified	b. ABSTRACT unclassified	c. THIS PAGE unclassified		10	

vehicles and also functions to isolate higher frequency shock loads. Whole-spacecraft shock isolation systems, on the other hand, are being designed to attenuate launch shock loads from about 70 Hz and upward. Most damaging shock loads have their most significant magnitude in the 1000 Hz and upward frequency range, however dynamic loads between 100 Hz and 1000 Hz are still considered to be shock loads and this frequency range has been known to be a real source of problems for some launch vehicles.

So the logical question is: Why not always use a vibration isolation system, as opposed to a shock isolation system, and get the isolation benefit from the lowest possible frequency? The answer lies in the relationship between the isolation system, the launch vehicle guidance, navigation, and control (GNC) system, and coupled loads analysis. The whole-spacecraft vibration isolation system is lower in frequency and stiffness than a shock isolation system and is carefully sized, for each mission, using coupled loads analysis. The first bending modes of the satellite are typically reduced by the introduction of a vibration isolation system and therefore must be designed in concert with the GNC system such that control instabilities are not introduced. Again, this is possible, and has been done successfully on several flights. The whole-spacecraft shock isolation system, on the other hand, is relatively high in frequency and stiffness and has little or no effect on the GNC system or on coupled loads analyses. For missions that do not anticipate any problems with lower frequency vibration loads, a shock isolation system will be easier to include with only minimal effort.

Under a number of contracts from the Air Force Research Laboratory, Space Vehicles Directorate, CSA Engineering has been working on the concept of whole-spacecraft vibration isolation and shock systems (hereinafter referred as the SoftRide system) since 1993. A number of design and performance analyses were performed on a variety of liquid-fueled and solid-fueled launch vehicles, all of which showed great promise. However, it was not until the launch of the GFO spacecraft on Orbital Science's Taurus launch vehicle in February 1998 did an isolation system designed to vibration-isolate the complete spacecraft actually fly. Since that time, two different types of systems have flown, and design work has been performed on several additional launch vehicle/spacecraft combinations. The following sections discuss each type of system, show hardware pictures, and present flight results.

SOFTRIDE VIBRATION ISOLATION SYSTEMS

Typical vibration isolation systems work by connecting the isolated structure (payload) to the base structure (launch vehicle) by means of a resilient mount or mounts. The resilient mounts have low relative stiffness as compared to the base and payload, and some degree of structural damping. The stiffness of the resilient mounts is tuned so that the frequency of vibration of the supported payload on the resilient mounts is a specified value (isolation frequency). Damping in the resilient mounts reduces the amplitude of response of the payload at the isolation frequency when the system is under external excitation. The resilient mounts must allow relative motion between the vibrating base structure and the payload at the isolation frequency, which is referred to as the isolator stroke.

Because the spacecraft is a major structural component of the launch vehicle/spacecraft dynamic system, variations in the isolation frequencies greatly effect the dynamics of the launch vehicle/spacecraft system. Any unpredicted changes in the dynamics could have an adverse effect on the control system of the launch vehicle and cause instability and thereby loss of the mission. Therefore, the stiffness properties of the isolation system must be predictable for the duration of the flight. This requires a linear isolation system under all load cases, including preloads from $-2g$'s to $+6g$'s accelerations of the launch vehicle. This eliminates using an elastomeric material (i.e., rubber mounts) as the stiffness component of the isolation system. Owners of spacecraft, which costs tens to hundreds of millions of dollars, demand a metallic connection between the spacecraft and the launch vehicle. This connection, which is the SoftRide system, must also provide a fail-safe connection, must be able to handle, without overstressing, the deflections due to the sum of the dynamic and quasi-static acceleration loads of the spacecraft, and must be of minimal height (reduces payload volume) and weight (reduces payload weight).

On expendable launch vehicles, spacecraft are attached to the launch vehicle at their base either at discrete points or by a band clamp. If the attachment stiffness is made soft in the axial or thrust axis, then we refer to that type of isolation system as an axial system. Axial systems can provide isolation in the axial and two rocking directions and therefore can isolate against both axial and bending modes of the launch vehicle. If the attachment stiffness is made soft in the in-plane directions at the attachment points, then that type of isolation system will be referred to as a lateral or shear

isolator. Whole-spacecraft vibration isolation systems may also be a combination of these.

The SoftRide whole-spacecraft vibration isolation systems have flown on two different launch vehicles to date: Orbital Science Corporation's Taurus launch vehicle and the Air Force Minotaur launch vehicle (Figure 2). This paper discusses axial and combined axial + lateral SoftRide systems designed for and flown on these launch vehicles. Even though these systems were designed to reduce transient vibration loads below 80 Hz, they performed extremely well at reducing high-frequency loads. Whole-spacecraft vibration isolation systems are now offered as a launch option in the Taurus Launch System Payload User's Guide¹ and in the Minotaur Payload User's Guide². Minotaur is a four stage, ground launched solid propellant, inertially guided spacelift vehicle from Orbital Sciences Corporation. It uses the first two stages from the Minuteman II intercontinental ballistic missile (ICBM) combined with the upper two stages, structure, and fairing from the Pegasus XL air-launched space vehicle³.



Figure 2 The Taurus and Minotaur launch vehicles

Passive Whole-Spacecraft Vibration Isolation Systems

Two types of passive whole-spacecraft vibration isolation systems have been flown. These are (1) a patented uniaxial damped flexure system called SoftRide UniFlex, and (2) a patented multi-axis damped flexure system called SoftRide MultiFlex. These systems are intended to attenuate low-frequency launch vibration loads from about 20 Hz and higher. The

following sections describe the isolation systems and present flight telemetry data.

SoftRide UniFlex

The patented SoftRide UniFlex whole-spacecraft vibration isolation system is intended to reduce dynamic launch loads that are predominantly axial (thrust-direction) in nature. The stiffness and damping of the isolators are sized to mission-specific requirements for reduction of these dynamic loads. This system consists of a set of damped flexure elements that connect the spacecraft to the launch vehicle. Figure 3 shows a UniFlex isolator. This consists of a titanium flexure and a constrained layer



Figure 3 SoftRide UniFlex isolator

damping treatment. The metallic load path of this isolator allows a strong, predictable, stable connection between the spacecraft and the launch vehicle. The damping treatment provides sufficient damping to control resonant amplification of loads. The typical application of this isolation system is to replace each bolt at a field joint with a UniFlex isolator element, as shown in Figure 4. The typical location for the isolation system is just aft of the spacecraft separation system.

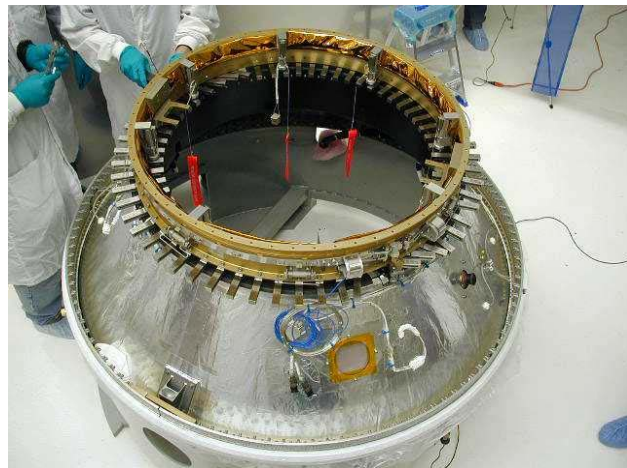

Figure 4 SoftRide UniFlex installation

SoftRide MultiFlex

The patented SoftRide MultiFlex whole-spacecraft vibration isolation system is intended to reduce dynamic launch loads that are both axial (thrust-direction) and lateral in nature. The stiffness and damping of the isolators are sized to mission-specific requirements for reduction of these dynamic loads. Similar to UniFlex, this system consists of a set of damped flexure elements that connect the spacecraft to the launch vehicle. Figure 5 shows a MultiFlex isolator.



Figure 5 SoftRide MultiFlex isolator

This consists of a pair of UniFlex isolators separated from one another by a central post. The axial isolation



Figure 6 SoftRide MultiFlex installation

is achieved by virtue of the UniFlex isolators in series with one another. The lateral isolation is achieved by the shearing of the assembly with bending occurring in the flexures. The typical application of this isolation system is to replace each bolt at a field joint with a MultiFlex isolator element, as shown in Figure 6.

Flight Heritage of Whole-Spacecraft Vibration Isolation

There is significant flight heritage for whole-spacecraft vibration isolation. These systems have, to date, flown on six separate missions. Flight telemetry data indicating the flight performance of the isolation systems is available from all missions except the MightySat mission and will be presented in the following sections. Table 1 summarizes the missions on which SoftRide has flown.

Table 1 Summary of SoftRide Flight Heritage

Launch Vehicle	Spacecraft	Isolation System
Taurus	GFO	UniFlex
Taurus	STEX	UniFlex
Minotaur	JAWSAT	MultiFlex
Taurus	MTI	UniFlex
Minotaur	MightySat	MultiFlex
Taurus	QuickTOMS OrbView4	Uniflex

Taurus 2 / GFO

The GFO spacecraft interface was instrumented with six accelerometers that measured axial and lateral vibration during the flight. A single accelerometer was mounted in the flight direction just forward or on the soft side of the isolation system. The remaining spacecraft interface accelerometers were mounted aft or on the hard side of the isolation system. The accelerometers were sampled at 4000 samples per second with 8 bit resolution. Variable capacitance accelerometers were used which measured both the steady state and transient acceleration. An overplot of the time history of the response, during the first stage burn, from accelerometers mounted on the launch vehicle side and on the satellite side of the isolation system is shown in Figure 7. The reduction due to the spacecraft isolation system is readily apparent by comparing the two time histories. The isolation system significantly reduces the vibration level to the payload by 50% for all load events.

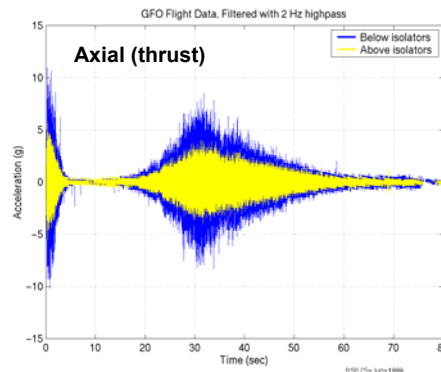

Figure 7 GFO flight data – below and above isolators

Taurus 3 / STEX

The Taurus/STEX SoftRide isolation system was very similar to that of GFO but “tuned” for this mission. The STEX spacecraft was heavier than the GFO and therefore the isolation system was larger. With one successful flight of this system, the program offices allowed a slightly more aggressive design (lower in frequency) to be flown. Finite element models of the LV and spacecraft were obtained and full coupled-loads analyses were performed to design the isolation system. While the first mission (Taurus/GFO) required both component-level and system-level testing of the isolation system, only component-level tests were performed on the Taurus/STEX system.

For the Taurus/STEX mission, data from two accelerometers, again one below and one above the isolators, was obtained. An overplot of this data is shown in Figure 8 (this data has been high-pass filtered to eliminate the quasi-static accelerations). This data shows a factor of five reduction in the broadband acceleration levels above the isolators.

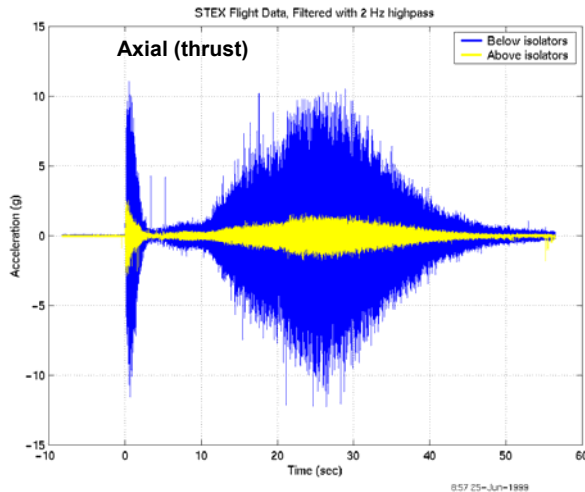

Figure 8 STEX flight data - below and above isolators

It is of great interest to examine the performance of the SoftRide isolation system in the frequency domain. This allows inspection of the broadband attenuation characteristics of the SoftRide system. The dynamic system made up of the launch vehicle and spacecraft is non-stationary due to continual propellant depletion and stage separations. Also, the highly transient nature of most launch load events precludes digital signal processing of the flight data averaged over the entire launch window. Therefore, the frequency content of the transient flight data is best observed by creating waterfall PSD plots. These plots show the PSDs of 2-second windows of transient data, overlapped by 1 second, and stacked up next to each other.

Figure 9 shows the waterfall plot for the axial acceleration below the isolators from the GFO flight. Similarly, Figure 10 shows the axial acceleration above the isolators from the STEX flight. Note that the sample rate of 4000 Hz only allows data to be examined up to 2000 Hz. Examination of these plots shows that the SoftRide system provided significant reductions in the acceleration levels across the broadband spectrum. The high frequency accelerations below the isolators may be due to structural-borne acoustic energy. The SoftRide system has greatly reduced the structural-borne acoustic vibration on the spacecraft.

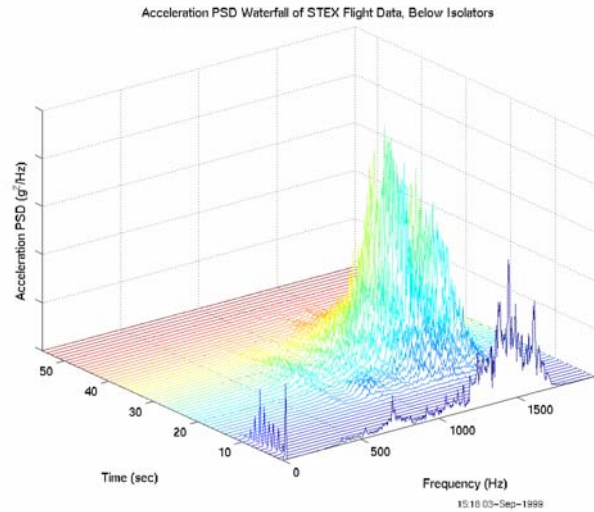

Figure 9 Waterfall PSD of STEX data - below isolators

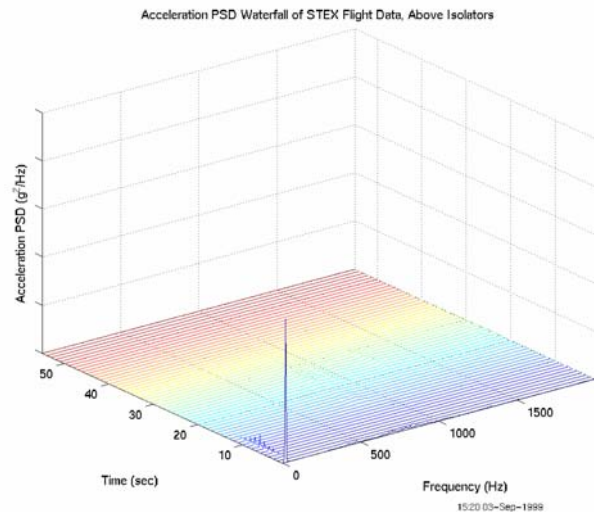

Figure 10 Waterfall PSD of STEX data - above isolators

Taurus 5 / MTI

For the Taurus/MTI mission, flight telemetry data was obtained below and above the isolators in both the axial and the radial directions. The instrumentation and data processing were done similarly to the GFO and STEX missions. Transient data and waterfall PSD plots for the axial direction are similar to the previous flight data. Transient data plot for the radial direction is shown in Figure 11. Note that the UniFlex isolation system not only provides attenuation in the axial direction, but also provides significant reduction in dynamic responses in the radial direction.

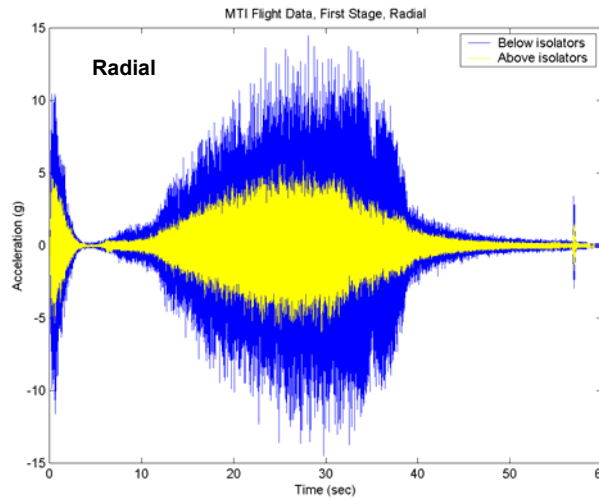

Figure 11 MTI flight data - below and above isolators

Taurus 6 / QuickTOMS & OrbView4

The Taurus 6 /QuickTOMS & OrbView 4 mission (see Figure 12) was the first dual mission where both satellites were protected by separate SoftRide systems. Flight telemetry data was obtained below and above the isolators in the axial direction for both satellites. Transient data plots for the axial are shown in Figure 13 for QuickTOMS and Figure 14 for OrbView4. This data shows that the isolators provided excellent response reductions, similar to other Taurus flights.



Figure 12 QuickTOMS and OrbView4 satellites in the launch configuration

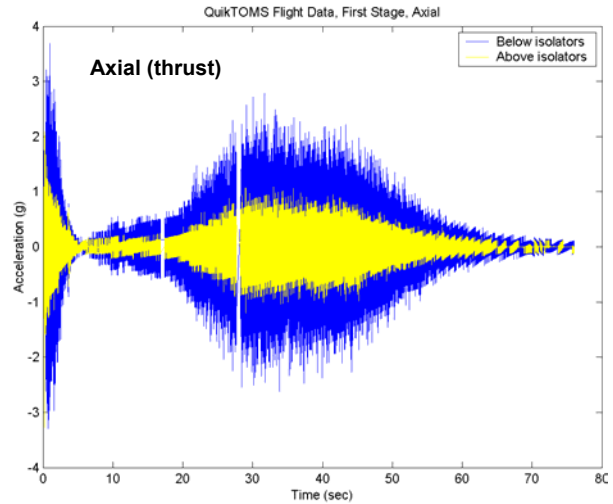

Figure 13 QuickTOMS flight data - below and above isolators

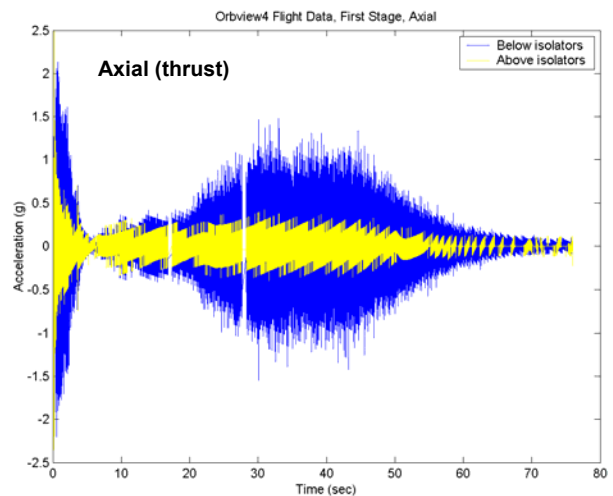

Figure 14 QrbView4 flight data - below and above isolators

Minotaur 1 / JAWSAT

The Air Force funded a significant data acquisition system on Minotaur for the purpose of assessing the performance of the SoftRide vibration isolation system. A total of 18 accelerometers were flown for measuring accelerations on both the launch vehicle side and the spacecraft side of the isolation system. These accelerometers were arranged into 6 triaxial sets: three triaxial sets on the hard side and three triaxial sets on the soft side. Flight data was examined and the trends observed agreed very well with the predictions of coupled loads analyses. An example of some SoftRide acceleration flight data from the JAWSAT mission is shown in Figure 15.

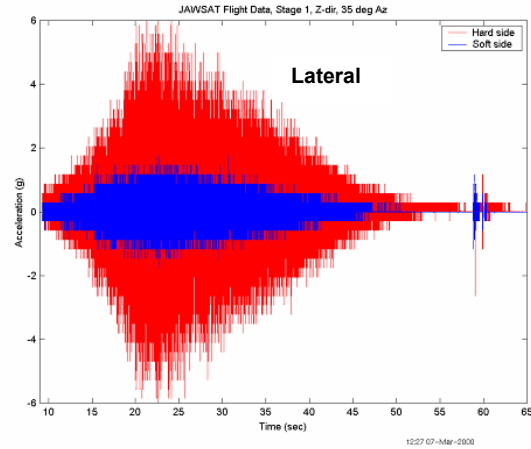
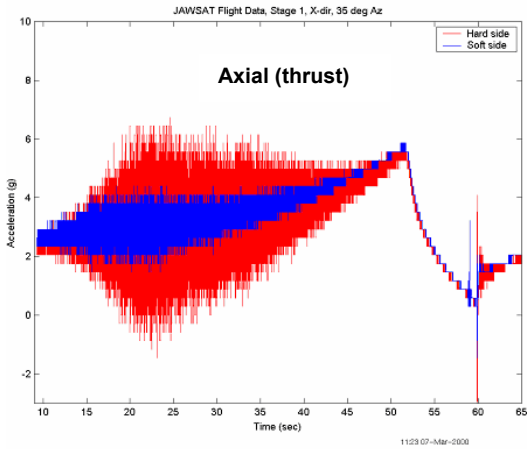

Figure 15 Typical SoftRide flight data from the Minotaur/JAWSAT mission

The quasi-static acceleration measurements have not been filtered out of this data. Note that excellent vibration isolation was achieved in both the axial (thrust) and the lateral directions.

Data showing the fairing separation shock event from the Minotaur/JAWSAT flight is shown in Figure 16. The flight accelerometers were not shock accelerometers and therefore some clipping of the high-level “hard side” shocks has occurred. However, the isolated “soft side” shows greatly reduced shock inputs to the base of the spacecraft.

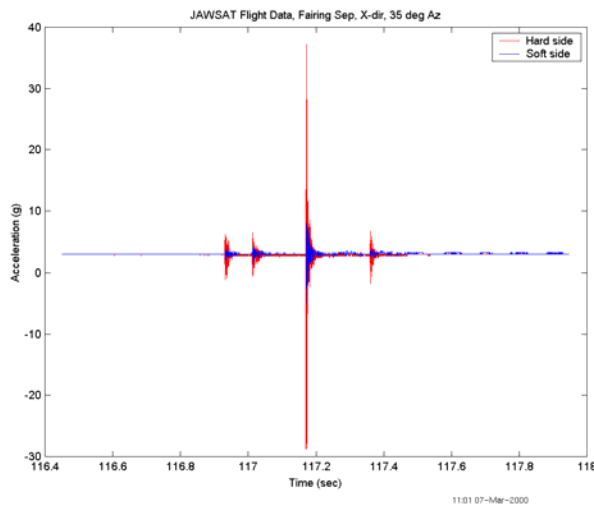

Figure 16 Fairing separation shock flight data showing SoftRide attenuation

Minotaur 2 / MightySat

The Minotaur/MightySat mission was the second flight of the Minotaur launch vehicle. The auxiliary data acquisition system for collecting SoftRide performance data was not flown on this mission so telemetry data is not available. The launch was a complete success and

the MightySat spacecraft, after its soft ride to orbit, began operation as planned.

SOFTTRIDE SHOCK ISOLATION SYSTEMS (SHOCKRING)

Whole-spacecraft shock isolation systems have been designed, analyzed, and tested and others are currently in development. These isolators are optimally located in the stack just aft of the satellite in order to attenuate all shock loads from the launch vehicle. Candidate locations include (1) at the top of the payload attach fitting (PAF), just below the satellite separation system (Figure 17), (2) at the bottom of the PAF, or (3) integrated somewhere within the PAF. One patented design for a whole-spacecraft shock isolation system is shown in Figure 17. This is a continuous ring made of a series of highly-damped flexures. The designed-in compliance, the high damping, the contorted shock path, and the joints all combine to make this an

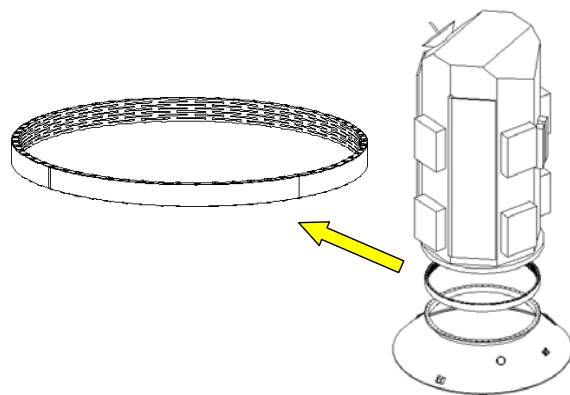

Figure 17 Whole-spacecraft shock isolator at top of PAF effective light-weight isolation system. This isolator design, along with several other designs that are in

development, have been tested and results will be presented in the following discussion. Flight results from the first flight are also presented.

Whole-spacecraft shock isolation systems are currently under development for the purpose of attenuating shock inputs from the launch vehicle to the spacecraft. The major source of these shock inputs is typically fairing separation shock, dual payload attach fitting (DPAF) separation shock, stage ignitions, and stage shutdowns. While UniFlex and MultiFlex vibration isolation systems are tailored to mission-specific requirements for low frequency isolation, the shock isolation system is planned to be more of an “off-the-shelf” component. It is envisioned that, for each class of launch vehicle, the shock isolator will be a “couple sizes fits all” type of system for the purpose of attenuating launch dynamic loads from frequencies of about 70 Hz and higher, depending on the design. A patented shock isolator is shown in Figure 18.



Figure 18 Shock isolator

During the initial development phase of the whole-spacecraft shock isolation system, prototypes were fabricated and shock tested using a pneumatic impact gun. The shock isolator was attached to two rigid steel blocks and suspended from a test frame. The impact occurred on the steel block referred to as the “base” and the accelerations are measured on both the base and the “payload” steel block. Acceleration time histories and their corresponding shock response spectra for a typical test are shown in Figure 19.

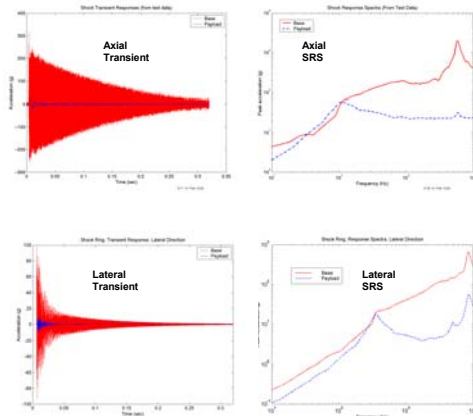

Figure 19 Transient responses and shock response spectra from impact test

The pneumatic impact gun testing is very useful for development of shock isolators. However, this type of testing is missing two essential ingredients to prove the shock isolator’s ability to attenuate shock loads. The launch community will place more credibility on the shock isolator testing if it includes (1) flight-like pyrotechnic excitation and (2) flight-like flexible adjoining structures as opposed to rigid blocks.

Shock tests were subsequently conducted using primacord for pyrotechnic excitation, launch vehicle components, and a spacecraft emulator. The amount of primacord was experimentally adjusted until flight-like shock acceleration levels were measured at the spacecraft interface. Accelerations were measured in all directions at several locations. Figure 20 shows acceleration time histories and shock response spectra from the test of a whole-spacecraft shock isolator. Data is shown for accelerometer locations both forward and aft of the isolator. The excellent attenuation performance of the shock isolator can be seen in both the time and frequency domains.

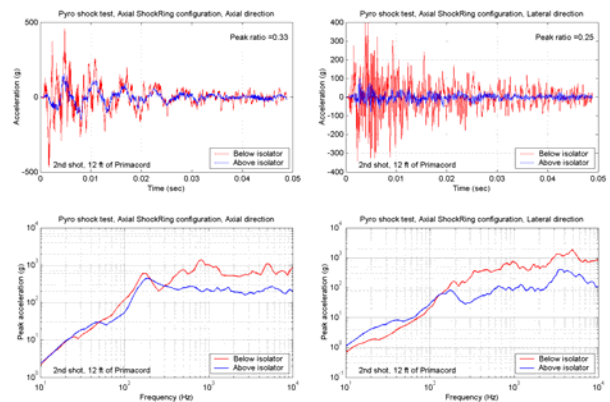

Figure 20 Time history data and shock response spectra from pyrotechnic testing of shock isolator

VALPE Flight Experiment

The Air Force Research Laboratory and the Air Force Space Test Program is sponsoring a program called VALPE, Vibro-Acoustic Launch Protection Experiment. VALPE is demonstrating several vibration/acoustics reduction techniques on board two flights of a NASA sounding rocket, the Terrier Improved-Orion. Passive and hybrid (passive-active) whole-spacecraft vibration isolation is one component of this program. For the first flight, only a passive SoftRide ShockRing isolation system was flown. For the second flight, an active vibration isolation system will also be implemented using the ShockRing as the passive stage. This launch vehicle produces very high quasi-static acceleration loads (up to 20 g’s) and very

high dynamic loads (up to 40 g's). Therefore, designing the isolation system for strength while maintaining the required flexibility was a challenge.

The first flight was launched from NASA Wallops Flight Facility at Wallops Island, VA in November 2002. Figure 21 shows the flight one payload hardware prior to integration into the launch vehicle. The ShockRing is protecting the mission specific electronics for monitoring the experiment launch environment. Figure 22 shows the launch vehicle and the lift-off.

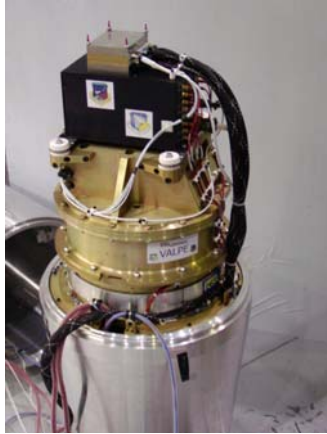

Figure 21 VALPE flight one payload hardware



Figure 22 VALPE Terrier Improved-Orion launch rail and November 02 launch

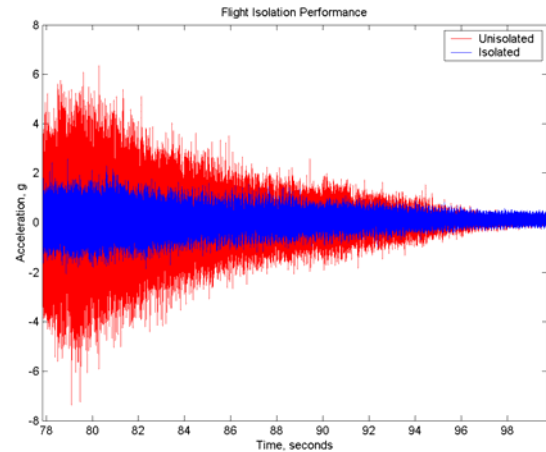

Figure 23 VALPE flight data from last 20 seconds of flight, below and above the isolation system

Flight data was recovered by telemetry from the entire flight. Flight data for the lateral direction for the second stage burn is shown in Figure 23, where the data in red is below the isolation system and data in blue is on the payload side. This data shows that the ShockRing reduced the acceleration levels even in the lateral direction, which is not as compliant and highly damped as the axial direction.

Conclusion

There is a need to reduce launch loads on spacecraft so that spacecraft and their instruments can be designed with more concentration on orbital performance rather than launch survival. A softer ride to orbit will allow more sensitive equipment to be included in missions, reduce risk of equipment or component failure, and possibly allow the mass of the spacecraft bus to be reduced. These benefits apply to military as well as commercial spacecraft.

For all of the missions flown to date, the patented SoftRide UniFlex, MultiFlex, and ShockRing whole-spacecraft vibration isolation systems have proved to be a very effective means of reducing spacecraft responses due to the broadband structure-borne launch environment.

From both the transient data and the waterfall PSDs, it is clear that the SoftRide whole-spacecraft vibration isolation systems performed very well to reduce structure-borne vibration levels transmitted to the spacecraft. The isolation system was designed specifically to reduce the effects of solid motor resonant burn in the 45 Hz to 60 Hz frequency range, which it did very well. It should also be noted that the SoftRide vibration isolation system provided extreme reductions

of shock and structure-borne acoustics at higher-frequencies.

The isolation system hardware design was elegant in its simplicity, which ultimately played a great part in its acceptance by both the spacecraft and launch vehicle manufacturers. The SoftRide isolation systems are simply inserted at an existing field joint. No flight hardware changes were required. The only change was to the guidance and control algorithms to account for bending frequency changes introduced by the isolation system.

In the end, the choice to fly the isolation system proved to be a tremendous risk-reduction for the spacecraft by drastically increasing the spacecraft margins. Because of the success of these flights, this isolation system design is being used on several upcoming flights.

Acknowledgements

This research and development was supported by a number of Small Business Innovative Research (SBIR) contracts from the Air Force Research Laboratory, Space Vehicles Directorate, along with funding from the Air Force Space and Missile Systems Center (SMC). Mr. Eugene Fosness, Dr. Dino Sciulli, and Dr. Benjamin (Kyle) Henderson were the technical monitors and their support and encouragement are gratefully acknowledged. Steve Buckley, SMC/TEB, (now with Northrup Grumman) was the driving force from SMC encouraging the flight of whole-spacecraft vibration isolation systems.

References

1. Orbital Sciences Corporation, "Taurus Launch System Payload User's Guide", Release 3.0, September, 1999
2. Orbital Sciences Corporation, "Minotaur Payload User's Guide", Draft version, April 26, 2001
3. Schoneman, S., Buckley, S., et. al, "Orbital Suborbital Program (OSP) "Minotaur" Space Launch Vehicle: Low Cost Space Lift For Small Satellites Using Surplus Minuteman Motors", AIAA Paper AIAA-2000-5068, AIAA Space 2000 Conference, September 19-21, 2000, Long Beach, CA.