

# REPORT DOCUMENTATION PAGE

*Form Approved*  
OMB No. 0704-0188

Public reporting burden for this collection of information is estimated to average 1 hour per response, including the time for reviewing instructions, searching existing data sources, gathering and maintaining the data needed, and completing and reviewing this collection of information. Send comments regarding this burden estimate or any other aspect of this collection of information, including suggestions for reducing this burden to Department of Defense, Washington Headquarters Services, Directorate for Information Operations and Reports (0704-0188), 1215 Jefferson Davis Highway, Suite 1204, Arlington, VA 22202-4302. Respondents should be aware that notwithstanding any other provision of law, no person shall be subject to any penalty for failing to comply with a collection of information if it does not display a currently valid OMB control number. **PLEASE DO NOT RETURN YOUR FORM TO THE ABOVE ADDRESS.**

<b>1. REPORT DATE (DD-MM-YYYY)</b> 18-11-2005		<b>2. REPORT TYPE</b> Technical Paper		<b>3. DATES COVERED (From - To)</b>	
<b>4. TITLE AND SUBTITLE</b>  <b>Experimental and Numerical Analysis of Transpiration Cooling of a Rocket Engine Using Lamilloy® Plates (POSTPRINT)</b>				<b>5a. CONTRACT NUMBER</b>	
				<b>5b. GRANT NUMBER</b>	
				<b>5c. PROGRAM ELEMENT NUMBER</b>	
<b>6. AUTHOR(S)</b> T.P. Auyeung, R. Cohn, E. Coy, S.A. Danczyk (AFRL/PRSA); C. Papesh (Northrop Grumman); P. Sweeney (Rolls-Royce LibertyWorks)				<b>5d. PROJECT NUMBER</b> 5026	
				<b>5e. TASK NUMBER</b> 0548	
				<b>5f. WORK UNIT NUMBER</b>	
<b>7. PERFORMING ORGANIZATION NAME(S) AND ADDRESS(ES)</b>  Northrop Grumman Space Technology One Space Park Redondo Beach CA 90278				<b>8. PERFORMING ORGANIZATION REPORT NUMBER</b>  AFRL-PR-ED-TP-2005-450	
<b>9. SPONSORING / MONITORING AGENCY NAME(S) AND ADDRESS(ES)</b>  Air Force Research Laboratory (AFMC) AFRL/PRS 5 Pollux Drive Edwards AFB CA 93524-70448				<b>10. SPONSOR/MONITOR'S ACRONYM(S)</b>	
				<b>11. SPONSOR/MONITOR'S NUMBER(S)</b> AFRL-PR-ED-TP-2005-450	
<b>12. DISTRIBUTION / AVAILABILITY STATEMENT</b>  Approved for public release; distribution unlimited. PA number AFRL-ERS-PAS-05-290.					
<b>13. SUPPLEMENTARY NOTES</b> Presented at the 53 <sup>rd</sup> JANNAF Joint Propulsion Meeting (JPM), 2 <sup>nd</sup> Liquid Propulsion Subcommittee (LPS) and Spacecraft Propulsion Subcommittee (SPS), Monterey, CA, 5-8 Dec 2005.					
<b>14. ABSTRACT</b> Transpiration cooling of rocket engine thrust chamber walls has the potential for improving the performance of liquid rocket engines by reducing the required cooling flow. For the TR107 hydrocarbon booster engine, it is estimated that replacing the proposed chamber wall film cooling with transpiration cooling could result in an engine Isp increase of 2% to 3%, which provides the potential to increase the maximum booster delivery capability by 4000-5000 lbm. In the past, various transpiration cooling wall materials have been investigated with varying degrees of success. In this investigation we examined the use of Lamilloy®* as the transpirant wall. Lamilloy is a cooling system with a 30+ year history in jet engine applications developed by Rolls-Royce LibertyWorks™. This work represents the first evaluation of this technology for rocket engine applications in a representative hot-fire environment. Tests were performed in a sub-scale hot-fire chamber that produced heat fluxes of 4-15 Btu/in. <sup>2</sup> /s at chamber pressures of 370-670 psi. Gaseous oxygen/RP-1 propellants were fired at mixture ratios ranging from 1.2 to 1.8. Three off-the-shelf Lamilloy designs were tested with three different transpirants: gaseous nitrogen, water, and RP-1. Testing demonstrated that the hot-gas wall temperature decreased rapidly in the downstream direction due to the cumulative effect of the injected coolant. The tested Lamilloy specimens demonstrated the potential to be an effective material for use as a transpiration cooled wall. However, the specimens tested were designed for low pressure drop in gas turbine combustor applications thus did not provide the high pressure drop needed for rocket propulsion applications. The extensive database generated during this testing can be used to guide future Lamilloy transpiration cooling designs for specific rocket thrust chamber application. Recommendations for follow-on development effort are discussed.					
<b>15. SUBJECT TERMS</b>					
<b>16. SECURITY CLASSIFICATION OF:</b>			<b>17. LIMITATION OF ABSTRACT</b>  A	<b>18. NUMBER OF PAGES</b>  13	<b>19a. NAME OF RESPONSIBLE PERSON</b> Dr. Douglas G. Talley
<b>a. REPORT</b>  Unclassified	<b>b. ABSTRACT</b>  Unclassified	<b>c. THIS PAGE</b>  Unclassified			<b>19b. TELEPHONE NUMBER</b> (include area code) (661) 275-6174

## **Experimental and Numerical Analysis of Transpiration Cooling of a Rocket Engine Using Lamilloy® Plates**

S.A. Danczyk, R. Cohn, E. Coy, T.P. Auyeung  
Air Force Research Laboratory, Edwards AFB, CA

C. Papesh  
Northrop Grumman Space Technology Division, Redondo Beach, CA

P. Sweeney  
Rolls-Royce North American Technologies, Inc. Indianapolis, IN

### **ABSTRACT**

Transpiration cooling of rocket engine thrust chamber walls has the potential for improving the performance of liquid rocket engines by reducing the required cooling flow. For the TR107 hydrocarbon booster engine, it is estimated that replacing the proposed chamber wall film cooling with transpiration cooling could result in an engine Isp increase of 2% to 3%, which provides the potential to increase the maximum booster delivery capability by 4000-5000 lbm. In the past, various transpiration cooling wall materials have been investigated with varying degrees of success. In this investigation we examined the use of Lamilloy®\* as the transpirant wall. Lamilloy is a cooling system with a 30+ year history in jet engine applications developed by Rolls-Royce LibertyWorks™. This work represents the first evaluation of this technology for rocket engine applications in a representative hot-fire environment. Tests were performed in a sub-scale hot-fire chamber that produced heat fluxes of 4-15 Btu/in.<sup>2</sup>/s at chamber pressures of 370-670 psi. Gaseous oxygen/RP-1 propellants were fired at mixture ratios ranging from 1.2 to 1.8. Three off-the-shelf Lamilloy designs were tested with three different transpirants: gaseous nitrogen, water, and RP-1. Testing demonstrated that the hot-gas wall temperature decreased rapidly in the downstream direction due to the cumulative effect of the injected coolant. The tested Lamilloy specimens demonstrated the potential to be an effective material for use as a transpiration cooled wall. However, the specimens tested were designed for low pressure drop in gas turbine combustor applications thus did not provide the high pressure drop needed for rocket propulsion applications. The extensive database generated during this testing can be used to guide future Lamilloy transpiration cooling designs for specific rocket thrust chamber application. Recommendations for follow-on development effort are discussed.

### **INTRODUCTION**

Due to its ability to locally tailor coolant injection, transpiration cooling is regarded as potentially one of the more efficient means of booster-class rocket thrust chamber thermal control<sup>1,2</sup>. This is especially true in the case of RP-1 fueled engines, where the excellent cooling characteristics of hydrogen are not available for regenerative cooling. One approach to transpiration cooling with great potential for these applications is to locally tailor coolant injection using Lamilloy®, a quasi-transpiration cooling technology that has been successfully employed in gas turbine engines for over 30 years. The objective of this project is to assess, via representative sub-scale hot-fire testing, the feasibility of this technology for LOX/RP-1 booster-class rocket engine applications. This work was accomplished by means of a close collaboration between Northrop Grumman Space Technology (NGST), Rolls-Royce North American Technologies, Inc., known as LibertyWorks™, and Air Force Research Laboratory (AFRL) Propulsion Directorate at Edwards Air Force Base (EAFB).

---

\* Lamilloy is a registered trademark of Rolls-Royce Corporation

In order to estimate the potential benefit of transpiration cooling for LOX/RP booster rocket engines, the performance of NGST's TR107 engine concept (1 million-pound-thrust reusable LOX/RP-1 Oxygen-Rich Staged-Combustion Cycle) was used as a baseline. The TR107 design employs a combination of forward film-cooled and duct-cooled thrust chamber design where RP-1 coolant is injected both at the chamber head-end and flows through a chamber wall duct to be injected axially at the start of the convergent nozzle section to efficiently cool the throat and divergent nozzle sections. For applications that are required to meet IHPRPT Hydrocarbon Boost Phase II performance goals, higher combustion efficiency can be achieved by replacing the baseline cooling approach with transpiration cooling that injects coolant at low velocity into the main chamber through the duct wall itself, perpendicular to the core flow. NGST estimates that transpiration cooling can increase Isp by approximately 7 seconds over the baseline, which translates to a stage performance increase of approximately 5,000 pounds, as shown in Figure 1.

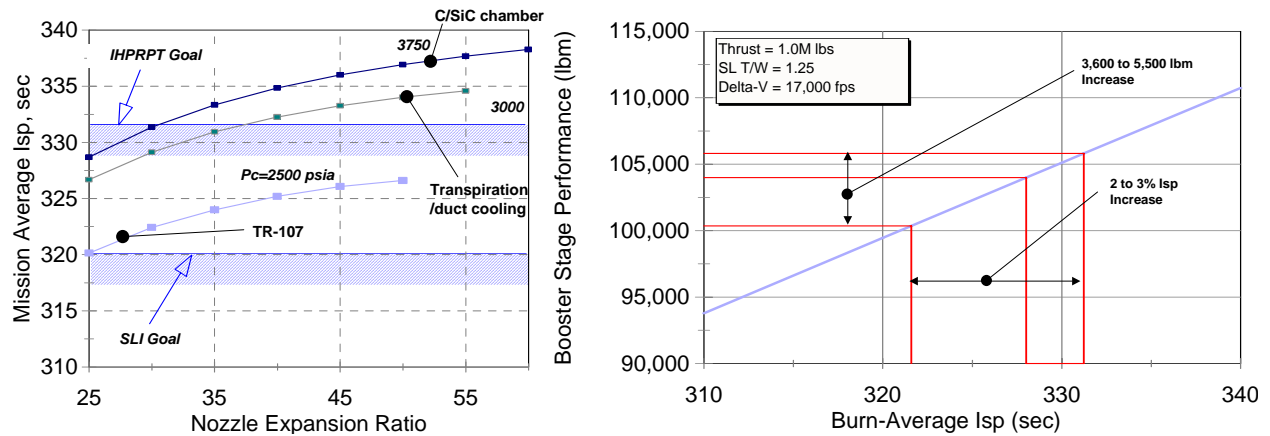

**Figure 1. NGST estimate for booster performance improvement with transpiration cooling**

Lamilloy® is a quasi-transpiration cooling system, developed by LibertyWorks™, with a multi-layered wall made by forming or casting a pattern of holes and/or channels in each layer. Lamilloy has been applied to gas turbine propulsion systems in combustors, turbine sections and engine exhaust components and has been fabricated from several different high temperature superalloys such as HA188 and HA230. It provides high levels of cooling effectiveness through a combination of (a) external film cooling (prevents heat transfer to metal surface), (b) high internal effectiveness (convection within tortuous passages), and (c) through-wall conduction (to internal areas where convection is high). In this approach several perforated high-temperature alloy sheets are diffusion bonded together, forming a reusable multilayer structure, as shown in Figure 2.

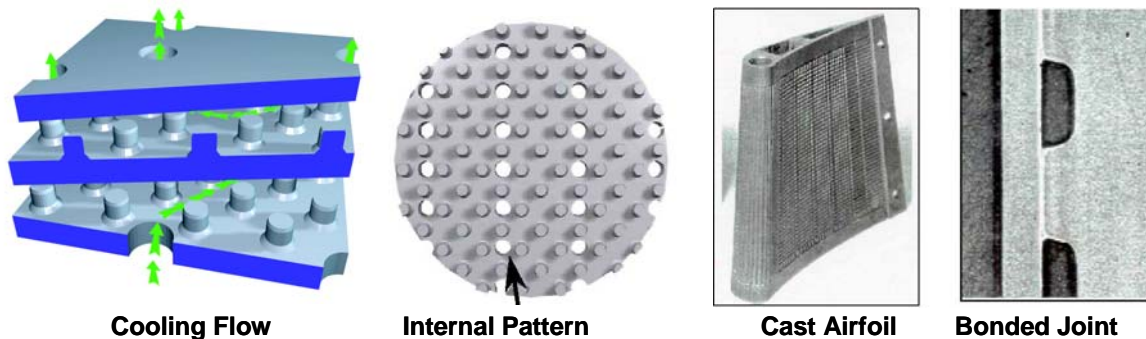

**Figure 2. Lamilloy® provides high level of cooling effectiveness through a combination of external film cooling, through-wall conduction, and strong internal convection.**

## APPROACH

A combined analytical and experimental approach was used to assess the cooling performance of off-the-shelf Lamilloy test specimens (designed for gas turbine applications) in a representative hot-fire rocket engine environment. Four key criteria were established for this investigation: (a) the transpiration cooling performance evaluation shall be based on more than one method and set of hardware; (b) hot-fire testing shall be accomplished at conditions that capture the underlying physical process of the eventual boost-class rocket engine application, (c) the effectiveness of transpiration cooling shall be measured as directly as possible, (d) the investigation shall address factors unique to RP-1, such as the effect of sooting, coking, and of endothermic cracking reactions, to the maximum extent possible.

In support of criterion (a) above, LibertyWorks™ predicted the thermal performance of the selected Lamilloy test articles using their proprietary analysis tool LAMILOP3. This analysis predicted the coolant flow rate and associated pressure drop required to maintain Lamilloy metal temperature below an acceptable maximum for the hot gas environment defined by NGST (criterion "b"). The tool analyzes an isolated micro-model of a single Lamilloy "cell" to predict coolant flow rates, pressure drops, coolant and metal temperatures at each layer. Three Lamilloy configurations that were analyzed with three coolants: gaseous nitrogen, water and RP-1, prior to testing.

Also in support of criterion (a), a CFD model of a single perforated metal sheet was developed, by AFRL/EAFB, to provide additional insight into the performance of the Lamilloy test articles with gaseous nitrogen coolant. The model used hot-side hole diameters, spacing, and metal thickness that matched the Lamilloy specimen geometries, but did not capture the multilayer features of the test articles. This simplified CFD modeling approach pursued an implicit, steady state, fully converged solution.

Key to accomplishing all four objectives of this investigation was the experimental measurement of cooling performance using the AFRL EC-1 test facility. Hardware that mated to an existing subscale rocket injector test rig on AFRL's EC-1 stand was designed, fabricated, and installed to conduct this hot-fire investigation. This hardware consisted of a water-cooled copper chamber with a 1in. square by 7in. long transpiration-cooled section that is mated upstream to an existing 2in. square main combustion chamber. This test rig consists of the following water-cooled hardware: the forward transition piece, the 1in. square main test section assembly, aft transition piece, and the nozzle sub-assembly. The main test section assembly accommodates a flat sheet Lamilloy test article, to which coolant is supplied through a flow distribution plate upstream of it, as illustrated in Figure 3. The section that houses and feeds coolant to the test article was designed for quick change out of the Lamilloy sheet and distribution plate. The nozzle sub-assembly at the discharge of the test section consists of the nozzle body, the nozzle insert, and retaining ring. This sub-assembly design allows for quick change out of the nozzle insert to vary test chamber operating pressure. All sections have water passages for cooling. Since testing at the TR107 chamber pressure of 2,500 psia was not feasible in the AFRL EC-1 test facility, a maximum test chamber pressure of 750 psia was deemed adequate for capturing the driving physical mechanisms present in the transpiration process. This chamber pressure is approximately twice the critical pressure of RP-1 so RP-1 was supercritical. It should be noted that this chamber pressure is slightly less than the critical pressure of nitrogen and definitely less than the critical pressure of water so both of those transpirants are likely subcritical.

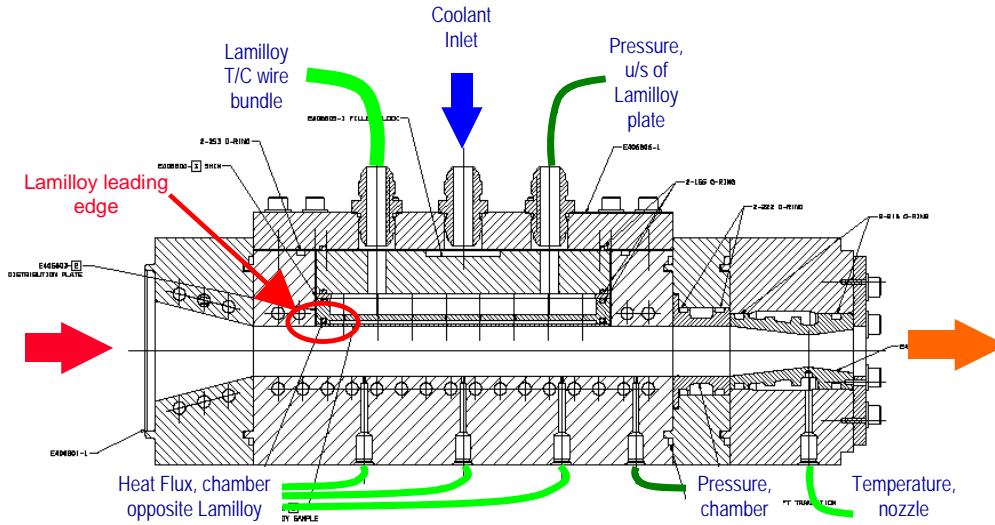

**Figure 3. The test section was designed for quick change out of the Lamilloy® sheet and distribution plate.**

The AFRL/EAFB EC-1 test facility can supply controlled GOX and hydrocarbon propellants to combustion devices running at chamber pressures up to 1,200 psia at thrust levels up to roughly 500 pounds. For this test program several existing test rig components were used, including the injector, the GOX/GH2 igniter, and the main 2"-square combustion chamber. The injector used is a swirl-coaxial "converger" designated "-11" that has demonstrated extremely stable combustion performance, high efficiency over a wide mixture ratio range and acceptable thermal performance in previous test programs<sup>10</sup>.

Instrumentation and control features of this test set-up are illustrated in Figure 4. Instrumentation upstream of the forward transition piece (labeled "NG New Engine Section" in Figure 4) is considered "facility" instrumentation; downstream, "test section" instrumentation. Pressures were measured with strain gage type pressure transducers (Stellar ST1500) with a range of 0-3,000 psig and accuracy of 0.1% of full range. Metal and fluid temperatures were measured with a combination of type K and E-type thermocouples.

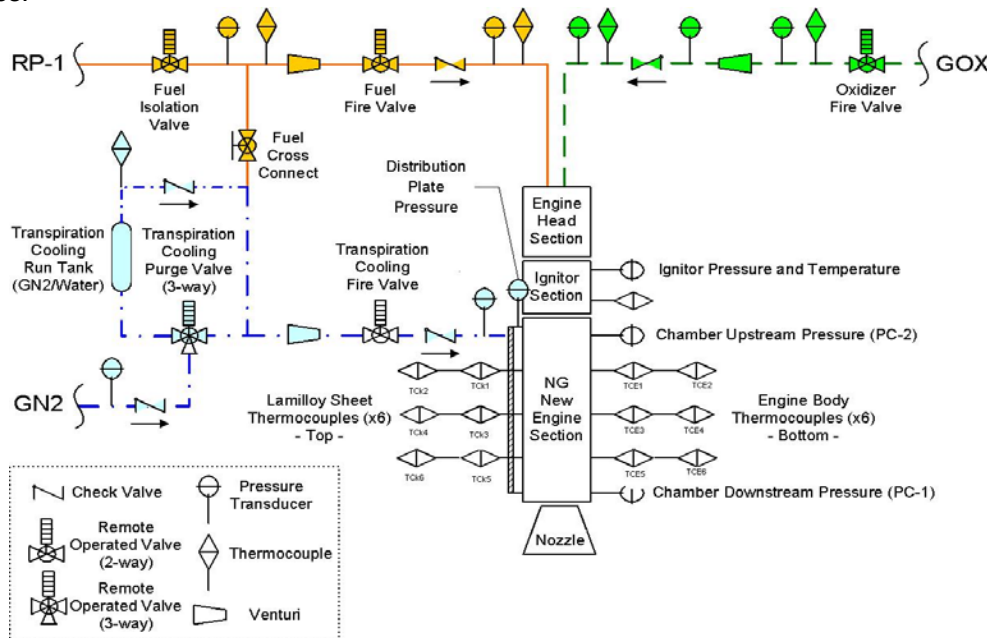
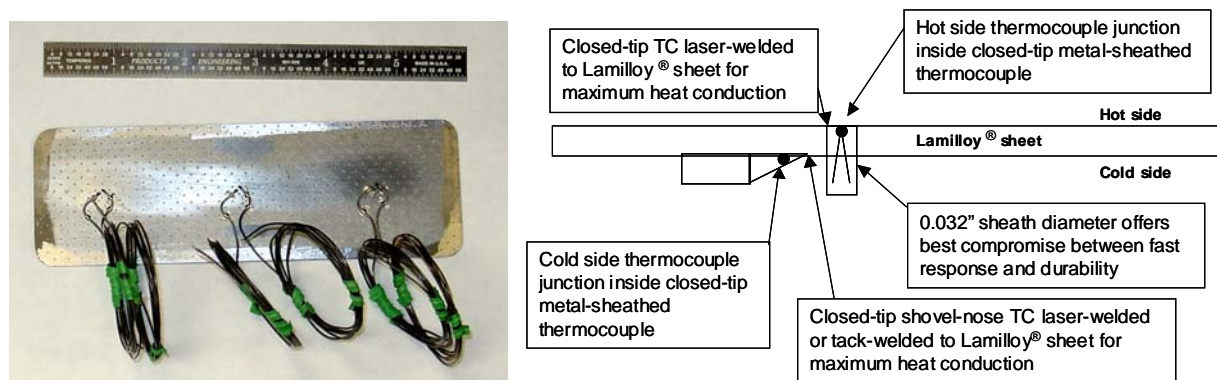

**Figure 4. Test Facility Schematic for AFRL's EC-1**

Coolant pressures were measured both upstream of the coolant distribution plate and between the distribution plate and Lamilloy sheet. Hot gas stream pressures were measured at the test section inlet (downstream of igniter) and exit (upstream of flow restricting nozzle). Coolant distribution plates were used to create a high pressure-drop flow-restricting interface between the coolant supply and the relatively low pressure-drop expected through the Lamilloy test articles.

Metal temperatures in the test section copper wall opposite the Lamilloy test article were measured by Medtherm (Model 11413) dual-coaxial, Type E thermocouples. These are designated as TCE1-6. TCE1, TCE3, and TCE5 and are installed flush with the hot surface of this wall. These thermocouples are placed in axial (streamwise) locations that correspond directly to thermocouple placement on the test article (1", 3", and 5" downstream of the Lamilloy leading edge). Thermocouples designated TCE2, TCE4, and TCE6 were placed on the water-cooled surface of the copper wall at the same streamwise locations as the other sets, to estimate wall heat flux.

A total of three transpiration cooling test samples were fabricated from existing (off-the-shelf) stock of LibertyWorks™ 2- and 3-ply combustor Lamilloy sheet. This enabled affordable, quick fabrication of test articles from existing sheets of representative high strength, high temperature materials. A total of 6 test articles were fabricated, 2 of each sample type. The edges of the test articles were sealed by TIG welding around the perimeter and weld penetration depth is estimated to be ~ 0.060". An instrumented test sample is shown in Figure 5.



**Figure 5. Lamilloy® test articles were instrumented with 3 hot-side and 3 cold-side thermocouples**

Each of the Lamilloy samples was installed with 6 closed tip welded-on Type K thermocouples whose leads were routed through the distribution plate, pedestal and out the top cover. The thermocouples were installed at three streamwise, locations (1, 3, and 5 in. downstream of the leading edge) on the centerline of the sample. Hot- and cold-side thermocouple pairs were co-located at each measurement site to measure the through-the-wall temperature gradient. These are designated as TCK1-6. TCK1, TCK3, and TCK5 are the hot-side upstream, mid, and downstream thermocouples, respectively. The TCK2, TCK4, and TCK6 are the corresponding cold-side thermocouples.

Based on the test specimen cooling performance predicted by the LAMILOP3 analysis, and copper wall temperatures predicted by NGST thermal analysis for low pressure cooling water, an initial run time limit of 1.5 to 2 seconds was established to keep the copper walls below the maximum allowable temperature of 1200°F and avoid overheating of the test specimens. Thermal analyses by NGST also estimated that the achievable heat flux in the test section was limited to 10 BTU/sec/in.<sup>2</sup>, which was marginally below the goal of 15 BTU/sec/in.<sup>2</sup>, or 50% of the TR107 main combustion chamber level. The test section hardware was designed for indefinite run durations at a maximum heat flux of 20 BTU/sec/in.<sup>2</sup> in anticipation of a planned facility upgrade to a 1,000-psi cooling water capability.

The test section hardware (specifically the flow restricting discharge nozzle) was designed to support nominal operating pressures of 500 and 750 psia. Such operating pressures ensured that coolant pressures did not drop below the 315 psia critical pressure of RP-1, thereby preventing phase change in the passages of the Lamilloy test articles when used with RP-1.

## RESULTS AND DISCUSSION

A total of forty-six (46) transpiration-cooling tests were completed, which included the three different Lamilloy designs; three coolant fluids: GN2, water, and RP-1. Coolant flowrates were varied between 1.5 and 3.5 times predicted ideal coolant flowrates. Heat flux ranging from 5 to 10 BTU/sec/in.<sup>2</sup> with mixture ratio (MR) 1.2 to 1.8 and chamber pressures ranging from 370 to 670 psig were examined. The most significant limitation to increasing the run time and heat flux (proportional to mixture ratio) inputs for this investigation was localized overheating of the test specimen leading edge, which is discussed later in this section.

The first coolant tested was gaseous nitrogen. Extensive testing with this coolant was conducted in order to establish the baseline characteristics and gain a better understanding of the effects of coolant flow rate and hot gas mixture ratio on cooling effectiveness in a rocket environment. The analytical predictions for the GN2 results are also the most well anchored since Lamilloy has been designed and developed almost exclusively for air cooling applications. Therefore, any discrepancies between measured and predicted results could be explored analytically with a high probability of successful resolution. Only minor erosion of the Lamilloy test article leading edge was observed over the range of coolant flow rates (3X to 1.5X ideal) at a fixed MR of 1.4 and run duration of 1.25 seconds. However, as mixture ratio (and corresponding heat flux) was increased (to MR = 1.6), the leading edge of the Lamilloy sheet experienced localized melting over approximately 0.15 in. axial length. The melting was ascribed to thermal isolation from the coolant plenum and a lack of cooling holes in the perimeter weld area as shown in Figure 6. Another significant contributing factor is believed to be the relatively small pressure difference through the thickness of the test specimen near the leading edge. Indeed, the freestream pressure drop along the length of the test specimen actually exceeded the pressure drop through the test specimen, as shown in Figure 7. This can easily be corrected in future efforts.

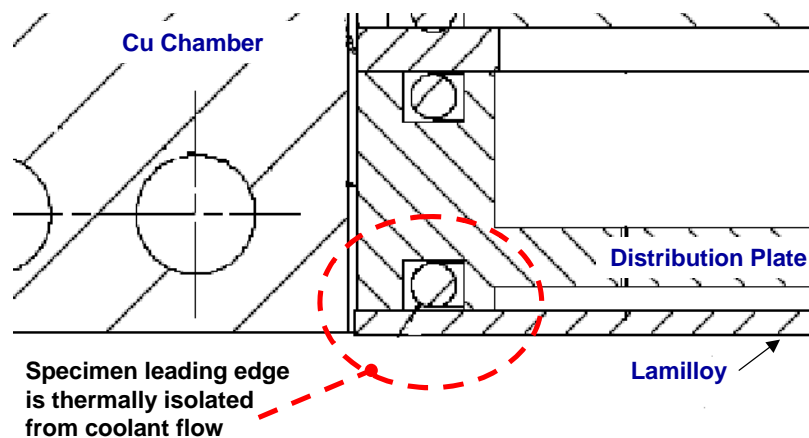
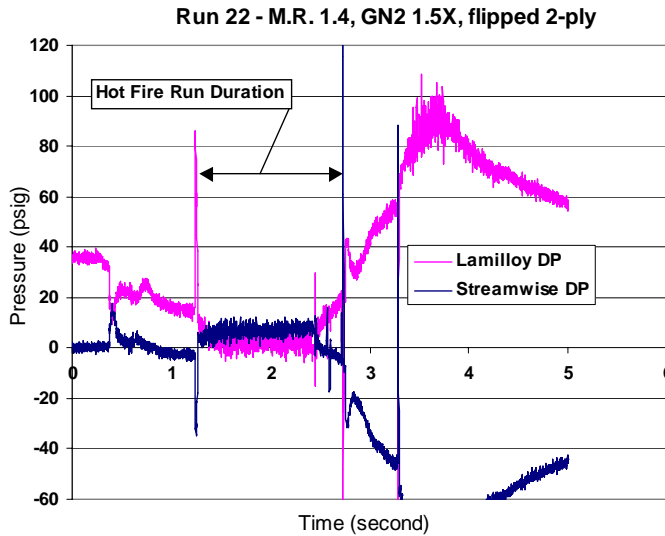

Figure 6. Thermal isolation of test specimen leading edge contributed to overheating.





**Figure 7. The freestream pressure drop along the length of the test specimen exceeded the pressure drop through the test specimen during the hot fire test duration.**

However, the most important result of the testing with GN2 coolant is the excellent agreement between measured and predicted cooling effectiveness, as shown in Figure 8, which plots cooling effectiveness as a function of non-dimensional cooling flow. Note that the actual test points were run at significantly higher cooling flows than recommended by the pre-test analysis in order to avoid the local flow starvation at the specimen leading edge discussed previously. Temperature measurements at the upstream end of the specimen indicated cooling effectiveness higher than that predicted for two of the four test cases plotted. This discrepancy is best explained by convective cooling of the thermocouple leads inside the supply plenum at the higher coolant flow rates, resulting in conduction of heat away from the hot tip and lowering the tip temperature.

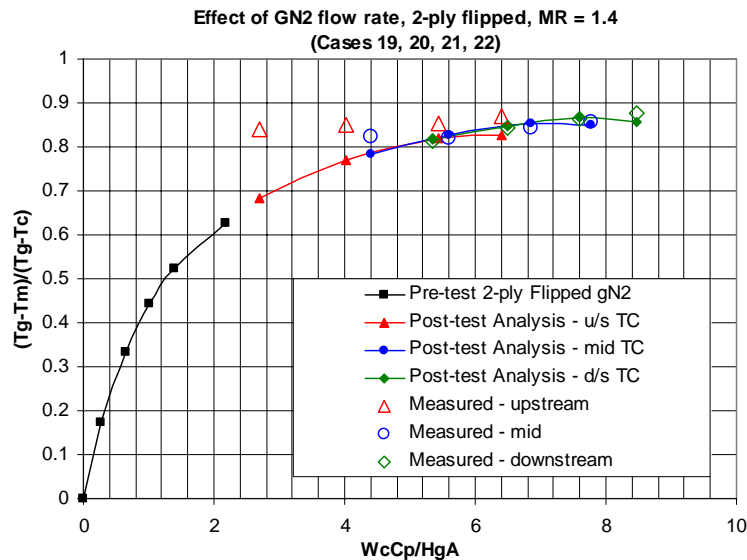

**Figure 8. Excellent agreement was observed between measured and predicted cooling effectiveness for GN2 coolant.**

Similar levels of cooling effectiveness and agreement between measurements and predictions were observed between the 2- and 3-ply specimen designs tested with GN2 coolant, as expected from pre-test thermal analyses of the samples. Predicted pressure drop across the Lamilloy specimens was also consistent with experimental results.



The results of the single-sheet CFD analysis for GN2 coolant provided further insight into the experimental results. Figure 9a shows the predicted gas temperature profile. The higher gas temperature near the leading edge is consistent with test observations. Note that the boundary layer grows to approximately 25% of channel height, forcing hot gases away from the test specimen surface. It is not clear at this time if this phenomenon was substantiated by the thermocouple readings in the copper section opposite the transpired wall. This behavior is not representative of an actual engine, in which the hot core would remain confined to the center of the chamber.

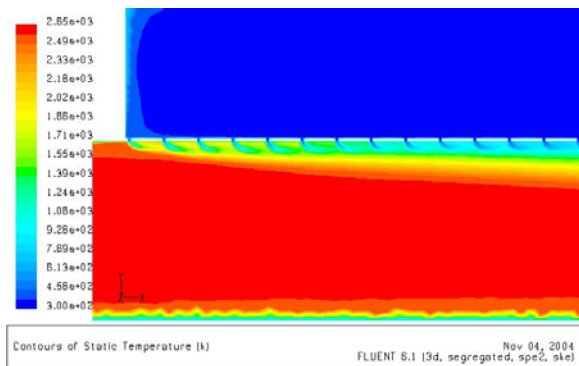

Figure 9a. Gas temperature profile

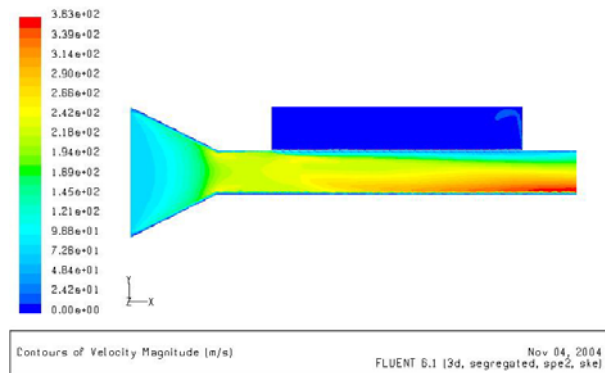

Figure 9b. Gas velocity profile

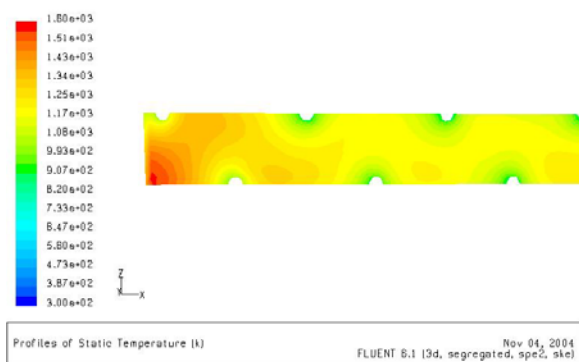

Figure 10a. Leading edge temperature

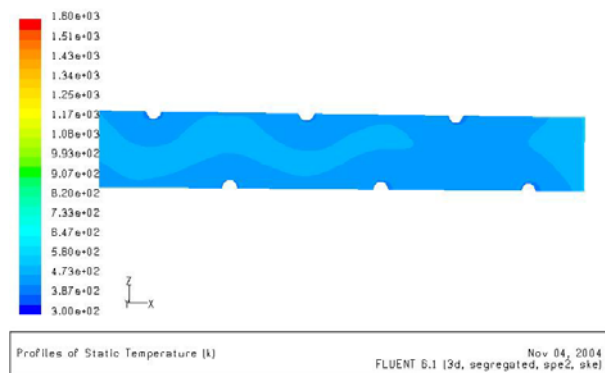

Figure 10b. Trailing edge temperature

The predicted gas velocity profile in the test section is shown in Figure 9b. Velocity is low near the single sheet surface. The displacement thickness of the injected cooling flow reduces the effective channel height at it approaches the downstream end of the test section, causing the highest freestream velocity in this area.

The predicted single-sheet surface temperatures at the leading and trailing edges of the test specimen are shown in Figure 10a and Figure 10b, respectively. The peak leading edge temperature is estimated at 2400°F, or roughly the melting temperature of the specimen material. The trailing edge peak temperature is calculated at about 300°F. These estimates are consistent with experimental measurements.

Hot-fire testing with water as the coolant followed GN2 testing. The initial water test was run at a hot gas mixture ratio of 1.4 (lowest heat flux level) and a conservatively high coolant flow rate (3X nominal). Upon post-test disassembly and inspection, the specimen leading edge was found to have melted as shown in Figure 11. Since GN2 coolant at equivalent conditions performed well, the damage in this instance could not be ascribed to the poor coolant distribution and low leading-edge pressure drop factors discussed previously. Instead, soot and streak patterns on the specimen (shown in Figure 11) suggest that the water was boiling over a significant portion of the Lamilloy sheet. This is believed to have

not only degraded heat transfer within the specimen internal passages but also diverted liquid coolant to the aft end due to the decreased density of the coolant (i.e., water vapor) near the leading edge.

To test the boiling hypothesis the chamber pressure was increased by installing the smaller of the two test section discharge nozzles, thereby increasing the water boiling point by about 100°F. The smaller nozzle (and higher chamber pressure) also decreased the freestream velocity and the streamwise pressure drop associated with it. Based on the lessons learned from the GN2 testing, it was predicted that the reduced streamwise pressure drop would improve coolant distribution. The Lamilloy sheet damaged in the previous run was rotated 180 degrees (leading edge is now the trailing edge) and re-used to provide a specimen with an undamaged leading edge. Testing continued with MR reduced to 1.2 but keeping the same water flow rate. Neither localized melting at the leading edge nor evidence of water boiling on the Lamilloy sheet were observed. Increasing test chamber pressure improved cooling performance with water, as shown in Figure 12.

To further explore the boiling hypothesis, the effects of run duration and water injection timing (relative to hot-fire ignition) were assessed. Increasing the run duration from 0.75 to 1.25 seconds (at the higher chamber pressure) produced no specimen melting or reduction in cooling performance. Starting water injection 200 ms before hot-fire ignition showed no effect on pressure or temperature profiles, indicating that the cooling flow was fully developed before ignition in both cases.

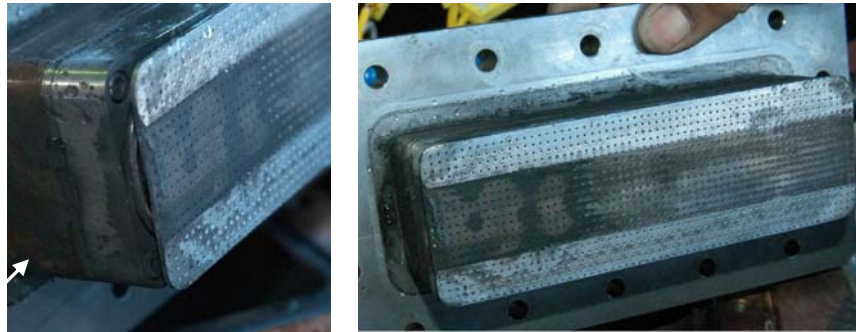

Figure 11. Soot and streak patterns on the specimen suggest that the water was boiling.

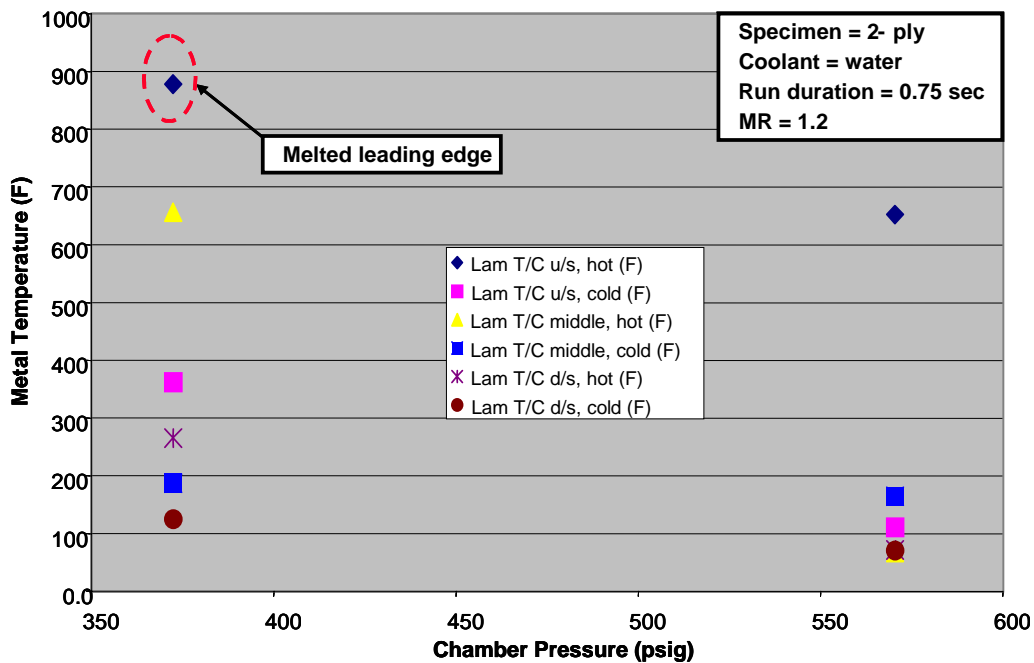

Figure 12. Increasing test chamber pressure eliminated water boiling.

With the boiling issue resolved, the higher test chamber pressure was used for the remainder of testing. The effect of water flow rate was investigated and the results are shown in Figure 13. In general, water flow rate had no effect over the range tested, except at the lowest flow rate, where the minute pressure drop across the Lamilloy at the leading edge allows some ingress of hot gas. The test specimen was “overcooled” in all cases due to the high coolant mass flow allowed by low-pressure-drop test specimens designed for air cooling.

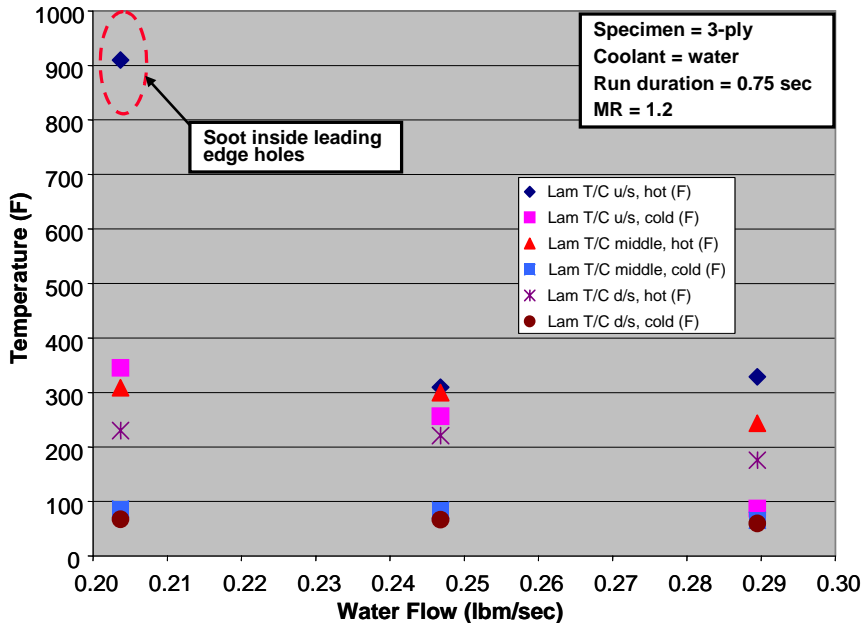

Figure 13. Water flow rate had no effect over the range tested.

The last coolant tested was RP-1. Three runs were completed with a 3-ply test specimen at a mixture ratio of 1.2 and coolant flow rate of 2.5X nominal before schedule constraints ended the testing activity. The smaller discharge nozzle (higher test chamber pressure) was used. The duration of the three tests was increased from 0.25 to 0.5 to 1.0 seconds, respectively. GN2 flow was used as a purge gas before and after hot-fire ignition to remove any combustible fluid from the specimen passages. There did not appear to have been significant RP-1 combustion with the core flow nor appreciable endothermic cracking reaction near the wall. Cooling performance results for the maximum flow RP run is shown in Figure 14, which compares all three coolants tested. As can be seen in the figure, the cooling effectiveness of RP-1 is similar to the other transpirants tested.

## CONCLUSIONS AND RECOMMENDATIONS

The relatively low-pressure drop across the Lamilloy test articles had a significant effect on the coolant flow uniformity and associated thermal performance of the test articles. In most cases the upstream portions of the test specimens tended to be undercooled and downstream portions overcooled. Such results underscore the need for higher pressure drop, rocket-specific Lamilloy designs that vary pressure drop (porosity) in the streamwise direction to provide the optimum cooling flow and prevent hot gas ingress.

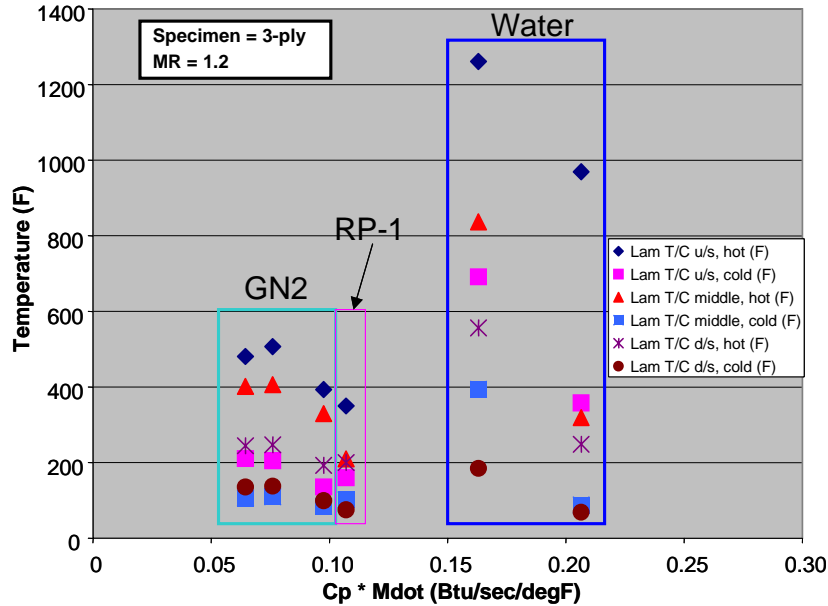

Figure 14. The cooling performance of RP-1 was comparable to GN2 at similar hot-fire conditions.

The analytical tools used to predict flow characteristics and thermal performance of the Lamilloy test specimens were shown to be accurate for the gaseous nitrogen coolant and captured general cooling levels and trends correctly for the liquid coolants. Maintaining chamber pressures above liquid coolant critical pressures should preclude the need to further develop these tools to model phase change, but supercritical fluid properties may need to be added. A more rigorous treatment of liquid flow phenomena in these tools may be warranted.

The test facility used for this test program was demonstrated to be sufficiently capable and adaptable to respond to developments as they occurred. The addition of 1000 psi water cooling capability will allow high heat flux levels to be studied. The relatively high streamwise pressure drop and aggressive heat flux condition at the specimen leading edge are conditions unique to the test facility and would not be encountered in the environment of an actual rocket combustion chamber where velocities are low and propellants are mixing more than burning at the upstream section of the cooled wall. A row of holes or a slot upstream of the sample to film cool the leading edge is recommended for future test programs.

Soot generated by the combusting RP-1 fuel formed patterns on the test article surface that were helpful for making a qualitative assessment of cooling performance. As shown in Figure 15, the clean shiny appearance of the surface at the upstream end indicates uniform spanwise film coverage undiluted by the hot gas flow. As the cooling film mixes with the hot gas flow further downstream soot deposits are formed on the surface, but the surface immediately surrounding each hole remained relatively clean along the entire test article length as expected.



Figure 15. Soot patterns were helpful for making a qualitative assessment of cooling performance.

All success criteria established at the outset of the test program were met. The extensive database generated can be used to guide future Lamilloy designs for rocket engine applications to overcome the coolant distribution issues encountered. Follow-on efforts in this regard would benefit from these recommendations:

- The hot gas streamwise pressure gradient in the current test facility should be compared with the gradients expected in an "actual" rocket chamber environment. The test section should be modified as feasible to either minimize the streamwise pressure gradient or make it representative of an "actual" environment (which it may be already).
- Future Lamilloy test articles should be designed with pressure drop on the order of 10-20 percent  $\Delta P/P$ , and porosity (coolant flow) should be tailored to meet streamwise variations in hot gas pressure. The latter could be accomplished by employing isolated compartments either in the coolant supply plenum or test articles themselves. Such efforts would be a necessary first step to minimizing total coolant flow while maximizing thermal effectiveness along the entire surface of the test article. As the understanding of the flow conditions improve, there will be the potential to decrease the required pressure drop.
- Trade studies should be performed to determine the best approach to achieving higher  $\Delta P$  Lamilloy designs within manufacturing constraints (e.g., hole size and sheet forming) while maintaining high levels of thermal performance.
- Regardless of the approach used to increase Lamilloy pressure drop and tailor it to streamwise pressure distribution for rocket applications, the flat plate test article configuration should be maintained for its ease of fabrication, instrumentation, testing and analysis.

## ACKNOWLEDGEMENTS

This work was performed by NGST in partnership with AFRL/EAFB and Rolls-Royce North American Technologies, Inc under NRO/OSL/APD FASTMAXII PO NRO000-02-05-0516. The NGST Program Manager was Mr. Arturo Casillas and NRO Program Manager was Capt. Erin Ryan. The authors gratefully acknowledge the following significant contributors:

- NGST: Jason Gromski, Paul Kim, Don Miller, and Tom Wang
- AFRL/EAFB: Ben Gleason, Toya Johnson, Soren Keuhn, Keith Lawson, Earl Thomas, Joel Wheaton, and Mark Wilson
- Rolls-Royce: Tom Hensler, Okey Kwon, and Steve Pantazis
- The Aerospace Corporation: Ken Behring

## REFERENCES

1. DRD 951-MA-011. 2nd Generation RLV - Risk Reduction Program TA8 - Propulsion; Main Engine Project Element 1.0 Mlb LOX/RP-1 Main Engine Study. Final Report/Final Quarterly Report, March 31, 2002. NASA Contract: NAS8-01110, CLIN 001 with Northrop Grumman Space Technology.
2. JOURNAL OF SPACECRAFT AND ROCKETS 1996. 0022-4650 vol.33 no.3 (453- 455). "Effect of transpiration cooling on nozzle heat transfer". Chen, F. (USAF, Inst. of Technology, Wright-Patterson AFB, OH); Bowman, W. J. (USAF, Inst. Of Technology, Wright-Patterson AFB, OH); Bowersox, R. (USAF, Inst. of Technology, Wright-Patterson AFB, OH).
3. AIAA 2003-125. "Swirl Coaxial Injector Development". R.K. Cohn, P.A. Strakey, R.W. Bates and D.G. Talley (Air Force Research Laboratory, Edwards AFB, CA), and J.A. Muss and C.W. Johnson (Sierra Engineering Inc., Carson City, NV). 41<sup>st</sup> Aerospace Sciences Meeting and Exhibit. 6-9 January 2003, Reno, Nevada.