

NSRP #0140

**MANUFACTURING TECHNOLOGY
FOR
SHIPBUILDING**

SHIPBUILDING TECHNOLOGY TRANSFER

**U.S. Department of Transportation
Maritime Administration**

**in cooperation with
Avondale Shipyards, Inc.
New Orleans, Louisiana**

Report Documentation Page

Form Approved
OMB No. 0704-0188

Public reporting burden for the collection of information is estimated to average 1 hour per response, including the time for reviewing instructions, searching existing data sources, gathering and maintaining the data needed, and completing and reviewing the collection of information. Send comments regarding this burden estimate or any other aspect of this collection of information, including suggestions for reducing this burden, to Washington Headquarters Services, Directorate for Information Operations and Reports, 1215 Jefferson Davis Highway, Suite 1204, Arlington VA 22202-4302. Respondents should be aware that notwithstanding any other provision of law, no person shall be subject to a penalty for failing to comply with a collection of information if it does not display a currently valid OMB control number.

1. REPORT DATE 1983		2. REPORT TYPE N/A		3. DATES COVERED -	
4. TITLE AND SUBTITLE Manufacturing Technology for Shipbuilding				5a. CONTRACT NUMBER	
				5b. GRANT NUMBER	
				5c. PROGRAM ELEMENT NUMBER	
6. AUTHOR(S)				5d. PROJECT NUMBER	
				5e. TASK NUMBER	
				5f. WORK UNIT NUMBER	
7. PERFORMING ORGANIZATION NAME(S) AND ADDRESS(ES) Naval Surface Warfare Center CD Code 2230 - Design Integration Tools Building 192 Room 128 9500 MacArthur Bldg Bethesda, MD 20817-5700				8. PERFORMING ORGANIZATION REPORT NUMBER	
9. SPONSORING/MONITORING AGENCY NAME(S) AND ADDRESS(ES)				10. SPONSOR/MONITOR'S ACRONYM(S)	
				11. SPONSOR/MONITOR'S REPORT NUMBER(S)	
12. DISTRIBUTION/AVAILABILITY STATEMENT Approved for public release, distribution unlimited					
13. SUPPLEMENTARY NOTES					
14. ABSTRACT					
15. SUBJECT TERMS					
16. SECURITY CLASSIFICATION OF:			17. LIMITATION OF ABSTRACT SAR	18. NUMBER OF PAGES 237	19a. NAME OF RESPONSIBLE PERSON
a. REPORT unclassified	b. ABSTRACT unclassified	c. THIS PAGE unclassified			

NSRP #0140

**MANUFACTURING TECHNOLOGY
FOR
SHIPBUILDING**

SHIPBUILDING TECHNOLOGY TRANSFER

**U.S. Department of Transportation
Maritime Administration**

**in cooperation with
Avondale Shipyards, Inc.
New Orleans, Louisiana**

UMTRI

70681

PROCESS LANES AND DESIGN ENGINEERING
FOR ZONE OUTFITTING
AVONDALE SHIPYARDS, INC.
SEMINAR
JUNE 7 & 8, 1984

PROCESS LANES AND
DESIGN ENGINEERING FOR ZONE OUTFITTING
AVONDALE SHIPYARDS, INC.

BACKGROUND AND INTRODUCTION

Prepared by: R. A, PRICE

PROCESS LANES AND DESIGN ENGINEERING

FOR ZONE OUTFITTING

AGENDA

First Day - June 7, 1984

07:30 - 07:40	Introduction	R. Price
07:40 - 08:15	Concept	E. James
08:15 - 09:15	Physical Process Lanes	D. Smith
09:15 - 09:30	Break	
09:30 - 10:30	Unit Breakdown and Scheduling	D. Smith
10:30 - 11:15	Coding Systems	A. Dufrene
11:15 - 12:00	Material Flow	G. Grimsley
12:00 - 13:00	Lunch	
13:00 - 13:45	Schedule Planning for Hull Construction	E. James
13:45 - 14:45	Planning Control Systems	D. Bergeron
14:45 - 15:00	Break	
15:00 - 16:00	Production Cost Controls	R. Oehmichen

Second Day - June 8, 1984

07:30 - 08:15	Production Planning and Control	D. Bergeron
08:15 - 09:00	Zone Outfitting Concepts	G. Grimsley
09:00 - 09:30	Moldloft	B. Pourciau
09:30 - 09:45	Break	
09:45 - 10:15	Accuracy Control	J. Taylor W. Weidman
10:15 - 11:30	Design Engineering for Zone Outfitting	J. Wilkins
11:30 - 12:30	Lunch	
12:30 -	Yard Tour	

PROCESS LANES AND
DESIGN ENGINEERING FOR ZONE OUTFITTING
BACKGROUND AND INTRODUCTION

I. INTRODUCTION

MarAd, over the past several years, sponsored a series of studies on the level of technology in U.S. shipyards. In fiscal year 1980, MarAd and Avondale cooperated on a "Technical Evaluation of Avondale's Production Operations and Organization, the Development of a Long Range Facilities Plan, and the Integration of Both," under Contract No. M9-80-DOC-O1O17. The technical evaluation of Avondale's Production Operations and Organization was performed by Ishikawajima-Harima Heavy Industries (IHI). In this study, Avondale concluded that they could significantly improve their productivity by using the IHI technology. But, there are so many areas that could be affected - many of which are outside the shipyard control - that Avondale could not implement all of the recommended changes at one time.

In order to improve productivity the most with the least amount of disruption, Avondale proposed to implement four of the IHI systems recommended in the Technical Evaluation. They are:

Accuracy Control

Production Planning

- Design Engineering for Zone Outfitting

Process Lanes

This effort was to be a demonstration intended not only for the benefit of Avondale, but of all U.S. shipyards. Avondale was required to work closely with MarAd and the U.S. shipbuilding community to insure adequate dissemination of information.

II. OBJECTIVES

The objectives were to decrease the time between the contract date and ship delivery and to increase productivity and reduce cost.

The following specific objectives arose out of the Technology Evaluation:

implement the IHI system of accuracy control at Avondale;
implement the IHI system of production planning at Avondale;
implement the IHI system of design engineering with procurement specifications at Avondale.

Process Lanes

Each of the four systems were broad and extensive. In order to implement the systems, the following action was taken:

- A) We selected the specific elements within each of the four systems which realize the most significant improvement in productivity with the least amount of disruption during the integration period.
- B) We determined to what extent the selected elements must be tailored for adoption for Avondale and for use as an Americanized version of Japanese technology.
- C) We determined what elements of the four systems are measurable and that a comparison can be made between the method previously being used and the method finally adopted.

The subject of this seminar is Process Lanes and Design Engineering for Zone Outfitting. An agenda of the seminar is included in the handbook.

This is the last of the Technology Seminars and we feel the format is suitable to demonstrate that implementing this technology requires that all departments of a company must work as a team and re-align their thinking in order to succeed.

PROCESS LANES AND DESIGN ENGINEERING
FOR ZONE OUTFITTING
AVONDALE SHIPYARDS, INC.

PROCESS LANES CONCEPT

Prepared by: E. L. JAMES

PROCESS LANES AND DESIGN ENGINEERING
FOR ZONE Outfitting
PROCESS LANES CONCEPT

I. INTRODUCTION TO PROCESS LANES

The historical evolution of Japanese technology transfer to American shipbuilding has been adequately covered in many previous seminars and discussions and, therefore, will not be discussed to any detail in the presentation given today.

In today's sessions we will focus specifically on the sequential development of the process lanes concept at Avondale. We will discuss the concept and the subsequent application of the process lanes principles, specifically, within the Avondale environment. This represents the task of assimilating the IHI technology principles and adapting them to our own shipbuilding environment.

It is very important to note throughout the presentations today that the many significant features of process lanes can be developed and implemented independently and/or in varying combinations in the pursuit of achieving a total system. This point highlights the important flexibility feature of the process lanes application.

II. THE PROCESS LANES CONCEPT – DEFINED (GRAPH NO. PL-01)

“The process lanes concept means very simply the categorization and separation of ‘like’ kinds of work and subsequent development of work centers specifically designed to efficiently and economically produce that kind of work. Process lanes establishes the greatest amount of ‘learning curve’ efficiency by having the same people at the same work centers doing repetitive types of work every day with the support of a well organized and efficient flow of material.”

We will discuss the work centers and the concept of categorization in more detail in the next several presentations, but for now just visualize how General Motors has arranged their product assembly lines. The Chevrolet Caprice is assembled on one line, a Monte Carlo on another line, a Corvette on yet another line and finally the Chevette. Why has GM set up such a process? Very simply, the duration time and the tooling requirements are very different. Can you imagine the disruption to the assembly line of a Caprice requiring a specific size torque wrench when confronted with a Chevette requiring a five minute duration and the worker has to re-tool. The flow of material and like work would certainly be

unfavorable, and the cost of the Chevette could feasibly equal that of the Caprice. In essence, the factory concept and/or the process lanes concept of categorization and flow is not so new in this country, just new to the shipbuilding community. In fact, we have been utilizing the basic principles of process lanes even in shipbuilding on specific isolated processes.

III. THE REQUIREMENTS OF PROCESS LANES

Obviously, with the advent of the process lanes study and a sound comprehension of the concept, it was determined that the principles of process lanes, as well as many of the controls, did not exist at Avondale. In fact, those conditions contrary to process lanes and prevalent to the conventional construction method did indeed exist as follows (GRAPH PL-02):

Different types of units were assembled at the same location

- The same units required various assembly duration times.
- There were different types of assembly platen
- Different types of material were required at each assembly platen
- Material flow presented on site storage problems increasing material handling and storage cost.

The above mentioned conditions and/or symptoms of conventional construction methods tended to decrease efficiency, productivity and accuracy of the product. Naturally, these observations presented a variety of obstacles that must be overcome in the course of developing and implementing the requirements of an effective process lanes system.

The implementation of an effective process lanes system at ASI has placed detailed emphasis on several requirements which includes the physical aspect of process lanes (facilities), unit breakdown, material flow, coding systems, cost system, planning systems, scheduling systems and control systems (SEE GRAPH PL-03). The principles of the Product Work Breakdown System (PWBS) provide the base for evolvement of the above identified requirements.

Detail process lanes schedule development, which will be discussed in much more detail later, provides the controls and risibility essential to determining the work center cost and efficiency. The detail emphasis on the entire process enhances both flexibility and control. It is through detail attention to these concepts that a uniform work flow within each work center and coordinated outputs for all work centers are achieved. Prime ingredient to the success of developing and

executing the process lanes system is discipline and attention to detail. It is this detail attention to the interim product which further enhances the flexibility aspect of the system.

The IHI concept requires that industrial engineers be assigned to work centers for each stage of construction, to study and establish detail work center schedules, to collect and monitor performance and adherence to schedule from the work center foreman daily and to prepare management reports. For this philosophy, Avondale has adopted a similar approach, whereby Production Planning monitors and reports schedule progress on each work center, Daily detail attention to each work center progress is provided With the addition of a strong shop planning function. In addition, Production Engineering routinely monitors and reports each work center cost and actual manhour cost per ton versus projected cost per ton efficiency.

The detail and flexibility of the system allows feedback from the work centers to be acted on and options exercised to assure that the necessary corrective action is taken, if required.

It is quite simple to envision change in technology; however, it is quite another matter in the implementation of change. The transition from conventional methods to the process lanes concept gives rise to all the well known objectives and cliques associated with change. We have experienced all of these, but we have enjoyed the good fortune of executive management commitment. The development and implementation of the process lanes system has been achieved with a wide cross section of ASI personnel which includes the management and workers of Production, Design and the support departments. Advisory services from IHI have contributed immensely to the success of deriving this system. The system justifies the effort; it is feasible; it is workable; it has definable benefits; and, furthermore, at Avondale we are committed. We accept the new technology as a basic functional part of doing business.

The remainder of the day will be dedicated to the detail requirements of process lanes as highlighted on GRAPH PL-03. Next, we will discuss some of the basic initial requirements of the physical process lanes.

QUESTIONS/ANSWERS

INTRODUCE NEXT SPEAKER

PROCESS LANES CONCEPT

DEFINED:

THE PROCESS LANES CONCEPT MEANS VERY SIMPLY THE CATEGORIZATION AND SEPARATION OF "LIKE" KINDS OF WORK, AND THE SUBSEQUENT DEVELOPMENT OF WORK CENTERS SPECIFICALLY DESIGNED TO EFFICIENTLY AND ECONOMICALLY PRODUCE THAT KIND OF WORK. PROCESS LANES ESTABLISHES THE GREATEST AMOUNT OF 'LEARNING CURVE" EFFICIENCY BY HAVING THE SAME PEOPLE AT THE SAME WORK CENTERS DOING REPETITIVE TYPES OF WORK EVERY DAY WITH THE SUPPORT OF A WELL ORGANIZED AND EFFICIENT FLOW OF MATERIAL.

EXISTING CONDITIONS CONTRARY TO
PROCESS LANES

- 1) DIFFERENT TYPES OF UNITS WERE ASSEMBLED AT THE SAME LOCATION.
- 2) THE SAME UNITS REQUIRED VARIOUS ASSEMBLY DURATION TIMES.
- 3) THERE WERE DIFFERENT TYPES OF ASSEMBLY PLATENS.
- 4) DIFFERENT TYPES OF MATERIAL WERE REQUIRED AT EACH ASSEMBLY PLATEN.
- 5) MATERIAL FLOW PRESENTED ON-SITE STORAGE PROBLEMS INCREASING MATERIAL HANDLING AND STORAGE COST.





THE KEY REQUIREMENTS OF PROCESS LANES

- 1) PHYSICAL PROCESS LANES
(FACILITIES, PLATENS, ETC.)
- 2) UNIT BREAKDOWN
- 3) CODING SYSTEMS
- 4) MATERIAL FLOW
- 5) HULL PLANNING AND SCHEDULING
- 6) PLANNING CONTROL SYSTEMS
- 7) COST CONTROL SYSTEMS



PROCESS LANES AND DESIGN ENGINEERING
FOR ZONE OUTFITTING
AVONDALE SHIPYARDS, INC.

PHYSICAL PROCESS LANES

Prepared by: D. SMITH

PROCESS LANES AND DESIGN ENGINEERING
FOR ZONE OUTFITTING
PHYSICAL PROCESS LANES

I. INTRODUCTION

Process Lanes, in the preceding discussion, was defined as the categorization and separation of like kinds of work and the development of work centers specifically designed to efficiently and economically produce that kind of work. Process Lanes established the greatest amount of "learning curve" efficiently by having the same people, at the same work centers, doing the same type of work every day with a constant organized efficient flow of material.

It was obvious, at the onset of the process lanes study, that our physical platform layout would require considerable thought to support the new concept. Area requirements, crane capacities, and material flow would be major considerations. In the selection of the assembly, sub-assembly, and fabrication sites, we also had to consider the volume of work for each category and the method of construction. While we discuss unit categorization in more detail, during the later part of this presentation, we will take a cursory look at the basic types of unit categories to appreciate further discussion of the physical layout (SEE GRAPH PL-04).

<u>CATEGORY NUMBER</u>	<u>DESCRIPTION</u>
1	Flat Panel Units
2	Curved Shell Units
3	Superstructure Units
4	Forepeak and Aft Peak
5	Engine Room Innerbottoms
6	Special Units (Skegs, Rudders, etc.)

It should be noted, at this point, that Category 1 units will comprise approximately 50% of the total hull weight of a typical tanker with an average amount of typical mid-body. Naturally, on vessels with a significant amount of shape, Category 2 units will comprise a much higher percentage of units. For category percentages on a typical Exxon type tanker, see GRAPH PL-05.

II. ASSEMBLY PLATFORM LAYOUTS (PHYSICAL PLATENS)

Based on the preciously mentioned criteria, the assembly platform layouts were selected and laid out. Starting with Assembly Platform No. 20, we will discuss the layout and the unit assembly form associated with it. See GRAPH PL-06 for general yard platen layout.

A) PLATEN NO. 20

Platen No. 20 was selected as the site for the construction of Category 1 units because of the high work volume it can produce, the relationship to the panel line, and the material flow from Platen No. 23 and No. 24. These criteria make Platen No. 20 the most suitable platen for Category 1 units. The production effort on this platen is divided into four specific stages.

1) First Sub-Assembly Stage (See Figure 1)

At this stage, most typically two or three web frames or the floors and girders are fitted and welded to the base panel of the unit which was produced at the panel line. The area has been divided into a gridwork of twelve (12) unit platforms that are 48' x 52'. It is recommended that each grid be clearly distinguished by flat bars colored with paint. They are known by the name S1, S2, S3, etc. Upon completion of the work at the sub-assembly stage, the units are moved to the pro-outfitting stage.

2) Pre-Outfitting Stage (See Figure 2)

Outfitting work is accomplished in this area while the unit is open. It also reduces substantially high position work and, thus, increases efficiency. There is a gridwork of eight (8) platforms, which also should be clearly identified. Upon completion of outfitting, the sub-units are sent to the main assembly stage. The exceptions would be centerline main decks and similar type units which are finished at this stage.

3) Main Assembly Stage (See Figure 2)

Here, sub-units are combined to make cubic units. This is where scaffolding work, as necessary, is accomplished. A total of six (6) platforms have been dedicated for use by this stage. Upon completion, the unit will be sent to the final assembly stage.

4) Final Assembly Stage (See Figure 2)

Most typically, the connection work of outfitting, inspection, and weld completion is accomplished at this stage. Upon completion, the unit is sent to blast and paint.

The above stages establish specific location on the work centers for each stage. The establishment of the four construction stages on Platen No. 20 allows for the same kind of work to be performed every day by the same personnel at a specific location, utilizing the same tools, welding machines, etc. for accomplishing the defined work. The work moves to the personnel in lieu of relocating. This is a fast moving platen area for easily constructed units with short durations. The pre-outfitting work stage provides a work queue storage of on-unit pallets for one (1) week's backlog of work. Outfitting can proceed without disruption from the sub-assembly process which preceded. After main assembly, the unit is turned, as required, to accommodate "final" pre-outfitting welding and inspection. After completion of down hand welding and pre-outfitting, the unit then moves to blast and paint prior to erection.

B) PLATEN NO. 17

Platen No. 17 was selected as the site for Category 2 curved shell units. Category 2 units are all curved side shell units requiring the use of curved side shell jigs, either the fixed or pin type depending on the degree of curvature. These units are, in general, more complex in construction requiring different construction methods and techniques and more elapsed time in assembly position than the Category 1 units. Therefore, since these units require a separate process lane, apart from the faster moving Category 1 units, Platen No. 17 is selected as being the most appropriate apart from Platen No. 20. Its location is convenient to the pre-fabrication shops for economical material flow and convenient to the blast and paint area, upon the completion of units. After units are removed from the jigs, they can proceed to the buffer/pre-outfit area of No. 17 or straight to blast and paint.

C) PLATEN NO. 14

Platen No. 14 was chosen to construct Category 5 units because of the location to the Plate Shop with its panel line and the material flow from Platen No. 16.

The work queue (backlog for the next week's work) is at the upriver end of the platen near the roadway separating Platen No. 13 from No. 17. Miscellaneous material coming from the

pre-fabrication and fabrication stages will be stored here for sub and main assembly. A sub-assembly stage area separates the miscellaneous work queue from the panel line work queue.

There are five (5) areas set aside for main assembly of five (5) engine room double bottom type units simultaneously, if required, along with area set aside at the down river end of the platen as a buffer/or unit outfitting area for two (2) additional units. At the extreme down river end is a work queue/outfitting sub-assembly area.

A three (3) foot high flat platen construction jig for the length of the platen is required to support this construction, As preciously mentioned, Category 5 units are the engine room double bottoms. These units, along with the Category 4 units, will require longer construction time because of the complexity of close fitting tolerance, size, and outfitting work necessitating a separate process lane. This is the equivalent of Lincoln assembly line, We do not want to mix engine room double bottoms with flat panel units or curved side shell units.

D) PLATEN NO. 10

Here on Platen No. 10, the superstructure units (Category 4) and heavy engine flat units are assembled. Fourteen (14) platforms are available for use on Platen No. 10, seven (7) for heavy units and seven (7) for light units. No outfitting will be done in this area. After all the hull work is completed, the units will be moved to the lower yard building ways and the outfitting will be completed at this time, Platen No. 16 will supply the fabricated material.

E) PLATEN NO. 307

Grand assembly and main assembly of Category 4 units are completed in this area. We prepared fifteen (15) platforms for this work area, and they are used for main assembly work only. There is no need for platforms for grand assembly because in most cases we will have to block up units. Platen No. 16 will supply the fabricated material.

F) PLATEN NO. 16

Platen No. 16 will fabricate for Category Types 2, 3, 4, 5 and 6 units. The fabrication will consist of web frames, stringers, built-up members, miscellaneous bulkheads, horizontal girders, floor, girders and docking brackets. At the extreme down river end of the platen is the work queue for incoming material from the pre-fabrication stages for the upcoming week's- schedule of work.

G) PLATENS NO. 23 AND NO. 24

Platens No. 23 and No. 24 will fabricate for Category Type 1 units. Platen No. 23 will fabricate floors, girders, and miscellaneous brackets. Platen No. 24 will fabricate web frames and girders. A portion of these platens is dedicated to turn over for welding, chipping, and grinding. The area between the two platens is the work queue for both platens. Material from the pre-fabricated stages will be stored here for the next week's scheduled work.

H) PRE-FABRICARTION

Pre-fabrication is broken down into three (3) primary categories. They are:

1) Skin Plates

- a) Straight (straight cut)
- b) Curved (irregular cuts)

2) Internal Members (Plates)

- a) Main Plates (N/C cut)
- b) Attached Plates (N/C, servo, shear, or manual cut)

3) Internal Members (Structural)

- a) "T" Beams
- b) Built-Up Beams
- c) Angles
- d) Flat Bars
- e) Miscellaneous Others

The objective of the pre-fabrication shops is to cut and shape the hull parts to the exact size with the greatest accuracy possible to allow quick assembly and construction through the assigned work centers.

The objective in pre-fabrication also is to minimize handling and movement of material and to work the same things in the same place which will create greater efficiency and reduce cost. The work methods of the various pre-fabrication operations need not be modified from existing methods.

The Plate Shop will receive 700 tons of raw steel plate per week to feed N/C, exacto and servo burning. This process cuts floor, girders and miscellaneous brackets, longitudinal bulkheads, transverse bulkheads, side shell plates, and flats.

Some of these plates move to another area in the shop for rolling, bending, or cutting of tabs, while others go to the panel line for fabrication. All material (except panel line material) is separated and palletized in the shop and sent to the appropriate fabrication work queue.

Platen No. 18 is designated as the structural steel pre-fabrication process lane. With this relocation of the punch press, frame and angle benders from the Plate Shop, the platen will process approximately 300 tons of structural steel per week.

Structural move from the down river end of the platen toward the upriver end and, on completion of all cutting, punching and forming, will be palletized and sent to the appropriate fabrication stage work queues.

Obviously, we have other platens which can be utilized for specific needs; however, we have devoted discussion here to those key platens dedicated to the process lanes flow.

III. UNIT CATEGORIZATION

Unit categorization of the ship's hull components is one of the most important processes of the process lanes system. It is a must for the planning and scheduling evolutions that the Planning Department will undertake.

Categorization is essential to determining where partial sub-units and sub-units will be fabricated and what duration of time will be required.

Categorization is the process of dividing the ship units into categories based on their size, shape, weight and method of construction. Each category requires different assembly jigs and specialized equipment or tools. At this time, it is pertinent to note that workers who are familiar with the methods of building a flat panel unit would be less efficient working a curved unit. When the material flow problems are added, it helps to comprehend the need for categorization and establishment of process lanes for each category of hull units.

The categorization process is required by the detail planning and scheduling process and establishes an orderly flow of material. It allows the determination to be made of where the various components of a unit will be constructed, in addition to the duration through process lanes. To accomplish categorization the hull units are divided into six (6) basic types, as preciously noted. (SEE GRAPH PL-04)

We will spend the next few minutes reviewing the category types in more detail as follows.

A) CATEGORY TYPE I - FLAT PANEL UNIT (GRAPH PL-07)

These units are comprised of panel line components and assembled on a flat surface as the base of the unit; however, it is not limited to strictly panel line components. This flat surface can be a deck, innerbottom, bulkhead, and sometimes a flat shell plate. This category is comprised of relatively simple units with short construction time required. The maximum weight would be approximately 140 tons. Category 1 units, on a typical tanker with an average amount of typical mid-body, would comprise approximately 50% of the total hull weight.

Platen No. 20 is the most appropriate site for the sub-assembly, pre-outfitting, and main assembly for these units, due to the direct connection with the panel line. Fabrication for Category 1 units will be accomplished at Platens No. 23 and No. 24. Platen No. 20 is sub-divided into four (4) stage areas - sub-assembly, pre-outfitting, main assembly, and final assembly.

B) CATEGORY TYPE II - CURVED SHELL UNITS (GRAPH PL-08)

These units are assembled on curved shell, knuckled longitudinal bulkhead, or innerbottom in a fixed jig or a pin jig. Such units would be outboard with tanks or outboard sections of shell plates for engine room flats and forepeaks.

C) CATEGORY TYPE III - SUPERSTRUCTURE TYPE UNITS (GRAPH PL-09)

These units are typically those built on a deck or flat as the base of the unit. Bulkheads, stanchions, and side shells, along with all pre-outfitting, are accomplished. These units remain in main assembly for longer periods of time than Categories 1 or 2 units. Examples would be superstructure decks, hull decks or flats - with bulkheads, stanchions, side shells, stacks, pilot house assemblies or, in some cases, vent houses. Category 3 would be constructed at Platens No. 8, No. 9 or No. 11 because of their relationship to the hull erection site (upriver or down river).

D) CATEGORY TYPE IV - LARGE AND HEAVY MODULAR UNITS (GRAPH PL-10)

These units are large and very heavy with a long assembly and outfitting period. They require much piecemeal and close tolerance fitting, such as forepeak with bow thruster and bulb, aft peak with rudder post and stern frame

castings, and engine room double bottom with main engine foundation. The assembly location would be Platen No. 10, No. 13 or Area No. 307 being close to the erection site. Fabrication is supplied from Platen No. 16.

E) CATEGORY TYPE V – MACHINERY SPACE DOUBLE BOTTOMS (GRAPH PL-11)

These units are usually built with tank tops as the base of the unit, and they require a long period of time in main assembly. Pre-outfitting requires more time in this area of the ship (due to enormous amounts of pipe). Shell plating is usually piecemealed, requiring more time for fitting and welding.

F) CATEGORY TYPE VI – SPECIAL WELDMENTS (GRAPH PL-12)

These are specialty units, such as rudders, skegs, anchor pockets, bilge keels, coamings, box girders, and bulwarks.

In the next section, we will take a closer look at the detail unit breakdown process, platen capacity loading, and the development of the Long Term Process Lanes Schedules.

QUESTIONS/ANSWERS

FINAL ASSY. & OUTFIT AREA

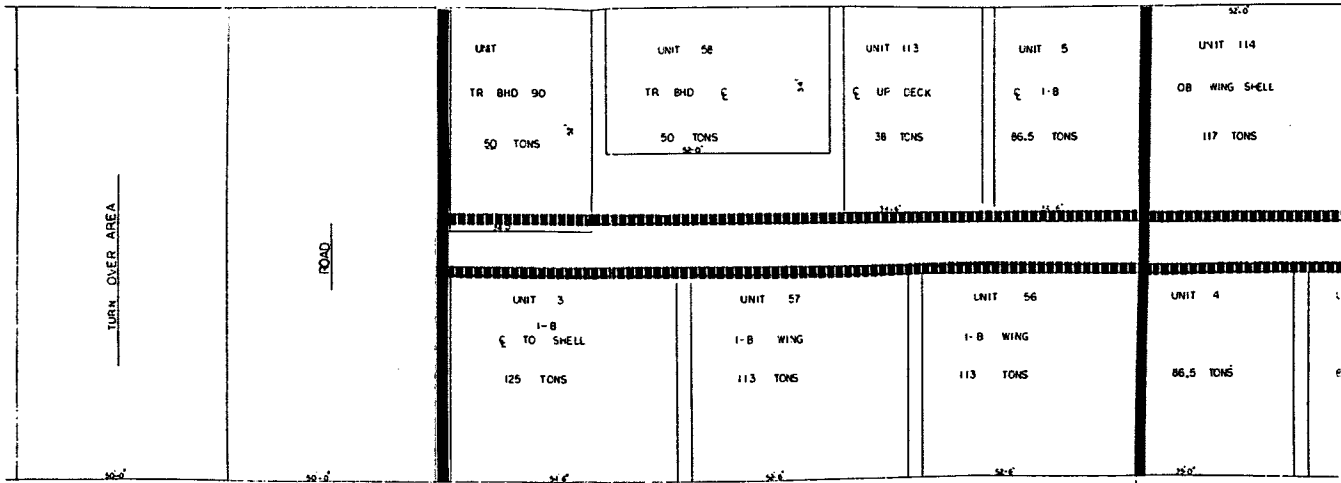

←----- FINL ASSY & OUTFIT AREA ----->

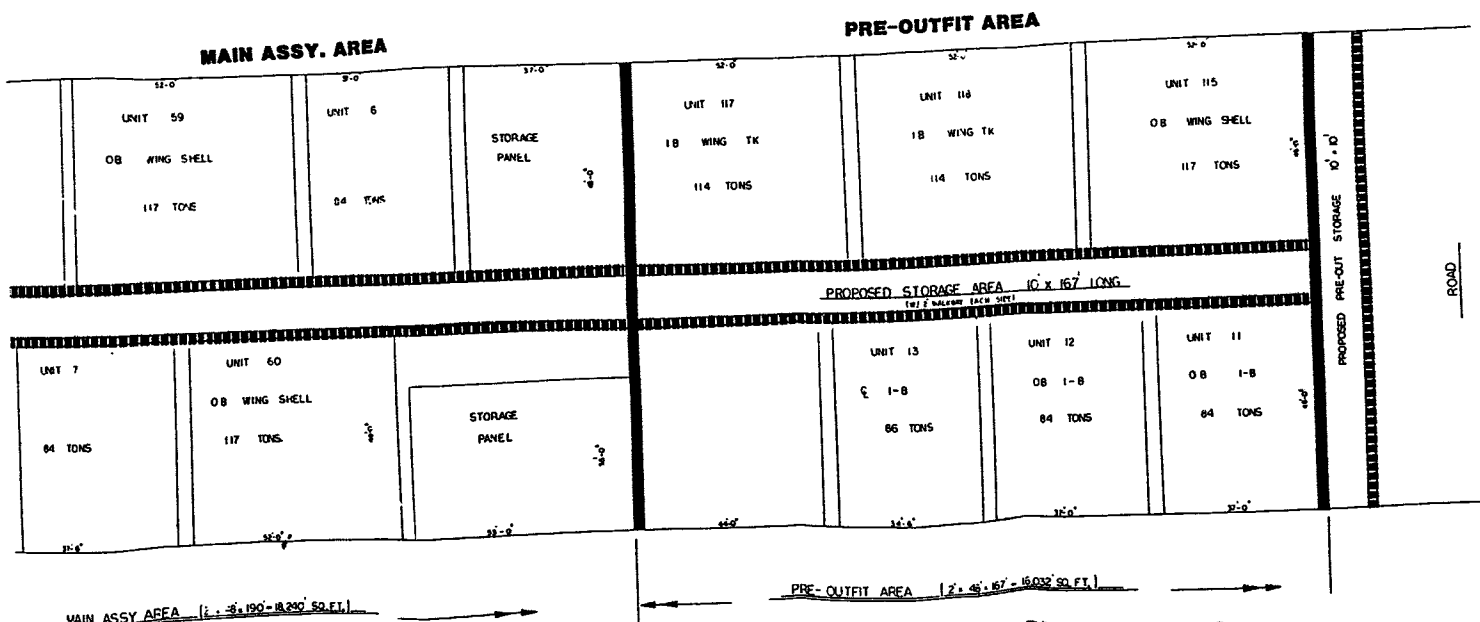

SUB-ASSY. AREA

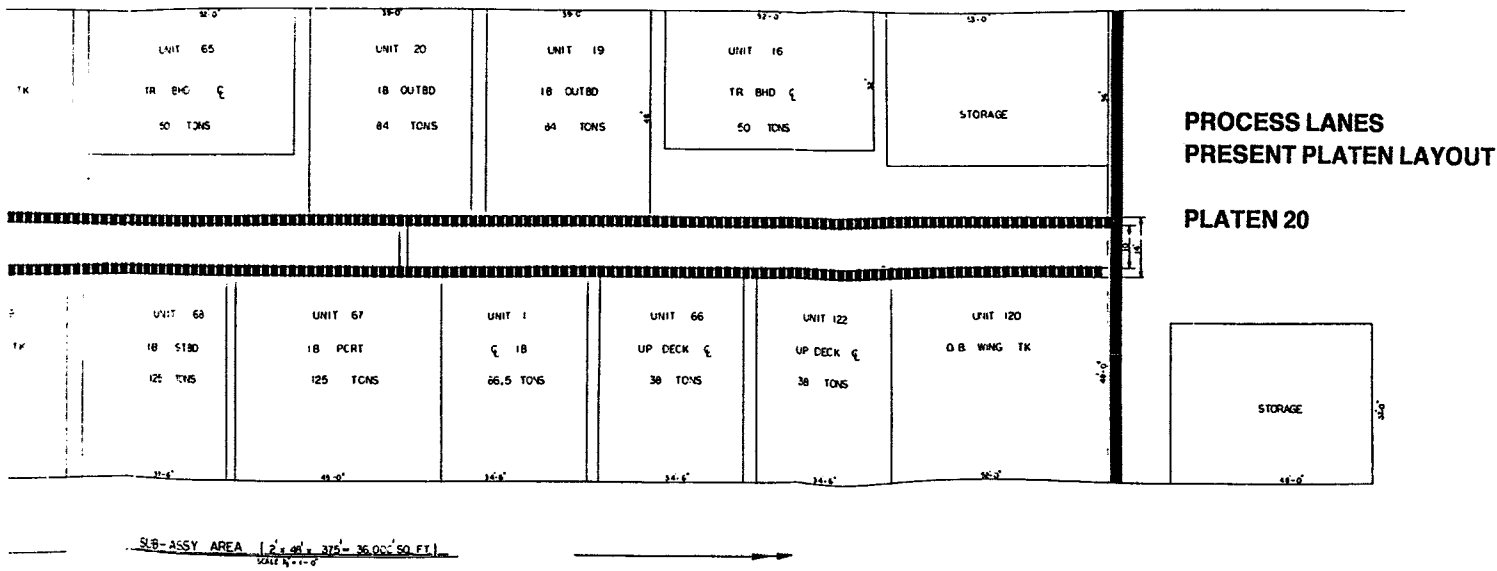
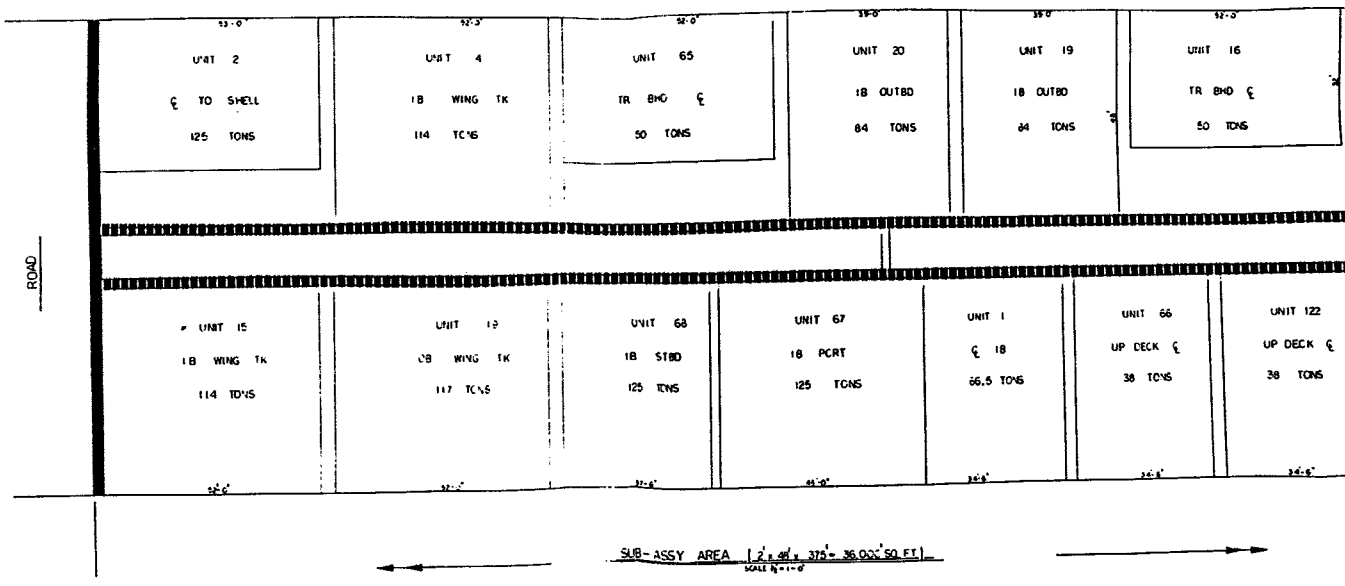

FIGURE 2

SUB-ASSY. AREA



UNIT CATEGORY PERCENTAGES ON A
TYPICAL TANKER

<u>CATEGORY NO.</u>	<u>DESCRIPTION</u>	<u>PERCENTAGE</u>
1	FLAT PANEL UNITS	48 %
2	CURVED SHELL UNITS	5 %
3	SUPERSTRUCTURE UNITS	29 %
4	FOREPEAK AND AFT PEAK	10 %
5	ENGINE ROOM INNERBOTTOMS	5 %
6	SPECIAL UNITS - SKEGS, RUDDERS, ETC.	5 %

GRAPH NO. PL-05

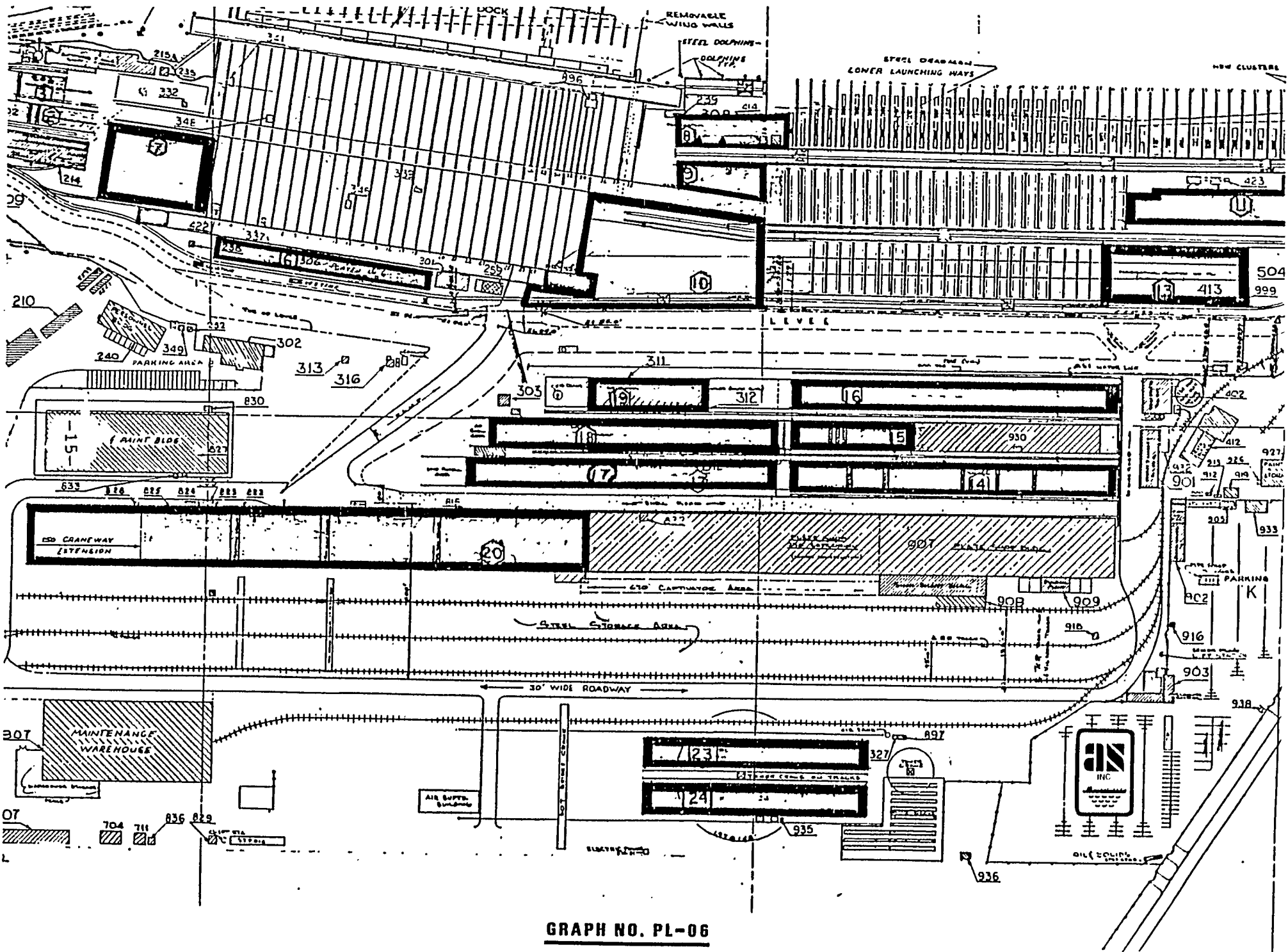

GRAPH NO. PL-06

CATEGORY NO.1 UNIT
TYP INBD LONG'L BHD WING TANK
TRANSPORT POSITION

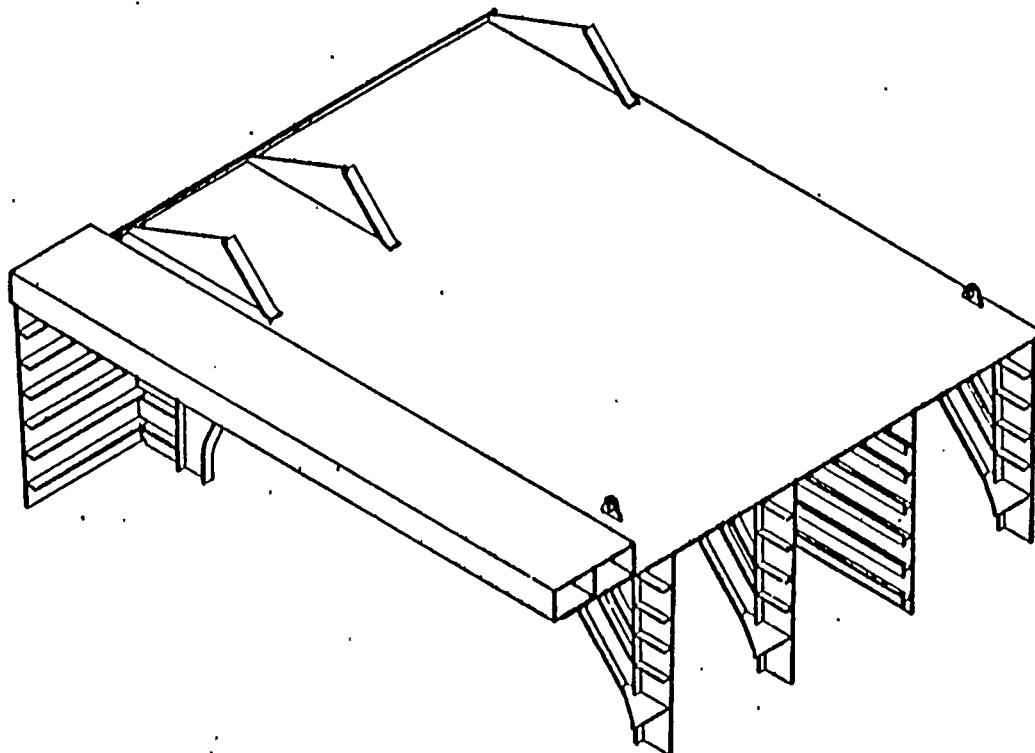

OPERATION SERVICES

GRAPH NO. PL-07

TYP CURVED SIDE SHELL
WING TANK UNIT IN JIG
CATEGORY NO. 2 UNIT

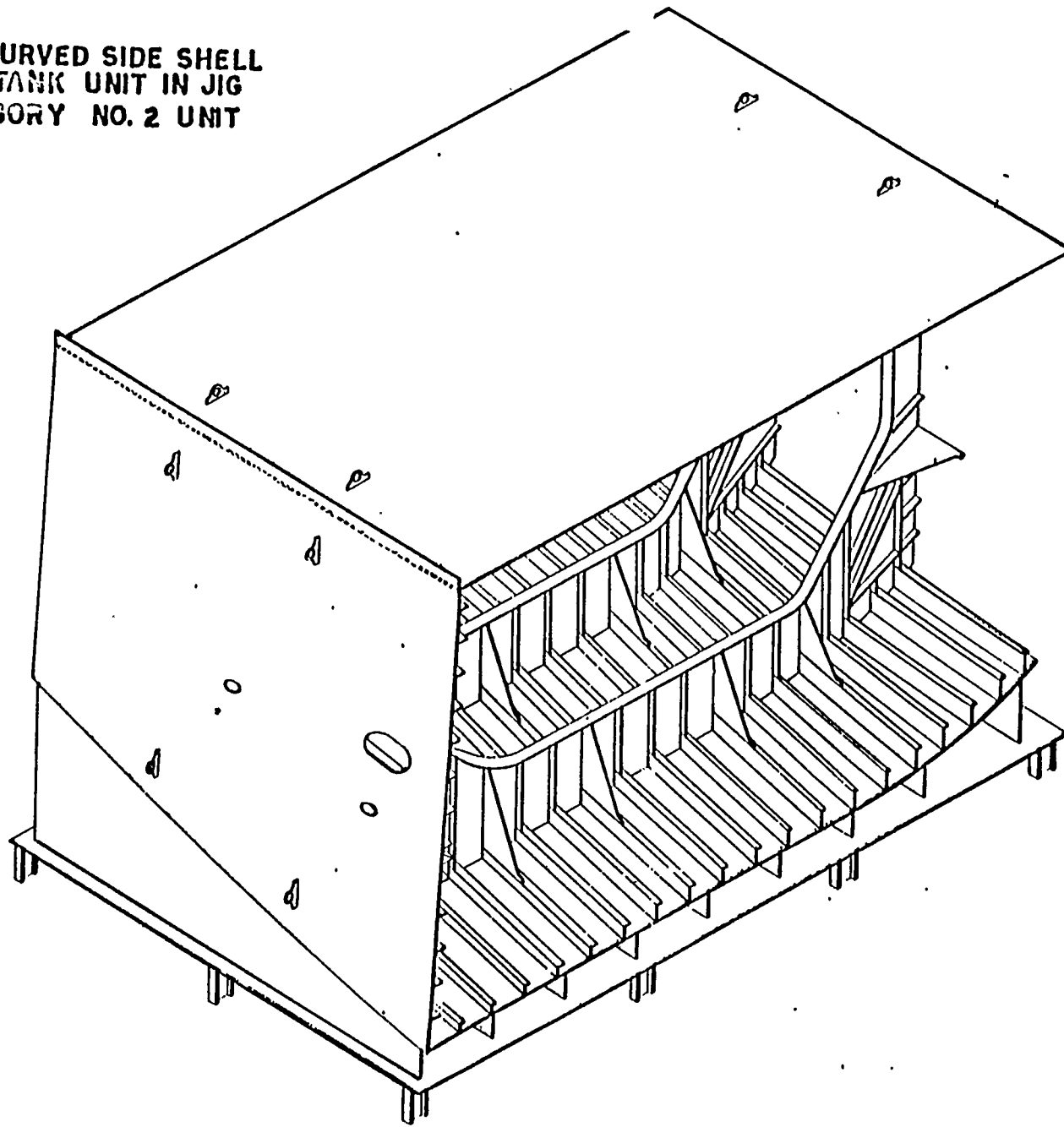

OPERATION SERVICE

GRAPH NO. PL-08

**CATEGORY NO. 3 UNIT
COMPLETED SUPERSTRUCTURE**

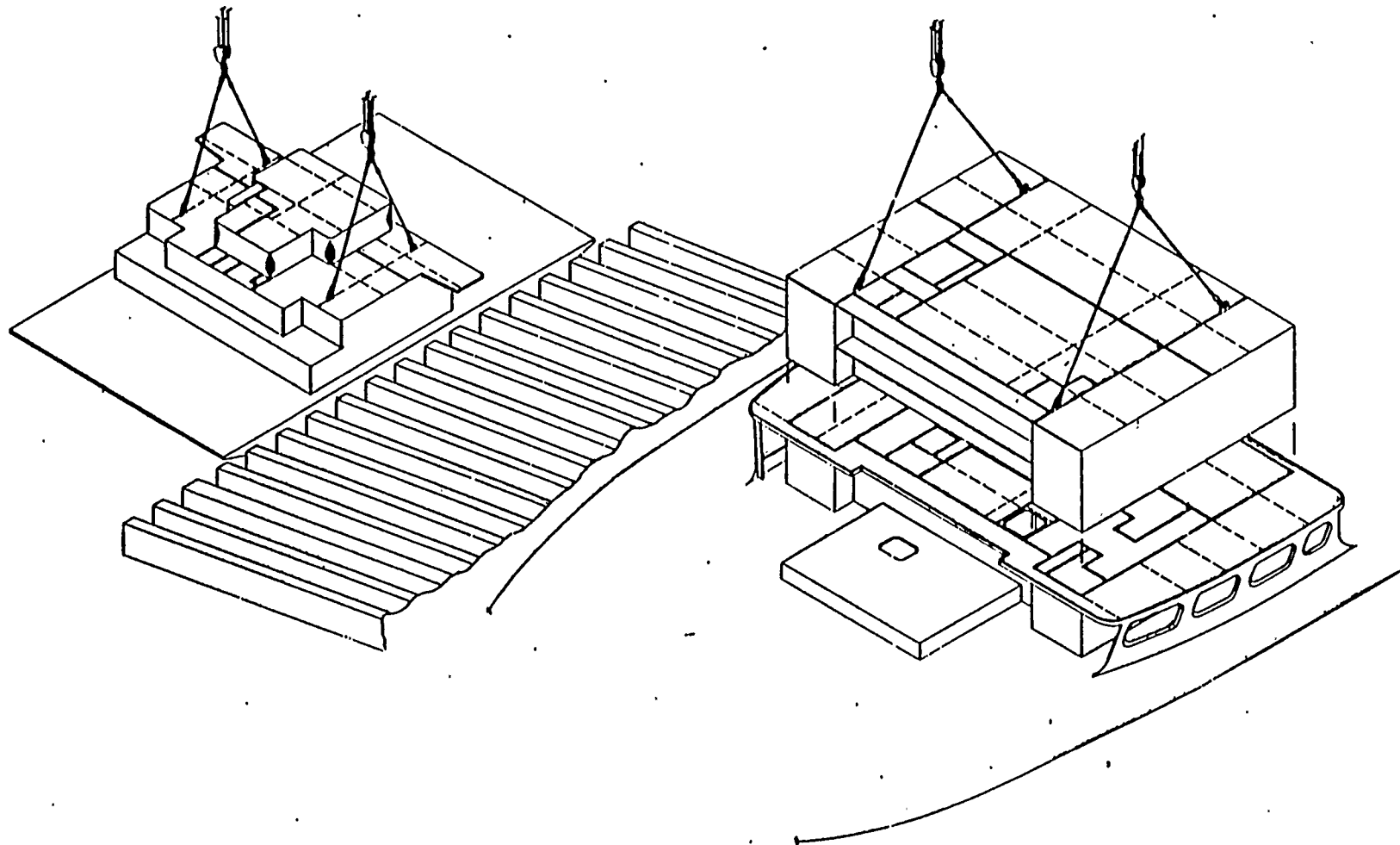

OPERATION SERVICES

CATEGORY NO. 4 UNIT
TYP FORE PEAK

UPPER DECK

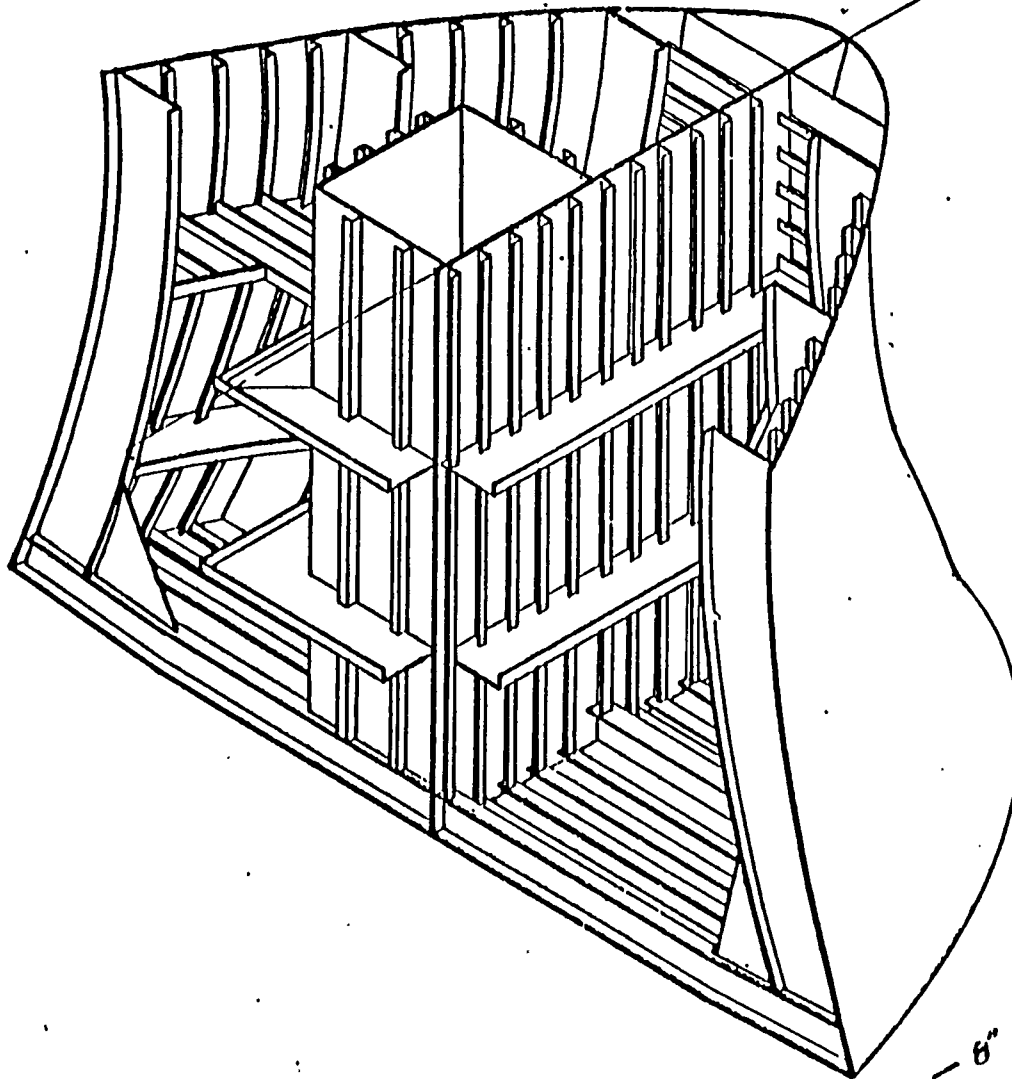

SHIP

6"
FR 105

OPERATION SERVICE

GRAPH NO. PL-10

CATEGORY NO. 5 UNIT
TYP ENG RM DBL BOTTOM

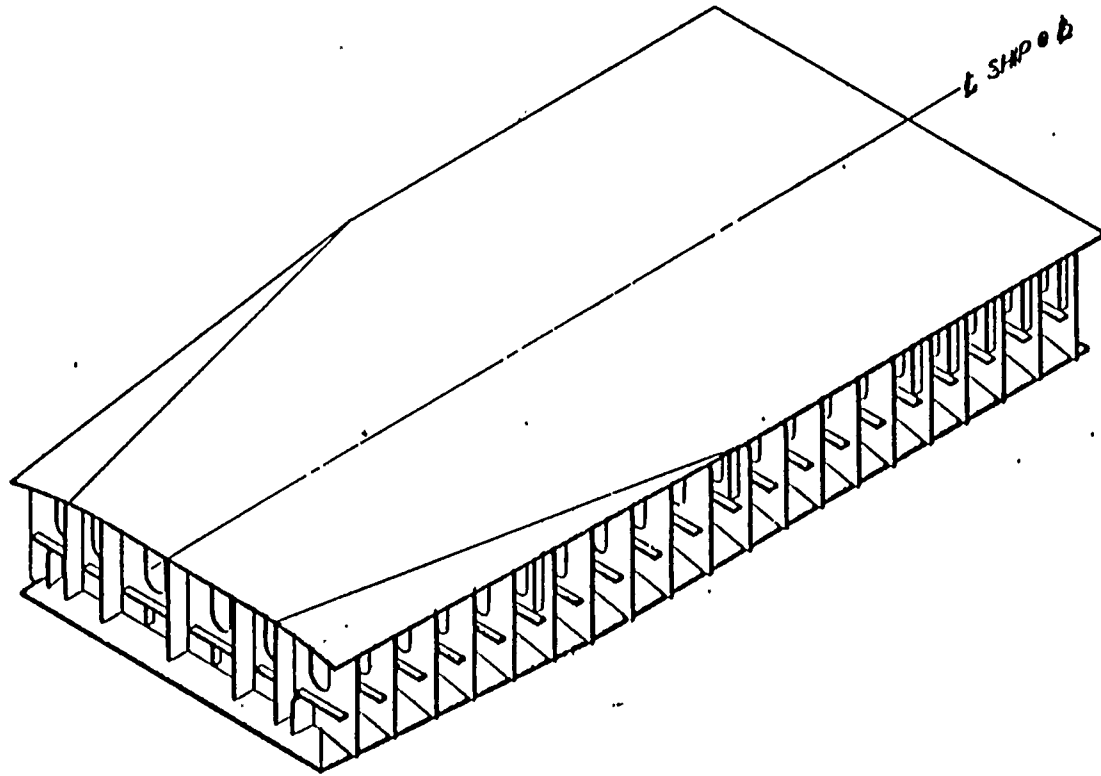

OPERATION SERVICE

GRAPH NO. PL-11

CATEGORY NO. 6

RUDDER AND BULBOUS BOW

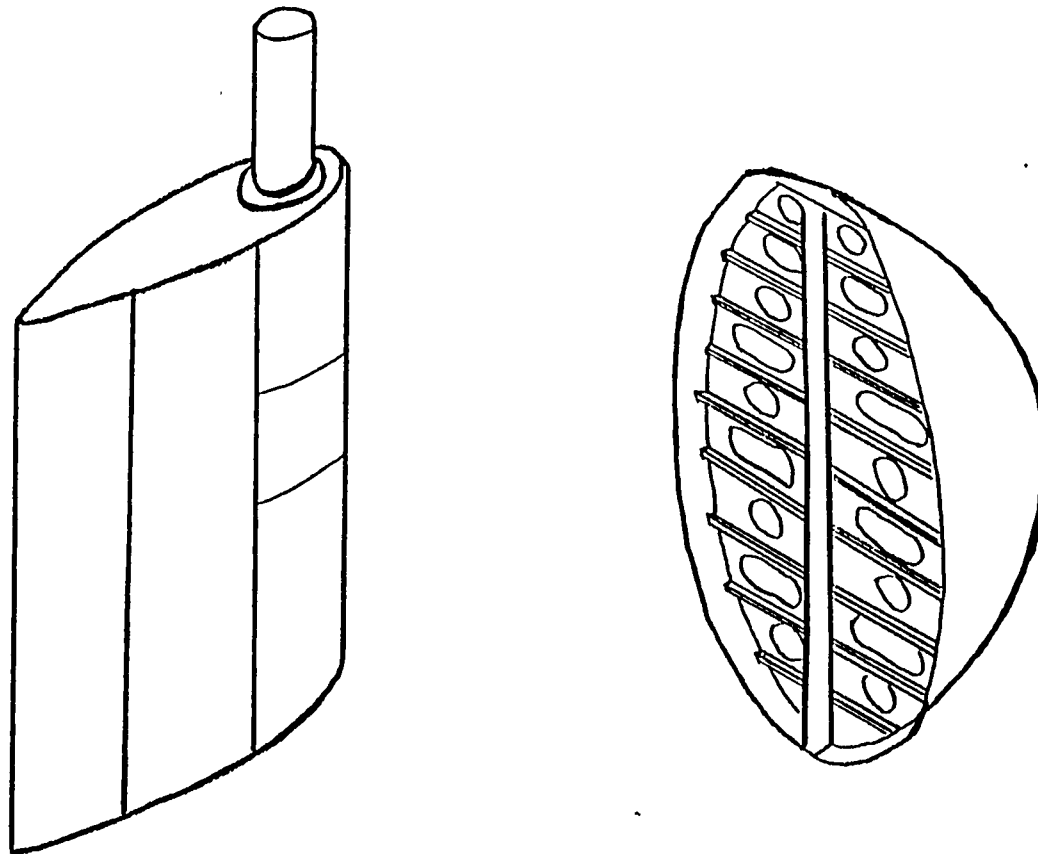

GRAPH NO. PL-12

PROCESS LANES AND DESIGN ENGINEERING
FOR ZONE OUTFITTING
AVONDRLE SHIPYARDS, INC.

UNIT BREAKDOWN

Prepared by: D. SMITH

PROCESS LANES AND DESIGN ENGINEERING
FOR ZONE OUTFITTING
UNIT BREAKDOWN

I. DETAIL UNIT BREAKDOWN

After all units have been placed in the final category list and building locations have been determined, the detail breakdown of a unit can proceed. Each unit is further divided into the following categories: (SEE GRAPH PL-13-1, 13-2 and 13-3).

- Main Assembly

- Sub Assembly

- Partial Sub Assembly

- Panel Line

- Items that are piecemeal, such as shell plate and structural members

- Final erection items, such as trunks, brackets, and web frame stubs

- The category of unit determines the building location of components, and schedules for each work center determine critical points at each assembly area

A) RECAP SHEETS (SEE GRAPH PL-14.1 through 14.4)

Using key plans and unit arrangement drawings, we group all like units in the same categories. We then put all like units into stages of construction, such as grand assembly, main assembly, and sub assembly. We then use the key plans to attain welding lengths, fitting lengths, and size of each unit. Once the above steps are taken, you have to look closely at the units and determine how many men you can put on one (1) unit and work efficiently. From the formula we determine the number of assembly days for both welding and fitting. Once the fitting and welding assembly days are known, the outfitting time required at each stage of construction is obtained from the Outfitting Section of Production Planning. Knowing the capacity of our shot house, we also incorporate the number of days necessary for blasting and painting of each unit. The Hull Planning Section furnishes the Scheduling Section with the weight of the units, which is added to the recap sheet. We then total the welding lengths and divide them by the total manhours to

come up with the efficiency of manhours per foot. With the completion of the category recap sheet, we have established the following information:

- The number of units by type per category
- Total weight of units per category
- Average weight of units per category
- Total fitting lengths of units per category
- Average fitting lengths of units per category
- Total welding lengths of units by category
- Average welding lengths of units by category
- Manhour requirements per category

Finalization of the above data on the recap sheets allows the scheduling phase to proceed as described in our next topic of discussion.

II. LONG TERM ASSEMBLY SCHEDULE DEVELOPMENT

Next we will discuss the development method of long term assembly schedules, whereby the following documents are a pre-requisite:

- Master Yard Schedule
 - Erection Schedule
 - Key Plans
 - Unit Recap Sheets
 - Unit Arrangement
 - Platform Arrangements

First of all, the date that each unit is in its last day of the process lanes flow is determined by the Erection Schedule with consideration for outfitting and blast and paint time. The date for each unit is then transferred to the appropriate assembly stage chart. Using Category 1 as an example, the Grand Assembly Schedule, which is the last assembly stage for Category 1, is the first schedule for which these critical dates are determined. When all the dates for each unit that goes to Grand Assembly are transferred to that chart the first

schedule can be prepared.. The units are then level loaded considering the information in the unit recap sheets and the platform arrangement appropriate to the grand assembly stage.

After the Grand Assembly Schedule is complete, ensuing schedules, final assembly, pre-outfitting, sub-assembly and panel line are developed, each one depending upon the critical dates established by the previous construction stage schedule. (SEE GRAPHS PL 15.1 THROUGH 15.4 FOR PROCESS LANES FLOW)

Then from the panel line schedule forward in time, we refine the loading and schedule dates to insure critical dates are not in conflict and that work areas are not overloaded, adjusting the panel line schedule to accommodate the refinement of the various other schedules.

An important point in accomplishing level loading is keeping in mind the capacities of work areas at each stage and backing off in time where necessary to meet critical dates without overloading those work capacities. Also important to level loading is the grouping and loading of similar work groups together. When the work is arranged in this manner, because the work groups are similar, the construction time periods are similar, These two points, capacities and similar constructions periods, permit the smooth flow of material and the improvement in construction efficiencies. This is the principle of not mixing Chevetttes and Monte Carlos on the same conveyor line or process line,

As these same scheduling principles are applied to each individual category, the resulting sum is a level loaded construction schedule for the duration of the contract.

When you go over these schedules in greater detail to study and become more acquainted with them, please keep in mind that these schedules are not meant to be an absolute final product. They are long term assembly schedules and will be continually updated and refined as efficiencies change and as new contracts are taken into account. They are perfectly adequate at this stage for preparation of unit control manualps, templates, and for the scheduling of purchasing materials.

Planning for a Process Lanes System should provide realistic schedules at each stage of construction, resulting in a smooth and even flow of materials required for each subsequent stage of construction, against which can be measured the efficiency of that particular stage. Without a good level loading and realistic schedule, efficiency or cost is extremely difficult to accurately predict or controk1. Level loading is achieved by maintaining an acceptable balance between time (duration) and storage.

It is obvious by the category descriptions that the percentage of each category will fluctuate considerably over a variety of contracts. More specifically, a standard tanker with considerable typical mid-body would have a higher percentage of Category 1 units, while a vessel with more curved shape would have a higher percentage of Category 2 units.

III. FACILITY CAPACITY LOADING

Based on the main yard assembly capacity of 4,200 short tons per month, Avondale plans its current and prospective work load in a manner which insures full capacity utilization without creating overloaded facilities. This concept is of primary importance when the work currently in progress and known future work is plotted according to key events of those contracts, using the erection tonnage as a base line. It is important to note that when scheduling multiple contracts or multi-hull contracts, consideration must be given to the projected erection sequence and category of units to be erected on the hulls concerned. This will be further discussed in the topic "Control Systems".

The objective here is to prevent the overloading of assembly work centers which is the ASI control point of hull construction, while remaining as close as possible to the total yard assembly capacity of 4,200 tons. The task of level loading and placing fabricated components/units in storage or work queues is the means to that end. This detailed level of planning is a constantly changing process which creates the flexibility to absorb project plan versus actual variations or the impact of additional work created by new contract signing.

IV. PROPOSED PLATEN LOADING

Proposed platen loading to support the Process Lanes concept will be addressed with this section and will highlight the six (6) categories of construction and the platens most suited by each,

The study revolved around the production effort on Platen No. 20 and Platen No. 17 for the calendar year of 1980 and the following recommendations for Process Lanes platen loading are based partially on that history and partially on what must be produced to maintain the contractual key event dates for the upcoming contracts on hand.

The recommended tonnage for platen loading represents the average weekly erection tonnage (all jobs) for the calendar year 1980, as well as average assembly tonnage per week for each of the two platens.

The platens that will be discussed are:

Platen No. 20, Category 1 units, with Platen No. 23, No. 24 and panel line as supporting fabrication platens.

Platen No. 17, Category 2 units, with Platen No. 16 and panel line as supporting fabrication platens.

Platen No. 14, Category 5 units, with Platen No. 16 and panel line as supporting fabrication platens.

Platen No. 20 is proposed to accommodate the Category 1 units (flat panel units), with the five (5) other categories, coming from other Process Lanes. Category 1 units are most typically comprised of panel line components. Examples would be double bottoms for a major portion of the mid-body, cofferdam bulkheads, those wing tank units built on a flat longitudinal bulkhead, inboard and outboard wing tank section, which would be built on flat longitudinal bulkhead or flat side shell.

The maximum weight would be approximately 140 tons per unit and approximately 48' X 52' in size. These dimensions were taken from the current Exxon contract (C1-15) because this work was the first to flow through Process Lanes. These units comprise approximately 65% of the hull steel weight; Therefore, a fast turnover of these units is required in order to meet key contract dates.

A review of Platen No. 20 loading for the duration of the Exxon contract, based on the established preliminary key dates, indicates that Platen No. 20 should be loaded to capacity when possible, This would be approximately 600 tons per week (all jobs) of Category 1 units, which will approximate six (6) to eight (8) units per week.

QUESTIONS/ANSWERS

CATEGORIES
PROCESS LANES

CATEGORY NO. 1

<u>MAIN ASSEMBLY</u>	<u>SUB ASSEMBLY</u>	<u>PARTIAL SUB ASSEMBLY</u>	<u>PRE-FABRICATION</u>
PLATEN 20	20	23/24	VARIOUS
PLATEN 20	20	PANEL LINE	VARIOUS
PLATEN* 20	17	16	VARIOUS
PLATEN* 20	17	PANEL LINE	VARIOUS

CATEGORY NO. 2

<u>MAIN ASSEMBLY</u>	<u>SUB ASSEMBLY</u>	<u>PARTIAL SUB ASSEMBLY</u>	<u>PRE-FABRICATION</u>
PLATEN* 17	17	16	VARIOUS
PLATEN* 17	17	PANEL LINE	VARIOUS

CATEGORY NO. 3

<u>MAIN ASSEMBLY</u>	<u>SUB ASSEMBLY</u>	<u>PARTIAL SUB ASSEMBLY</u>	<u>PRE-FABRICATION</u>
PLATEN 14	14	16	VARIOUS
PLATEN 14	14		
PLATEN 14	17	16	VARIOUS

CATEGORY NO. 4

<u>MAIN ASSEMBLY</u>	<u>SUB ASSEMBLY</u>	<u>PARTIAL SUB ASSEMBLY</u>	<u>PRE-FABRICATION</u>
PLATEN 10, 13,307	10,13,307	16	VARIOUS
PLATEN* 10, 13,307	17	16	VARIOUS

CATEGORY NO. 5

<u>MAIN ASSEMBLY</u>	<u>SUB ASSEMBLY</u>	<u>PARTIAL SUB ASSEMBLY</u>	<u>PRE-FABRICATION</u>
PLATEN 14	14	16	VARIOUS
PLATEN* 14	17	16	VARIOUS

CATEGORY NO. 6

<u>MAIN ASSEMBLY</u>	<u>SUB ASSEMBLY</u>	<u>PARTIAL SUB ASSEMBLY</u>	<u>PRE-FABRICATION</u>
PLATEN 19	19	16	VARIOUS

* SUB ASSEMBLY ON THIS STAGE MIGHT OCCUR ON RARE OCCASIONS

DEFINITIONS OF CATEGORIZING

MAIN ASSEMBLY:

- CATEGORY NO. 1. FLAT PANEL UNIT
- NO. 2. CURVED SHELL UNIT
- NO. 3. SUPERSTRUCTURE UNIT OR SEMI-FLAT PANEL UNIT
- NO. 4. FORE AND AFT PEAK UNIT
- NO. 5. ENGINE ROOM DOUBLE BOTTOM UNIT
- NO. 6. SPECIAL WELDMENT UNIT

SUB ASSEMBLY:

- CATEGORY A. FLOORS TO GIRDERS ON TANK TOP
- B. WEBS, DECKS, BULKHEADS OR GIRDERS TO PANELS

FABRICATION:

- CATEGORY NO. 1. FLOORS
- NO. 2. GIRDERS
- NO. 3. WEBS (FOR LONGITUDINAL BULKHEAD OR SHELL)
- NO. 4. STRINGER (FOR TRANSVERSE BULKHEADS)
- NO. 5. BUILT UP BEAMS
- NO. 6. "L" TYPE
- NO. 7. WALLS
- NO. 8. CURTAIN OR MARGIN PLATES
- NO. 9. SPECIAL WELDMENT (BILGE KEEL, ETC.)

PRE-FABRICATION

- CATEGORY NO. 1 SKIN PLATE
 - A - STRAIGHT LINE CUT (EXACTO)
 - B - SHAPED IRREGULAR (N/C)
 - 1. ROLL
 - 2. ROLL AND LINE HEAT
 - 3. PRESS
 - 4. ROLL AND BLACKSMITH

DEFINITIONS OF CATEGORIZING

(CONTINUED)

PRE-FABRICATION:

CATEGORY NO. 2 INTERNAL MEMBERS

- A. MAIN PLATE (N/C)
 - 1. ROLL
 - 2. ROLL AND LINE HEAT
 - 3. PRESS
 - 4. ROLL AND BLACKSMITH

CATEGORY NO. 3 STRUCTURAL

- A. PURCHASED "T" BEAM
 - 1. STRAIGHT
 - 2. CURVED
- B. BUILT UP STIFFENER
 - 1. STRAIGHT
 - 2. CURVED
- C. PURCHASED ANGLE
 - 1. STRAIGHT
 - 2. CURVED
- D. FLAT BAR
 - 1. STRAIGHT
 - 2. CURVED
- E. OTHERS
 - 1. STRAIGHT
 - 2. CURVED

PROCESS LANES FOR THE PREFABRICATION STAGE AND WORKING INSTRUCTION PLANS

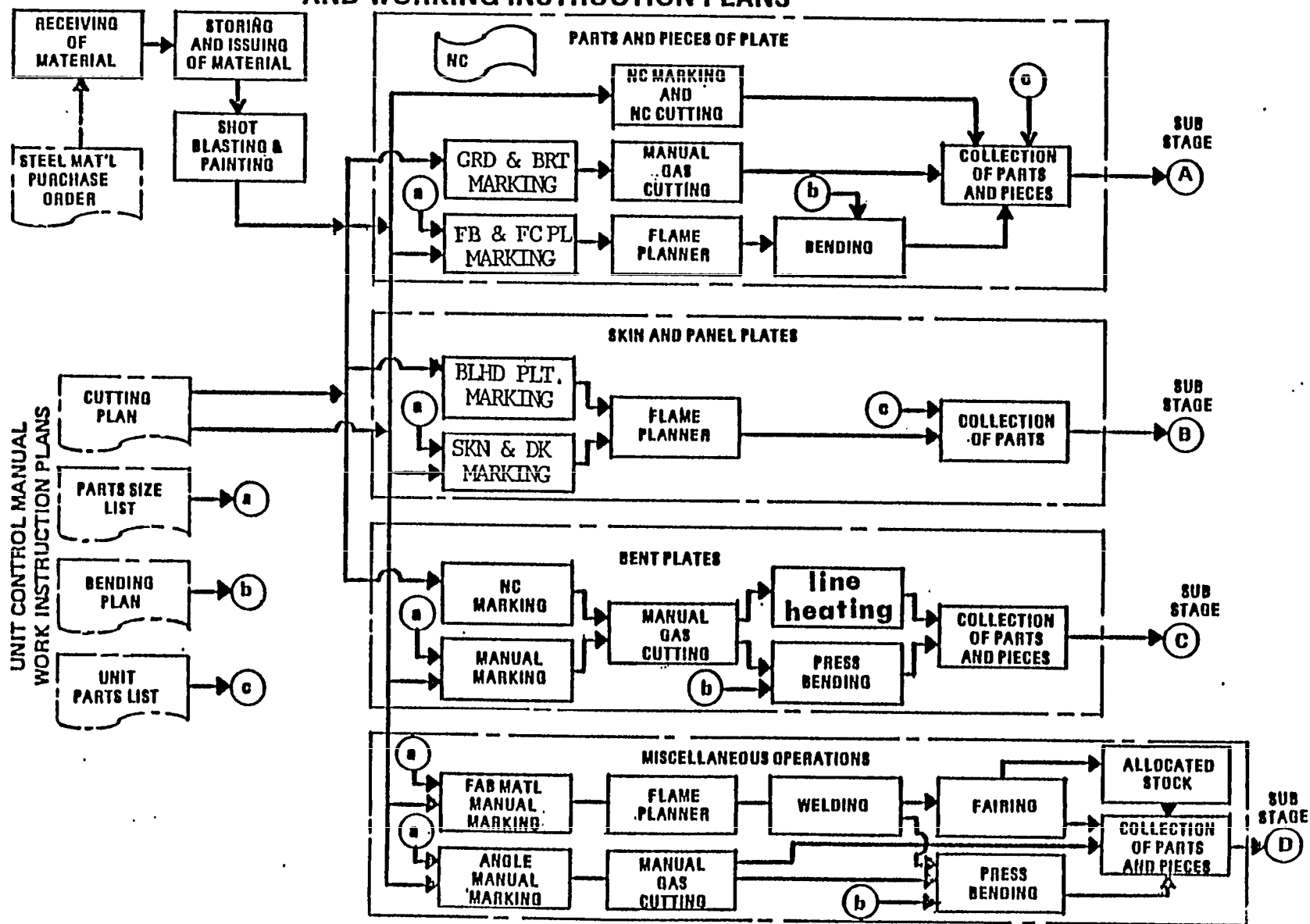

GRAPH NO. PL-15.1

PROCESS LANES FOR THE SUB-ASSEMBLY STAGE AND WORKING INSTRUCTION PLANS

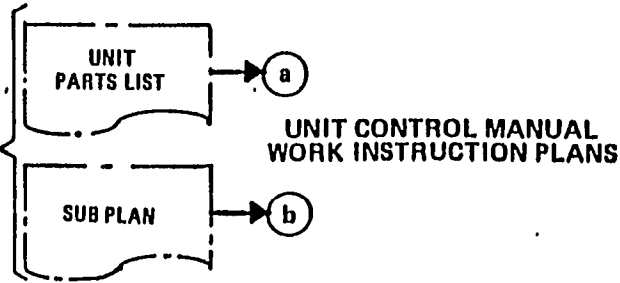
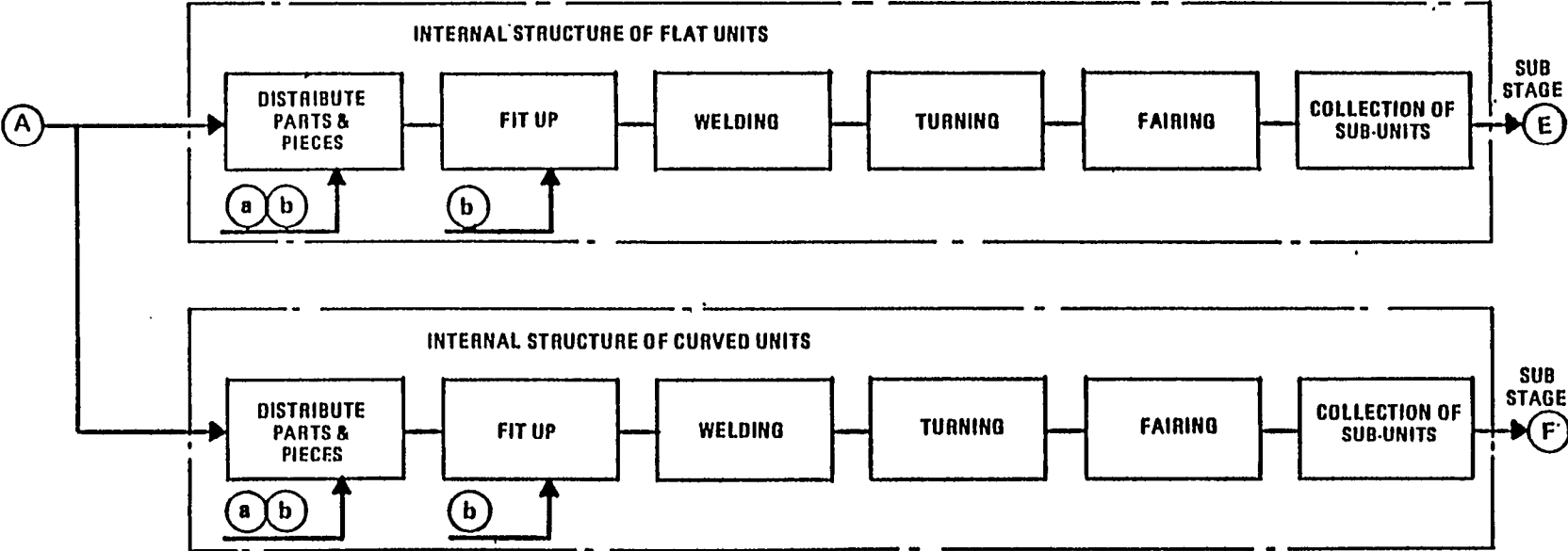

**PROCESS LANES FOR THE ASSEMBLY STAGE
(FLAT UNITS) AND WORKING INSTRUCTION PLANS**

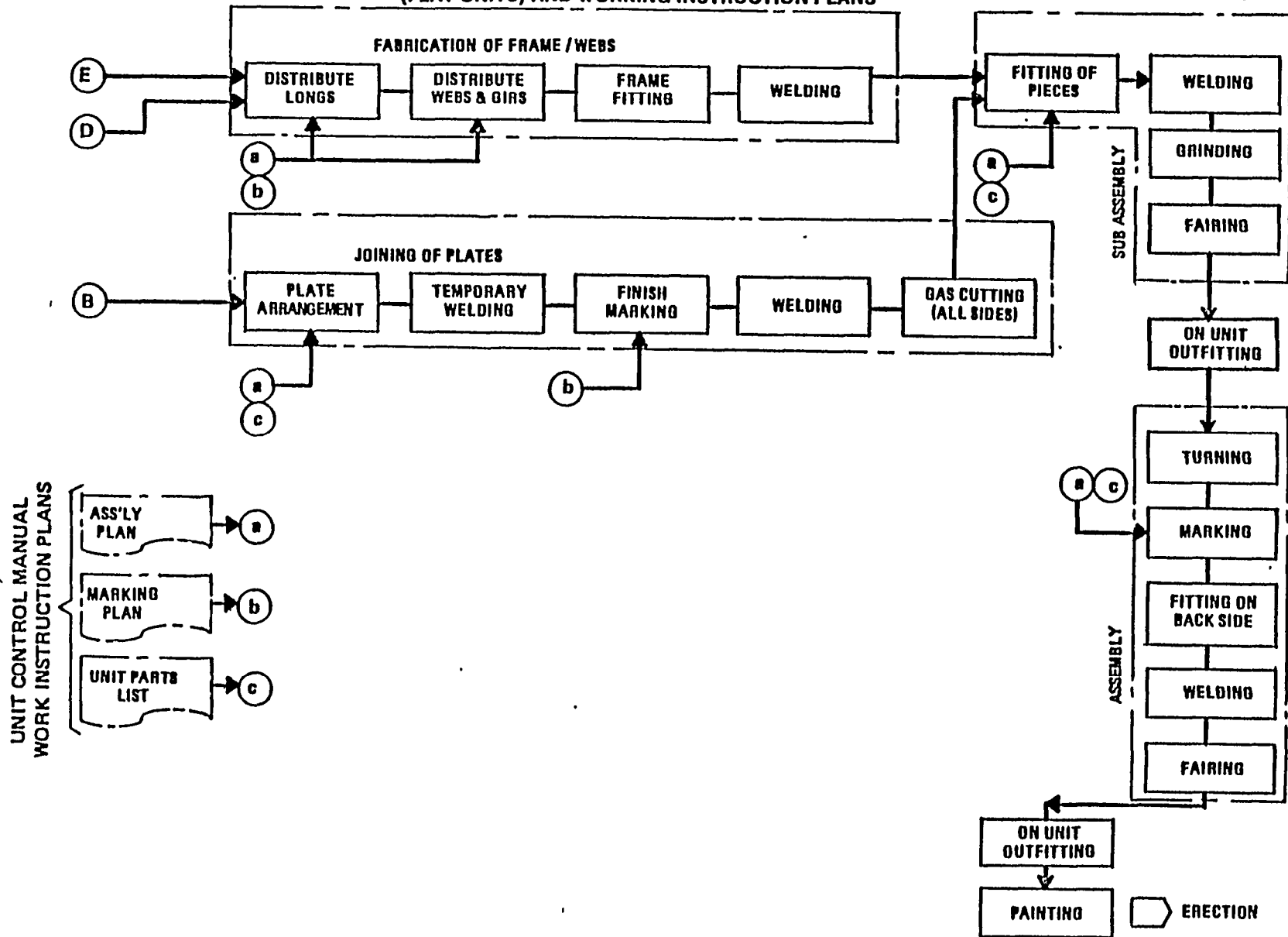

GRAPH NO. PL-15.3

**PROCESS LANES FOR THE ASSEMBLY STAGE (CURVED
UNITS) AND WORKING INSTRUCTION PLANS**

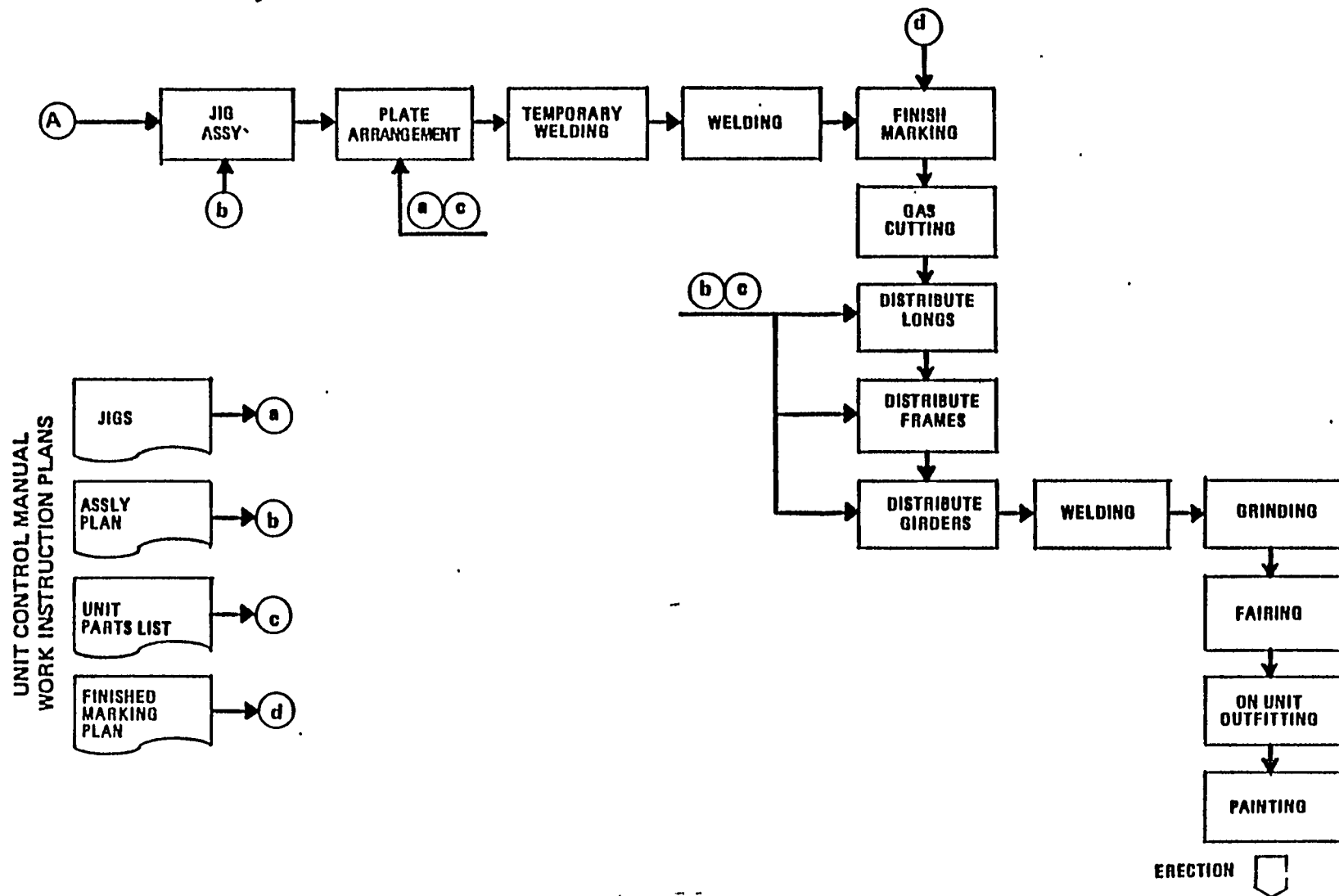

PROCESS LANES AND DESIGN ENGINEERING
FOR ZONE OUTFITTING
AVONDALE SHIPYPRDS, INC.

CODING SYSTEM

Prepared by: A. DUFRENE

PROCESS LANES AND DESIGN ENGINEERING
FOR ZONE OUTFITTING
CODING SYSTEM

I, INTRODUCTION

The coding system is a major tool for controlling the flow of all hull pieces through the process lanes flow. The primary purpose of piece coding is to identify the pieces to be used to fabricate and construct any given portion of the hull. The piece coding system, of course, must provide the relationship of each piece to the total structural hierarchy. The "Product Work Breakdown Structure (PWBS)" provides the necessary guidance to accomplish this objective. Piece coding is a major vehicle to assure that the required steel flows to the specific process lanes work center in an orderly and efficient manner. The stage is set for the piece coding application at the completion of unit breakdown, assignment of the unit numbers and initial categorization of the individual units.

II. CODING SYSTEM

On previous ships at Avondale we used a sequential numbering system. Unit numbers were essentially assigned according to the erection sequence. More often than not, through development, the erection sequence and the unit arrangement would be modified. Naturally, once the erection sequence changed the unit number became simply a vehicle to monitor the unit through the system. The sequential numbering system was utilized on the Exxon contract (SEE GRAPH PL-16).

Through much discussion and development, a decision was made that it would be more advantageous to have some clearly defined intelligence built into the unit numbering system. A final decision was made that the unit numbers would be systematic and depict specific locations on the ship. Thus, it was decisive that the sequential unit numbering system for units would be abandoned on future contracts (after the Exxon) in favor of a block numbering system. The block numbering system was first applied on the TAO-187 contract (SEE GRAPH PL-16).

To establish the unit numbers, the unit arrangement is utilized to separate the ship into systematic and easily distinguishable blocks as identified below:

T-90 BLOCK BREAKDOWN (SEE GRAPH PL-17)

- 100 Block Engine Room
- 200 Block. Aft Cargo Area
- 300 Block. Fwd Cargo area
- 400 Block Superstructure and Mist Deck Houses
- 500 Block Pump Room Area
- 600 Block Aft Peak
- 700 Block Forepeak
- 10 Block, Underwater Hull Fittings (Rudder, Skeg, Bilges, etc.)

Once the blocks are identified, they are further separated into bands (SEE GRAPH PL-18).

The ship bands are now separated into units. Using the numbering system, it is readily recognizable in which area of the ship units are located. This system may differ somewhat from ship to ship, but will generally remain the same. This is a specific aid in categorizing units.

- Units in the (100) Block are most often Category 3 and 5,
- Units in the (200) Block are most often Category 1 and 2.
- Units in the (300) Block are most often Category 1 and 2.
- Units in the (400) Block are most often Category 3.
- Units in the (500) Block are most often Category 1 and 2.
- Units in the (600) Block are most often Category 4.
- Units in the (700) Block are most often Category 4.
- Units in the (10) Block are most often Category 6.

Each unit is further broken down into four (4) categories via the numbering system as follows:

- Main assembly: Assembling Sub Units
- Sub Units: Assembling Partial Sub Units
- Partial Sub Units: Assembling Pieces
- Pre-Fabrication: Cutting Pieces

In order to provide continuity within the total system, the piece code should be compatible with the process lanes work center, predetermined for each category as discussed in the two previous sections. Therefore, the piece code should represent the construction process a particular piece will encounter. Due to different construction methods for units, there will be pieces which do not follow all four of the steps; however, this is easily managed with the triple zero identifier as follows:

	<u>Main Assembly</u>	<u>Sub Rsembly</u>	<u>Partial Sub Unit</u>	<u>Pre-Fabrication</u>
Exxon	000 Unit	000 Unit Unit	000 Partial Sub Unit	000 Piece
TAO	000 Unit	00A Sub Unit	000 Fabrication	000 Piece

The piece number will identify where the work will be performed, compatible with process lanes in each category. Process lanes flow for Category 1 is as follows:

- Main Assembly - Platen No. 20
- Sub Assembly - Platen No. 20
- Partial Sub Assembly - Panel Line and Platens No. 23 & No, 24

Commonly in shipbuilding, we refer to the construction procedure as to what we are doing. By definition, when we combine pieces we have partial sub units, when we combine partial sub units we have sub units, and when we combine sub units we have main assembly. These definitions are not always compatible with process lanes. In process lanes the piece code identifies where the work is to be performed and the location dictates the piece number. In order to keep the piece code compatible with process lanes, we adopted the alpha in the P,S,U. and S,U. as a common denominator. This permits us to perform work on the partial sub unit (P.S.U.) and the sub unit (S.U.) platens which by mere definition would not work.

In studying the outline provided by GRAPH PL-19, which is the present piece coding system on the TAO ship, you will find that as the pieces and parts are gathered the numbers drop off. You will also see the relationship on the numbers steps. 911 pieces in the unit carry the Unit No. 213 (SEE ISOMETRIC GRAPH PL-20). It generally takes several sub units to make up a unit. In Unit No, 213 we have three (3) sub units, No. 213-01, No. 213-02, and No. 213-03. On the left, sub unit No, 213-01, as in all sub units takes a combination" of pre-sub, combined partial sub units and partial sub units,

Naturally, several variations of numbering systems would be appropriate provided that the pieces have the ability to be tracked back through the hierachial structure.

If we would have used the piece coding established on the Exxon for Unit No, 213, it would have been written as shown by GRAPH PL-19a. A review of the Exxon piece coding and the TRO piece coding reflects that all pieces will carry the Unit No. 213 identifier; however, on the Exxon the sub unit numbers are the same; there is no common denominator. On the left, sub unit No, 213-001, the combined partial sub unit number was not carried on the partial sub unit number and there isn't anything to indicte the pre-sub units. The partial sub unit just indicates that the parts fabricate.

QUESTIONS/ANSWERS

BLOCK/UNIT PROFILES

EXXON

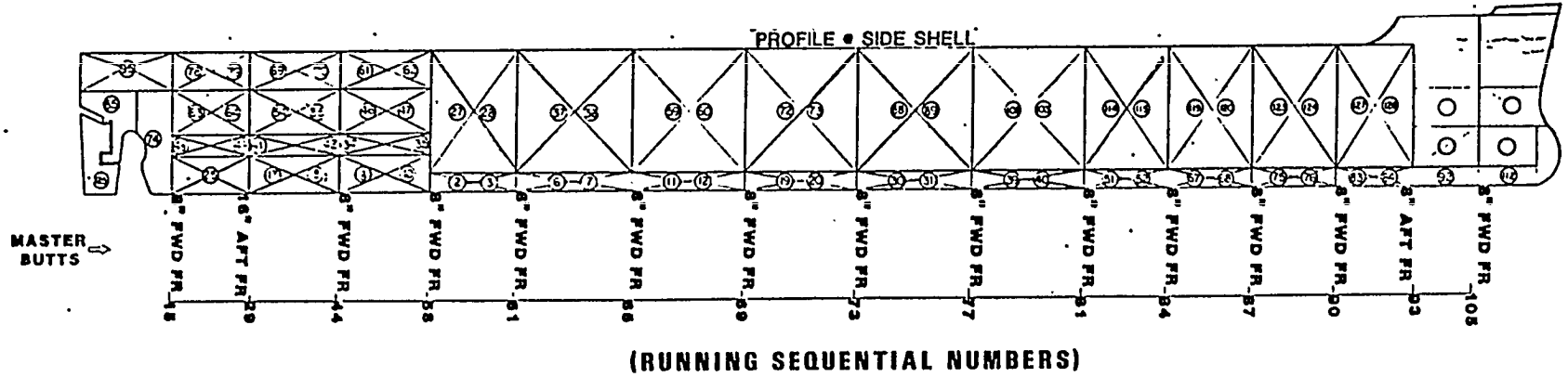

TAO

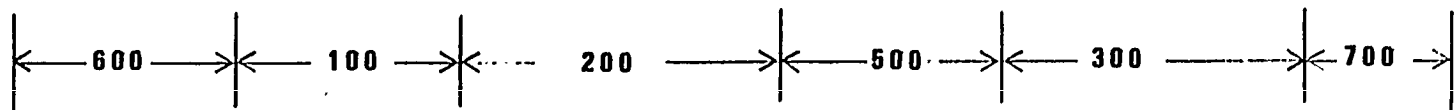
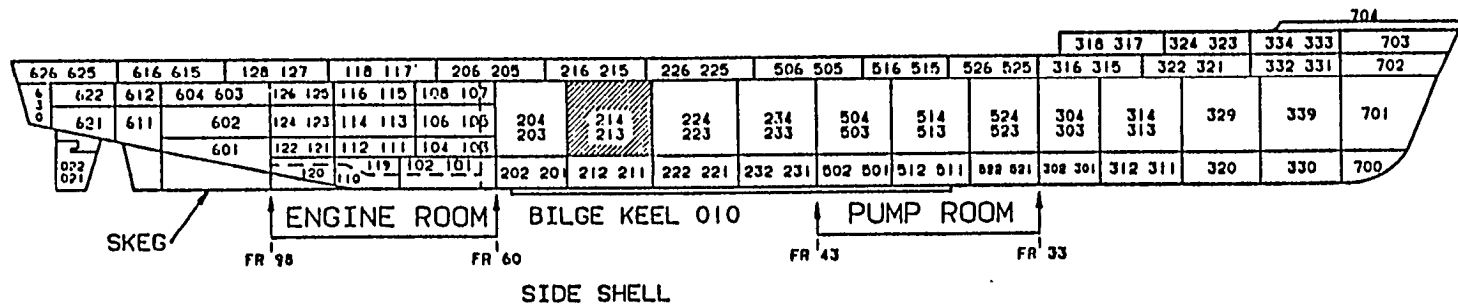

T-AO
BLOCK NUMBERING BREAKDOWN

1. 100 BLOCK, IS THE ENGINE ROOM
2. 200 BLOCK, IS THE AFT CARGO AREA
3. 300 BLOCK, IS THE FWD CARGO AREA
4. 400 BLOCK, IS THE SUPERSTRUCTURE AND MISCELLANEOUS DECK HOUSES
5. 500 BLOCK, IS THE PUMP ROOM AREA
6. 600 BLOCK, IS THE AFT PEAK
7. 700 BLOCK, IS THE FOREPEAK
8. 10 BLOCK, IS THE UNDERWATER HULL FITTINGS - EXAMPLE: RUDDER, SKEG,BILGE,ETC.

ONCE THE BLOCK HAVE BEEN ESTABLISHED THEY ARE SEPARATED INTO BANDS AS SHOWN
BELOW:

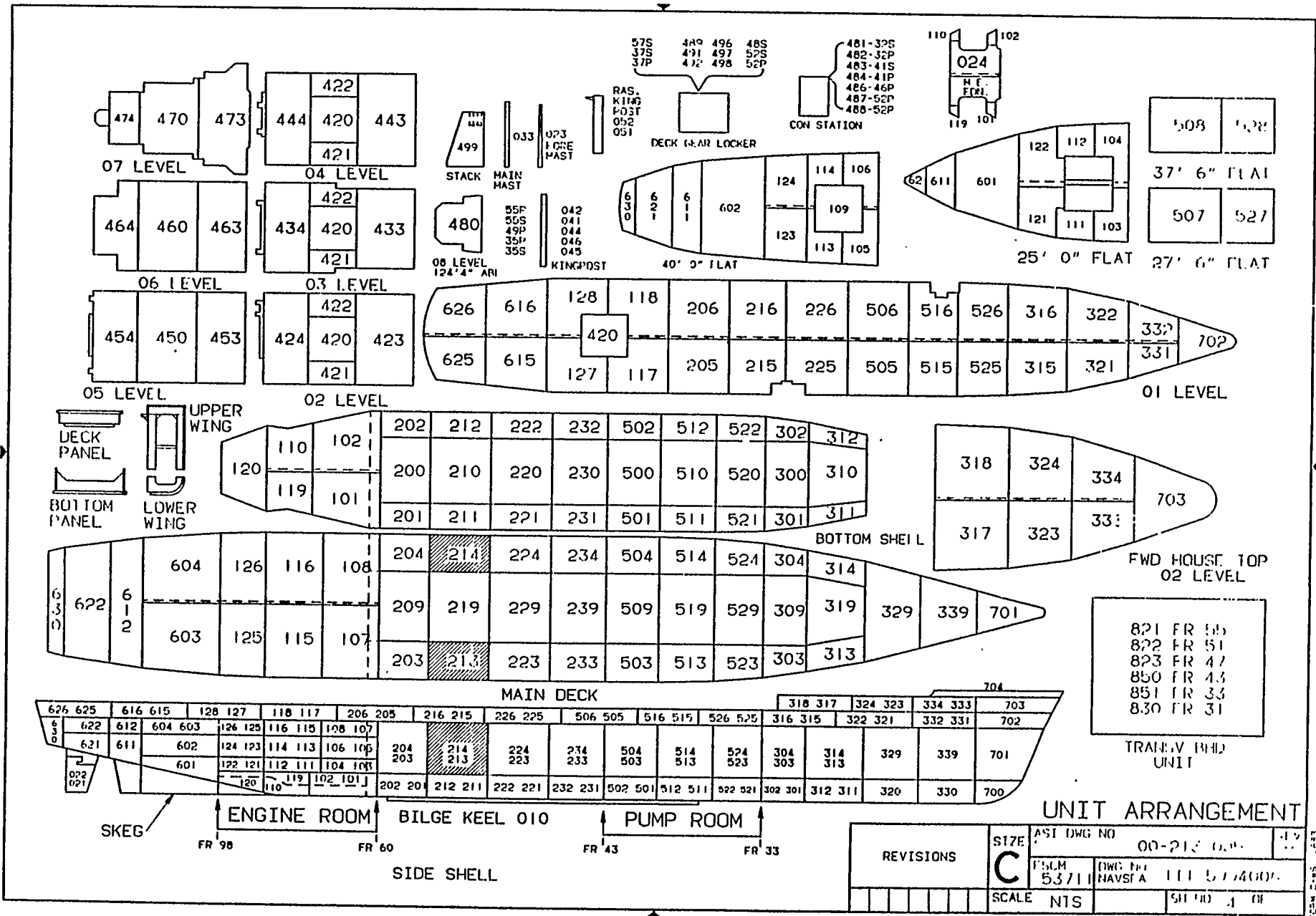

GRAPH NO. PL-18

CATEGORY #1 - TAO

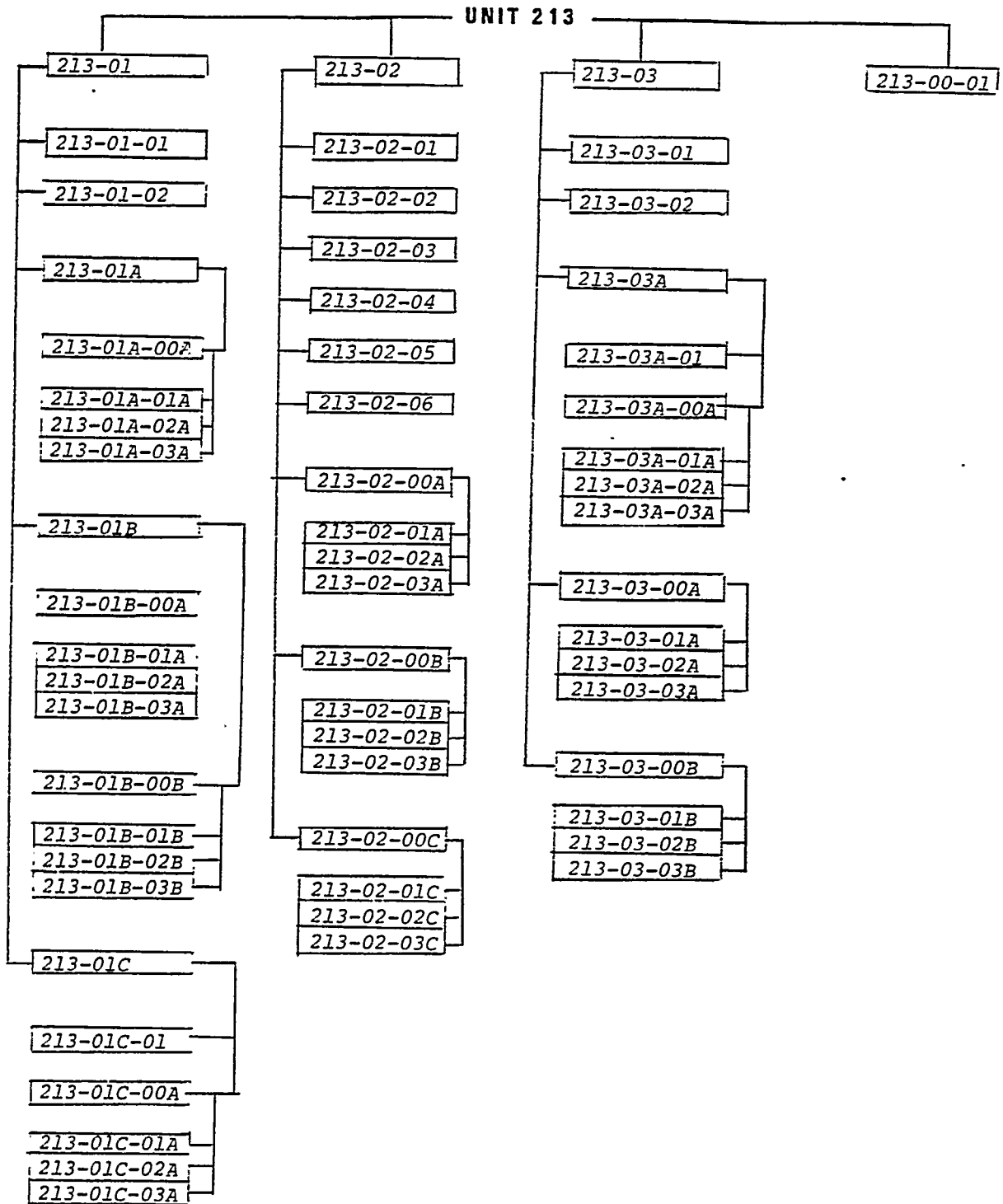

CATEGORY #1 - EXXON

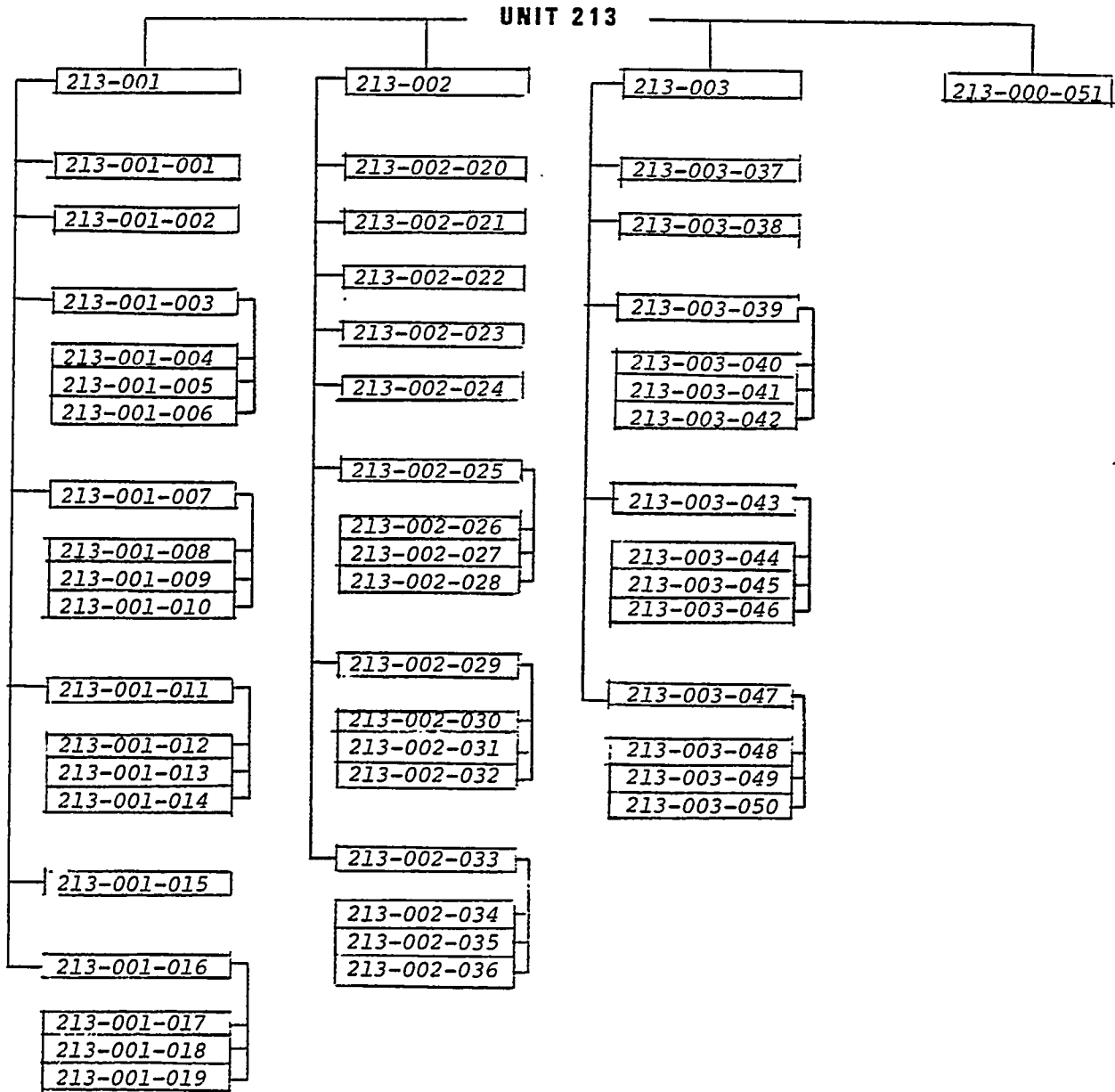

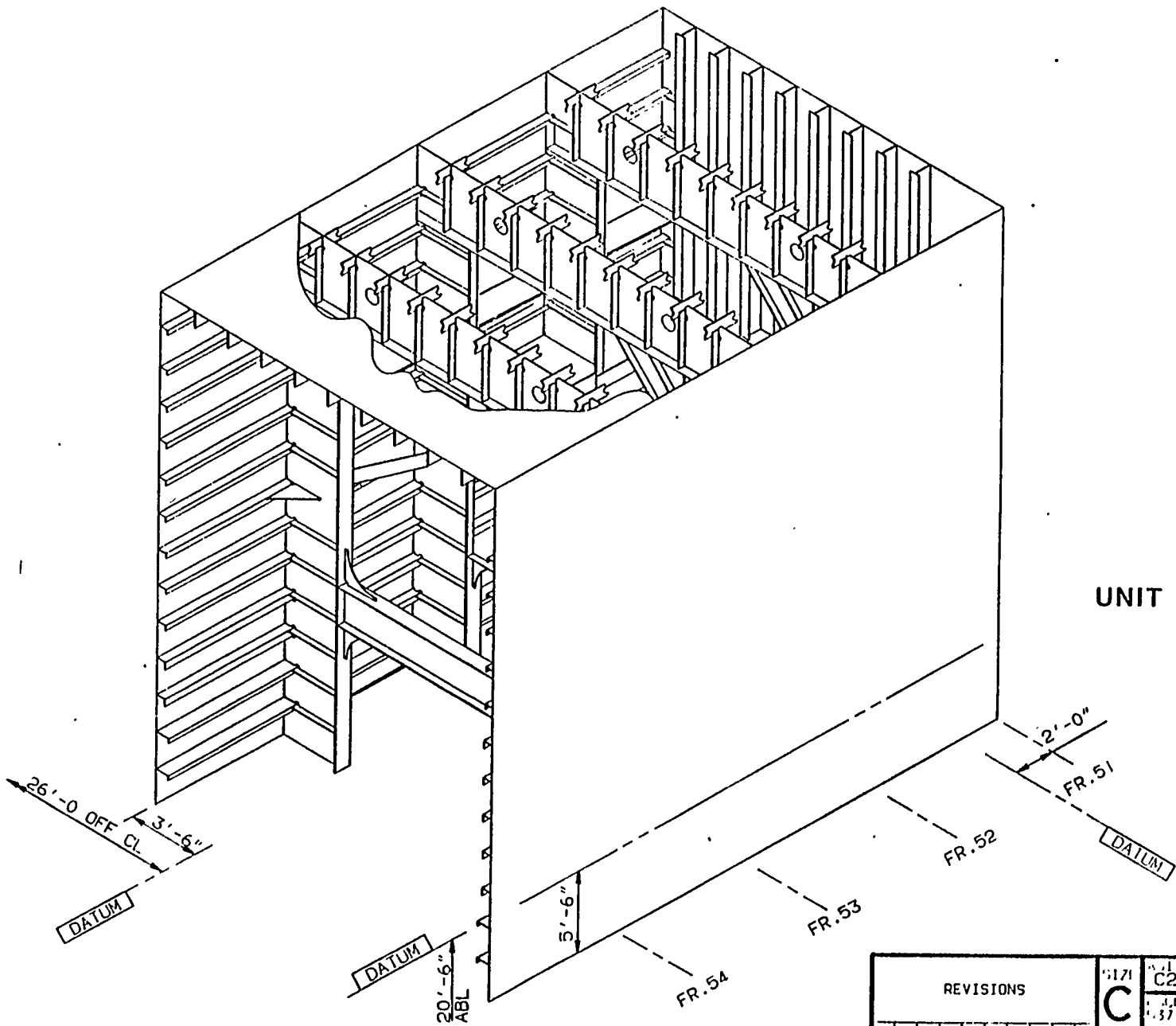

UNIT 213 ISOMETRIC

REVISIONS	SIZE	C2-400	001 213 000
	DATE	11/11/54	11/11/54
	SCALE	NIS	

PROCESS LANES AND DESIGN ENGINEERING
FOR ZONE OUTFITTING
AUONDALE SHIPYARDS, INC.

MATERIAL FLOW

Prepared by: G. GRIMSLEY

PROCESS LANES AND DESIGN ENGINEERING
FOR ZONE OUTFITTING
MATERIAL FLOW

1. MATERIAL FLOW AND FACILITY LAYOUT ANALYSIS

The basic concept of good plant layout is effective material flow. The objective is to minimize the number and length of routes and eliminate any unnecessary movements such as back-hauls, cross-hauls, transfers, etc. Material flow problems can arise because of changes in the design of a process or may develop because of gradual changes over time that finally manifest themselves in terms of bottlenecks in production, crowded conditions, poor housekeeping, failure to meet schedules, and a high ratio of material handling time to production time.

The material flow analysis, which was performed at Avondale, concentrates on some quantitative measures of movement between departments of activities. Since the shipyard layout should be designed to facilitate the flow of the product, we are primarily concerned with the flow of materials. Some of the factors that affect material flow, and which were studied, are:

- external transportation facilities;
- the number of items to be moved;
- the number of units to be produced;
- material storage locations;
- location of manufacturing service areas.

The most popular method of analyzing material flow is to use charts and diagrams. The diagrams (Figures 3, 4, 5, & 6) and the "From - To" chart (SEE GRAPH PL-21) were employed to analyze the material flow of Avondale Shipyards. The flow diagram is an illustration of the actual flow of material and is quite beneficial in evaluating present or proposed facility layouts. From the flow diagram, we can measure material-handling distances.

This discussion will first address the flow diagrams developed from information compiled from our former method of handling the material, then the present diagrams developed from the process lanes studies. Following this, we will compare the number of pieces, trips, and distances involved in the two methods (SEE GRAPHS PL-22 & PL-23).

The development of the charts/diagrams, titled "Past," in this analysis were generated from information collected in a ten week period, in March, April, and May of 1981. The information was extracted from reports created by the Material Control Department and the mobile crane servicing area.

911 material moved from one site to another at Avondale is accompanied by a "Yard Movement Ticket" specifying the origin of the movement, what is being moved, and the destination. So, the reports represented actual material movements within the yard during the period studied. The information was summarized and is presented in the form of flow/from-to diagrams. These diagrams provide information as to the sites that material flowed to and from, and the distances involved. The number of pieces involved, that are discussed further on, were extracted from the "Yard Movement Tickets."

The "Past" diagrams represent two types of material movement:

plate and structural;

fabricated pieces between platens and other areas, such as storage.

NOTE: In the past, much of the steel plate and structural, after they were cut or fabricated, were sent to the steel fabrication storage area. This was the result of multi-hull cutting and fabricating.

The development of the charts/diagrams titled "Present" in the analysis was generated from information developed by the Process Lanes Committee concerning the work locations and material movements required. The process lanes concept eliminates multi-hull cutting and fabrication. It, thereby, eliminates material flow to the fabrication storage area (except Outfitting) and sends it directly to the work site storage queue in which there is one week's backlog of either pre-cut raw material for a fabrication platen or a week's work backlog of fabricated pieces for an assembly platen. This information was incorporated into the present flow charts by mathematically shifting the related material from the fabrication storage area to the work site storage queues.

The end result is a very large reduction of material going to storage (plate and structural) and an appropriate increase in material going to the work sites from the Plate Shop and Platen No. 18, where the structural are cut.

The "Present" diagrams also represent the two types of material movement shown in the earlier part of this discussion: plate and structural, and fabricated pieces between plates.

A comparison of the two methods shows that under the past facility layout and storage method we moved 9,174 pieces of steel material per week, of which 60.7% was moved to or from the fabrication storage area. The process lanes method moves 6,571 pieces per week of which only 8% is involved with the fabrication storage area. The reduction of 2,603 pieces per week is due to the large reduction in double handling that was involved in moving the material to and from the fabrication storage area. A reduction of 28.4% in the number of pieces handled per week is realized by the process lanes concept, with the attendant saving in manhours.

The former method we used had a total steel material movement of 66.6 in-plant miles per week, of which 60% was to and from the fabrication storage area. Under the process lanes method, movement is 43.4 miles per week, of which 13.6% is to and from the fabrication storage area. A reduction of 23.2 miles per week (34.8%) is realized under the process lanes concept,

There were 177 distinct moves from area to area under the former material flow method. Under the process lanes method, there is a reduction of these moves by 58 for a total of 119, resulting in a 32.8% decrease in the number of distinct moves.

In evaluating these four (4) areas, it can be seen that a savings of approximately 30% in the handling of steel is realized as a result of the implementation of the process lanes concept. The appropriate cost savings can be obtained by evaluating the manpower, equipment, and energy reductions which result from a 30% reduction in the handling of steel material. It is evident from the analysis shown here that one of the major reasons for process lanes implementation is the evolution toward an ideal material handling system.

Precisely, we made 170.5 trips per week moving an average of 53.8 pieces per trip, of which 47.8% was moved to or from the fabrication storage area. The process lanes method makes 145.2 trips per week moving an average of 45.3 pieces per trip, of which only 6.4% will be involved with the fabrication storage area. A 14.8% in the number of trips per week are realized, while handling 15.8% less material per trip. If we eventually fill the loads to capacity (assume 53.8 pieces per load is capacity), we will reduce the trips by an additional 15.85 and have a reduction of 30.6% on the total number of trips per week.

In closing the discussion on this section, it should be reiterated that the savings from process lanes implementation is real and measurable. The returns from lost material alone are significant. The savings obtained from standardization of pieces including lifting lugs, padeyes greatly reduces the overall cost. The elimination of multi-ship burning has greatly reduced rework cost via established procedures for material flow through process lanes.

QUESTIONS/ANSWERS

HULL STEEL MATERIAL MOVEMENT COMPARISON BY TRIPS AND DISTANCE

	PRESENT METHOD	PROCESS LANES	DIFFERENCE
Material Handling Distance/week (Miles)	66.6	43.4	23.2
Material Handling Distance To-From Fab. Storage	39.3	5.9	33.4
Percent M. H. Distance To-From Fab. Storage	60.0	13.6	
Trips / week from Plate Shop	42.3	62.3	(20.0)
Trips/week from Platen 18	5.3	11.4	(6.1)
Trips/week from A-Crane Storage	31.3	7.7	23.6
Distinct Moves	177	119	58

HULL STEEL MATERIAL MOVEMENT COMPARISON BY PIECES

DESCRIPTION	PRESENT METHOD	PROCESS LANES	DIFFERENCE
Pieces/week	9,174	6,571	2,603
Pieces To - From Fabrication Storage	5,564	532	5,032
Percent To - From Fabrication Storage	60.7	8.0	
Trips/week	170.5	145.2	25.3
Pieces/trip	53.8	45.3	8.5
Trips/week To - From Fabrication Storage	81.5	9.3	72.2
Percent To - From Fabrication Storage	47.8	6.4	

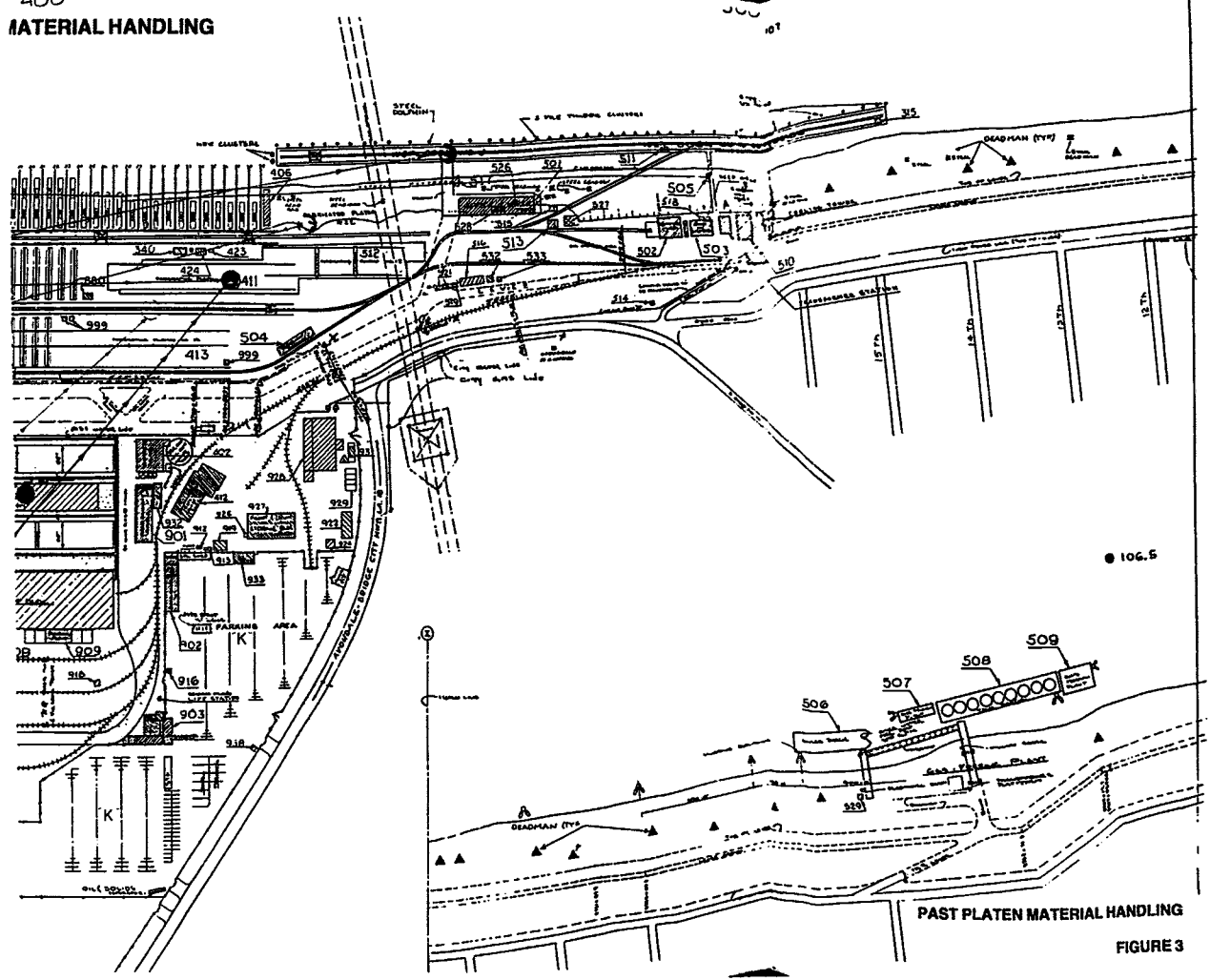
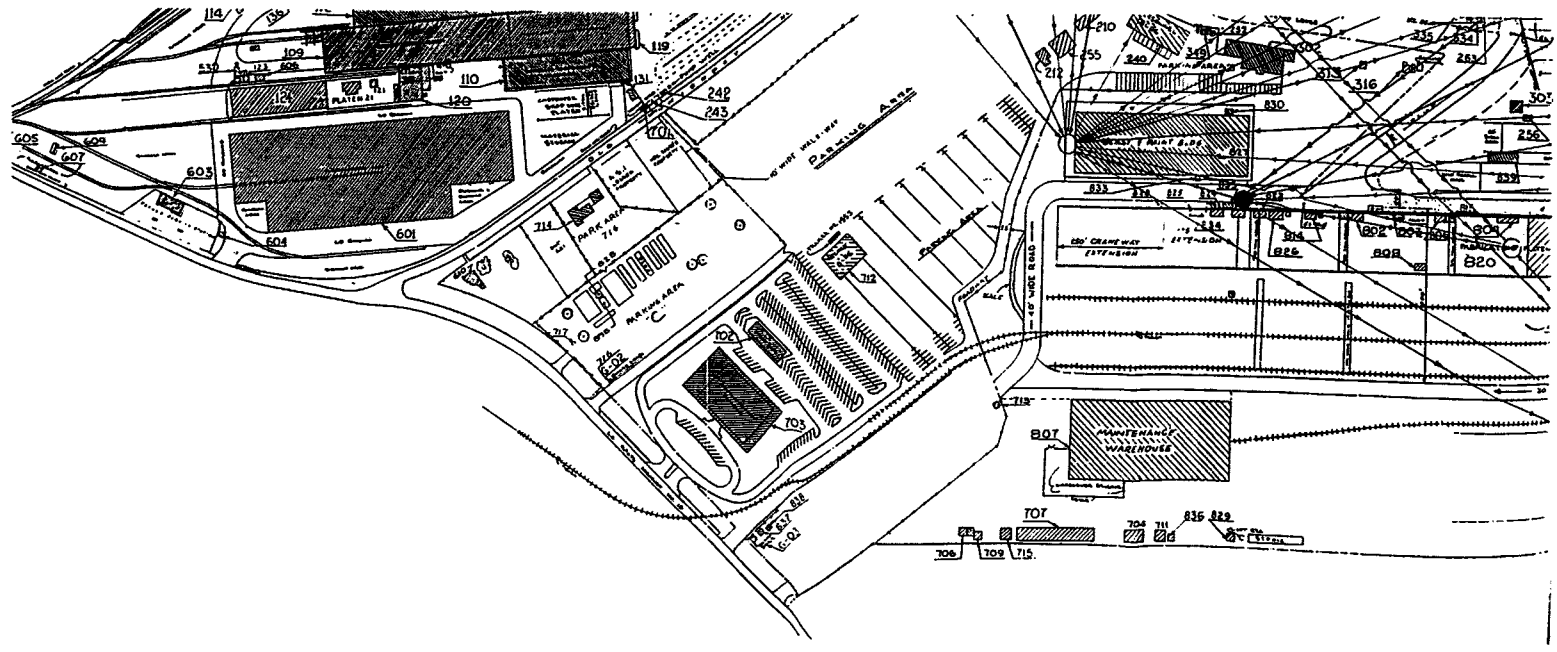
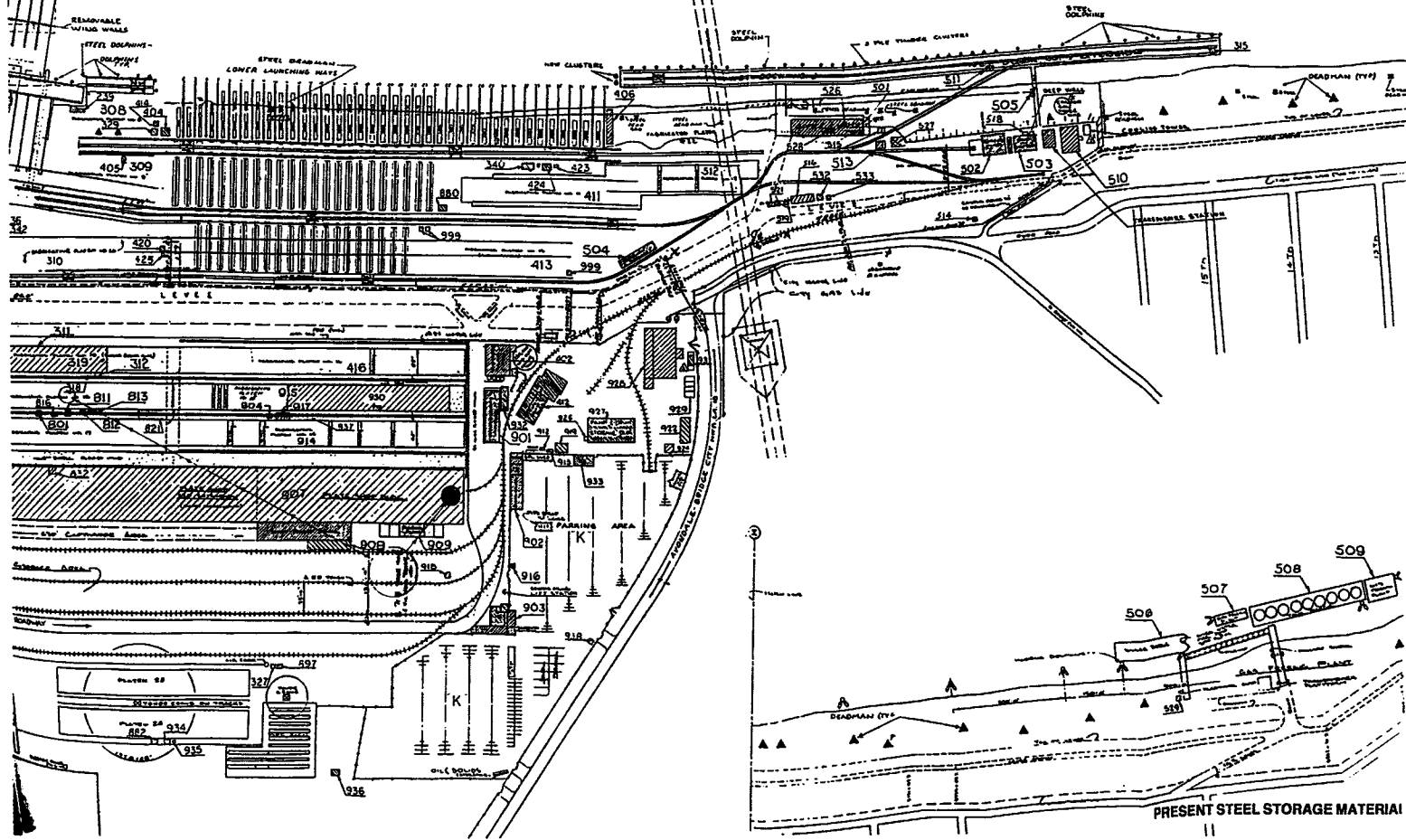

FIGURE 3



400
PRESENT STEEL STORAGE MATERIAL HANDLING

300
107



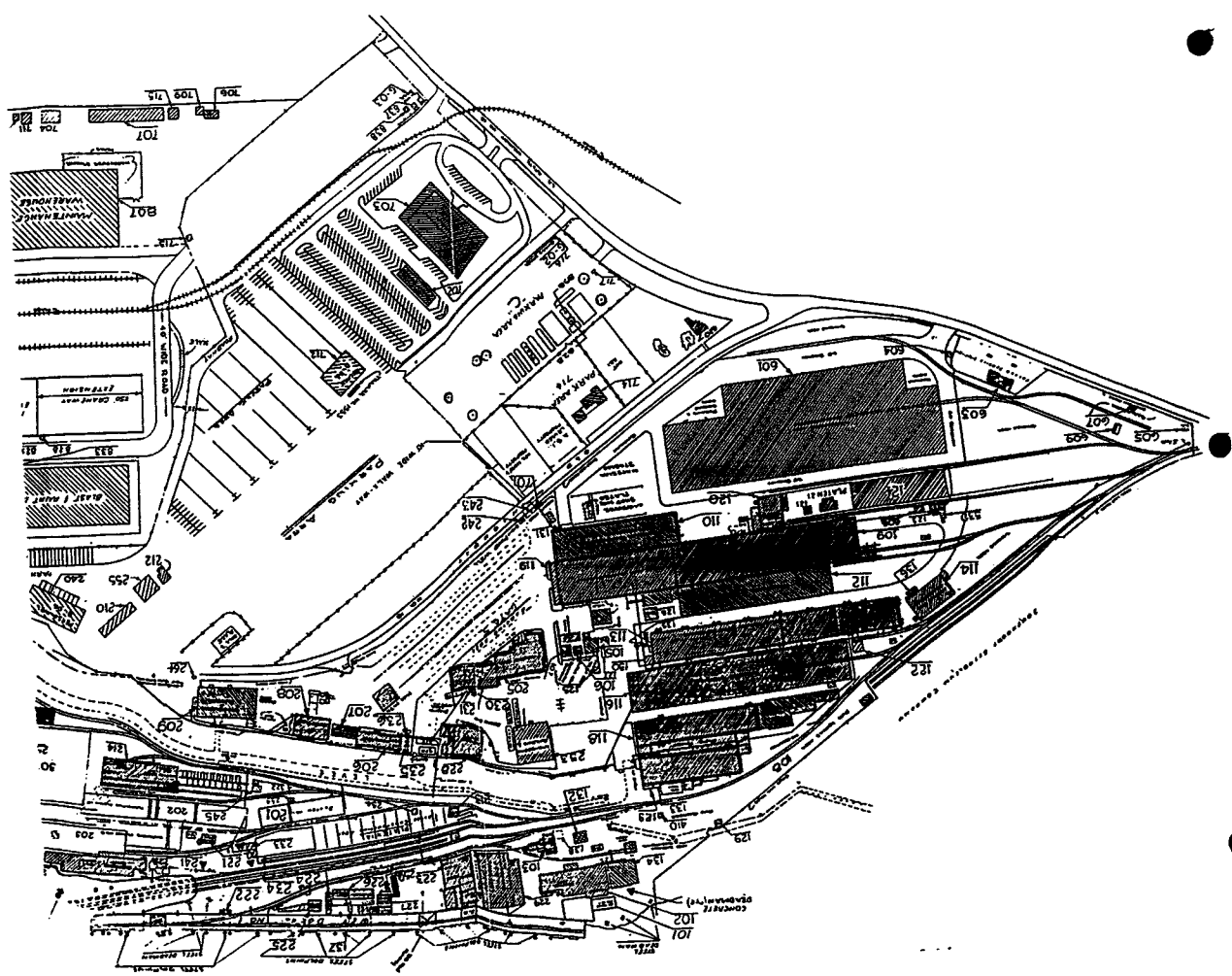

AVONDALE SHIPYARDS, INC
NEW TECHNOLOGY IN SHIPBUILDING

NEW TECHNOLOGY APPLICATIONS

- ZONE OUTFITTING
 - * PACKAGE UNITS
 - * ON-UNIT OUTFITTING
 - * ON-BOARD OUTFITTING

- ACCURACY CONTROL

- PROCESS LANES

- LINE HEATING

- PIN JIGS



AVONDALE SHIPYARDS, INC.
 NEW TECHNOLOGY IN SHIPBUILDING

EVOLUTION OF NEW SHIPBUILDING TECHNOLOGY

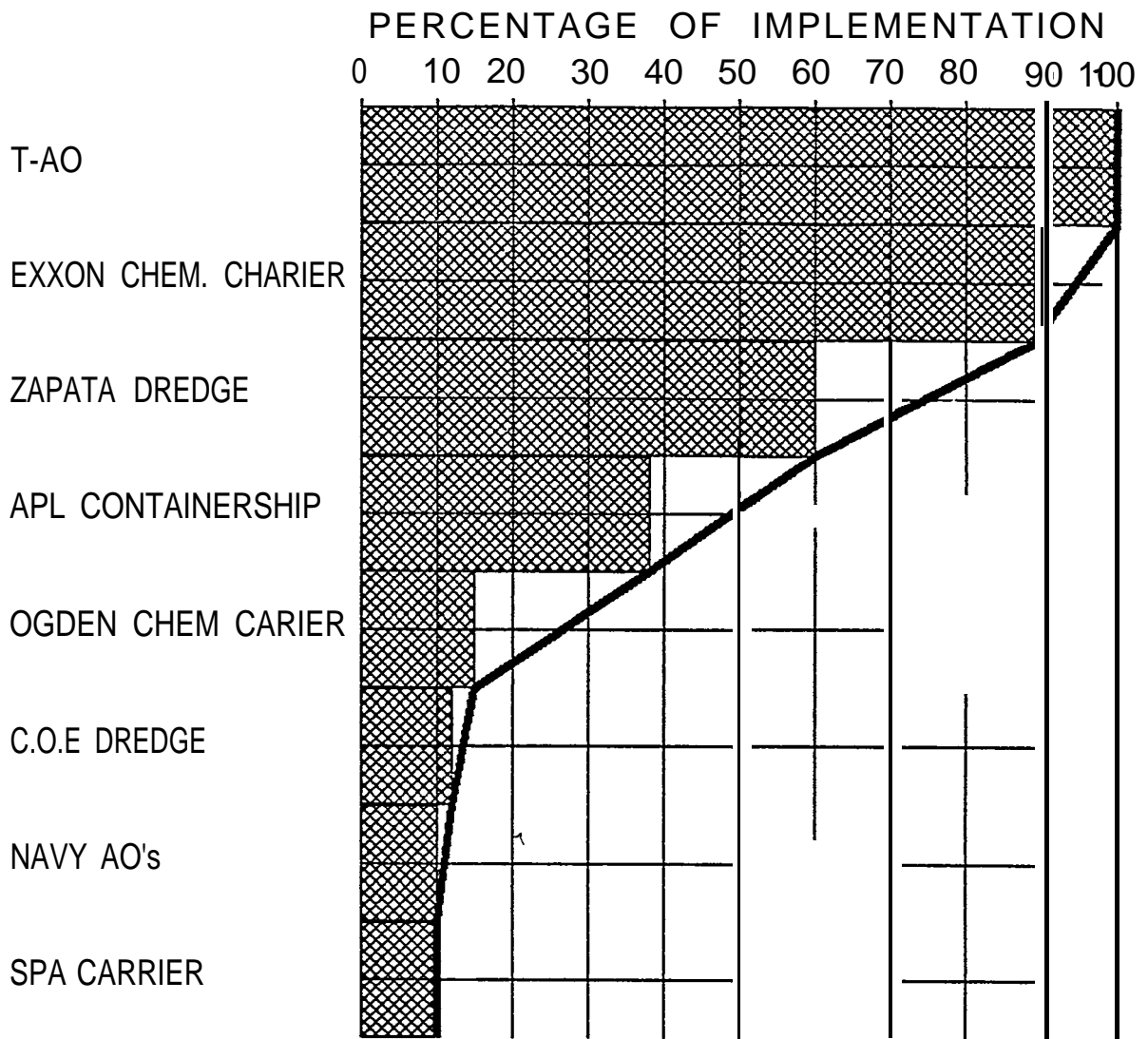

**NEW TECHNOLOGY VS TRADITIONAL
PLANNING AND ENGINEERING EFFORT
IN SUPPORT OF CONSTRUCTION**

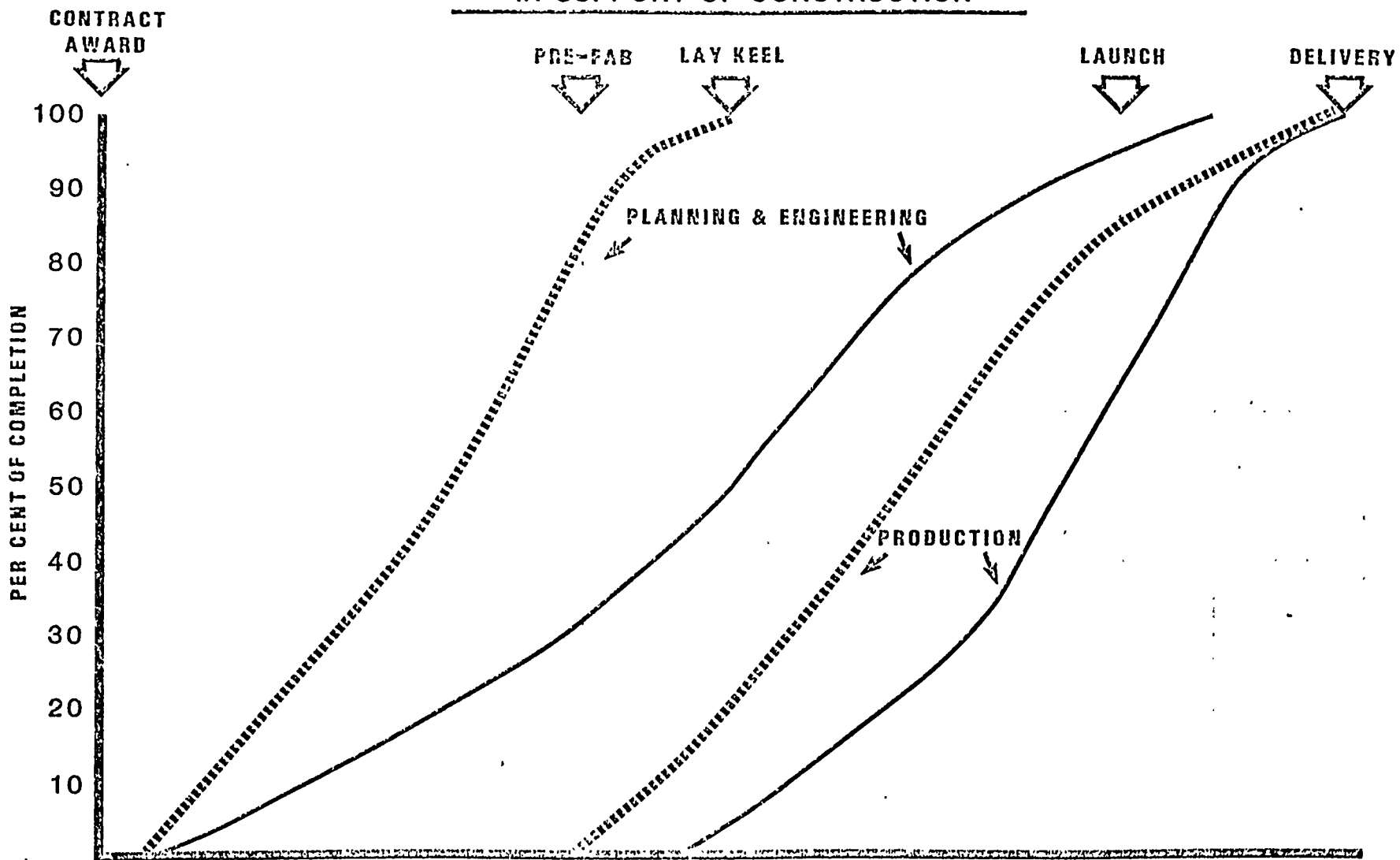

COMPARISON OF PLANNING & ENGINEERING EFFORT VS PRODUCTION CRAFT EFFORT

CONVENTIONAL DESIGN & CONSTRUCTION METHODS _____
CURRENT ASI DESIGN & CONSTRUCTION METHODS ······

JOB DESCRIPTION AT EACH STAGE
IN NEW HULL AND OUTFITTING
ENGINEERING PROCEDURE AT ASI

MARKETING STAGE DEFINITIONS

(A) – CONTRACT SPECIFICATION

- SHIP PROPORTIONS
- DRAWINGS

LINES

GENERAL ARRANGEMENT OF HULL AND MACHINERY

SUPERSTRUCTURE AND QUARTERS ARRANGEMENTS

MIDSHIP SECTION

SCANTLING SECTIONS

PRELIMINARY SHELL EXPANSION

CARGO OIL SYSTEM DIAGRAM (3)

INERT GAS, DEHUMIDIFICATION AND CARGO VENT DIAGRAMS (3) – 43 TANKS

ENGINE – RELATED AND OTHER PIPING DIAGRAMS

- DIAG. MAIN ENGINE LUBE OIL SYSTEM
- DIAG. MAIN ENGINE CYLINDER LUBE OIL SYSTEM
- DIAG. LUBE OIL FILLINGS, TRANSFER AND PURIFIER SYSTEM
- DIAG. STERN TUBE LUBE OIL SYSTEM
- PIPING MATERIAL SCHEDULE
- DIAG. ENGINE ROOM BILGE & BALLAST SYSTEM
- DIAG. SEGREGATED BALLAST SYSTEM
- DIAG. FEED AND CONDENSATE SYSTEM
- DIAG. FIREMAIN – ENGINE ROOM
- DIAG. FIREMAIN – ACCOMMODATIONS
- DIAG. FIREMAIN AND FOAM SYSTEM – MAIN DECK
- DIAG. CENTRAL FRESH WATER COOLING SYSTEM
- DIAG. MAIN ENGINE JACKET WATER COOLING SYSTEM
- DIAG. MAIN ENGINE PISTON COOLING WATER SYSTEM
- DIAG. MAIN ENGINE FUEL VALVE COOLING WATER SYSTEM

**JOB DESCRIPTION AT EACH STAGE
IN NEW HULL AND OUTFITTING
ENGINEERING PROCEDURE AT ASI**

- DIAG. MAIN SEA WATER COOLING SYSTEM
 - DIAG. AUXILIARY SEA WATER COOLING SYSTEM
 - DIAG. VENTS, SOUNDING TUBES AND OVERFLOWS
 - DIAG. STEAM SYSTEM
 - DIAG. SHIP'S SERVICE, STARTING AND CONTROL AIR SYSTEM
 - DIAG. FUEL OIL SERVICE SYSTEM
 - DIAG. FUEL OIL FILLING, TRANSFER, AND PURIFICATION SYSTEM
 - DIAG. DIESEL OIL SYSTEM
 - DIAG. FUEL, SLUDGE AND MAIN ENGINE CLEANING SYSTEMS
 - DIAG. TANK HEATING COILS
- CALCULATION OR OTHER TECHNICAL DATA
- WEIGHT ESTIMATE
 - LONGITUDINAL STRENGTH
 - HYDROSTATICS
 - TANK CAPACITIES
 - BONJEANS CURVES
 - INTACT TRIM AND STABILITY DATA
 - LOADING CONDITIONS
 - DAMAGED STABILITY EVALUATION
 - WAKE SURVEY
 - RESISTANCE AND SELF-PROPELLED TESTS
 - ELECTRIC LOAD ANALYSIS
 - ELECTRIC ONE LINE DIAGRAM
 - VENT SYSTEM DEVELOPMENT AND DUCT OPENING

**JOB DESCRIPTION AT EACH STAGE
IN NEW HULL AND OUTFITTING
ENGINEERING PROCEDURE AT ASI
4 MONTHS**

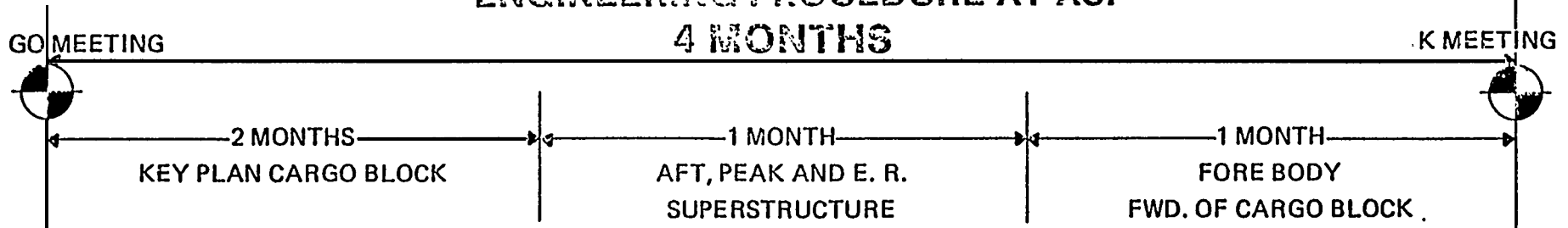

KEY PLAN STAGE

- FRAME BODY PLAN (BASED ON FAIRED LINES)
- SHELL EXPANSION
- FORE CONSTRUCTION
 - DECK, FLAT AND STRINGER
 - ELEVATION (LONGITUDINAL BULKHEAD AND GIRDER)
 - EVERY FRAME SECTION AND TRANSVERSE BULKHEAD
- HOLD PAR CONSTRUCTION
 - DECK AND FLAT
 - ELEVATION
 - EVERY FRAME SECTION AND TRANSVERSE BULKHEAD.
- ENGINE ROOM AND AFT CONSTRUCTION
 - DECK AND FLAT
 - ELEVATION
 - EVERY FRAME SECTION AND TRANSVERSE BULKHEAD
- SUPERSTRUCTURE CONSTRUCTION
- SET-UP OF SPADE DATA BASE
- APPROVAL OF REGULATORY BODY AND OWNER
- FINAL UNIT ARRANGEMENT AND LIST
- 70% - 75% STEEL BILLED - BUY STEEL AS NEEDED
- DETERMINE PLATES TO BE FURNACED BY "K" MEETING
- ISSUE FINAL OUTFIT MILESTONE SCHEDULE
- ISSUE FINAL PALLET LIST

STYLE OF DRAWING:
OVERVIEW OF STRUCTURE

**JOB DESCRIPTION AT EACH STAGE
IN NEW HULL AND OUTFITTING
ENGINEERING PROCEDURE AT ASI
4 MONTHS**

GO MEETING

K MEETING

← 2 MONTHS →
KEY PLAN CARGO BLOCK

← 1 MONTH →
AFT, PEAK AND E. R.
SUPERSTRUCTURE

← 1 MONTH →
FORE BODY
FWD. OF CARGO BLOCK

KEY PLAN STAGE

- FRAME BODY PLAN (BASED ON FAIRED LINES)
- SHELL EXPANSION
- FORE CONSTRUCTION
 - DECK, FLAT AND STRINGER
 - ELEVATION (LONGITUDINAL BULKHEAD AND GIRDER)
 - EVERY FRAME SECTION AND TRANSVERSE BULKHEAD
- HOLD PAR CONSTRUCTION
 - DECK AND FLAT
 - ELEVATION
 - EVERY FRAME SECTION AND TRANSVERSE BULKHEAD
- ENGINE ROOM AND AFT CONSTRUCTION
 - DECK AND FLAT
 - ELEVATION
 - EVERY FRAME SECTION AND TRANSVERSE BULKHEAD
- SUPERSTRUCTURE CONSTRUCTION
- SET-UP OF SPADE DATA BASE
- APPROVAL OF REGULATORY BODY AND OWNER
- FINAL UNIT ARRANGEMENT AND LIST
- 70% - 75% STEEL BILLED - BUY STEEL AS NEEDED
- DETERMINE PLATES TO BE FURNACED BY "K" MEETING
- ISSUE FINAL OUTFIT MILESTONE SCHEDULE
- ISSUE FINAL PALLET LIST

STYLE OF DRAWING:

OVERVIEW OF STRUCTURE

JOB DESCRIPTION AT EACH STAGE IN NEW HULL AND OUTFITTING ENGINEERING PROCEDURE AT ASI

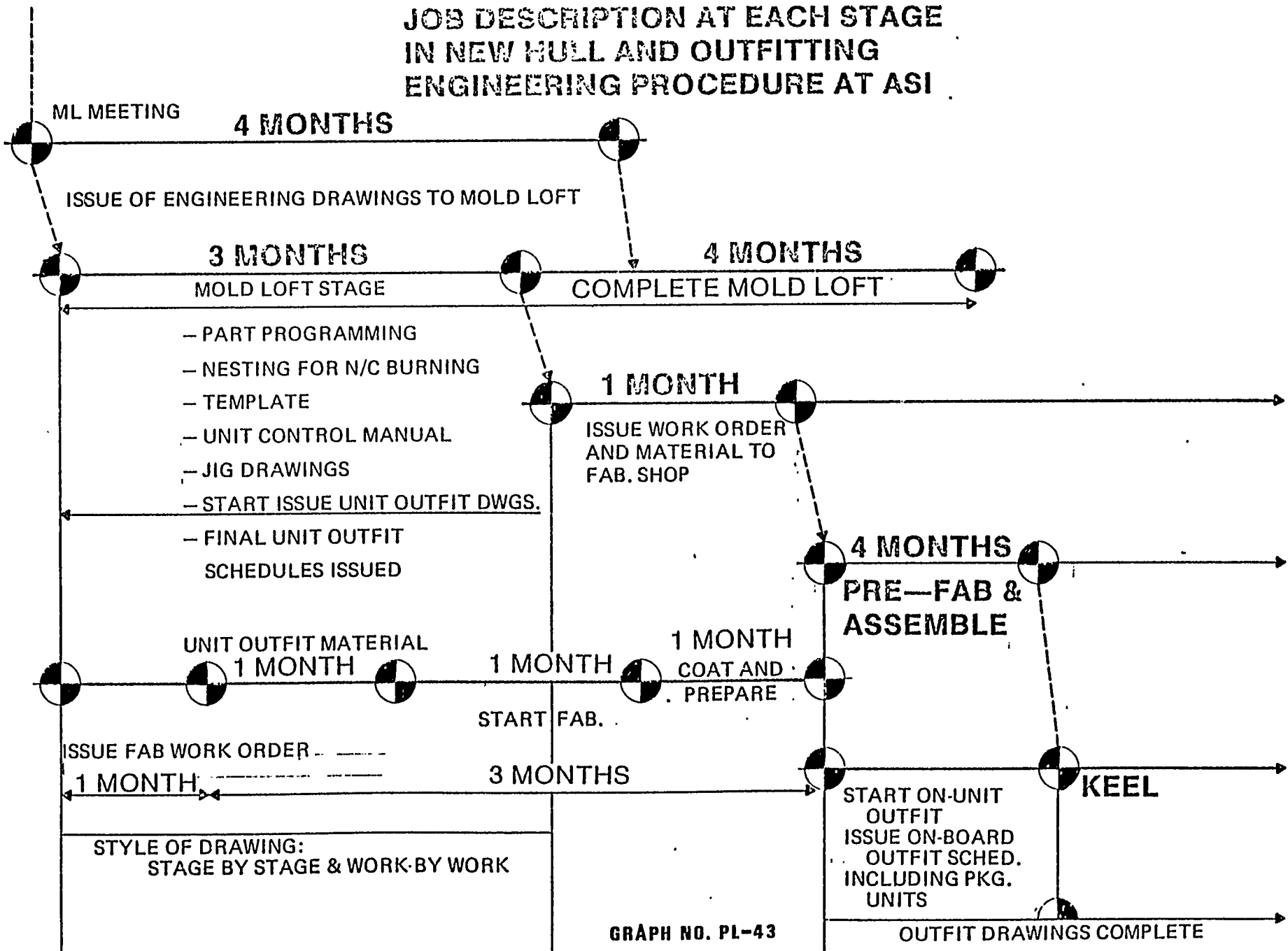

EXXON NO.1 ERECTION SCHEDULE REV.1

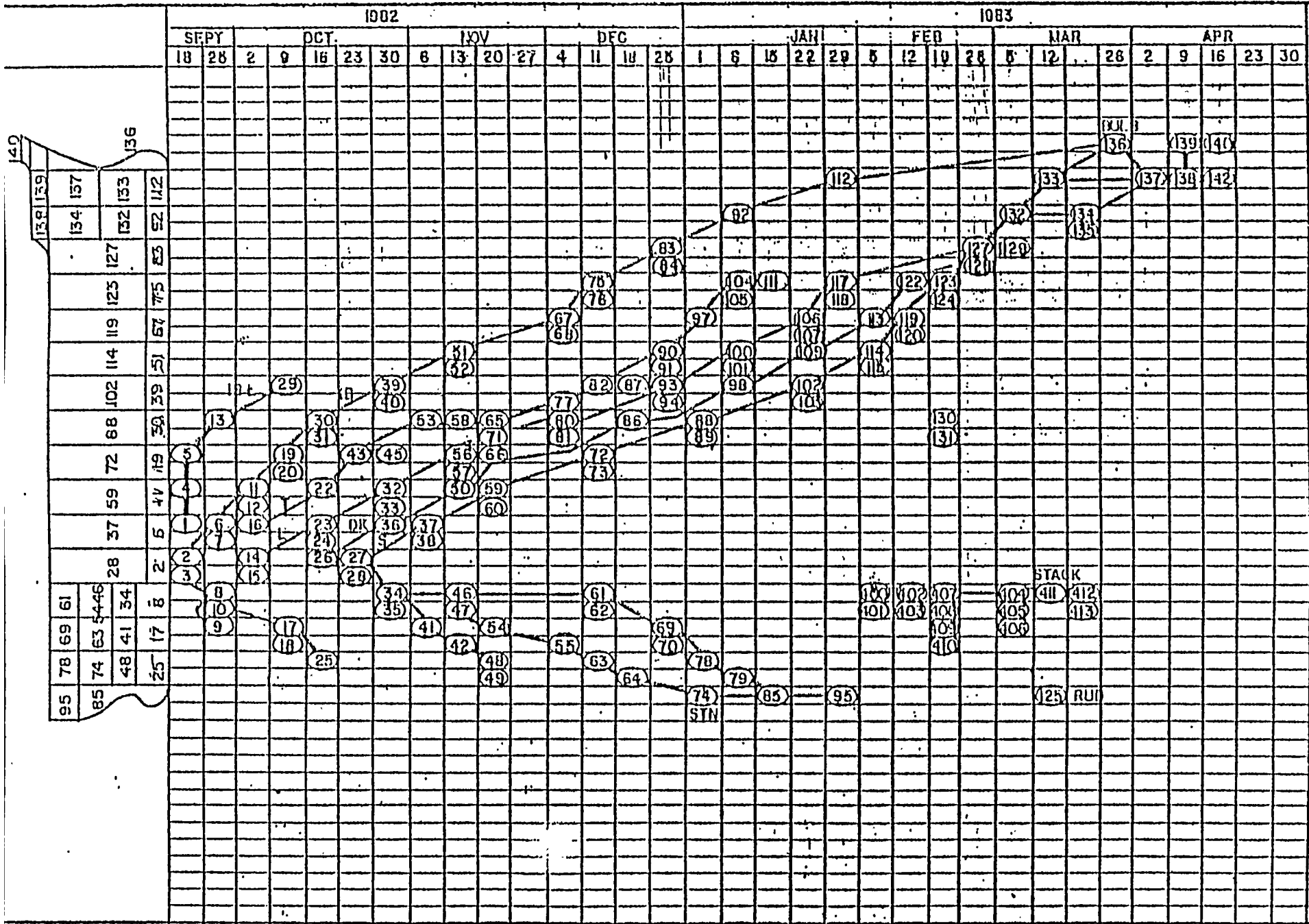

MAJOR SCHEDULES ISSUED AT AS

TYPE SCHEDULE	PURPOSE & USE	GENERATED BY	DISTRIBUTED TO	FREQUENCY OF
MASTER YARD SCHEDULE	TOTAL WORK LOAD INDICATOR PROJECT UP TO 3 YEARS	PRODUCTION PLANNING	TOP MANAGEMENT	MONTHLY
JOB STAGE DESCRIPTION FOR HULL & OUTFIT ENGINEERING	ESTABLISH NEED DATES FOR INFOR & DWGS. CONTRACT ORIENTED	ENGINEERING PRODUCTION PLANNING & ADVANCED PRGMS.	TOP MANAGEMENT	PRE-CONTRACT
HULL UNIT BREAKDOWN	IDENTIFY MODULAR SECTIONING OF SHIP	PRODUCTION PLANNING	TOP MANAGEMENT ENGINEERING PRODUCTION PURCHASING	PRE-CONTRACT
ADVANCED PURCHASING ZONES	PROJECT STANDARD ZONE DELIV. DATES	PRODUCTION PLANNING	DITTO	PRE-CONTRACT
MASTER MILE STONE	ESTABLISH ALL KEY EVENTS AND ALL MAJOR MILESTONES	PRODUCTION PLANNING	DITTO	AFTER CONTRACT AND MONTHLY UPDATE
PALLET SCHEDULE	ESTABLISH STAGE CODES AND DATES FOR MATERIAL PALLETS	PRODUCTION PLANNING	DITTO	AFTER CONTRACT
MAIN ASSEMBLY AND ERECTION	ESTABLISH ERECTION SEQUENCE AND UNIT IDENTIFICATION	PRODUCTION PLANNING	TOP MANAGEMENT ENGINEERING PRODUCTION	AFTER CONTRACT MONTHLY REVIEW
PRE-FAB & SUB ASSEMBLY	IDENTIFY LEAD TIME & STAGES OF FABRICATION	PRODUCTION PLANNING	DITTO	AFTER CONTRACT MONTHLY REVIEW
DRAWING SCHEDULE	IDENTIFY ALL DWGS AND ESTABLISH ALL NEED DATES	ENGINEERING	DITTO	AFTER CONTRACT
DRYDOCK & WHARF SCHEDULE	ESTABLISH DRYDOCK PERIODS AND WHARF TIME & LOCATION	PRODUCTION PLANNING	DITTO	MONTHLY
LONG TERM PROCESS LANES	LONG TERM PRODUCT WORK BREAKDOWN FOR HULL WORK	PRODUCTION PLANNING	DITTO	AFTER CONTRACT REVIEW MONTHLY
SHORT TERM PROCESS LANES	SHORT TERM PRODUCT WORK BREAKDOWN FOR HULL WORK	FABRICATION SHOP PLANNERS	DITTO	AFTER CONTRACT REVIEW WEEKLY
COMPARTMENT COMPLETION	ESTABLISH COORDINATED COMPLETIONS OF COMPARTMENTS	PRODUCTION FIELD PRODUCTION PLANNING	DITTO	AFTER CONTRACT REVIEW WEEKLY
MECHANICAL TEST SCHEDULE	ESTABLISH COORDINATED COMPLETIONS OF TEST PROCEDURES	PRODUCTION FIELD PRODUCTION PLANNING	DITTO	AFTER CONTRACT REVIEW WEEKLY

PROCESS LANES AND DESIGN ENGINEERING
FOR ZONE OUTFITTING
AVONDALE SHIPYARDS, INC.

SCHEDULE PLANNING FOR HULL CONSTRUCTION

Prepared by: E. L. JAMES

PROCESS LANES AND DESIGN ENGINEERING
FOR ZONE OUTFITTING
SCHEDULE PLANNING FOR HULL CONSTRUCTION

I. TOTAL CONTRACT PLANNING REQUIREMENTS

Historically, the importance of planning and scheduling of the total contract requirements has been very much under-emphasized. The coordination and subsequent performance of the support functions, in terms of timeliness and accuracy, obviously has a direct and powerful impact on the success of the production effort. Most often we have not done anywhere near what is required to assure production of a successful construction effort. Consequently, when schedules become critical and quality suffers, the production effort stands last in line and suffers from our upfront inadequacies. The development and implementation of process lanes, in hull construction, serves to delineate many of our old shortcomings.

To support the requirements of the process lanes system, a concentrated upfront planning effort is a must. In fact, a "process lanes" approach to the total contract requirements is essential to proceed in advance of hull construction. This is a dramatic departure from the traditional approach that has prevailed in the shipbuilding environment (SEE GRAPH PL-24 FOR COMPARISON). This objective can only be achieved if we keep in mind and constantly remind ourselves that the total contract requirements themselves must be planned and monitored. GRAPH PL-25 provides a general outline for the basis of a total requirements planning effort.

This approach to planning, as with any other method of planning, requires a well organized planning organization. The process lanes concept requires defined standard operating procedures which provide the system to coordinate, develop and assimilate upfront data to Engineering, Production, and support departments. This serves to assure visibility of the total contract requirements and the relationship to other contracts.

The implementation of process lanes requires the development and preparation of information and data from planning, beginning during the bid stage on new contracts. The process lanes system provides detail feedback from each production stage, which is valuable in the evaluation of new contract capacity requirements and the compatibility of key dates for proposed contracts. The routine monitoring of schedule status and cost efficiency readily provides the data required to firmly commit to new contracts and deliver on schedule.

At award, it is essential that pre-award planning be readily available for the total contract requirements. At Avondale, we utilize a document referred to as the "Job Description At Each

Stage Schedule" which represents a meaningful and realistic approach to the entire planning and scheduling process. Obviously, hull construction planning and the process lanes system is only one part of the many integrated parts and efforts from beginning to end. GRAPHS PL-26 THROUGH PL-30 depict the overall effort for hull construction on the total contract in some detail. This concept has been presented in other seminars and is being re-emphasized here because of its importance to process lanes.

As mentioned earlier, the "Job Description At Each Stage Schedule" must be realistic. It is important that the stages of the total contract requirements, as well as process lanes, be time phased to assure adequate lead time is provided for all functions (Engineering, Production Planning, Purchasing, Mold Loft and Production Engineering) to perform their tasks in timely manner.

Beginning very early during the marketing stage, pre-determined meetings are conducted to review stage development, and these meetings continue throughout the duration of the contract.

As indicated on GRAPH PL-26, the "marketing" stage definitions are well detailed and provide key pieces of information necessary for all of the subsequent stages. The contract specifications, ships lines and contract drawings are essential. The midship sections, scantling expansions provide much detailed planning information. The machinery arrangements and diagrammatic are essential for outfitting and hull planning development.

As indicated on GRAPH PL-26, the calculation and technical data developed at this time is essential to the following engineering stages. Preliminary procurement specifications must be started for resolution at contract.

As noted on GRAPH PL-28, one month after contract the second "go" meeting is held with Engineering, Planning and top management to assure that the preparation stage is progressing satisfactorily.

Four months after the "go" meeting, a third meeting referred to as the "K" meeting (or key plan stage) is held to assure that approval from the regulatory bodies and the customer is available. At this time key plans should be available.

As indicated on GRAPH PL-29, the planning and scheduling milestones are identified and set the stage for the subsequent detail schedules. On GRAPH PL-30 the mold loft, prefabrication, fabrication, sub-assembly, assembly and outfitting evaluations are clearly defined by activity.

It is not enough to establish and monitor the construction stages; in fact, controls are essential to achieve the increased efficiency as planned with the process lanes concept.

The overall system of process lanes, like the total contract requirements, must interface and each division must execute their respective parts of the plan. If this does not occur, as we discussed earlier, the burden of late and out-of-sequence information creates log jams and facility over-burdens which impact the construction effort.

Thus, the initial schedule planning for hull construction sets the stage for all subsequent planning and schedule, which was discussed in some detail in the presentation on Unit Breakdown and Scheduling and will be further defined in the upcoming presentation on Planning Control Systems.

QUESTIONS/ANSWERS

**NEW TECHNOLOGY VS TRADITIONAL
PLANNING AND ENGINEERING EFFORT
IN SUPPORT OF CONSTRUCTION**

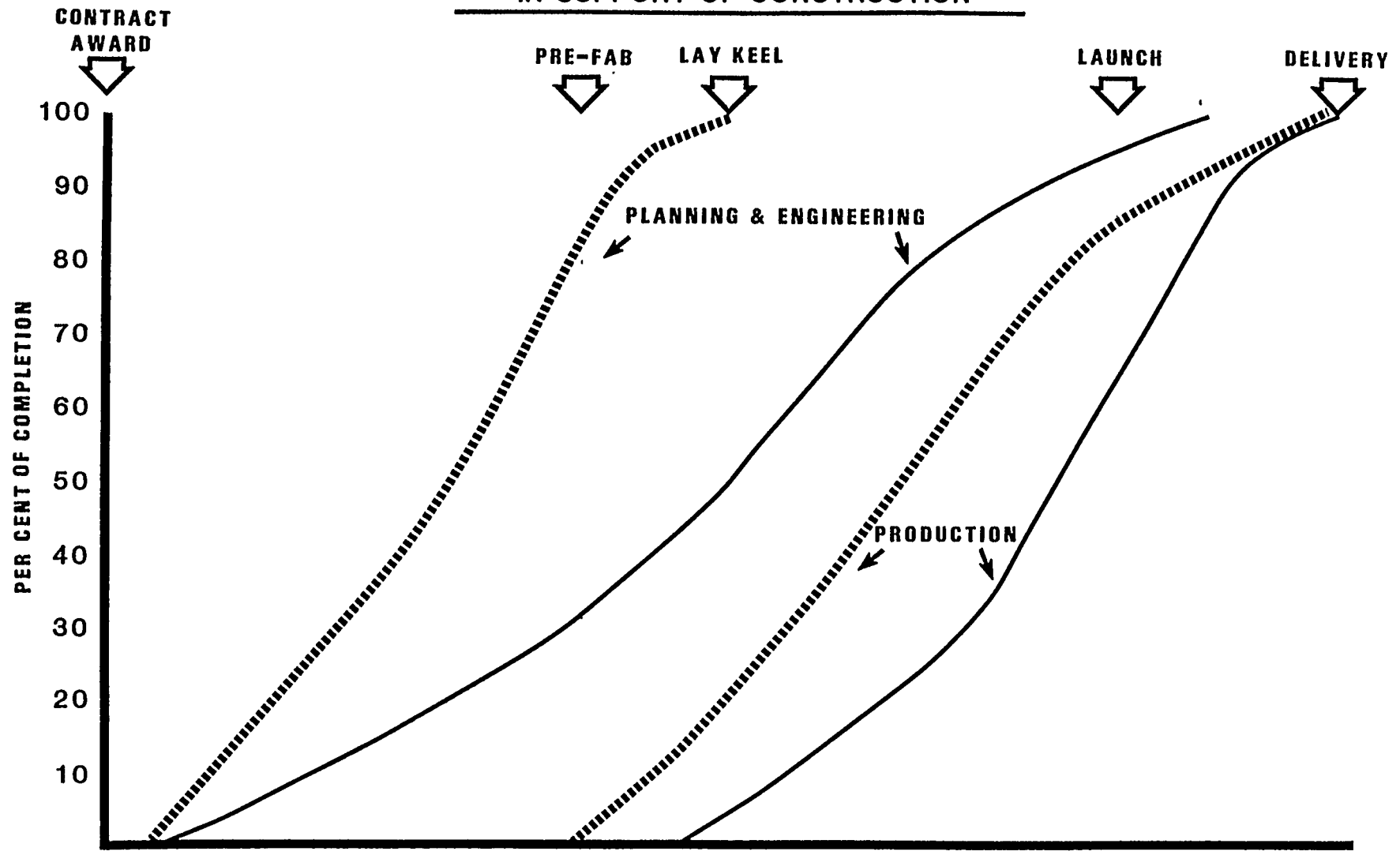

COMPARISON OF PLANNING & ENGINEERING EFFORT VS PRODUCTION CRAFT EFFORT

CONVENTIONAL DESIGN & CONSTRUCTION METHODS —————
CURRENT ASI DESIGN & CONSTRUCTION METHODS ·······

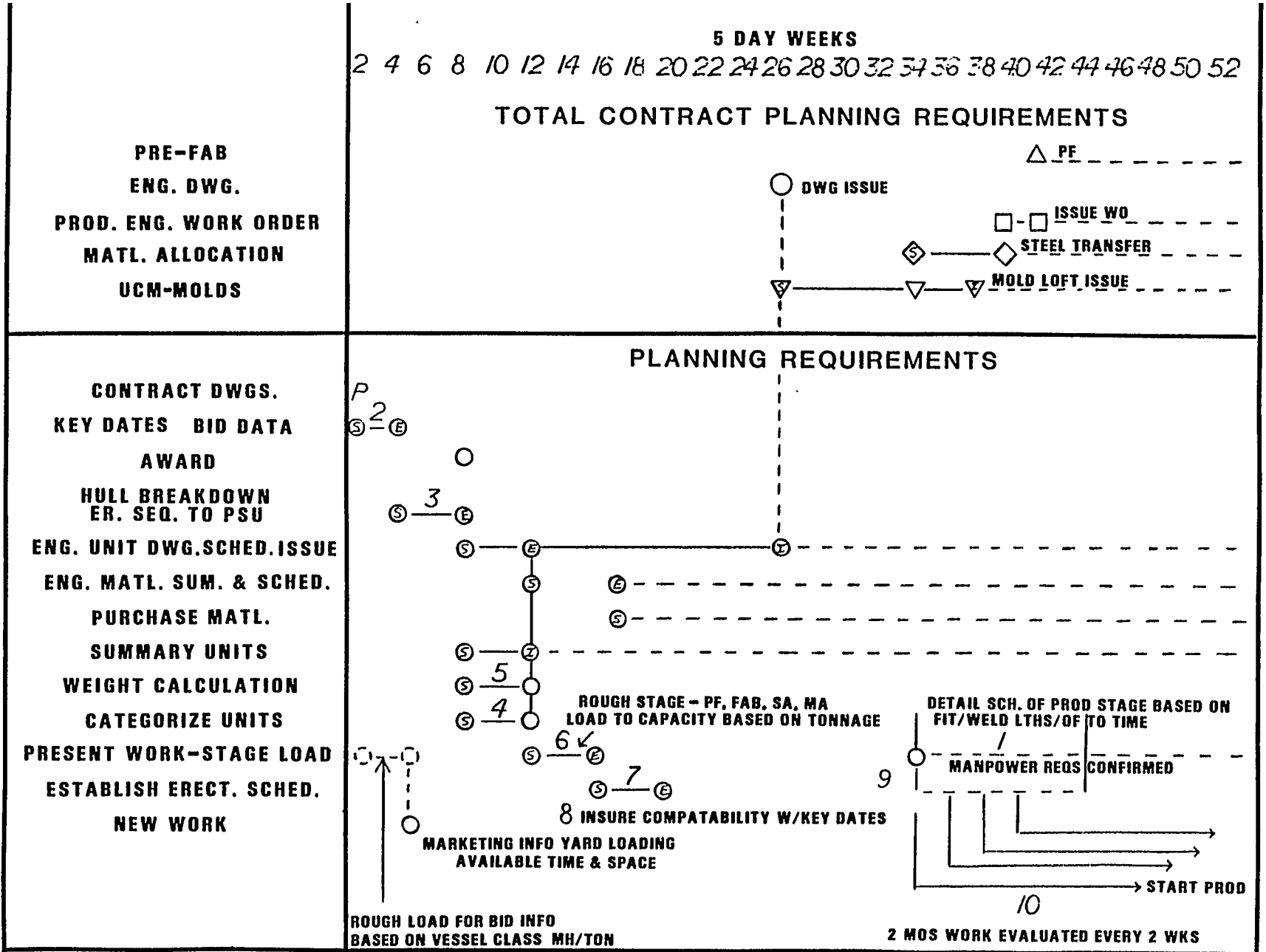

GRAPH NO. PL-25

MARKETING,

JOB DESCRIPTION AT EACH STAGE IN NEW HULL AND OUTFITTING ENGINEERING PROCEDURE AT ASI

MARKETING STAGE DEFINITIONS

- (A) – CONTRACT SPECIFICATION
- SHIP PROPORTIONS
- DRAWINGS

LINES

GENERAL ARRANGEMENT OF HULL AND MACHINERY

SUPERSTRUCTURE AND QUARTERS ARRANGEMENTS

MIDSHIP SECTION

SCANTLING SECTIONS

PRELIMINARY SHELL EXPANSION

CARGO OIL SYSTEM DIAGRAM (3)

INERT GAS, DEHUMIDIFICATION AND CARGO VENT DIAGRAMS (3) – 43 TANKS

ENGINE – RELATED AND OTHER PIPING DIAGRAMS

- DIAG. MAIN ENGINE LUBE OIL SYSTEM
- DIAG. MAIN ENGINE CYLINDER LUBE OIL SYSTEM
- DIAG. LUBE OIL FILLINGS, TRANSFER AND PURIFIER SYSTEM
- DIAG. STERN TUBE LUBE OIL SYSTEM
- PIPING MATERIAL SCHEDULE
- DIAG. ENGINE ROOM BILGE & BALLAST SYSTEM
- DIAG. SEGREGATED BALLAST SYSTEM
- DIAG. FEED AND CONDENSATE SYSTEM
- DIAG. FIREMAIN – ENGINE ROOM
- DIAG. FIREMAIN – ACCOMMODATIONS
- DIAG. FIREMAIN AND FOAM SYSTEM – MAIN DECK
- DIAG. CENTRAL FRESH WATER COOLING SYSTEM
- DIAG. MAIN ENGINE JACKET WATER COOLING SYSTEM

JOB DESCRIPTION AT EACH STAGE IN NEW HULL AND OUTFITTING ENGINEERING PROCEDURE AT ASI

- DIAG. MAIN SEA WATER COOLING SYSTEM
- DIAG. AUXILIARY SEA WATER COOLING SYSTEM
- DIAG. VENTS, SOUNDING TUBES AND OVERFLOWS
- DIAG. STEAM SYSTEM
- DIAG. SHIP'S SERVICE, STARTING AND CONTROL AIR SYSTEM
- DIAG. FUEL OIL SERVICE SYSTEM
- DIAG. FUEL OIL FILLING, TRANSFER, AND PURIFICATION SYSTEM
- DIAG. DIESEL OIL SYSTEM
- DIAG. FUEL, SLUDGE AND MAIN ENGINE CLEANING SYSTEMS
- DIAG. TANK HEATING COILS

- CALCULATION OR OTHER TECHNICAL DATA
 - WEIGHT ESTIMATE
 - LONGITUDINAL STRENGTH
 - HYDROSTATICS
 - TANK CAPACITIES
 - BONJEANS CURVES
 - INTACT TRIM AND STABILITY DATA
 - LOADING CONDITIONS
 - DAMAGED STABILITY EVALUATION
 - WAKE SURVEY
 - RESISTANCE AND SELF-PROPELLED TESTS
 - ELECTRIC LOAD ANALYSIS
 - ELECTRIC ONE LINE DIAGRAM
 - VENT SYSTEM DEVELOPMENT AND DUCT OPENING

**JOB DESCRIPTION AT EACH STAGE
IN NEW HULL AND OUTFITTING
ENGINEERING PROCEDURE AT ASI
4 MONTHS**

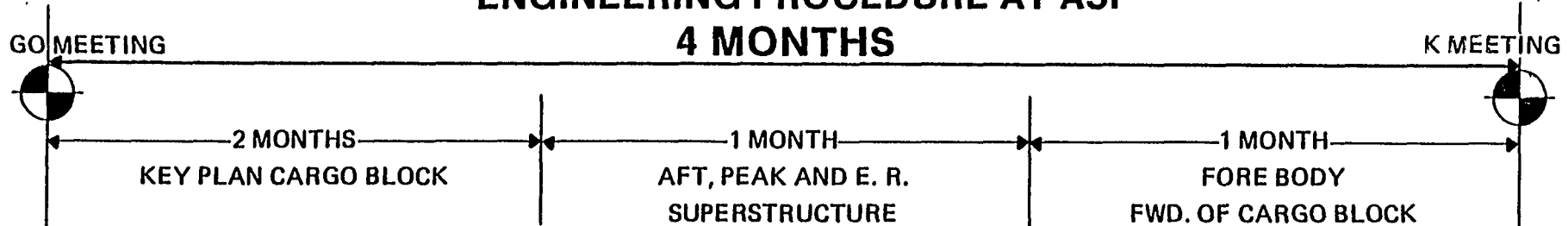

KEY PLAN STAGE

- FRAME BODY PLAN (BASED ON FAIRED LINES)
- SHELL EXPANSION
- FORE CONSTRUCTION
 - DECK, FLAT AND STRINGER
 - ELEVATION (LONGITUDINAL BULKHEAD AND GIRDER)
 - EVERY FRAME SECTION AND TRANSVERSE BULKHEAD
- HOLD PAR CONSTRUCTION
 - DECK AND FLAT
 - ELEVATION
 - EVERY FRAME SECTION AND TRANSVERSE BULKHEAD
- ENGINE ROOM AND AFT CONSTRUCTION
 - DECK AND FLAT
 - ELEVATION
 - EVERY FRAME SECTION AND TRANSVERSE BULKHEAD
- SUPERSTRUCTURE CONSTRUCTION
- SET-UP OF SPADE DATA BASE
- APPROVAL OF REGULATORY BODY AND OWNER
- FINAL UNIT ARRANGEMENT AND LIST
- 70% - 75% STEEL BILLED - BUY STEEL AS NEEDED
- DETERMINE PLATES TO BE FURNACED BY "K" MEETING
- ISSUE FINAL OUTFIT MILESTONE SCHEDULE
- ISSUE FINAL PALLET LIST

**STYLE OF DRAWING:
OVERVIEW OF STRUCTURE**

**JOB DESCRIPTION AT EACH STAGE
IN NEW HULL AND OUTFITTING
ENGINEERING PROCEDURE AT ASI
4 MONTHS**

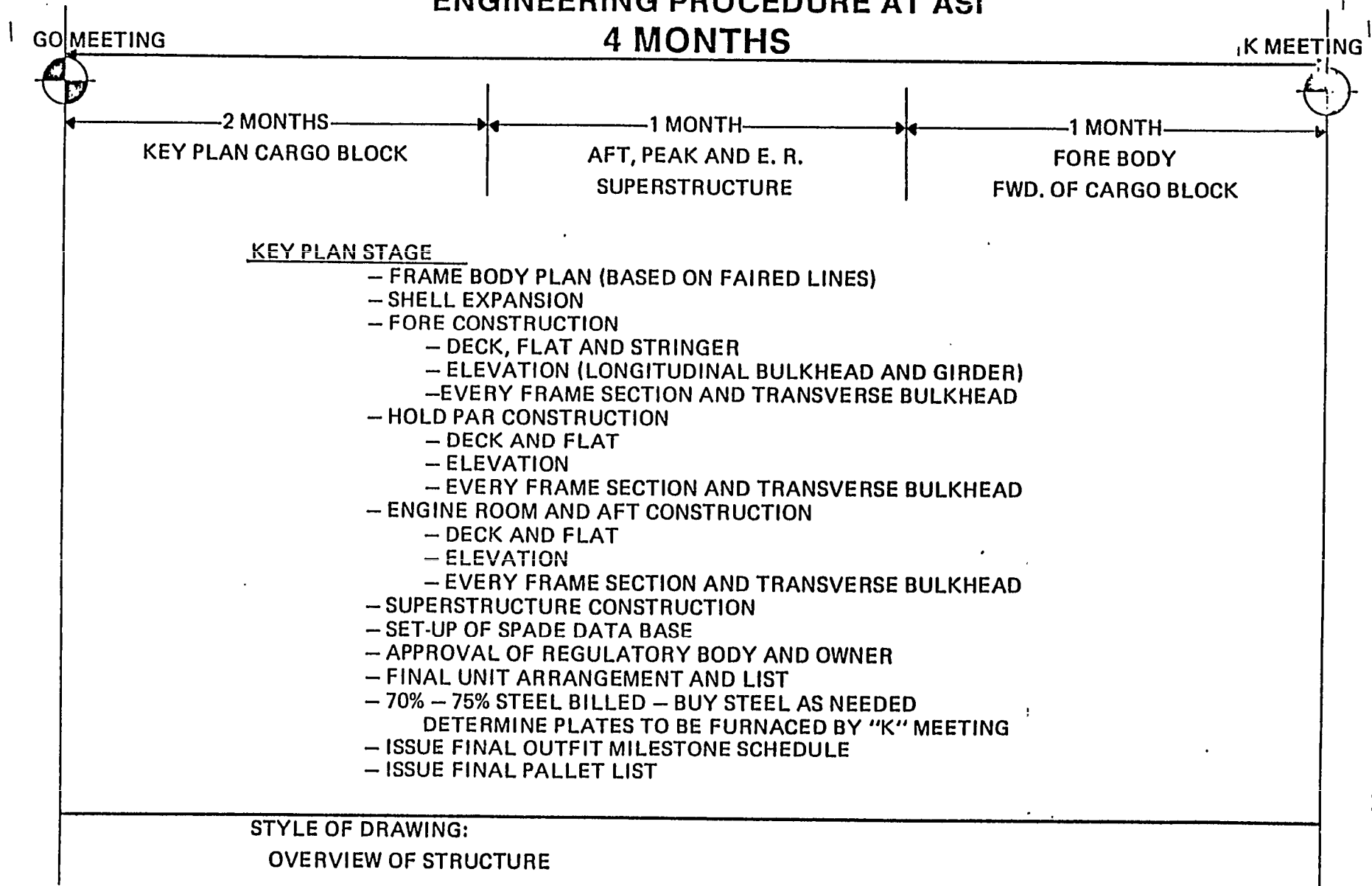

JOB DESCRIPTION AT EACH STAGE IN NEW HULL AND OUTFITTING ENGINEERING PROCEDURE AT ASI

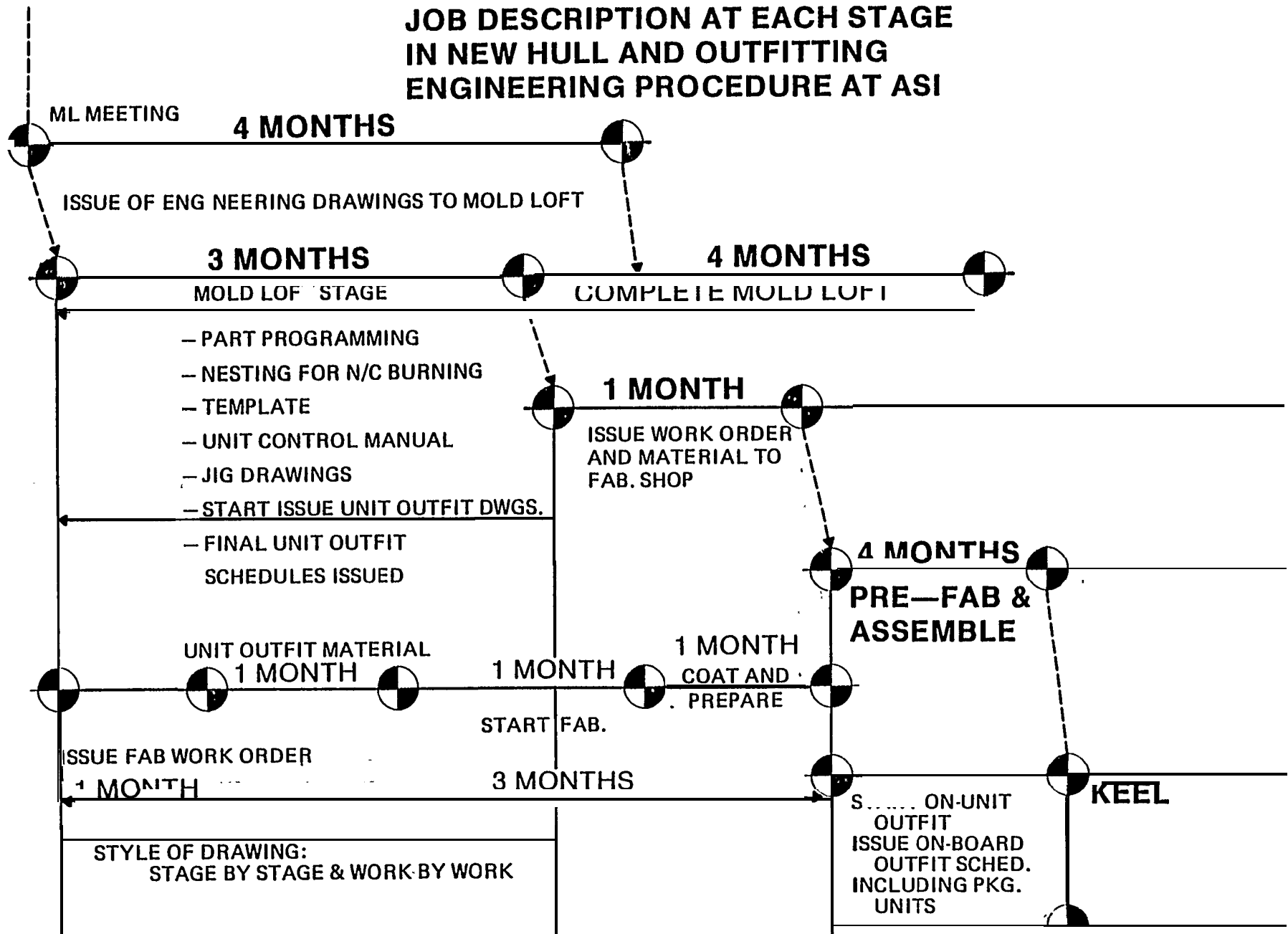

PROCESS LANES AND DESIGN ENGINEERING
FOR ZONE OUTFITTING
AUONDALE SHIPYARDS, INC.

PLANNING CONTROLS UNDER PROCESS LANES

Prepared by: D. BERGERON

PROCESS LANES AND DESIGN ENGINEERING
FOR ZONE OUTFITTING
PLANNING CONTROLS UNDER PROCESS LANES

i. INTRODUCTION

With, implementation of the process lanes concept, the Production Planning Department has been required to perform more definitive analysis and in-depth study of the planning and scheduling functions. This analysis has dictated that the planning and scheduling activities must occur in a more detailed and more timely manner. Process lanes highlighted the fact, furthermore, that specific planning functions must occur in a pre-determined sequence to support the level loading aspect of process lanes (SEE GRAPH PL-31). The level loading process and the proper sequence of flow are an absolute to providing a realistic and achievable construction schedule.

II. PLANNING CONTROLS

The functional and sequential planning control guidelines were established as basic steps essential in support of the process lanes concept, as well as the overall planning development. Thus, the following guidelines were considered to be steps paramount to support a successful construction effort (SEE GRAPH PL-32):

1. Determine present platen loading;
2. Establish key dates;
3. Divide hull into units and develop erection sequence;
4. Categorize hull units;
5. Weight calculations by unit (rough);
6. Platen load (Platen #20) to capacity;
7. Establish the erection sequence;
8. Insure compatibility with key dates;
9. Prepare long term schedule;
10. As detailed drawings become available - refine weight estimates and all schedules;
11. Planning flow diagrams.

Summaries of the planning controls required for each of the above guidelines are defined as follows:

9) DETERMINE PRESENT PLATEN LOADING

Study the present and long term platen loading for contracts in progress on Platen No. 20 and Platen No. 17. Platen No. 20 is the main assembly area for flat type units with shorter durations; while Platen No. 17 is the main assembly area for curved units which generally are longer duration units, as discussed in the Unit Breakdown section. The platen loadings are constantly monitored and the loading for any given week should be immediately available for each platen and all contracts on hand for the duration of the long term schedules.

B) ESTABLISH KEY DATES

The Planning Department must establish the possible key event dates (start of pre-fabrication, keel, launch and delivery) as early as possible, based on the required delivery date set by the customer and within the overall master (Long Term) yard schedule. This effort must be "Rough Cut" or preliminary for contract bid purposes and then refined upon signing of the contract (or letter of intent). During the key event review, lead times for engineering drawing development and lofting development must be given priority attention. Risibility in these areas must be maintained during the upcoming planning evolutions.

c) DIVIDE HULL INTO UNITS AND DEVELOP ERECTION SEQUENCE

The unit arrangement drawing is prepared by Production Planning for purposes of identifying the finalized unit erection breaks and unit numbering. This evolution is essential for further development of the desired erection sequence. A list of units with the basic unit description s is prepared. Preliminary weights for planning purposes are added to the unit description sheets prior to issue,

D) CATEGORIZE HULL UNITS

The hull units are now categorized within the process lanes concept, as discussed in the Physical Process Lanes and Unit Breakdown sections; whereas, a separate list of units is then prepared within each of the six (6) process lanes categories, along with basic unit descriptions and more refined weights (to be added later). The planning engineers

then begin detailed study of the construction method for each individual unit for determining the proper category in which to place each unit.

E) WEIGHT CALCULATIONS

Weight estimates must be developed for each unit in Category 1 and Category 2 for purpose of proper platen loading on Platen No. 20 (Process Lane No. 1) and Platen No. 17 (Process Lane No. 2).

F) PLATEN LOAD PLATEN NO. 20 TO CAPACITY

After thoroughly reviewing the loading of Platen No. 20 (Guideline No. 1) for the duration of NEW contract based on the established preliminary key event dates, the platen should then be loaded (week by week) to capacity, The quantity of units per week (Based on their weights) can then be determined and this then establishes the number of units per week, that will be available, from Platen No. 20, for erection during any given week from start to launch. The number of units per week thus established are then reviewed against the preliminary unit erection schedule (Guideline No. 3) and the erection schedule can be finalized.

G) ESTABLISH ERECTION SCHEDULE

Using the sequence of erection developed in Guideline No. 3 and the number of units per week available from Platen No. 20 developed in Guideline No. 6, the erection schedule can be developed. For example, if the first 5 units to be erected are numbered in sequence No. 1, No. 2, No. 3, **No. 4**, and No. 5 and the unit weights are:

Unit No. 1	=	86.5 Tons
Unit No. 2	=	125.0 Tons
Unit No. 3	=	125.0 Tons
Unit No. 4	=	86.5 Tons
Unit No. 5	=	<u>86.5</u> Tons
Total		509.5 Tons

Then Units No. 1 through No. 5 can be erected in one (1) week leaving $600 - 509.5 = 90.5$ tons (based on 600 tons/week output Platen No. 20) available for units on another ship.

It is important to note that the quantity of Category 1 units per week to be erected (all jobs) cannot exceed this maximum tonnage output per week available from Platen No. 20. This condition can be adjusted via either expansion of the platen grids or via the level loading process while developing the long term schedules, if additional **tonnage is** necessary at the erection site. Further refinements can be made to the erection schedule after completion of the level loading process, if necessary.

H) INSURE COMPATIBILITY WITH KEY DOTES

Review the prepared erection schedule to be sure that all units can be erected in a timely fashion with the rough draft key event dates established in Guideline No. 2 and consistent with machinery and material requirements. Adjustments to platen loading (Guideline No. 6) should be made if required as preciously noted, attention to engineering drawing issue dates and lofting leadtime requirements must be maintained,

I) PREPARE LONG TERM SCHEDULES

The long term schedules or platen loading schedules are now prepared. Short term schedules are developed and issued for one (1) to two (2) month intervals for the platens. The platen schedules are dynamic with routine review and update form feedback via shop planner, etc.

J) DETAILED DRAWINGS – REFINE SCHEDULE

As detailed drawings are developed and become available, a review of all weight estimates is continued; whereby, fitting and welding lengths are utilized to further refine and update all platen loading schedules.

K) PLANNING FLOW DIAGRAMS

The lead hull planners start development of the construction methods by unit early during the key plan stage (SEE GRAPH PL-33) . The detail breakdown of units into partial sub-assemblies and main assembly is completed early and assigned to specific process lanes. The issue of detail drawings allow for detail refinement of the "Working Instructions" prior to final issue to the loft. During the detail drawing review production planning prepares the Units Parts Listings (UPL) which breaks the material down to the "Working Instruction" level prior to issue to the Loft.

III. STAGE PLANS

Stage plans are documents which are vital to the process lane operations . This concept is very similar to the documents used by the IHI ship yards. The Avondale stage plan takes the form of the Unit Control Manual (UCM). The Mold Loft has prime responsibility for preparation and issue of their key documents . It is produced in its final form on Cadam based on the following:

Unit Summary Sheet (work instruction prepared by Production Planning);

Unit Drawing from Engineering;

Unit Parts List from Production Planning;

SPADES hull data base on N/C parts file,

The UCM is a driving document which communicates the work instruction to all responsible parties, through the process lanes flow, in support of the platen schedules.

The UCM, the material transfers, work orders and the schedules are essential for the production personnel to perform their tasks in a timely and efficient manner. Efforts have been made in this area to assure that the supervisor and worker get that information neccessary to do the job, no more and no less. In virtually all cases the UCM satisfies the need for the unit drawing in the field.

Stage plans produced by the Production Planning Department and the shop planners assure that the proper material flow is maintained. The Shop Planner prepares detailed shop schedules based on the master platen schedules and work center loading. Shop planners are assigned responsibility for each separate.

Platen and are further responsible for maintaining manning and efficiency charts (SEE GRAPH PL-34) for the individual work center.

IV. PROCESS AND EFFICIENCY CONTROL

All of the planning, scheduling, work instructions and stage plans discussed in the various sections today provide the basis for controls. These devices are utilized by Program Management, Production Planning, Production Engineering and Production to monitor and report. In addition, Material Control, along with Storage Control and Transportation Control, monitors the movement of materials. The UCM and the UPL provide the

tools to monitor and control this effort. Accuracy Control plays a vital role throughout the process flows providing feedback for action, as necessary, relative to manufacturing standards, tolerance, and methods. Process lanes has given increased attention to the use of standards within our Engineering and Production effort.

Manpower controls are available for each work center based on the detail process lanes schedules.

The long term and short term process lanes schedules provide a forum for formal weekly Production Control Meetings. Status for all work centers is reviewed at the detail level. Corrective action is taken as necessary and reports are generated for top management use.

QUESTIONS/ANSWERS

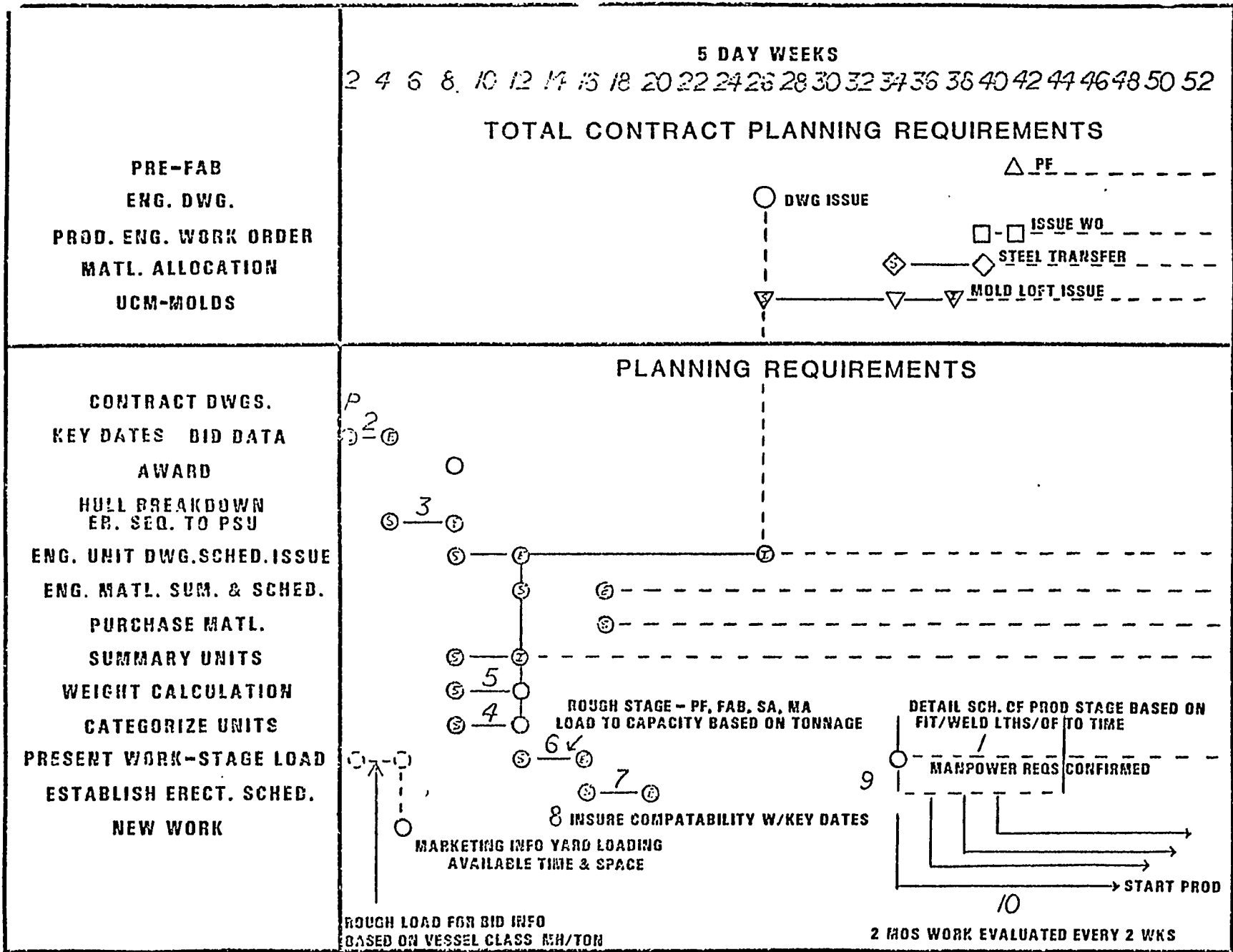

GRAPH NO. PL-31

P R O C E S S L A N E S
P L A N N I N G G U I D E L I N E S

- 1) DETERMINE PRESENT PLATEN LOADING
- 2) ESTABLISH KEY DATES
- 3) DIVIDE HULL INTO UNITS AND DEVELOP
ERECTION SEQUENCE
- 4) CATEGORIZE HULL UNITS
- 5) WEIGHT CALCULATIONS BY UNIT (ROUGH)
- 6) PLATEN LOAD (PLATEN 20) TO CAPACITY
- 7) ESTABLISH THE ERECTION SCHEDULE
- 8) INSURE COMPATIBILITY WITH KEY DATES
- 9) PREPARE GROUND ASSEMBLY SCHEDULE
- 10) AS DETAILED DRAWINGS BECOME AVAILABLE -
REFINE WEIGHT ESTIMATES AND ALL SCHEDULES

THE FUNCTIONS FOR HULL CONSTRUCTION
RELATE TO EACH OTHER AND FLOW IN SEQUENCE.

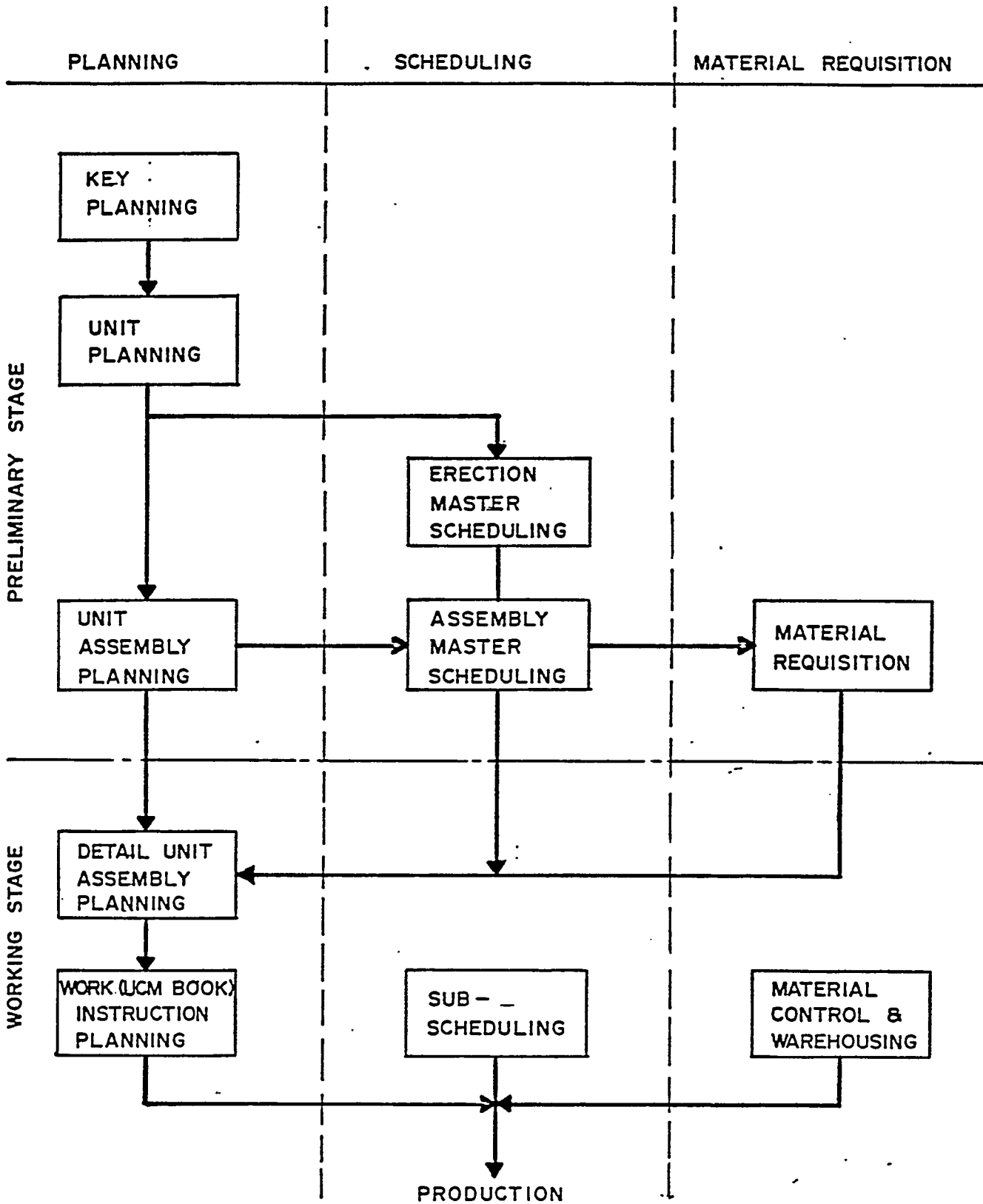

EFFICIENCY CONTROL CHART

SNO C9-215 PRE-FABRICATION TOTAL

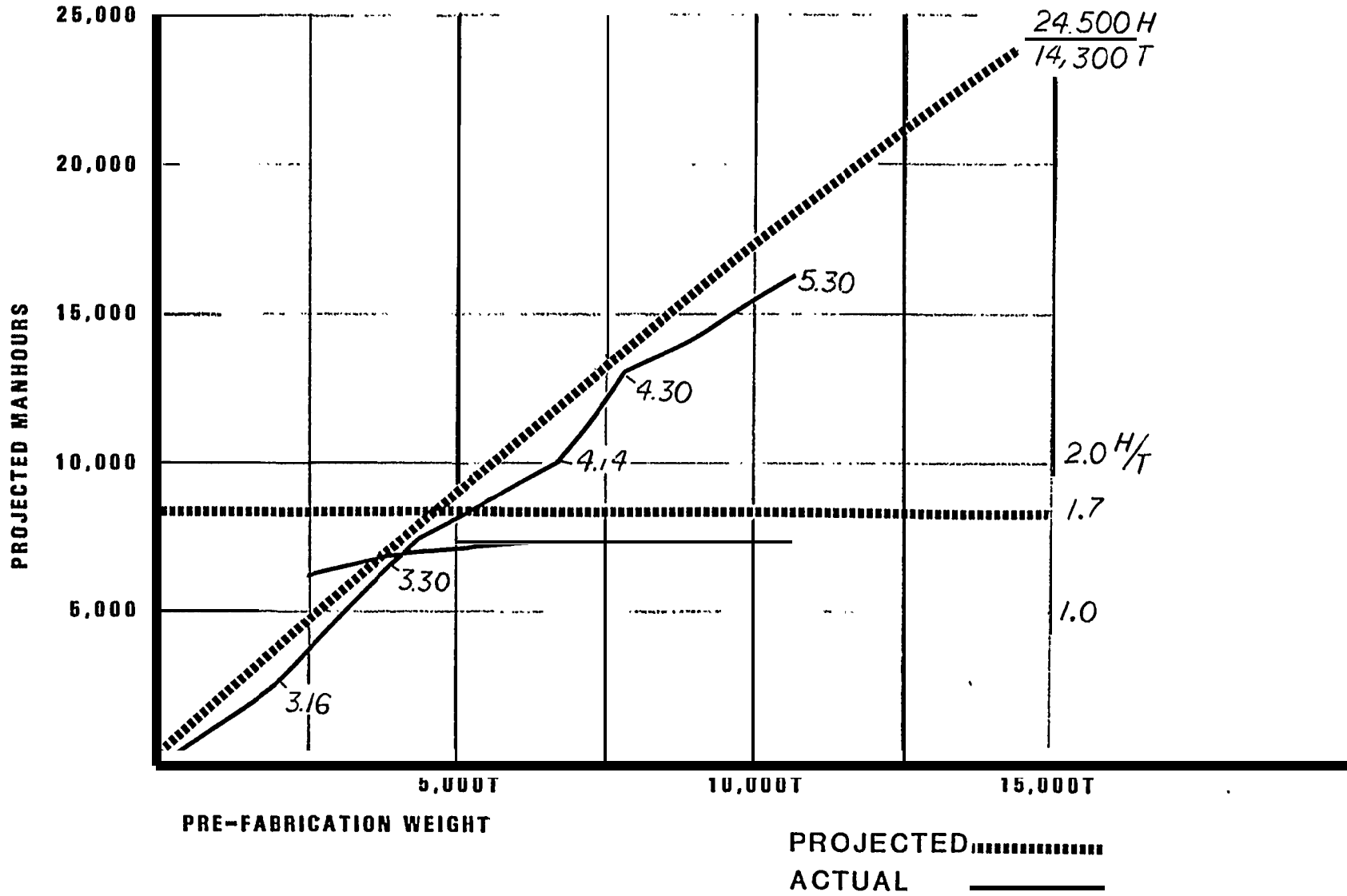

GRAPH NO. PL-34

PROCESS LANES AND DESIGN ENGINEERING
FOR ZONE OUTFITTING
AVONDALE SHIPYARDS, INC.

PRODUCTION ENGINEERING SECTION
PRODUCTION CONTROL DEPARTMENT
PRODUCTION COST CONTROLS

Prepared by: R. OEHMICHEN

PROCESS LANES AND DESIGN ENGINEERING
FOR ZONE OUTFITTING
PRODUCTION COST CONTROLS

I. INTRODUCTION

A number of production controls are currently in use within the Production Control Department. This presentation will address those cost controls which have been implemented as a direct result of the I.H.I. technology transfer, or those which, without the benefit of the technology, could not have otherwise been implemented. Controls that were preciously in effect prior to the technology transfer are reviewed only as those controls have effect on the overall system.

Production controls, other than cost, are addressed in other areas of the seminar.

II. THE PRODUCTION WORK ORDER

The Work Order System in use at ASI was discussed in detail at a previous seminar and is presented here to review its significance as being the primary document, to not only drive the work effort prescribed by the various schedules, but around which all schedule and cost monitoring evolves. All other cost control and analysis systems currently in use depend on the information provided or generated by the work order.

III. HULL WORK COST COLLECTION AND MONITORING

The work order (GRAPH NO. O1PE) is prepared by the Production Engineer for a specified portion of hull construction and reflects the following criteria:

- job number;

cost group, sub-group, item number and vessel number
(obtained from production plan);

weight (in tons) obtained from the Ship Production & Control Report (SPAC);

manhour estimate, prepared by the Production Engineer through detailed drawing take-off and "weighted" with the production plan manhour-per-ton estimates for the stage of construction and work/cost center. This individual work

order estimate has the net effect of issuing the manhours (reflected to the cost "item" level in the production plan) to the manufacturing superintendent in small, measured increments which can be more closely monitored;

indicates the work/cost center and authorizes the manufacturing superintendent to accomplish the work;

- describes the work to be accomplished based on instructions contained in the Hull Unit Summary and the UCM construction details;

indicates the starting date and completion date obtained from the short or long term schedules;

serial number - gives the work order identity for data processing tracking and control;

vehicle for accumulating the daily direct labor cost expended toward the work effort. When the Production Engineer releases the work order to the work center, a copy goes to the Data Processing Department where D/P cards are key punched with the cost codes, estimate, weight, serial number, etc., which is returned to the Production Engineering Department affixed to the superintendent's copy. Data Processing also enters the work order into the computer data base. As the work prescribed in the text of the work order progresses, the direct labor manhours are "entered" directly into the computer data base by the work/cost center superintendent at a local terminal. The computer accumulates the manhour charges and D/P printouts are run on a daily basis and forwarded to the Production Engineer for continuous monitoring of progress regarding percent completion and cost (actual spending versus estimate). D/P printouts can be sorted in various ways to facilitate overall job monitoring such as the listing of all "active" work orders on one report and all "closed" work orders on another. The daily reports are used to monitor individual work order efficiency and progress, whereas the "closed" and "active" reports are used for determining overall percent completion and a projection on work remaining to be accomplished.

IV. DATA PROCESSING REPORTS

Three EDP reports used for controls and which utilize the work order as a primary source of information are:

- The Combined Work Order Report (GRAPH 02PE)
- The Closed Work Order Report
- The "Late Complete" Work Order Report (GRAPH 03PE)

A11 three reports draw information from the work order file and are used in a number of applications within the system. The combined Work Order report, as it relates to Process Lanes technology, is a source document supplying information concerning total direct labor manhours issued on both active and closed work orders, along with the total accumulated tonnage issued to any given Process Lane work center.

The Closed Work Order Report is a source document which supplies the same information but on closed and completed work orders only.

The information supplied by these two reports is utilized as the basis for the Process Lanes Hull Efficiency Report,

The "Late Complete" Work Order Report flags those work orders which were not closed as being complete on the scheduled completion date. This control "alerts" both the Production Engineer and the Planning Engineer so that subsequent review and appropriate action can be effected.

V. PROCESS LANES WORK CENTER BUDGETS

Upon completion of Process Lanes Work Center level loading and subsequent completion of work center schedules by the Planning Section, the Production Engineering Section analyzes the scope of work assigned to the center and applies appropriate labor rate standards to establish work center budget. Charts are then prepared to reflect the targeted tonnage, targeted manhour budget, and targeted manhour/ton efficiency (GRAPH 04PE).

As work progresses through the center, the "actual" accumulated manhours, as well as "actual" completed tonnage, are plotted and graphed for continual monitoring of actual cost of work performed against budget. This is a very simple control document, yet an extremely important one!

VI.. HULLWORK EFFICIENCY REPORT

The Hullwork Efficiency Report (GRAPH 05PE) is an extremely useful control utilized by the Production Engineer. The report is generated for every Process Lane Work Center and is updated and reviewed on a weekly basis throughout the contract. The report headings indicate the contract number, vessel number, cost code, general work effort, work center, targeted tonnage, targeted manhours, and targeted efficiency. The data from the Combined Work Order Report in terms of total manhours issued and total tonnage issued to the work center is input and the subsequent mh/ton efficiency that those work orders represent.

is calculated. This control provides a continuous evaluation of work order estimates to be sure that each work order estimate is consistent with overall targeted budget.

Data from the Closed Work Report in terms of total accumulated tonnage produced and total accumulated manhours expended is input, and the manhour per ton efficiency being experienced is computed.

Period actuals are then input to review the weekly production efficiency, as well as serve as a source document for subsequent forecasting analysis.

VII. LINEAR REGRESSION ANALYSIS (GRAPH 06PE)

The Process Lanes concept of hull construction has opened the door to apply linear regression forecasting methodology. Prior to Process Lanes technology, this type of analysis was neither feasible or possible (at the work center level).

The period actuals from the Hull Efficiency Report now serve as the statistical basis for forecasting computations. The weekly tonnage "actuals" are input as the independent or predictor variable (x), and the weekly manhour "actuals" become the basis for computing the dependent or response variable (y). The results of the analysis produce mean manhours per week, mean tonnage per week, standard deviation of both tonnage and manhours, intercept, slope, correlation coefficient, and the projected completion manhours.

It should be noted at this point that the total engineering and production effort is a finely meshed system which centers around, contributes to, and coordinates with the Process Lanes concept. From initial planning, drawing preparation, scheduling, work center loading, budgeting, order release, cost control, to cost analysis and projections, the systems all compliment and enhance Process. Lanes.

QUESTIONS/ANSWERS

①	②			Section	Percentage	Weight (tons)	Serial No. K 185
WORK ORDER				Title ④			
Superintendent ⑤			FROM	Originator ⑨			
Foreman ⑥				Date ⑩			
Work Center ⑦				Transfer No. ⑪			
Drawing No. ⑧		Alt. No.	Sheet No.	Total Est. Hours ⑫	To Be Started ⑬	To Be Completed	
⑭ YOU ARE INSTRUCTED TO PERFORM THE FOLLOWING WORK							

- ① JOB NUMBER (CONTRACT)
- ② COST CODE PER PRODUCTION PLAN
- ③ WORK ORDER NUMBER (UNIQUE IDENTIFICATION)
- ④ DESCRIPTIVE TITLE OF WORK
- ⑤ SUPERINTENDENT RESPONSIBLE
- ⑥ FOREMAN RESPONSIBLE
- ⑦ WHERE WORK IS TO BE PERFORMED
- ⑧ WORKING DRAWING REFERENCE
- ⑨ PRODUCTION ENGINEER
- ⑩ DATE THE ORDER IS WRITTEN
- ⑪ MATERIAL DOCUMENT REFERENCE
- ⑫ ESTIMATED HOURS BASED ON UNITS OF WORK
- ⑬ SCHEDULE
- ⑭ DETAILED LISTING OF WORK & BASIS FOR ESTIMATED MANHOURS

GRAPH NO. 01PE

21.0.42

AVONDALE

BY JOHN G. VESS, SGR. ITH

COMBINED WORK ORDERS

4-01-84

PAGE 261

SU PT	JOB C	GR NO.	SB NO.	IT NO.	VS	WDRK ORDER	U N	EST. HOURS	LST-DAY ACTIVE	HOURS ACTUAL	PREMIUM	TODAY TOTAL	DATE ISSUED	FST-DAY STARTED			
05	P	C30170	02	20	01	010	E6190000	16	3-20-4				3-14-4	3-28-4			
TOTAL ITEM								16									
TOTAL SUB GROUP								16									
05	P	C30170	02	20	01	010	E6240000	12					3-09-4				
TOTAL ITEM								12									
TOTAL SUB GROUP								12									
10	S	C30170	02	77	01	010	E5000000	32	1-13-4				1-10-4	1-11-4	C		
10	S	C30170	02	77	01	010	E5002000	12	1-13-4				1-10-4	1-11-4	C		
10	S	C30170	02	77	01	010	E5004000	14	1-13-4				1-16-4	1-19-4	C		
10	S	C30170	02	77	01	010	E5006000	20	1-13-4				2-06-4	2-08-4	C		
10	S	C30170	02	77	01	010	E5008000	25	1-13-4				2-13-4	2-17-4	C		
10	S	C30170	02	77	01	010	E5010000	84	1-13-4				2-17-4	2-20-4	C		
10	S	C30170	02	77	01	010	E5012000	112	1-13-4				2-27-4	2-29-4	C		
10	S	C30170	02	77	01	010	E5014000	8	1-13-4				3-14-4	3-20-4	C		
10	S	C30170	02	77	01	010	E5016000	20	1-13-4				2-29-4	3-14-4	C		
TOTAL ITEM								353									
TOTAL SUB GROUP								353									
10	S	C30170	02	81	01	010	E5412000	80	3-20-4				1-31-4	2-06-4	C		
10	S	C30170	02	81	01	010	E5414000	15	3-20-4				1-31-4	2-09-4	C		
10	S	C30170	02	81	01	010	E5416000	85	3-20-4				1-31-4	2-08-4	C		
10	S	C30170	02	81	01	010	E5418000	142	3-17-4				1-23-4	2-01-4	C		
10	S	C30170	02	81	01	010	E5420000	124	2-24-4				1-11-4	1-23-4	C		
10	S	C30170	02	81	01	010	E5422000	80	12-23-3				12-02-3	12-15-3	C		
10	S	C30170	02	81	01	010	E5424000	158	1-19-4				12-22-3	12-27-3	C		
10	S	C30170	02	81	01	010	E5426000	155	2-01-4				12-22-3	12-28-3	C		
10	S	C30170	02	81	01	010	E5428000	153	1-30-4				1-03-4	1-06-4	C		
10	S	C30170	02	81	01	010	E5430000	153	1-27-4				1-03-4	1-09-4	C		
10	S	C30170	02	81	01	010	E5432000	121	1-27-4				1-03-4	1-05-4	C		
10	S	C30170	02	81	01	010	E5434000	121	2-02-4				1-06-4	1-06-4	C		
10	S	C30170	02	81	01	010	E5436000	150	2-17-4				1-06-4	1-11-4	C		
10	S	C30170	02	81	01	010	E5438000	159	1-02-4				1-06-4	1-11-4	C		
10	S	C30170	02	81	01	010	E5440000	124	2-24-4				1-11-4	1-26-4	C		
10	S	C30170	02	81	01	010	E5442000	121	2-23-4				1-11-4	1-18-4	C		
10	S	C30170	02	81	01	010	E5444000	121	3-02-4				1-23-4	1-30-4	C		
10	S	C30170	02	81	01	010	E5446000	142	3-14-4				1-23-4	2-01-4	C		
10	S	C30170	02	81	01	010	E5448000	156	3-16-4				1-23-4	2-06-4	C		
TOTAL ITEM								1,272	2,454								
10	S	C30170	02	81	02	010	E6707000	147	3-10-4				1-23-4	2-01-4	C		
10	S	C30170	02	81	02	010	E6720000	147	3-30-4				1-23-4	2-02-4	C		
10	S	C30170	02	81	02	010	E6722000	92	3-30-4				1-23-4	2-08-4	C		
10	S	C30170	02	81	02	010	E6724000	92	3-16-4				1-23-4	2-08-4	C		

GRAPH NO. 02PE

SUPT	PE	JOB	Gr	SG	ITH	VES	WORK ORDER	H/H ALLOWED	H/H SPENT	DATE ISSUED	SCHED START	ACT START	SCHED FINISH	LATE
11	X	C20400	19	00	05	014	H1016	16	8.0	3-12-4	3-14-4	3-14-4	3-31-4	***
07	X	C20400	50	27	01	014	E7104	210	108.2	2-27-4	3-01-4	3-01-4	3-31-4	***
29	X	C20400	50	27	05	014	E7105	84	72.1	2-27-4	3-01-4	3-02-4	3-31-4	***
10	X	C20400	19	00	05	014	H1033	70	56.0	3-14-4	3-19-4	3-15-4	4-30-4	
09	X	C20400	19	00	03	014	H1009	500	472.2	3-09-4	3-12-4	3-14-4	4-30-4	
87	X	C20400	50	27	01	014	H2701	200		3-26-4	4-01-4		4-30-4	
29	X	C20400	50	27	05	014	H2702	80		3-26-4	4-01-4		4-30-4	
09	X	C20400	19	00	03	014	H2703	500	146.0	3-26-4	3-28-4	3-28-4	4-30-4	
18	X	C20400	19	00	05	014	E8188	400	385.0	2-10-4	3-01-4	2-24-4	6-20-4	
18	X	C20400	19	00	05	014	E8190	100	91.5	2-10-4	4-01-4	3-13-4	6-30-4	
11	X	C20400	19	00	05	014	E8187	256		2-10-4	4-01-4		6-30-4	
P.E. TOTAL:								2,416	1,339.0		WORK ORDERS	11		

GRAPH NO. 03PE

M.H.

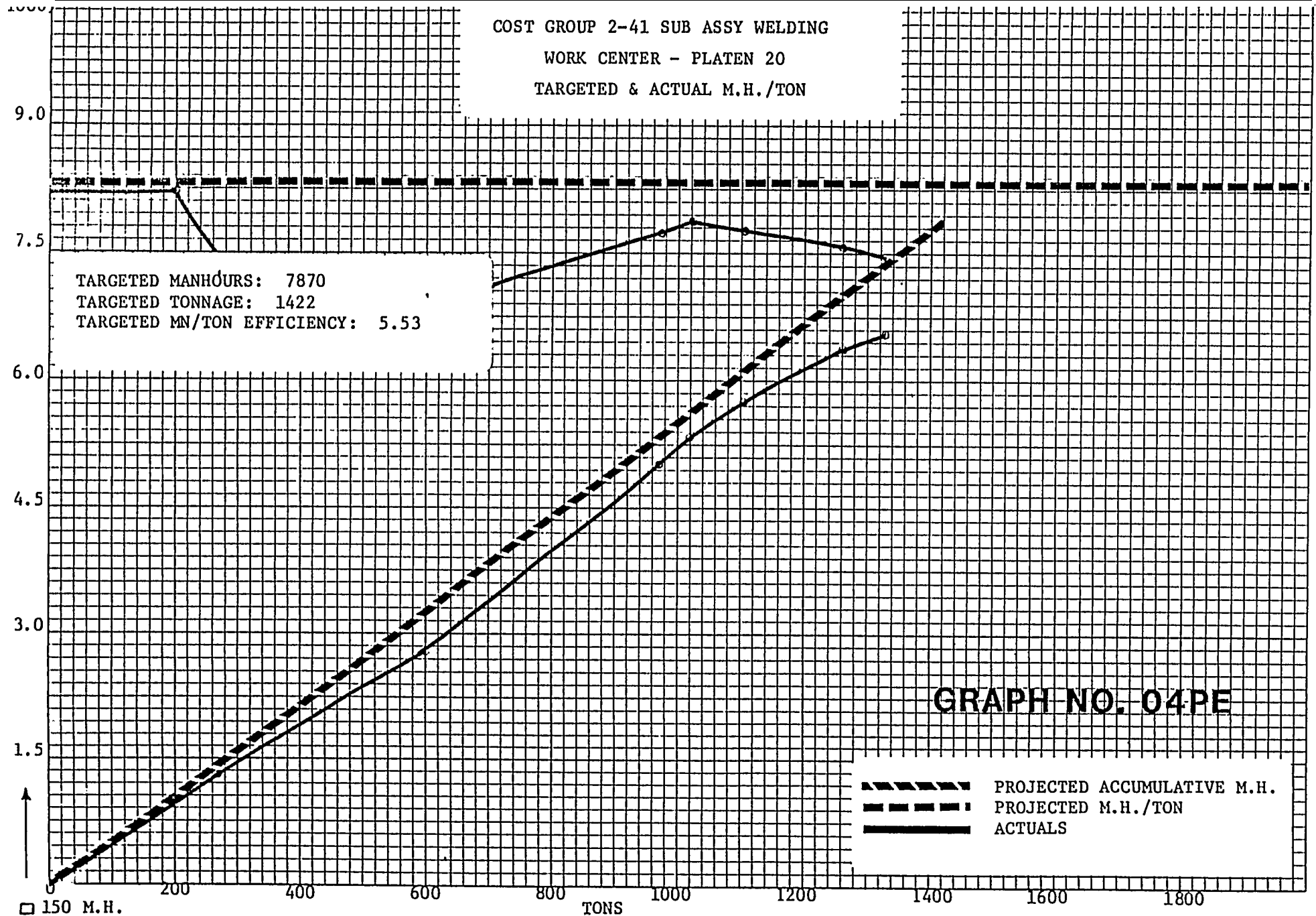

□ 150 M.H.
□ 20 TONS

COST GROUP 2-41

PLATEN 20 SUB ASSY WELDING

PROJECTED MANHOURS: 7906
TARGET TONNAGE: 1422

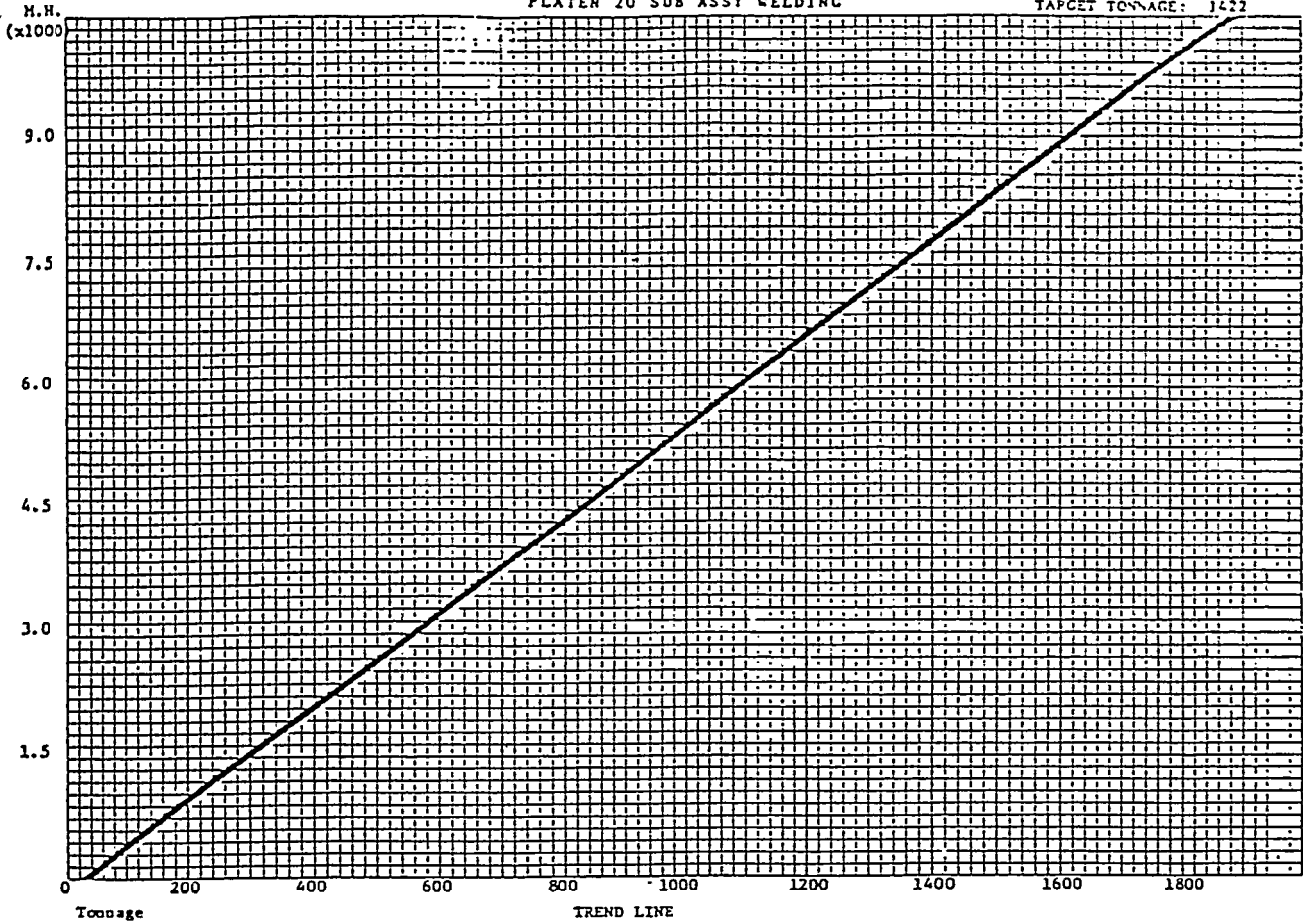

LINEAR REGRESSION ANALYSIS

y = MANHOURS

x = TONNAGE

MEAN (y) = 785 mh/week

MEAN (x) = 162.8 tons/week

POPULATION STANDARD DEVIATION - Qn (y) = 720.6 mh/week

POPULATION STANDARD DEVIATION - Qn (x) = 124.6 tons/week

INTERCEPT (b) = -129.6 mh

SLOPE(a) = 5.6509018 (79°57')

TOTAL TARGET TONNAGE: 1422 tons

PROJECTED TOTAL COMPLETION MANHOURS: 7906

NUMBER OF SETS OF DATA POINTS: 7 weeks

CORRELATION COEFFICIENT OF INPUT DATA = 0.9774

(A VALUE NEAR 1 DENOTES DATA CLOSELY RELATED)

DEGREE OF CERTAINTY OF PROJECTED MANHOURLY COMPLETION

(BASED ON 0.9774) = 99.9%

TREND LINE EQUATION (SLOPE/INTERCEPT FORM):

$y = a x + b$ WHERE y = projected completion manhours

a = slope

b = intercept

x = any value of tonnage

GRAPH NO. 06PE

PROCESS LANES AND DESIGN ENGINEERING
FOR ZONE OUTFITTING
AVONDALE SHIPYARDS, INC.

PRODUCTION PLANNING AND CONTROL

Prepared by: D. BERGERON

PROCESS LANES AND DESIGN ENGINEERING
FOR ZONE OUTFITTING
PRODUCTION PLANNING AND CONTROL

I. INTRODUCTION

The history of Japanese technology transfer to the American shipbuilding environment has been discussed in much depth over several previous seminars and has been adequately covered in numerous publications and, therefore, will not be discussed in any further detail in this seminar,

Avondale Shipyards has been in the implementation stages of the Japanese type transfer of technology since 1980. This was a follow-up from a preliminary evaluation and the subsequent recommendations made by IHI during 1979. These methods have been applied in increased scope over several construction programs and have proven most successful on the current Exxon contract. SEE GRAPH PL-35 for those areas of technology transfer which have realized the greatest attention. The Exxon contract realized approximately 90% of the total technology transfer application. The complete system is being implemented on the TAO 187 Class ships and the LSD-41 Class ships (SEE GRAPH PL-36). The new technology has evolved and has been accepted as the Avondale method of doing business. No major modifications are anticipated to the current system, other than continued refinement resulting from our experience base,

Naturally, our prime objective for implementation of the technology is the benefits derived by narrowing the tremendous cost differential between domestic shipyards and foreign shipyards.

II. GENERAL APPROACH TO PRODUCTION PLANNING AND CONTROL

Prior to commencing the new technology application at Avondale, the planning and scheduling of both the hull and outfitting functions were accomplished in a very low profile and conventional manner. The production crafts actually accomplished a significant amount of the planning and scheduling in the field, particularly when changes were required. This was prompted by the fact that the basic planning function did not provide sufficient detail during development of the initial plan. The "Product Work Breakdown Structure" was not utilized to the extent which would provide detail visibility and controls. In addition, the initial planning and scheduling effort was normally undertaken after award and continued up to launch. SEE GRAPH PL-37 for comparison of conventional planning effort versus present approach.

The conventional planning and scheduling was accepted simply because it presented what was available. It was through increased awareness of the need to improve the methods, controls and predictability of construction that a serious analysis began.

The initial analysis for improved hull technology focused on production real estate. A determination had to be made to assure that the existing space would be adequate to construct the various categories and sub categories of units. The basis of the evaluation was the Exxon Product Carriers and similar square footage requirements from the Kure Shipyard in Japan.

Based on the real estate studies, it was determined that adequate space was available to support the envisioned technology and principles without any significant expenditures for real estates. GRAPH PL-38 represents the resulting platen or work center sites.

The next step began with a review of the total requirements necessary for a meaningful and realistic approach to the entire planning and scheduling process. This review resulted in development of our basic approach to hull planning and scheduling with a document called "Job Description At Each Stage Schedule" (SEE GRAPHS PL-39 THROUGH 43). While the stage schedule was discussed in several of the preceding sections, it is mentioned again to highlight the evolution of the planning effort. This schedule is significant because it provides the integration of both division responsibility and functions. It provides specific relationship and dependencies between the hull, outfitting, and facility requirements. Probably just as important, it highlights all requirements beginning upfront during the marketing stage through final delivery of the end product. The stage schedule also provides top milestone meetings which are essential for visibility and control.

The total requirement approach was a major step in identifying the many aspects of upfront planning and scheduling requirements in a logical sequenced flow. GRAPH PL-44 provides a summation of the basic upfront hull planning and scheduling requirements.

The new technology has significantly improved Engineering and Production communications and the subsequent deliverables (drawings, material, etc.). Upfront development of the plan is a must to assure that Engineering is fully apprised of the construction methods before award for inclusion in the preliminary engineering development.

The new hull technology in planning and scheduling has been influenced significantly by the zone outfitting application. This has forced detail attention to pre-outfitting during the process lanes flow and the integrated effort of hull and outfitting planning. In addition, package units have resulted in even greater schedule consideration not only to level loading

for the fitting and welding tonnage, but to also provide specific windows for installation of the constantly increasing number of larger and more complex package units.

The dates for unit erection are determined by the Hull Erection Schedule (CLAW) as shown by GRAPH PL-45.

Fitting manhours and welding lengths are obtained by control charts . With this data, the sub-schedules are developed which tell us the pre-determined amount of time needed to perform the fitting, welding and other sub stages for each unit, each tank, and each zone. The detail tonnage, weights and footages are a derivative of the hull planning process evolving from the process lanes requirements.

The execution of the erection sub-stage work, tank by tank and zone by zone, should be completed with no work remaining. Unfinished work negatively influences the total shipbuilding process. It slows down the progress of productivity and of pre-outfitting.

On the Exxon contract, most of the cargo and ballast tanks testing was completed prior to launch. On the lead ship approximately 77 of the 92 tanks were tested prior to launch. Much attention is given to the completion of work prior to launch because the cost of unfinished work can double after the ship goes overboard. This effort requires much dialogue between Hull and Outfitting Planning, as well as coordination with Engineering.

The progress and productivity of each tank and each zone completion is closely monitored by Production Planning, Shop Planners and Production Supervisors. The monitoring process is accomplished via detailed schedules for all crafts with heavy emphasis on painting, The monitoring is done via footages, weights, lengths and numbers (bean counting).

Accuracy control applications have made a significant impact on improved products coming from the process lanes main assembly to erection. This has been instrumental in units going to erection with stock trimmed neat and with excellent fit up. While accuracy control will be discussed further in a session later this morning, the importance of this discipline cannot be overemphasized .

Line heating application with assistance and training from IHI has assisted tremendously in our planning and scheduling effort by eliminating furnacing and many fixed jigs. This has not only resulted in significant savings but has aided the schedule flow .

III. DETAIL APPROACH TO PRODUCTION PLANNING AND CONTROL

The detail development of the integrated hull and zone outfitting planning and scheduling is achieved in harmony with the "Job Description At Each Stage Schedule" as preciously indicated on GRAPHS PL-39 THROUGH 44. The stage schedule provides all the major milestones and documentation requirements necessary to accomplish the planning flow in accordance with the company master plan. To assure that the planning and scheduling flow is achieved in a timely and effective manner, the Planning Department prepares and issues a Schedule of Schedules . This schedule incorporates the planning requirements flow as depicted by GRAPH PL-45.

Based on the contract documents available during the bid period, the following basic planning processes are accomplished:

- Review of ship specifications and drawings for both hull and outfitting requirements.

- Develop preliminary breakdown of the hull into units with consideration for facility weight requirements, accuracy, zone outfitting concepts and the erection sequence. Consideration of the process lanes concepts and requirements for tooling and jigs must be considered.

- Prepare preliminary weight calculations and verify against unit breakdown arrangement. This is important for verification of the unit breaks and is critical to both platen construction and erection.

- Proceed with development of a preliminary erection schedule assuring compatibility with key dates. Verify preliminary outfitting requirements for erection (package units, shafting, tank testing, boring, etc.).

- Develop initial unit categorization of units for further process lanes breakdown.

- Prepare preliminary "Job Description At Each Stage Schedule" based on key dates and preliminary planning, This schedule is refined during the bid period and immediately preceding award for issue.

During the bid stage the proposed contract is stage loaded to the entire facility flow via tonnage to assure available space against present work. Many of these aspects of the planning and scheduling functions are further developed during the bid stages:

- preliminary drawing schedule requirements;

- major equipment requirements (main engines, reduction gears, pumps, etc.) for long lead purposes;

- establish major milestones.

Immediately after award, the preliminary planning and scheduling development is reviewed and the refinement process is undertaken. At this time, the unit breakdown is constantly reviewed between Engineering and Planning during the key plan stage in the period immediately following award. Finalization of the key plans and the ship's lines are most essential to the finalizing of the unit breakdown. Once the unit breakdown is finalized and the unit categorization has been made, the detail arrangement of the "recap sheets" is undertaken.

As discussed in the presentation yesterday, the recap sheets, by unit, provide the transition from the basic planning stage to the process lanes detail scheduling process. Development of the long term schedules, as discussed in detail in a previous section, provides the capacity loading for all work centers. This development results in approximately 35-40 detail schedules which are utilized by the shop planner for further detail manpower and efficiency evaluation. More important, these schedules form the basis for visibility and control of the entire process lanes flow to support erection. GRAPH PL-46 identifies the major schedules required. As previously indicated, the long term schedule alone is comprised of 35-40 separate sub-schedules,

Essentially, the schedules which have been discussed during the last two days and the planning flow provide the planning controls which have evolved within implementation of the process lanes concept.

QUESTIONS/ANSWERS

PROCESS LANES AND DESIGN ENGINEERING
FOR ZONE OUTFITTING
AVONDALE SHIPYARDS, INC.

ZONE OUTFITTING CONCEPTS

Prepared by: G. GRIMSLEY

PROCESS LANES AND DESIGN ENGINEERING
FOR ZONE OUTFITTING
ZONE OUTFITTING CONCEPTS

I. INTRODUCTION

Zone outfitting implementation at Avondale has evolved in parallel to the development of hull construction and planning techniques. Other presentations over the past two days have highlighted much detail of the hull transfer of technology and the general relationship to zone outfitting. I would like to present to you, today, the basic zone outfitting philosophy and methods employed on our current contracts. While we provide a distinct line, in many cases, between hull and outfitting in our presentation, we, internally at Avondale, are treating outfitting as an integral part of the hull construction process. The old philosophy of hull construction domination has eroded with acceptance of the new technology.

II. ZONE OUTFITTING

The emphasis on zone outfitting at Avondale has probably not received the publicity that has been bestowed on the "process lanes" implementation. This has been prompted by the fact that zone outfitting has been implemented, as indicated earlier, on a concurrent basis, as part of the hull construction process. In fact, zone outfitting is a major determinant of the initial hull breakdown, as well as the detail breakdown of the unit into the assembly process.

NOTE: During the process lanes "development stages" and while hull is planning where and how the hull units are to be built, the Hull and the Outfitting Sections of Planning and Engineering maintain extremely close communications. Sessions are held routinely, during which the "where and how" is explained and at which time the outfitting input is provided. This input consists of the durations required for outfitting at each stage of unit construction, which is then built into the process lanes long term schedules. Requests are made also by Outfitting Planning for the turning of units for outfitting processes at the various process lanes work centers. Thus, the two processes of hull and outfitting are integrated very early on in the contract and the lines between them start losing their historical identity.

The conventional method of outfitting utilized at Avondale was provided on drawings that were concerned with total systems and system functions. The outfitting material, for the most part, was installed after the hull units were erected and after completion of the major hull work. Outfitting in this manner was an extremely costly method due to the scaffolding requirements for access and the fact that it resulted in unsafe and crowded working conditions for the workmen. This was due to the number of workers required by the schedule to be in the same place at the same time. More importantly, the work was scheduled for the wrong time frame in relation to the eventual delivery of the ship.

Zone outfitting, as presently employed at Avondale, is a radical departure from the conventional method. It is now a combination of new technology and methodology which we have adopted and adapted to suit our specific needs and capabilities and which we are continuing to improve and refine.

The zone outfitting method is a direct offspring of the unit or block method of hull construction, preciously described, in which the hull is broken up into specific blocks or units relative to our facility capabilities in support of convenient construction and erection. Naturally, the hull and outfitting is accomplished remote from the building ways and transported to the building site just prior to their erection.

In principle, there are three distinct aspects of zone outfitting which have been implemented at Auondale and are illustrated by GRAPH PL-47:

- package unit pre-outfitting;
- on unit outfitting;
- on board outfitting.

A) PACKAGE UNIT OUTFITTING

The design and construction of package units follow the same principle of "off ship" outfitting or does on unit outfitting. The planning and design of package units are directed to the fabrication and assembly of components into packages; whereby, stability is maintained and limited temporary support is required. There are two (2) distinct types of package units constructed at Avondale (see GRAPH PL-48 for increased use of package units).

1) Machinery Package Units

These are packages which are components of multi-systems. They are designed for fabrication and assembly complete with supporting structure (machinery, Foundations, pumps, motors, coolers, piping, valves, grating, ladders, etc.). Figures 7 and 8 provide good examples of a machinery package.

2) Zone Package Units (Pipe Package)

Usually represents an assembly of pipe details, valves, ladders, grating, etc. A package of this type could also be ventilation, etc. Figure 8 provides an example of this type of package.

B) ON UNIT OUTFITTING

The outfitting is broken down by unit commensurate with the hull . Prior to erection, we are not concerned with the outfitting of total systems, but rather with portions of systems that can be installed on unit and become part of the system again after erection. Most of the outfitting can be installed at locations remote from the erection site. This is readily accomplished in smaller and less complicated increments in a much safer working environment. The outfitting drawings, at this stage, being unit oriented, ignore systems and concentrate on maximizing the degree of interim material that can be installed in a smaller and less complicated part of the ship. On unit outfitting involves several types of crafts; however, they have become oriented to the concept and are increasingly working as a team. Their approach is just short of embracing the assembler concept, The outfitting is accomplished at the various stages of process lanes assembly with specific durations provided up to blast and coat of the unit and thereafter. The outfitting stages are pre-determined and are not left to chance, The prime objective is to accomplish the outfitting while the unit is turned in the best position to complete the work without scaffolding. See Figures A and 10 for examples of on unit outfitting.

C) ON BOARD OUTFITTING

This is not the old traditional approach to outfitting. This stage of zone outfitting is limited to material or packages that cannot be installed on unit for specific reasons and are installed on board, after erection. A specific item may be too large or too heavy to install on unit prior to erection and some items may be too fragile to be subject to the weather or damage. On board outfitting is

planned and scheduled zone by zone and sub-zone by sub-zone, On board outfitting is scheduled and sequenced to assure that the number of workmen in a given area, at a given time, is efficiently controlled. GRAPH PL-48a depicts the zone arrangement which drives the on board sequence. See Figure 11 for an example of on board outfitting.

II. ZONE OUTFITTING EVOLUTION

Zone outfitting was initiated at Avondale on the Suwanee Tug and Barge contract in October, 1979 and the Ogden Marine product carrier in January, 1980, followed by the Navy A.O., Job C8-400, in June of 1980. This was started with Production Planning "breaking down" the system type drawings produced by Engineering and assigning the material to specific destinations, either on unit or on board, without Engineering's assistance. Although this approach was only moderately successful, this initial effort taught many valuable lessons that were invaluable for Planning and Engineering on later contracts when the IHI technology transfer was introduced in a more finite manner.

Some indication of the value of the initial applications of zone outfitting techniques on the A.O. contract are illustrated in the following comparison:

<u>HULL</u>	<u>JOB</u>	<u>TECHNIQUE</u>	<u>APPLICATION</u>	<u>PERIOD</u>
2305	C8-750	No Zone Outfit	Launch to Lite Off	10 Months
2314	C8-400	Limited Zone Outfit	Launch to Lite Off	5 Months
2305	C8-750	No Zone Outfit	Launch to Lite Off	18 Months
2314	C8-400	Limited Zone Outfit	Launch to Lite Off	12 Months

Following introduction of the IHI technology in 1980, Engineering became very involved, and the pallet numbering system, developed by Planning, was included on their drawings. Essentially, Engineering had begun to evolve design to suit the zone outfitting philosophy. The first contract that was engineered in this manner was the Zapata split hull dredge, with the three (3) APL containerships to follow. During the early stages of zone outfitting application, some sections of Engineering were not fully involved. On the Exxon contract all sections of Engineering were fully involved and indoctrinated into the system. Engineering has now proven its dedication to the zone outfitting philosophy in support of Production. Avondale is continuing to further refine the outfitting techniques at the detail level. GRAPH PL-49 depicts the evolution of pre-outfitted units through the successive contracts.

additionally, the on board outfitting has improved significantly in that it has been reduced to a point, where only those items that cannot be installed on unit, for various practical reasons, remain. This remaining material is scheduled to load and install in harmony with the hull erection schedule which has drastically reduced the number of shipping cuts preciously required to a minimum. Every effort is now being made to complete the ship to the greatest point possible, prior to launch, The Exxon ships were launched at approximately 80% complete,

On the first Exxon, a total of 77 tanks, of a total of 92, were hydro tested prior to launch. All engine room associated tanks (26) were finished and fuel was loaded two (2) weeks after launch. Further, electrical cable pulling was essentially complete on the ship and the main switchboard was lit off with the shore power one week prior to launch. Piping installation was 95% complete, and testing was approximately 50% complete at launch, (311 major equipment, including deck machinery, was installed with only some small items remaining for which no special access was required. This results from outfitting percentage completion goals laid down by Production Planning in the Pallet Schedule and the Outfitting Milestone Schedule, and vigorous pursuit of these goals by Production and Engineering.

III. THE ZONE OUTFITTING PALLET SYSTEM

The key instruments for accomplishing zone outfitting in the manner described are the pallets, under which number the packages of material are grouped and which we will now discuss in some detail.

A pallet, as used in this context, is a predetermined work package of outfitting material which has been designed by Engineering to be installed in the hull of a ship in a specific place and at a specific advantageous time during construction on the ship (on units, on board, on package, etc.). All outfitting material in this system is pallet coded from docking plugs to fire hose.

Each pallet is identified by its own significant and unique number and installation code (see GRAPH PL-50 for pallet coding system) . The pallet numbering system utilized at Avondale was developed by Production Planning to satisfy conditions at Avondale and are unique to this plant as follows:

<u>CRAFT/UNIT NO./SERIAL NO.</u>	<u>INSTALLATION STAGE</u>
06-001-01	s = During Sub Assembly
07-001-01	u = During Main Assembly
08-001-01	T = After Turning
09-001-01	B = After Painting
06-001-01	J = After Joining

On Board Examples:

06-M11-01	z = Prior Closing
06-M11-01	Y = Easy Access
06-M11-01	z = Final Items

Engineering assigns the pallet numbers, based on criteria supplied by the Production Planning Department. These numbers are supplied to Engineering prior to starting the drawings. This is developed from study of the contract plans, diagrams, etc. by Production Planning well in advance. Additionally, during drawing development, Production Planning works extremely close with Engineering to insure their proper understanding and use.

The pallets are controlled by the Pallet Schedule that sets forth dates which dictate the time of all functions that affect each pallet from drawing issued through fabrication, painting, pallet assembly and, finally, installation. The Pallet Schedule is supportive of the guidelines provided from the "Job Description At Each Stage Schedule" discussed in several other presentations and must be in harmony with the long term process lane schedule. See GRAPH PL-51 for example of a Pallet Schedule (partial).

IV. SUMMARY

It can easily be observed that the zone outfitting method is a highly organized and logistically supported operation. We have realized continued growth of the concept since its conception at Avondale. Package units have evolved in many respects beyond our original expectations with larger and more complex packages. In fact, all facets of zone outfitting including packages, on unit and on board, have been very successful both to cost and control. This translates to advantages for both Avondale and the customer. Some of the more obvious advantages are provided as follows:

less complicated systems for Production;
improved safety condtions;
improved quality;
more efficient controls;
support to meeting schedules, more outfitting complete at launch.

QUESTIONS/ANSWERS

AVONDALE SHIPYARDS, INC.
NEW TECHNOLOGY IN SHIPBUILDING

THE THREE ASPECTS OF ZONE OUTFITTING

1 - PACKAGE UNIT
PRE-OUTFITTING

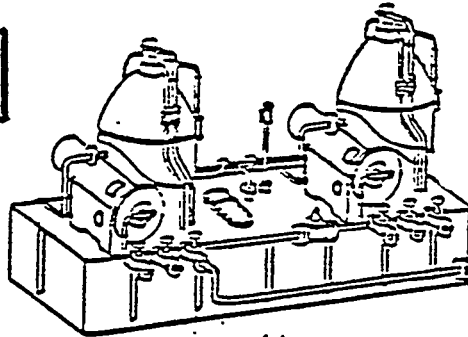

2 - ON-UNIT
OUTFITTING

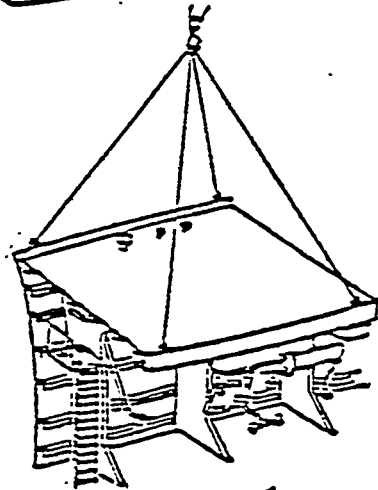

3 - ON-BOARD
OUTFITTING

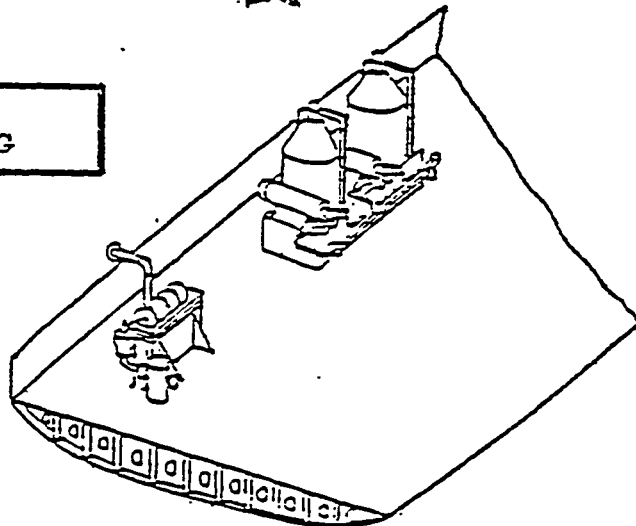

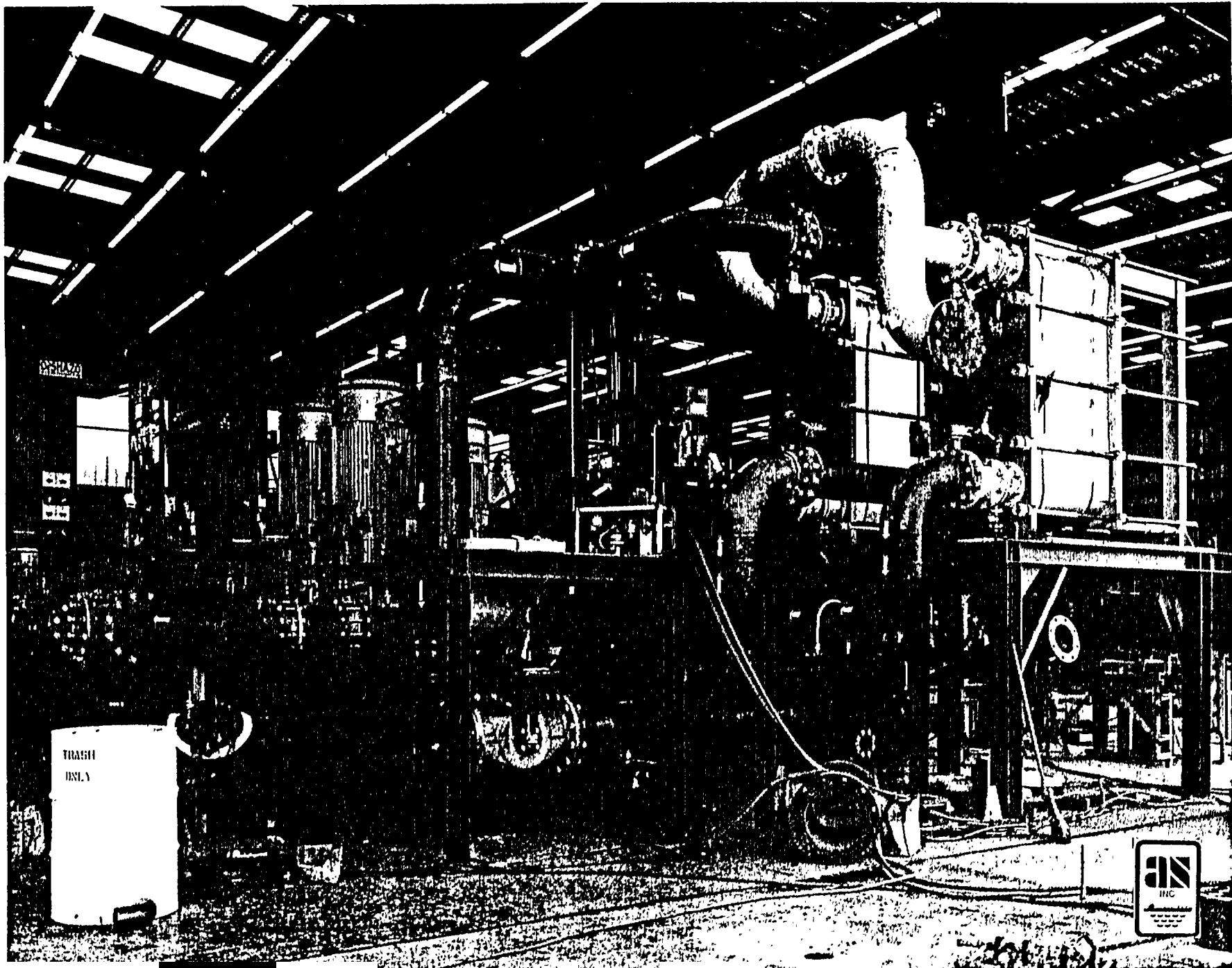
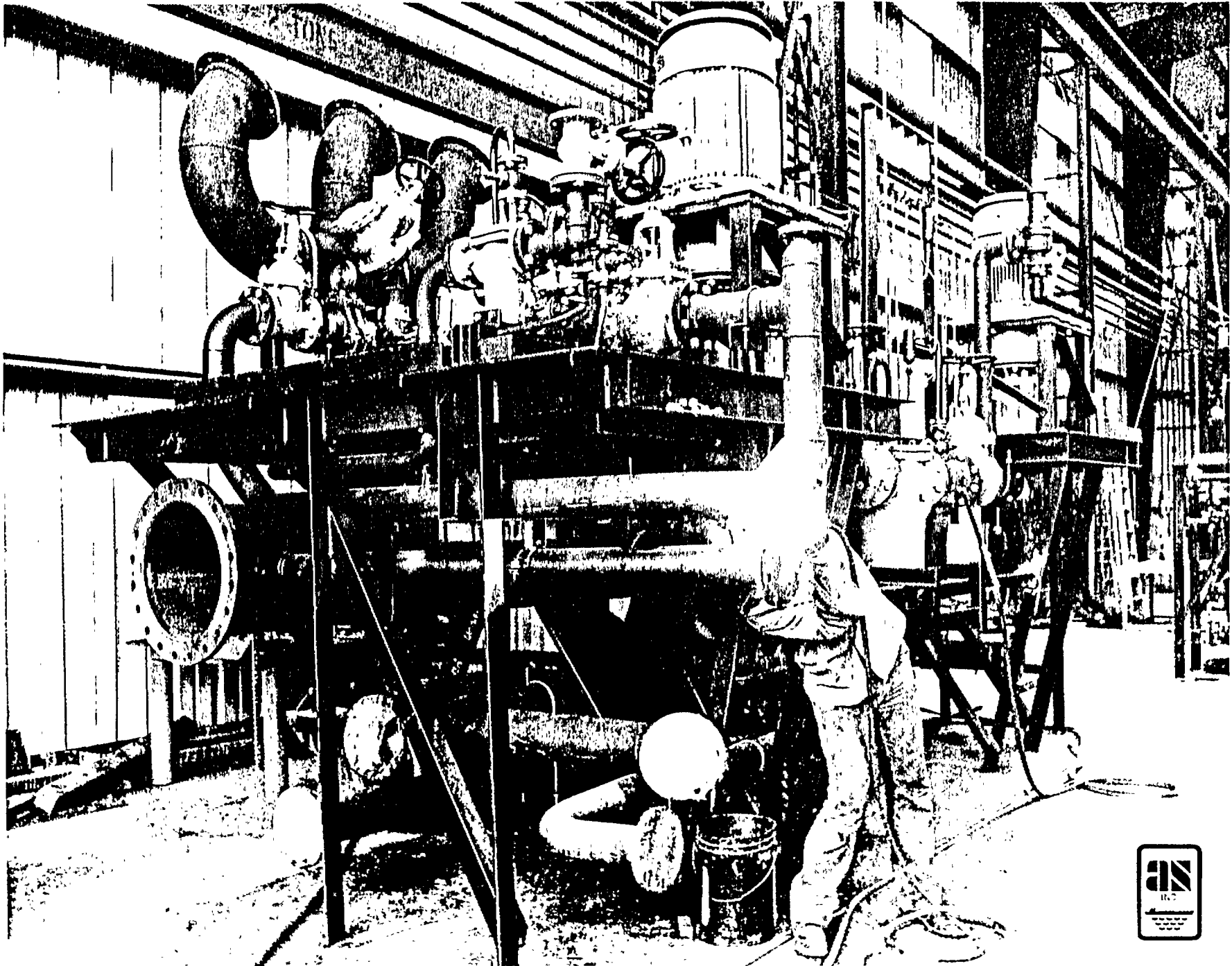

FIGURE 7



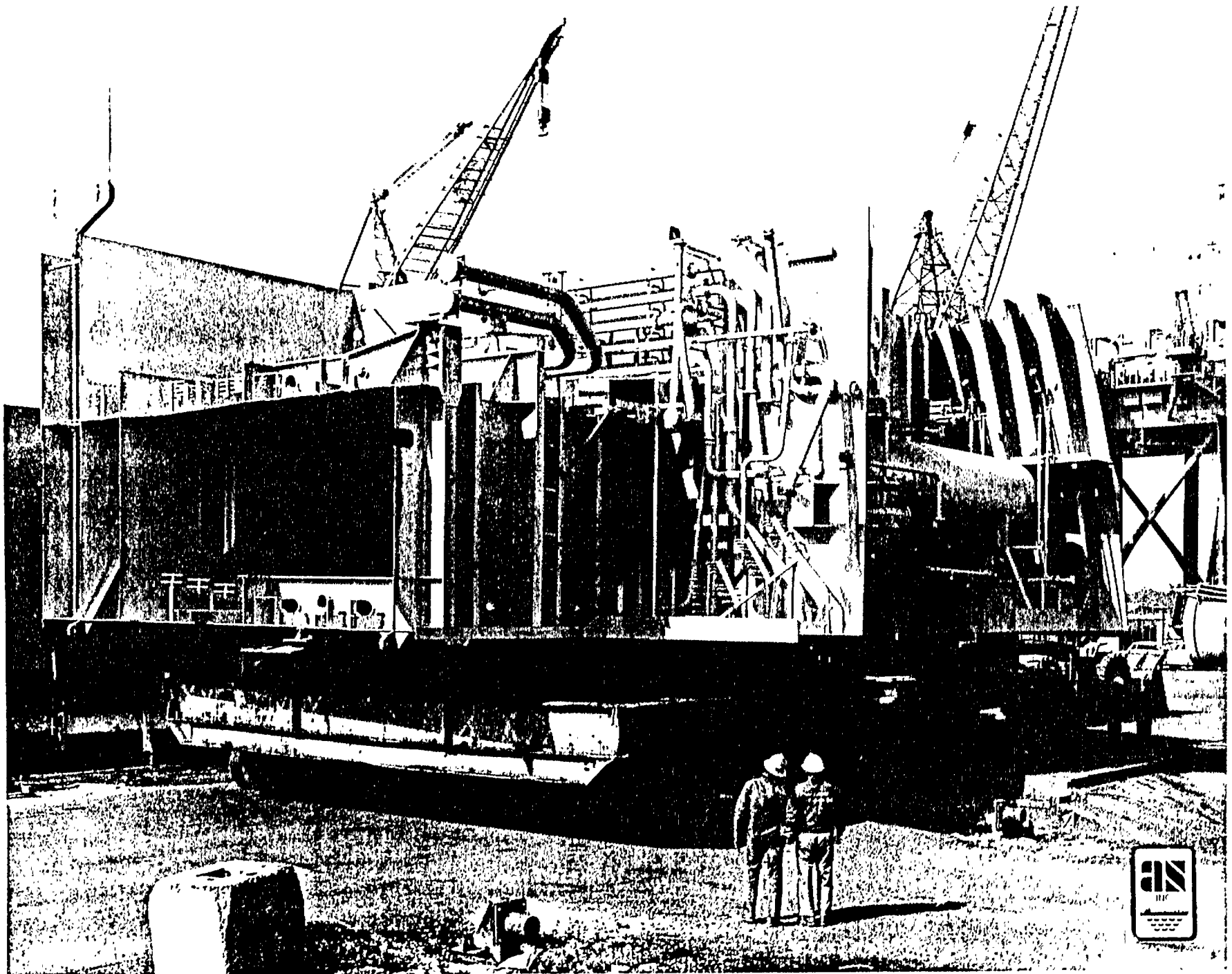
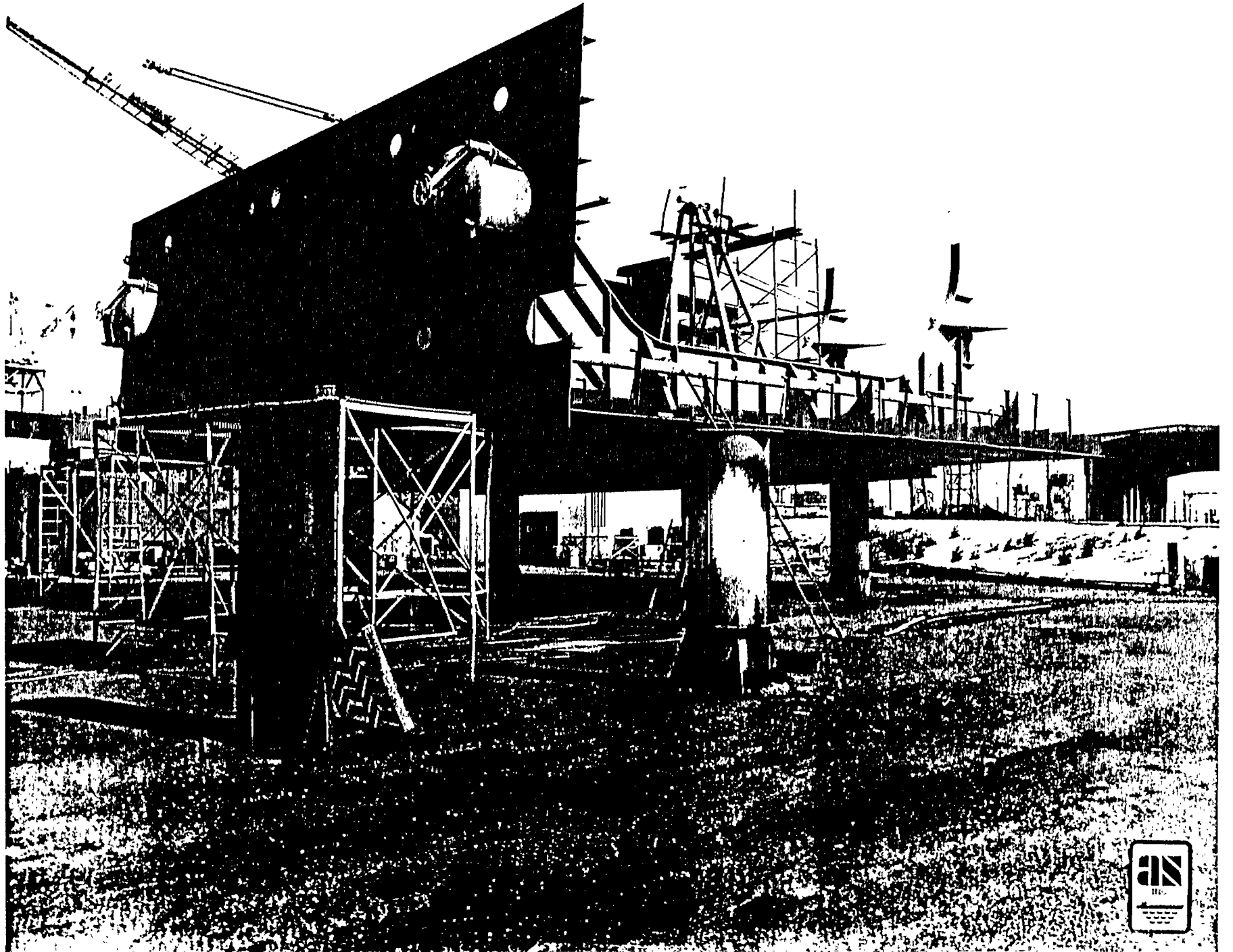

FIGURE 9



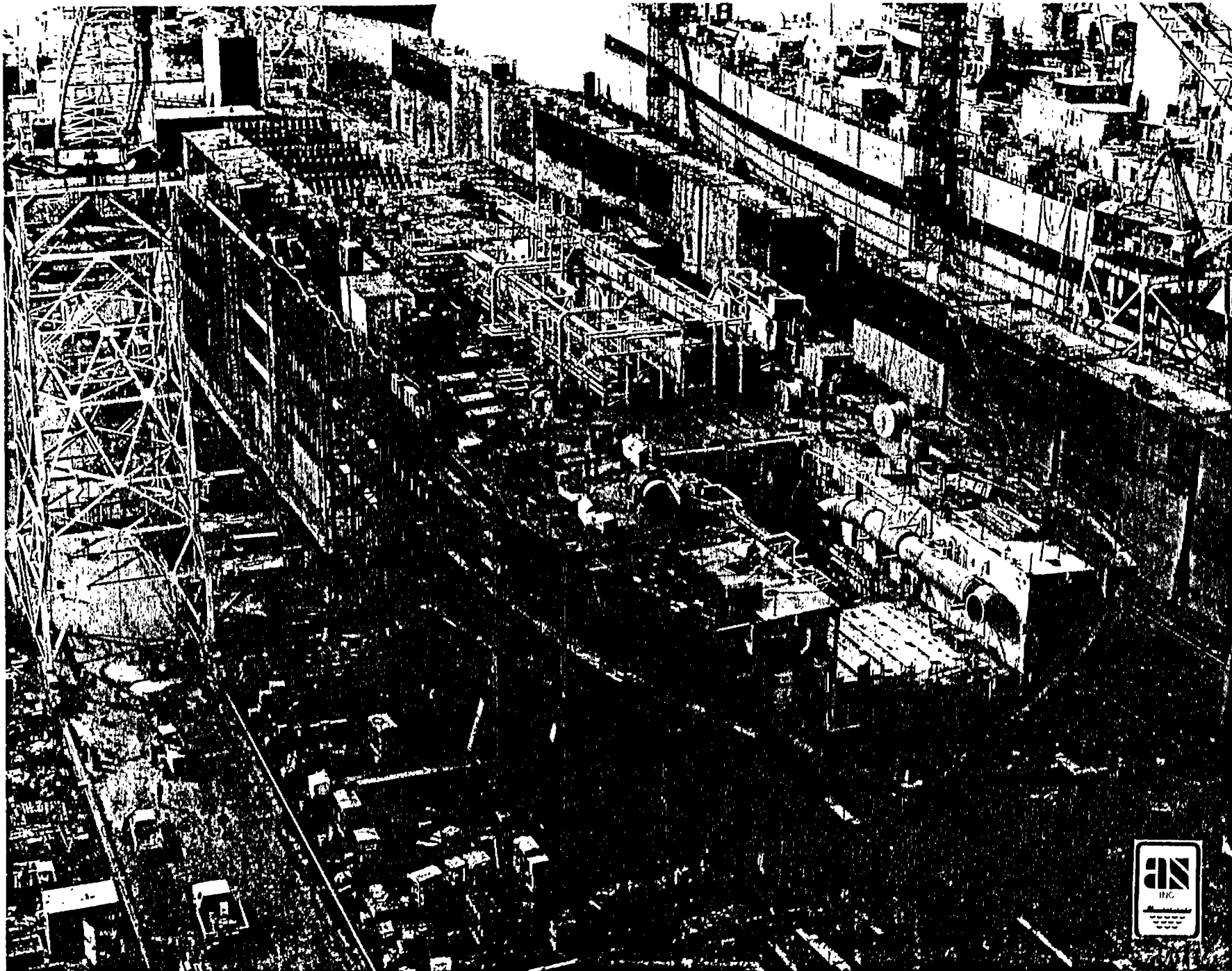
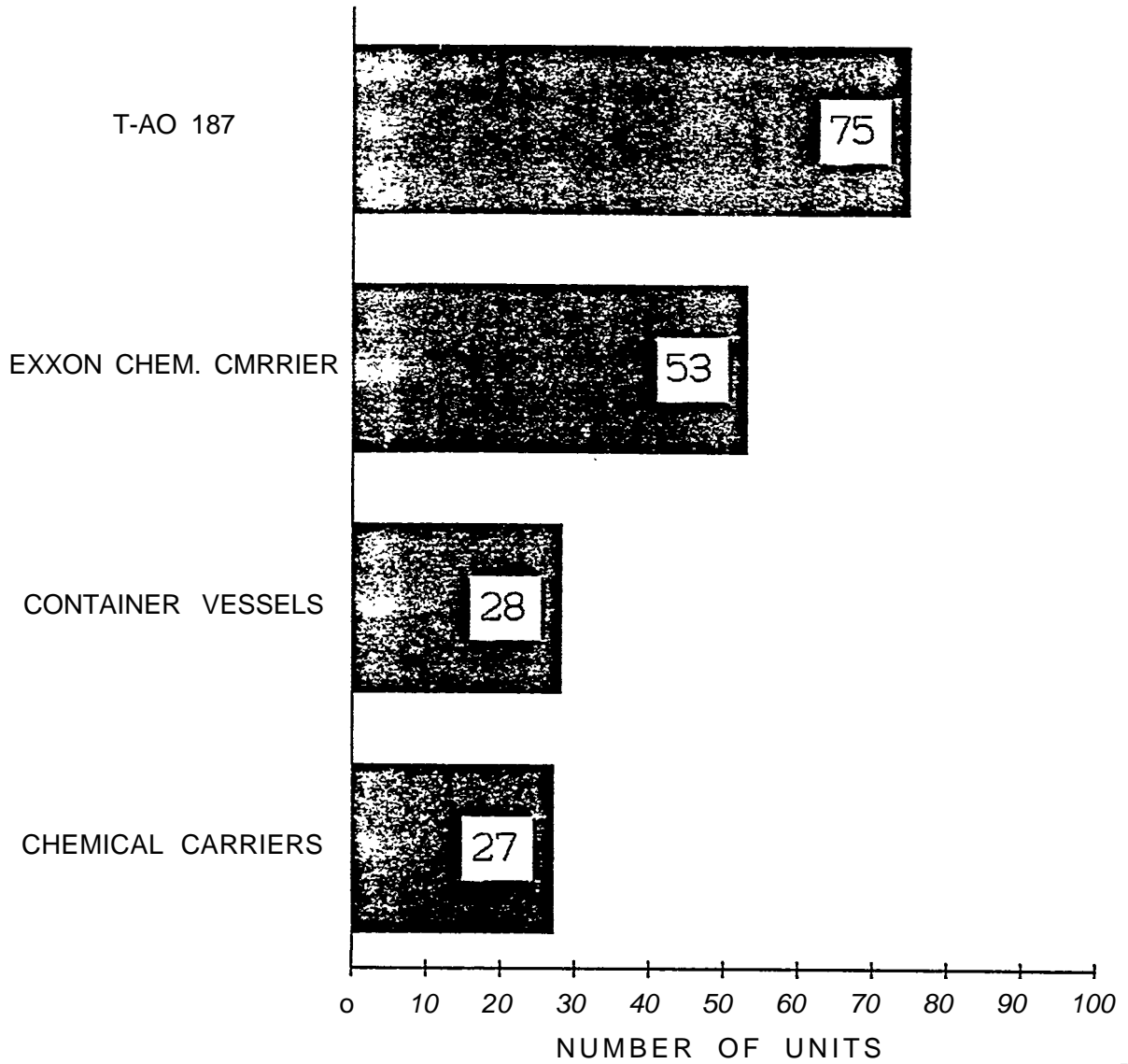

FIGURE 1

A V O N D A L E S H I P Y A R D S , I N C
N E W T E C H N O L O G Y I N S H I P B U I L D I N G

I N C R E A S E D U S E O F P A C K A G E U N I T S



LEGEND

ZONE ARRANGEMENT

ZONE "M" - MACHINERY SPACE

ZONE "A" - ACCOMODATIONS

ZONE "D" - DECK & HOLDS

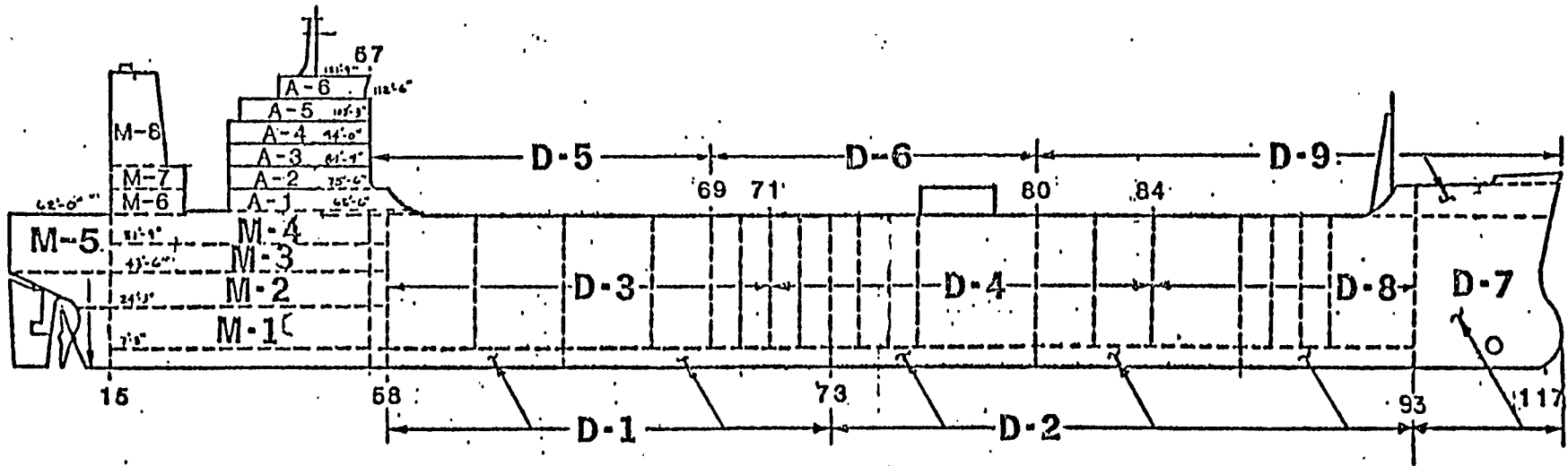

LENGTH O.A. 635'-6"

BREADTH MLD. 106'-10"

DEPTH MLD. 60' 0"

**C1-0015
EXXON PRODUCT CARRIER**

PRODUCTION PLANNING

GRAPH NO. PL-48a

AVONDALE SHIPYARDS, INC NEW TECHNOLOGY IN SHIPBUILDING

INCREASE IN PRE-OUTFITTED UNITS

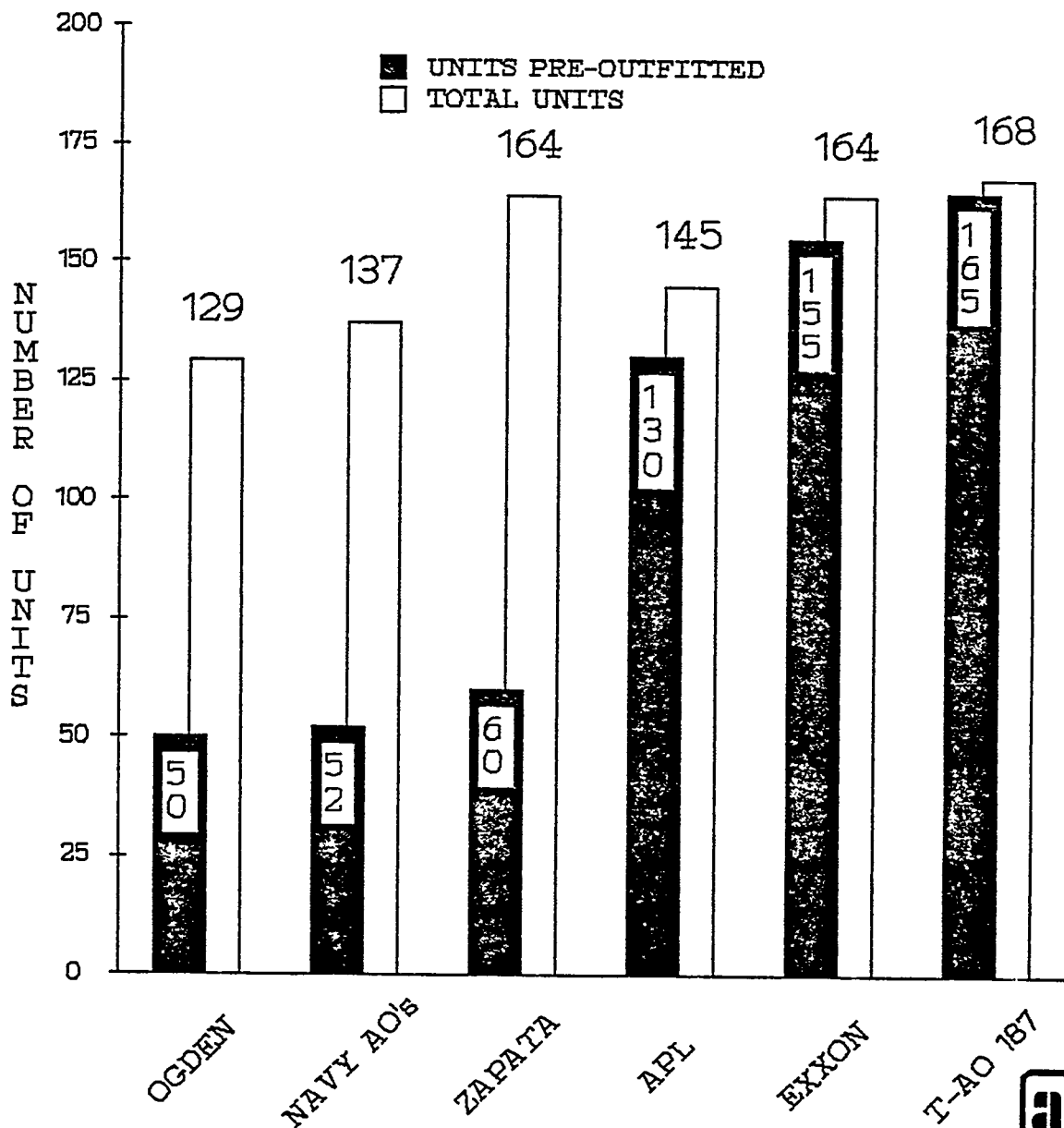

PALLET CODING SYSTEMS

THIS DRAWING CONTAINS MATERIAL WITH THE FOLLOWING PALLET CODES		
PALLET CODE	DESCRIPTION	X
S	DURING SUB ASSEMBLY ON UNIT	
U	BEFORE TURNING DURING MAIN ASSY ON UNIT	
T	AFTER TURNING - PRIOR TO PAINT ON UNIT	
B	AFTER PAINT - PRIOR TO ERECTION ON UNIT	
G	GRAND ASSEMBLY ON UNIT	
J	AFTER JOINING W/OTHER UNITS - PRIOR TO ERECTION ON BLOCK	
X	BEFORE CLOSING IN ON BOARD	
Y	EASY ACCESS OR ON OPEN DECK ON BOARD	
Z	FINAL OUTFITTING, PILFERABLES, SPARE PARTS, LOOSE ITEMS, ETC. ON BOARD	
1A	MATERIAL TO BE ROUTED TO PIPE ASSEMBLY AREA .	
1R	MATERIAL TO BE ROUTED TO RACK ASSEMBLY AREA	
1P	MATERIAL TO BE ROUTED TO PACKAGE UNIT SHOP	
1	MATERIAL TO BE ROUTED TO PIPE SHOP	

C2-280
-AK R4

PALLET SCHEDULE (EXAMPLE)

PL FAB MAT'L REQ'D	01-10-83	01-17-83	01-24-83	01-31-83	02-07-83	02-14-83	02-21-83	02-28-83	03-07-83
PLM, ZPLM REQUIRED	01-17-83	01-24-83	01-31-83	02-07-83	02-14-83	02-21-83	02-28-83	03-07-83	03-14-83
ARCH FAB MAT'L REQ	01-21-83	01-28-83	02-04-83	02-11-83	02-18-83	02-25-83	03-04-83	03-11-83	03-18-83
HEEL XFER REQUIRED	01-24-83	01-31-83	02-07-83	02-14-83	02-21-83	02-28-83	03-07-83	03-14-83	03-21-83
IB W/O REQUIRED	02-07-83	02-14-83	02-21-83	02-28-83	03-07-83	03-14-83	03-21-83	03-28-83	04-04-83
PE MAT'L XFER REQ'D	02-18-83	02-25-83	03-04-83	03-11-83	03-18-83	03-25-83	04-01-83	04-08-83	04-15-83
PART FABRICATION	02-21-83	02-28-83	03-07-83	03-14-83	03-21-83	03-28-83	04-04-83	04-11-83	04-18-83
FIN FAB PURC MATL REQ	03-14-83	03-21-83	03-28-83	04-04-83	04-11-83	04-18-83	04-25-83	05-02-83	05-09-83
IMP FAB-START COAT	03-21-83	03-28-83	04-04-83	04-11-83	04-18-83	04-25-83	05-02-83	05-09-83	05-16-83
INSTALL W/O REQUIRED	03-28-83	04-04-83	04-11-83	04-18-83	04-25-83	05-02-83	05-09-83	05-16-83	05-23-83
INST COMP-ASSY PALLET	04-04-83	04-11-83	04-18-83	04-25-83	05-02-83	05-09-83	05-16-83	05-23-83	05-30-83
PALLET REQ IN QUEUE	04-11-83	04-18-83	04-25-83	05-02-83	05-09-83	05-16-83	05-23-83	05-30-83	06-06-83
PART INST/ASSY WK OF:	04-18-83	04-25-83	05-02-83	05-09-83	05-16-83	05-23-83	05-30-83	06-06-83	06-13-83
C2-280 TAKA #1									*START LOAD H/DRS

UNITS	UNITS	UNITS	UNITS	UNITS	UNITS	UNITS	UNITS	UNITS
"S" PLTS	"S" PLTS	"S" PLTS	"S" PLTS	"S" PLTS	PLAT 19	"S" PLTS	"S" PLTS	"S" PLTS
240	9	63	250	20	"S" PLTS	"S" PLTS	"S" PLTS	"S" PLTS
241	75	32	138	23	84	87	88	17
242		4	79	82				92
254	*U&T*PLTS	5		25	*U&T*PLTS		PLAT 20	
8	246		*U&T*PLTS		24	*U&T*PLTS	"S" PLTS	PLAT 20
10	249	*U&T*PLTS	255	*U&T*PLTS	75	130	80	"S" PLTS
255	129	248	69	254	76	5		84
	45	19		10		16	*U&T*PLTS	
*U&T*PLTS	266		ONBD PLTS		ONBD PLTS		81	PLAT 20
247			16-D24-1X	PKG UNITS	20-M10-1X		7	*U&T*PLTS
239	ONBD PLTS		H/C FRMG	81D23-17X	20-M11-1X	ONBD PLTS	32	80
238	16-D23-1X		06D21-1XB	81D23-18X	20-M12-1X	07-M10-1X		
	H/C FRMG		ALL GRPS			07-M11-1X	H/C MODS	ONBD PLTS
			D21-1XB	LOAD PKGS		07-M12-1X	S, U, T	16-D31-1Y
	PKG UNITS		D21-1YB	81D21-29X			509	(DOORS)

PROCESS LANES AND DESIGN ENGINEERING
FOR ZONE OUTFITTING
AVONDALE SHIPYARDS, INC.

MOLD LOFT

Prepared by: R. POURCIAU

PROCESS LANES AND DESIGN ENGINEERING
FOR ZONE OUTFITTING
MOLD LOFT

I. INTRODUCTION

Today I will tell you of the many benefits Avondale has reaped as the result of implementing IHI technology. First, I will give you a brief overview of the technology; then, I will describe specific benefits.

Many of the IHI innovations implemented at Avondale on the Exxon contract were somewhat conceptual in nature at our first series of presentations. That is, not much experience at Avondale could be called upon to support why we elected to pursue some of the IHI concepts. Today that experience has been gained, the results documented and the techniques refined.

Some of these processes were incorporated into our daily work routines smoothly and with little effort. Some of the procedures were more difficult and required training, special programs and special techniques to implement. Such was the case with the "key line" method, for example. IHI technology is utilized "by the Mold Loft in the following: (VIEW GRAPH ML1)

- Mold Loft Planning
- Steel Tape System
- Key Line System
- Line Heating
- Pin Jigs
- Piece Number System
- Unit Control Manual

Now I will elaborate on the specifics of how IHI technology is utilized in each of these areas.

II. MOLD LOFT PLANNING

Much of the Mold Loft planning effort has been streamlined and incorporated into the Mold Loft's standards. The standards maintain continuity throughout the department and, ultimately, to all the Mold Loft data utilized by the shipyard. The procedure used by the planners, for example, on the Exxon contract to identify Datum lines, which are common reference lines, waterlines, frames and buttocks throughout the ship which are used for accuracy control, has now become a function of the engineering drawings.

Many of the inconsistencies that occur on a daily basis due to the large volume of lofting material have disappeared by the extensive use of comprehensive standard procedure manuals. As problem areas are discovered by the planners, meetings are held, the problems discussed and the resolution incorporated into a standard. (VIEW GRAPH ML-2)

In conclusion, the Mold Loft planners have aided the programmers and loftsmen to become more efficient in their work and have contributed in standardization of information forwarded to the field.

III. "UNIT CONTROL MANUAL"

The Unit Control Manual (U.C.M.) is a group of seven different documents designed to be used by the yard workers in every stage of hull construction from pre-fabrication to the erection of a unit on the ship. The objective of the U.C.M. effort is to break down the Engineering Yard Plan into basic components so that the average worker in the shipyard will be able to understand and follow these simplified instructions enabling the person to work accurately and quickly.

Each of the following seven documents is released separately to the shipyard prior to the work effort addressed. By confining the information in a document to the specific type of work to be done in each stage of construction, the worker has only that information needed to complete his specific task - thus, reducing the possibility of misinterpretation of non-essential information that could result in errors. For example, VIEW GRAPH ML 3.

A) CUTTING LIST (VIEW GRAPH ML-4)

This is the first document to be released to the shipyard and is ultimately utilized by the Plate Shop. The cutting list contains such information as piece numbers, quantities required, type of material and grade and cutting medium information for every part in a given unit to be burned with the exception of foundations and outfitting items.

B) PARTIAL SUB-UNIT BOOKLET (VIEW GRAPH ML-5)

This booklet is distributed to certain platen areas where initial fabrication of pieces is to be done. The information contained in this booklet includes parts list and pictorial references showing how to fit and weld all the pieces together that apply to this fabrication stage.

C) SUB ASSEMBLY BOOKLET (VIEW GRAPH ML-6)

This document is distributed to work areas where subassembly work is to be performed. This fabrication involves that combination of larger assemblies as opposed to individual pieces being welded together. The booklet contains a sequence of construction, part lists for each sub-assembly being built (if more than one) and an isometric drawing of the sub-assembly with all necessary details needed to complete the desired work.

D) MAIN ASSEMBLY BOOKLET (VIEW GRAPH ML-7)

The work effort addressed by this document deals with the closure of a unit by combining a sub-assembly with a panel of plating along with miscellaneous items such as collar plates, clips, chocks, etc. The booklet contains a sequence of construction, a parts list and all necessary drawings (including details) to complete the final hull work on a given unit.

E) ERECTION BOOKLET (VIEW GRAPH ML-8)

This is the final booklet required for actual hull assembly.

It provides information concerning leveling requirements, the attachment of the unit to the erected portion of the hull (with relevant details for fabrication of miscellaneous items that could not be built with the unit at an earlier stage).

The unit control manual, that I just described, was used in the Exxon contract, and proved to be an invaluable tool. Many of the IHI innovations are utilized as part of the data found in the UCM documents. Although the UCM was developed at Avondale prior to the IHI technology transfer, it readily serves the same purpose as the Japanese concept of "Stage Plans." A total of 635 UCM booklets were provided to the shipyard workers on the Exxon contract. Such IHI innovations such as steel tape identification numbers and datum lines are contained in the UCM'S.

The biggest selling point of the UCM manual is that it is a simple document that the average yard worker can easily understand. The UCM improves worker efficiency in the yard by saving drawing research time, by eliminating costly errors because the ship is "constructed" by the computer before any steel is cut. The unit control manual also allows yard supervision time to directly manage the workers rather than spending time interpreting documents for them.

iv. STEEL TAPE SYSTEM

To lessen the use of measuring devices and assure continuity across sections joined together, the IHI steel tape system was incorporated into the Mold Loft's effort. Similar aids were used in the past in the forms of wooden battens. This was done sparingly and only in repetitive areas. The tapes are fabricated from steel bands and produced by the conventional Mold Loft. A special measuring table was constructed which aids the loftsmen in his work.

The N/C Loft provides computer programs which are utilized to extract the steel tape data. These programs provide a printout to the loftsmen for marking the girths, etc. on the steel band. Steel tapes are used extensively by the yard in the fabricating and erection processes. A total of steel tapes for active jobs within the yard is now 693 steel tapes. Each tape is catalogued and duplicated in case of loss or breakage (VIEW GRAPH ML-9).

Steel bands are provided for all stages of ship construction. Steel tapes eliminate the use of measuring rulers and the errors associated with using those devices. The same information is used over and over, which increases accuracy and consistency when fabricating the units.

Steel tapes have contributed to reduced costs at the erection site and an overall reduction in fitting problems.

v. LINE HEATING

Traditionally, shell plates in the shipyard were shaped by one of the following methods:

- Rolling
- Pulling in place on unit with jacks or weight blocks
- Furnaced plates from the blacksmith shop

With the implementation of line heating technology these processes have virtually been eliminated (with the exception of rolling) in the shipyard. Shell plates with compound shape that customarily cause fitting, welding and distortion problems to the units have been replaced with shell plates accurately pre-formed to the configuration of the unit.

Experience on the Exxon ships has shown that practically every shell plate with some compound shape was eventually line heated. (VIEW GRAPH ML-10)

As each unit is processed by the Mold Loft, the conventional loft provides form templates (usually on frame lines) with sight edges and sight lines for line heating clearly marked. The sight lines are on an axis normal to the roll axis to the plate. The declivity angle for each frame is also indicated so that the templates are held in the proper orientation. The roll set templates give the desired transverse shape. The plane established normal to the roll axis at each frame gives the amount of twist; the tread line or sight line, when straightened, determines the amount of longitudinal shape. A plate has the correct shape only when the roll sets fit the plate on the prescribed declivity; the vertical plane is sighted as flat and the sight line is straight. Results of the line heating process as applied to the Exxon tankers were excellent. We monitored each unit carefully as we installed the shell plates, checking tolerances for shape and overall fit to the units. As line heated shell plates were placed in the pin jigs, we checked the overall configuration against the pins. More exacting checking procedures were used on some units such as forepeak and aftpeak units where under certain conditions we used a wooden template to assure ourselves that the shape of the shell plate was correct. Another method used to determine exactness were the diagonal dimensions derived from the key line programs.

Certainly, not every shell plate fit the jig or unit without some adjustment by either utilizing the forming stock or further line heating of the plate. The number of these plates was minimal and to an acceptable number within the shipyard. When this condition occurred, it was usually quickly rectified.

A total of 600 shell plates were line heated over the course of the three-ship Exxon contract.

The benefits we have gained by utilizing the line heating method are:

- elimination of the furnaced plates;
- more accurately shaped plates;
- less fitting time on the platens;
- eliminating dogs, clips and lugs and having to restore surfaces;
- reduction in misalignment across units;
- larger plates can be utilized without furnace size restrictions.

VI. PIN JIGS

Forty (40) construction jigs were utilized on the Exxon contract. Twenty-one (21) of these jigs were pin jigs, nineteen (19) of these were fixed or solid jigs, Those units that required a solid jig were units that had excessive curvature, excessive twist or a width too narrow to be suitable for pin jig fabrication. Generally speaking, those units requiring a fixed jig were in the fore-peak or aft peak of the vessel."

Data required by production to set the pin heights, check dimensions, etc. are derived via computer programs. This information, along with a sketch of pins to be utilized, is used to set the jig for the unit. (VIEW GRAPH ML11, ML12)

The procedure utilized to set the pin jigs are as follows:

Pin elevations are converted to identify if a long pin or a short pin is to be utilized and to identify which of the three pin stops to use.

Labeling each pin location with it's appropriate elevation and pin size (pin number and row).

- Making necessary reinforcements when necessary (if the pin is totally extended it wobbles, and a brace is necessary).

Locate and install stops to restrict plate movement.

Rough adjustments are made to the approximate elevation.

Final adjustments are made to the pin.

Success of pin jig implementation is directly attributed to accurately line heated shell plates, The shell plates must be in the jig correctly. Once plates are installed on the pins they cannot be "pulled" down into position as on a fixed jig.

False frames at the ends of the unit are also a prerequisite when using the pin jig method. False frames are used for the alignment of shell plates and longitudinal in the pin jig. Use of false frames assures that the degree of fairness required for aligning shell butts and longitudinal at erection will be maintained.

Accurate layout of the frames and longitudinals is provided by utilization of the "Key Line" method. Steel tapes are used once the shell plate has been welded to verify the accuracy of the N/C punched layout and any discrepancies between the machine layout are resolved at this time. After the layout is corrected, the frames and longitudinal are installed and welded.

The transition from fixed jigs to pin jigs was very smooth and basically problem free. We encountered one unit on Exxon that because of its unusual shape should not have been built in a pin jig. This unit was a forepeak unit that had one shell plate tht "stuck out in space." The problem was not apparent when we analyzed the unit to determine if it should be built on a pin or solid jig. The Loft provided some special templates to maintain the correct shape and the unit was completed on schedule.

Some of the advantages we have gained by utilizing pin jigs is that the Mold Loft cost/effort is reduced from that of a fixed jig. The set-up time for the field is shorter with a pin jig. The pin jig area can be utilized without the costly storage of fixed jigs. The material costs of steel plates for fixed jigs is eliminated. Welding costs and fitting costs for fixed jigs is eliminated, and the cost of N/C burning the fixed jigs disappears.

Our successful use of pin jig technology, coupled with line heating and the keyline layout method, is evident in the reduction of costs at the erection site when units are quickly and accurately aligned.

VII. PIECE NUMBER SYSTEM

A major factor in the successful use of process lanes was the new piece numbering system. This number consists of a twelve digit hull piece identification number. The staging or construction route of a part is determined by this number. Individual hull components are numbered on the hull engineering drawing. These drawing are used by the hull production planner to assign the staging piece number in the form of a parts list. The drawings are also used to write a unit summary sheet of how the unit is to be built.

The actual construction method for a unit is decided in advance at production meetings. The four basic components used in the piece numbering are: (VIEW GRAPH ML-13)

- Unit Number
- Sub-Unit Number
- Partial Sub-Unit Number
- Piece Number

Individual pieces are fabricated together to form partial sub-units. The combination or partial sub-units with other partial sub-units and/or individual pieces, depending on the fabrication site, creates a uniquely numbered, larger partial sub-unit. The fabrication of a sub-assembly to another sub-assembly will create another site unique sub-unit. If the work is done at the main assembly site, the result is the main assembly of the unit.

In all cases, the location of the fabrication work done on pieces or assemblies determines the type of assembly produced. If the work is done on an initial fabrication platen, then the result is a partial sub-unit (PSU). If fabrication is done on a sub/main assembly platen, then the result is a sub-assembly, and likewise for main assembly. An individual piece (before fabrication) will always have the following numbering configuration:

Unit No. - Sub-Unit No. - Partial Sub-Unit NO. - Piece No.
Ex. #003 - 001 - 017 - 143

A partial sub-unit will always have this configuration:

Unit No. - Sub-Unit No. - Partial Sub-Unit No.
Ex. 003 - 001 - 017

(NOTE: After initial fabrication, the resulting assembly loses its individual piece number identities.)

A sub-unit will have the following configuration:

Unit No. - Sub-Unit No.
Ex. 003 - 002

(NOTE: P.S.U. identities no longer needed after fabricated to create sub-unit.)

At the final or grand assembly the assembly is identified with only the unit number.

The previous examples show that the information given by the piece number explicitly indicates not only the unique identity of a part or assembly but also its next destination in terms of the process lanes concept and has proven its worth since introduced.

VIII THE KEY LINE METHOD FOR MARKING SHELL LAYOUT (VIEW GRAPHS ML-14 & ML-15)

Integrated into the Mold Loft's procedures is the IHI method for checking N/C or manual layouts on curved shell units built in a solid or pin jig. The key line method, which has been presented in detail at an earlier seminar, utilizes a series of steel marking tapes and wooden templates to verify the marking in a jig for structural entities such as bulkheads, shell longitudinal and frames. The key line method is utilized to check an existing layout either from N/C burning or from a manual layout.

Computer programs have been written to provide the complex data required for the key line layout. Variable names for sight edges, etc., are plugged onto these programs and the output retrieved from the ships data base. This output in the form of computer printouts are provided to the loftsmen to generate the steel tapes and declivity data required for a key line layout.

The "Key Line" method for marking shell plate layouts in fabrication jigs has been used extensively since our last meeting. All of the units requiring jigs on the Exxon contract (approximately 50 units) were verified by using the key line method. The results were very favorable with benefits gained in a reduction of rework for those units built in jigs and reduced costs. Other benefits were the elimination of stock in certain areas of the ship and higher accuracy obtained at the erection site.

Close cooperation with the many departments the Mold Loft deals with has contributed significantly to the success of the IHI program at Avondale. A willingness to improve and seek more efficient and cost effective techniques has aided us in becoming one of the most competitive shipyards in the United States.

QUESTIONS/ANSWERS

I H I
TECHNOLOGY IN MOLD LOFT

- * MOLD LOFT PLANNING
- * MOLD LOFT SCHEDULING BY STAGE
- * DEVELOPMENT OF UNIT CONTROL MANUALS
- * STEEL TAPE SYSTEM
- * KEY LINE
- * PIECE NUMBER SYSTEM
- * LINE HEATING
- * PIN JIGS

REFERENCE MARKS (RFMK) FOR INNER TRACE OF A MEMBER, MUST BE PUNCHED ACROSS THE CUTOUT IT PENETRATES. THIS ESTABLISHES CORRECT ALIGNMENT OF STIFFENERS. THIS IS DONE BY USING COMMAND (DBCT) WITH (RFMK). THE RESULT IS AN AUTOMATIC PUNCH. FOR CUTS NOT LOADED TO THE DATA BASE. AN INNER TRACE POINT MUST BE SAVED AND A MANUAL PUNCH GENERATED WITH THE PUNCH NORMAL TO THE MEMBER.

EXAMPLE

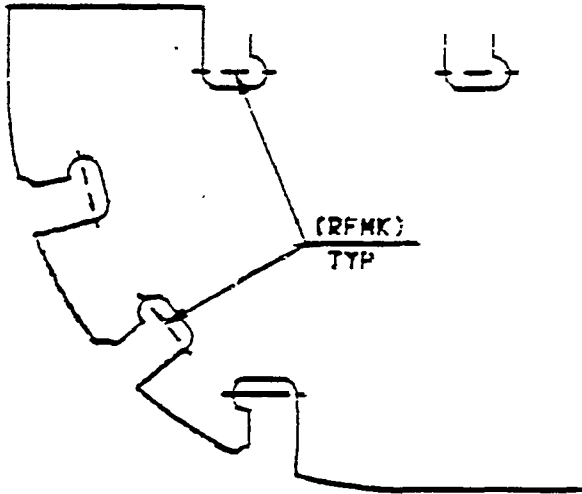

SOURCE OF INFORMATION: NUMERICAL CONTROL STANDARD PRACTICE	APPLICABLE TO
	JOB ALL

REVISIONS:	DATE	REV.

TITLE: INNER TRACE REFERENCE MARKS FOR ALIGNMENT OF STIFFENERS	DRAWN BY	DATE	S.P.514
	C. MORGANT	8-4-81	
	ORIGINATOR	DATE	
	R. PROBCIAW	8-4-81	
	APPROVED	DATE	SHT 5.6

•STANDARD PROCEDURE

ML 2

UNIT CONTROL MANUAL

2335 (B)

2336 (H)

2337 (G)

ASI HULL NO

NAME OF VESSEL

AVONDALE
SHIPYARDS INC

ASI JOB NO

C1-15



P O BOX 50280
NEW ORLEANS LA
70150

EXXON

DRAWN BY DATE

42,000 DWT

MULTI-PRODUCTS CARRIERS

CHECKED BY DATE

UNIT -

APVD

ISSUED

SIZE
B

CUTTING LIST

REV

SIZE
B

PANEL LINE

REV

SIZE
B

PARTIAL SUB-UNITS

REV

SIZE
B

SUB ASSEMBLY

REV

SIZE
B

MAIN ASSEMBLY

REV

SIZE
B

ERECTION

REV

ML 3

FRB-FABRICATION INFORMATION IN U.C.M.

FRB-FAB INFO. IN U.C.M.	TYPE OF INFO. PLANS SHOP WILL RECEIVE	LABELING METHOD
./C Burning Tape No.'s <u>16-----</u>	<ol style="list-style-type: none"> 1. 1" scale drawing representing steel plate to be burned. 2. Burning data stored on IBM System 7. 	1" scale burning tape drawing
Servo (Servograph)	Full size optical tracing template (film)	Full size servo-graph template
Temp. (Template)	Full size wooden or paper template	Full size wooden or paper template.
M.T. (No Template)	Cut to size given in "Dimensions" column of U.C.M. Cutting List	U.C.M. Cutting List
Exacto No. (Exactograph)	Exactograph Sketch	Exactograph Sketch
FRBD (Frame Bending)	<ol style="list-style-type: none"> 1. Framebending computer printout of inverse curve. 2. Paper end cut templates. 	Frame Bending computer print-out
.LCSK No. (Cold Loft Cutting Sketch)	<ol style="list-style-type: none"> 1. Sketch of structural showing dimensions & processing instructions. 2. Standard end cut template (if applicable) 	Cold Loft Cutting Sketch
PLCSK (Panel Line Cutting Sketch)	Sketch of panel (butt station) indicating lengths, widths & bevels of plates to be cut on exacto machine.	Butt Station Drawing (found in panel line booklet).

ML4

DET. "A"

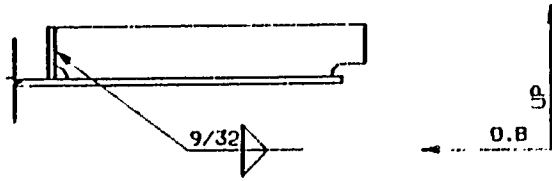

15/16"

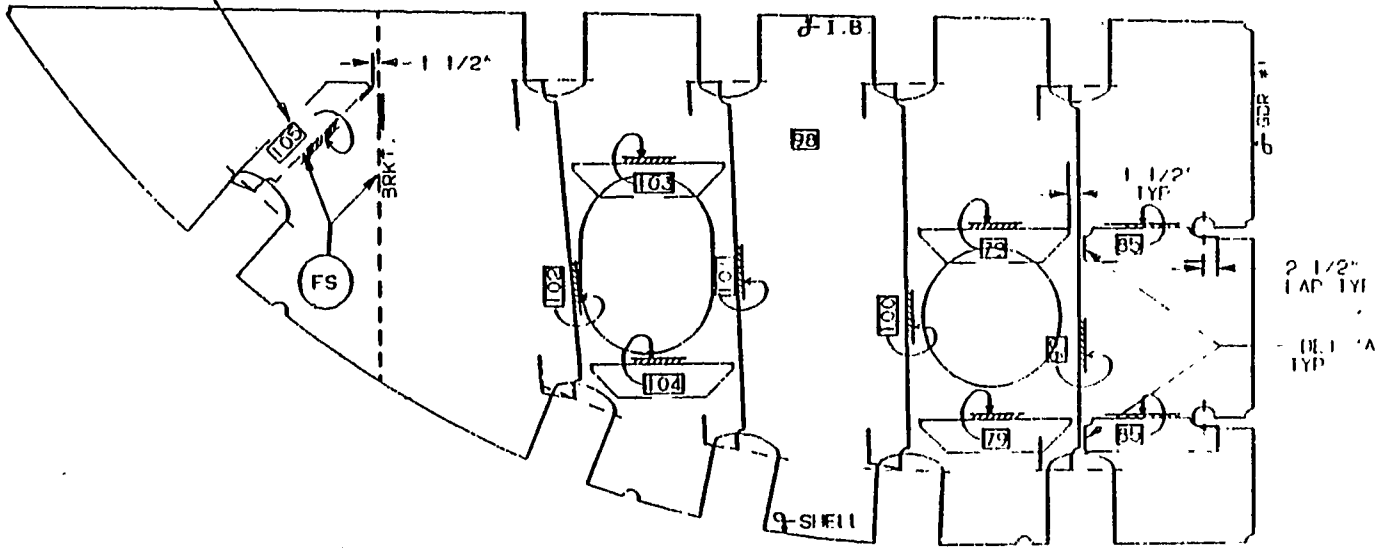

PARTS LIST					
QTY	PIECE NO	QTY	PIECES	MATERIAL	GRADE
1	2-1-18-98	1		15/32 PLAIN	ALL S.
2	2-1-18-99	1		5/8" X 6" I.B.	A
3	2-1-18-100	1		5/8" X 6" I.B.	A
4	2-1-18-101	1		5/8" X 6" I.B.	A
5	2-1-18-102	1		5/8" X 6" I.B.	A
6	2-1-18-103	1		5/8" X 6" I.B.	A
7	2-1-18-104	1		5/8" X 6" I.B.	A
8	2-1-18-105	1		5/8" X 6" I.B.	A
9	2-1-18-79	2		5/8" X 6" I.B.	A
10	2-1-18-85	2		5/8" X 6" I.B.	A

ACRCK SHEET 9/81

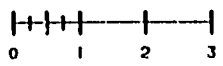

TYP WELD 3/16	SIZE B	DRAWN BY B. LYNN	NOV 11 1951	TRANSV FLOOR FR 60 PURT	ASSEMBLY NOV 21 1951
		CHECKED BY <i>[Signature]</i>	REVISION		SHEET NO. 16

ML5

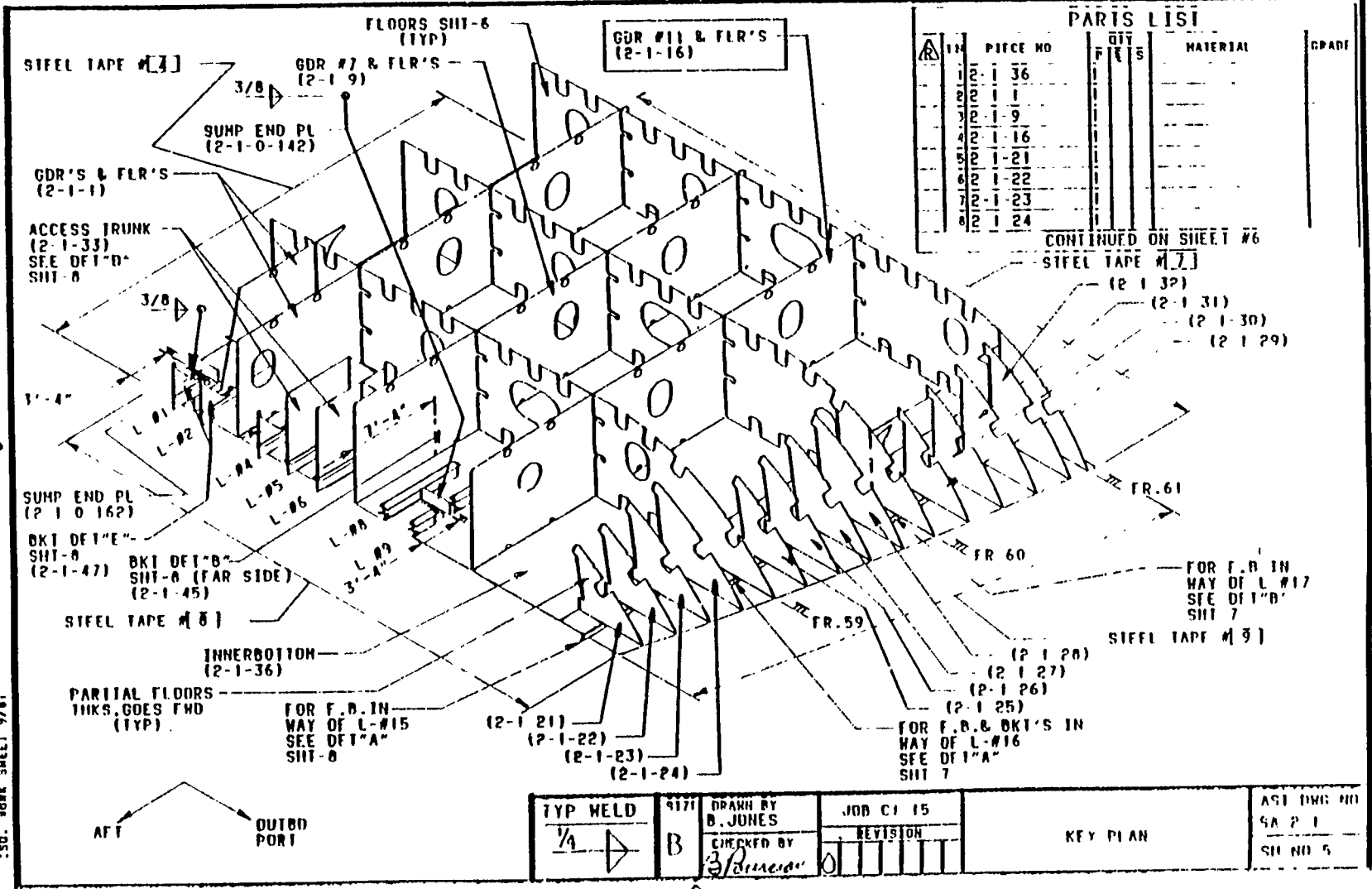

PARTS LIST				
IN	PIECE NO	QTY	MATERIAL	GRADE
1	36			
1	9			
1	16			
1	21			
1	22			
1	23			
1	24			

CONTINUED ON SHEET #6

30. WORK SHEET 9/61

TYP WELD 1/4	9171 B	DRAWN BY B. JONES	JOB C/ 15	KEY PLAN	AS1 DWG: 011 SA 2 1 SH NO 5
		CHECKED BY <i>B. Jones</i>	REVISION		

ML6

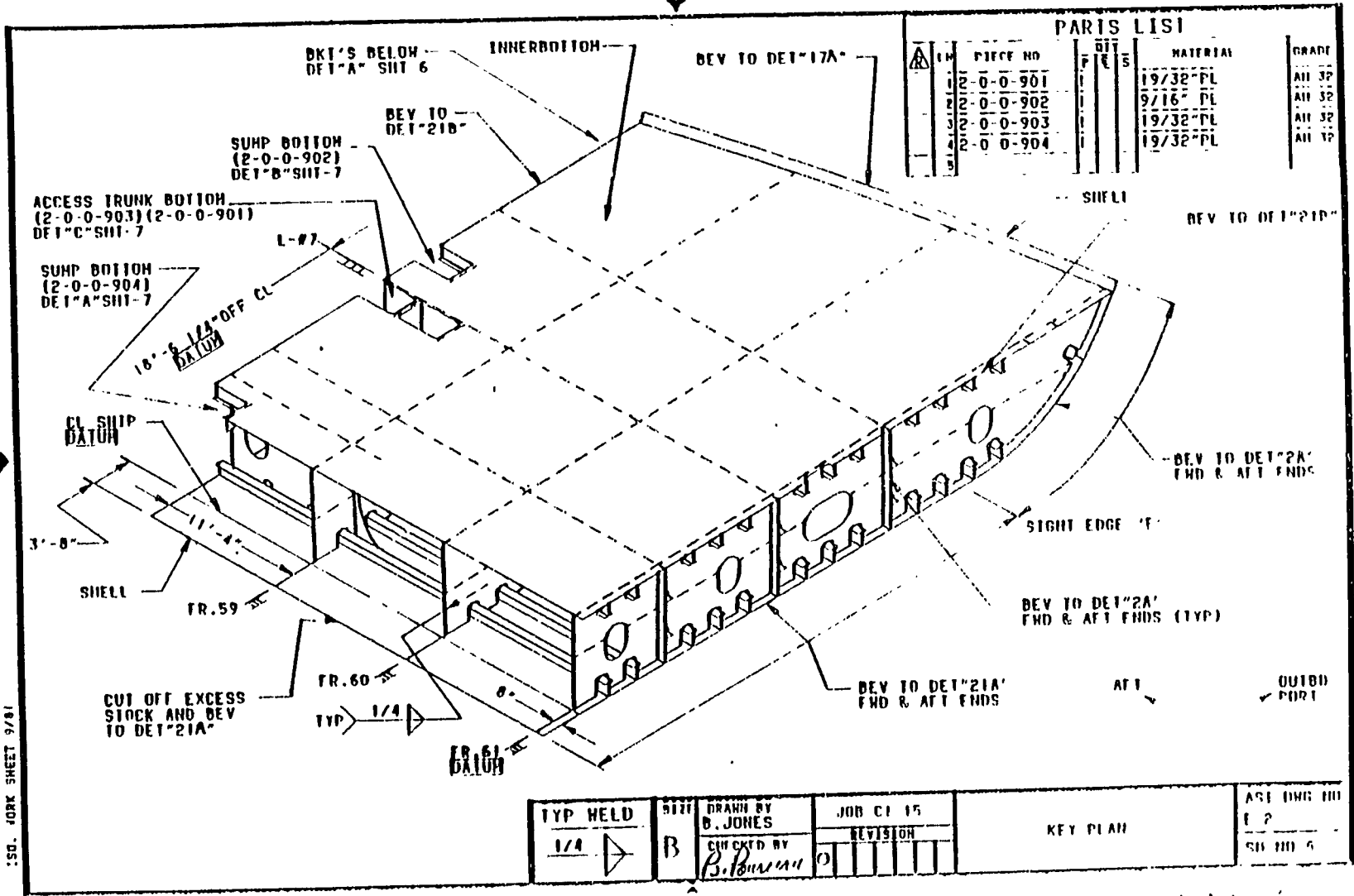

PARTS LIST				
QTY	PIECE NO	DET	MATERIAL	GRADE
1	0-0-901	1	19/32" PL	AN 32
2	0-0-902	1	9/16" PL	AN 32
3	0-0-903	1	19/32" PL	AN 32
4	0-0-904	1	19/32" PL	AN 32

ISO. WORK SHEET 9/81

TYP WELD 1/4	SIZE B	DRAWN BY B. JONES	JOB CI 15	KEY PLAN	ASE DWG III
		CHECKED BY P. BROWN			REVISION
					SIX III 5

ML 6

11

Mark side on the steel Tapes

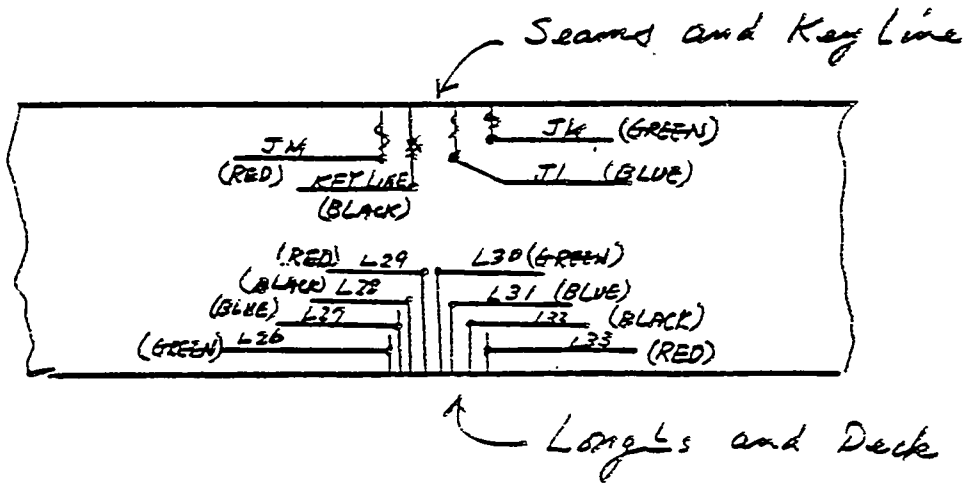
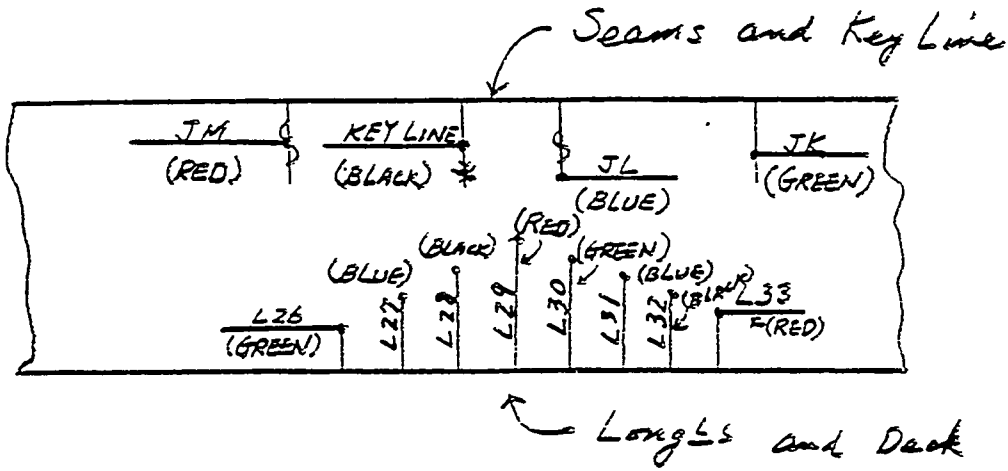

M_9

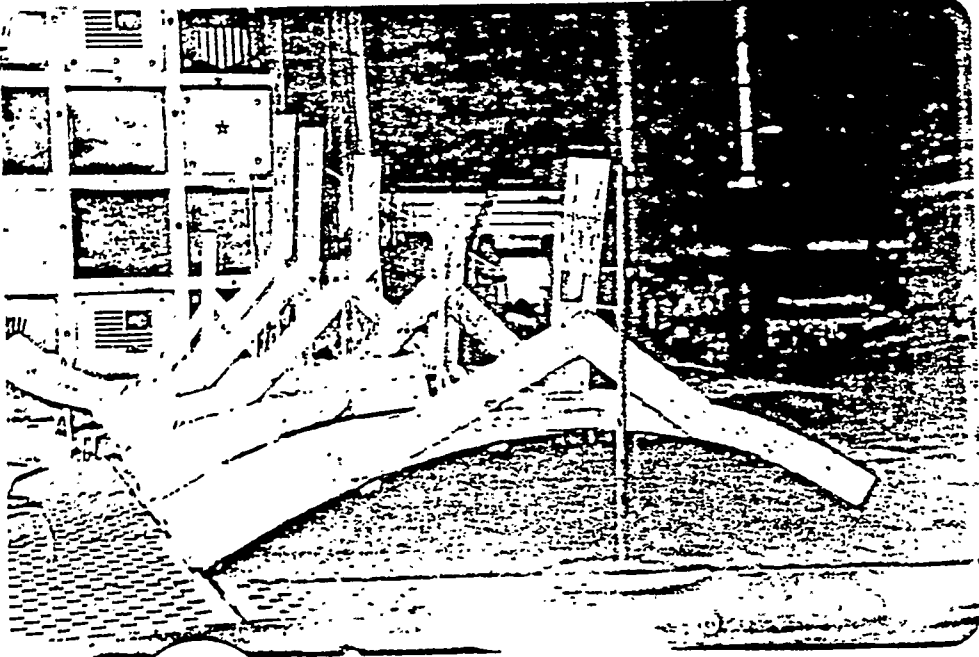
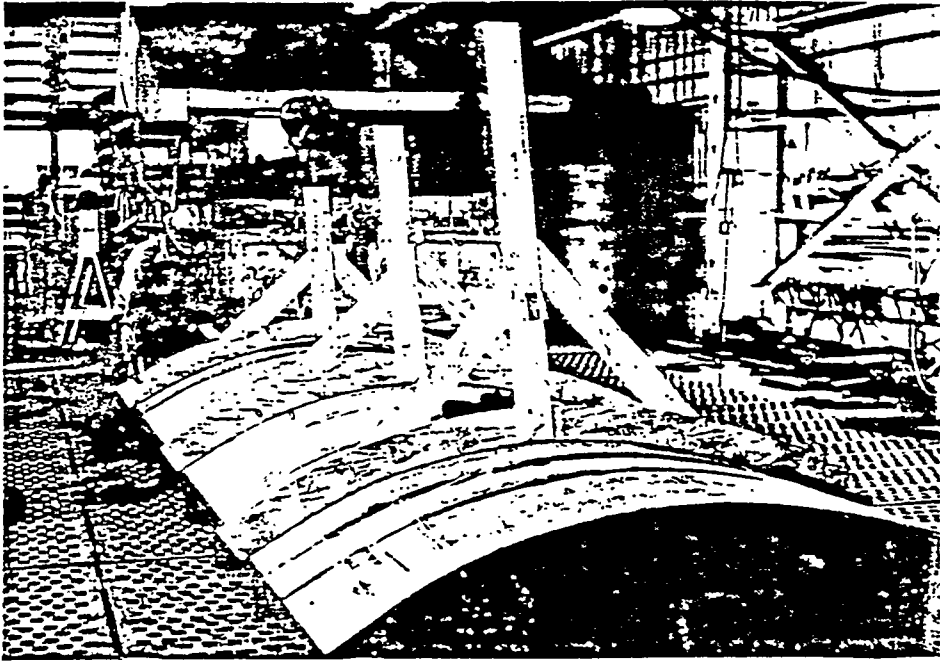
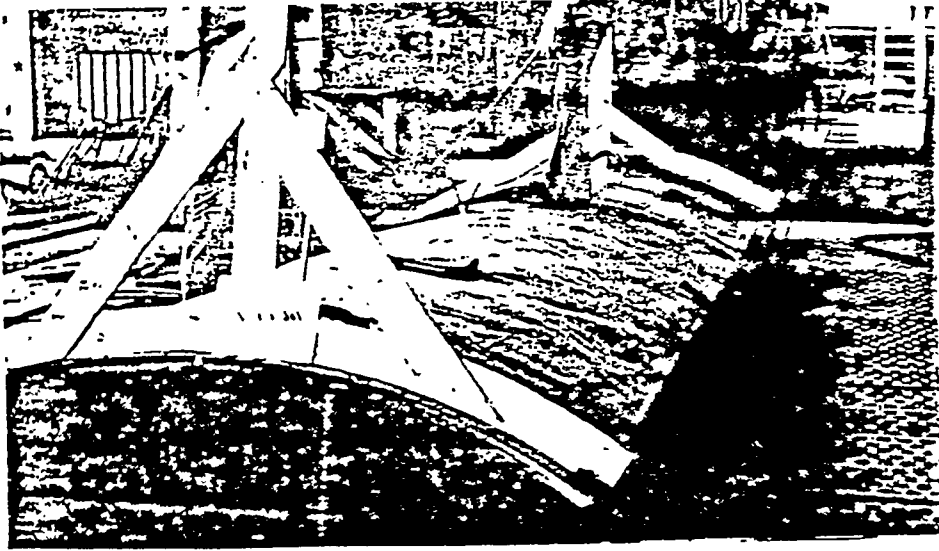

MLIC

DATE: 01/15/92
JOB NO.: 01-15

SHELL JIG PIN HEIGHTS

PAGE NO. 1

PRODUCT CARTER

ASSEMBLY: *

UNIT 27-P/28-S

ALL DIMENSIONS GIVEN IN FEET, INCHES & 16TH

DISPLAY OF SHELL ASSEMBLY CORNER POINTS

CORNER NO.	1	ON SIGHT EDGE G	700700 FEET FWD OF FRAME	61900
CORNER NO.	2	ON SIGHT EDGE HDK	700700 FEET FWD OF FRAME	61900
CORNER NO.	3	ON SIGHT EDGE MDK	700700 FEET FWD OF FRAME	58900
CORNER NO.	4	ON SIGHT EDGE G	700700 FEET FWD OF FRAME	58900

ANGLE OF WEDGEMATE AGAINST BASE IS 86 DEGREES

JIG CONFIGURATION	ROW SPACING	4.0 FEET	MARGIN	0.5 FEET
	PIN SPACING	4.0 FEET	PIN OFFSET	0.0 FEET

CORNER LOCATIONS ON THE JIG

CORNER NO.	1 IS DISPLACED	-3/00/09 IN Y	-7/06/00 IN Z	FROM PIN 1 IN ROW 2
CORNER NO.	2 IS DISPLACED	7/01/06 IN Y	-3/05/10 IN Z	FROM PIN 2 IN ROW 14
CORNER NO.	3 IS DISPLACED	3/05/13 IN Y	7/09/05 IN Z	FROM PIN 10 IN ROW 13
CORNER NO.	4 IS DISPLACED	-7/06/00 IN Y	3/10/14 IN Z	FROM PIN 9 IN ROW 1

Y DENOTES DIRECTION ACROSS ROWS
Z DENOTES DIRECTION WITHIN ROWS

ML 11

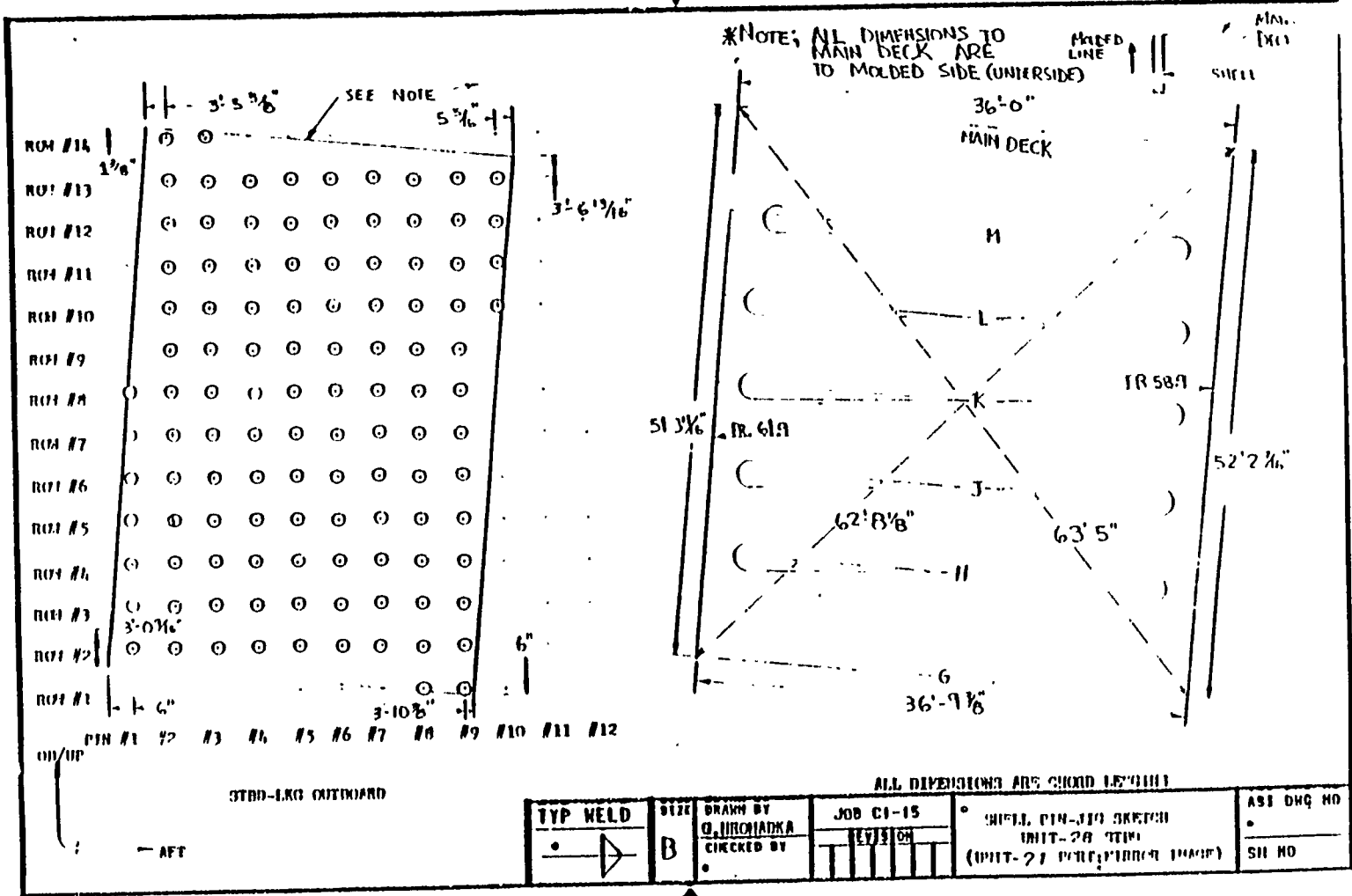

ML 12

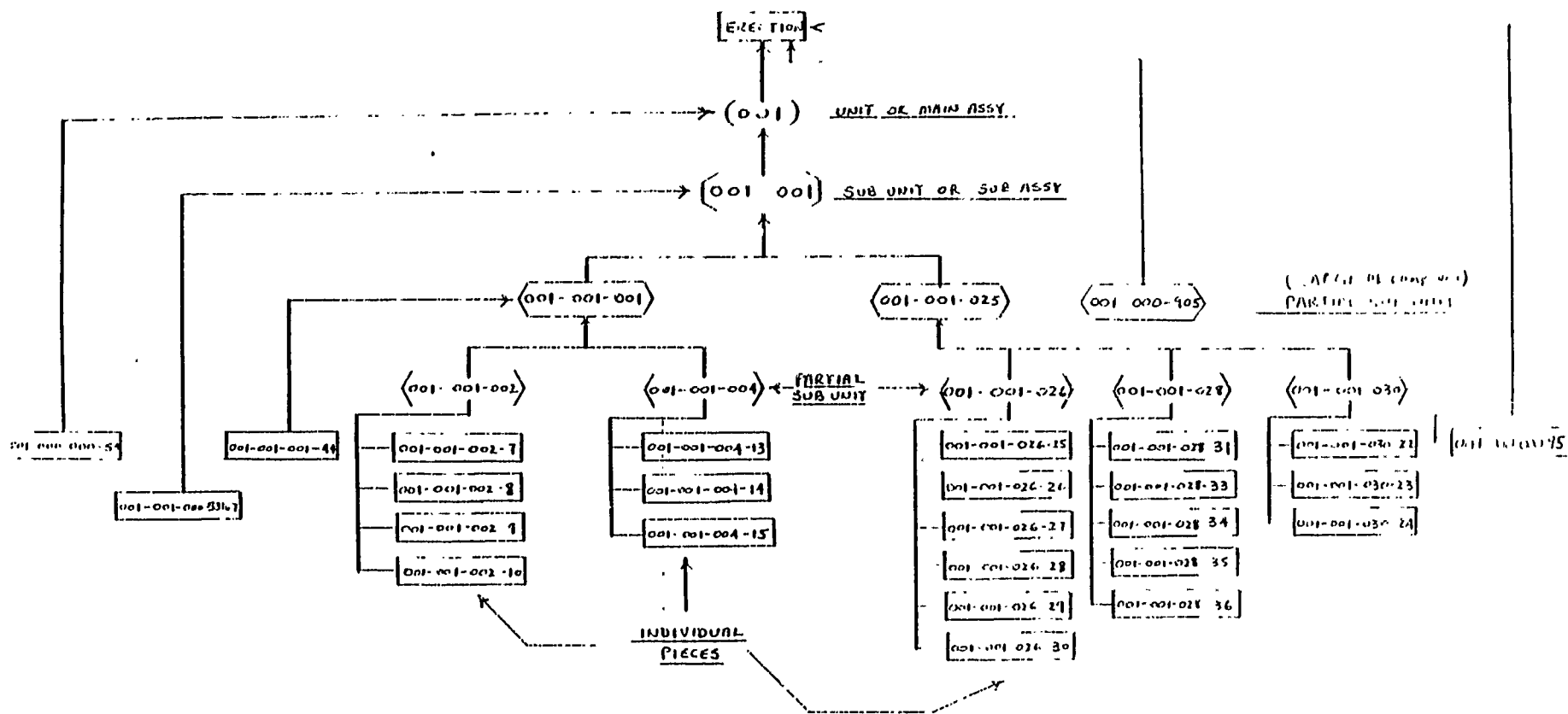

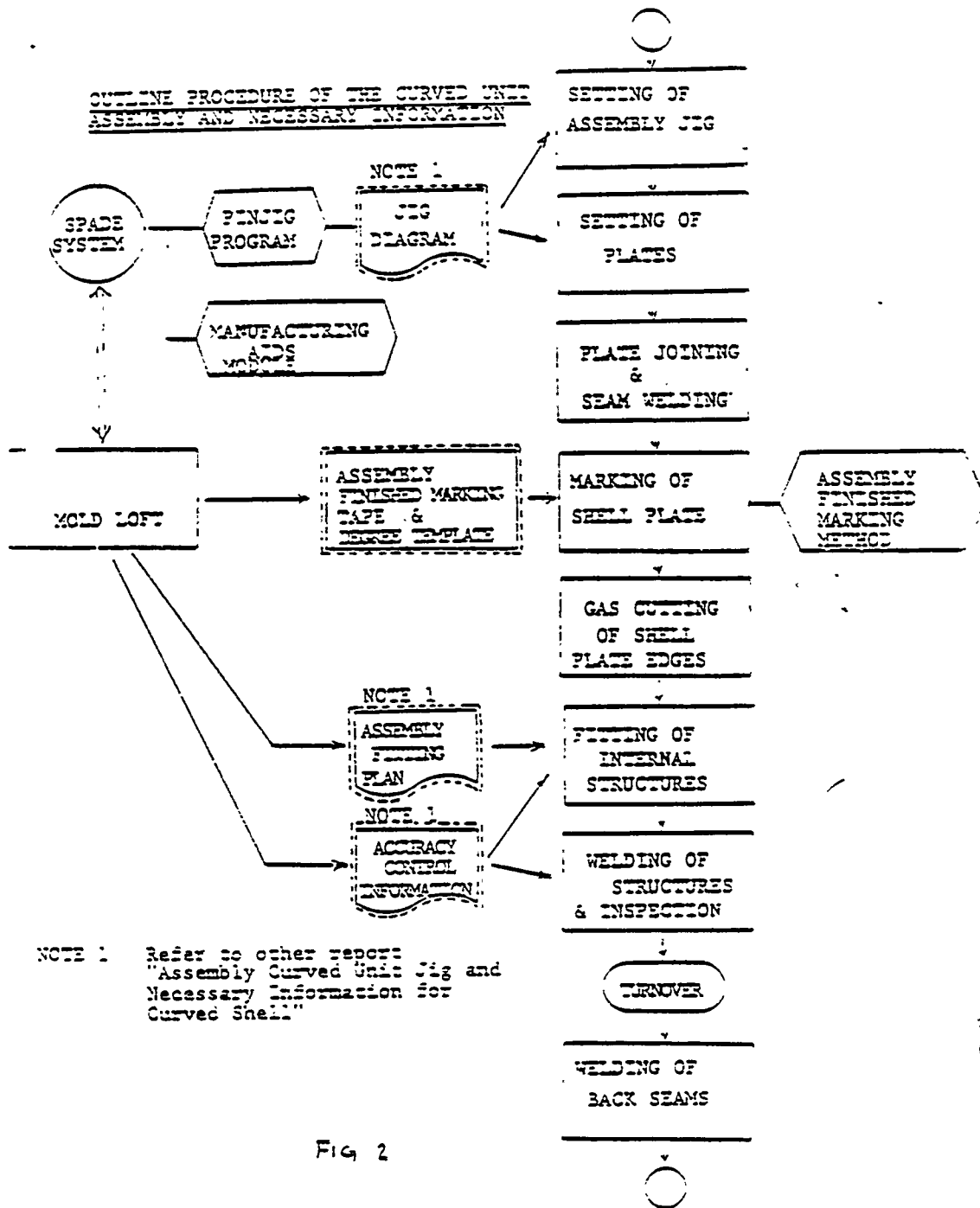

Fig. 2

D. I. W.

PROCESS LANES AND DESIGN ENGINEERING
FOR ZONE OUTFITTING
AVONDALE SHIPYARDS, INC.

ACCURACY CONTROL INTERFACE

Prepared by: JIM TAYLOR and WALTER WEIDMAN

PROCESS LANES AND DESIGN ENGINEERING
FOR ZONE OUTFITTING
ACCURACY CONTROL INTERFACE

I. INTRODUCTION

This is the fourth in this series of seminars in which Accuracy Control has been one of the topics under discussion. And, although much progress has been made here at Avondale in this field, the basic concepts and procedures have remained quite constant. Therefore if a valid presentation of these concepts, and a comprehensive one, is to be made, it necessitates going over the same ground with each discussion, This obviously results in a considerable degree of redundancy for you who may have attended any of the earlier seminars. For the sake of those who are in attendance for the first time, I ask you to please forgive this redundancy. For those of you who are attending for the first time, I must explain that the limited time made available for this discussion does not permit full coverage of all material. I hope that you will refer to the printed copy for more comprehensive coverage,

Webster's says that "accuracy" is "freedom from mistakes or errors. If this were applied to ship construction, it would imply that the finished individual parts and ultimately the ship itself would exactly coincide with all design dimensions and details, While obviously no such exactness could be expected to actually exist, one of the functions, perhaps even the primary function, of an Accuracy Control Department is the establishment of realistic goals in the area of "accuracy" within which a shipyard Production Department can operate, with proper consideration being given to the demands of both quality workmanship and sound economics.

The word "Control" should be quite literally accepted; the required controls should be implemented in such manner as to insure the degree of accuracy which is desired.

We have now determined the two initial functions of an Accuracy Control Department:

the establishment of realistic goals in the area of accuracy;

the development of proper procedures or controls to permit the achievement of those "accuracy" goals.

The adequate implementation of these two primary functions necessitates the existence of a basic philosophy in management that is committed not to just doing a job the best way possible, utilizing all the facilities that are available, but is

rather committed to doing that job the best way possible the very first time it is attempted. Any other philosophy is a positive commitment to the necessity of rework and the elimination or rework should be inherent in all of the activities of an Accuracy Control Department. The continued operation of an effective accuracy control program, administered under this concept, will virtually assure that the philosophy of doing a job the best way possible the very first time will ultimately pervade all areas of work.

In this discussion we will consider the areas of work where an accuracy control program can be the most cost effective and how that program can best be developed and implemented. An attempt will also be made to determine certain basic priorities to be applied when getting up the activities of an accuracy control program. Such priorities may well vary from shipyard to shipyard, but it is probable that they will generally be applicable.

II. ACTIVITIES OF AN ACCURACY CONTROL DEPARTMENT

A. GENERAL

The activities of an Accuracy Control Department should span all phases of construction from the burning of the plate and structural to the final erection of all material in the completed ship. These activities may be roughly divided into three categories:

- Checks
- Controls
- Statistics

These efforts should have a dual impact: the improvement of immediate work and the improvement of future work (see Fig. 1-1). Although these are distinct and separate activities, they are so thoroughly interrelated that any one cannot be effectual without the involvement of the other two.

1. Checks

Checks are utilized for three primary purposes:

- a. The isolation of specific problems that present a demand for controls.
- b. The monitoring of construction to insure that:
 - 1) proper controls are being utilized
 - 2) controls are, in fact, effective

C. The monitoring of construction to assist in the minimizing of human errors.

2. Controls

The word "Controls" in this discussion refers to various specific activities and procedures that are developed and utilized to aid in the achievement of established Accuracy Control goals. It is only through the use of such Controls that a predictable end result may be achieved.

3. Statistics

Statistics may be divided into two categories:

- a. The development of statistics that are applicable to shipfitting work throughout the ship.
- b. The development and maintenance of statistics applicable to a specific unit. In other words, a unit history.

4. Coordination Of Activities

The coordination of these activities is graphically displayed in Figures 1-2 through 1-5. Figure 1-2 indicates that without the utilization of an Accuracy Control Program, a poor product is the predictable end result, both for immediate and future work. Figure 1-3 indicates the implementation of checks. Checks alone cannot improve the end product. Figure 1-4 indicates the development and implementation of controls in addition to checks. This results in an improved product for immediate work but develops slight potential for the improvement of future work, Figure 1-5 indicates the results that may be expected with the implementation of a well coordinated Accuracy Control Department, utilizing checks, controls and statistics.

The results from this are not only a good product in the immediate work nor the potential for a good product in the future work, but the potential has also been developed for improved design concepts, improved engineering concepts and improved production concepts.

The amount of time spent on each of these three distinct but interrelated activities will vary widely, contingent upon many factors such as the stage of development of the Accuracy Control Department or the complexity of the work at hand. In the early stages of the development of an Accuracy Control Department, it is likely that checks will be the single most important activity. Initially, the checks are necessary to develop a cognizance of all

the problems that are at hand. As these various problems are recognized and evaluated, controls may then be developed and implemented to alleviate the problems. As the work progresses and the effect of controls becomes pronounced, the need for checks should begin to taper off until ultimately it is used primarily as a monitoring procedure. Similarly, in the early stages of development of an Accuracy Control Program, a very considerable amount of time will be utilized in the development of generally applicable statistics. As these statistics are evaluated and utilized in the development of controls, the need for statistics will also tend to taper off. The maintenance of unit histories must be a continuing effort.

B. OUTLINE OF ACCURACY CONTROL ACTIVITIES

1. Controls

- a. Control Lines, Control Points and Backside Marking
- b. Burning Procedures
- c. Uniform Shrinkage Factors
- d. Construction Procedures
- e. Erection Procedures
- f. Construction Aids

2. Checks

- a. Measuring Procedures
- b. Mathematical Checking Systems
- c. Forms For Reporting
- d. Establishment Of Unit Profiles

3. Unit Histories

- a. Engineering
- b. Mold Loft and Numerical Control
- c. Plate Shop
 - 1) Burning
 - 2) Panel Line
- d. Structurals

- e. Shipfitting
- f. Welding
- g. Handling
- h. Miscellaneous

C. DISCUSSION OF ACCURACY CONTROL ACTIVITIES

1. Controls

a. Control Lines

Control lines, otherwise called master lines or datum lines, are water lines, frame lines, or buttocks that are layed out on various components of units to facilitate the building and erection of the unit. (See Fig. 3-6.) The utilization of these lines will receive further elaboration later in this discussion,

b. Burning Procedures

The accurate burning of all pieces of units, subunits, or partial sub-units is of primary importance because anything else is a commitment to rework. Fig. 2-3 shows several areas where this accuracy is demanded. The fit of floor stiffeners to shell longitudinals requires not only that the stiffener be cut to proper length, but that the shell longitudinal must also be ripped to the proper width. A minimum gap of 1/4" requires that each of these members be cut within 1/8" tolerance. A fit that will always insure no burning at assembly requires even closer burning tolerance.

The fit of floor to girder requires a burning tolerance of 1/32" if all of the floors are to be fitted on a unit without reburning. Unit No. 17, the first unit completed on the Exxon contract, with the exception of one shell plate that had stock on it when it should have been neat, was completely assembled without the use of a torch during assembly.

c. Uniform Shrinkage Factors

Few activities are of greater consequence than the development of uniform shrinkage factors. Accurate burning is of little consequence without the utilization of such factors. Floors, as shown in Fig. 2-3 with an excessive shrinkage factor built in, would require occasional reburning to offset a cumulative build-up, even if individual floors were only 1/16" oversize. Web frames (see Fig. 2-4) require a differ-

ent shrinkage factor than the longitudinal bulkhead to which they must be fitted. Specific factors must be developed for all components of a unit.

d. Construction Procedures

Proper construction procedures such as fitting and welding sequences may well offer the most possible and immediate reward for the efforts of an Accuracy Control Department. This area of work will receive greater elaboration later in this discussion.

e. Erection Procedures

The Accuracy Control Department at ASI is primarily involved in work during stages prior to erection. However, erection is a principal beneficiary of the use of control lines. These lines, when layed out with predictable accuracy, are an invaluable aid in setting units at erection. Also, the elimination of stock is virtually impossible without the use of these lines.

f. Construction Aids

Various tools are utilized in the Production Department at ASI to facilitate increased accuracy of construction. These will receive greater elaboration further in this discussion.

2. Checks

a. Measuring Procedures

Accuracy Control engineers spend a great part of their time measuring – slow, methodical, painstaking, tedious measuring. This can at times seem like the most plodding of work, but it is also the most necessary of work. It is this statistical evidence from which proper controls may be developed. A typical example is a web frame. (See Fig. 2-4.) This component must be measured before the butts are welded, after the butts are welded, and after the stiffeners and face plate are welded. This is necessary in order to determine proper shrinkage factors to be utilized in the cutting of component plating. This information is also utilized in the development of assembly procedures that assist in the minimizing of deformation of the component. It may be noted that the dimensions shown on this form provide all the information necessary to make possible these evaluations.

b. Mathematical Checking Systems

Utilizing pertinent X and Y coordinates and rather uncomplicated programs that can be fed into hand-held calculators, it is possible, with only a few measurements to develop the shape of the most common of units. Such procedures of measuring and checking have almost unlimited potential.

c. Forms for Reporting

The need for and the design of forms for reporting are dictated by the problem at hand. Typical of such forms is Fig. 2-4. A similar form is shown in Fig. 2-5. This is for the reporting of measurements on the longitudinal bulkhead to which web frames must be assembled. When both of these forms provide information that is identical, a first time fit is assured.

d. Establishment of Unit Profiles

This is a procedure that can be very helpful in the determination of the finished shape of complex weldments such as innerbottom units. This procedure will receive greater elaboration further in this discussion.

3. Unit Histories

Unit histories are merely the methodical recording of all problems encountered in the production of a specific unit. This data is used in the development of procedures that will assist in the minimizing of the effect of any particular problem on subsequent units. This is particularly useful on multi-ship contracts,

III. ACTIVITIES DEMANDING SPECIAL EMPHASIS

A. GENERAL

Most of the benefits of a well coordinated Accuracy Control Department are applicable primarily to the Production Department. In the time available today, we will briefly explore some of these activities with an emphasis on the profound effect that they can have on an end product. The Accuracy Control program at ASI was started early in the production of a contract to build three APL Containerships. Techniques and procedures developed during that contract have been used on three Exxon product carriers and on various other contracts with increasingly effective results. Only a few areas of activity have been selected

for discussion at this time, not because they are necessarily of any greater importance than other activities, but rather because they more graphically illustrate the advantages that can be derived from the functions of an Accuracy Control program.

B. CONSTRUCTION SEQUENCES

It is probable that the most immediate and most positive improvement that can be achieved in the work process is through the development and implementation of properly conceived fitting and welding sequences. This is most surely a valid assumption in that the complete lack of such sequences can virtually negate all other improvements. A typical unit has been selected for minimal discussion at this time.

Unit No. 7, as we shall call it, is a fairly typical inner-bottom unit. (See Fig. 3-1.) Three major areas of heat introduction, in the form of welding, present the potential for building in stresses or actually deforming this unit:

- butt welds;
- vertical welds, floors to girders;
- welding of loose shell longitudinals.

Each of these types of welds presents a very distinct potential for deforming the unit. Without a well conceived construction sequence, a unit such as this one could very easily crown or deform as much as one inch from side to side. Such a sequence is an absolute necessity. (See Fig, 3-4.)

This procedure isolates and controls the three basic problem areas: butt welding of all shell plates, welding of all floors to girders, and welding of all loose shell longitudinals. The procedure in no way minimizes the heat introduction, but only permits it to shrink the components in such a manner as to minimize the potential for deformation.

C. CONTROL LINES, CONTROL POINTS (AND BACKSIDE MARKING)

Early in the production phase of the APL contract, it became evident that accurately located control lines on a unit would be advantageous in both the building and erection of the units. Figure No. 3-6 shows the layout on a typical innerbottom unit. The buttock is used for setting the unit athwartship and the frame line is used for setting the unit longitudinally. For this procedure to be practical, these lines must be located with unvarying accuracy. Current contracts incorporate these lines into the engineering drawings and panel line sketches that are used for building flats, decks, bulkheads, etc.

D. CONSTRUCTION AIDS

Many tools may be developed to assist the Shipfitting Department in completing accurately built units, but perhaps the one of greatest value is the erection joint tape batten. These battens indicate proper position of all structurals, seams, or sight edges at erection joints. Where utilized properly and in conjunction with other procedures, it is possible to locate structurals within a tolerance of one quarter inch or less. This procedure is used on all contracts at Avondale. Fig. No. 3-7 shows a backside marker. This piece of equipment permits the accurate transferral of centerpunch marks from the layout side of plating to the opposite side. Such accuracy is required if these lines are to be used for construction of the ship.

IV. DISTORTIONS OF UNITS

For the simplicity of discussion, we analyzed the unit in the form of a simple beam (see Fig. 4-1 and 4-2). Using a standard W36 x 194 beam, we derived the following comparison: the distortion from welding can be compared to simple beam action when the beam is loaded with a uniformly distributed load,

From the AISC Handbook on simple beams with uniformly distributed loads:

$$\max = \frac{5Wl^4}{384EI}$$

Where: max = maximum deflection in the vertical direction

w = load in kips/inch

L = length of the beam in inches

E = modulus of elasticity (30 x 10⁶ PSI)

I = moment of inertia in inches to the fourth.

If w = .5 k/in and l = 480" and I = 12,100 in⁴ for a standard W36 x 194 shape, then:

$$\max = \frac{5(.5 \text{ k/in})(1000 \text{ lb/k})(480 \text{ in})^4}{(384)(30 \times 10^6 \text{ lb/in}^2)(12,100 \text{ in}^4)}$$

$$\max = 0.9521 \text{ in} = 15/16''$$

We can easily measure the horizontal deflection, but the vertical deflection is more difficult to determine and is very important. To determine the vertical deflection that would occur as a result of the horizontal deflection, we need to derive some more formulas.

Horizontal deflection " Δ_H " caused by a force "P" can be described by the following formula:

$$\text{EQ.I } \Delta_H = \frac{Pl}{AE}$$

Where: Δ_H = horizontal movement of the shell

P = the force in the shell

A = cross sectional area of the plate

l = length (varies with the size and amount of tack welds)

E = modulus of elasticity.

Since stress " σ " = P/A

then EQ.I becomes

$$\text{EQII } \Delta_H = \frac{1}{E}$$

$$\text{but } \sigma = \frac{Mc}{I}$$

Where: M = moment

C = distance to the neutral axis

So: EQIII $\Delta_H = \frac{Mc}{EI}$ by substitution

Since $M = \frac{wl^2}{8}$

EQIV $\Delta_H = \frac{wl^3c}{8EI}$ also by substitution

To obtain the vertical deflection " Δ_V " in terms of the horizontal deflection " Δ_H ," multiply both sides of the following equation:

$$\Delta_V = \Delta_{\max} = \frac{5wl^4}{384 EI}$$

By equation IV

$$(\Delta_V) \frac{wl^3 c}{8EI} = \frac{5wl^4}{384 EI} (\Delta_H)$$

$$\Delta_V = \Delta_H \frac{(0.104)l}{c}$$

To prove this equation we substituted the values we used in the Δ_{\max} equation into our equation IV.

$$\Delta_H = \frac{wl^3 c}{8EI}$$

When: $w = .5k/in$

$c = 17.61 in$ (steel handbook)

$l = 480''$

$E = 30 \times 10^6 PSI$

$I = 12,100 in^4$

$$\Delta_H = \frac{(.5k/in)(1000 lb/k)(480 in)^3(17.61 in)}{8(30 \times 10^6 lb/in^2)(12,100 in^4)}$$

$$\Delta_H = 0.3353 inches$$

$$\Delta_V = \Delta_H \frac{(0.104)l}{c}$$

$$\Delta_V = (0.3353 in) \frac{0.104 (480 in)}{(17.61 in)}$$

$$\Delta_V = 0.9505 in = 15/16''$$

This compares with our earlier results of 15/16" in the equation for Δ_{\max} .

V. ORGANIZATION OF AN ACCURACY CONTROL DEPARTMENT

A. GENERAL

The most often asked questions concerning accuracy control are "How do you go about setting up an Accuracy Control Department?" and "what problems should receive the greatest initial emphasis?" Obviously, there is no positive answer to either of these questions since there are so many contingency factors involved. However, there are doubtlessly enough common problems prevalent in most U.S. shipyards to warrant an attempt at answering these questions.

B. THE SETTING UP OF AN ACCURACY CONTROL DEPARTMENT

1. Organizational Arrangement

The departmental organization of an Accuracy Control Department is no doubt subject to as many potential variations as are present in the organization of the shipyards themselves. It is probable that some advantages and some disadvantages will become evident regardless of what type of organization is instituted, but it is equally probable that a well-defined and well-instituted department will tend to minimize the disadvantages. Two basic approaches seem to be worth the greatest consideration:

- Department consisting of all full-time Accuracy Control engineers.
- Department consisting of a coordinating supervisor with representatives of the various departments accepting the accuracy control responsibility for their respective departments. While there may be many other approaches to organizational set-up, it is quite likely that they would be only variations of the ones listed above.

a. Department Consisting Of Full-Time Accuracy Control Engineers.

This type of organizational set-up has many advantages, particularly in the early stages of implementing an accuracy control program. The initial responsibilities of the department consist primarily of the definition of problems at hand and the development of procedures to help in the elimination or minimizing of those problems. Although it might not be immediately realized, it is a rare problem that has a single, simple solution that can be applied within that one area of work. Most such problems are merely the result of a specific human error and are not of

primary importance. to accuracy control. It is the interdepartmental problems or "system problems" that Accuracy Control is primarily interested in. An example of such a problem is the lack of well-defined uniform shrinkage factors. Without the development and utilization of such factors, it will be impossible to predict the accuracy of fits between components produced in different areas of the shipyard. This problem can best be solved by the concerted effort of several individuals, analyzing the problem at all levels, arriving at proper conclusions and then disseminating that information to all involved departments such as Moldloft, Numerical Control, Burning Shop, and Fab Shops or Platens. Since a problem of this nature involves so many departments and since the solution of many other related accuracy problems is contingent upon the timely solution of this specific one, it then may be deemed necessary to have the entire department concentrate on this one area of work until a viable solution is achieved. It would probably be more difficult to achieve the required concerted effort with other than full-time Accuracy Control engineers. Many of the problems with which the department will be confronted will demand this type of concerted effort to permit achievement of proper solutions without significant delay.

b. Department Consisting Of Coordinator And Part-Time Accuracy Control Engineers From Various Departments

The primary advantage of this form of organization stems from the familiarity that each of the part-time Accuracy Control engineers has with his own department. This degree of familiarity can result in both incisive conclusions and realistic solutions.

Perhaps the most realistic resolution is the initial development of a department consisting of a full-time supervisor with a group of full-time Accuracy Control engineers, the size of which would be determined by the size of the yard and the scope of the operation. As procedures are gradually and properly implemented, it would then be probable that most solutions would not require the concerted effort of the whole department but could be achieved through the coordinated efforts of two or three full-time Accuracy Control engineers working with part-time Accuracy Control engineers representing all departments.

QUESTIONS/ANSWERS

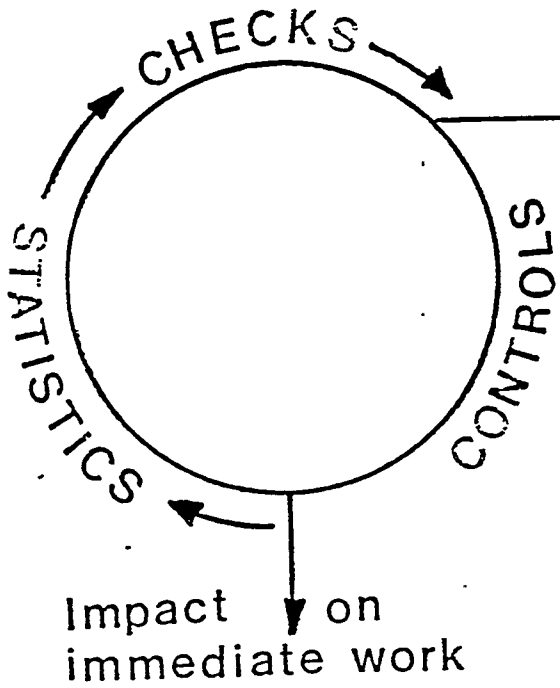

Fig. 1-1

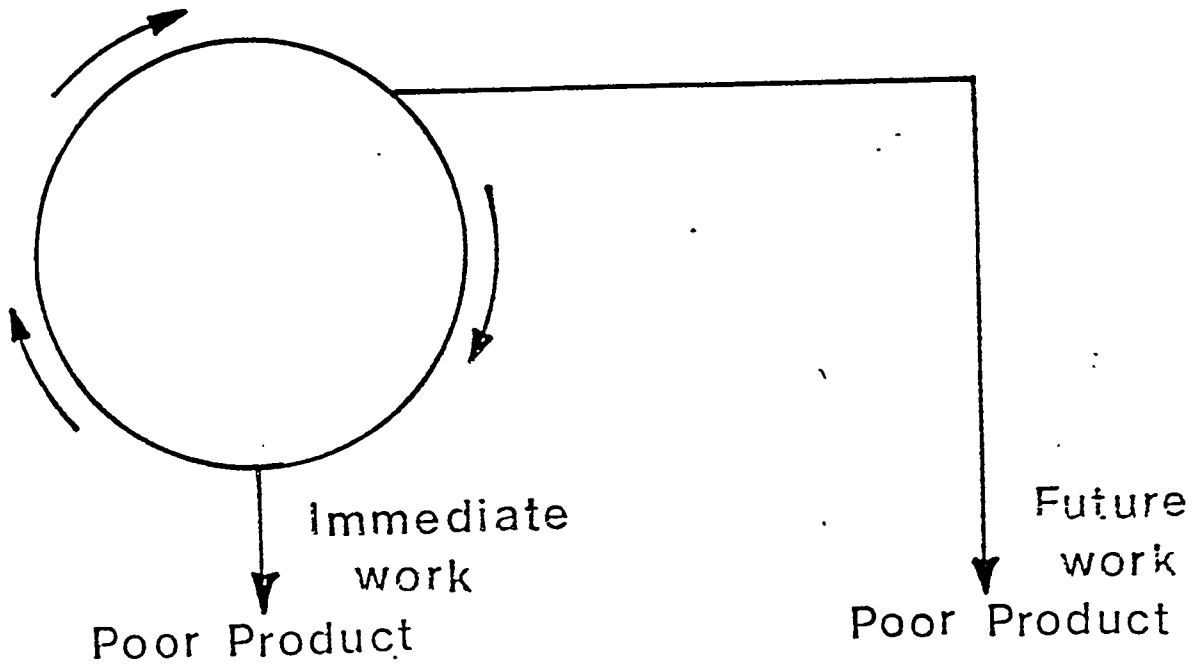

Fig. 1-2

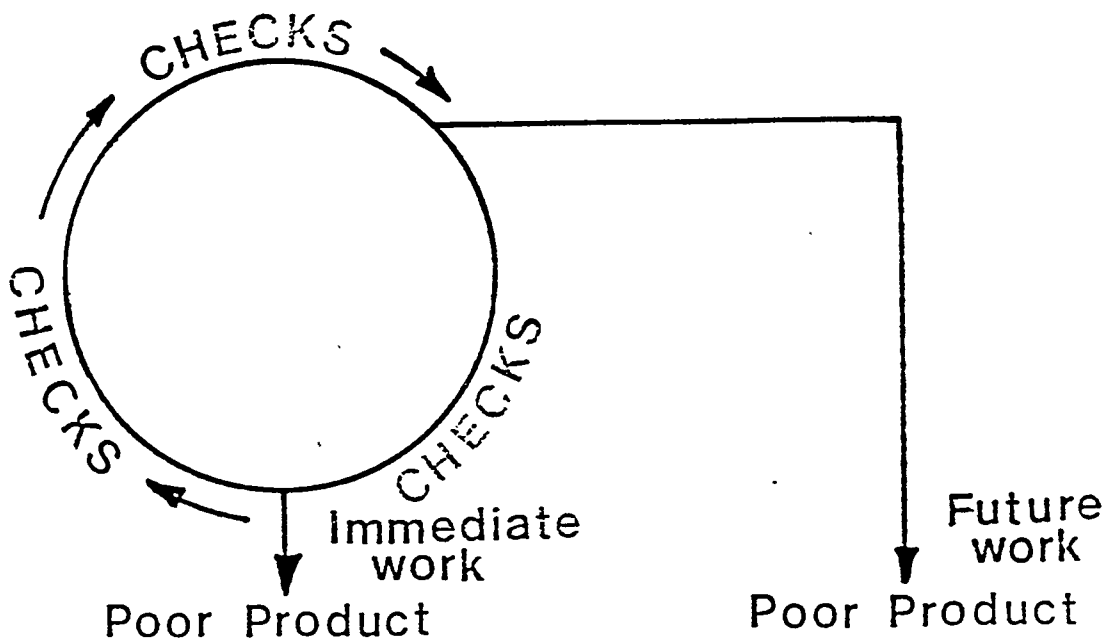

Fig. 1-3

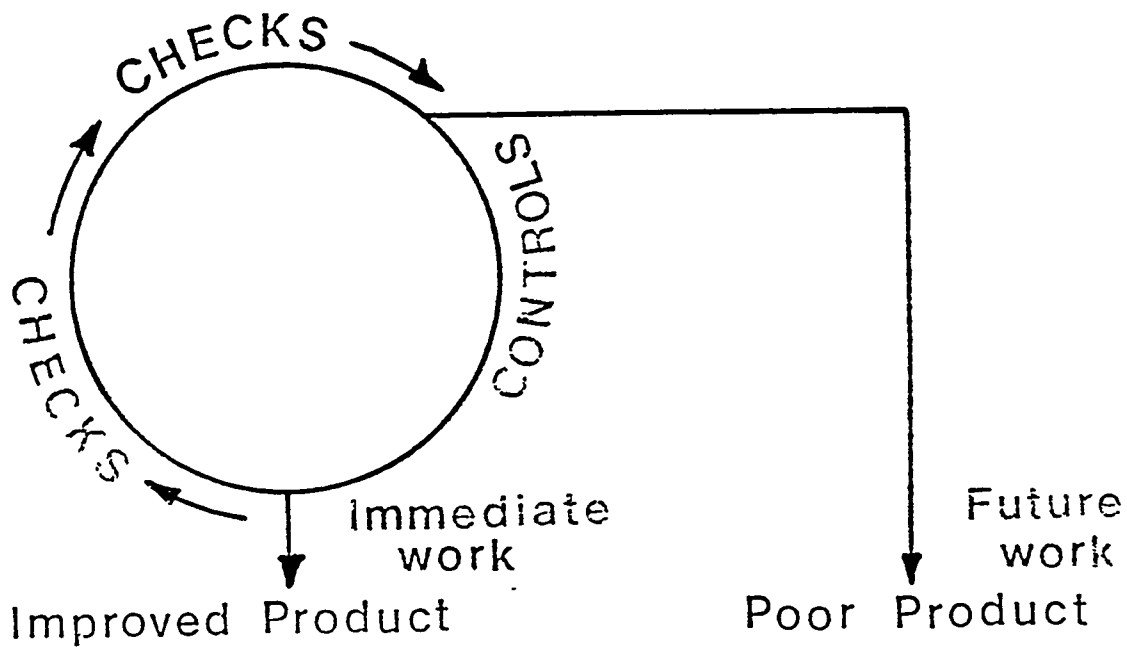

Fig. 1-4

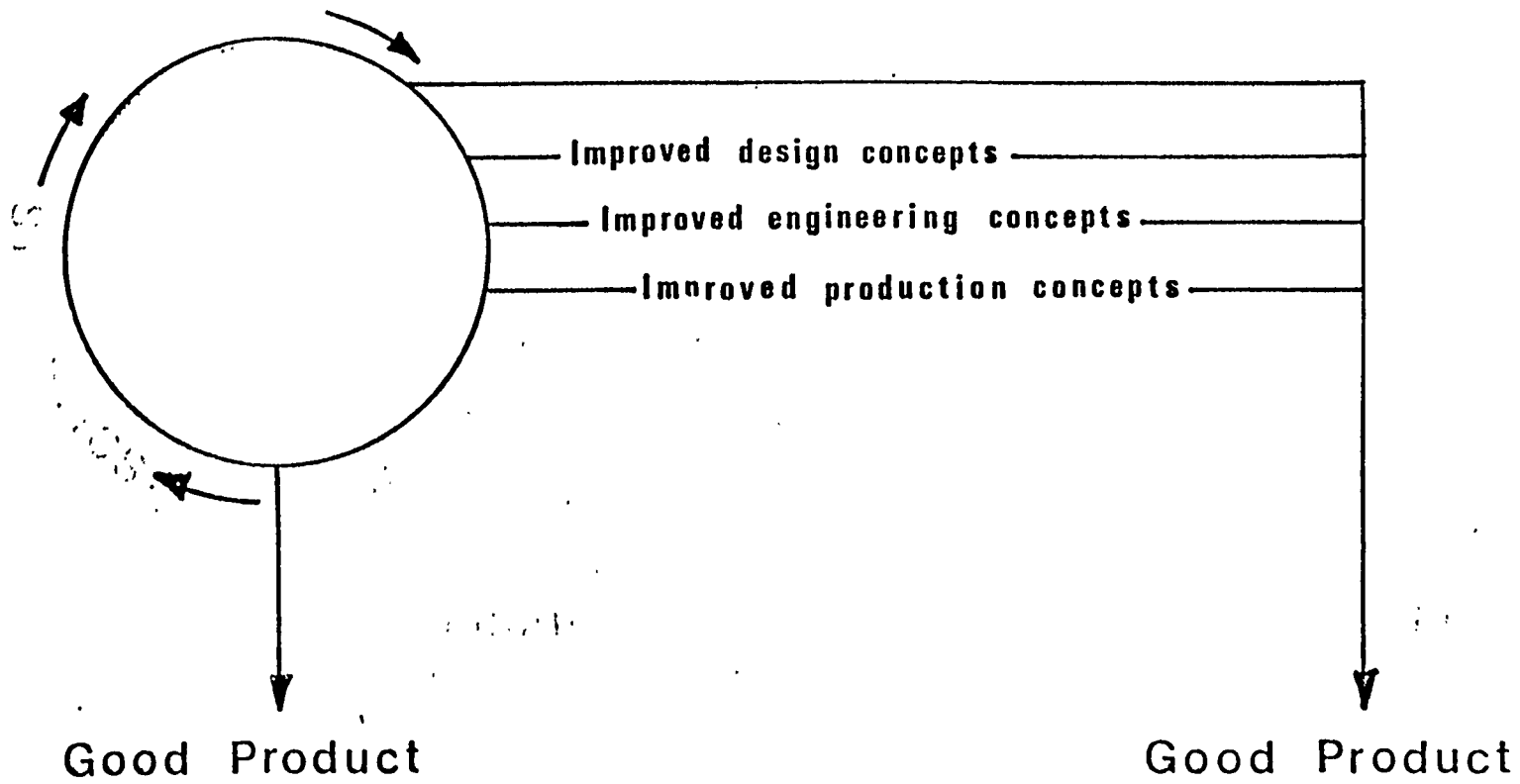

Fig. 1-5

2.0 Outline of Accuracy Control Activities

2.1 Controls

- A. Control Lines, Control Points and Backside Marking
- B. Burning Procedures
- C. Uniform Shrinkage Factors
- D. Construction Procedures
- E. Erection. Procedures
- F. Construction Aids

2.2 checks

- A. Measuring Procedures
- B. Mathematical Checking Systems
- C. Forms for Reporting
- D. Establishment of Unit Profiles

2.3 Unit Histories

- A. Engineering
- B. Mold Loft and Numerical Control
- C. Plate Shop
 - 1. Burning
 - 2. Panel Line
- D. Structurals
- E. Shipfitting
- F. Welding
- G. Handling
- H. Miscellaneous

Fig 2-1

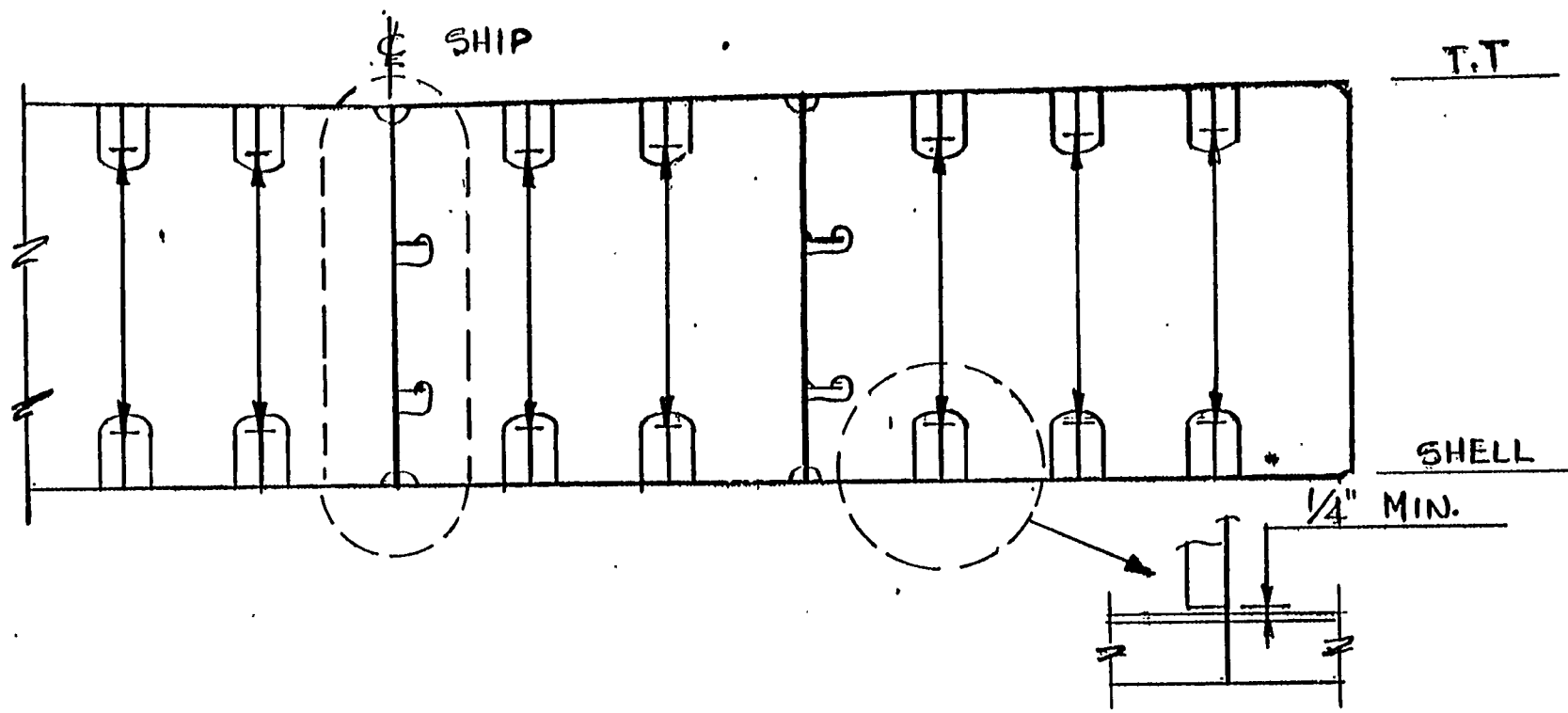

FIG. 2-3

Unit # _____
Web P.P. _____

Design dim. 44'-0"

Before butt welding

After butt welding _____

After stiff. welding _____

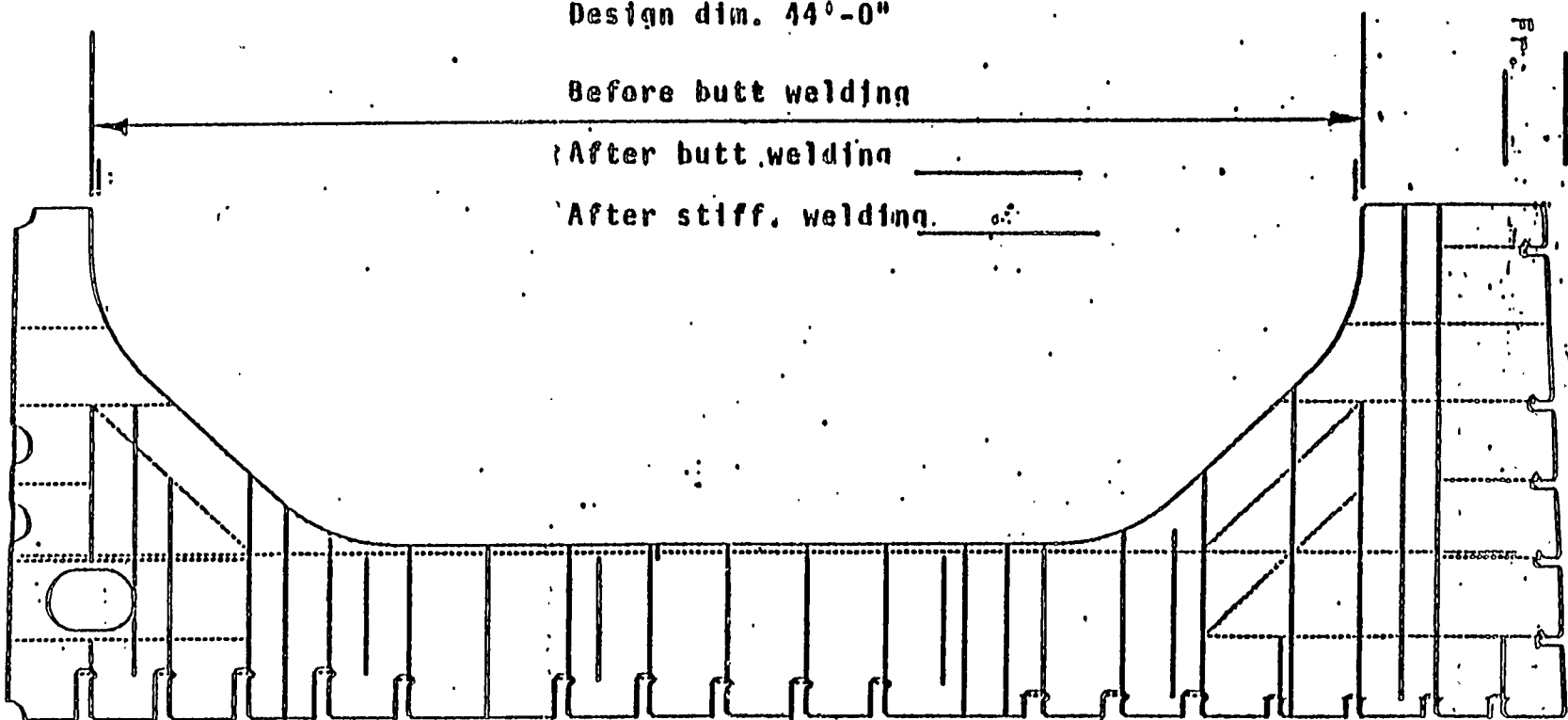

FIG. 2-4

Design dim. 54'-3 3/4"

Before butt welding

After butt welding _____

After stiff. welding _____

Long. Bhd.

Unit # _____

Before welding

After welding

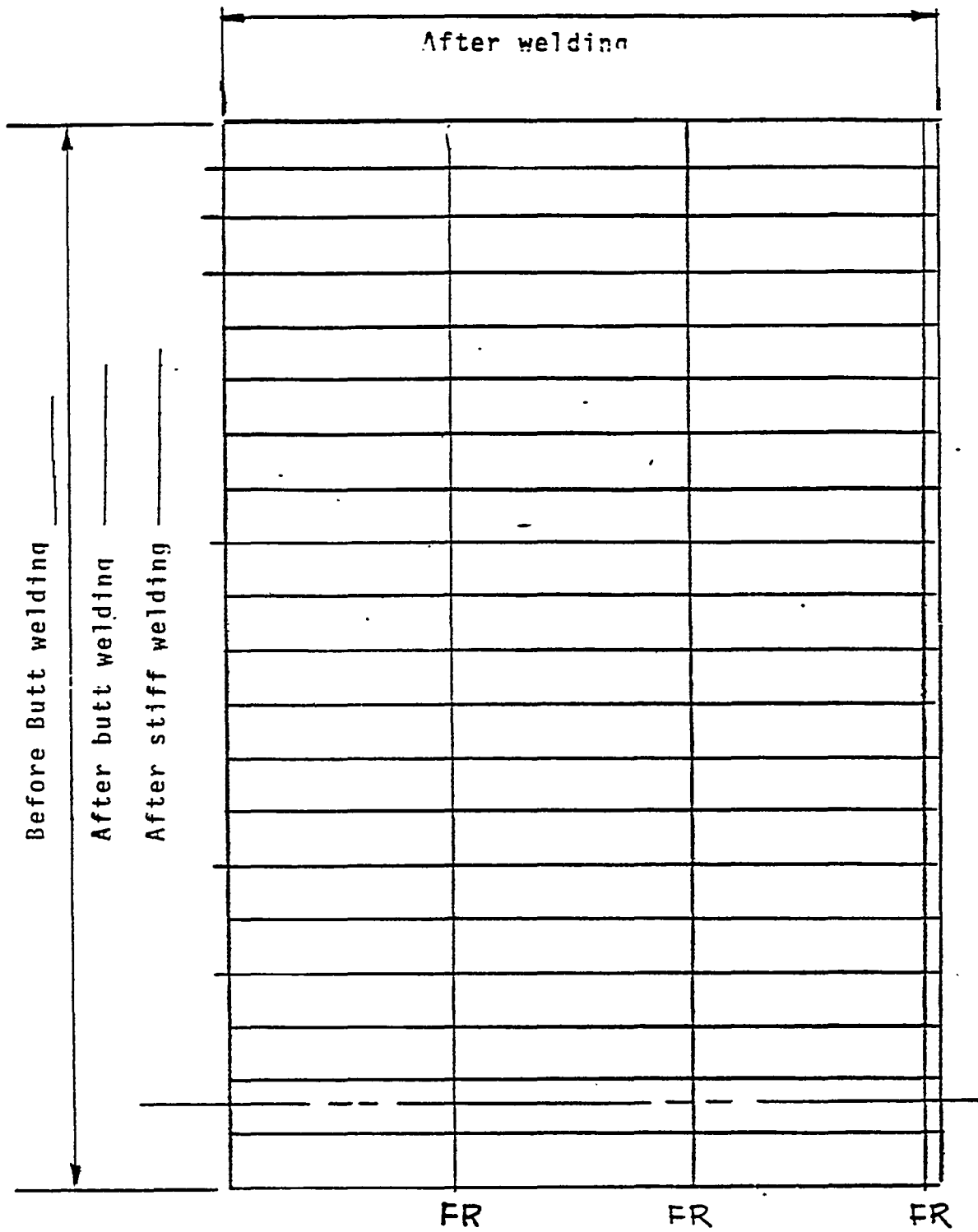
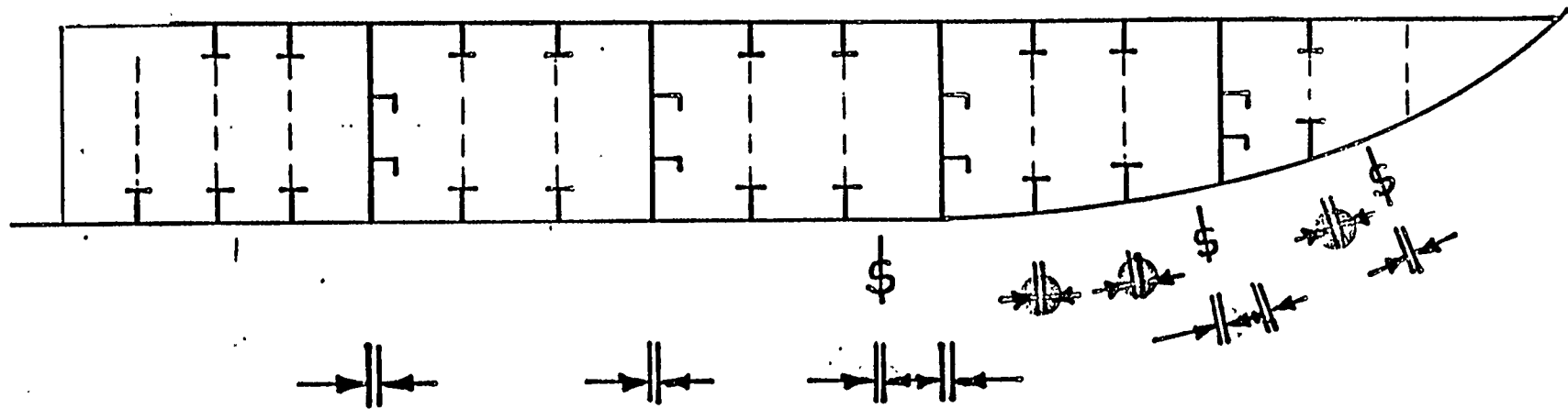

FIG 2-5



- Butt welds
- Vertical fillet welds
- Welds at longitudinals

Fig. 3-1

| Gdr. | Gdr. | Gdr. | Gdr. | End |

Fig. 3-2
Hull 1

| Gdr. | Gdr. | Gdr. | Gdr. | End |

Fig. 3-3
Hull 2

| Gdr. | Gdr. | Gdr. | Gdr. | End |

Fig. 3-4
Hull 3

Main Assembly Construction Sequence

1. Lay down tank top panels on platen.
2. Hang girders to which floors have been previously fitted and welded.
3. Pit girders to tank top. (2'-0" fwd. and aft. of each frame should left free of tacks)
4. Level unit. (Tack to platen w/clips)
5. Pit floors to girders. (Do not fit floors to tank top)
6. Weld all floors to girders, backstepping four times.
7. Fit floors to-tank top.
8. Flat weld all girders and floors to tank top.
9. Fit all stiffeners, collars, brackets, clips, etc. at tank top.
10. Weld stiffeners, collars, etc., at tank top.
Note: No piping to be installed prior to this stage of construction.
11. Hang and fit all loose shell longitudinals.
12. Weld clips or collars at shell longitudinals.
13. Hang and fit shell plate nearest to centerline of ship. (If this is a blanket, fit entire blanket, tacking to floors, girders and longitudinals)
14. Hang adjacent shell plate.
15. Weld shell plate butt.
16. Repeat procedure prescribed. in item #14 for each of remaining shell plates up to extreme outboard plate.
17. Hang extreme outboard shell plate. If shell longitudinals fall under this plate, fit as previously described. Otherwise fit shell plate to floors, utilizing welding clips. (Do not fit to floors) Do not fit to tank top at this time!
18. Weld last shell plate butt.
19. Fit shell plate to tank top.
20. Flat weld shell plate to tank top.
21. Turn unit right side up and finish fitting at shell.
22. Flat weld floors, girders and longitudinals and backgouge and weld butts.
23. Check ends of all girders and longitudinals for proper alignment with adjacent units. Fair if necessary.

Fig 3-5

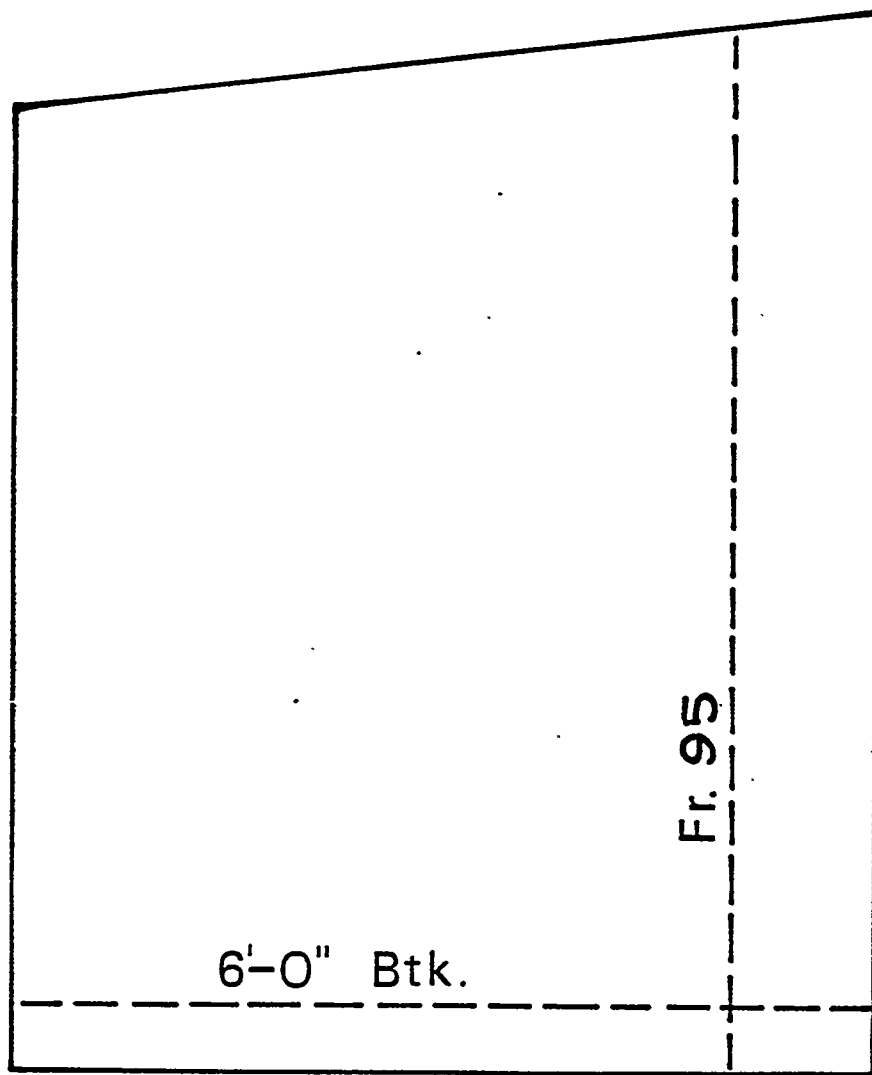

Fig. 3-6
Control lines on typical innerbottom
unit

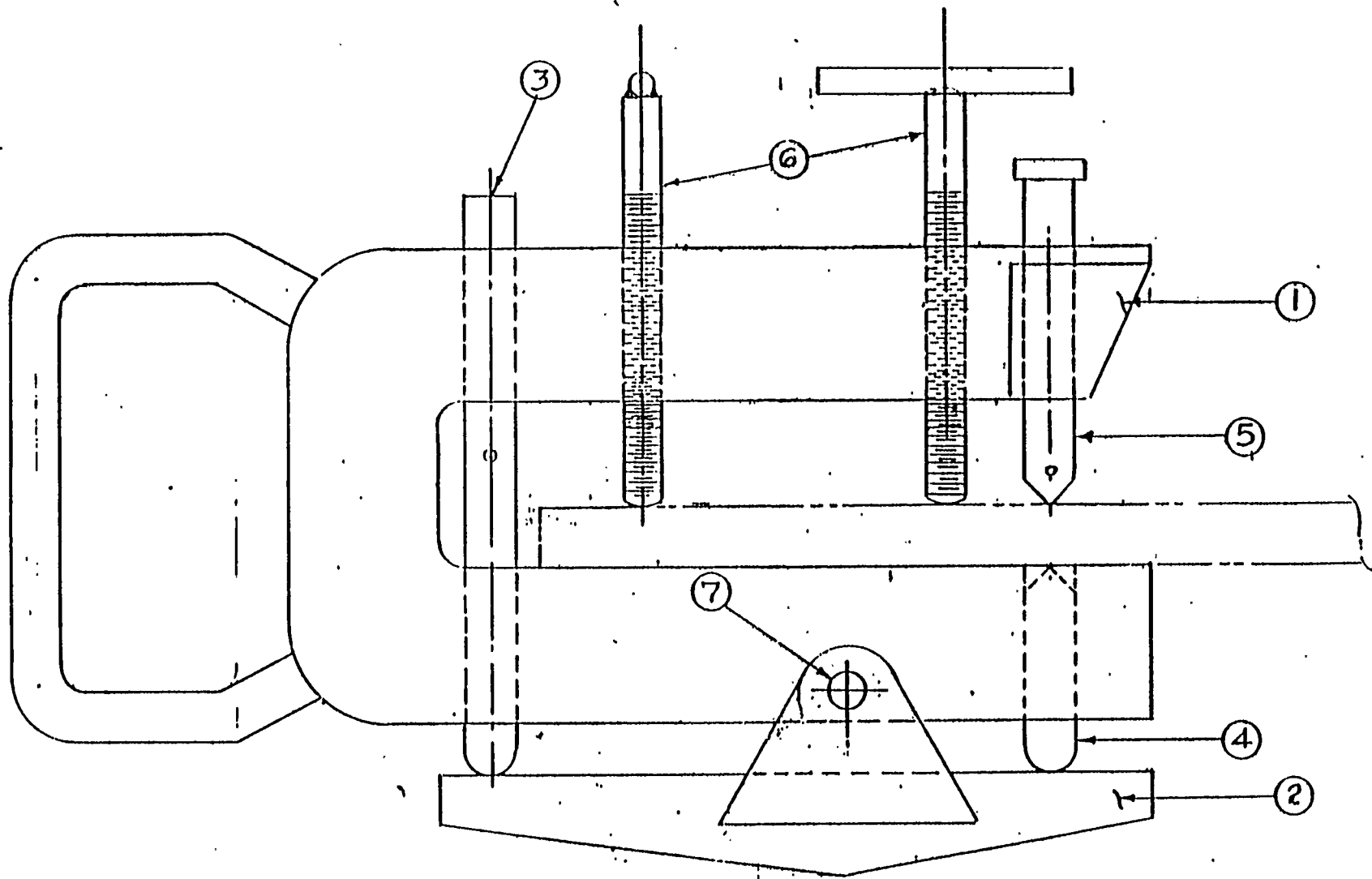

FIG. 3-7

BACKSIDE PUNCH

SH 1

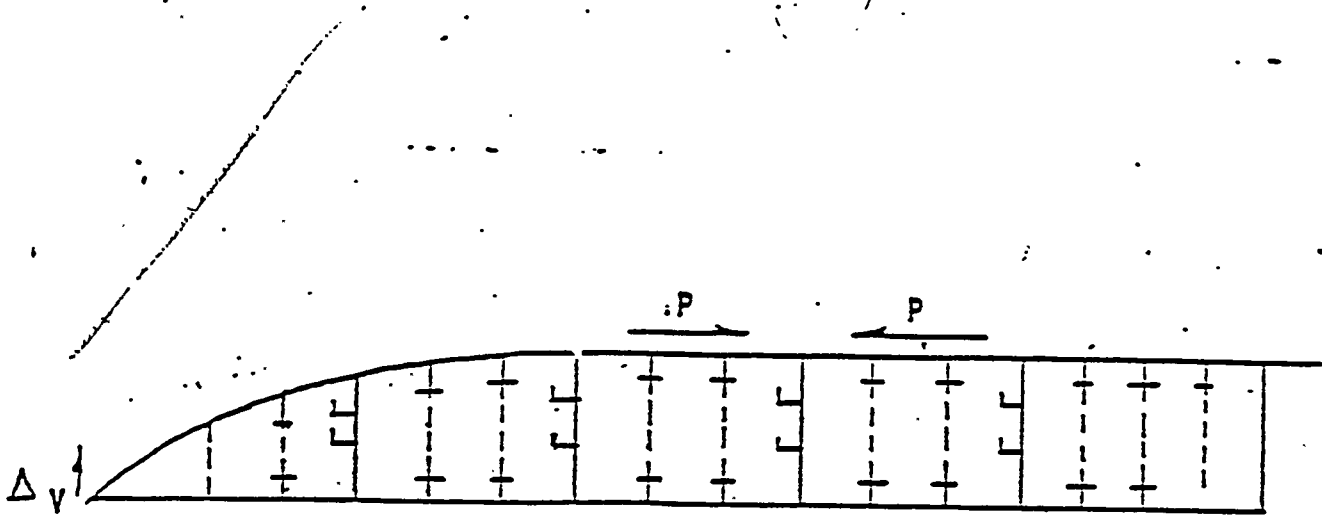

FIG. 4-1
TYPICAL INNERBOTTOM

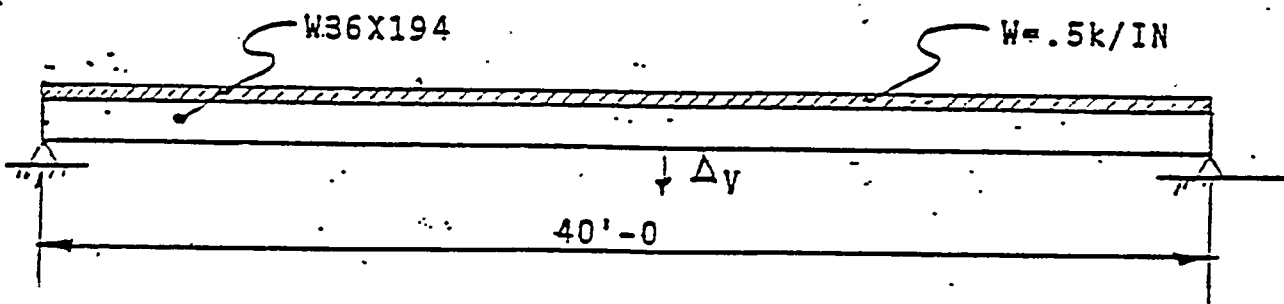

FIG. 4-2
SIMPLE BEAM

PROCESS LANES AND DESIGN ENGINEERING
FOR ZONE OUTFITTING
AVONDALE SHIPYARDS, INC.

DESIGN ENGINEERING FOR ZONE OUTFITTING

Prepared by: DR. J. R. WILKINS, JR.

PROCESS LANES AND DESIGN ENGINEERING
FOR ZONE OUTFITTING
DESIGN ENGINEERING FOR ZONE OUTFITTING

I. INTRODUCTION

Avondale's interest in zone outfitting technology goes back to the early seventies when a team of Avondale engineers went to Japan and Europe to investigate the techniques used by shipbuilders in those areas. Just prior to this, the Maritime Administration had conducted several investigations of world-wide shipbuilding practices and had provided seed money for shipyards to attempt to improve their own capability for decreasing shipbuilding costs. In 1974, Avondale signed a contract with Ishikawajima - Harima Heavy Industries Co. (IHI) to make an in-depth study of the way Avondale was building ships and to make recommendations to Avondale for things which could be done to improve productivity. As most of you are aware, the approach recommended by IHI required major changes to the existing sequence of construction and resulted in major changes to the type and timing of the design effort.

At the time of the last series of seminars which Avondale conducted under the National Shipbuilding Research Program covering the IHI Technology Transfer effort, Avondale's work on the Exxon multi-product carriers was well under way. This was Avondale's first "all out" effort at employing zone outfitting techniques. On this program, Avondale's production manhours have been significantly reduced compared to the manhours which would have been expended had the ships been built in the "conventional" manner. The reduction in production manhours have much more than offset the increase in engineering manhours. Although this part of today's seminar will look at the impact of zone outfitting on Avondale's design engineering activity, we need to always keep in mind that the primary emphasis of the implementation of zone outfitting technology is to reduce production manhours.

II. OVERALL IMPACT OF ZONE OUTFITTING TECHNOLOGY ON THE ENGINEERING DEPARTMENT

The impact of zone outfitting on Avondale Engineering has been significant and has affected all sections and disciplines. Figure No. 1 shows this impact in six important areas.

A) MODIFICATIONS TO ENGINEERING APPROACH

There have been a number of significant changes to the approach to development of drawings which have been either necessary or desirable to most effectively adapt to the revised techniques involved in unit oriented construction.

Analyzing the Engineering efforts during the detail design phase with respect to the processes involved yields the conclusion that there are three basic processes:

- 1) Final System-Level Design
- 2) Selection of Equipment
- 3) Fabrication/Installation Design

The time periods of Process 1 and Process 2 greatly overlap, while Process 3 must follow the other two (see Figure No. 2). The first of these is known at ASI as the Key Plan Stage, Key Plans are those necessary to define the system designs in sufficient detail to satisfy regulatory body and owner requirements, as well as to support the preparation of technical specifications for equipment and material procurement, In general, these phases are not conceptually different from conventional shipbuilding practice.

It is in the development of the fabrication and installation drawings that the approach to the design effort is significantly different. In the conventional approach, these drawings also were primarily system oriented. The entire firemain would be detailed in one drawing; another piping system would be shown in a separate drawing. Structural drawings were essentially presented to production personnel deck by deck, bulkhead by bulkhead, and frame by frame.

Zone-oriented engineering produces drawings which describe the units which will be built - not systems. The reason is obvious - the ship will be built unit by unit, so that's the way the production personnel need the information. That's the key to the whole philosophy of this design phase - the designers must be totally immersed in considering what information production people need at each stage of construction and in providing just that information in a format which is most useful to the production people. To do this, designers must have a complete understanding of precisely how each unit will be built and then configure the systems in each unit so as to simplify that installation. This is accomplished by having Production provide a detailed, written, unit-by-unit description of how each unit will be constructed, Joint meetings of Engineering and Production personnel are held on a weekly basis to discuss the optimum timing of installation of each system - and the engineering drawings reflect those agreements.

Composite drawings of areas and spaces are extensively employed subsequent to the key plan effort and preceding the installation drawing effort to develop system routing, assure maintainability requirements are satisfied, etc.

Fabrication drawings (pipe details, vent ducting, etc.) are developed unit by unit, rather than system by system, as a part of the installation drawing package. Component identification nodes identify not only the unit on which the component will be installed, but the stage of subassembly or assembly of that unit which defines the building site at which the installation will take place. Thus, the drawing becomes a material control document in addition to all other functions.

In a further effort to orient the design product to the production worksite, most ASI drawings now are produced in "booklet" form, meaning that we use many "C" size sheets rather than fewer large "H" size sheets to contain essentially the same information.

B) MORE DATA IS DISPLAYED ON EACH DRAWING

In order for zone outfitting to be successful, the Engineering Department must be closely involved with the methods and sequences of production that are to be used. The "Unit Breakdown Summary Sheet" produced by Production describes in detail the intended methods to be used to manufacture each unit. This methodology must be carefully studied by each Engineering section and reflected on the drawings they produce. It is not enough to know that a run of pipe or a valve will be located in a particular spot on a certain unit, the installer must also be told at what stage in the unit's assembly that the components are to be located. The information required by Production relative to when equipment and components are to be installed must be shown on each drawing.

Information concerning material control must also be reflected on the drawings. In addition, certain work previously left for field accomplishment is now reflected on the drawings. An example is the detailing of small bore pipe 3/4" to 2" which was previously field run.

C) NUMBER OF DRAWINGS PRODUCED IS SIGNIFICANTLY INCREASED

The preparation of drawings on a unit basis has greatly increased the number of drawings. As stated above, the total amount of information supplied is greater because of the added scope, but by no means is it in the same ratio as the increased number of drawings. Each drawing covers a smaller portion of the ship, as compared to the conventional

method. There are only a few very long "H" size drawings. Most of the drawings are of the booklet type.

If we were to count the number of drawings in the plan schedules for two similar ships at Avondale, the zone outfitted ship would have about twice as many drawings. The major reason for this is in the method of presenting the piping work. There are about three times as many piping plans for the zone-outfitted ship. This is because a piping arrangement drawing which may apply to two units is accompanied by two pipe detail drawings and two lists of materials, one each for each unit. Previously, the arrangement drawing would have included more units and would be accomplished by one one pipe detail booklet and one list of material. The change is necessary because the pipe is fabricated by unit, then stored by pallet code to await installation. The list of material must be by unit to suit the pipe fabrication sequence.

D) PACKAGE UNIT GROUP ESTABLISHED

Some reassignment of work in the Engineering sections was necessary to better equip the Avondale Engineering Department to accomplish zone outfitting; however, there was no major reorganization. The most significant organizational change was to establish the Package Unit Group in the Mechanical Engineering Section. This group develops complete machinery package units for the machinery space. They detail the equipment foundations, gratings and hand-rails, as well as the piping, instrumentation, etc. IHI consultants had recommended to Avondale management an engineering organization similar to theirs. Figure No. 3 shows the basic engineering organization utilized by IHI. It consists of four Engineering Groups: Deck, Machinery, Accommodation, and Electric. Such a change was not considered necessary at Avondale. Functionally, however, our current organization embodies some of these concepts. Examples are as follow:

- The newly established Package Unit Group handles all aspects of the Package Unit design.

Our Outfitting Section essentially controls the arrangement and routing of all systems in the accommodation areas .

- The Mechanical Section controls the routing of all systems in the machinery space.
- The Hull Section still handles the steel superstructure and machinery space structure, except for the Package Unit foundations and support structure which is handled by the Package Unit group.

- The output of the Hull Section is the Yard Plans which are used by the Mold Loft to produce the working drawings.

These procedures are very similar to the IHI concept. Regardless of the organization or how it is constructed, the most necessary ingredient is effective communication.

E) SCHEDULE ADHERENCE BECOMES CRITICAL

Under the conventional system approach, a particular drawing had a production required date based on when Production intended to start work on that system. Production work on the entire system may have spanned a considerable length of time. Under zone outfitting, the same amount of production work will be portrayed on many drawings. Each drawing, however, has a much more critical issue date since work on that portion of the system is closely knit into the pre-outfitting plan. This means that Engineering must very effectively plan the start, the progress, and the issue of all drawings and the support activities necessary to provide the information needed for developing these drawings. The Engineering Planning and Scheduling Section has been expanded to effectively handle this task.

F) OVERALL WORK SCOPE INCREASED

The use of zone outfitting at Avondale has increased the scope of the engineering job and, consequently, the engineering costs. However, it has been demonstrated that this increase has been more than offset by savings in man-hours and time in production. This first use of zone outfitting in engineering involved a considerable learning period. Many operational procedures were established only through painstaking investigation and some trial and error. These costs will not be repetitive.

The next zone outfitting engineering job, the T-AO'S for the U.S. Navy, has benefited greatly from our experience here. As we improve these methods and as all concerned become more familiar with the system, we expect that less information will be required from Engineering. It is also intended that many of the methods and details developed for this first job will become a standard on future jobs, thus reducing the engineering costs. It is anticipated that, as methods are standardized and improved over several jobs, the engineering costs may actually become equal to those under conventional methods. Of course, the savings in Production will also improve as their techniques are further refined.

III. EFFECTS OF ZONE OUTFITTING TECHNOLOGY COMMON TO ALL ENGINEERING SECTIONS

Let us now turn to a look at some of the specific effects of zone outfitting technology on the various Avondale Engineering sections. A number of these were common to a greater or lesser degree to all of the sections. Figure No. 4 lists six of these effects .

A) ENGINEERING EFFORT MUST BEGIN AND BE COMPLETED EARLIER THAN IN CONVENTIONAL DESIGN METHODOLOGY

It is extremely important to recognize the overall scheduling concept associated with unit and zone outfitting to understand the combined impact on the engineering scheduling effort. Firstly, it is expected that the total construction period from keel laying to delivery for a unit outfitted ship, as compared to a conventionally constructed vessel of comparable configuration, will be significantly reduced, enabling the shipyard to offer a quicker delivery with the vessel cost less subject to added escalation. This savings in time is generally applied to the total contract time with theoretically no impact on the engineering lead time. HOWEVER, the system of unit outfitting and other production techniques also dictate that a far greater stage of overall work completion be achieved at time of keel laying, necessitating the start of pre-fabrication several months further in advance of the keel laying date than in conventional construction methods, resulting in a shortened engineering lead time. The unit outfitting methodology also requires that a far greater level of engineering be complete at the start of pre-fabrication such that all possible work is accomplished on-unit.

We have adopted the phrase, "engineering essentially complete" to illustrate our overall scheduling goal at time of pre-fabrication. Typically, we have seen the percentage of total engineering manhours spent at time of pre-fabrication increase from approximately 50% in a conventional construction system to approaching 75% in a fully unit outfitted concept.

The net effect of the overall vessel scheduling is a far greater level of engineering effort to be accomplished in a far shorter period of time. This fact is clearly illustrated on Figures No. 5 and No. 6.

B) ROLE OF THE ENGINEERING AND PRODUCTION ORGANIZATIONS AS PARTNERS MUST BE STRESSED

It is a universal objective for all large industries to achieve a true team spirit among the various departments, especially between Production and Engineering. Such cooperation leads to time, labor, material, and thus to dollar savings. While this objective is desirable for all ship-builders, it is an absolute necessity for those who employ or seek to employ zone outfitting technology.

The demands of zone outfitting require extremely close cooperation among all facets of shipyard operations, and the early involvement of Production Planning in the design effort. In the zone outfitting system, a drawing listing cannot even be compiled by Engineering until such time as the hull unit construction arrangement is defined. And the material need date for the same piece of equipment can vary as follows, depending on construction method:

<u>CONSTRUCTION METHOD</u>	<u>MATERIAL NEED (MONTHS)</u>
On-Board	17
On-Unit	14
Package Unit	12

C) ENGINEERING DRAWINGS ARE DEVELOPED AS UNITS, NOT AS SYSTEMS

This concept is, of course, seminal to zone outfitting technology. Prior to zone outfitting at Avondale, almost all engineering drawings were developed to describe a single system or entity such as: the Main Deck, Transverse Bulkheads, Bilge and Ballast System, Fire Main System, etc. This systems approach was adequate for the production philosophy where the ship was built in sections and these sections assembled into a complete hull before most of the outfitting material was installed. Production work was steel-work oriented, and piping and other outfit material were added only after the hull was complete. However, with zone outfitting, Production is supplied with unit drawings that depict all the systems that are to be installed in each unit.

D) STRUCTURAL "KEY PLANS" (ARE USED IN DRAWING DEVELOPMENT

Structural key plans are very detailed scantling plans that show all aspects of the vessel's structure. The vessel is divided into three main divisions with each division having its own key plan. The first area is the forward structure from the stem to the collision bulkhead; the second is the cargo hold structure between the collision bulkhead and forward machinery bulkhead; and the third is the after body

peak structures, All frames, bulkheads, decks, flats, stringers, stiffeners, shell plates and major penetrations, along with most major equipment foundations, are included on each respective key plan.

The primary purpose of the key plans is to provide a document depicting all details related to the vessel's major structural components for use by all departments, both Engineering and Production, in their own respective functions or tasks related to the shipbuilding effort. For example, the Hull Drafting Section uses the data shown to develop the yard plans or unit drawings. The Piping Section uses the plans to locate major interferences of their piping runs. Production Planning uses the plans to aid in the unit breakdown development. Since the key plan is a tool for other departments, the drawings must obviously be completed very early to allow the accelerated Engineering completion dates to be met. This obviously requires all support tasks necessary for the development of the key plans to likewise be completed earlier.

E) MATERIAL ON DRAWINGS MUST BE "PALLET CODED"

Each unit drawing must contain only that information necessary to do the desired job at the planned time. The designer must also consider the physical progress of the surrounding area at the time of installation. It is very important that the drawings reflect the agreed upon construction sequence, since they also control the flow of material. Portions of piping systems, manholes, ladders, reach rods, wireway hangers, etc. may require installation as a particular unit is being constructed, maybe before the unit is complete or before it is painted. The drawing reflects this by specifying when the material or component is installed. This specification is called a pallet code. Each piece of material is pallet coded. The Material Control Section of Production uses the pallet code information to assemble all material to be installed at a particular time and routes it to the exact location for installation. The importance of the pallet code cannot be over-emphasized, since it controls the flow of material. In zone outfitting, the flow of material basically controls the cost of the job. Figure No. 7 is an example of the Pallet Code System used at Avondale.

The pallet code is basically an eight-character designation. The first two characters represent a craft labor cost code. The middle three characters specify the unit number for material to be installed on unit, or the zone for material to be installed on board. The sixth and seventh characters are the pallet serial number. The last character in the code indicates the stage of construction at which time the material will be installed. To assist Production in

the control of material, each drawing on the title page has a tabulation of the pallet codes contained on the drawing. Figure No. 8 is an example of this tabulation.

F) ADVANCE ORDERING ON LONG LEAD MATERIAL IS EMPHASIZED

It is, of course, a prime concern of any shipbuilder to identify, specify and purchase long lead materials as soon as possible. The implementation of zone outfitting makes this task critical. The design effort depends on the receipt of vendor information at an early date, and zone outfitting production schedules require earlier-than-conventional receipt of material and equipment. This can only be achieved if each engineering discipline becomes involved with the ordering of long lead material at contract start or sooner.

IV. UNIQUE EFFECTS OF ZONE OUTFITTING TECHNOLOGY ON THE ENGINEERING SECTIONS

Some of the effects of zone outfitting technology were experienced uniquely by the Engineering sections. Following is a look at some of these effects on five of the sections.

A) HULL TECHNICAL AND DESIGN SECTION

Figure No. 9 shows some of the unique effects of zone outfitting technology on the Hull Technical and Design Section.

The Design Section is composed of naval architects, civil engineers, computer programmers, weight programmers, and drafting support personnel. The responsibility delegated to the Design Section under the conventional shipbuilding system is the design and preparation of midship sections and associated scantling plans, fairing of lines, naval architectural calculations and drawings, weight estimates, and support functions for other sections on an "as-needed" basis.

1) Development of Structural Key Plans

This function was discussed in Section III under the effects common to all sections. It is mentioned here because it is the Design Section which develops the structural key plans.

2) Creation and Maintenance of the Data Base

This function was the responsibility of Production's Mold Loft under the conventional system. The data base is a storehouse of information that, through the use of designated computer programs, defines all structures within the vessel inclusive of the vessel's shell contours. The data base is developed or created in a systematic manner starting with the definition of the vessel's final faired lines. Then, surfaces such as decks and bulkheads are added, along with shell longitudinals, traces and shell seams. This data base is updated and maintained through the span of the contract to reflect any and all developments that occur as production proceeds.

The data contained within the data base is used to develop computer prepared drawings. Any frame bulkhead or deck contour can be retrieved and drawn depicting the associated stiffeners. Once the drawings have been developed and the data base verified, the data is used to control the N/C burning machines in the Plate Shop, the generation of templates, bending of frames, etc.

3) Review of Yard Plans

Once the key plans are issued, the Hull Section uses them to develop the yard structural plans or "yard plans" that are sub-divided into each particular hull construction/erection unit. These unit drawings are complete with the smallest detail shown and defined to allow the preparation of the unit parts list, "UPL'S," from which the Mold Loft prepares the unit construction manuals, "UCM's." The UCM'S are the documents from which the steel is nested, marked, punched and burned within the construction sequence. Therefore, in order to assure the accuracy of the data released to Production, the Design Section reviews the unit drawings to verify that all details are in accordance with the intended design and latest developments.

4) Increased Role in Production/Engineering Liaison

Since the Design Section is responsible for the development of the key plans, questions and problems that arise during development of yard plans and N/C burning are channeled through the Design Section for resolution. Although this is not a new function of the Design Section, the amount of day-to-day involvement has intensified due to the increased detail of the actual design work now undertaken. Also, since the data base maintenance requires daily involvement, the flow of input to and from the Design Section has increased drastically.

B) HULL STRUCTURES SECTION

Figure No. 10 shows some of the unique effects of zone outfitting technology on the Hull Structures Section.

Prior to the introduction of zone outfitting at Avondale, the hull structural drawings were developed and presented to the Production Department utilizing a system-by-system approach. The drawings were developed presenting the decks as a system, the shell as a system, the web frames as a system, and so on.

The system-by-system approach presented the entire shell, deck or longitudinal bulkheads to the Loft, from which the various structural units had to be extracted. The system-by-system drawings did indicate the unit breaks or erection joints, but the individual unit's demarcation lines and extent was not so discernible graphically. Additionally, the system-by-system approach required the user to possess other system plans in order to obtain the knowledge of all of the components of a particular unit. Many reference plans were necessary.

1) Arrangement Drawings (Yard Plans) Developed From Key Plan Rather Than From Scantling Plan

As the Hull Technical and Design Section develops the structural key plans, the Hull Structures Section uses them to produce the yard plans. Because the structural key plans are more detailed than the conventional scantling plans, the Hull Technical and Design Section assumes more of a role in the detailed design effort.

2) More Through Detailing of Penetration Locations on Yard Plans

Penetrations in structural components, due to piping, ventilation, mechanical and electrical routings, are presented in the yard plans when those penetrations fall into either one of two categories: penetrations requiring structural reinforcement, and those that can be cut by numerical burning.

Until the advent of zone outfitting, only the penetrations that required structural reinforcement were shown. Zone outfitting technology has provided for earlier identification of system routings, with the attending benefit of being able to include those penetrations into the yard plans .

3) Incorporation of Process Lane Notation on Yard Plans

The concept of process lanes has been incorporated into the yard plan. The notations for the various structural components, designating them as sub units, partial sub units, combined partial sub units or just individual pieces to be left loose until assembly or erection, are a function of the area or location of their manufacture.

This designated manufacturing location is one of the basic concepts of the Process Lanes principle. The yard plan notations are obtained from the Unit Breakdown Summary Sheet. By knowing the meaning of the process lane coding notations, one can determine the location of manufacture of a particular structural component.

c) MECHANICAL DESIGN SECTION

Figure No. 11 shows some of the unique effects of zone outfitting technology on the Mechanical Design Section. Because the Piping Design Group of the Mechanical Design Section produces systems diagrams, the effects of zone outfitting which other sections have experienced have not been as intense for this section. However, there have been at least a couple of primary effects on the Mechanical Design Section.

1) Pipe Line Identification Added to Piping Diagrams

The Mechanical Design Section has developed a standard practice for identifying pipe lines, piping materials and piping components. The identification numbers appear on diagrams, ADCS's, composites and working drawings and allow for traceability of any line or component from the diagrams through the pipe details. This traceability is important because with zone outfitting, unit drawings are produced which depict a number of systems on each unit drawing.

2) Equipment/Component Locations Added to Piping Diagrams Rather Than to Arrangement Drawings

Again, because of the depiction of a number of systems on each unit drawing, the systems diagrams have been designated to show the exact location of all equipment and components for each system.

D) PIPING AND HVAC SECTION

Figure No. 12 shows some of the unique effects of zone outfitting technology on the Piping and HVAC Section.

The advent of zone outfitting technology has had many far-reaching effects on the operations of the Piping and HVAC Section. This is due to the fact that perhaps no other engineering section was as "systems oriented" as was Piping and HVAC prior to zone outfitting.

1) Utilization of Advanced Design Composite Studies (ADCS)

For over twenty years, Avondale's Machinery Composite Group has provided the primary design for machinery space and main deck arrangements. These composites are not merely interference checks, but are used to provide the arrangement groups with completely routed systems for working drawing development.

Basically, the procedure for machinery composite development has remained the same with zone outfitting. The composites are done at 1/2" to 1" scale, depending on area, and are divided into the required plan and section views to clearly represent the area depicted. The composites show all systems within the machinery space including piping, HVAC and wireways, as well as outfitting items such as ladders, gratings, and so on. Figures Nos. 13, 14 and 15 are various views of a machinery space composite recently developed. The major difference between composites now and before zone outfitting is the manner of presentation to the arrangement group. Before, an entire system was routed on composite and then forwarded to the arrangement group for development into working drawings. Now, the composite group routes all the systems within a particular unit and then forwards that unit to the arrangement group.

Another difference between the traditional and the new composites is that now the unit breaks are clearly shown on the composites. This is to ensure that machinery is not located on the break lines and to ensure that allowance is made for flanging make-up pipe pieces to bridge unit breaks after erection.

Since machinery spaces are developed from the lower levels on up, the obvious problem with zone outfitting is to be certain that all systems in a given unit have been routed prior to issue to the arrangement group. Avondale's answer to this problem is what we call the Advanced Design Composite Study or ADCS. The ADCS is a 1/2" scale single line routing of all systems in the machinery space, main deck, or other congested area of the vessel. It took approximately six weeks for the "preliminary" ADCS to be developed for the Exxon multi-product carriers and approximately three months for the final ADCS to be developed. This, of course, required that vendor information and contract drawings were ready at the start of ADCS development. It also

required that top notch designers were available to handle the assignment. Figures Nos. 16 and 17 are two views of the ADCS which was done on the above-mentioned Exxon carriers.

2. Creation of the Package Unit Group

The creation of this group was mentioned in Section II as it pertained to the overall impact of zone outfitting technology on the Engineering Department. It is mentioned here, because the Package Unit Group is a part of the piping and HVAC Section.

Although Avondale has built package units in the past, the effort on the Exxon multi-product carrier was the most comprehensive to date and certainly the most successful. One of the major factors in the success of the package unit program was the construction of the Machinery Package Unit Assembly Shop, a large shop with overhead cranes, a clean environment in which to work and so on. The rapport that has been established between the shop foreman and Engineering personnel is excellent. A good many more engineering manhours beyond our original projection have been expended on package unit development; however, reports from the shop indicate that a Production manhour savings in the neighborhood of 15% may have been realized. Not bad for a first effort.

There are two basic types of package units. First, there is the custom built type which is designed to suit certain conditions of the vessel being designed. These package units will differ from design to design and are usually found in congested areas such as the lower level of the machinery space. The Bilge and Ballast Pump Package Unit is a good example of this type of package unit. The other type of package unit is the standardized type such as the Fuel Oil Pump Package Unit. These package units are suitable for reuse on other jobs and are usually found in less congested areas such as the upper levels of a machinery space. Of course, the ultimate goal should always be to design package units such that they are reusable.

3. Development of Pipe Rack Drawings Depicting Structure as Well as Piping

Figure No. 18 is a tank heating coil assembly. The Piping Section is called on to design not only the heating coil itself but also the structure used to support it. This blending of disciplines is really a hallmark of the zone outfitting philosophy which emphasizes concentrating as much design effort in a given group or section as is technically possible. Figure No. 19 is the detail of the pipe rack structure.

The main deck rack drawings for the present Exxon contract were developed from composites similar to those prepared for the machinery space area which were then divided into three zones with six to eight racks in each zone. Each rack contains sections of pipe together with the necessary supporting structure, walkways, and gratings. It is quite an improvement to assemble the rack completely outfitted and lift it in one piece aboard ship, as opposed to the traditional procedure of assembling pipe structure on the ship and then adding the pipe, piece by piece. As with the tank heating coil drawings discussed above, the Piping Section is responsible for developing the rack structure, as well as the pipe routing and detailing. The Outfitting Section provides the ladder and grating drawings for the racks.

4) Addition of Pipe Shop Work Station Routing and Coating Procedure to P/D'S

Each unit, machinery package unit, and main deck rack contains a piping detail drawing (P/D). The procedure for producing P/D's under zone outfitting has not changed a great deal from the traditional method with which these drawings were prepared. The major difference really is the addition of the pallet code number and the attention that is paid to Pipe Shop work station routing and coating procedures. The routing and coating information is the result of (a) adapting to Avondale's new semi-automated Pipe Shop to accommodate zone outfitting technology, and (b) the need for more accurate computer-aided scheduling required for zone outfitting.

E) OUTFITTING SECTION

Figure No. 20 shows some of the effects of zone outfitting technology on the Outfitting Section. They are self-explanatory and are primarily the result of the Outfitting Section having to perform certain design development in a much earlier time frame than under conventional design methodology.

QUESTIONS/ANSWERS

IMPACT OF ZONE OUTFITTING TECHNOLOGY ON ENGINEERING DEPARTMENT

- **MODIFICATIONS TO ENGINEERING APPROACH
(FABRICATION/INSTALLATION DRAWINGS ARE
NO LONGER SYSTEM-ORIENTED)**
- **MORE DATA IS DISPLAYED ON EACH DRAWING**
- **NUMBER OF DRAWINGS PRODUCED IS
SIGNIFICANTLY INCREASED**
- **PACKAGE UNIT GROUP ESTABLISHED**
- **SCHEDULE ADHERENCE BECOMES CRITICAL**
- **OVERALL WORK SCOPE INCREASED**

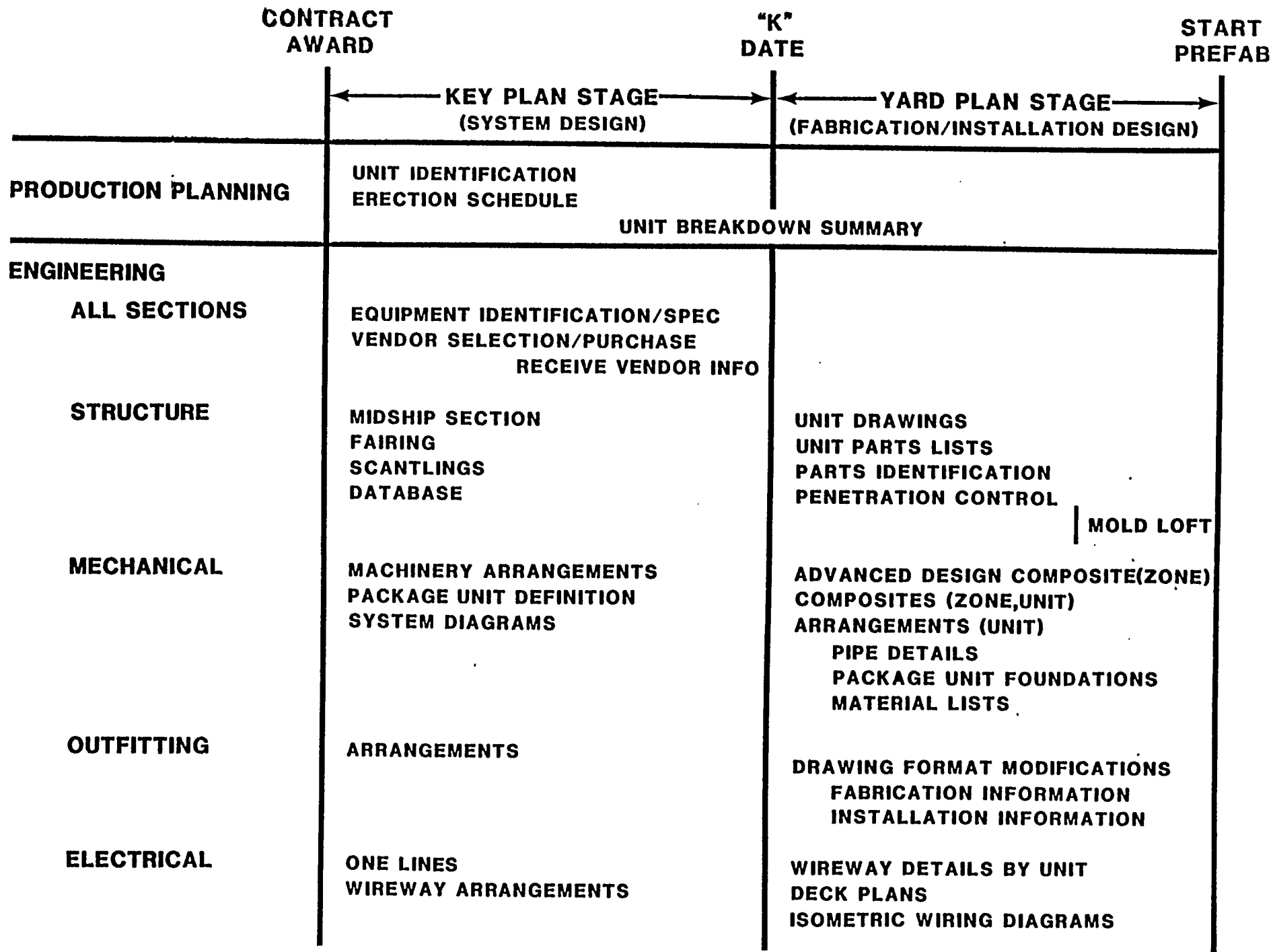
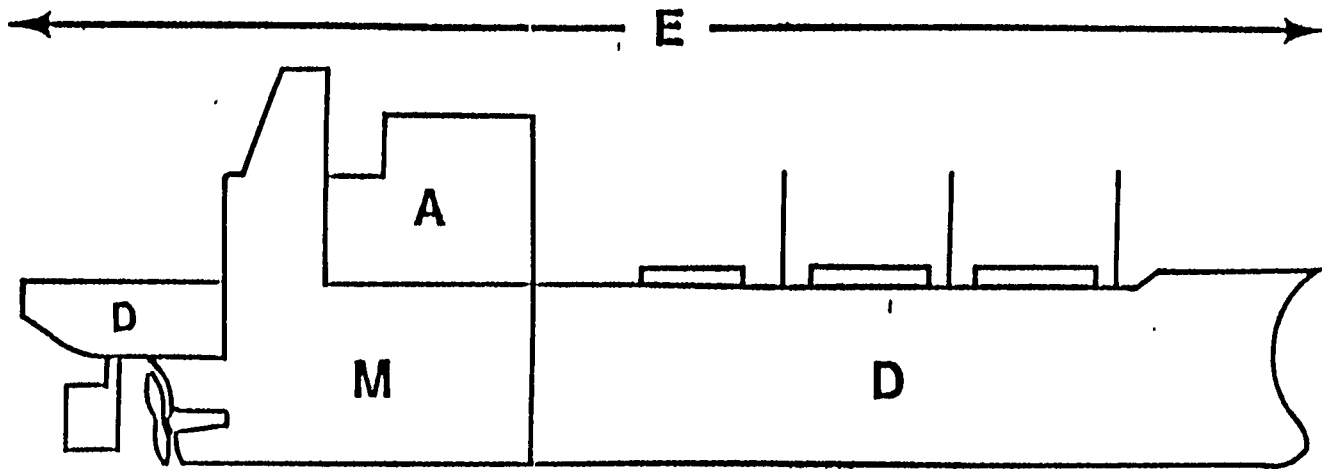

Figure No. 2



D - DECK

M - MACHINERY

A - ACCOMMODATIONS

E - ELECTRICAL

I H I ORGANIZATION

EFFECTS OF ZONE OUTFITTING TECHNOLOGY COMMON TO ALL ENGINEERING SECTIONS

- **ENGINEERING EFFORT MUST BEGIN AND BE COMPLETED EARLIER THAN IN CONVENTIONAL DESIGN METHODOLOGY**
- **ROLE OF THE ENGINEERING AND PRODUCTION ORGANIZATIONS AS PARTNERS MUST BE STRESSED - MEANINGFUL DIALOGUE IS ESSENTIAL**
- **ENGINEERING DRAWINGS ARE DEVELOPED AS UNITS, NOT AS SYSTEMS**
- **STRUCTURAL "KEY PLANS" ARE USED IN DRAWING DEVELOPMENT**
- **MATERIAL ON DRAWINGS MUST BE "PALLET CODED"**
- **ADVANCE ORDERING ON LONG LEAD MATERIAL IS EMPHASIZED**

OVERALL SCHEDULING IMPACT UNIT OUTFITTING vs CONVENTIONAL CONSTRUCTION

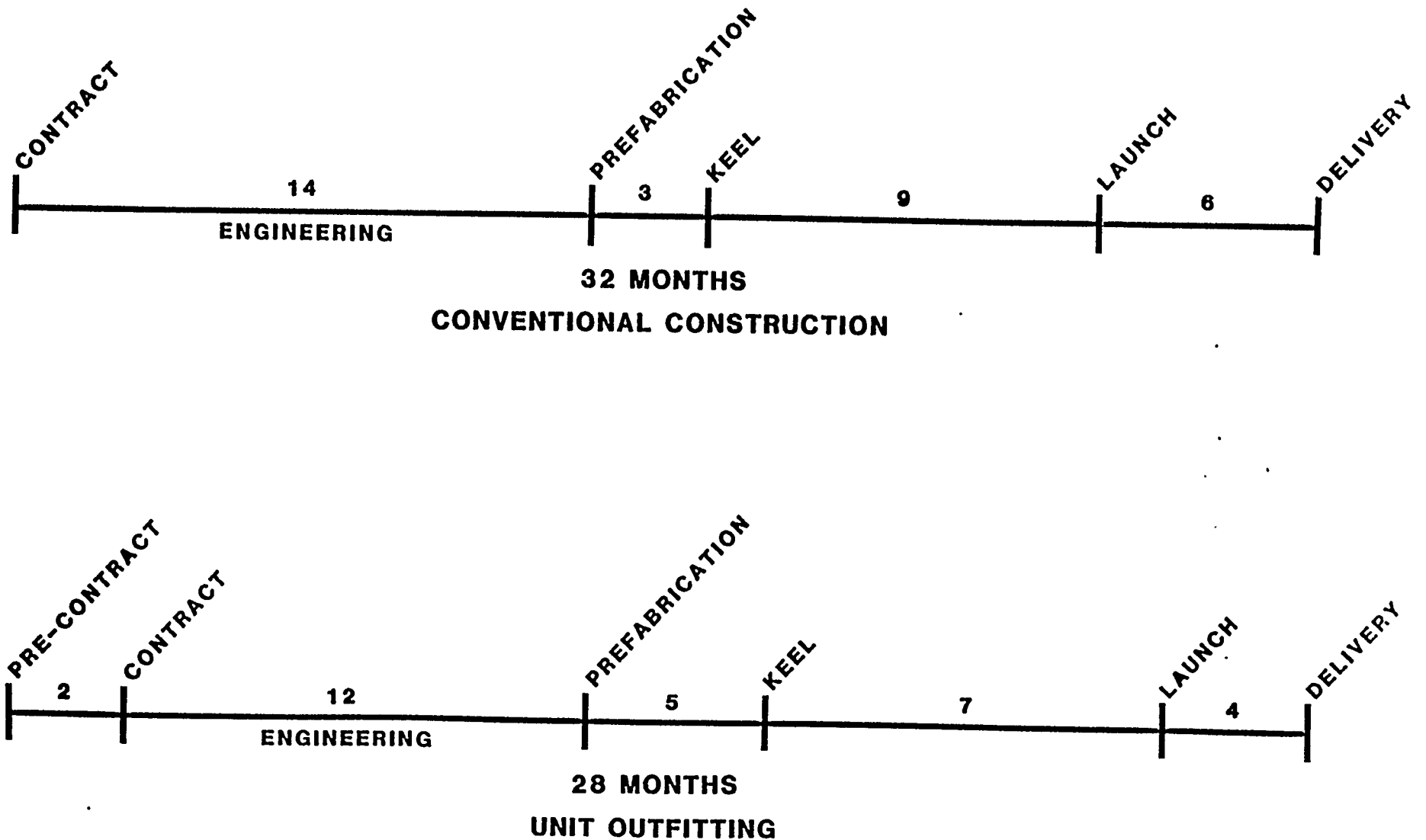

Figure No. 5

INTENSITY OF ENGINEERING EFFORT

CONVENTIONAL CONSTRUCTION

- Total Engineering Manhours - - - - - 350,000
- Percent Complete At Pre-Fabrication - - - - - 60%
- Months From Contract To Pre-Fabrication - - - 14
- Manhours Per Month (avg) Prior To Pre-Fabrication- 15,000

UNIT OUTFITTING

- Total Engineering Manhours - - - - - 500,000
- Percent Complete At Pre-Fabrication - - - - - 80%
- Months From Contract To Pre-Fabrication - - - 12
- Manhours Per Month (avg) Prior To Pre-Fabrication - 33,333

SUMMARY

- Engineering Intensity More Than Twice As Great In Unit Outfitting

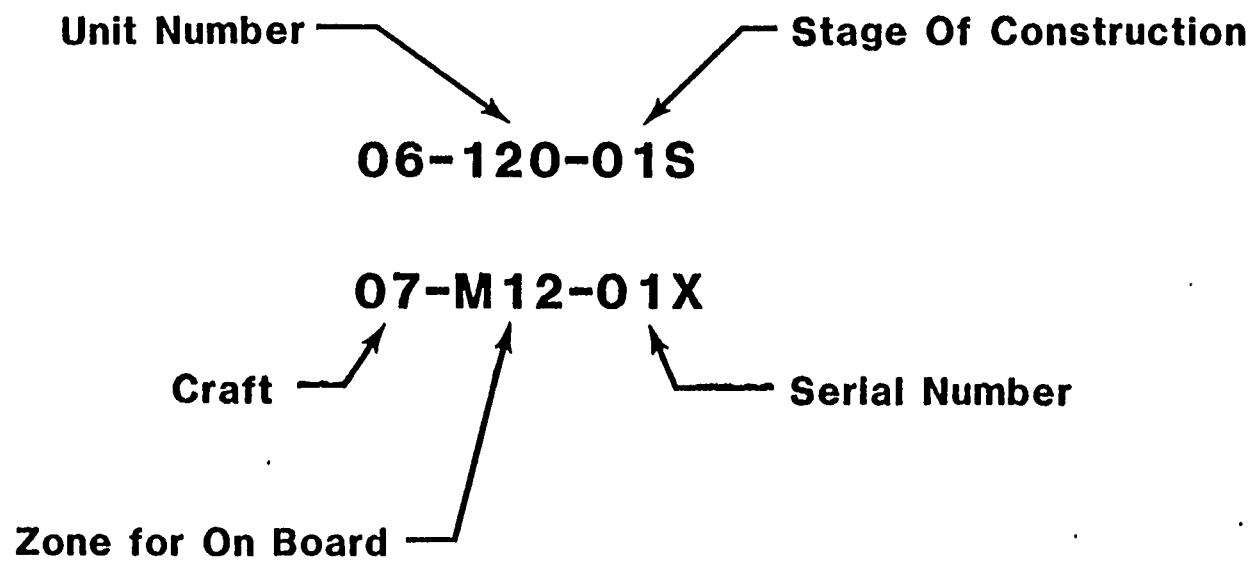

EXAMPLE OF PALLET CODES

Figure No. 7

THIS DRAWING CONTAINS MATERIAL WITH THE FOLLOWING PALLET CODES

PALLET CODE	DESCRIPTION
S	DURING SUB ASSEMBLYON UNIT
U	BEFORE TURNING DURING MN ASSYON UNIT
T	AFTER TURNING — PRIOR TO PAINTON UNIT
V	AFTER PAINT — PRIOR TO ERECTIONON UNIT
J	AFTER JOINING W/OTHER UNITS — PRIOR TO ERECTION..ON BLOCK
X	BEFORE CLOSING INON BOARD
Y	EASY ACCESS OR ON OPEN DECKON BOARD
Z	FINAL OUTFITTING, PILFERABLES, SPARE PARTS, LOOSE ITEMS, ETC.ON BOARD
1R	MATERIAL TO BE ROUTED TO RACK ASSEMBLY AREA
1P	MATERIAL TO BE ROUTED TO PACKAGE UNIT SHOP
1	MATERIAL TO BE ROUTED TO PIPE SHOP
2	MATERIAL TO BE ROUTED TO FRP PIPE FABRICATION AREA

Figure No. 8

UNIQUE EFFECTS OF ZONE OUTFITTING TECHNOLOGY ON THE HULL TECHNICAL AND DESIGN SECTION

- DEVELOPMENT OF STRUCTURAL KEY PLANS**
- CREATION AND MAINTENANCE OF THE
DATA BASE**
- REVIEW OF YARD PLANS**
- INCREASED ROLE IN PRODUCTION/
ENGINEERING LIAISON**

UNIQUE EFFECTS OF ZONE OUTFITTING TECHNOLOGY ON THE HULL STRUCTURES SECTION

- **ARRANGEMENT DRAWINGS (YARD PLANS)
DEVELOPED FROM KEY PLAN RATHER THAN
FROM SCANTLING PLAN**
- **MORE THOROUGH DETAILING OF PENETRATION
LOCATIONS ON YARD PLANS**
- **INCORPORATION OF PROCESS LANE
NOTATION ON YARD PLANS**

UNIQUE EFFECTS OF ZONE OUTFITTING TECHNOLOGY ON THE MECHANICAL DESIGN SECTION

- PIPE LINE IDENTIFICATION ADDED TO
PIPING DIAGRAMS**
- EQUIPMENT/COMPONENT LOCATIONS ADDED
TO PIPING DIAGRAMS RATHER THAN TO
ARRANGEMENT DRAWINGS**

UNIQUE EFFECTS OF ZONE OUTFITTING TECHNOLOGY ON THE PIPING AND HVAC SECTION

- UTILIZATION OF ADVANCED DESIGN COMPOSITE STUDIES (ADCS)**
- CREATION OF PACKAGE UNIT GROUP**
- DEVELOPMENT OF PIPE RACK DRAWINGS DEPICTING STRUCTURE AS WELL AS PIPE**
- ADDITION OF PIPE SHOP WORK STATION ROUTING AND COATING PROCEDURES TO P/D'S**

COMPOSITES
NOT FOR CONSTRUCTION
YARD INFORMATION ONLY

WARNING
All dimensions shall be scaled from the nearest
grid or frame line. Long scaled dimensions will
cause errors due to stretch of print paper or film.

EX-IP PLAN INNER BOTTOM

PORT

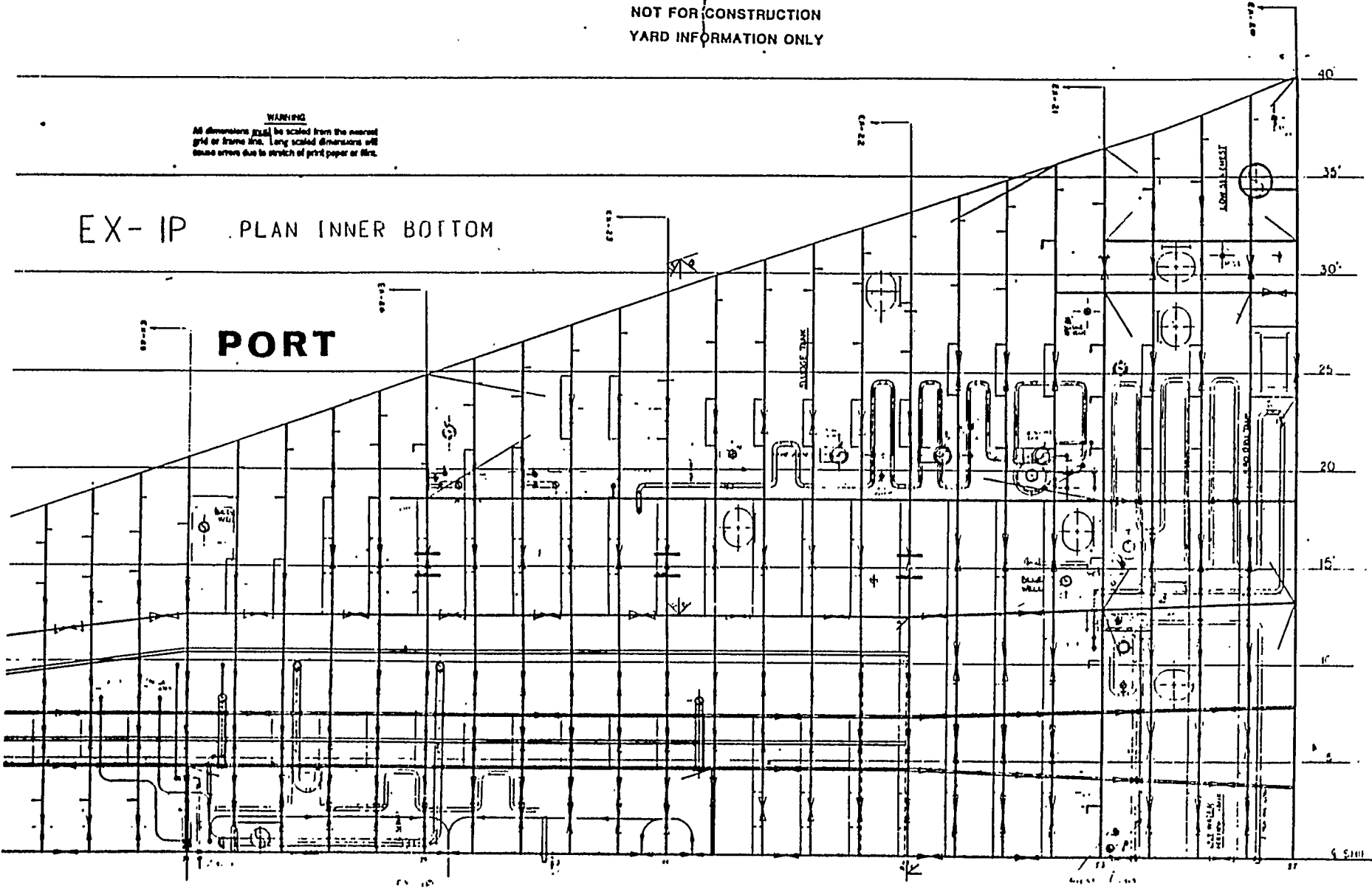

Figure No. 13

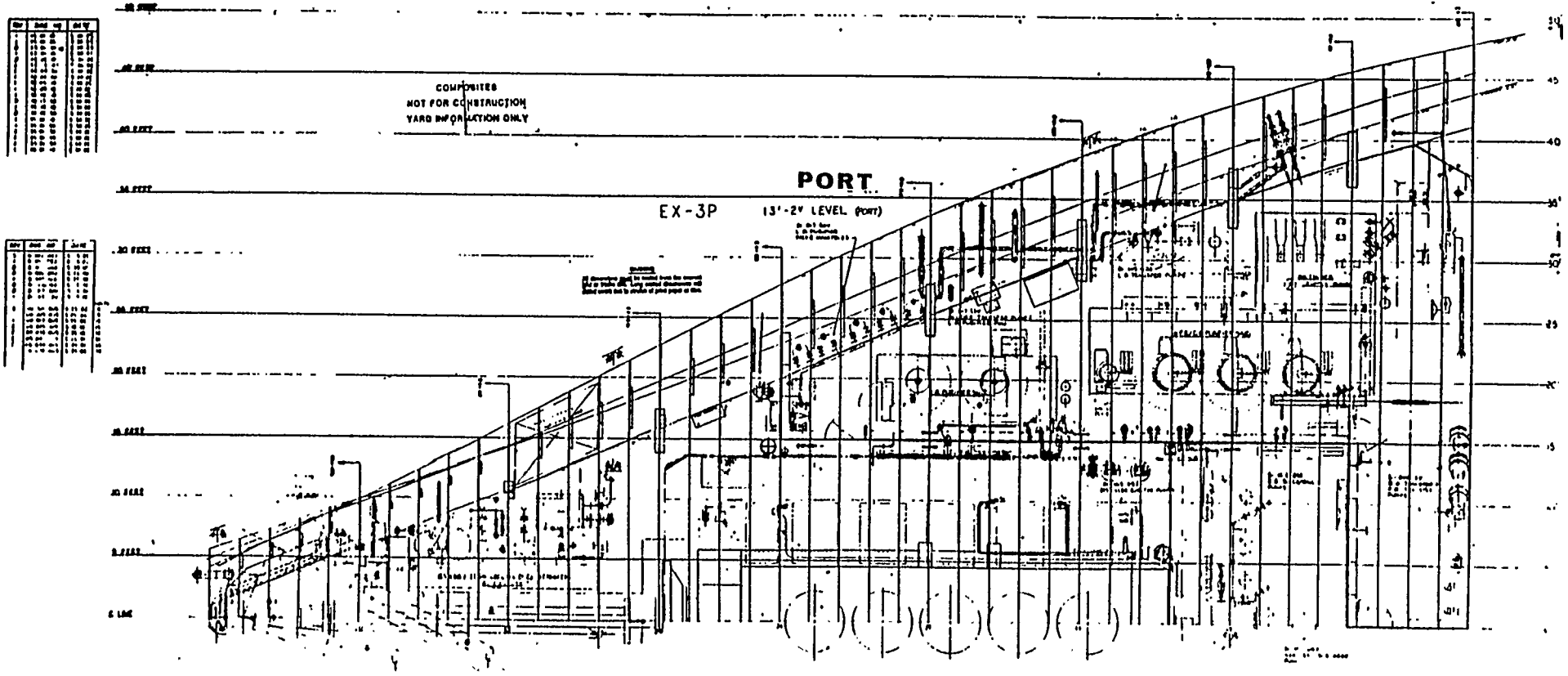

Figure No. 14

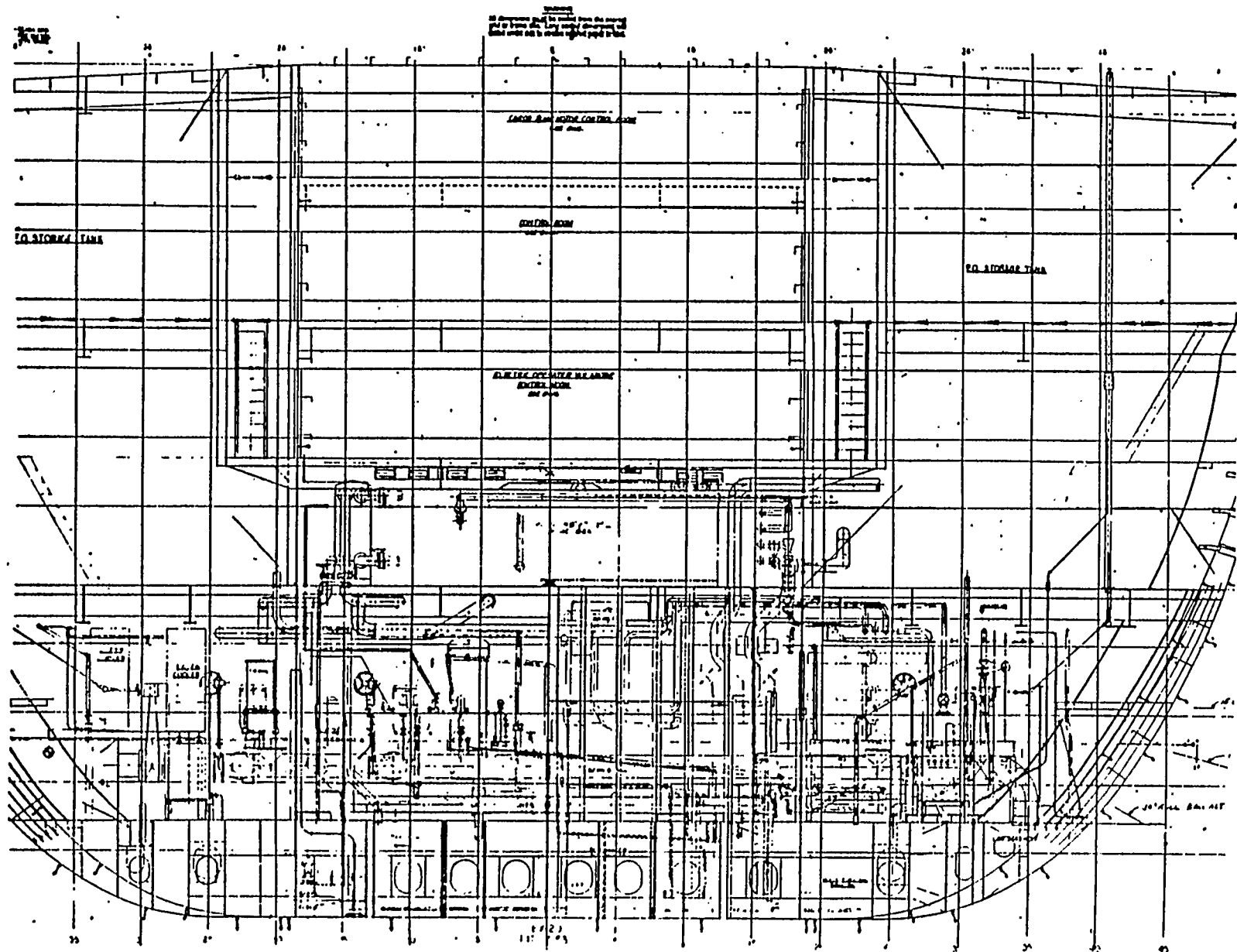

Figure No. 15

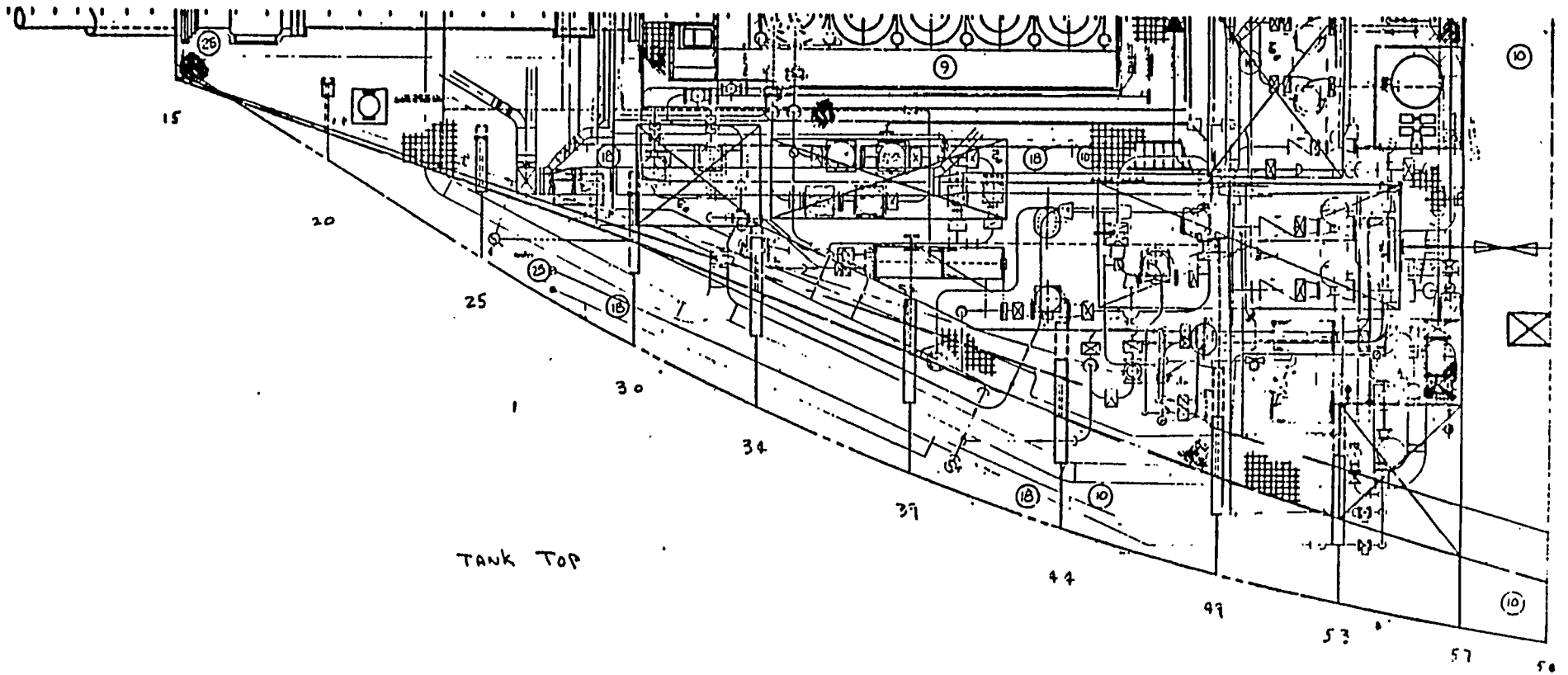

Figure No. 16

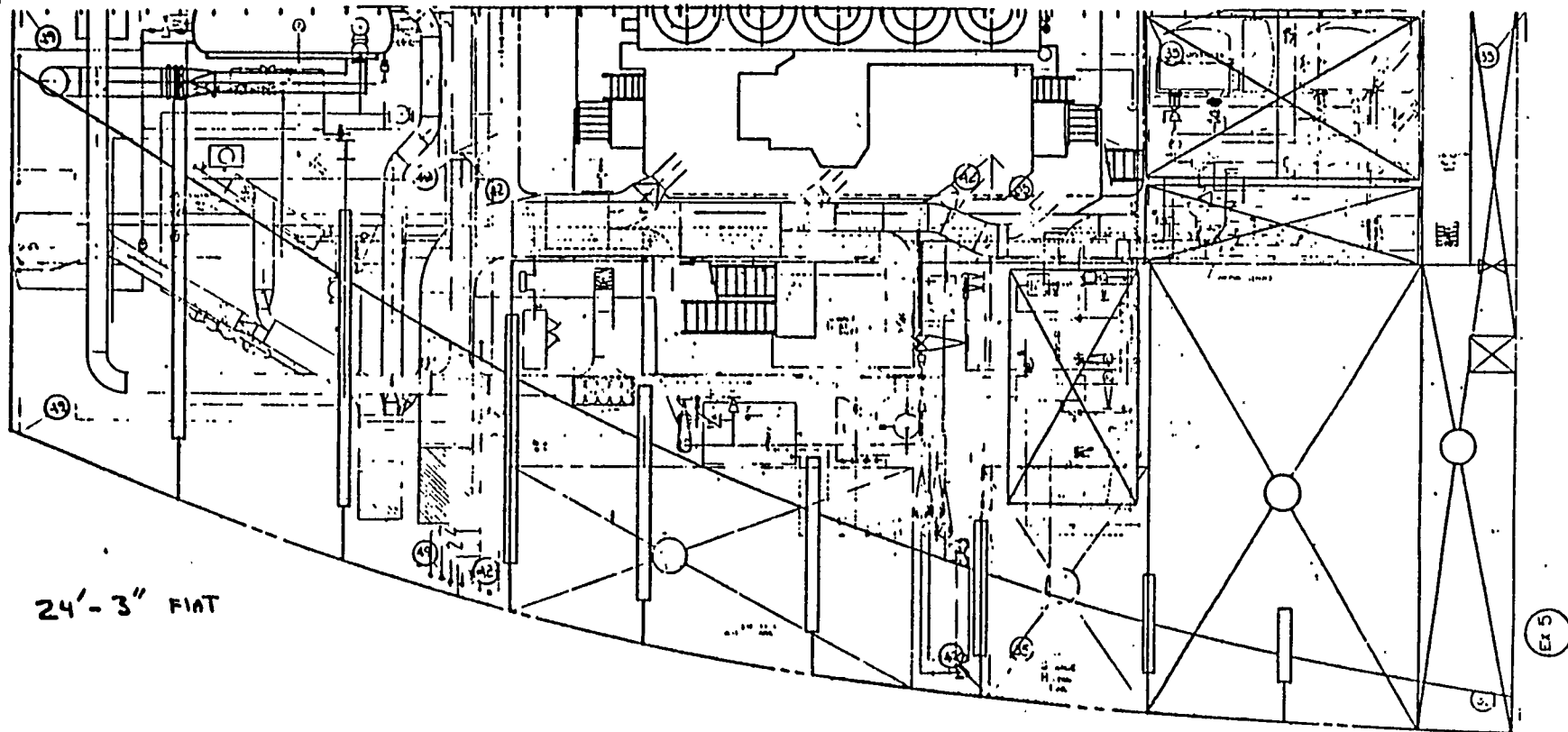
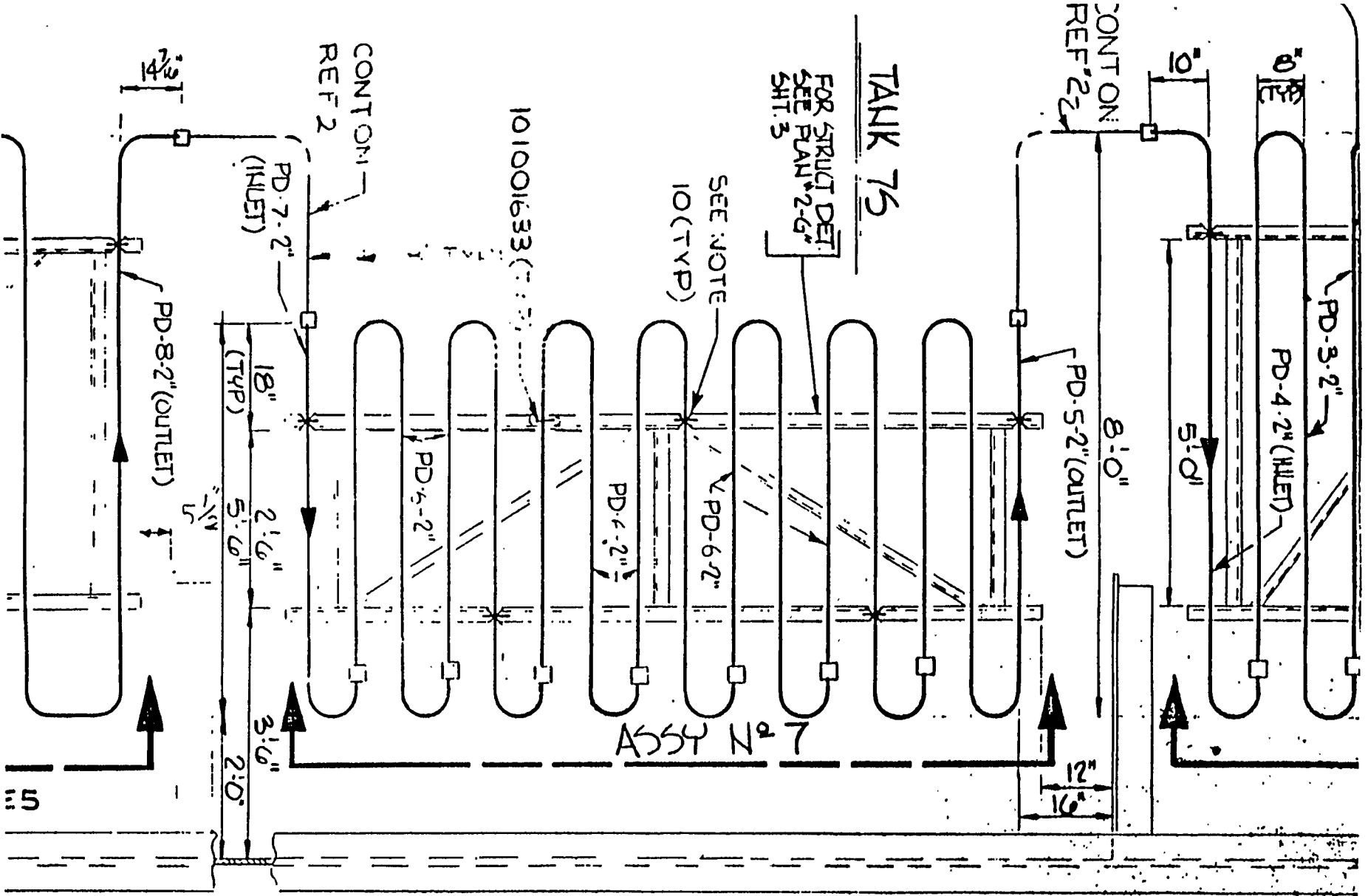

Figure No. 17



TANK 75

CONT ON
REF 22

CONT ON
REF 2

FOR STRUCT DET.
SEE PLAN 2-G
SHT. 3

SEE NOTE
10 (TYP)

101001633 (TYP)

ASSY N^o 7

PD-5.2" (OUTLET)

PD-4.2" (INLET)

PD-3.2"

PD-6.2"

PD-4.2"

PD-4.2"

PD-7.2" (INLET)

PD-8.2" (OUTLET)

8'-0"

5'-0"

18" (TYP)

2'-6"

5'-6"

2'-0"

3'-6"

2'-0"

12"

16"

FOR STRUCT. DET.
SEE PLAN 4-A
SHT. 3

CONT ON
REF 2

MASTER BUTT

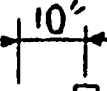

10" (TYP)

FOR STRUC DET.
SEE PLAN 3
SHT. 3

Figure No. 18

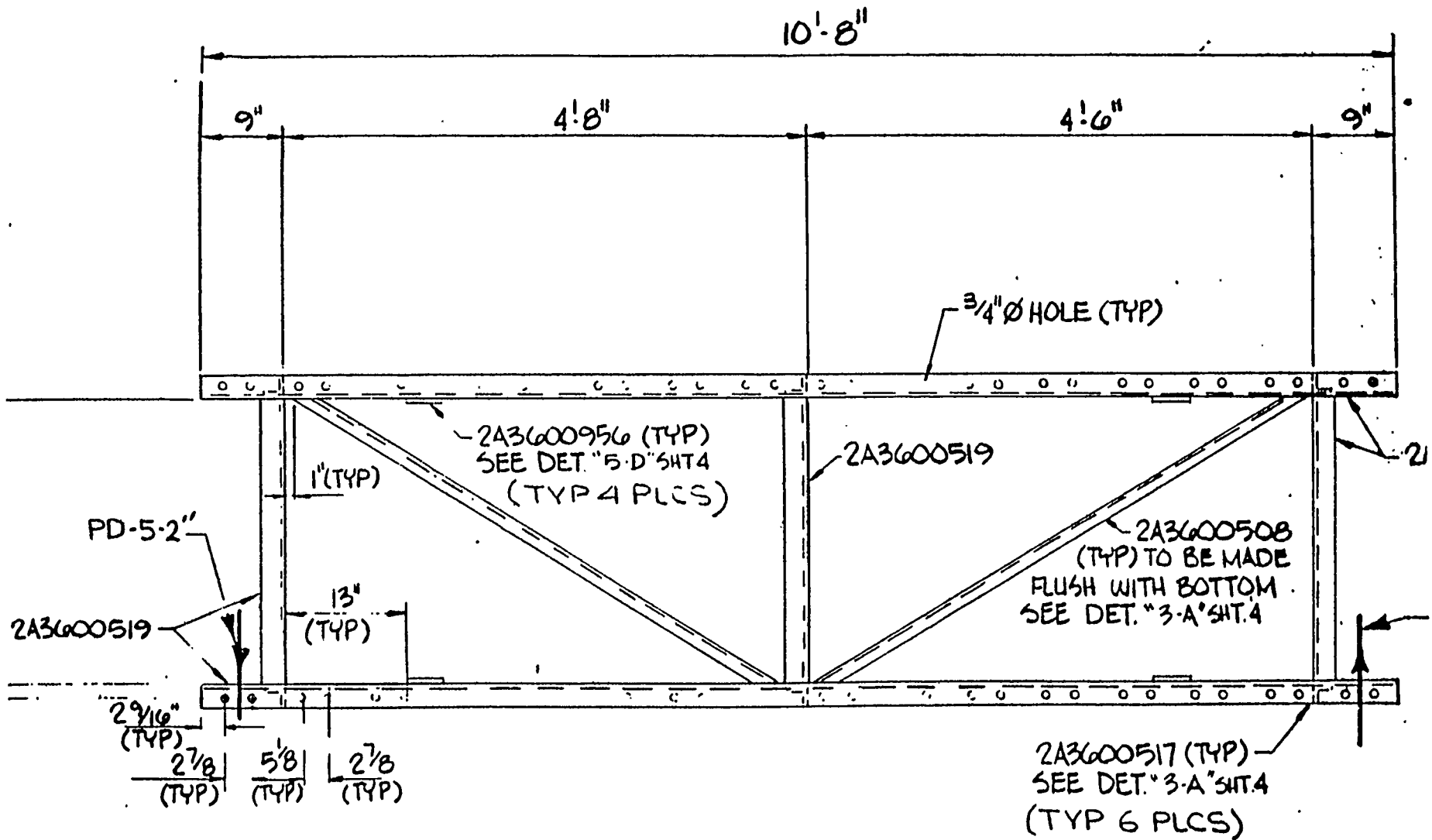

PLAN "2-G"

TANK No 75, ASSY No 7

UNIQUE EFFECTS OF ZONE OUTFITTING TECHNOLOGY ON THE OUTFITTING SECTION

- **COMPARTMENTATION & ACCESS DRAWINGS DEVELOPED EARLIER THAN IN CONVENTIONAL DESIGN METHODS**
- **CLASSIFICATION OF DECKS AND BULKHEADS DONE EARLIER THAN IN CONVENTIONAL DESIGN METHODS**
- **HAZARDOUS AREA DEFINITION DONE EARLIER THAN IN CONVENTIONAL DESIGN METHODS**
- **FABRICATION AND INSTALLATION INFORMATION SEPERATED ON DRAWINGS**