



**NAVAL  
POSTGRADUATE  
SCHOOL**

**MONTEREY, CALIFORNIA**

**THESIS**

**AN EXPLORATION OF UNMANNED AERIAL VEHICLES IN THE  
ARMY'S FUTURE COMBAT SYSTEMS FAMILY OF SYSTEMS**

by

Charles A. Sulewski

December 2005

Thesis Advisor:  
Second Reader:

Thomas Lucas  
Jeffrey B. Schamburg

**Approved for public release; distribution is unlimited.**

THIS PAGE INTENTIONALLY LEFT BLANK

REPORT DOCUMENTATION PAGE			Form Approved OMB No. 0704-0188
Public reporting burden for this collection of information is estimated to average 1 hour per response, including the time for reviewing instruction, searching existing data sources, gathering and maintaining the data needed, and completing and reviewing the collection of information. Send comments regarding this burden estimate or any other aspect of this collection of information, including suggestions for reducing this burden, to Washington headquarters Services, Directorate for Information Operations and Reports, 1215 Jefferson Davis Highway, Suite 1204, Arlington, VA 22202-4302, and to the Office of Management and Budget, Paperwork Reduction Project (0704-0188) Washington DC 20503.			
1. AGENCY USE ONLY (Leave blank)	2. REPORT DATE December 2005	3. REPORT TYPE AND DATES COVERED Master's Thesis	
4. TITLE AND SUBTITLE: An Exploration of Unmanned Aerial Vehicles in the Army's Future Combat Systems Family of Systems			5. FUNDING NUMBERS
6. AUTHOR(S) Charles Sulewski			
7. PERFORMING ORGANIZATION NAME(S) AND ADDRESS(ES) Naval Postgraduate School Monterey, CA 93943-5000			8. PERFORMING ORGANIZATION REPORT NUMBER
9. SPONSORING /MONITORING AGENCY NAME(S) AND ADDRESS(ES) N/A			10. SPONSORING/MONITORING AGENCY REPORT NUMBER
11. SUPPLEMENTARY NOTES The views expressed in this thesis are those of the author and do not reflect the official policy or position of the Department of Defense or the U.S. Government.			
12a. DISTRIBUTION / AVAILABILITY STATEMENT Approved for public release; distribution is unlimited			12b. DISTRIBUTION CODE
13. ABSTRACT (maximum 200 words) Unmanned aerial vehicles (UAVs) will be a critical part of the U.S. Army's Future Force. The Future Force will be a highly mobile, network enabled family of systems with integrated sensors and precision munitions. The Future Force will rely heavily on UAVs to provide eyes on the battlefield. These eyes will trigger the deployment of precision munitions by other platforms, and possibly by UAVs themselves. To provide insight into how the numbers and capabilities of UAVs affect a Future Force Combined Arms Battalion's (CAB's) ability to secure a Northeast Asia urban objective, a simulation was built and analyzed. 46,440 computational experiments were conducted to assess how varying the opposing force and the numbers, tactics, and capabilities of UAVs affects the CAB's ability to secure the objective with minimal losses. The primary findings, over the factors and ranges examined, are: UAVs significantly enhance the CAB's performance; UAV capabilities and their tactics outweigh the number of UAVs flying; battalion level UAVs, especially when armed, are critical in the opening phases of the battle, as they facilitate the rapid attrition of enemy High Pay-off Targets; and, at least one company level and a platoon level UAV enhances dismounts survivability later in the battle.			
14. SUBJECT TERMS Agent-based models, MANA, Project Albert, Nearly Orthogonal Latin Hypercube, Design of Experiment, Unmanned Aerial Vehicles, UAV, FCS, Future Force, Objective Force			15. NUMBER OF PAGES 184
			16. PRICE CODE
17. SECURITY CLASSIFICATION OF REPORT Unclassified	18. SECURITY CLASSIFICATION OF THIS PAGE Unclassified	19. SECURITY CLASSIFICATION OF ABSTRACT Unclassified	20. LIMITATION OF ABSTRACT UL

THIS PAGE INTENTIONALLY LEFT BLANK

**Approved for public release; distribution is unlimited.**

**AN EXPLORATION OF UNMANNED AERIAL VEHICLES IN THE ARMY'S  
FUTURE COMBAT SYSTEMS FAMILY OF SYSTEMS**

Charles A. Sulewski  
Captain, United States Army  
B.S., United States Military Academy, 1996

Submitted in partial fulfillment of the  
requirements for the degree of

**MASTER OF SCIENCE IN OPERATIONS RESEARCH**

from the

**NAVAL POSTGRADUATE SCHOOL  
December 2005**

Author: Charles A. Sulewski

Approved by: Thomas Lucas  
Thesis Advisor

Jeffrey B. Schamburg  
Second Reader

James N. Eagle  
Chairman, Department of Operations Research

THIS PAGE INTENTIONALLY LEFT BLANK

## **ABSTRACT**

Unmanned aerial vehicles (UAVs) will be a critical part of the U.S. Army's Future Force. The Future Force will be a highly mobile, network enabled family of systems with integrated sensors and precision munitions. The Future Force will rely heavily on UAVs to provide eyes on the battlefield. These eyes will trigger the deployment of precision munitions by other platforms, and possibly by UAVs themselves.

To provide insight into how the numbers and capabilities of UAVs affect a Future Force Combined Arms Battalion's (CAB's) ability to secure a Northeast Asia urban objective, a simulation was built and analyzed. 46,440 computational experiments were conducted to assess how varying the opposing force and the numbers, tactics, and capabilities of UAVs affects the CAB's ability to secure the objective with minimal losses. The primary findings, over the factors and ranges examined, are: UAVs significantly enhance the CAB's performance; UAV capabilities and their tactics outweigh the number of UAVs flying; battalion level UAVs, especially when armed, are critical in the opening phases of the battle, as they facilitate the rapid attrition of enemy High Pay-off Targets; and, at least one company level and a platoon level UAV enhances dismounts survivability later in the battle.

THIS PAGE INTENTIONALLY LEFT BLANK



## **THESIS DISCLAIMER**

The reader is cautioned that the computer programs presented in this research may not have been exercised for all cases of interest. While every effort has been made, within the time available, to ensure that the programs are free of computational and logic errors, they cannot be considered validated. Any application of these programs without additional verification is at the risk of the user.

THIS PAGE INTENTIONALLY LEFT BLANK

# TABLE OF CONTENTS

<b>I.</b>	<b>INTRODUCTION.....</b>	<b>1</b>
<b>A.</b>	<b>TRANSFORMATION BACKGROUND .....</b>	<b>1</b>
<b>B.</b>	<b>UAVS: THE FCS FACILATER.....</b>	<b>5</b>
<b>C.</b>	<b>PROBLEM STATEMENT .....</b>	<b>7</b>
<b>D.</b>	<b>SCOPE .....</b>	<b>9</b>
<b>II.</b>	<b>NORTHEAST ASIA ATTACK SCENARIO OVERVIEW .....</b>	<b>11</b>
<b>A.</b>	<b>FCS SYSTEMS DESCRIPTION .....</b>	<b>11</b>
<b>1.</b>	<b>Unmanned Aerial Vehicle - Class I, II, and III .....</b>	<b>12</b>
<b>2.</b>	<b>Mounted Combat System (MCS) .....</b>	<b>14</b>
<b>3.</b>	<b>Infantry Carrier Vehicle (ICV) .....</b>	<b>14</b>
<b>4.</b>	<b>Armed Robotic Vehicle Assault Variant (ARV-A) .....</b>	<b>15</b>
<b>5.</b>	<b>Armed Robotic Vehicle Assault Variant (ARV-L) .....</b>	<b>15</b>
<b>6.</b>	<b>Armed Robotic Vehicle - Reconnaissance Surveillance, and Target Acquisition Variant (ARV-RSTA).....</b>	<b>15</b>
<b>7.</b>	<b>Reconnaissance and Surveillance Vehicle (R&amp;SV) .....</b>	<b>15</b>
<b>8.</b>	<b>Non-Line-of-Sight Mortor (NLOS Mortor).....</b>	<b>16</b>
<b>9.</b>	<b>Non-Line-of-Sight Launch System (NLOS LS).....</b>	<b>16</b>
<b>10.</b>	<b>Non-Line-of-Sight Cannon (NLOS Cannon).....</b>	<b>16</b>
<b>11.</b>	<b>Land Warrior System.....</b>	<b>16</b>
<b>12.</b>	<b>Apache Attack Helicopter AH-64D.....</b>	<b>17</b>
<b>13.</b>	<b>JSF (Joint Strike Fighter) .....</b>	<b>17</b>
<b>B.</b>	<b>RED FORCE DESCRIPTION .....</b>	<b>17</b>
<b>1.</b>	<b>BMP-3 System .....</b>	<b>18</b>
<b>2.</b>	<b>82 Mortor System.....</b>	<b>18</b>
<b>3.</b>	<b>Dismounted Soldier.....</b>	<b>18</b>
<b>a.</b>	<b><i>Surface-to-Air System (SA-16) .....</i></b>	<b><i>18</i></b>
<b>b.</b>	<b><i>Rocket Propelled Grenade System (RPG 7).....</i></b>	<b><i>18</i></b>
<b>c.</b>	<b><i>Anti-Tank System (AT-7).....</i></b>	<b><i>19</i></b>
<b>d.</b>	<b><i>RPK-74 .....</i></b>	<b><i>19</i></b>
<b>4.</b>	<b>Armored Personnel Carrier (APC) BTR-80 .....</b>	<b>19</b>
<b>5.</b>	<b>T-72 Tank System .....</b>	<b>19</b>
<b>C.</b>	<b>MODEL VIGNETTE DESCRIPTION.....</b>	<b>20</b>
<b>III.</b>	<b>MODEL DEVELOPMENT .....</b>	<b>27</b>
<b>A.</b>	<b>AGENT-BASED SIMULATION (ABS) OVERVIEW .....</b>	<b>27</b>
<b>B.</b>	<b>WHY MANA? .....</b>	<b>29</b>
<b>C.</b>	<b>MODELING METHODOLOGY .....</b>	<b>31</b>
<b>1.</b>	<b>Scaling: Configure Battlefield Settings .....</b>	<b>31</b>
<b>2.</b>	<b>Model Unit Summary .....</b>	<b>36</b>
<b>a.</b>	<b><i>Players .....</i></b>	<b><i>36</i></b>
<b>b.</b>	<b><i>Weapons .....</i></b>	<b><i>37</i></b>
<b>c.</b>	<b><i>Aggregation .....</i></b>	<b><i>38</i></b>
<b>3.</b>	<b>Movement Rates.....</b>	<b>38</b>

4.	Personalities.....	41
5.	Sense and Detect.....	43
	<i>a. Ground and other Air (Non UAV) Sensors .....</i>	<i>43</i>
	<i>b. UAV Sensors .....</i>	<i>45</i>
4.	Communication Characteristics .....	50
6.	Weapon Characteristics .....	51
	<i>a. Kinetic Weapon Modeling .....</i>	<i>52</i>
	<i>b. Area Fire Weapon Modeling .....</i>	<i>53</i>
7.	Armor and Concealment.....	55
D.	MODEL LIMITATIONS.....	56
IV.	DESIGN METHODOLOGY .....	59
A.	DESIGN OF EXPERIMENT.....	59
	1. Design Factors .....	60
	2. Measures of Effectiveness (MOE) .....	62
B.	TOOLS AND TECHNIQUES .....	63
	1. DOE Software Tools .....	63
	<i>a. Spreadsheet Modeling with Excel .....</i>	<i>64</i>
	<i>b. XML.....</i>	<i>64</i>
	<i>c. Tiller© .....</i>	<i>64</i>
	<i>d. Ruby Code and Scripting .....</i>	<i>65</i>
	2. Analysis Software Tools (JMP Statistical Discovery Software <sup>TM</sup> ).....	65
	3. Analysis Techniques .....	66
	<i>a. Graphical Analysis.....</i>	<i>66</i>
	<i>b. Classification and Regression Trees (CART).....</i>	<i>66</i>
	<i>c. Multiple Regression .....</i>	<i>67</i>
V.	DATA ANALYSIS.....	69
A.	DATA COMPILATION.....	69
B.	INITIAL OBSERVATIONS.....	70
C.	CLOSING OBSERVATIONS RELATED TO THESIS QUESTIONS ...	77
	1. Battlefield Time Hacks .....	77
	2. The Early Fight .....	79
	<i>a. How many Platoon, Company, and Battalion level UAVs             are needed for the FCS to secure the urban environment? ..</i>	<i>81</i>
	<i>b. How will armed battalion level UAVs enhance the FCS's             ability to secure the urban environment?.....</i>	<i>93</i>
	<i>e. Is it better to arm Warrior UAVs with Hellfire missiles at             the CAB level, or to use APKWS 2.75 inch guided rockets             with M151 HE warheads attached to the CL III UAVs? .....</i>	<i>97</i>
VI.	CONCLUSIONS AND RECOMMENDATIONS FOR FUTURE STUDY .....	99
A.	SUMMARY OF CONCLUSIONS AND GAINED INSIGHT .....	99
	1. Data Analysis Conclusions .....	99
	2. Modeling and DOE Methodology Findings.....	101
B.	RECOMMENDATIONS FOR FUTURE STUDY .....	103

<b>APPENDIX A. MANA SPREADSHEET MODELING.....</b>	<b>105</b>
<b>A. SCALING: CONFIGURE BATTLEFIELD SETTINGS .....</b>	<b>106</b>
<b>B. MODEL UNIT SUMMARY .....</b>	<b>107</b>
<b>C. MOVEMENT RATES.....</b>	<b>108</b>
<b>D. SENSE AND DETECT.....</b>	<b>109</b>
<b>E. PERSONALITIES .....</b>	<b>111</b>
<b>F. COMMUNICATION CHARACTERISTICS.....</b>	<b>116</b>
<b>G. WEAPON CHARACTERISTICS.....</b>	<b>118</b>
<b>H. ARMOR AND CONCEALMENT .....</b>	<b>123</b>
<b>APPENDIX B. DOE MODELING.....</b>	<b>125</b>
<b>A. DOE SPREADSHEET MODELING .....</b>	<b>125</b>
<b>B. TILLER .....</b>	<b>129</b>
<b>C. RUBY SCRIPTING .....</b>	<b>130</b>
<b>APPENDIX C. ADDITIONAL DATA ANALYSIS .....</b>	<b>133</b>
<b>A. INITIAL OBSERVATIONS.....</b>	<b>134</b>
<b>B. THE EARLY FIGHT .....</b>	<b>138</b>
<b>C. INTERACTIONS.....</b>	<b>147</b>
<b>LIST OF REFERENCES.....</b>	<b>149</b>
<b>INITIAL DISTRIBUTION LIST .....</b>	<b>155</b>

THIS PAGE INTENTIONALLY LEFT BLANK

## LIST OF FIGURES

Figure 1.	Unit of Action Tree Diagram.....	5
Figure 2.	Future Combat Systems: Platforms .....	12
Figure 3.	NEA 50.2 Area of Operation Map.....	21
Figure 4.	Combined Arms Battalion Tree Diagram.....	22
Figure 5.	NEA 50.2 MANA Screenshot.....	32
Figure 6.	Adjusted Average Sensor Value .....	44
Figure 7.	UAV Sensor Probability of Detection Graph .....	47
Figure 8.	Modeled UAV Sensor Probability of Detection Graphs.....	49
Figure 9.	Carleton Function.....	54
Figure 10.	Regression Tree, with MOE: Proportion of HPT Killed .....	71
Figure 11.	Regression Tree, with MOE: Proportion of Dismounts Survived .....	72
Figure 12.	Histograms of Initial Analysis with Robust DOE .....	73
Figure 13.	Tests of Main Effects (Stepwise Linear Regression Model Fit).....	75
Figure 14.	Graphical Analysis: Battlefield Time Hack without robust DOE .....	77
Figure 15.	Histograms at 450 seconds (7.5 minutes) .....	78
Figure 16.	Histograms at 900 seconds (15 minutes) .....	78
Figure 17.	<i>t</i> -Test Results Between a 15-minute and 2-hour Battle .....	80
Figure 18.	Scatterplot Matrix (Positive Correlation Between HPTs and Dismounts) .....	82
Figure 19.	Regression Model (Proportion of HPTs Killed at 450 seconds).....	84
Figure 20.	Regression Tree (Proportion of HPTs Killed at 450 seconds).....	86
Figure 21.	Regression Model (Proportion of HPTs Killed at 900 seconds).....	87
Figure 22.	Regression Tree (Proportion of HPTs Killed at 900 seconds).....	88
Figure 23.	Regression Model (Proportion of Dismounts Survived at 900 seconds).....	91
Figure 24.	Regression Tree (Proportion of Dismounts Survived at 900 seconds).....	91
Figure 25.	Regression Model (Interaction Measured by HPTs) .....	94
Figure 26.	Interaction Plot of CL III UAVs Armed with Munitions .....	95
Figure 27.	Additional Interaction Plot.....	97
Figure 28.	Ruby PatchExcursion.rb Code .....	130
Figure 29.	Ruby Scripting Command.....	130
Figure 30.	Multiple Regression Output for Initial Analysis of Robust DOE.....	134
Figure 31.	Regression Model (Proportion of HPTs Killed at 450 seconds).....	138
Figure 32.	Regression Model (Proportion of HPTs Killed at 900 seconds).....	141
Figure 33.	Regression Model (Proportion of Dismounts Survived at 900 seconds).....	144
Figure 34.	Determine Interactions Model, MOE: Proportion of HPTs Killed.....	147

THIS PAGE INTENTIONALLY LEFT BLANK



## LIST OF TABLES

Table 1.	NEA 50.2 Team Disposition.....	23
Table 2.	Red Force Disposition.....	24
Table 3.	Scaling Equations.....	34
Table 4.	Edit Terrain Properties.....	35
Table 5.	Real World Basic Movement Rates .....	38
Table 6.	MANA Movement Speeds.....	40
Table 7.	Numerical Sensor Value .....	44
Table 8.	FCS UAV Sensor Type.....	46
Table 9.	FCS UAV Sensor Type Definitions .....	46
Table 10.	Modeled Communication Types.....	50
Table 11.	Weapon Characteristics .....	51
Table 12.	Modeled P(Kill) for Area Fire Weapons using the Carleton Function.....	54
Table 13.	Factor and Level Description for DOE.....	61
Table 14.	Significant Factors (Proportion of HPTs Killed at 450 seconds) .....	85
Table 15.	Significant Factors (Proportion of HPTs Killed at 900 seconds) .....	88
Table 16.	UAV Estimates (Proportion of HPTs Killed at 450 and 900 seconds).....	89
Table 17.	Significant Factors (Proportion of Dismounts Survived at 900 seconds).....	92
Table 18.	UAV Estimates (Proportion Dismounts Survived at 900 seconds) .....	93
Table 19.	Table of Instruction to Modify a Skeleton <i>study.xml</i> File .....	131

THIS PAGE INTENTIONALLY LEFT BLANK

## LIST OF ACRONYMS AND ABBREVIATIONS

ABM	Agent-Based Models
ABS	Agent-Based Simulations
AoA	Analysis of Alternatives
APKWS	Armed Precision Kill Weapon System
ARV-A	Armed Robotic Vehicle - Assault Variant
ARV-L	Armed Robotic Vehicle - Light
ARV-RSTA	Armed Robotic Vehicle - Reconnaissance, Surveillance, and Target Acquisition Vehicle
BLOS	Beyond-Line-of-Sight
CA	Combined Arms
COA	Course of Action
CPU	Central Processing Unit
DA	Department of the Army
DoD	Department of Defense
FCS	Future Combat Systems
GUI	Graphical User Interface
GWOT	Global War on Terrorism
HPT	High Pay-off Target
HVT	High Value Target
ICV	Infantry Carrier Vehicle
LOS	Line-of-Sight
MASINT	Measurement and Signature Intelligence
MCS	Mounted Combat System

METT-T	Mission, Enemy, Troops, Terrain, and Time
MOUT	Military Operations in Urbanized Terrain
NAI	Named Areas of Interest
NEA	Northeast Asia
NLOS	Non-Line-of-Sight
OBJ	Objective
RSTA	Reconnaissance, Surveillance, Target Acquisition
R&SV	Reconnaissance and Surveillance Vehicle
SIGINT	Signals Intelligence
TA	Target Acquisition
TOS	Time on Station
TRAC	Training and Doctrine Command Analysis Center
TRADOC	Training and Doctrine Command
UA	Unit of Action
UAV	Unmanned Air Vehicle
UE	Unit of Employment
UGV	Unmanned Ground Vehicle
UH	Utility Helicopter
UAMBL	Unit of Action Maneuver Battle Lab
VIC	Vector-in-Commander
VTOL	Vertical Take-off and Landing
WSMR	White Sands Missile Range
XML	Extensible Markup Language

## ACKNOWLEDGMENTS

I would like to begin by thanking the Lord for watching over me, and providing me with the wisdom, courage, and perseverance to not only live, but to enjoy it as well.

I would also like to thank my great thesis team. I thank Professor Thomas Lucas for his guidance and extensive statistics, design of experiments, and write up guidance. The journey and final product would not have been the same without your mentorship. I would also like to thank LTC Jeffrey B. Schamburg for his military expertise and keeping me focused and headed in the correct direction within the parameters of my work. Two additional faculty members here at NPS contributed to overcoming obstacles along the way in this analysis, and to these two individuals, Professors Paul and Susan Sanchez, I say thank you. I would also like to acknowledge the talented staff at Project Albert, and especially Dr. Gary Horne, for the opportunity to ask questions, learn insights, and find surprises.

Finally, I would like to thank my family. Stacey, your support, love, and charm is unbounded. Without you, my life would be incomplete. Thanks for taking extra good care of the children during this time, and for always keeping me smiling. Thanks also to Jessica and Anthony, the apples for each of my eyes, who always love Daddy for just being Dad.

THIS PAGE INTENTIONALLY LEFT BLANK

## **EXECUTIVE SUMMARY**

Unmanned aerial vehicles (UAVs) are playing an increasingly important role in the Global War on Terrorism (GWOT). These roles are part of the United States Department of Defense's (DoD's) greatest transformation of the armed forces since World War II. This transformation is a holistic approach to modernize our forces' equipment, methods, and tactics to ensure success for future conflicts.

The Army's Future Force (formerly "Objective Force") focuses on a lighter, more agile force, permitting the troops to move quickly in order to seize the initiative and finish decisively. Since conventional systems are inadequate to facilitate all of the goals of the Army's transformation, the Army is developing the core building block of the Future Force—known as the Future Combat Systems (FCS) Family of Systems (FoS). The FCS is a networked "system of systems" comprised of 18 individual system platforms, the network, and the soldier. Unmanned Aerial Vehicles are among these platforms.

This area of research is significant because the Army's FCS relies heavily on unmanned air vehicles (UAVs) and unmanned ground vehicles (UGVs) to provide eyes on the battlefield. These eyes will trigger the deployment of precision munitions by fixed wing Close Air Support (CAS), Beyond-Line-of-Sight (BLOS), Non-Line-of-Sight (NLOS) weapon platforms, and possibly by UAVs themselves. The FCS UAVs are the hunters in the sky for tomorrow's battles.

FCS UAVs are currently broken down into classes I, II, III, and IV(a, b). This thesis only focuses on classes I, II, and III. Class I UAVs within the FCS provide Reconnaissance, Surveillance, and Target Acquisition (RSTA) capabilities at the platoon level. Class II UAVs provide RSTA capabilities and target designation at the platoon and company level. Class III UAVs provide RSTA capability, target designation, communication relay, and mine detection at the combined arms battalion (CAB) level. Both the CL IV(a and b) provide similar capabilities at the Unit of Action (UA) level of the battlefield, and are outside the scope of this thesis.

This thesis applies a low-resolution model to examine the U.S Army Training and Doctrine Command's (TRADOC's) tasked analysis questions regarding the effectiveness of the FCS within an urban environment. The objective is to identify a preferred numerical mix of class I, II, and III RSTA, and precision guided armed UAVs needed in a combined arms battalion of the Army's Future Force to identify, engage, and destroy enemy targets in a specified MOUT environment.

This analysis focuses on an UA Combined Arms Battalion (CAB) attacking in a Northeast Asia (NEA) area of operation (Refer to Figure ES1). The scenario and Blue Force structure for the analysis is adopted from the Training and Doctrine Analysis Center—White Sands Missile Range (TRAC-WSMR) CASTFOREM modeled vignette NEA 50.2. The Red Force Order-of-Battle, modified slightly, represents a plausible stronger threat. This ensures that the blue CAB does not gain complete victory with every simulation, thus facilitating the search for outliers and surprise.

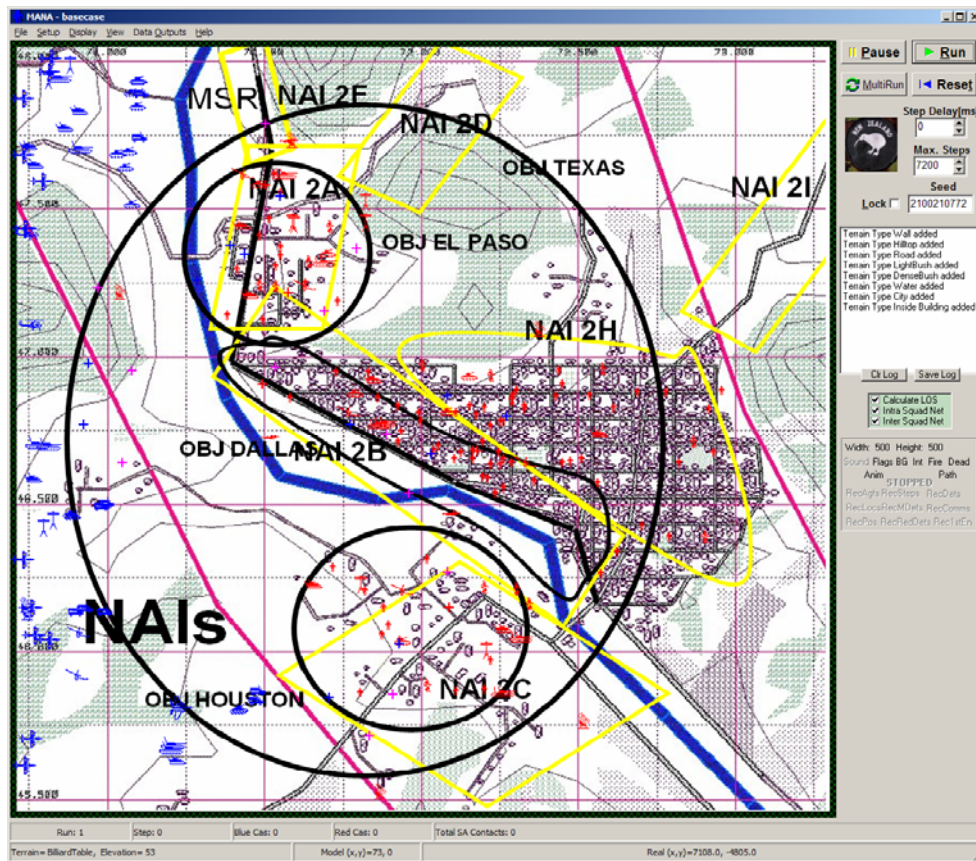

FIGURE ES1 Northeast Asia Area of Operation



The intent is to replicate the CASTFOREM vignette as closely as possible using an agent-based model (Map Aware Non-uniform Automata, or MANA) while exploring future aspects of UAVs. (Note: the original CASTFOREM vignette does not include the use of armed UAVs). This thesis studies the effectiveness of the FCS while varying the number, capabilities, and tactics of UAVs and considering the use of armed CL III battalion level UAVs. The primary goal is to identify a number of CL I, II, and III UAVs, for this specific MOUT region, where UAVs enable the effective use of precision munitions—thus enhancing the UA’s ability to fight. The analysis focuses on a critical 2-hour window of operation where the CAB assaults onto the urban objective.

The questions scoping this thesis are as follows:

- How many Platoon, Company, and Battalion level UAVs are needed for the FCS to secure the urban environment?
- How will armed battalion level UAVs enhance the FCS’s ability to secure the urban environment?
- Is it better to arm Warrior UAVs with Hellfire missiles at the CAB level, or to use APKWS 2.75 inch guided rockets with M151 HE warheads attached to the CL III UAVs?

Applying a Nearly Orthogonal Latin Hypercube design of experiment with 258 design points provided a multitude of data. Initial observations of the data portrayed three things:

- The enemy and terrain (two elements of mission, enemy, troops, terrain, and time or METT-T) provide greater significance to the mission outcome than the number and capability of UAVs deployed within the CAB at any level.
- The tactical employment, and capabilities of each UAV, provides greater significance to the CAB’s mission accomplishment than does the actual numbers of UAVs at each level.
- The joined platform capabilities within the FCS is so robust, that eliminating an entire platform category, such as all the UAVs from the battle space, has

little effect on the CAB's ability to still maintain 95% of its Dismount population while destroying 90% of the enemy HPTs.

The findings listed above were surprising to the author. As such, the author evaluated several outliers portraying greater detriment to the Blue Force. These outliers called for a slight modification to the original experimental design. Modifications stabilized the varying environmental and enemy factors at levels providing the greatest detriment to the Blue Force.

Upon applying the modified experimental design, the final analysis showed that within a critical 2-hour window of the CAB's assault on the urban terrain:

- 11 or more battalion level UAVs provide the FCS's ability to act quickly and decisively by bringing the biggest punch against the enemy as measured by both the proportion of HPTs killed and the proportion of Blue Dismounts Survived.
- The model portrays the CAB's increased lethality against the HPTs, while minimizing Blue Dismount deaths when adding precision munitions to CAB UAV assets.
- The CAB needs the CL III UAV for the deep fight and preparation of the battlefield by destroying the HPTs.
- Once the battlefield is prepared and the Dismounts arrive, then the CL I UAVs are more significant because they provide the local situational awareness (over the next hill) to these Dismounts.
- The APKWS missiles tend to provide more benefit to the mission immediately upon the start of the battle.
- As the battle moves on, Hellfire missiles become more significant as measured by the proportion of HPTs killed at 900 seconds.
- Hellfire missiles also seem to provide more application as measured by the proportion of Blue Dismounts survived at 900 seconds. However, at 900 seconds there is already a large loss to the Red Force.

- Each tactical team benefits when deployed with between one and three platoon level UAVs. The benefit of adding one platoon level UAV per team increases the overall CAB survival proportion of Blue Dismounts by almost one percent.
- Need at least one CL II UAV per tactical team. The exact number of CL II UAVs is still unknown from this thesis.
- Lower class UAVs provide the eyes “over the next hill” for Dismounts. Operators need to balance the tactical flight pattern in order to cover as much ground as possible while minimally loitering over detected targets.

THIS PAGE INTENTIONALLY LEFT BLANK

# I. INTRODUCTION

*"CEDAT FORTUNA PERITIS"*  
*(Skill is Better Than Luck)*  
*US Army Field Artillery School*

## A. TRANSFORMATION BACKGROUND

Unmanned aerial vehicles (UAVs) are playing an increasingly important role in the Global War on Terrorism (GWOT). These roles are part of the United States Department of Defense's (DoD's) greatest transformation of the armed forces since World War II. This transformation is a holistic approach to modernize our forces' equipment, methods, and tactics to ensure success for future conflicts. Dovetailing tomorrow's technology with innovative tactics will enable the US Army to transform into the next Future or Objective Force "in order to quickly and effectively respond to situations across a full spectrum of contingencies."<sup>1</sup>

The United States Army's adaptation of the new force structure intends to meet the needs of the next millennium. The vision for accomplishing this, as defined by the senior Army leadership, is to invest in a "leap ahead" capability that will be the heart of mounted close combat for the Army after next.<sup>2</sup> There exists the need to blend the capabilities of several battlefield-operating platforms, into a common System of Systems (SoS), that will re-engineer the Army's ability to quickly and effectively respond to situations across a full spectrum of contingencies. Tomorrow's threats pose complex asymmetric situations which demands our response with an Army capable of deploying a combat-capable brigade anywhere in the world within 96 hours, a full division in 120 hours, and five divisions on the ground within 30 days.<sup>3</sup> Rising technology, integrated with evolutionary tactics, will propel the US Army's transformation in its development of the Future Force to meet these needs.

---

<sup>1</sup> Examining the Army's Future Warrior, Force-on-Force Simulation of Candidate Technologies, Rand Arroyo Center, 2004, p. xi.

<sup>2</sup> Global Security.org, *Future Combat Systems – Background*, Retrieved 28 June 2005 from the World Wide Web at <http://www.globalsecurity.org/military/systems/ground/fcs-back.htm>

<sup>3</sup> Global Security.org, *Future Combat Systems*, Retrieved 1 August 2005 from the World Wide Web at <http://www.globalsecurity.org/military/systems/ground/fcs.htm>

The Army's Future Force (formerly "Objective Force") focuses on a lighter, more agile force, permitting the troops to move quickly and versatile in order to seize the initiative and finish decisively.<sup>4</sup> Since conventional systems are inadequate to facilitate all of the goals of the Army's transformation, the Army is developing the core building block of the Future Force—known as the Future Combat Systems (FCS) Family of Systems (FoS). The FCS is a networked "system of systems" comprised of 18 individual system platforms, the network, and the soldier.<sup>5</sup> These platforms are designed to operate in concert with each other using greater quantities of precision munitions, with minimal soldier manning. In addition, advanced communications and technologies will link soldiers with both manned and unmanned, ground and air, platforms and sensors.

The FCS has currently progressed into the System Development and Demonstration (SDD) Phase of its program.<sup>6</sup> It is a living entity, with almost monthly modifications, as new information regarding tomorrow's technological needs unfold. As such, it will be interesting for the reader to note the similarities and differences describing the FCS now and from a thesis written during the Concept and Technology Development (CTD) Phase by CPT Joseph Lindquist, June 2004, addressing degraded communications in the Army's Future force. Lindquist's references provided a stepping-stone for launching this research. Some of the source names are the same, but the publishing dates and source descriptions have changed. In addition, Lindquist's thesis served as a template to follow in format, as this thesis contains similar aspects with regard to the FCS and agent-based modeling.

As Lindquist pointed out, there exist two critical components to transform the vision of the Future Force into a prevailing reality. The first is the requirement of high situational understanding of the battlefield and the second is decisive tactical combat.<sup>7</sup> Situational understanding of both friendly and enemy forces permits the commander to

---

<sup>4</sup> Boeing, *Future Combat Systems*, Retrieved 15 November 2005 from the World Wide Web at <http://www.boeing.com/defense-space/ic/fcs/bia/about.html>

<sup>5</sup> Boeing, *Future Combat Systems*, Retrieved 5 August 2005 from the World Wide Web at <http://www.boeing.com/defense-space/ic/fcs/bia/about.html>

<sup>6</sup> US Army Material Systems Analysis Activity (US AMSAA), FCS UA Design Concept Baseline Description (UA-001-01-050124), 3 March 2005.

<sup>7</sup> Naval Postgraduate School Thesis, *An Analysis of Degraded Communications in the Army's Future Force using Agent Based Modeling*, Joseph M. Lindquist, June 2004, pp. 2-3.

enter the fight on his conditions and seize the initiative. Decisive tactical combat refers to sophisticated capabilities enabling mobility and long-range precision fires. This permits the commander to safely engage and attrite the enemy at a greater distance.<sup>8</sup> For purposes of this research, the former focuses more on the Command, Control, Communications, Computer, Intelligence, Surveillance, and Reconnaissance (C4ISR) and Reconnaissance, Surveillance, Target Acquisition (RSTA) of the battlefield. One excellent method to gain C4ISR and to perform RSTA for the FCS, while eliminating multiple inherent flight risks to humans, is with unmanned aerial vehicles (UAVs).

Before proceeding, it is important to identify FCS features. The Army is currently developing an Operational and Organizational plan to reorganize the current fighting force and field this revolutionary "leap ahead" system as the centerpiece of the Army's ground combat force between FY2015 and FY2020.<sup>9</sup>

*The FCS is the catalyst for achieving the Army's transformation vision of fielding a Future Force by the end of this decade. The Future Force will operate as part of a joint, combined, and/or interagency team, it will be capable of conducting rapid and decisive offensive, defensive, stability and support operations, and be able to transition among any of these missions without a loss of momentum. It will be lethal and survivable for warfighting and force protection; responsive and deployable for rapid mission tailoring and the projection required for crisis response; versatile and agile for success across the full spectrum of operations; and sustainable for extended regional engagement and sustained land combat. The FCS will network fires and maneuver in direct combat, deliver direct and indirect fires, perform intelligence, surveillance, and reconnaissance functions, and transport Soldiers and material as the means to tactical success.<sup>10</sup>*

Over time, the FCS may actually replace the current inventory of 'heavy' vehicles. Vehicles such as the Abrams tank, Bradley Fighting Vehicle, and Paladin howitzer may fade away, as the new family of manned and unmanned, ground and aerial vehicles enter the battlefield. The ground vehicles will weigh tremendously less, each

---

<sup>8</sup> US Army Training and Doctrine Command, *The Army Future Force: Decisive 21<sup>st</sup> Century Landpower Strategically Responsive Full Spectrum Dominate*. pp. 4-5.

<sup>9</sup> Global Security.org, *Future Combat Systems – Background*, Retrieved 28 June 2005 from the World Wide Web at <http://www.globalsecurity.org/military/systems/ground/fcs-back.htm>

<sup>10</sup> Global Security.org, *Future Combat Systems*, Retrieved 3 August 2005 from the World Wide Web at <http://www.globalsecurity.org/military/systems/ground/fcs.htm>

with the requirement of weighing less than 20 tons. Two of these smaller and lighter vehicles must fit inside one C-130 or C-141 cargo aircraft. Though lighter, the capabilities of each platform will increase, blending current single capabilities among multiple platforms. The combined capabilities include Line-of-Sight (LOS) / Beyond-Line-Of-Sight (BLOS) / Non-Line-of-Sight (NLOS) precision munitions weapon systems, robotic C4ISR platforms, soldier Land Warrior platforms, and support platforms. Hence, the FCS Family of Systems facilitates the response needs to the more complex and asymmetric future fronts, with the ability to deploy a brigade size element any where in the world, within the 96 hour time limit.<sup>11</sup>

The FCS is broken down into smaller elements; each called a Unit of Action (UA) (Refer to Figure 1). The UA will replace a brigade size element with modularity and agility. Within one UA, there exist three Combined Arms Battalions (CAB) comprised of a Headquarters and Headquarters Company, one Brigade Intelligence Company, one Communications Battalion, one NLOS Battalion, and a Forward Support Battalion. Within a CAB, there is a Headquarters Company, two to four Infantry Companies, two to four Mounted Combat System (MCS) companies, a Recon Troop, a Mortor Battery, and a Reconnaissance Surveillance Target Acquisition (RSTA) Squadron. These smaller organizations blend into smaller teams, allowing for a diverse tailorable force that moves with speed and versatility, allowing teams of troops to conduct a variety of missions on the future battlefield, including Military Operations in Urban Terrain (MOUT).

---

<sup>11</sup> Global Security.org *Future Combat Systems*, Retrieved 3 August 2005 from the World Wide Web at <http://www.globalsecurity.org/military/systems/ground/fcs.htm>



# Unit of Action Design

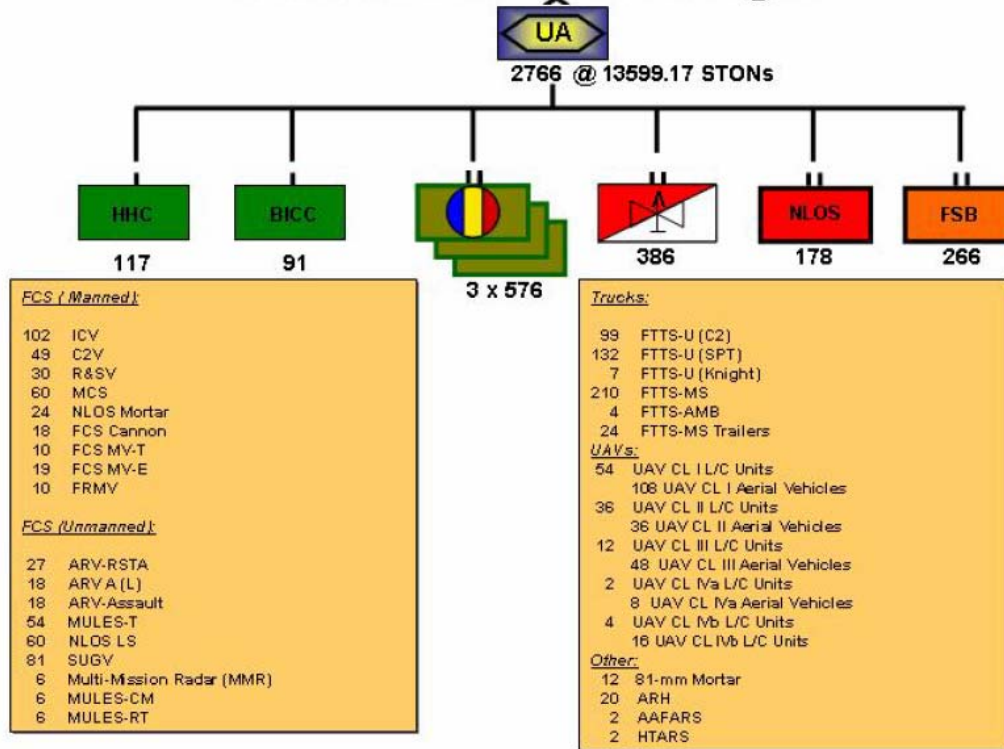

Figure 1. Unit of Action Tree Diagram<sup>12</sup>

*"PRIMUS AUT NULLUS"*  
*(First, or Not at All)*  
*1<sup>st</sup> Field Artillery*

## B. UAVS: THE FCS FACILATER

This area of research is significant because the Army's FCS relies heavily on unmanned air vehicles (UAVs) and unmanned ground vehicles (UGVs) to provide eyes on the battlefield. These eyes will trigger the deployment of precision munitions by fixed wing Close Air Support (CAS); Beyond-Line-of-Sight (BLOS) and Non-Line-of-Sight (NLOS) weapon systems; and possibly by UAVs themselves. As of September 2004, "some twenty types of coalition [unmanned aerial vehicles], large and small, have flown

<sup>12</sup> Unit of Action Maneuver Battle Lab, *Change 3, to TRADOC Pamphlet 525-3-90 O&O, The United States Future Force Operational and Organizational Plan Maneuver Unit of Action (DRAFT)*, 30 July 2004, Fort Knox, KY 40121, section 3.2, p.18.

over 100,000 total flight hours in support of Operation Enduring Freedom (OEF) and Operation Iraqi Freedom (OIF).”<sup>13</sup> The FCS UAVs are the hunters in the sky for tomorrow’s battles. In addition to triggering the deployment of precision munitions, they will provide situational awareness of the engagement area, and will assist in all communication aspects throughout the combat maneuver area and theater area of operations.

FCS UAVs are currently broken down into classes I, II, III, and IV(a, b). Class I UAVs within the FCS provide RSTA capabilities at the platoon level. Class II UAVs provide RSTA capabilities and target designation at the platoon and company level. Class III UAVs provide RSTA capability, target designation, communication relay, and mine detection at the combined arms battalion (CAB) level. Class IVa UAVs provide RSTA capability, target designation, communications relay, mine detection at the UA level and supports manned/unmanned teaming operations with manned aviation. Class IVb UAVs provide RSTA capability, target designation, communications relay, long endurance persistent staring, and wide area surveillance for the UA.<sup>14</sup>

Currently the US Air Force is using and testing Hellfire packed Predator UAVs. The Armed Forces is currently flying these UAVs in Afghanistan and Iraq, but little analysis explains the full effectiveness of armed UAVs on the battlefield.<sup>15</sup> In addition, the Army plans to procure 11 Warrior systems, a new Extended Range Multi Purpose (ERMP) UAV. Each system consists of 12 aircraft, five ground control stations and other support equipment. The Warrior begins operational deployment in 2009.<sup>16</sup> The once reconnaissance only role is now shared with strike, force protection, and signals collection, and, in doing so, has helped to reduce the complexity and time lag in the sensor-to-shooter chain for a broad range of mission capabilities.<sup>17</sup>

---

<sup>13</sup> Stephen Cambone, Kenneth Krieg, Peter Pace, Linton Wells, Unmanned Aircraft System Roadmap 2005-2015, Department of Defense, 4 August 2005, p. 1.

<sup>14</sup> US Army Material Systems Analysis Activity (US AMSAA), FCS UA Design Concept Baseline Description (UA-001-01-050124), 3 March 2005.

<sup>15</sup> United States Department of Defense, *Predator UAV Proves its Worth*, Retrieved 10 August 2005 from the World Wide Web at <http://usmilitary.about.com/cs/afweapons/a/preditor.htm>

<sup>16</sup> Greg Grant, “Army picks General Atomics for ERMP program,” Army Times, 8 Aug 2005, Retrieved 11 October 2005 from the World Wide Web at <http://www.armytimes.com/story.php?f=1-292925-1021240.php>

<sup>17</sup> Cambone, p. 1.

The Warrior contains flexible payloads, with equal lethality to the Air Force's Predator. The Army accelerated the [Extended Range Multi-Purpose UAV] ERMP program after US commanders in Iraq “clamored for a drone that could carry Hellfire missiles and perform the more traditional intelligence, surveillance, and reconnaissance mission.”<sup>18</sup> Though heavy, the Warrior can carry up to four Hellfire missiles. For lighter payload options, an Advanced Precision Kill Weapon System (APKWS) of guided rockets may also prove useful if attached to the current planned CL III UAV category. The Army accelerated the ERMP with precision munitions. Contradictory, FCS planners do not currently consider Hellfire, APKWS, or any other guided munitions, as part of any FCS UAV. Even though the ERMP UAV possesses a higher-class level than the current planned CAB Class III UAV, planners must consider “what if questions?” What effect occurs on the battlefield if the CAB gains control of UAV assets with Hellfire or lighter APKWS guided rocket payloads? For this thesis, Warrior and Class III UAVs will be similar for modeling purposes.

*"CELERITAS ET ACCURATIO"*  
*(Speed and Accuracy)*  
*Third Field Artillery Regiment*

### **C. PROBLEM STATEMENT**

The underlying questions of this research ask how many UAVs are needed, and how will armed UAVs affect mission performance? “Combatant Commanders are requesting [UAVs] in even greater numbers. Our challenge is the rapid and coordinated integration of this technology to support the joint fight.”<sup>19</sup> This research assumes that UAMBL’s classification and capabilities of FCS UAVs is correct, with the exception of possibly adding precision guided missiles to the CL III UAV. The UA planning numbers, as shown in Figure 1, per UAV class is part of the *FCS MSB Update*, dated 18 May 2005.<sup>20</sup> However, in speaking with experts from UAMBL, AMSAA, and TRAC,

---

<sup>18</sup> Greg Grant.

<sup>19</sup> Department of Defense, Memorandum for Secretaries of the Military Departments, Subject: Unmanned Aircraft Systems (UAS) Roadmap, 2005 -2015, 4 August 2005.

<sup>20</sup> Unit of Action Maneuver Battle Lab.

they all agree that more research similar to this needs to be completed between now and 2015. This additional research will help validate, field, and quantify the actual number of UAVs needed to facilitate a 24-hour operation in different environments. Continued research will also balance the needs of the future force along with the logistics necessary to create and support it. Advanced phases of the FCS program prompted AMSAA to change the name of the platform description manual from the Army Future Combat Systems Unit of Action Systems Book Version 3.0, 22 May 2003, to the FCS UA Design Concept Baseline Description (UA-001-01-050124). Upon starting this thesis in June 2005, the 9 May 2005 publication was the most up to date manual, which supersedes previous manuals dated 3 March 2005, and even 4 May 2005, which portrays constant updates due to advanced breaks in research.

In addition, Jane's Information Group, Inc. published a listing of the 59 US made UAVs, and 114 known foreign made UAVs.<sup>21</sup> Each year these numbers and the capabilities of each also increase. Traditionally, surveillance UAV military users have tended to regard them as semi-expendable battlefield assets. However, the continued development of more sophisticated UAVs, coupled with the platform design of the FCS, brings the need directly back for continued research.

With the collection of multiple programs, increasing UAV technologies, and future threats, a specific need exists to identify the number of UAVs, by class type and capabilities, needed to perform a variety of missions in different environments.<sup>22</sup> The Director, Headquarters United States Army Training and Doctrine Command, Futures Center, tasked the US Army Training and Doctrine Command (TRADOC), Analysis Center, to conduct an operational analysis of precision munitions deployed as part of the FCS FoS.<sup>23</sup> In an effort to assist in this essential task, this research focuses on UAV related key battlefield and targeting factors that necessitate precision delivery of effects,

<sup>21</sup> Kenneth Munson, *Jane's Unmanned Aerial Vehicles and Targets: Issue Twenty-Three*, (Alexandria: Jane's Information Group Inc, 2004), p. 20.

<sup>22</sup> Interview with Thomas Lancarich, Senior Operations Research Analyst, Chief, Scenario Integration & Methodology Development Division, TRADOC Analysis Center-White Sands Missile Range, New Mexico, 25 June 2005.

<sup>23</sup> Headquarters United States Army Training and Doctrine Command (Director Futures Center), Memorandum for U.S. Army TRADOC Analysis Center, Fort Leavenworth, KS, 9 July 2004.

and what acquisition force adjustments are relevant to the FCS-equipped UA and UEx organizations for the delivery of precision munitions.

This thesis applies a low-resolution model to examine TRADOC's tasked analysis questions regarding the effectiveness of the FCS within an urban environment. The objective is to identify a preferred numerical mix of class I, II, and III RSTA and precision guided rocket packed UAVs needed in a combined arms battalion of the Army's Future Force to identify, engage, and destroy enemy targets in a specified MOUT environment. This analysis output should not replace higher resolution physics-based modeling techniques. It does however; applaud the lower resolution data process for its delivery of quick results and analysis, while using limited resources, and possible uncovering hidden surprises.

*"NOLI ME TANGERE"*  
*(Do Not Touch Me)*  
*1<sup>st</sup> Battalion (ABN), 321<sup>st</sup> Field Artillery Regiment*  
*The U.S. Army's Only 155mm Airborne Artillery*

#### **D. SCOPE**

There exist countless questions regarding how to integrate UAVs into the Future Force. Mission, Enemy, Troops, Terrain, and Time (METT-T) has always scoped the battlefield. Friendly and enemy Order-of-Battle also play a key component on how to utilize UAVs. However, this thesis will only focus, and provide insight, on one Military Operations in Urban Terrain (MOUT) scenario.

This analysis focuses on an UA Combined Arms Battalion (CAB) attacking in a North East Asia area of operation. The scenario and Blue Force structure for the analysis is adopted from the Training and Doctrine Analysis Center—White Sands Missile Range (TRAC-WSMR) CASTFOREM modeled vignette started in the Spring of 2005.<sup>24</sup> The Red Force Order-of-Battle, modified slightly, represents a plausible stronger threat. This

---

<sup>24</sup> Thomas Lancarich, Senior Operations Research Analyst, Chief, Scenario Integration & Methodology Development Division, TRADOC Analysis Center-White Sands Missile Range, New Mexico *North East Asia Vignettes (Vignette NEA50.2) FCS BN(-) attack vs enemy stronghold of city, May 2005.*

ensures that the blue CAB does not gain complete victory with every simulation, thus facilitating the search for outliers and surprise.

The intent is to replicate this vignette as closely as possible using an agent-based model while exploring future aspects of UAVs. However, the original CASTFOREM vignette does not include the use of armed UAVs. Lastly, there is no complete analysis regarding data output from the CASTFOREM vignette. Therefore, this thesis will not compare and contrast the methodology, design of experiments, or output between both models, but will study the effectiveness of the FCS while varying the number of UAVs and considering the use of armed CL III battalion level UAVs. The primary goal is to identify a number of CL I, II, and III UAVs, for this specific MOUT region, where UAVs enable the effective use of precision munitions—thus enhancing the UA’s ability to fight.

To complete this thesis within the allotted time, with limited reasonable exploration, the following research questions scope the direction of this research:

- How many Platoon, Company, and Battalion level UAVs are needed for the FCS to secure the urban environment?
- How will armed battalion level UAVs enhance the FCS’s ability to secure the urban environment?
- Is it better to arm Warrior UAVs with Hellfire missiles at the CAB level, or to use APKWS 2.75 inch guided rockets with M151 HE warheads attached to the CL III UAVs?

## II. NORTHEAST ASIA ATTACK SCENARIO OVERVIEW

*"FESTINALENTE"  
(Make Hast Slowly)  
42nd Field Artillery Regiment*

The first portion of this chapter outlines the players within the scenario, while the second portion of this chapter outlines the actual scenario studied and then modeled within this research. The players are broken down into Blue and Red Forces. The Blue force is comprised of a Combined Arms Battalion with Unit of Action assets as part of the Future Combat Systems. The Red Force is the enemy. Their detailed description follows later in this chapter. There is no Neutral (Yellow) Force modeled.

### A. FCS SYSTEMS DESCRIPTION

The FCS is a networked “system of systems” comprised of 18 individual system platforms, the network, and the soldier.<sup>25</sup> These platforms operate in concert with each other using greater quantities of precision munitions, with minimal soldier staffing. In order to reduce the logistics burden on the FCS equipped UA, all FCS manned platforms have a common core chassis, and a common set of base capabilities. Each platform will weigh less than 20 tons in order to fly two FCS platforms inside of one C-130 cargo aircraft. To facilitate weight requirements, counter ballistic protection, and add-on armor capabilities substitute the full-up armor protection observed on today’s manned platforms.<sup>26</sup> In addition, advanced technologies will link soldiers to any combination of manned, unmanned, air, and ground platforms or sensors.

---

<sup>25</sup> Boeing, *Future Combat Systems*, Retrieved 5 August 2005 from the World Wide Web at <http://www.boeing.com/defense-space/ic/fcs/bia/about.html>

<sup>26</sup> US Army Material Systems Analysis Activity (US AMSAA), Army Future Combat Systems Unit of Action Systems Book Version 3.0, 22 May 2003.



Figure 2. Future Combat Systems: Platforms <sup>27</sup>

The following paragraphs describe each FCS system modeled within this vignette. Each FCS description is a direct excerpt from one of three sources. Paragraph 1 comes directly from one of the Unit of Action Maneuver Battle Lab's Operational Requirements Document.<sup>28</sup> Paragraphs 2 through 11 are direct excerpts from the FCS UA Design Concept Baseline Description.<sup>29</sup> Paragraphs 12 and 13 arrive directly from the World Wide Web.

### 1. Unmanned Aerial Vehicle - Class I, II, and III

The Class III Unmanned Aerial Vehicle (CL III UAV) is a multifunction aerial system capable of providing reconnaissance, security/early warning, target acquisition, and designation for precision fires, throughout the battalion area of influence by remotely over-watching and reporting changes in key terrain, avenues of approach and danger

<sup>27</sup> Global Security.org *Future Combat Systems*, Retrieved 17 November 2005 from the World Wide Web at <http://www.globalsecurity.org/military/systems/ground/images/fcs-2005armymodernization.jpg>

<sup>28</sup> Unit of Action Maneuver Battle Lab, *Change 1, to Joint Requirements Oversight Council (JROC) – approved Future Combat Systems (FCS) Operational Requirements Document (ORD)*, June 2004, Fort Knox, KY 40121, Annex E.

<sup>29</sup> US Army Material Systems Analysis Activity (US AMSAA), FCS UA Design Concept Baseline Description (UA-001-01-050124), 3 March 2005.



areas in open, rolling, restrictive, and urban areas. The aerial system will provide information from operating altitude and standoff range both day/night and in adverse weather. The aerial system should be capable of communication relay, detecting mines, performing CBRN detection, and performing meteorological survey for the NLOS battalion to deliver precision fires.

The UAV at the Battalion level must provide multiple capabilities, to include: Reconnaissance and security/early warning capability for the UA during day and night; Remotely over-watch and report changes in key terrain, avenues of approach and danger areas in open and restrictive terrain, and urban areas; Perform target acquisition and designation for the UA; Act as a communications (wide band) relay; Perform target area meteorological survey; Does not require an airfield; Support CAB by performing R&S on a minimum of three routes or nine NAIs; Enable NLOS targeting and fires.

The CL II UAV is a multifunctional aerial system capable of providing reconnaissance, security/early warning, target acquisition, and designation for the Infantry Company and MCS Platoon within the UA in support of LOS/BLOS and NLOS cooperative engagements. The CL II UAV will be a vehicle-mounted system that provides LOS enhanced dedicated imagery. This capability greatly reduces the operational and tactical risks associated with small unit operations in all environments. CL II UAVs provide RSTA operations under canopy, open, rolling, complex, and urban terrain. It is carried by selected platforms and capable of autonomous flight and navigation. The aerial system should be capable of acting as a communication relay.

The CL II UAV supports the following tasks: Provide a reconnaissance and security/early warning capability for the UA, day or night; Remotely over-watch and report changes in key terrain, avenues of approach and danger areas in open and restrictive terrain, and urban areas; Perform target acquisition for the UA (LOS, BLOS and NLOS); Perform limited communications relay; Provide teaming opportunity between itself and other manned systems for the purpose of target acquisition, R&S; Does not require an airfield; Capable of covering three Named Areas of Interest (NAIs).

The CL I UAV provides RSTA operations in open, rolling, complex, and urban terrain under canopy, and in MOUT. Selected platforms and dismounted soldiers will

manpack the UAV. It will use autonomous flight and navigation with Vertical Take-off and Landing (VTOL).

One system consists of two UAVs and a control interface, which displays the information to the operator and allows human interface with the AV. The control interface is interoperable with the dismounted soldier and the FCS Battle Command system for mounted control. The system will provide a networked SA capability to the UA and small unit (platoon), in all missions, securing areas, and providing RSTA. Soldiers will employ the system and dismounted soldiers will carry it in a container that fits within a man-packed "MOLLE pack" and protects the system from the effects of the weather and terrain (rain, dust, etc).

The CL I UAV supports the following tasks: Provide a reconnaissance and security/early warning capability for the UA, day or night; Remotely over-watch and report changes in key terrain, avenues of approach and danger areas open, rolling and restrictive terrain, and urban areas; Provide target information for the LOS/BLOS; Provide target information for area fire munitions; Perform limited communications relay (narrow band, short duration) in restrictive terrain within echelon; Does not require airfields.

## **2. Mounted Combat System (MCS)**

The Future Combat System's (FCS) Mounted Combat System (MCS) is a manned combat platform that provides offensive maneuver to close with and destroy enemy forces. The MCS is a joint effort between the Army and the Defense Advanced Research Projects Agency intended to replace the Army's current fleet of General Dynamics M1 Abrams tanks, United Defense M2 and M3 Bradley Fighting Vehicles and other armored vehicles.

## **3. Infantry Carrier Vehicle (ICV)**

The ICV is the FCS Manned Combat Platform that provides the mobility for 11 personnel (two-man crew and nine-man infantry squad) on the battlefield. It is located within the infantry platoons and companies within the CAB. The ICV delivers dismounted forces to the close battle, supports the squad by providing self-defense weapons support, and carries the majority of equipment freeing the individual soldier of excess weight.

#### **4. Armed Robotic Vehicle Assault Variant (ARV-A)**

The ARV-A provides the Infantry platoon Reconnaissance, Surveillance, and Target Acquisition (RSTA), direct fire and BLOS capabilities in support of maneuver and dismounted operations. It responds to actions on contact, executing fire and maneuver and tactical assault to ensure lethality overmatch. It supports cooperative engagements in the full variety of terrain sets including "point and shoot" engagements by dismounted soldiers and designation of firing missions from other platforms or dismounted elements. ARV-A is the primary unmanned ground platform for reconnaissance and surveillance operations and the primary unmanned ground system enabler of BLOS in the Infantry platoon. The ARV-A RSTA mission is three-fold: Provide the sophisticated on-board sensors; Enable the delivery of precision BLOS fires; Detect, recognize, and identify targets with enough fidelity to support the use of LOS, BLOS and NLOS assets to support cooperative engagement.

#### **5. Armed Robotic Vehicle Assault Variant (ARV-L)**

The ARV-L is an FCS Unmanned System, transportable by UH-60 that will remotely provide reconnaissance capability and provide LOS/BLOS over-watching fires.

#### **6. Armed Robotic Vehicle - Reconnaissance Surveillance, and Target Acquisition Variant (ARV-RSTA)**

The Armed Robotic Vehicle-Reconnaissance, Surveillance, and Target Acquisition (ARV-RSTA) is the primary unmanned ground platform for reconnaissance and surveillance operations and the primary unmanned ground system enabler of BLOS in the MCS Company within the Unit of Action. The ARV-RSTA's mission is three-fold: Provide the Recon Troop Scout with sophisticated on-board sensors; Enable the Mounted Combat System delivery of precision BLOS fires; Detect, recognize and identify targets with enough fidelity to support the use of LOS, BLOS and NLOS assets to support cooperative engagement.

#### **7. Reconnaissance and Surveillance Vehicle (R&SV)**

The R&SV is the FCS Manned Combat Platform that conducts streamlined acquisition, discrimination of multiple target sets, and provides a dynamic hunter-killer capability using on-board systems and Comanche and other UA organic, UE, Joint, and Coalition lethal systems. It provides sophisticated on-board sensors and a suite of tools to integrate other sensors such as MASINT, SIGINT, and EO/IR. It is employed within

teams of both manned and unmanned robotics sensor platforms as well as unattended systems. Highly trained multi-functional scouts operate it. It provides sensors that will detect, locate, track, classify, and automatically identify targets from increased standoff ranges under all climatic conditions, day or night.

#### **8. Non-Line-of-Sight Mortor (NLOS Mortor)**

NLOS Mortors are the FCS Manned Combat Platform that provides short-range indirect fires in support of assault battle units. It accommodates a smoothbore 120 mm Mortar System, which can fire the full family of mortar ammunition (HE, illumination, IR illumination, smoke, precision-guided, DPICM, training, and non-lethal).

#### **9. Non-Line-of-Sight Launch System (NLOS LS)**

NLOS LS is the FCS System that provides networked, extended-range targeting and precision attack of armored, lightly armored, stationary, and moving targets during day, night, obscured, and adverse weather conditions. The system's primary purpose is to provide responsive precision attack of High Pay-off Targets in support of the UA in concert with other UA NLOS, external and Joint capabilities. The system also provides "discriminating" capability via automatic target recognition and limited battle damage assessment.

#### **10. Non-Line-of-Sight Cannon (NLOS Cannon)**

NLOS Cannon is the FCS Manned Combat Platform that provides networked, extended-range targeting and precision attack of point and area targets in support of the UA with a suite of munitions that include special purpose capabilities. It provides sustained fires for close support and destructive fires for tactical standoff engagement. It provides responsive fires in support of Combined Arms Battalions and their subordinate units in concert with LOS, BLOS, NLOS, external, and joint capabilities. It provides flexible support through its ability to change effects round-by-round and mission-by-mission. It provides rapid response to calls for fire, high rate of fire, and a variety of effects on command.

#### **11. Land Warrior System**

Existing program leveraged by FCS that provides an overwhelmingly lethal and survivable Soldier System of Systems capable of dominance across the entire spectrum of operations. For purposes of this model, two separate types of infantry soldiers

transported via the ICV model the Land Warrior. One type of modeled soldier is using an M-16 rifle, and the other modeled soldier is using an M-249 squad automatic weapon.

### **12. Apache Attack Helicopter AH-64D**

The AH-64D is a quick-reacting, airborne weapon system that can fight close and deep to destroy, disrupt, or delay enemy forces. The Apache is designed to fight and survive during the day, night, and in adverse weather conditions throughout the world. The principal mission of the Apache is the destruction of high-payoff targets using the HELLFIRE missile. It is also capable of employing a 30 mm M230 chain gun and Hydra 70 (2.75 inch) rockets that are lethal against a wide variety of targets. The Apache has a full range of aircraft survivability equipment and has the ability to withstand hits from rounds up to 23 mm in critical areas.<sup>30</sup>

### **13. JSF (Joint Strike Fighter)**

The Joint Strike Fighter (JSF) is a multi-role fighter optimized for the air-to-ground and close-air-support (CAS) roles, designed to affordably meet the needs of the Air Force, Navy, Marine Corps and allies, with improved survivability, precision engagement capability, the mobility necessary for future joint operations and the reduced life cycle costs associated with tomorrow's fiscal environment. JSF will benefit from many of the same technologies developed for F-22 and will capitalize on commonality and modularity to maximize affordability.<sup>31</sup>

## **B. RED FORCE DESCRIPTION**

The enemy does not obtain a characterization of any traditional military echelon, but is rather decentralized and autonomous in nature. Enemy descriptions listed in the following paragraphs are excerpts from the Federation of American Scientists (FAS) Military Analysis Network.<sup>32</sup>

---

<sup>30</sup> FAS Military Analysis Network, *AH-64 Apache*, Retrieved 22 September 2005, from the World Wide Web at <http://www.fas.org/man/dod-101/sys/ac/ah-64.htm>

<sup>31</sup> FAS Military Analysis Network, *Joint Strike Fighter*, Retrieved 22 September 2005, from the World Wide Web at <http://www.fas.org/man/dod-101/sys/ac/jsf.htm>

<sup>32</sup>Federation of American Scientists, Retrieved 22 September, from the World Wide Web at <http://www.fas.org/main/home.jsp>

### **1. BMP-3 System**

The BMP-3 was accepted for service in 1990 and while of a similar size to other Infantry Fighting Vehicles (IFVs) it is more heavily armed than any previous IFV as it mounts a 100mm 2A70 rifled gun, 30mm 2A42 cannon and a 7.62mm PKT machine gun.<sup>33</sup>

### **2. 82 Mortor System**

The 82 mm Mortor unit provides unique indirect fires that are organizationally responsive to the ground maneuver commander. Military history has repeatedly demonstrated the effectiveness of mortars. Their rapid, high-angle, plunging fires are invaluable against dug-in enemy troops and targets in defilade, which are not vulnerable to attack by direct fires.<sup>34</sup>

### **3. Dismounted Soldier**

The dismounted soldier contains an array of capabilities and threats. The following sub-paragraphs identify the weapon systems fired by the dismounted soldiers.

#### ***a. Surface-to-Air System (SA-16)***

SA-16 GIMLET (Igla-1 9K310) man-portable surface-to-air missile system, a further development from the SA-7 & SA-14 series, is an improved version of the SA-18 GROUSE, which was introduced in 1983, three years before the SA-16. Features added to the SA-16 include a new “seeker” and modified launcher nose cover. The 9M313 missile of the SA-16 employs an Infrared (IR) guidance system using proportional convergence logic, and an improved two-color seeker, presumably IR and UV.<sup>35</sup>

#### ***b. Rocket Propelled Grenade System (RPG 7)***

The RPG-7 anti-tank grenade launcher is one of the most common and most effective infantry weapons in contemporary conflicts. It is rugged, simple and carries a lethal punch. Whether downing US Blackhawk helicopters in Somalia, blasting

---

<sup>33</sup> Zaloga, Steven J. *BMP Infantry Combat Vehicle*, 2nd Ed, Concord Publications, 1990, Hong Kong.

<sup>34</sup> FAS Military Analysis Network, *Mortars*, Retrieved 23 September 2005, from the World Wide Web at <http://www.fas.org/man/dod-101/sys/land/mortars.htm>

<sup>35</sup> FAS Military Analysis Network, *SA-16 Gimlet*, Retrieved 23 September 2005, from the World Wide Web at <http://www.fas.org/man/dod-101/sys/missile/row/sa-16.htm>

Russian tanks in Chechnya, or attacking government strong points in Angola, the RPG-7 is the weapon of choice for many infantrymen and guerrillas around the world.<sup>36</sup>

**c. Anti-Tank System (AT-7)**

The Russians characterize the AT-7 ATGM as a complex and light or man portable (5-20 kg) anti-tank system. It permits long-distance carry by dismounted infantry. Since the module is small, and fires quickly corrected by shifting its field of view, it may also be used to engage hovering or stationary helicopters.<sup>37</sup>

**d. RPK-74**

The RPK-74 is a machine gun version of the AKM-74, firing the same ammunition. Instead of the prominent muzzle brake used on the AK-74, the machine gun has a short flash suppressor. The magazine is longer than that normally used with the AK-74, but the magazines are interchangeable. The RPK-74 has a bipod.<sup>38</sup>

**4. Armored Personnel Carrier (APC) BTR-80**

The BTR-80 is a modern, lightly armored vehicle with a diesel power train. It has been in service since the early 1980s. The BTR-80 is a lightly armored amphibious vehicle with a collective chemical-biological-radiological (CBR) protective system. Operated by a crew of three, the vehicle can deliver a squad of seven infantry troops on the battlefield while provide close fire support. It can also perform reconnaissance, combat support and patrol missions.<sup>39</sup>

**5. T-72 Tank System**

The T-72, is a Russian medium size tank which entered production in 1971. The T-72 has six large road wheels and three track return rollers, which carries a 120 mm main gun capable of firing both traditional and precision guided munitions.<sup>40</sup>

---

<sup>36</sup> Lester W. Grau, *For All Seasons: The Old But Effective RPG-7 Promises to Haunt the Battlefields of Tomorrow*, Foreign Military Studies Office, Fort Leavenworth, KS Retrieved 23 September 2005 from the World Wide Web at <http://www.g2mil.com/RPG.htm>

<sup>37</sup> FAS Military Analysis Network, *AT-7*, Retrieved 23 September 2005, from the World Wide Web at <http://www.fas.org/man/dod-101/sys/land/row/at-7.htm>

<sup>38</sup> Retrieved 23 September 2005 from the World Wide Web at [http://www.sovietarmy.com/small\\_arms/rpk-74.html](http://www.sovietarmy.com/small_arms/rpk-74.html)

<sup>39</sup> FAS Military Analysis Network, *BTR-80*, Retrieved 11 October 2005, from the World Wide Web at <http://www.fas.org/man/dod-101/sys/land/row/btr-80.htm>

<sup>40</sup> FAS Military Analysis Network, *T-72*, Retrieved 23 September 2005, from the World Wide Web at <http://www.fas.org/man/dod-101/sys/land/row/t72tank.htm>

### **C. MODEL VIGNETTE DESCRIPTION**

TRAC-WSMR provided the initial vignette, Northeast Asia (NEA) 50.2, for the basis of this research. The nomenclature NEA 50.2 identifies the specific vignette modeled within CASTFOREM at TRAC-WSMR. NEA 50.2 grew from the NEA 50 scenario modeled within VIC at TRAC-Leavenworth. NEA 50.1 is the same scenario but modeled with CASTFOREM. The difference between NEA 50.1 and NEA 50.2 lays within the Blue force Structure. NEA's 50.1 Blue Force is a traditional Brigade Combat Team (BCT). NEA's 50.2 Blue Force is a Combined Arms Battalion (CAB), as part of a Unit of Action (UA), from the Army's Future Combat Systems.

The use of the model, Map Aware Non-Uniform Automata (MANA), replicates the CASTFOREM NEA 50.2 vignette. The following chapter provides an overview of MANA. The initial scenario models an 18-hour battle, starting from the initial Start Position (SP), followed by the Order of March towards the Release Point (RP), and finishes with the attack of an urban location. However, the scope of this thesis focuses on modeling a critical 2-hour window of the NEA 50.2 scenario using MANA. This critical 2-hour window models the overwhelming mission and goal of the CAB to clear and secure OBJ DALLAS within an urban terrain (OBJ TEXAS) in a timely manner (See Figure 3).



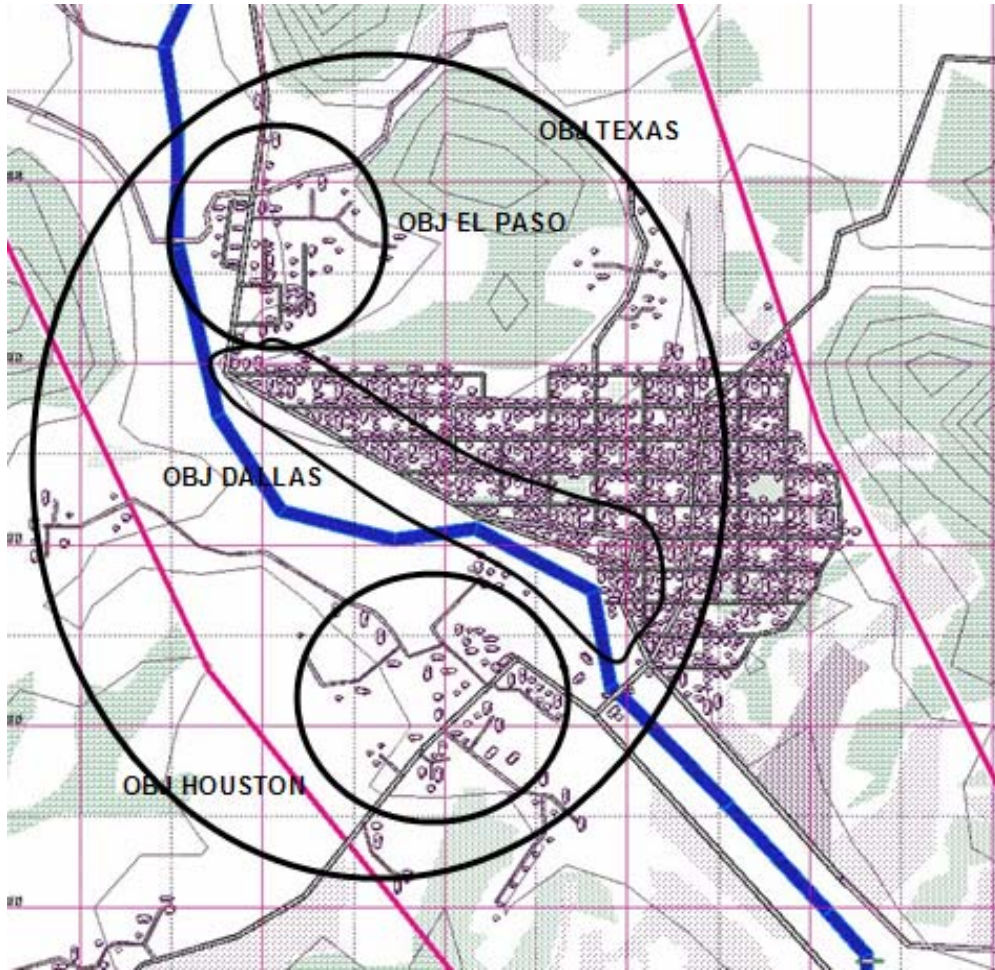

Figure 3. NEA 50.2 Area of Operation Map

Control of this key terrain is extremely important because follow on units from the Southeast will need to use OBJ TEXAS as part of a main supply and logistics route in order to continue another advance towards the capitol city located Northwest of OBJ TEXAS.<sup>41</sup> The terrain surrounding the urban area is quite mountainous and covered with varying dense vegetation. Along the avenue of approach is a river. The FCS platforms are tested in their ability to negotiate all obstacles providing protection to the forces in the city as well as the FCS's ability to use LOS, BLOS, NLOS weapons in a completely networked manner to clear and ultimately secure the city. The city itself provides varying buildings and urban obstacles that may hamper the FCS's ability to clear and

---

<sup>41</sup> Brigade and Below Scenario (BBS) slide show, March 2005, provided by Mr. Tom Loncarich, TRAC-WSMR during office visit 25 June 2005.

secure the area in a timely manner. Not modeled in this vignette is a BCT arriving from the East to secure the denser part of the city easterly of OBJ DALLAS.

Figure 4 outlines the Blue Force Combined Arms Battalion (CAB) disposition. The CAB, with additional UA assets, is blended into four teams; A, B, C, and D, as shown in Table 1. Each team has a specific mission. Team A provides reinforcing fire and support from a position West of OBJ TEXAS. Teams C and D will cross the river to the North and advance onto OBJ EL PASO and OBJ DALLAS. Team B secures OBJ HOUSTON and provides over-watching fires as Team C secures OBJ EL PASO and allows a passing of lines from Team D to secure OBJ DALLAS.

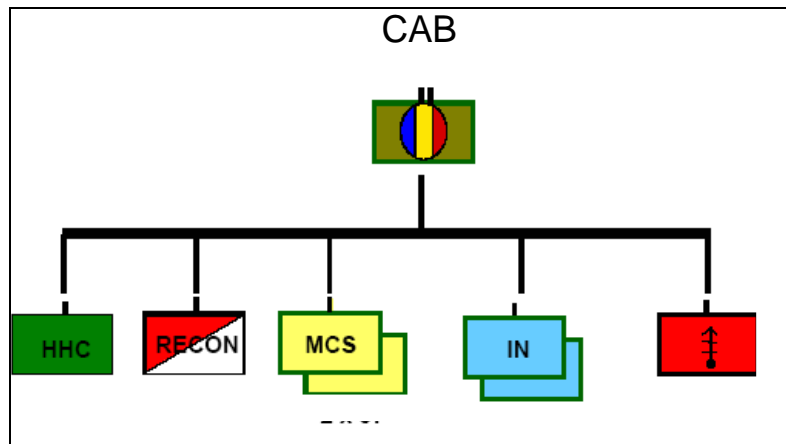

Figure 4. Combined Arms Battalion Tree Diagram

		ICV	MCS	R&SV	NLOS-M	ARV-RSTA	ARV-Assault	ARV-Light	CL I UAV	CL II UAV	CL III UAV	NLOS-C	NLOS-LS	JSF Air Strike Force	AH 64 D
Team A	MCS PLT 1		3			1									
	MCS PLT 2		3			1									
	INF PLT 3	5					1	1	2						
	HQ		1							3					
Team B	MCS PLT 1		3			1									
	MCS PLT 2		3			1									
	INF PLT 3	5					1	1	2						
	HQ		1							3					
Team C	INF PLT 1	5					1	1	2						
	INF PLT 2	5					1	1	2						
	MCS PLT 3		3			1									
	MTR SEC				2										
	HQ	1								3					
Team D	INF PLT 1	5					1	1	2						
	INF PLT 2	5					1	1	2						
	MCS PLT 3		3			1									
	MTR SEC				2										
	HQ	1								3					
REC TRP	REC PLT 1			3		1			6						
	REC PLT 2			3		1			6						
	REC PLT 3			3		1			6						
	UAV SEC									12					
MTR BAT (-)	MTR PLT				4										
UA Supporting Assets															
UA NLOS A BAT (+)															
NLOS PLT 1															
NLOS PLT 2															
Air Assets															
															6

Table 1. NEA 50.2 Team Disposition

Table 2 outlines the enemy force disposition. In order to maintain an unclassified thesis, the true enemy (Red Force Order of Battle) from the original vignette will remain unidentified. However, within the limits of an unclassified disclaimer, a traditional military echelon does not characterize the enemy, but the enemy is rather decentralized and autonomous in nature. Each enemy soldier and platform has 100% strength and capabilities. A generality of the enemy from the original vignette is as follows:

*The Operational Environment that the Threat would assume, from what I believe our Threat Experts would tell you, is that few armored vehicles would be isolated in any one urban area. They would be in small groups, platoon size or less, and would be scattered throughout the entire terrain area in hidden positions. They would move only short distances to avoid detection from aerial sensors, and would be used only when it was felt they would be at an advantage in an isolated situation.*

*-Tom Loncarich, Senior Operations  
Research Analyst (TRAC-WSMR)*

The author modeled this type of enemy, but assumed greater numbers with more aggressiveness and lethality. Tom Loncarich noted that the disposition of the modeled Red Force assumed for the MANA scenario is rather, “more high-end, aggressive threat excursion. Perhaps possible, but not probable.” Since this research includes the use of “Data Farming” tools intended to unleash possibility and surprise, and the ability to use an exhaustive and thorough Design of Experiments exists, then there presents a need to model a flexible and challenging enemy Order of Battle in order to identify any “what if” or “worst case” plausible outcomes.

<b>Asset</b>	<b>Quantity</b>
Red BMP-3	6
Red 82 Mortors	6
Red SA-16 Infantryman	5
Red RPG-7	8
Red AT-7	5
Red Scout	5
Red RPK-74	6
Red AK-M Infantryman	80
Red SVD	3
Red APC	6
Red T-72	6

Table 2. Red Force Disposition

The Red Force uses the urban area as a hide position in order to attack the Blue Force when advantageous. The Red Force mission within the urban area is to defend and deny US and allies access to important avenues of approach, in order to help protect the regime from intervention by US and combined forces.<sup>42</sup>

---

<sup>42</sup> Brigade and Below Scenario (BBS) slide show, March 2005.

THIS PAGE INTENTIONALLY LEFT BLANK

### III. MODEL DEVELOPMENT

*"SIC ITUR AD ASTRA"*  
*(This Is the Way to the Stars)*  
*102D FIELD ARTILLERY REGIMENT*

The purpose of this chapter is three fold. First, it provides the reader with an understanding of the model. Second, it provides a methodology for developing an advanced simulation technique. Some readers may consider the second point of most interest as it provides systematic directions, explaining the author's methodology to develop the critical values within this scenario. Considering George Box's quote that "all models are wrong, some are useful," the last part of this chapter outlines limitations within the modeling environment and the techniques the author used to develop a useful scenario within the model.

Looking back, nobody really knows when humans first introduced simulation to represent warrior battle maneuvers. Possibly, a polished stone represented the first "toy soldier" and a flat piece of dirt represented his battle space. Historians accredit Sun Tzu, the Chinese general and military philosopher, as inventing the first simulation, or war-game, known as *Wei Hai* (meaning "encirclement") about five thousand years ago.<sup>43</sup> Though initially titled as a game, it truly offered a primitive simulation process that replicated a battle as many times as the player desired, training a military mindset in the art of war. Improved simulation techniques continued to emerge through the years.

#### A. AGENT-BASED SIMULATION (ABS) OVERVIEW

The Department of Defense (DoD) incorporates simulation modeling techniques to support decision makers. Primarily, DoD simulation models encompass high-resolution, complex, and resource intensive modeling procedures.

*The scenario generation process for our high-resolution simulations is man-hour intensive and requires detailed knowledge of the simulation's underlying data and operating assumptions. Often times, the analyst is*

---

<sup>43</sup> Peter P. Perla, *The Art of War-Gamming*, United States Naval Institute, Annapolis, Maryland, 1990, p. 15.

*limited to a small set of simulation runs due to the simulation's complexity, scenario development constraints, and the decision maker's timeline. Consequently, they may only obtain a limited view of possible outcomes.*<sup>44</sup>

For example, to replicate a howitzer firing a projectile in a high-resolution model, the analyst must know more information than just the classical 'trajectory in a vacuum' physics problem. Instead, the analyst must take into account interior, exterior, and terminal ballistics. Each includes, but is not limited to, factors such as projectile square weight, propellant temperature, propellant moisture, muzzle velocity variation, and tube wear effecting interior ballistics, as well as meteorological atmospheric conditions such as air temperature, air moisture, wind direction, wind speed, and the rotation of the Earth effecting exterior ballistics. These examples only name a few factors that the analyst could consider when modeling the howitzer firing the projectile. This process then repeats for every other howitzer in the battery, positioned at different locations, and any other munitions also fired. As such, a simulation requiring multiple munitions, from several platforms demands significant computing ability just to provide the decision maker with useful insights required for his decision.

As a result, an innovative class of simulation, known as agent-based simulation (ABS), emerged as a low-resolution simulation to compliment, and augment, previously established more computationally intensive physics-based simulation models. The role of ABS should not replace high-resolution models. However, the author maintains that over the past few years, ABS increasingly proves useful to the DoD in primarily two areas. The first is to use ABS up front in an exploratory analysis, in order to gain quick insight and narrow the focus of seemingly endless possibilities of factors, parameters, and variables in order to expedite building high-resolution physics-based simulations.<sup>45</sup> This saves time and money on the front end of a simulation project. The second is to use ABS in order to offset timely resource intensive key battlefield objectives that otherwise require excessive recourses in physics-based models. Here the analyst switches back and forth between two models in order to gain advanced scenario insight.

---

<sup>44</sup> Lloyd Brown, Thomas Cioppa, and Thomas Lucas, "Agent-Based Simulations Supporting Military Analysis," *Phalnex*, April 2004.

<sup>45</sup> Brown, Cioppa, and Lucas.



Insight, surprise, and outliers all hail from analysis. ABS offers quick scenario generation, fast run times, rapid data turn around, and permits the analyst to consider many alternatives in a short amount of time. ABS complements and augments physics-based models permitting analysts to examine the problem over a greater range of plausible possibilities, while helping to fix the aforementioned quantities.

## **B. WHY MANA?**

The author chose Map Aware Non-Uniform Automata (MANA) as the agent-based simulation-modeling tool to support this research. MANA's individual agent and squad situation awareness (SA) aptitude, coupled with its networked communication parameters supports use of this tool to replicate the NEA 50.2 scenario.

*FCS are networked via a C4ISR architecture including networked communications, network operations, sensors, Battle Command system, training, and both manned and unmanned reconnaissance and surveillance (R&S) capabilities that will enable levels of SA and synchronized operations heretofore unachievable.*<sup>46</sup>

New Zealand's Defense Technology Agency (DTA), initially developed MANA, and has continuously updated the model as needed. As a general notation, the MANA User Handbook provides direct annotation for the following paragraphs.<sup>47</sup>

The reader must first appreciate the meaning of MANA. Concurring with Lindquist's dissection<sup>48</sup> of each word constructing the acronym MANA, we have:

- Map Aware — Agents are aware of and respond to, not only their local surroundings and terrain, but also a collective registry of recorded battlefield activities.
- Non-Uniform — Not all agents move and behave in the same way (much like soldiers, sailors or airmen).

---

<sup>46</sup> Unit of Action Manuever Battle Lab, TRADOC Pam 525-3-90, Future Force Operational and Organization Plan, Maneuver Unit Action, with Change 3, Fort Knox, KY, 30 July 2004.

<sup>47</sup> Galligan, David P., Mark A. Anderson, Michael K. Lauren, *Map Aware, Non-Uniform Automata version 3.0*, New Zealand Defense Technology, July 2004.

<sup>48</sup> Lindquist, p.27.

- Automata — Agents can react independently to events, using their own “personalities.” Personalities, in general, are propensities that guide an agent’s actions to move.

Fundamentally, analysts use MANA for two reasons. The first is because the behavior of the entities within a combat model (both friend and foe) adds possibilities to the analysis of the possible outcomes. The second is because analysts have limited time to determine particular force mixes and each side’s combat effectiveness necessary for programming into higher resolution models.

The behavior of troops in any given scenario plays an important role in simulations. However, as is the weather, human nature is mathematically intangible, and often overlooked by analysts. MANA, as with other ABMs, contains entities controlled by decision-making algorithms. Hence, agents representing military units make their own decisions, as opposed to the modeler explicitly determining their behavior in advance.

To differentiate MANA from highly detailed models also using agents, analysts sometimes refer to MANA as an Agent Based Distillation (ABD), which reflects the intention to model only the essence of a problem. MANA falls into a subset of these models, called cellular automaton (CA) models. CA models have their origin in physics and biology. The famous Ising model of magnetic spin alignment is an example of such a model in physics, while Conway’s “Game of Life” is an example of a CA model designed to explore biological ideas. MANA and other CA models encompass complex adaptive systems (CAS) properties because entities react to their surrounding. Agents’ decisions, actions, and reactions alter as agents switch among their state conditions. Some properties exhibited in MANA include:

- Local interactions among agents emerge into a “global” behavior
- Agents interact with each other in non-linear ways, and “adapt” to their local environment
- The influence of situational awareness when deciding an action
- The importance of sensors and how to use them to best advantage

MANA users may sit down and obtain a good understanding of the model within a few short hours, while completing their first scenario soon after. MANA offers a simple to use graphical user interface (GUI), including drop down window capabilities much like many Window based applications. As a reminder, the preceding information came primarily from the MANA User Handbook.

### C. MODELING METHODOLOGY

This section describes detailed information used to create the scenario within the MANA model. In turn, it provides the reader a methodology to facilitate the model development process implemented within this simulation technique. The reader wishing more detail may consider viewing each corresponding section within Appendix A, SPREADSHEET MODELING to the section headings within this chapter prior to advancing to each new section. Each appendix shows a snapshot of modeling spreadsheets built with Excel. Spreadsheet modeling describes the approach implemented to transform real world data into scaled MANA values.

#### 1. Scaling: Configure Battlefield Settings

Scaling the scenario is the most important step, as it also parallels as the first step. The model's output becomes useless if the scenario fails proper scaling. Part of the conclusions, and lessons learned section of this thesis, describes in more detail the trials and errors associated with scaling. In addition, Appendix A provides the screen shots of the spreadsheet modeling referenced throughout this chapter. Spreadsheet modeling assisted in the entire scaling and model development of this scenario. CAPT Mike Babilot, United States Marine Corps, developed a *baseline spreadsheet*, which the author incorporated within this work.<sup>49</sup> A modified and upgraded version of the *baseline spreadsheet* fits this scenario, and may assist in a wider array of future scenario applications. The intent of Appendix A is two fold. First, it provides the reader with the input values assigned to each modeling entity within MANA, such that the reader can replicate the scenario by inputting each value into a MANA version 3.0.39, or newer,

---

<sup>49</sup> Naval Postgraduate School Thesis, Comparison of a Distributed Operations Force to a Traditional Force in Urban Combat, Michael Babilot, September 2005.

simulation model. Second, it provides a graphical representation of the modeling methodology.

As humans, we typically express distances in feet, miles, kilometers; time in seconds, minutes, hours; and velocities in feet per second, miles per hour, or kilometers per hour. In essence, we think of a distance and time. MANA provides distance and time in grids (or pixels) and time steps. The user defines the resolution settings for each MANA scenario as any rectangle between the values of 1 square and 1000 square grid matrix. As such, the user also defines the relationship of MANA grids to real world distances. One pixel may represent any metric of length. Possible examples include a centimeter, foot, kilometer, or even 5 miles. The model is a stochastic simulation, allowing the user to define each time step as a second, minute, hour, 5 hours or any other time metric.

Three parameters molded together, properly scale any simulation scenario. The first labels the model terrain distance. The second represents the total time the scenario runs with respect to real world time. The third defines the velocity at which agents travel along the terrain. This scenario encompasses a 500 by 500 square grid resolution representing a 2.6 by 2.6 kilometer terrain piece upon the Earth's surface (Figure 5).

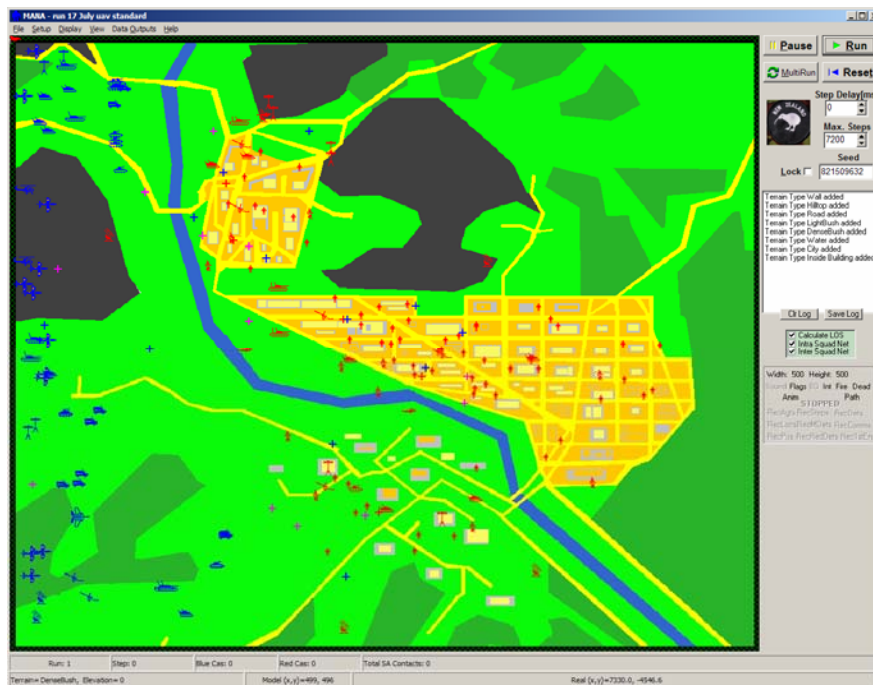

Figure 5. NEA 50.2 MANA Screenshot  
32

The full scenario lasts for 7200 time steps, which represents the critical 2-hours of real time to secure the urban objective. Thus, each time step corresponds to one second. Calculations stemming from these two parameters yield the correct MANA speed in which each agent travels. Immediately one might ask why the maximum resolution of 1000 square grids does not scale the scenario. The answer lies in the velocity at which each agent travels.

The model itself limits agent's velocities. Optimally, an agent should travel with a velocity not exceeding one grid per each time step. Here, a value  $x$ , represents the agent's velocity, such that in one time step, the agent advances to the next grid with a probability of  $x$  over 100. Therefore, the ratio 0/100 describes a stationary agent while 100/100 describes an agent's ability to advance one grid with 100% probability per time step. As such, 200/100 described the agent's ability to advance two grids with a probability of one. Ultimately, agents appear to move at different velocities.

MANA limits the ratio to not exceed greater than 1000/100. As the numerator grows past 100, certain side effects occur. The MANA User Guide describes these side effects in greater detail. However, one side effect increases the possibility of two agents passing right by each other without detection of the other agent. This side effect actually represents possible real world occurrences, and the author accepts it within the scenario. Combining the equations shown in Table 3 balances the distance, duration, and velocity—yielding a 500 square grid resolution.

Given the battle lasts for 2 hours, and the terrain encompasses 2.6 square kilometers, experimentation with associated values for *time step*, *second*, and *grid*, led to a feasible scaling for this specific scenario. Notice an increase of time steps per second provides unrealistic characteristics allowing each agent to have multiple capabilities per second. In real life, a second reflects a short amount of time, limiting a soldier's cognitive and reaction process. Inverting the relationship with an increase of seconds per each time step, or setting the resolution above 500 grids, dramatically amplifies the converted MANA movement ratios towards 1000/100, and increases more side effects. The feasible scaled values assume a compromise between extremes. Notice each air movement speed may result with a failed probability to detect other agents within

proximity. However, this possible failure indicatively represents air assets flying rapidly at high altitudes.

$$\frac{2.6 \text{ KM}}{500 \text{ grid}} \bullet \frac{1000 \text{ meters}}{1 \text{ KM}} = 5.2 \frac{\text{meters}}{\text{grid}}$$

$$2 \text{ hours} \bullet \frac{60 \text{ min}}{1 \text{ hour}} \bullet \frac{60 \text{ sec}}{1 \text{ min}} \bullet \frac{1 \text{ timestep}}{1 \text{ sec}} = 7200 \text{ timesteps}$$

General speed conversions of tactical speeds modeled in this scenario							conversion	rounded mana input / 100
Ground	Dismounts	1.6 km * 1 hour * 1 min * 1 sec * 500 grids =	0.09 grids * 100 =	8.547008547	9			
		1 hours 60 min 60 sec 1 steps 2.6 km 1 step						
Ground	Ground Vehicles	16 km * 1 hour * 1 min * 1 sec * 500 grids =	0.85 grids * 100 =	85.47008547	85			
		1 hours 60 min 60 sec 1 steps 2.6 km 1 step						
Air	UAV CL I	60 km * 1 hour * 1 min * 1 sec * 500 grids =	3.21 grids * 100 =	320.5128205	321			
		1 hours 60 min 60 sec 1 steps 2.6 km 1 step						
	UAV CL II and Helo	80 km * 1 hour * 1 min * 1 sec * 500 grids =	4.27 grids * 100 =	427.3504274	427			
		1 hours 60 min 60 sec 1 steps 2.6 km 1 step						
	UAV CL III	140 km * 1 hour * 1 min * 1 sec * 500 grids =	7.48 grids * 100 =	747.8632479	748			
		1 hours 60 min 60 sec 1 steps 2.6 km 1 step						
CAS	300 km * 1 hour * 1 min * 1 sec * 500 grids =	16 grids * 100 =	1602.564103	1000				
	1 hours 60 min 60 sec 1 steps 2.6 km 1 step							

Table 3. Scaling Equations

Table 4 edits the terrain properties, represented by colors, within the model. The user defines each color with the Red-Green-Blue (RGB) schematic found in most paintbrush applications. The user assigns a name to each color. Each color represents an associated going, cover, and concealment value. Going and movement speed are synonymous. Cover provides protection from bullets, and concealment shields them from other's visibility. The color affects each agent's movement speed, as well as their cover and concealment from others, for each time step while traveling within that terrain color. For this scenario, each value estimates percentages of speed, cover, and concealment when traveling through similar terrain and vegetation features as experienced by the author. For example, the color defining a Wall prevents an agent from going through it, while providing 100% cover and concealment. In contrast, the color defining a Road permits an agent to travel an average rate of 90% of its maximum speed, and provides zero cover and concealment.

	Going	Cover	Conceal	Red	Green	Blue
BilliardTable	1.00	0.00	0.00	0	0	0
Wall	0.00	1.00	1.00	192	192	192
Hilltop	0.90	0.00	0.00	64	64	64
Road	0.90	0.00	0.00	255	255	0
LightBush	0.60	0.10	0.30	10	250	10
DenseBush	0.20	0.30	0.90	40	180	40
Water	0.10	0.00	0.00	51	102	204
City	0.50	0.60	0.60	255	200	0
Inside Building	0.90	0.90	0.90	250	250	100

Table 4. Edit Terrain Properties

Refer to Appendix A, section “Configure Battlefield Settings” to view the remaining input values associated with the “Configure Battlefield Settings” portion of the Model. Each spreadsheet screenshot correlates to an associated series of main menu tabs located within the GUI of the MANA application. All appendices include the necessary values needed for entry to build this scenario.

## **2. Model Unit Summary**

Chapter II outlined both the Blue and Red players modeled in this scenario. This section discusses in detail how to model each player in MANA. Appendix A, section “Model Unit Summary,” is a tabular format of multiple inputs from the *General*, *Ranges*, and *Weapons* GUI tabs within the MANA application. Though other sections in Appendix A describe these three tabs in detail, fundamental rules and assumptions established to build this scenario lay within this specific section. Following in each paragraph is a description for each table column. Refer to the actual table in “Model Unit Summary,” for each associated value.

### ***a. Players***

Unit Type / Squad: Each group of real world players has an assigned squad value within the model. Squads fall into two categories, Red or Blue, followed by the traditional name for that specific player. There are 33 squads built in this scenario. Squads one through 11 are Red Force units and squads 12 through 33 are Blue Force units.

Start # - End #: Each squad has a number for record keeping. Most squads have identical start and end numbers. However, each of the four maneuver teams, A, B, C, and D, has identical UAV squads assets. As such, the scenario has four squads for each of the Class I and Class II UAVs, resulting in different start and end numbers.

# Type Squads: Following from the preceding bullet, this column identifies the number of squads built in the scenario to represent the real world player. Thirty-three squads represent the real world players.

# Agents: Within each squad, there may be multiple agents. Each icon on the battlefield map defines a separate agent.



Moving Parts: Moving Parts is the total number of agents per each type of squad. It is the product of the # Type Squads and # agents. The running tally of the number of moving parts within the scenario facilitated aggregation in order to minimize the run time of the scenario.

Squad Class: Each squad has an assigned class value. Red Force squad class values range from one to three, and Blue Force squad class values range from 100 to 210. Class values limit the types of munitions fired from enemy classes. Squad Class tightly weaves with Squad Threat Level, as well as each Target Classification value. The Squad Class restricts, for example, a Blue Infantrymen firing a M16 rifle at a Red T72 tank, but authorizes a NLOS cannon system to fire its primary weapon at the same Red T72 tank.

Squad Threat Level: In addition to the Squad Class, a Squad Threat Level also designates each squad. The threat level simulates the Maneuver Commander's Guidance and limits the number of munitions fired from a particular squad. For example, the Blue NLOS Cannon Platoon has authorization to shoot at a Red AK-M Infantrymen, but it would be an expensive choice of munitions to fire at a single target. However, threat levels of multiple agents are added together to create a cumulative group threat level within a specified radius. Now, if an abundant number of infantrymen are located within a specified blast radius, then they form a group. Thus, the cannon system will fire the same projectile at this group target.

***b. Weapons***

Weapons: A general assumption is that all squads have, at most, two weapon systems. This includes the primary weapon classifying a specific platform, and an alternate weapon also found on that platform. In addition, each different kinetic energy (LOS) weapon fires only one type of bullet. However, two different target effects simulate the use of each area fire (NLOS or BLOS) weapon system. As such, a third weapon added to all squads armed with NLOS or BLOS weapons works around the model's limitations. Weapon 3 simulates different effects the same projectile fired from Weapon 1 has against hardened targets. Weapon 1 simulates projectile effects against soft targets, where as Weapon 3 simulates projectile effects against hard targets. A later section covers specific weapon modeling characteristics within the scenario.

Priority Target Class vs. Non Target Class: Classifies the use of weapons fired at only specific enemy targets, and in an order of priority.

Min and Max Threat Levels: Offers a specified threat level window that particular weapon systems are able to fire at enemy targets. This coincides with the example detailed in Squad Threat Level regarding firing upon a group target in lieu of a single target.

**c. Aggregation**

There exist three columns for aggregation. Two of these columns primarily provide bookkeeping to count the number of squads and agents per side, and to limit the number of icons present on the map. However, the aggregation value of “1 icon to X number of real world objects” also doubles as the number of hits required to kill a specific agent within each squad. This simulated ‘one hit one kill’ for all agents within the simulation.

**3. Movement Rates**

As pointed out earlier, scaling the scenario is a critical part in modeling. Table 5 displays initial movement rates. Due to limitations with the model, or assumptions made, changes occurred to each platform’s basic movement rates noted in Table 5. These changes reflect different speeds the agent travels at in different state conditions.

<b>Ground</b>	Dismounts	1.6 km
		1 hour
	Ground Vehicles	16 km
		1 hour
<b>Air</b>	UAV CL I	60 km
		1 hour
	UAV CL II and Helo	80 km
		1 hour
	UAV CL III	140 km
		1 hour
	CAS	300 km
		1 hour

Table 5. Real World Basic Movement Rates<sup>50 51</sup>

<sup>50</sup> US Army Material Systems Analysis Activity (US AMSAA), FCS UA Design Concept Baseline Description (UA-001-01-050124), 3 March 2005.

<sup>51</sup> “Unopposed Movement Rates” in FM 90-31, Chapter 4, Table IV-5.

Table 5 splits the movement rates into two basic categories: Ground, and Air. There are four different subcategories, or values, identifying the air category. Assumptions include that the different atmospheric conditions are negligible on the air movement speeds. As such, the UAV and Helo converted movement values remain the same for the remainder of this scenario. Notice in Table 3, the converted CAS movement value exceeds the MANA limit, 1000. Instead of using the maximum value of 1000 to represent CAS movement, its speed is set to zero. The CAS icon is set to the side of the battlefield. The placement assumes the CAS is flying too fast, and at too great of an altitude, to be effected by the enemy surface-to-air missiles. The CAS has two state changes, active (Default) and passive (Taken Shot (Pri) ). In the Default state, the CAS fires upon acquired targets. Upon firing its weapon, it enters a passive or Taken Shot (Pri) state for 60 time-steps, simulating a racetrack flight route returning it to the same launch position for future targets.

There are two different subcategories for each ground asset: Dismounted and Ground Vehicle. Each category has different movement values depending on the squad state. Table 6, from Appendix A, section “Movement Rates,” identifies the final possible converted movement rates for each state change within each subcategory of ground assets.

Ground Vehicle Different State Value Settings	% of Adjusted Movement Speed		MANA Input Speed
<b>Default movement Rate</b>	100%	1.20	<b>120</b>
<b>Reach Waypoint</b>	10%	0.12	<b>12</b>
<b>Taken Shot (for primary or secondary)</b>	0%	-	<b>0</b>
<i>(judgement call based on platforms)</i>	50%	0.60	<b>60</b>
<i>ability to fire at 0, 50%, 60% or full speed)</i>	60%	0.72	<b>72</b>
	100%	1.20	<b>120</b>
<b>Shot At</b>	150%	1.80	<b>180</b>
<b>Run Start (if applied)</b>	0%	-	<b>0</b>
<b>Reach Final Waypoint</b>	1%	0.01	<b>1</b>

Dismounted Different State Value Settings	% of Adjusted Movement Speed		MANA Input Speed
<b>Default movement Rate Red</b>	100%	0.09	<b>9</b>
<b>Default movement Rate Blue</b>	0%	-	<b>0</b>
<b>Reach Final Waypoint</b>	100%	0.09	<b>9</b>
<b>Taken Shot Red</b>	60%	0.05	<b>5</b>
<b>Taken Shot Blue</b>	0%	-	<b>0</b>
<b>Refuled by Anyone</b>	100%	0.09	<b>9</b>

Table 6. MANA Movement Speeds

Table 6 shows the final model values inputted in MANA after manipulating the base movement rates in the movement calculator spreadsheet. The movement calculator spreadsheet annotated in Appendix A begins with each of the researched basic movement speeds of 1.6 kmph and 16 kmph for both dismounted and ground vehicles respectively. Research showed a difference in tactical speeds in a restricted area verses a platform's maximum speed, and the author wanted to incorporate both into this scenario.

There exist two ideas behind incorporation the movement calculator. The first idea defines a platform's tactical speed as 100% of its movement speed, while defining its maximum speed as 550% of its tactical speed. The maximum speed of all the FCS ground vehicles is roughly 90 kmph, thus 550% of 15 kmph equals 88 kmph.<sup>52</sup> For

<sup>52</sup> US Army Material Systems Analysis Activity (US AMSAA), FCS UA Design Concept Baseline Description (UA-001-01-050124), 3 March 2005.

simplicity, Red Force ground vehicles have the same movement abilities. Also for simplicity, assume that a dismounted soldier sprints at about 9 kmph when in a combat uniform, which is roughly 550% of its tactical speed ( $1.6 \text{ kmph} * 5.5 = 8.8 \text{ kmph}$ ). There are times when a platform, or a soldier, travel at speeds in between the tactical and maximum speeds. In the scenario, 200% and 400% rates of the tactical speed represent these in between speeds.

Secondly, each platform moves at different speeds depending on its combat load. Based on prior experience of personal timed road marches while carrying combat equipment, four adjustment factors affect each of the base movement rates. The factor values affecting ground vehicles is 1 if unencumbered, 0.95 for a light combat load, 0.85 for a full combat load, and 0.75 for a heavy combat load. These values represent both the strain on an engine as well as a slower safety speed when carrying increased cargo. The factor values affecting dismounted troops are 1 if unencumbered, 0.7 for a light combat load, 0.5 for a full combat load, and 0.2 for a heavy load. These values represent a soldier's physical inability to travel at the same speed when carrying increased loads.

Babilot designed this movement calculator<sup>53</sup> for use within various applications. For this scenario, assume that the soldier in the urban terrain would spend most of his time walking or jogging while carrying a light to full combat load; and a ground vehicle will spend most of its time traveling at either its tactical speed or twice that speed, while again carrying a light to full combat load. Since some of the FCS ground vehicles are robotic in nature, a combat load refers to its fuel, add on armor, and ballistics. In each category, an average of each of these four values determines the adjusted speed. Lastly, in order to simulate the agent's reaction in different states, multiply the adjusted speed by a certain percentage annotated in the second column of Table 6, resulting in the final input values annotated in the last column of Table 6.

#### **4. Personalities**

The premise of ABS is the agent's ability to act or react due to its goals and situational awareness. MANA permits each of the agents within a squad to have one of three categories of situational awareness: Agent Situational Awareness (SA), Squad SA,

---

<sup>53</sup> Babilot.

and Inorganic SA. These categories are important to note here, because they help formulate modeling different sensor, detection, communication, and weapon capabilities.

Agent SA—Response of an agent to information that it receives only from its current local surrounding that is defined by its Sensor and Detection Ranges found within its own SA map.

Squad SA—Response of an agent to information on other agents' (only within the squad) local surroundings defined by their Sensor and Detection Ranges found within their SA map.

Inorganic SA—Response of agent to information on other agents' (only within the squad) inorganic SA map. Entities are places on the inorganic SA map via communication properties among each squad.<sup>54</sup>

Appendix A, section “Personalities and Ranges,” shows each weighted value entered into MANA for each state a squad enters. This includes the associated values needed for entry within each Agent SA, Squad SA, and Inorganic SA field. Left to the reader is to familiarize himself with the MANA handbook to understand each weighted value. Operational experience, coupled with designer’s intentions for each platform, dictate the value setting chosen for each squad’s personality traits. Setting these personality values last makes the agents move with closer resemblance to how they would in real life. The author claims that these settings are best applied after mathematically determining the other parameter settings for each squad’s sensor, detection, communication, and weapon capabilities. An increased value of a squad’s desire to go towards the next waypoint simulates the squad’s tactical decision to maintain a designated march route, where as an increased value of the squad’s desire to go towards the enemy simulates the squad’s tactical decision to aggress the enemy. Opposite values have the reverse effect upon each agent. The “Personalities and Ranges” section summarizes into one large chart much of the inputted values discussed in the following paragraphs.

---

<sup>54</sup> Galligan, p.28.

## 5. Sense and Detect

This section describes the methodology used to model each squad's sensor capabilities. Appendix A, section "Sense and Detect," portrays the numeric approach used to set values within MANA. There are two categories: UAV Sensors, and Ground and other Air (Non UAV) Sensors. For clarity purposes of the technique used, the discussion of the latter precludes the former.

### *a. Ground and other Air (Non UAV) Sensors*

An assumption made, is that all platform sensor range capabilities fall into one of six categories: Short, Short-Medium, Medium, Medium-Long, Long, and Extra Long; which corresponds to 150 meters or less, 200 meters or less, 250 meters or less, 350 meters or less, 500 meters or less, and 1300 meters or less. MANA's runtime increases dramatically depending on increased agent's sensor ranges coupled with the total number of agents in a scenario. Since this scenario has 280 total agents within the squads, there existed a need to reduce the sensor ranges. As such, we assume a scaled down distance of real world sensor ranges to minimize runtime. This scaled down distance simulates possible degraded sensor capabilities within an urban terrain. Based on the scenario and terrain, this had little, if any, influence on the results.

A matrix consisting of rows depicting each squad, and columns depicting each type of sensor is part of Appendix A, section "Sense and Detect, Ground and other Air (non UAV) Platforms." There are 18 columns in this matrix. The first three columns represent whether a squad has short, medium, or long-range antenna capabilities. Columns four through 18 characterize each of the possible sensor capabilities outlined in the FCS UA Design Concept Baseline Description.<sup>55</sup> The value 1 in each row/column intersection indicates that the squad modeled has that type of sensor capability. Using the formula in Figure 6, a weighted adjusted value between 1 and 3.6, numerically describes each squad's sensor capability.

---

<sup>55</sup> US Army Material Systems Analysis Activity (US AMSAA), FCS UA Design Concept Baseline Description (UA-001-01-050124), 3 March 2005.

$$1 \bullet (short) + 2 \bullet (medium) + 3 \bullet (long) + \frac{\sum \text{Sensor Types}}{15} = \text{Adjusted Average Value}$$

Figure 6. Adjusted Average Sensor Value

The following example explains the formula in figure 6: The MCS has two of the 15 possible sensor types listed in the FCS UA Design Concept Baseline. In addition, the overall sensor range capability of the MCS has a *medium* range associated to it.<sup>56</sup> Each of the values *short*, *medium*, and *long* is binary and has the assigned value of “1” only if it describes that platform's capability. Therefore, MCS’s Adjusted Average (sensor) Value is characterized by the following values: (*short*) = 0, (*medium*) = 1, (*long*) = 0, and the sum of the Sensor Types equal to 2. Substituting these values into Figure 6, the MCS Adjusted Average Value = 2.13.

Each weighted Adjusted Average Value falls within one of the six sensor range categories (Numerical Value) shown in Table 7. Using these categories, each squad corresponds to a predetermined table value found in Appendix A, section “Sense and Detect, Ground and other Air (non UAV) Platforms.” These predetermined table values convert real world metrics to MANA units and depict the squad’s modeled distance and probability of detection at each distance.

Range	Numerical Value
Short	= 1
Medium	= 2
Long	= 3
Short-Medium	1 < x < 2
Medium-Long	2 < x < 3
Extra Long	> 3

Table 7. Numerical Sensor Value

<sup>56</sup> US Army Material Systems Analysis Activity (US AMSAA), FCS UA Design Concept Baseline Description (UA-001-01-050124), 3 March 2005.



Each table's distance is monotonically increasing, while the probability of detection is monotonically decreasing. This represents most ground and traditional air assets with simplistic sensors: However, this is not generally true for UAV sensor ranges.

***b. UAV Sensors***

Generally for UAV sensors that were modeled in this research, the UAV sensors' probability of detection increases at greater ranges, up to a certain distance. Then the probability decreases. Notice in Appendix A, section "Sense and Detect," each UAV's adjusted average value depicted in the chart with 18 columns, is greater than the value of three. Hence, the algorithm annotated in Figure 6 could not be used alone to depict the increased UAV sensor ranges.

Due to a UAVs complex set of sensor capabilities, each class of UAVs fly at a specific height while pointing their sensors at an optimal angle towards the ground. Aviators call this angle, the field of view<sup>57</sup>. A 90-degree field of view, pointing straight at the ground, as well as a 0-degree field of view, pointing straight at the horizon, provides minimal footprints on the ground causing limited detection abilities. Instead, an optimal angle obtained optimizes the sensor footprint on the ground. The footprint is the piece of the earth that the UAV sensor performs a sweep width. Different UAVs have different sensor footprint capabilities.

MANA limits each squad with only one sensor and detection range. However, each class of FCS UAVs has multiple sensors, as noted in Table 8, generated from the FCS Design Concept Baseline.<sup>58</sup> Refer to Table 9 for definitions of each sensor type with respect to UAVs only. Again, the procedure alone outlined in *paragraph a* above, is insufficient for modeling UAVs. Added to the procedure is a need to create three additional subclasses within the category, *Extra Long*, which specify the greater sensor capabilities of the platoon, company, and battalion level UAVs. All UAV classes yielded an adjusted average numerical value greater than three, and require a modeling

---

<sup>57</sup> Department of the Navy, Office of the Chief of Naval Operations, Integration of Unmanned Vehicles into Maritime Missions, TM 3-22-5-SW, chap. 2, p. 4.

<sup>58</sup> US Army Material Systems Analysis Activity (US AMSAA), FCS UA Design Concept Baseline Description (UA-001-01-050124), 3 March 2005.

table, which monotonically increases in both range and probability of detection, similar to the graph in Figure 7.

	AITR	EO	IR	TD	CM	RADAR Warning	Plum Dect	Standoff Chem De	SIGNINT	Combat ID
UAV CL I		x	x	x						
UAV CL II		x	x	x						
UAV CL III	x	x	x		x	x	x	x	x	x

Table 8. FCS UAV Sensor Type

AITR	Aided Target Recognition: Aided target recognition of targets in FLIR image; provides high-resolution FLIR target "chips" for ID by operator.
EO	Electro-Optic. Support RST operations in open, rolling, complex and urban terrains. Support situational awareness and provide the operator/COP actionable and accurate targeting information.
IR	Thermal Imager. Support RST operations in open, rolling, complex and urban terrains. Support situational awareness and provide the operator/COP actionable and accurate targeting information.
TD	Temperature Detection: Aided target recognition of targets in FLIR image; provides high-resolution FLIR target "chips" for ID by operator.
CM	Sub-Sea sensor capabilities
RADAR Warning	Detect and locate RADAR guided missile threats; acquire and provide warning on threats engaging UAV
Plume Detector	Detects and locates threat IR based sensors or IR based weapon systems that have acquired, targeted and/or engaged the UAV
Standoff Chemical Detector	Description not provided
SIGNINT	Signals Intelligence. Provide relevant "deep look" SIGNINT emitter mapping to detect, locate, and classify RF emitters
Combat ID	Multiple-Sensor design for Multiple Platforms

Table 9. FCS UAV Sensor Type Definitions <sup>59</sup>

<sup>59</sup> US Army Material Systems Analysis Activity (US AMSAA), FCS UA Design Concept Baseline Description (UA-001-01-050124), 3 March 2005.

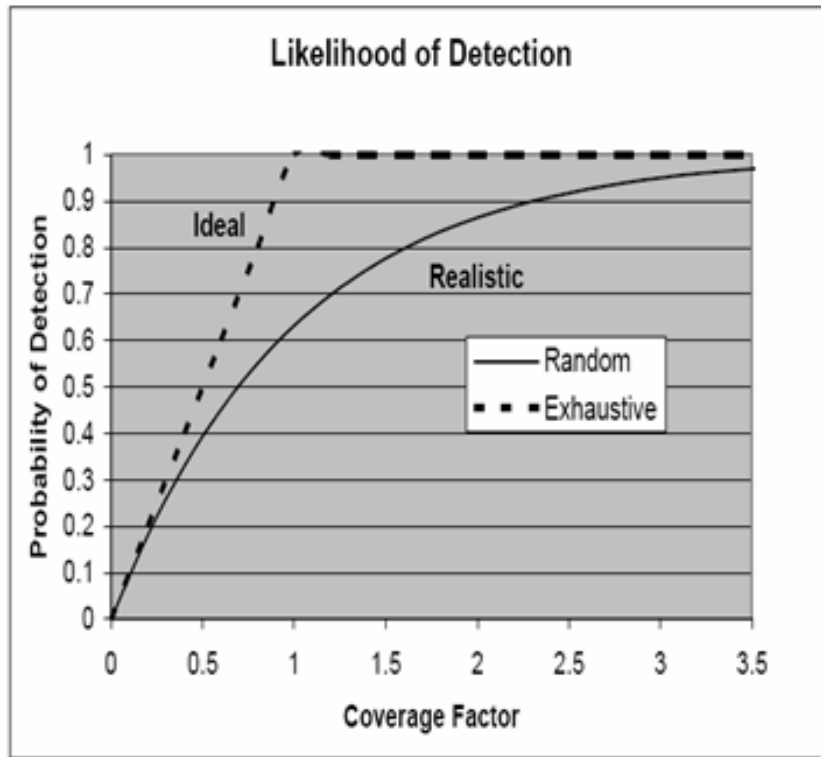

Figure 7. UAV Sensor Probability of Detection Graph<sup>60</sup>

The coverage factor is an adjusted weighted value comprised of four factors: UAV speed, sensor sweep width (footprint), time on station (TOS), and size of area patrolled. The coverage factor is directly proportional to its speed, sweep width, and TOS, while inversely proportional to the size of the patrolled area.<sup>61</sup> The base scenario assumes maintaining the speed, TOS, and size of patrolled area constant for each modeled UAV, leaving only the sweep width affecting the probability of detection. Therefore, each modeled UAV's probability of detection is solely dependent upon the length of the sweep width (measured in meters on the ground), or in MANA terms, the sensor range in grids. Hence, the idea behind modeling each of the UAV sensor capabilities is to replicate the curve in Figure 7 for each class of UAVs flying at a specified height, with an optimal field of view, yielding the greatest sweep width (footprint) on the ground. The graphs in Figure 8 each depict this intent while assuming the following characteristics for each UAV modeled.

<sup>60</sup> Department of the Navy, chap. 2, p. 4.

<sup>61</sup> Department of the Navy, chap. 2, p. 2.

CL I UAV has a 350 ft footprint, which converts to 21 MANA grids. To obtain this size footprint in real life, the UAV must fly at 500 ft while using a 30-degree field of view.<sup>62</sup>

CL II UAV has a 650 ft footprint (38 MANA grids). To obtain this, the UAV must fly at 1000 ft while using a 30-degree field of view.<sup>63</sup>

CL III UAV has a 2500 ft footprint (147 MANA grids). To obtain this, the UAV must fly at 2500 ft while using a 45-degree field of view.<sup>64</sup> This is actually 500 ft higher than the recommended window of 1000 – 2000 ft for the FCS CL III UAV<sup>65 66</sup>; however, the only value of concern needed for input into MANA is the width of the footprint (sensor range).

MANA's battlefield is only two-dimensional, and in the model, the UAVs are actually flying at the ground level. In order to simulate the UAV, and all other air assets flying in this scenario, the scenario has the "Terrain Affects Going" turned off for all airborne squads. This eliminates the modeled terrain from affecting the speed of the squads as noted in the *Terrain and Battlefield* section of this chapter, making the flying height of each air platform negligible. Refer to Appendix A, section "Sense and Detect," for the spreadsheet model behind each graph in Figure 8.<sup>67</sup>

---

<sup>62</sup> Department of the Navy, chap. 3, p. 12.

<sup>63</sup> Department of the Navy, chap. 3, p. 12.

<sup>64</sup> Department of the Navy, chap. 3, p. 12.

<sup>65</sup> US Army Material Systems Analysis Activity (US AMSAA), FCS UA Design Concept Baseline Description (UA-001-01-050124), 3 March 2005.

<sup>66</sup> Presentation to the CSA on the FCS *Brigade Combat Team Operational & Organizational Plan*, by US Army Futures Center, TRADOC, 7 October 2005.

<sup>67</sup> The methodology used to model each squad's sensor capabilities is adopted by combining lecturer material from OA3602 Search Theory and Detection, Naval Postgraduate School and the references noted in footnotes 57, 58, and 66.

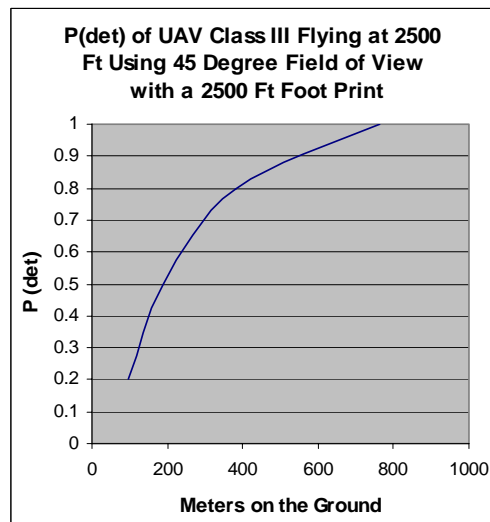
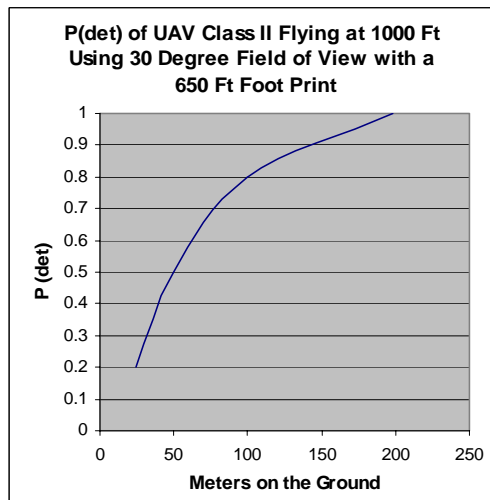
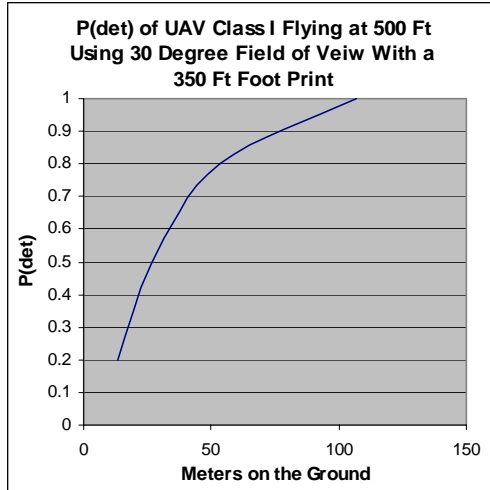

Figure 8. Modeled UAV Sensor Probability of Detection Graphs

#### 4. Communication Characteristics

This scenario assumes that each squad uses one of eight communications devices annotated in Table 10.

Device	Type	Notes
Cellphone or equivalent	VHF	Limited Reliability
Basic Radio or equivalent	UHF	LOS
Personal Role Radio (PRR) or equivalent	UHF	Intra-Team Communications
PRC 148 or equivalent	VHF/UHF	Platoon – Squad – Team C2 - CAS Control
JTRS Cluster(8 channel) or equivalent	Digital	Future Internet Networked Protocol System (Joint Tactical Radio System)
JTRS Cluster(4 channel) or equivalent	Digital	Future Internet Networked Protocol System (Joint Tactical Radio System)
JTRS Cluster 5 SFF-D-E-G or equivalent	Digital	Future Internet Networked Protocol System (Joint Tactical Radio System)
PRC 117 or equivalent	VHF / UHF / Satellite Communications	Squad – Plat – HHQ CAS/Fires Control (OTH - Digital)

Table 10. Modeled Communication Types

Appendix A, section “Communication Characteristics” explains in detail each communication device assigned to each squad. Each device modeled encompasses specific parameters outlined in Appendix A. Each relates to its signal transmission range; outgoing message capacity; outgoing message buffer size; latency of message to reach receiving squad; reliability of device to send a transmission; if sent, the message accuracy in which it is received, maximum length of time a message sent remains in queue; level of confidence the receiver has in the message; and deliverability conformation.

## 6. Weapon Characteristics

The scenario assumes there is a maximum of only two weapon systems per squad, falling into two categories, Kinetic or Area Fire. Kinetic (LOS) weapons are those similar to a rifle or a traditional tank, where as Area Fire (BLOS or NLOS) weapons are those similar to an indirect artillery system. Table 11 from Appendix A, section “Weapon Characteristics” provides detailed information of each weapon built in this scenario including the weapon name, minimum effective range, maximum effective range, maximum weapon range, blast shot radius, maximum number of targets each weapon can engage in one minute, and the weapon’s basic load of carried rounds. Each value converts into values entered into MANA.

Platform	Weapon	Min Effective Range (m)	Max Effective Range (m)	Max weapon Range	Shot Radius (m)	Max Targets/ min	Carried Rounds	{High Rate of Fire / min}
Blue NLOS Mortor Sec	120 mm BLOS guided munition	500	12000	15000	60	2	62	24
	xm307 25mm	1	450	2000	1	10	300	250
Blue NLOS Cannon Plt	155 mm std	500	30000	30000	50	4	24	10
	155 mm guided (heavy targets only)	500	30000	30000	50	4	24	10
Blue NLOS LS Plt	payload assit mod (PAM)	500	40000	40000	50	1	15	1
Blue ICV Platoon	MK44 30 mm	1	2000	6000	1	10	320	400
	M240B 7.62mm	1	1800	3725	1	10	1200	200
Blue MCS Platoon	Guided xm36 120mm	40	2000	4000	15	4	27	4
	xm307 25mm	1	450	2000	1	10	300	250
Blue ARV-A	MK44 30 mm	1	2000	6000	1	10	320	400
	M240B 7.62mm	1	1800	3725	1	10	1200	200
Blue ARV-A(L)	xm307 25 mm	1	450	2000	1	10	300	250
	Javelin Anti Tank Missile	75	2000	2000	5	2	2	2
Blue ARV-RSTA	xm307 25 mm	1	450	2000	1	10	300	250
Blue UAV CL 3	Guided Hellfire	500	7000	8000	30	16	4	16
	APKWS	500	6000	6500	10	4	6	4
Blue R&SV	xm307 25 mm	1	450	2000	1	10	300	250
Blue Infantryman	m16	1	550	3600	1	10	1260	16
Blue MachineGunner M2	m240B 7.62mm	1	1800	3725	1	10	1200	200
Blue CAS	m230 / 30 mm	1	1830	6000	1	10	1200	625
	Guided LOCAAS	100	100000	100000	50	1	16	1
Blue Apache	m230 / 30 mm	1	1830	6000	1	10	1200	625
	Guided Hellfire	500	7000	8000	30	16	16	16
Red BMP-3	2A-42 /30 mm	1	4000	unk	5	4	500	15
	Guided 2A-70M100mm tube firing AT12 guided stabber	100	5500	unk	15	4	50	3
Red 82 Mortors	82 mm Mortar	1000	4000	4000	15	4	65	10
	ak m/47 rifle	1	300	1000	1	10	240	600
Red SA-16 Infantryman	Guided SA-16 Surface to Air Missile	500	3500	5000	5	2	2	2
Red RPG-7	anti tank grenade launcher	50	500	920	5	6	6	6
Red AT-7	anti tank missile	40	500	1000	5	2	2	2
Red Scout	ak m/47 rifle	1	300	1000	1	10	240	600
Red RPK-74	rpk 74 light machine gun	1	450	2500	1	10	1000	150
Red AK-M Infantryman	ak m / 47 rifle	1	300	1000	1	10	240	600
Red SVD	SVD 7.62 sniper	1	1300	3800	1	1	10	30
Red APC	2A-42 /30 mm	1	300	2500	1	10	240	100
	rpk 74 light machine gun	1	450	2500	1	10	1000	150
Red T72	2A-46 /125mm	50	2120	10000	15	4	60	8
	rpk 74 light machine gun	1	450	2500	1	10	1000	150

Table 11. Weapon Characteristics

Depending on whether the weapon is kinetically or aurally modeled depends directly on limitations within the model, and hence calls for separate spreadsheet modeling techniques. Refer to Appendix A to identify the modeling technique applied for each weapon.

**a. Kinetic Weapon Modeling**

Each kinetic weapon assigned the probabilities of 1.0, 0.5, and 0, to the minimum effective range, maximum effective range, and maximum weapon range, respectively. The maximum effective range is the “the distance from a weapon system at which a 50 percent probability of target hit is expected.”<sup>68</sup> From this definition, the scenario assumes the other two hit probabilities, facilitating the graphing function that yields the probability of hit dependent upon each weapon system’s range to target. Rather than formulating a piecewise linear regression connecting each of the weapon’s three data points, a more exhaustive graphical smoothing spline maps the probability of hit for each meter, starting at 0 meters, and increases to each maximum weapon range. A smoothing spline is an excellent way to get an idea of the shape of the expected value of the distribution of  $y$  across  $x$ . A spline may vary in smoothness (or flexibility) according to a user-defined lambda, a tuning parameter within the spline formula.<sup>69</sup> For consistence, the scenario assumes a very stiff lambda equal to 1,000,000 for each kinetic weapon modeled. Three data points per weapon system entered into a spline formula provided by *JMP IN* software resulted in a smooth distribution of hit probability across meters.

Since the distribution is a smooth approximation that best fits the three initial data points, some fitted values annotated in Appendix A, section “Raw Spline Data,” exceed the numerical probability limits of 1.0 and 0. Importing each string of values into Excel and using a series of “if, then statements,” any value outside the limit becomes 0 or 1.0. Nested inside are additional “if, then statements” ensuring that all approximated values adhere to the original weapon minimum and maximum limits. For example, the Guided Hellfire arms at the minimum effective range of 500 meters; it has a

<sup>68</sup> “Operational Terms and Graphics” in FM 101-5-1, chap. 1, p. m.

<sup>69</sup> *JMP Start Statistics, A Guide to Statistics and Data Analysis using JMP and JMP IN Software, Third Edition*, (SAS Institute Inc. 2005) p. 245.



maximum effective range of 7000 meters, and a maximum launch range of 8000 meters.<sup>70</sup> Refer to Appendix A, section “Raw Spline Data” to observe that the spline technique estimated values starting at zero and continued past 8000, whereas the “Spline Look-up Table” used the series of nested “if, then statement” to replicate minimum arming distances for modeling purposes within MANA. The following Excel coding script is an example of the cell codes within the “Spline Look-up Table.”

*=IF('Raw Spline Data'!\$A5<500,0,IF('Raw Spline Data'!\$A5>8000,0,IF('Raw Spline Data'!\$R5<0,0,IF('Raw Spline Data'!\$R5>=1,1,'Raw Spline Data'!\$R5))))*

Using the same lambda to estimate each weapon’s “best fit” did inflate each weapon’s maximum effective range. However, the scenario assumes this point mute since the inflation is identical for all kinetic weapon systems. An additional assumption regarding the LOS kinetic energy weapons is that they cannot travel through walls to engage targets. However, the Hellfire, APKWS, LOCAAS, SA-16 guided rockets, and the AT-12 stabber do not track traditional ballistic trajectories. Since the model limits ballistics to follow straight paths, the scenario does assume these munitions modeled as kinetic energy systems, to travel through walls to engage targets. This modeling assumption simulates their precision guidance characteristics.

***b. Area Fire Weapon Modeling***

The scenario models area fire weapons much simpler. Assumptions include that all area fire weapons can fire through walls to engage a target, simulating the “lobbing effect” of indirect fire. This assumption holds true for both traditional munitions, as well as precision guided munitions modeled. A third weapon system added to each squad simulates the difference in effects that the same projectile has against both soft and hard targets. As noted earlier, the third weapon system truly replicates the primary weapon system (Weapon 1) when fired against hardened targets.

---

<sup>70</sup> Global Security.org, *Hellfire, Getting the Most from a Lethal Weapon System*, referenced 7 October 2005 on the World Wide Web at <http://www.globalsecurity.org/military/library/news/1998/01/helfire.pdf>

The Carleton Function, Figure 9, where  $r$  is the blast radius and  $b$  is a coefficient identifying the lethality to the target, determines the probability of hit for each area fire weapon. For this model,  $p(\text{hit}) = p(\text{kill})$ .

$$p(\text{hit}) = e^{\left(-\frac{r^2}{2b^2}\right)}$$

Figure 9. Carleton Function<sup>71</sup>

The blast (shot) radius in Appendix A, section “Weapon Specifications,” is the maximum effective range for each projectile. The maximum blast radius has  $p(\text{kill}) = 0.5$  when applying an appropriate  $b$  coefficient for each light (soft) target noted in Table 12. The model assumes a direct hit with a  $p(\text{kill}) = 1$ , and that the same weapon system has half the effects on heavy (hardened) targets at the maximum blast radius. Selecting an appropriate  $b$  coefficient models these assumptions and provides various  $p(\text{hit})$  values for different targets located with the corresponding blast radii annotated in Table 12.

Platform	Target Type	$b$					
NLOS M			real world range	0	20	40	60
			MANA units	0	4	8	12
	light target	51	1	0.925988	0.735228	0.500553	
	heavy target	36	1	0.856997	0.539408	0.249352	
NLOS C/LS			real world range	0	16.66667	33.33333	50
			MANA units	0	3	6	10
	light target	43	1	0.927636	0.740476	0.508627	
	heavy target	30	1	0.856997	0.539408	0.249352	
guided xm36			real world range	0	5	10	15
			MANA units	0	1	2	3
	light target	13	1	0.928705	0.743893	0.513924	
	heavy target	9	1	0.856997	0.539408	0.249352	
guided 82mm			real world range	0	5	10	15
			MANA units	0	1	2	3
	light target	13	1	0.928705	0.743893	0.513924	
	heavy target	9	1	0.856997	0.539408	0.249352	

Table 12. Modeled P(Kill) for Area Fire Weapons using the Carleton Function

<sup>71</sup> Thomas Lucas, OA4655 Combat Modeling, Naval Postgraduate School, lecture presentation: Entity-level Attrition: Some Phit and Pkill Algorithms.

## **7. Armor and Concealment**

Weighted values of each system's platform capabilities models both the squad's armor and concealment MANA values. There existed a need to link FCS platform defensive capabilities together in order to model each squad's armor and concealment.

The Armor Thickness is a weighted average of possible capabilities classified within each category described by the FCS UA Design Concept Baseline:<sup>72</sup> Ballistic protection, active measures, passive measures, threat warning receivers, countermine abilities, and additional body armor. Refer to Appendix A, section "Armor and Concealment," to observe each of the possible capabilities within each category. Summing the capabilities of each platform and dividing by the total number of capabilities yields an average numerical value associated per squad. Seventy-five percent of each averaged numerical value is the final weighted value defined in MANA. The weighted value compliments the penetration value of each modeled weapon system. For example, the value 75 annotates the armor value for an MCS vehicle. As such, only weapons modeled with penetration values of 75, or greater, can kill the MCS. A close look at the scenario reviews that an AK-M rifle cannot kill the MCS, whereas the AT-Stabber can. The scenario assumes the Red Forces to have similar capabilities among similar platforms in order to obtain a robust scenario.

Caveats to the algorithm in place include the author's decision to model the NLOS Cannon and Launch systems, CAS, and Apache squads to all have an armor value of 100. A value of 100 makes each of these squads invincible to any other weapon system. This simulates the CAS and Apache's flying at altitudes greater than the SA-16 missile can engage. This also simulates the NLOS systems' positions at greater distances than actually portrayed on the scenario map. Model limitations dictate current positions of the NLOS systems.

The squad concealment rate represents the signature management capability of each platform. Each platform has a level 0, 1 or 2 signature management capability as

---

<sup>72</sup> US Army Material Systems Analysis Activity (US AMSAA), FCS UA Design Concept Baseline Description (UA-001-01-050124), 3 March 2005.

defined by the FCS UA Design Concept Baseline.<sup>73</sup> In addition, the author included a binary value, 0 or 1, to represent if there exists a human in the loop decision to position the platform, or squad, in a concealed manner, rather than exposed in the open. Multiplying 10 to the sum of each row in the *Concealment* table, Appendix A, section “Armor and Concealment,” yields the MANA input value for each squad.

Red Force squads assume similar capabilities to maintain a robust scenario. In addition, an **x** in the last row of the table identifies the author’s assumption to model the squad with a different concealment rate. This serves for two reasons. First, it speeds up computer run time by disabling enemy squad’s acquisition of air and NLOS assets on their SA map, since these squads are invincible. Second, it provides the sniper and UAVs greater concealment to represent real world occurrences.

#### **D. MODEL LIMITATIONS**

MANA version 3.0.39 presented several unique challenges to work around, or to simply accept as limitations. This research uncovered a “bug” which prompted an accelerated distribution of version 3.1.1 from New Zealand’s Defense Technology Agency. The “bug” allows the agent the ability to engage targets through walls with the use of their non-precision modeled kinetic energy weapons. This only occurred if the agent acquired a target thru their inorganic situational awareness map. However, even a direct hit, failed to kill the target. In essence, the “bug” lowered the agent’s ammunition count, without posing harm to the target. However, this reflects what may occur in real battles. A soldier may request a second soldier among their squad to provide suppressive fires towards a particular building. The purpose of these fires may be to cover the first soldier’s movement to better position him to engage a target. It is in this case that the target is not harmed by the suppressive fires provided by the second soldier.

Ironically, the scenario settings specific to this research caused the newer version of MANA to execute with a slower computer run time. As such, the author accepted this “bug,” and continued with version 3.0.39 declaring the “bug” as a simulation providing suppressive fires. Observing the simulation shows that suppressive fires do not harm

<sup>73</sup> US Army Material Systems Analysis Activity (US AMSAA), FCS UA Design Concept Baseline Description (UA-001-01-050124), 3 March 2005.

each target. However, each agent soon repositioned himself and the detection of the targets drifted from their inorganic situational awareness map to their personal agent situation awareness map. Once this occurred, the agent's weapons killed each target.

All modeled UAVs encompass a 360-degree sweep width around their platform even with the careful modeling considerations outlined earlier. This limitation in MANA gives the UAVs an increased ability to detect other agents, where as in real life, their sweep width only protrudes in one direction from the nose of the UAV. This limitation was mitigated by bounding the maximum sensor range for each UAV class where the  $p(\text{det})$  approached the value one, as annotated in the predetermined table values converting real world metrics to MANA units in Appendix A, section "Sense and Detect."

Modeling Hellfire, APKWS, LOCAAS, SA-16 guided rockets, and the AT-12 stabber, as kinetic energy weapons allows each to travel through walls with desired effects upon the target. The reader should not confuse this technique used with the "bug" discussed above. The author modeled these weapons as kinetic energy instead of area fire weapons because all agents within a squad fire an area fire weapon simultaneously at the same target, which would have resulted in an additional waste of precision guided munitions all targeted upon the same object. The downfall is that each of these precision munitions kinetically modeled incur a  $p(\text{kill}) = 1$  for the entire blast radius, which is not necessarily representative of real life. This limitation is mitigated by only firing precision munitions against targets having threat level values within the boundary limits annotated in Appendix A, section, "Model Unit Summary." This simulates only firing precision guided munitions against intended targets as authorized by a maneuver commander on the battlefield with the specific intent to destroy (not neutralize or suppress) each target.

As noted earlier, the author scaled down each platform sensor range to increase the simulation run time. The same holds true for each maximum range modeled as a kinetic energy weapon. Appendix A, section "Weapon Characteristics," provides converted valued needed for input out to 500 grids, or the entire battlefield length of 2.6 kilometers. The author experienced an agonizing sluggish run time as each agent searched the entire battlefield for targets. Shortening the maximum range to 96 grids

(500 meters) for each kinetic energy modeled weapon improved the simulation run time without significantly changing the results.

The last major workaround built within the scenario included two inactive and invisible “ghost” blue-dismounted squads with prepositioned locations on the battlefield. Once the Blue Force ICV drove within the specified distance of 20 grids (approximately 100 meters on the ground) the “ghost” agents changed states into active visible blue force dismounts. The downfall is that within one time step (equal to one second) the dismounts obtained a position equivalent to 100 meters on the ground. Again, the author judged this as acceptable for modeling purposes as it replicates the quick dispersion of infantrymen in securing a perimeter. In addition, this too had little, if any, consequences on the results.

## IV. DESIGN METHODOLOGY

*"NOUS SOUTIENDRONS"*  
*(We will support)*  
*42nd Field Artillery Brigade*

This chapter outlines the design of experiment (DOE) which supports, and bridges, the model development to the data analysis. Factors applied to help answer thesis questions are included within the DOE. This chapter also describes each measure of effectiveness (MOE) chosen to scope and quantify the analysis conclusions based upon the DOE. A brief mention of the tools and techniques supporting the UAV exploration follows at the last part of the chapter.

### A. DESIGN OF EXPERIMENT

An effective design of experiment (DOE) supports the simulation model that provides the data output for analysts to perform supporting work in the decision-making process. As mentioned earlier, and as a product of Project Albert, *Data Farming* provides a method to grow an abundance of data points for further exploration. The initial DOE chosen to support this analysis was a Nearly-Orthogonal Latin Hypercube (NOLH). The NOLH design efficiently searches the high-dimensional input space defined by an intricate response surface. The NOLH has the following characteristics<sup>74</sup>:

- Approximate orthogonality of all input factors
- A collection of experimental cases representative of the subset of points in the hypercube of explanatory variables (space filling)
- Ability to examine 20, or more, variables efficiently
- The flexibility to analyze and estimate multiple effects, interactions and thresholds
- Requires minimal *a priori* assumptions on the response

---

<sup>74</sup> Cioppa, Thomas M., *Efficient Nearly Orthogonal and Space-Filling Experimental Designs for High-Dimensional Complex Models*, (PhD. Dissertation, Operations Research Department, Naval Postgraduate School, Monterey, CA), 2002.

- Easy design generation
- An ability to gracefully handle premature experiment termination

Refer to Cioppa's dissertation for additional information regarding a NOLH.

Specific to the final study, a crossed robust NOLH DOE with 20 nearly uncorrelated input factors yielded 258 design points and paved the way towards the data analysis. The reader may appreciate the following example identifying one benefit for choosing such a design. A simple grid design consisting of 20 factors observed at only two levels each, requires  $2^{20}$  (or 1,048,576) design points. Design points and data runs are synonyms. If each run lasted only one computer minute, then it would still take 1.99 CPU years to finish running a single replication of the entire full design. Under the same conditions, 258 design points takes only 4.3 hours using a single computer.

A crossed design captures the single NOLH, with 129 design points, stacked on top of another NOLH with an additional 129 design points, while varying only one factor different between the two stacks. The remaining factors and each of their levels maintain the same values. A robust design captures both controllable and uncontrollable factors. Uncontrolled factors are synonymous with noise factors. This better reflects real world occurrences since it captures both controlled and uncontrolled situational entities.

### **1. Design Factors**

Several assumptions mentioned within the *Model Development* chapter of this thesis double as design factors. Since the FCS is a futuristic entity with some unknowns, each factor selected for the DOE supports a modeling assumption or addresses a thesis question. Selection of both controlled and noise factors ensured evaluating a robust design. Each controlled factor specifies UAV values, and each noise factor portrays uncontrolled elements such as environmental conditions, and enemy force sizes. Table 13 portrays the 20 nearly uncorrelated factors chosen for this design, respective levels, and factor explanations.

Factors numbered four and five outlined in Table 13 reveal the necessity for the crossed design. For this thesis, one battalion level UAV cannot carry both Warrior and APKWS missiles at the same time. The thesis explores the benefits of one missile type against the other by attaching only one type of missile per UAV for 129 runs each.



Keeping the remaining factors the same and substituting the Warrior missiles for APKWS missiles systematically, builds the crossed design and doubles the number of design points (runs) to 258.

Factor Number	Potential Decision (Controlled) Factors	Applied to each Squad # in MANA	Low Level	High Level	Explanation: Appropriate titles are listed as the Decision and Noise Factors for programing purposes
1	Number of UAVs CL I per team	20,21,22,23	0	6	Number of CL I UAVs per each A, B, C, and D teams
2	Number of UAVs CL II per team	24,25,26,27	0	6	Number of CL II UAVs per each A, B, C, and D teams
3	Number of UAVs CL III	28	0	16	Number of battalion level UAVs (This includes Warrior UAVs or CL III UAVs)
4	Number of Hellfire missiles in UAV Warrior	28	0	4	The number of precision guided missiles upon a battalion level UAV
5	Number of APKWS missiles in UAV CL III	28	0	8	The number of precision guided missiles upon a battalion level UAV
6	Sensor range and P(det) UAV CL I	20,21,22,23	0	2	The P(det) at a given sensor range for this type of UAV
7	Sensor range and P(det) UAV CL II	24,25,26,27	0	2	The P(det) at a given sensor range for this type of UAV
8	Sensor range and P(det) UAV CL III	28	0	2	The P(det) at a given sensor range for this type of UAV
9	Agents desire to go after enemy UAV CL I and II	20,21,22,23, 24,25,26,27	0	20	Tactical flight pattern of the UAV to fly towards, and circle (or possible) hover over a detected target
10	Agents desire to go to next way point UAV CL I and II	20,21,22,23, 24,25,26,27	0	20	Tactical flight pattern of the UAV to fly upon its intended path
11	Agents desire to go after enemy UAV CL III	28	0	20	Tactical flight pattern of the UAV to fly towards a detected target
12	Agents desire to go to next way point UAV CL III	28	0	20	Tactical flight pattern of the UAV to fly upon its intended path
13	UAV CL I flying speed	20,21,22,23	60	80	The equivalent ground speed of this type of UAV
14	UAV CL II flying speed	24,25,26,27	80	100	The equivalent ground speed of this type of UAV
15	UAV CL III flying speed	28,	80	140	The equivalent ground speed of this type of UAV
<b>Potential Noise (Uncontrolled) Factors</b>					
16	Number of initial enemy high pay off targets	1,2,3,6,10, 11	1	12	Initial number of enemy high pay-off targets
17	Map editor city cover and concealment	all	1%	100%	Density of obstacles and darkness within the urban location
18	Map editor inside building cover and concealment	all	1%	100%	Density of walls or other obstacles and darkness within the buildings
19	Communication Reliability due to inclement weather	20-28	0.75	1	The UAV communication links to ground elements are greatly hindered in inclement weather such as rain
20	UAV Concealment	20-28	0	0.9	UAVs concealed by low cloud cover

Table 13. Factor and Level Description for DOE

This next portion follows the example listed in the preceding paragraph regarding the time saving benefit of the NOLH DOE. Applying these 20 factors to a full factorial design, and evaluating incremented levels between the low and high level of each, combined with a six minute computer runtime for each design point, results in 6.9E48 CPU years to complete one iteration of the whole design. The crossed NOLH DOE limited the number of design points, or runs, to again only 258. By lowering the number

of design points, and using a cluster set of 12 computers to share all the runs, the number of computing hours lowered dramatically. The decreased total time allotted an additional 29 iterations per design point, enabling a “large sample” of 30 observations per point. Even with 30 iterations per design point, the total number of computing hours cumulated to only 2.68 CPU days per computer, resulting with 7740 rows and 102 columns of raw data ready for analysis scoped by the measures of effectiveness. This process repeated six times, evaluating different time-hacks within the battle. In total, the final production runs consisted of 46,440 simulated battles.

## **2. Measures of Effectiveness (MOE)**

Measures of effectiveness (MOEs) scope the analysis. An MOE is specific to the success or failure of the military mission. While the thesis concentrates on UAVs, recall that the UAV, and other FCS platforms, are only supporters of combat soldiers. One of the Army’s mottos, “Mission first, people always” helped narrow the focus of the MOEs for this thesis.

Recall that the CAB’s mission is to secure the urban area, OBJ Dallas. Though the UAVs, and precision munitions platforms are an intricate part of the mission accomplishment, much of the FCS is robotic in nature, and the only way to effectively secure the urban area is with the dismounted infantry. This suggests looking at ways to measure mission accomplishment through the success or failure of the infantry. An 80% survival proportion of the Blue Dismounts at their final waypoint at the end of a 2-hour battle portrays seizing the objective for this analysis. The CAB’s ability to fire precision munitions against Red Force High Pay-off Targets (HPTs) directly affects the ability of the CAB to accomplish their mission. Scouting platforms, such as the UAVs, provide the TA for the use of precision munitions. For this analysis, the HPTs are the Red Force entities precluding the Blue Force in delivering infantry to the close fight, thus obscuring the specific mission to secure the objective. The HPTs include the SA-16 agents trying to destroy the Blue UAVs and other air assets. Other HPTs are the BMP-3, 82 mm mortars, scouts, APC, and T72 platforms, who deliver firepower to the deep fight, intended to minimize the CAB’s penetration and delivery of dismounts to the close fight. To accomplish the mission, the Blue Force has a desire to preserve their High Value Targets (HVTs).

In this model, the HVTs are the Blue Force platforms that if destroyed by the enemy will fail to protect the dismounts prior to arriving to the close fight. This effect ultimately causes deaths among the Dismounts and failure to their mission. People always, reflects the sacred desire to minimize dismounted deaths, for without the dismounted infantry, the Blue Force would never secure the urban area. TRAC-Monterey approved the following MOEs,<sup>75</sup> chosen for this analysis in this order of importance:

- Proportion of Blue Dismounts (Infantry) survived
- Proportion of Red High Pay-off Targets (HPTs) killed

Note: For this thesis, the Blue Dismounts (Infantry) only refer to those soldiers who dismount from an ICV with the specific mission to secure the urban objective while on foot. The ICV driver, who remains inside the ICV, as well as other soldiers who remain inside other platforms such as an MCS, are not included in the calculations as measured by the first MOE.

## **B. TOOLS AND TECHNIQUES**

Visual observation of the MANA model provides a certain degree of value; however, the purpose of MANA is essentially to “explore the greatest range of possible outcomes with the least set-up time.”<sup>76</sup> This section describes the tools and techniques used to complement MANA’s quick build up approach and to create a valuable DOE resulting in a quick, vast, and effective data analysis.

### **1. DOE Software Tools**

The tools bridging MANA to the analysis include spreadsheet modeling with Excel; Tiller©; XML; and Ruby scripting. As described in the *Model Development* chapter of this thesis, the author maintains that spreadsheet modeling provides an organized method to perform the thought process, while simultaneously cataloging important modeling parameters.

---

<sup>75</sup> Jeffrey Schamburg, LTC, Director, TRADOC Analysis Center – Monterey, Naval Postgraduate School, Monterey California.

<sup>76</sup> Galligan, p. 2.

**a. Spreadsheet Modeling with Excel**

Appendix B, section “DOE Spreadsheet Modeling” outlines the crossed NOLH DOE. There exist three spreadsheet models. The first is the factor description and is similar to that of Table 13. It outlines both the controlled and noise factors creating the robust design. The second spreadsheet is a NOLH coded spreadsheet for 17-22 factors detailing the factor levels used at each of the 129 design points.<sup>77</sup> The third spreadsheet is a design file and looks very similar to the second. This file adds an additional nine correlated factors. These are correlated to each of the UAV P(det) factors. The correlation represents the modeled monotonic increase in the P(det) incurred at extended ranges, rather than just studying a single “cookie-cutter” sensor range. The design file incorporates the final crossed NOLH DOE with 258 design points. The process dovetails both the design file and the Ruby scripting procedures annotated in the following paragraphs.

**b. XML**

Though MANA offers an easily viewed GUI to input data values, analysts may also build MANA scenarios and edit them using the Extensible Markup Language (XML), as all MANA databases are stored and transmitted in XML. XML offers a simple and very flexible text format device derived from SGML (ISO 8879). Technicians originally designed SGML to meet the challenges of large-scale electronic publishing; XML also plays an increasingly important role in the exchange of a wide variety of data on the internet.<sup>78</sup> Storing scenarios in XML permits the analyst to transmit scenario files quite rapidly over the internet to perform Data Farming techniques. This process occurs with agencies such as the Maui High Performance Computing Center (MHPCC) and enables thousands of design points to run over a networked cluster of computers in a short amount of time.

**c. Tiller©**

The Tiller, Version 0.7.0.0, Copyright 2004 Referentia Systems Incorporated, is a product developed in support of Project Albert and the Marine Corps

---

<sup>77</sup> NOLH 17-22 Factors, coded by Professor Susan Sanchez, Naval Postgraduate School, Monterey, California.

<sup>78</sup> W3C, Extensible Markup Language, referenced 18 October 2005 from the World Wide Web at <http://www.w3.org/XML/>

Warfighting Laboratory. Its primary purpose is to prepare model XML scenarios for Data Farming. It provides DOE options such as the Random Latin Hypercube, coded by Professor Paul Sanchez, Naval Postgraduate School, and a Nearly Orthogonal Latin Hypercube, coded by Professor Susan Sanchez, Naval Postgraduate School. The final output of the Tiller is a usable *study.xml* file containing the chosen DOE for running at any computer cluster facility.

The Tiller application may be used alone to process the DOE, or as performed in this thesis, may be used in conjunction with an object-oriented programming language, such as Ruby, to modify the XML. XML modifications lockstep the additional nine correlated factors within this design. In addition, it quickly links the multiple squads depicting the same factor values as annotated from the design. Though the Tiller is useful, the author found the application rather lengthy when applying all 20 factors, at each level, for each squad, and for each set of pre-analysis DOE iterations performed. Instead, the author used the Tiller to build a skeleton *study.xml* file once, and then performed further XML manipulation solely with the rapid process of Ruby Scripting. Appendix B, section “Tiller,” outlines the Tiller GUI.

#### *d. Ruby Code and Scripting*

Ruby is a reflective, object-oriented programming language. It combines syntax inspired by Ada and Perl with Smalltalk-like object-oriented features, and also shares some features with Python, Lisp, Dylan and CLU. Ruby is a single-pass interpreted language. Programmers describe Ruby as behaving intuitively, or as the programmer assumes it should, not as expected by the computer itself.<sup>79</sup>

Refer to Appendix B, section “Ruby Scripting,” to observe the Ruby code and scripting process written by Paul Sanchez that modified the skeleton Tiller *study.xml* file for all DOE iterations performed.

## **2. Analysis Software Tools (JMP Statistical Discovery Software™)**

JMP Statistical Discovery Software™ contains the software features used for the Data Analysis portion of this thesis. The Data Analysis is included in the next chapter of this thesis.

---

<sup>79</sup> Wikipedia.org, Ruby Programming Language, referenced 18 October 2005 on the World Wide Web at [http://en.wikipedia.org/wiki/Ruby\\_programming\\_language](http://en.wikipedia.org/wiki/Ruby_programming_language)

The author chose JMP as the tool to support the majority of the Data Analysis because JMP provides interactive graphical and desktop statistics. JMP excels at helping analysts uncover relationships and outliers within the data. This unveils valuable discoveries, unleashes surprises, and supports better decision-making. It joins statistics with graphics, and the flexibility to see the data from all angles to discover these relationships and outliers.<sup>80</sup>

### **3. Analysis Techniques**

Most large databases yield the flexibility to perform a wide array of data analysis techniques. Though this analysis applies statistical tests, the core analysis focuses primarily on three techniques: Graphical Analysis, Multiple Regression, and Classification and Regression Trees.

#### ***a. Graphical Analysis***

Graphical analysis provides a visual method to sift and explore through data sets to find unexpected relationships. Statistical experts describe exploratory analysis as *data-driven hypothesis generation* in search of structures that may indicate deeper relationships between cases or variables.<sup>81</sup> The output graphs from this analysis will assist military decision makers by providing UAV insights without requiring the decision maker to read the entire thesis.

#### ***b. Classification and Regression Trees (CART)***

The CART (Classification and Regression Trees) algorithm is a widely used statistical procedure for producing classification and regression models with a tree-based structure. The principle behind building tree models is to identify significant factors. This is done by partitioning the space spanned by the factors to minimize the score of variance (or impurity) of response data at each branch node. Depending on the particular score chosen, high purity occurs when the majority of points in each cell of the partition are similar. This is a recursive process and repeats as many times as necessary so that each end branch defines a separate node.<sup>82</sup> <sup>83</sup> The regression tree yields a

---

<sup>80</sup> JMP, The Statistical Discovery Software, referenced 18 October 2005 on the World Wide Web at [http://www.jmp.com/product/jmp5\\_brochure.pdf](http://www.jmp.com/product/jmp5_brochure.pdf)

<sup>81</sup> Hand, David, Heikki Mannila, and Padhraic Smyth, *Principles of Data Mining*, (MIT Press, Cambridge, Massachusetts, 2001), p. 53.

<sup>82</sup> Montgomery, Douglas, Elizabeth Peck, and Geoffrey Vining, *Introduction to Linear Regression Analysis, Third Edition*, (John Wiley and Sons, Inc, 2001), p. 516.

continuous output. Classification trees, however, are the product of a discrete categorical output based on a hierarchy of univariate binary decisions.<sup>84</sup> The CART algorithm will classify significant UAV factors into classes complimented by further regression analysis.

**c. Multiple Regression**

A general regression analysis is a statistical process that investigates the relationship between two or more variables (factors) related in a nondeterministic fashion. Regression itself means coming or going back. The objective in multiple regression is to build a probabilistic model that relates a dependent variable  $y$  to more than one independent or predictor variables. Then the predicted values of each variable are “pulled back in” towards the mean.<sup>85</sup> The actual  $y$  values in a sample differ from the predicted values. The errors or *residuals* denoted by  $e$ , are the differences between the observed and predicted values, hopefully possessing a normal distribution with constant variances.<sup>86</sup> The regression analysis is practical for gaining insight on which predictor variables (design factors) have the greatest significance towards the success of the FCS CAB mission, as measured by the previously mentioned MOEs. Regression analysis is also useful in identifying interactions between input variables.

---

<sup>83</sup> Hand, pp. 145,343.

<sup>84</sup> Hand, p. 147.

<sup>85</sup> Devore, Jay L., *Probability and Statistics for Engineering and the Sciences, Sixth Edition*, (Brooks/Cole, 2004), pp. 497,587.

<sup>86</sup> Devore, p. 587.

THIS PAGE INTENTIONALLY LEFT BLANK



## V. DATA ANALYSIS

*"CONJUNCTI STAMUS"*  
*(United We Stand)*  
*27th Field Artillery Regiment*

This chapter contains the significant results of the data analysis drawn for conclusions. Within the chapter, there are three sections: Data Compilation, Initial Observations, and Closing Observations Related to Thesis Questions. Each section paints the iterative process identifying significant findings. The closing observations section outlines each thesis question, the measure of effectiveness addressing the question, and the significant observations and findings pertaining to each question. (Note: Dismounts and Infantrymen are synonymous throughout the analysis)

### A. DATA COMPILATION

Receiving a multitude of data consisting of over 46640 data runs, with 102 variables each, begs the question, what now? This is raw data. Analysis of the raw data could be an endless process. In addition, since MANA is stochastic in nature, heteroscedasticity, or variance of the variability, can be quite prevalent within the raw data. On one hand, ignoring it may bias the standard errors and  $p$  values. On the other hand, its effect, though not detrimental, possibly weakens an analysis. In an attempt to minimize, and apply better-suited models without losing core information, the aggregated means of each of the replicated 30-design points builds a single measure of centrality used for analysis procedures.<sup>87</sup> The benefit of aggregating the means becomes lucid after viewing Figure 12 in the next section.

For simplicity, this analysis concentrates on the multiple means, or averages, of the outcomes. Though this technique delivers possibly an inflated  $R^2$  value (measuring how well the regression line approximates real data points), it compliments the analyst's ability to identify otherwise unforeseen significant factors when Data Farming.

---

<sup>87</sup> Lindquist, p. 59.

## B. INITIAL OBSERVATIONS

Applying the robust crossed NOLH DOE outlined in Chapter IV of this thesis, the initial analysis presented surprising results. The overwhelming flavor of the results suggested that the noise (uncontrollable) factors included within the robust experimental design were more significant than that of the actual number of UAVs assigned within the CAB. The regression trees shown in Figures 10 and 11 identify enemy and terrain factors as having greater significance than that of the number of UAVs assigned within the CAB. Specifically, we observe the city and building density (modeled as cover and concealment) and the initial number of enemy HPTs possessing higher significance. There are 258 observations within each tree. Initial observations also show that the Blue Force predominately achieves their objective while maintaining most of their Infantry and annihilating most of the enemy HPTs. The trees show 0.9 as the mean for the proportion of HPTs killed and 0.95 as the mean for the proportion of the surviving Blue Dismounts. Notice in Figure 10, the first significant split occurring at the factor labeled “City Cover and Concealment,” depicts a vast difference among the number of observations and its respective mean—much more so than that of each subsequent branch. Though the “number of CL I UAVs” factor does appear in Figure 10, suggesting its significance, it does so only once and on the third split. In addition, numerous splits of “Building Cover and Concealment” suggest possibly a non-linear relationship.

Figure 10 shows multiple paths that span out as branches of the tree. One path is as follows. There are 258 total observations. Recall that each observation is an aggregated mean of 30 replications. The overall mean is 0.90 as measured by the proportion of HPTs killed. The first split occurs on the parameter City Cover and Concealment. Of these observations, 236 occur when the parameter value is less than 0.92, indicating a slightly less dense city environment comprised of perhaps walls, obstacles, and rubble. Among the 236 observations, only eight occur when the Building Cover and Concealment parameter exceeds 0.97, indicating a denser environment within the buildings. When the Building Cover and Concealment is less dense, as in this split at 0.97, then the Blue force performs better, as seen by a mean of 0.91 over 0.80 from the other eight grouped observations. Finally, of the 228 observations, 198 occur when the initial number (of each type) of HPTs at the beginning of the battle is equal to three or

more. From the initial robust DOE, we observe that the proportion of HPTs killed is inversely proportional to the initial number of HPTs on the battlefield, suggesting that the Blue Force is not as capable against a larger enemy, nor when fighting in a denser city. Observe in Figure 10, the mean is highest among a smaller sample (only 30 observations) in which the number (of each type) of enemy HPTs is less than three, and when the fight occurs in a less dense city and building environment.

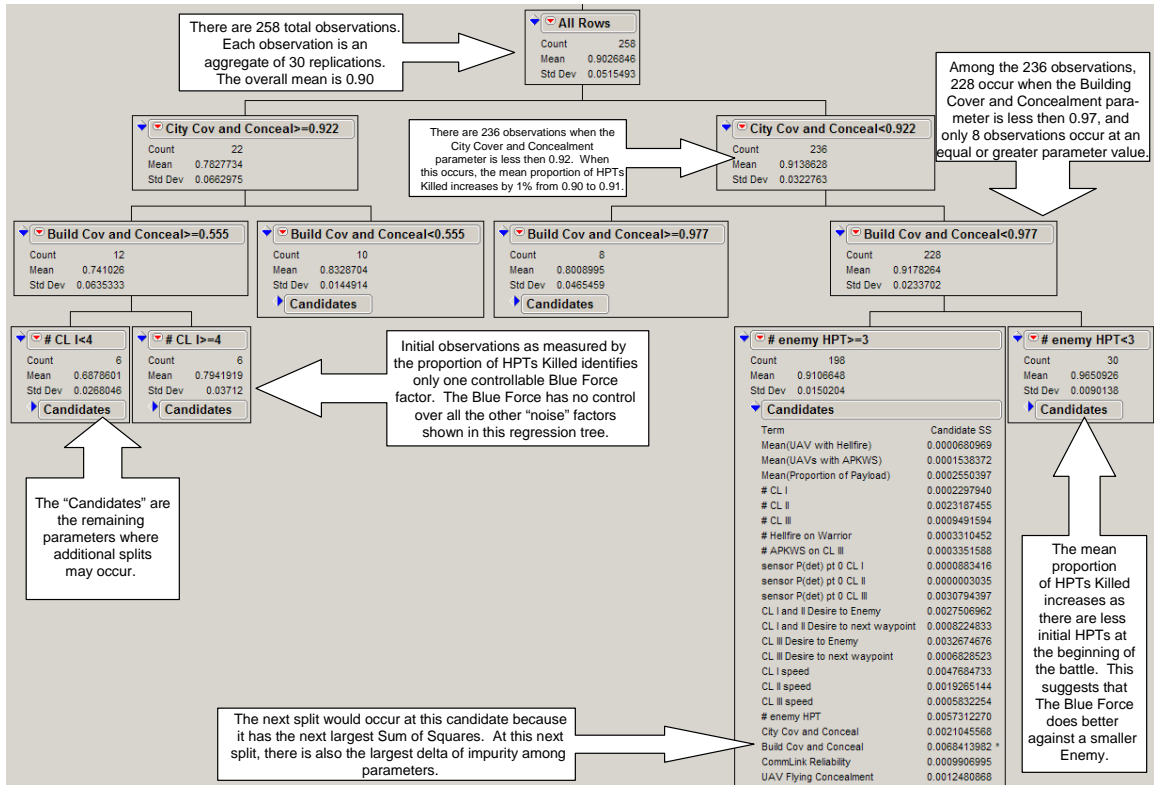

Figure 10. Regression Tree, with MOE: Proportion of HPT Killed

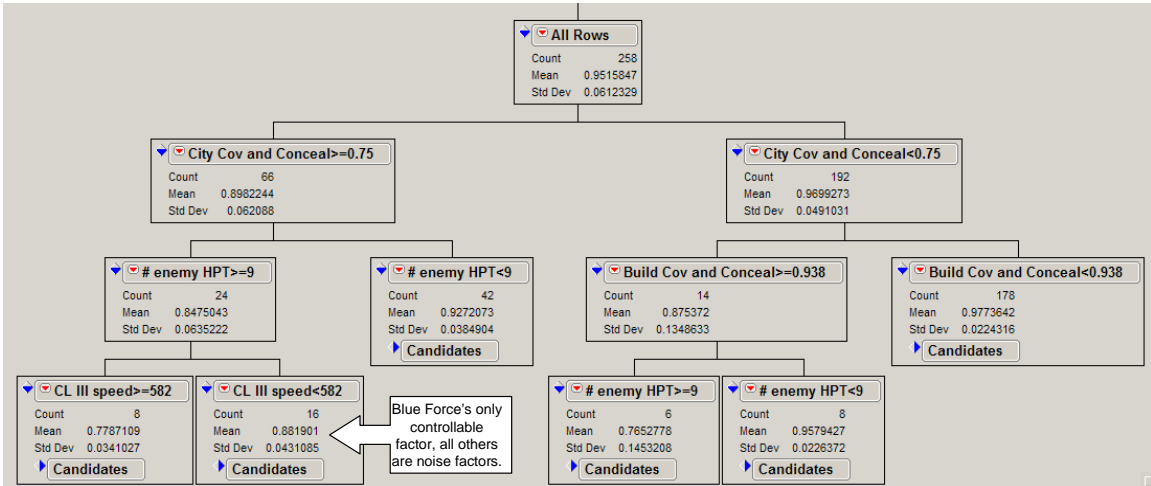

Figure 11. Regression Tree, with MOE: Proportion of Dismounts Survived

Furthermore, the initial analysis suggests that the Blue Force is overwhelming in this scenario, and that changing the levels of each factor, to include the number of UAVs, has little effect on the overall outcome. Again, the Blue Force predominately maintained almost all of its infantry, while almost destroying the enemy's entire supply of HPTs.

Figure 12 shows two histograms and their associated box plots, quantiles, and moments information. The histogram (bar chart) represents a frequency distribution predicting the number of observations occurring at each of the recorded proportions. The proportion scales from zero to one. The box plot graphically represents the numerical information listed in the quantiles and moments portions of the figure. Quantiles are the points at which various percentages of the total sample are above or below, and moments combine the individual data points to form descriptions of the entire data set.<sup>88</sup> The median is the horizontal line in the center location of the box. In both, the right edge of the box is much closer to the median than is the left edge, indicating a very substantial skew in the middle half of the data.<sup>89</sup> The whiskers protruding from each box represent the observations outside the quartiles, and the single dots represent possible outliers. The furthest dots from the mean are then extreme outliers. The box itself represents the interquartile range, and symbolizes observations ranging from the 25<sup>th</sup> to the 75<sup>th</sup>

<sup>88</sup> Sall, p. 118.

<sup>89</sup> Devore, p. 41.

percentiles of the collected data. Refer to the key within Figure 12 for additional information regarding the observations.

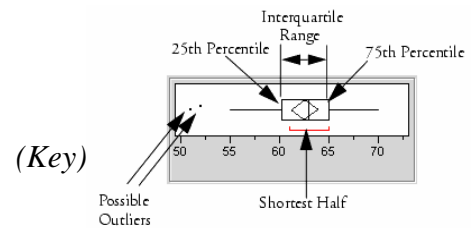
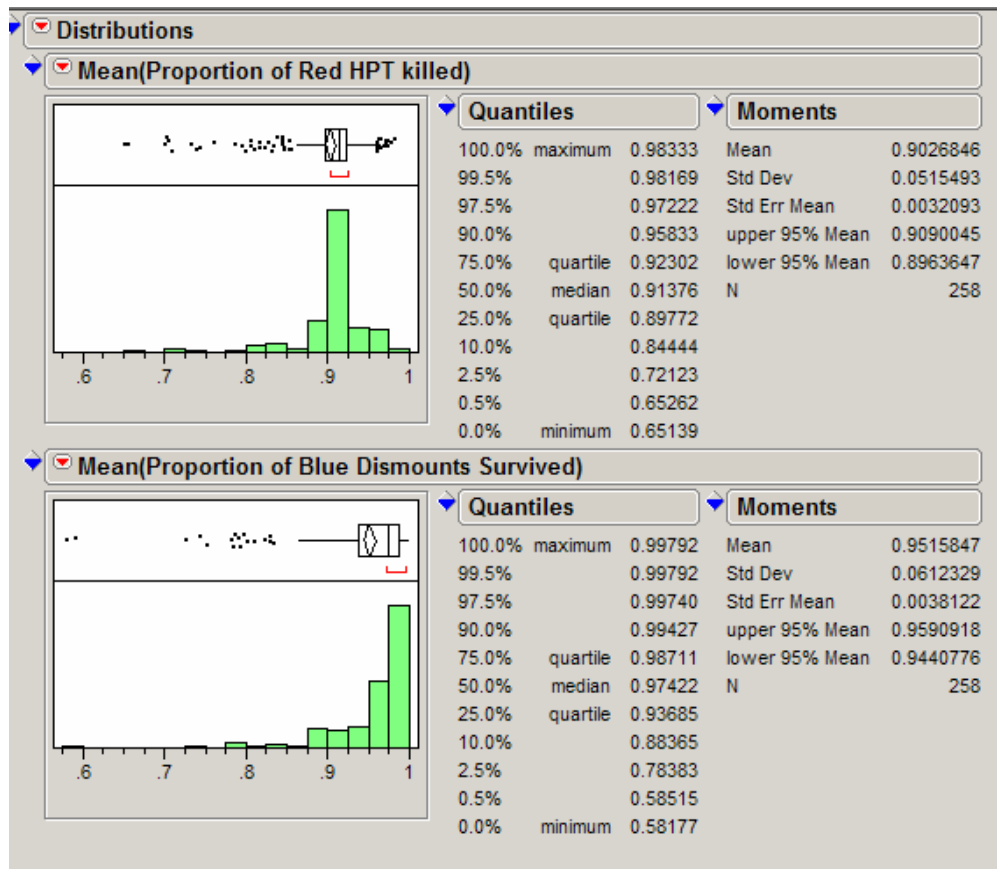

Figure 12. Histograms of Initial Analysis with Robust DOE <sup>90</sup>

Figure 12 contains 258 observations in each plot. Each histogram portrays a skewed advantage towards Blue Dismounted Infantrymen surviving, and the annihilation of Red HPTs. Each histogram illustrates two extreme outliers as measured by the established MOEs. The histogram on the bottom portrays two observations reflecting an unacceptable survival level of Blue Dismounts at only 60%. The histogram on the top

<sup>90</sup> JMP IN, *JMP 5.5.2 Help Command*, SAS Institute Inc, 2004.

portrays two observations reflecting 65% of enemy HPTs killed, in relation to its mean at 90%. Recall that each of these data points is an aggregation of 30 original observations averaged about each point. The 30 replications yield similar observations due to initial battlefield settings determined from the experimental design. Therefore, each outlier is not a single observation, but rather the mean of 30 observations. This identifies something significant causing a possible spread of 30 undesirable outcomes affecting the mission. As suggested previously, aggregating the means brought forth an insight otherwise difficult to observe. These outliers implored the author to determine the initial parameter settings that caused such undesirable mission results.

Examining the model and data output simultaneously identified a generality among each of these specific outliers. It revealed that the initial parameter levels for several of the noise factors were higher in each of these 30 replications than that of other data runs. The most dominant of these noise factors contributing to mission detriment, as measured by the MOEs, is a denser city environment coupled with a greater number of initial enemy HPTs. In essence, a value closer to “1” for both the city and the building cover and concealment parameters within the model yielded a denser city with perhaps more obstacles that offered greater protection to the enemy from the Blue Force.

A fitted model developed through a stepwise regression and labeling each of the MOEs as the  $y$  variable resulted with a summary of fit and parameter estimates complimenting the regression tree analysis. Setting  $y$  as the proportion of Blue Dismounts surviving, and examining all 20 factors, without interactions, resulted in a fitted model with  $R^2$  equal to 0.42. This  $R^2$  suggests that the fit to the real data points is lower than desired. However, Figure 13 maintains that the noise factors are more significant than the others as measured by their high  $F$ -ratios. This measurement is with respect to the proportion of Blue Infantrymen surviving. Appendix C, “Initial Observations,” holds the entire model as determined by the multiple regression process. The entire output, as well as similar results for the Red HPTs killed, is within this appendix. The  $F$ -ratios portrayed from multiple regression also suggest the significance of having armed battalion level UAVs. In addition, UAV tactical capabilities such as speed, sensor range, and employment to fly towards the enemy targets are more significant than that of the specific number of UAVs assigned within the CAB.

Source	Nparm	DF	Sum of Squares	F Ratio	Prob > F
# Hellfire on Warrior	1	1	0.01398357	6.2346	0.0132
# APKWS on CL III	1	1	0.00973069	4.3384	0.0383
sensor P(det) pt 0 CL III	1	1	0.00608539	2.7132	0.1008
CL I and II Desire to Enemy	1	1	0.00466474	2.0798	0.1505
CL I speed	1	1	0.00548193	2.4441	0.1192
CL II speed	1	1	0.00627712	2.7987	0.0956
# enemy HPT	1	1	0.10503218	46.8286	<.0001
City Cov and Conceal	1	1	0.15357172	68.4699	<.0001
Build Cov and Conceal	1	1	0.10478362	46.7177	<.0001
CommLink Reliability	1	1	0.01102546	4.9157	0.0275

Figure 13. Tests of Main Effects (Stepwise Linear Regression Model Fit)

An interesting note is that performing a multiple regression with interactions between factors raised the  $R^2$  to 0.80, suggesting an improved fitted model. With interactions applied to the model, the Effect Test output, similar to Figure 13, is too large for the main body of the thesis. The output for this model is located in Appendix C, “Initial Observations.” This improved model was similar to the first in that the most significant factors are those that are uncontrolled by the Blue Force.

Identifying this generality resulted in modifying the DOE, and setting the parameter levels for the final observations within the data analysis. Changes to the DOE included eliminating the various levels of each of the three noise factors already discussed and setting their levels to stable values which provide a greater amount of detriment to the CAB’s ability to complete its overall mission. Similar insight on some of the other outliers portrayed in Figure 12 led the author to stabilize the two remaining noise factors: Communication Reliability due to inclement weather and UAV Concealment due to various cloud cover. The enemy, terrain, and weather predominately outweighed any controlled factors within the DOE. Stabilizing the level of each the noise factors at values that posed a stronger threat against the Blue Force, eliminated the robustness of the design. Eliminating the robustness at this stage parallels the Intelligence community’s process in providing the enemy’s most capable course of action (COA) during a war-gaming design exercise. This action permitted the author to concentrate the remaining analysis on controllable Blue Force factors. This follows suit with the Operations community building friendly COAs. The observations obtained through the initial regression analysis set each of the noise parameter levels for all the

remaining data runs. The stable levels for each noise parameter are as follows: 12 platforms for each type of HPT, 0.85 for the Map Editor City Cover and Concealment, 0.95 for Map Editor Building Cover and Concealment, 100 for Communication Reliability, and 90 for UAV Concealment due to cloud cover.

The fitted model determined by the process of multiple regression identifies the number of UAVs flying at each level. For both the initial and closing observations sections of this chapter, the model is in the form:

$$\hat{y} = \hat{\beta}_0 + \sum_{i=1}^k \hat{\beta}_i x_i + \sum_{i=k+1}^{2k} \hat{\beta}_i x_i^2 + \sum_{i=1}^{k-1} \sum_{j>i} \hat{\beta}_{i,j} x_i x_j$$

where

$$\hat{y} = MOE$$

$$\hat{\beta}_0 = \text{intercept}$$

$$\hat{\beta}_i = \text{parameter estimate}$$

$$x_i = \text{parameter (or factors)}$$

and where applicable

$$\sum_{i=k+1}^{2k} \hat{\beta}_i x_i^2 = \text{quadratic terms}$$

$$\sum_{i=1}^{k-1} \sum_{j>i} \hat{\beta}_{i,j} x_i x_j = \text{interaction terms}$$



### C. CLOSING OBSERVATIONS RELATED TO THESIS QUESTIONS

The iterative process detailing the data analysis identified the need to stabilize all the noise factors (minus communications) at levels stressing to the Blue Force. Simultaneous efforts also raised an inquiry to question if different time hacks on the battlefield provide any insight to answering the thesis-based questions.

#### 1. Battlefield Time Hacks

Recall that the CASTFORM NEA 50.2 vignette is an 18-hour battle, and that this research focuses only on a 2-hour window. Within the 2-hours, what time is most critical? Stabilizing the noise levels, and performing six additional iterations of the battle (running each simulation for the first 7.5, 15, 30, 60, 90, 120 minutes) shows that the battle damage asymptotes as time increases. Figure 14 depicts the asymptotic curves suggesting that the Blue Force kills most of the Red HPTs early in the fight—fifty percent within the first 450 seconds (7.5 minutes) and sixty-five percent within the first 900 seconds (15 minutes) of the battle. A more important observation reveals a 5% loss in Blue Dismounts within the first 15 minutes. The percentage increases until the end of the first hour (3600 seconds) where it tapers off to 25% (75% strength of initial force). These observations focused the remaining analysis toward the initial part of the battle.

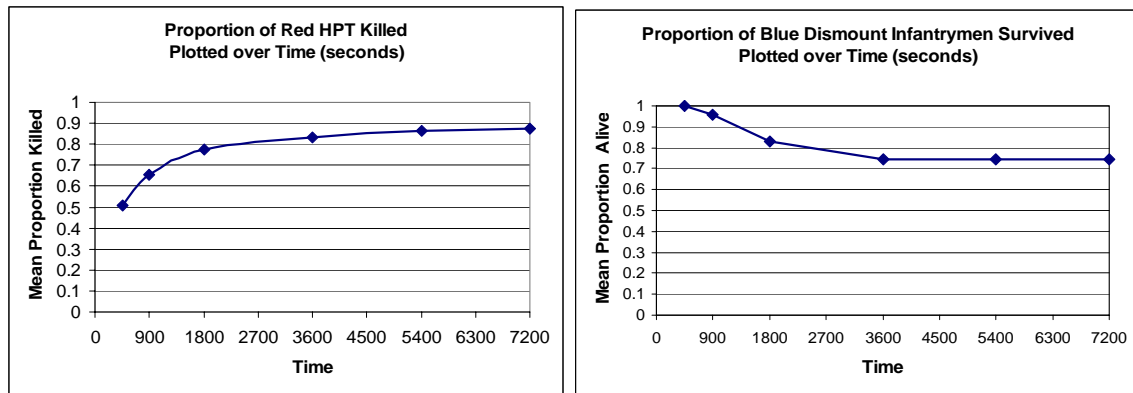

Figure 14. Graphical Analysis: Battlefield Time Hack without robust DOE

Note: The Blue Infantry normally do not dismount from their ICV until roughly 600 seconds into the battle. Recall that this simulation is a stochastic (not a time) driven event. Therefore, the time varies occasionally as reflected in Figure 15. Figure 15 shows a possible Blue Dismount killed by the 450<sup>th</sup> second.

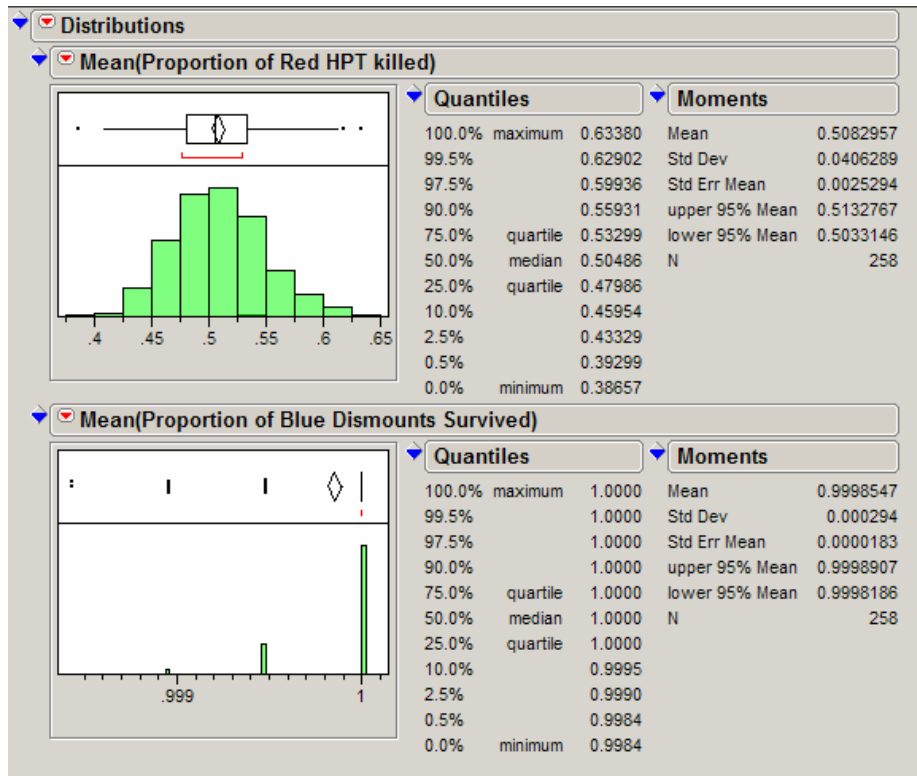

Figure 15. Histograms at 450 seconds (7.5 minutes)

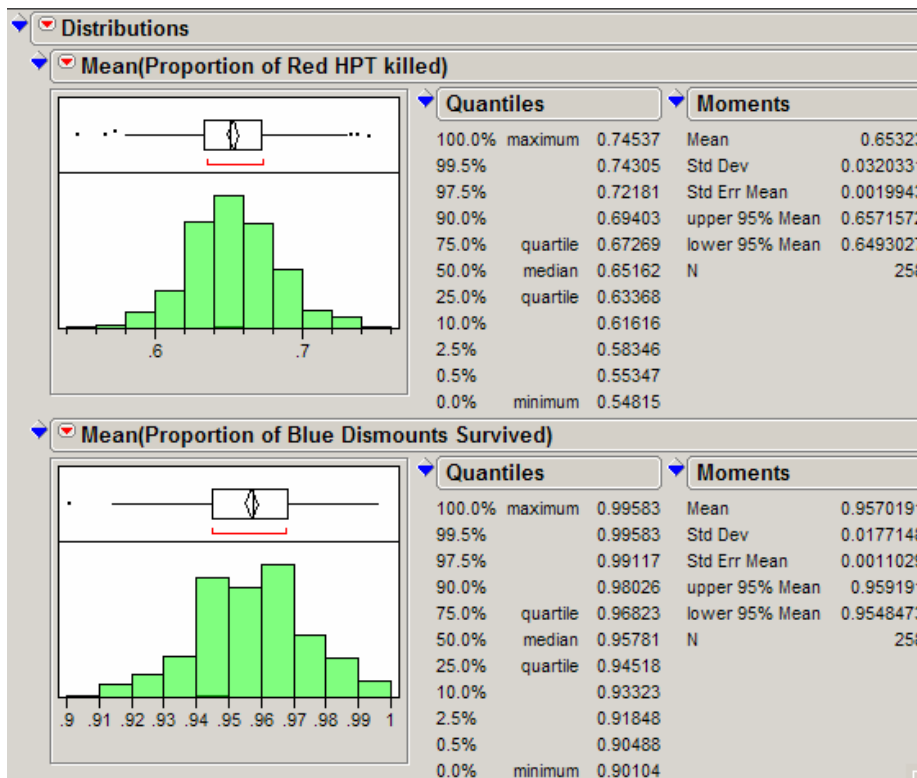

Figure 16. Histograms at 900 seconds (15 minutes)

## 2. The Early Fight

Prior to analyzing the early fight, a  $t$ -test identifies the significance of the first 15 minutes in comparison to the entire 2-hour fight. The 15-minute mark chosen for the  $t$ -test ensures the infantry's delivery to the close fight (Figure 16). The null hypothesis is that the means are equal when comparing the 15-minute and a 2-hour battle. Recall the 15-minute battle observations result from a DOE depicting a stronger enemy, whereas the 2-hour battle observations result from a DOE encompassing a variety of noise factor levels.

The reader should not compare the two  $t$ -tests depicted in Figure 17 to each other. Each graph and corresponding  $t$ -test represents different entities. Recall the MOEs are the proportion of HPTs *killed*, and the proportion of Blue Dismounts that *survived*. As such, each  $t$ -test speaks volumes on their own accord, as outlined in the following paragraphs.

There exists a significant difference between the means when comparing the proportion of Red HPTs *killed*. This significance is proved by the two-sided  $P$ -value ( $\text{Prob} > |t|$ ) equal to "0" as shown in the top half of Figure 17. A smaller  $P$ -value suggests more contradiction to the null hypothesis,<sup>91</sup> thus identifying a significant difference between the means. Figure 17 shows expected results benefiting Blue's fight as measured by the first MOE, proportion of Red HPTs killed. Contrary, the same figure also portrays what should be dreadful results to the military reader as measured by the second MOE, proportion of Blue Dismounts survived.

There is not as much significant difference between the means when comparing the proportion of *surviving* Blue Dismounts; however, the variances are clearly different. The two-sided  $P$ -value is equal to 0.16, and the single sided  $\text{Prob} < t$  is equal to 0.92. Therefore, there does not exist enough evidence to reject the null hypothesis, and for all practical purposes, the means are the same. The author claims that this initial 5% loss of infantry during the first 15 minutes of combat is detrimental to the mission. Recall that this is the same 5% loss occurring at the end of a 2-hour fight with a more random enemy, as posed by the robust DOE. This raises the author's eyebrow and suggests that

---

<sup>91</sup> Devore, p. 347.

military leaders should devise a system minimizing casualties within the first 15-minutes of a fight when up against a strong enemy.

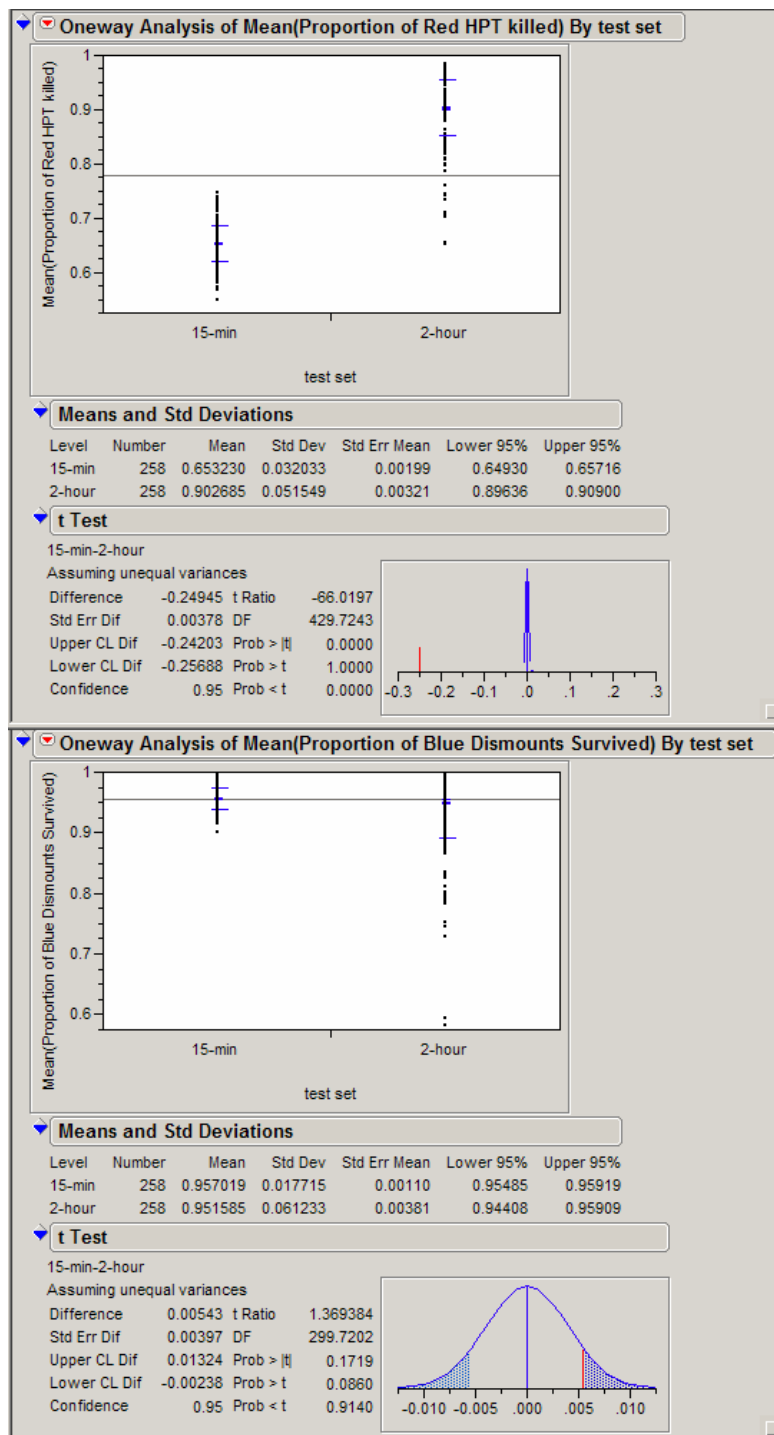

Figure 17. *t*-Test Results Between a 15-minute and 2-hour Battle

Left to the reader is the option to perform an additional *t*-test identifying similar results when comparing the 7.5-minute mark to the entire 2-hour battle. The analysis format for the remainder of this chapter mirrors the order of the thesis questions outlined in Chapter I.

*a. How many Platoon, Company, and Battalion level UAVs are needed for the FCS to secure the urban environment?*

Securing the urban area is binary, either the Blue Force did, or it did not. TRAC-Monterey defines securing the urban environment for this scenario as the Blue Force Dismounts reaching their final waypoint with 80% of their initial strength remaining. Recall that the initial analysis of the robust DOE showed the mean proportion of Blue Dismounts surviving at 0.95. This is different from the secondary analysis of the Blue Dismounted strength when the changed DOE reflected a 25% loss at the end of the same 2-hour duration. Since the iterative process drove the analysis to concentrate on the initial part of the battle, the Blue Dismounts do not have enough time to reach their final waypoint at either of the 7.5 or 15-minute time hacks. Therefore, the question asking if the Dismounts reached their final waypoint is not addressed within the context of this analysis. Instead, the question asks what needs to occur early in the fight in order to minimize Infantry deaths (less than 20%) by the end of the 2-hour duration. The answer is to minimize the HPTs prior to the Infantry's arrival to their dismounted checkpoint.

The scatterplot in Figure 18 supports the claim in minimizing HPTs. The covariance matrix, also in Figure 18, depicts how strong the two output MOEs relate to one another. The proportion provides reason for the small values appearing within the covariance matrix. According to 95% of observations (depicted by the oval shape), there is a positive correlation (about 0.4) between the proportion of surviving Blue Infantry and the proportion of Red HPTs killed. This positive correlation supports the observations gleaned when viewing the simulation model. There is a lower survival rate of Blue Dismounts when the Red Force has more HPTs alive on the battlefield.

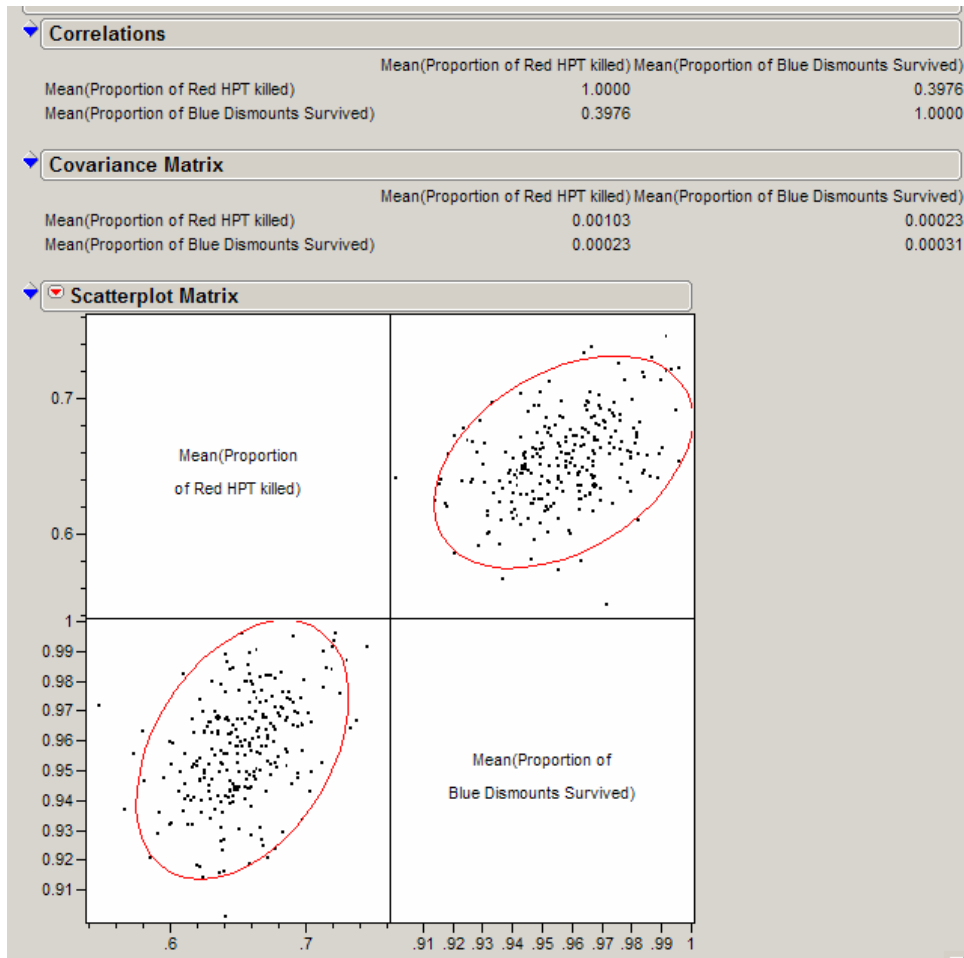

Figure 18. Scatterplot Matrix (Positive Correlation Between HPTs and Dismounts)

The top portion of Figure 19 portrays the model fit with each observation positioned along the line of fit within an ideal manner. The line of fit is the centered straight-line protruding at a 45-degree angle. The line of fit shows where the actual response and the predicted response are equal. The distance between the line of fit and each observation is the residual, or error ( $e$ ), for that point. The horizontal dashed line identifies the mean 0.92. The adjusted  $R^2$  for this model is 0.89. The closer the adjusted  $R^2$  is to 1.0 implies a better fitted model for its data. This adjusted  $R^2$  suggests a good fitted model for this data.

The middle portion of Figure 19 is a diagnostic plot (a basic plot that assesses the validity and usefulness of a model, also known as a residual plot). The residual ( $e$ ) is on the vertical axis, and the MOE is on the horizontal axis. The points follow a random distribution about 0 implying constant variances, free of heteroscedasticity (explained earlier in the chapter). This is observed from the absence of any unusual or distinct pattern of points, thus providing a good visual assessment of model effectiveness.<sup>93</sup> The bottom portion of Figure 19 is another diagnostic plot useful for visualizing the extent to which the residuals are normally distributed. The histogram of the residuals appears to have a normal distribution. The appearance of a normal distribution is reinforced by the diagonal straight line shown in the Normal Quantile Plot. This kind of plot is also called a quantile-quantile plot, or Q-Q plot. The Q-Q plot also shows Lilliefors confidence bounds, reference lines, and a probability scale.<sup>94</sup>

Refer to Appendix C, “Early Fight,” to observe the full model for Figure 19. Also refer to Table 14 to observe the most significant factors and interactions yielding the greatest effects within this regression. Since the Sum of Squares for each are all quite small (due to measuring proportions), and the model is quite large, the author lists  $F$ -values greater than 25.0 in order to identify the significant factors. Table 14 outlines these factors. Refer to the appendix to review the remaining significant factors.

---

<sup>92</sup> Sall, p. 314.

<sup>93</sup> Devore, pp. 557-559.

<sup>94</sup> JMP IN, *JMP 5.5.2 Help Command*, SAS Institute Inc, 2004.

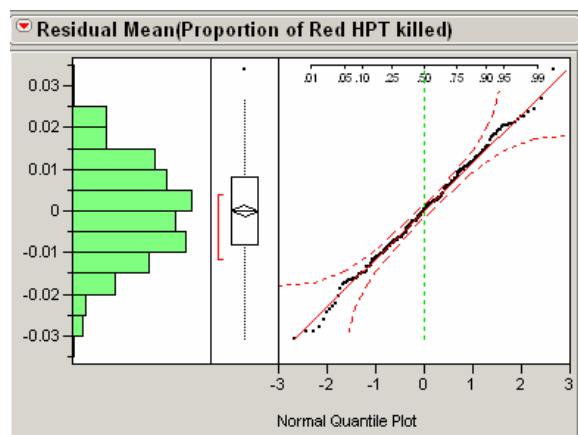
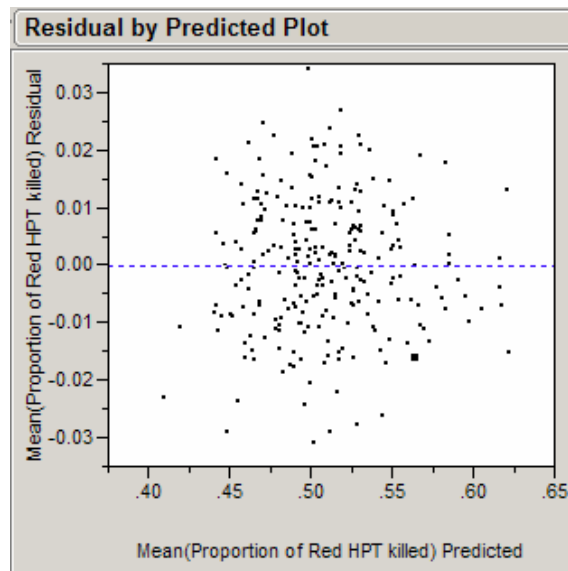
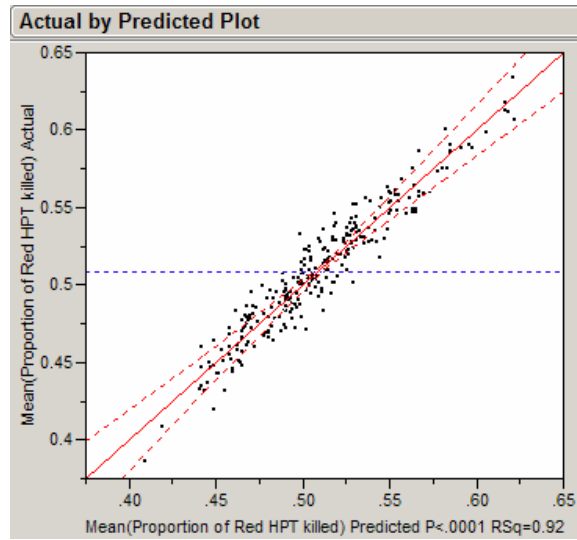

Figure 19. Regression Model (Proportion of HPTs Killed at 450 seconds)



<b>Single Factor</b>	<b>F-ratio</b>
# CL I	145.72
# CL II	25.70
# CL III	676.50
# Hellfire on Warrior	188.91
# APKWS on CL III	260.05
CL I and II Desire to Enemy	26.68
CL I and II Desire to next waypoint	82.61
<b>Interaction of Factors</b>	
# CL III and Hellfire on Warrior	43.77
# CL III and # APKWS on CL III	133.60
CL I and II Desire to Enemy and CL I and II Desire to next waypoint	46.43
<b>Quadratic</b>	
# CL I and # CL I	52.60
# APKWS on CLIII and # APKWS on CL III	37.93

Table 14. Significant Factors (Proportion of HPTs Killed at 450 seconds)

Table 14 (extracted from Appendix C) shows that the most significant factor, as measured by the MOE proportion of HPTs killed, is the number of CL III UAVs. Recall these are battalion level UAVs. The *F*-ratio for each UAV class identifies their significance in the early fight to prepare the battlefield for the infantry’s arrival. In addition, the interaction of battalion UAVs with APKWS weapons is also very valuable, as measured by the same MOE. A partition of factors shown in the regression tree (Figure 20) coupled with the parameter estimates outlined in the full model (found in Appendix C, “Early Fight,”) helps identify the number of the UAVs needed to facilitate the early destruction of Red HPTs. As found in the initial analysis of the robust DOE, we find that the tactical employment of the UAVs is extremely important. Tactical employment refers to the UAV operator’s decision to fly the UAV along the intended flight path verses loitering over detected targets. This is seen from both the single factors and the interaction of factors labeled in Table 14. Observe the significance of UAVs flying towards the enemy verses towards their intended flight route, and their interaction.

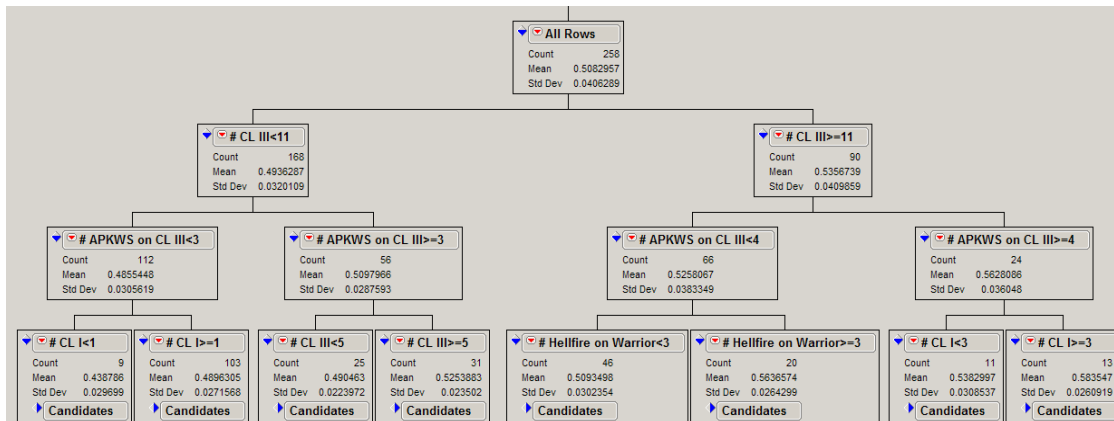

Figure 20. Regression Tree (Proportion of HPTs Killed at 450 seconds)

The Regression Tree compliments the fitted regression model by showing an increase in the purity of the model at the first split by identifying the number of battalion level UAVs. The proximity of the means upon the first split is closer than expected, but the means do clearly show the benefit of having more than 11 CL III UAVs during the early fight. The larger means on the right side of the regression tree identify this benefit. The second split, across both paths, shows that armed battalion level UAVs are significant. The proximity of the means among each split suggests that perhaps about three or four APKWS missiles will have the same increased affect on the battlefield. The third split identifies the significance of platoon level UAVs. Since the means are rather close, we can conclude that roughly three-platoon level UAVs among each team facilitate the CAB's mission. Recall from the scenario, that there are four tactical teams within the CAB. Team A, B, C, and D.

Performing the same analysis on this MOE at 900 seconds resulted in a stepwise fitted model with an adjusted  $R^2$  value at 0.82. This value is slightly lower than the regression model developed at 450 seconds, but still quite high, and a good fit. Figure 21 paints the predicted by actual plot of the model. Again, the observations fall quite symmetric about the line of fit. The residual plot is distributed without any distinct pattern, and reinforces the validity of this model. The histogram and the Q-Q plot suggest a normal distribution of the residuals.

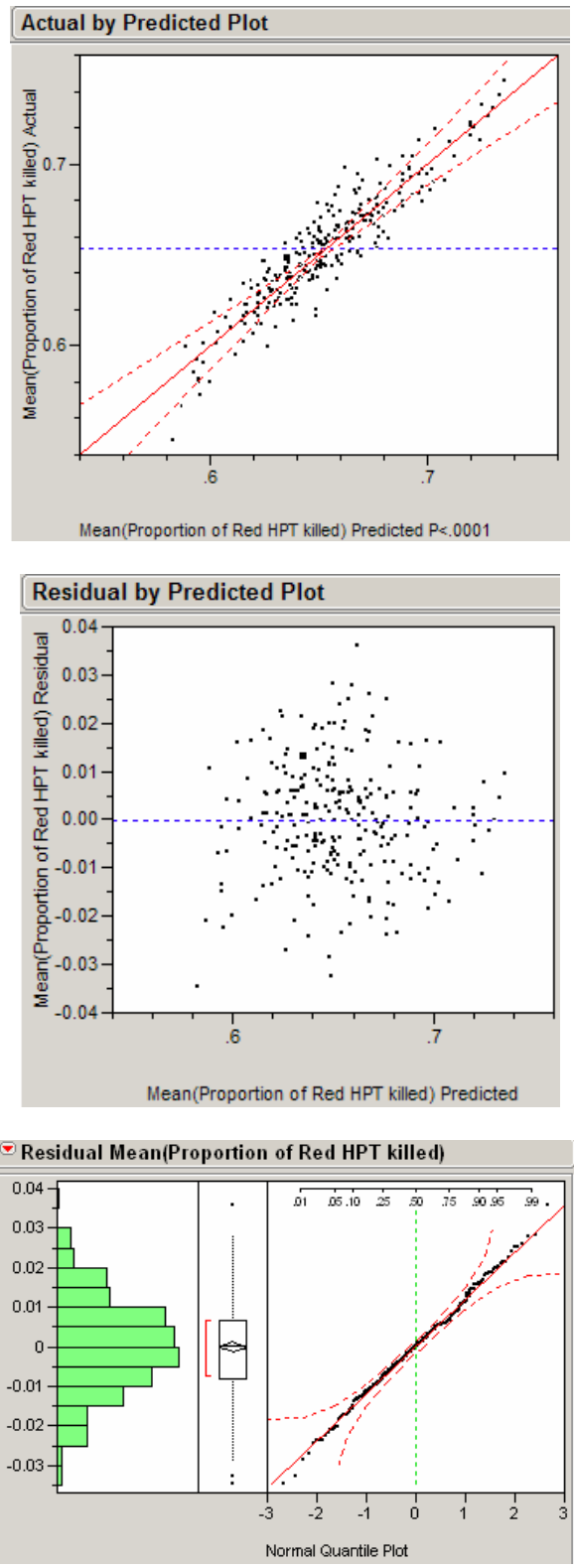

Figure 21. Regression Model (Proportion of HPTs Killed at 900 seconds)

Table 15 identifies the significant factors of the regression model with an *F*-ratio above 25.0. To observe the entire model, with the parameter and estimate effects, refer to Appendix C, section “Early Fight.” The importance of the extracted *F*-ratios portrayed in both Tables 14 and 15 lays in the similarity of significant factors. The battalion level UAV remains as the single most important factor as measured by the proportion of HPTs killed. Though not as significant, both company and platoon level UAVs are important. Noticeable again, precision munitions attached to battalion level UAVs are quite significant, as is the tactical employment of the UAVs. The interaction suggests the need for the UAVs to follow their flight plan as well as sometimes continuing in their scoping operations of detected enemy targets. Figure 22 again helps determine the quantifiable number of UAVs needed to assist the Blue Force in obtaining their mission to secure the urban area by depleting the Red HPTs.

<i>Single Factor</i>	<i>F-ratio</i>
# CL I	47.93
# CL II	54.41
# CL III	324.89
# Hellfire on Warrior	131.73
# APKWS on CL III	28.00
CL I and II Desire to next waypoint	54.89
<i>Interaction of Factors</i>	
CL I and II Desire to Enemy and CL I and II Desire to next waypoint	27.06

Table 15. Significant Factors (Proportion of HPTs Killed at 900 seconds)

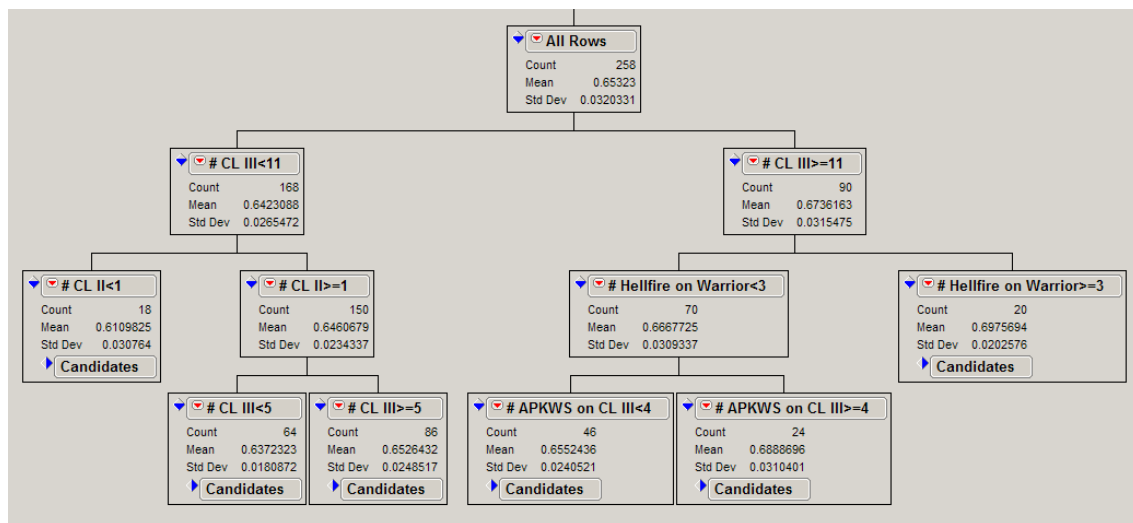

Figure 22. Regression Tree (Proportion of HPTs Killed at 900 seconds)

A consistency between Figures 20 and 22 shows that battalion level UAVs bring the most punch to the battlefield in order to maximize the proportion of Red HPTs killed. Though the means are relatively close, the right side of the regression tree does again yield higher means in the destruction of HPTs when deploying more than 11 CL III UAVs. The significance of having at least one platoon level UAV per team becomes apparent again. Since the means are relatively close among each split, the CAB may launch less than 11 CL III UAVs if deemed necessary after performing a cost benefit analysis (outside the scope of this thesis). The presence of CL III UAVs appearing twice in the regression tree suggests a non-linear fit, thus supporting the quadratic stepwise regression model performed and displayed in Appendix C.

Though the CL III UAV seems to deliver the greatest punch to the battle as measured by the regression trees and *F*-ratios, the military never depends on one asset alone. On both the 450 and 900-second regression trees, notice the absence of CL II UAVs. Table 14 possibly explains their absence by showing that even though the CL II UAVs are significant as determined by their *F*-ratio, they are not as significant to the model when applying this particular MOE. However, the parameter estimates for both regression models does support the significance of CL II UAV presence as outlined in Table 16 (extracted from Appendix C, section “The Early Fight.”)

Each estimate in Table 16 is positive, annotating a positive effect on increasing the number of HPTs killed. An increase of one UAV within each class in turn increases the proportion of HPTs killed by their respective estimates outlined in Table 16. For example, given an increase of one CL III UAV from 11 to 12, provides almost a 0.5% increase in the proportion of Red HPTs killed within the first 450 seconds.

450 Seconds		900 Seconds	
Parameter	Estimate	Parameter	Estimate
# CL I UAVs	0.0055	# CL I UAVs	0.0032
# CL II UAVs	0.0023	# CL II UAVs	0.0034
# CL III UAVs	0.0045	# CL III UAVs	0.0032

Table 16. UAV Estimates (Proportion of HPTs Killed at 450 and 900 seconds)

Thus far, mostly one MOE, proportion of Red HPTs killed, has provided insight to answering the thesis question. This next section performs the same analysis techniques already described, but by applying the MOE proportion of Blue Dismounts survived. This section, shortened for brevity, only examines the 900-second time-hack as the stochastic simulation predominantly maintains a later arrival of Dismounts to the close fight than that at the 450-second time-hack.

Figure 23, again portrays the regression fitted model with each observation falling along the line of fit. The  $R^2$  in this model is 0.61, and the adjusted  $R^2$  for this model is slightly lower, only 0.53. This adjusted  $R^2$  is not as high as seen in the past, but it is not laughable either. The model, significant factors, and parameter estimates provide continued insight into our questions as measured with the MOE, proportion of Blue Dismounts survived. Appendix C, “The Early Fight,” contains the entire model.

The regression tree in Figure 24 compliments this entire model, proposing that the CL I and II UAV traveling to the next waypoint is key to maintain a higher survival proportion of Blue Dismounts. This suggests that the UAV operators play a critical part in providing the eyes for the fight. Both the CL I, and CL II, UAV has excellent sensor capabilities, that when flown routinely provides battlefield signature patterns resulting in keeping Dismounts alive. The first split minimizing the impurity occurs with a factor level of 15. This means on a scale between zero and 20, that there is a stronger desire for the operators to fly the UAVs along the intended flight route. The delta between the means about each split continues to be minimal. The mean for both (# CL I UAV  $\geq 1$ ) and (# CL I UAV  $< 3$ ) is about 0.95, suggesting the significance in having between one and three platoon size UAVs per team. This observation supports the same number lower bound of CL I UAVs determined when applying the previous MOE. The remaining splits identify tactical measures when deploying the UAVs as having greater significance than other factors. These factors are not present within the tree when looking at the MOE proportion of Blue Dismounts survived.

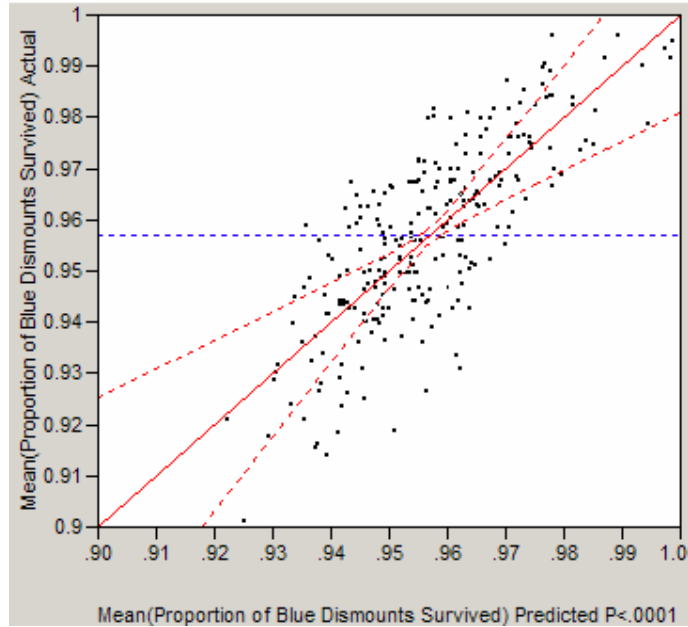

Figure 23. Regression Model (Proportion of Dismounts Survived at 900 seconds)

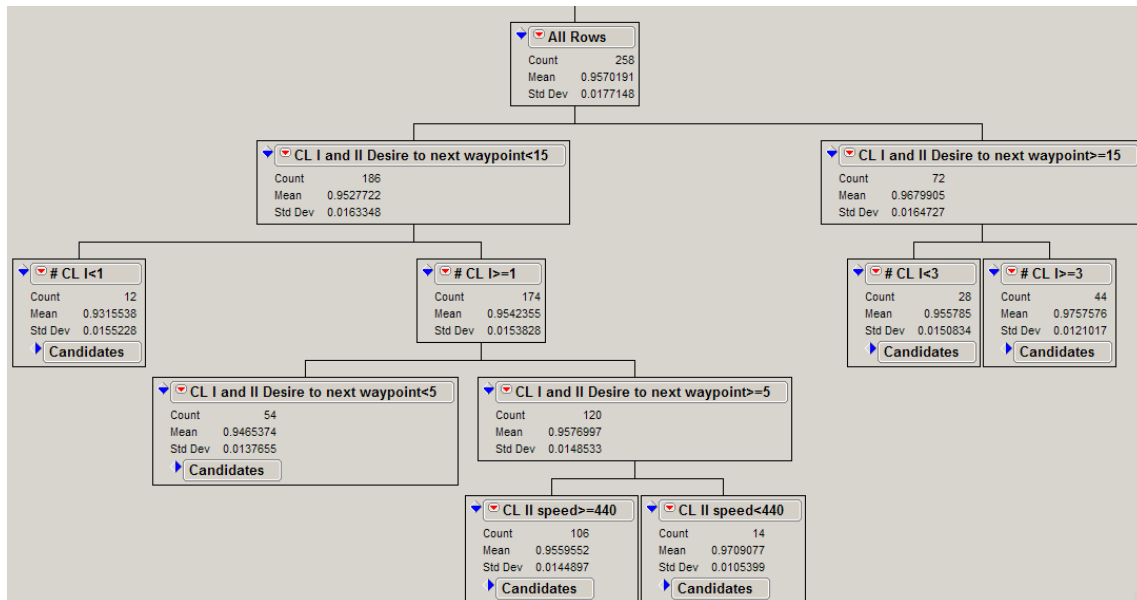

Figure 24. Regression Tree (Proportion of Dismounts Survived at 900 seconds)

The absence of the number of CL II and III UAVs within the tree in Figure 24 is possibly explained by the impact of killing a large quantity of HPTs within the first 450 seconds of the battle and prior to the arrival of the Dismounts. This observation again supports the importance of preparing the battlefield for the Infantry's

arrival. Thus, the CAB needs the CL III UAV for the deep fight and preparation of the battlefield by destroying the HPTs. Once the Dismounts arrive, the CL I UAV is more significant, as shown by Table 17, because it provides the local situational awareness (over the next hill) to these Dismounts.

In addition, Table 17 extracted from the full regression model in Appendix C, “The Early Fight,” has very few significant factors with *F*-ratios greater than 25.0. The author listed the examples outlined in Table 17 because of their interesting values. Supporting the corresponding regression tree, the most significant factor as measured by its *F*-ratio, is the tactical employment of the CL I and II UAVs towards their next waypoint. This supports the need of the smaller UAVs by the Dismounts to use them for local situational awareness, covering as much territory as possible. Completely opposite to this finding is the appearance in the small amount of significance of the CL I and II UAVs aggressive flight pattern circling detected enemy targets. This suggests that operators should fly both the CL I and II UAVs according to their flight pattern, even after detecting an enemy target. There is little need for loitering, or hovering over an established target with these UAV classes for the MOE proportion of Blue Dismounts survived.

<b>Single Factor</b>	<b>F-ratio</b>
# CL I	26.61
# CL II	5.73
# CL III	3.20
# Hellfire on Warrior	14.89
# APKWS on CL III	2.03
CL I and II Desire to Enemy	0.04
CL I and II Desire to next waypoint	92.97
<b>Interaction of Factors</b>	
# CL I and CL I and II Desire to next waypoint	22.28
# CL II and # APKWS on CL III	13.16
# CL III and # Hellfire on Warrior	24.68
# CL III and # APKWS on CL III	14.58
<b>Quadratic</b>	
# CL II and # CL II	9.11
# CL III and # CL III	4.98

Table 17. Significant Factors (Proportion of Dismounts Survived at 900 seconds)

The parameter estimates outlined in Table 18, extracted from the full model, identify the significance of adding one additional UAV per class at 900 seconds into the battle. Adding an additional platoon UAV to each team increases the proportion



of surviving Blue Dismounts by almost one percent. Comparing this observation with the interaction of factors outlined in Table 17, and the regression tree in Figure 24, suggests the significance of the scouting abilities of the platoon level UAV. This is even stronger as it continues along its flight pattern. Increasing the number of platoon UAVs from one to three may save the proportion of Infantry lives by two percent.

900 Seconds	
Parameter	Estimate
# CL I UAVs	0.9470
# CL II UAVs	0.0022
# CL III UAVs	-0.0010

Table 18. UAV Estimates (Proportion Dismounts Survived at 900 seconds)

The negative valued estimate corresponding to the number of battalion level UAVs suggests that an increase in CL III UAVs may not preserve additional lives once the battle reaches 900 seconds. This may call for a shift in prioritizing Blue Force assets. There is a continued trend showing that success in the opening stages of the battle paves the battlefield for the Infantry’s arrival. Once the battlefield is prepared, there is less necessity for this battalion level asset.

***b. How will armed battalion level UAVs enhance the FCS’s ability to secure the urban environment?***

Continued analysis, using two smaller models with four factors apiece helped establish the effect of armed UAVs as measured by the two established MOEs. Performing a stepwise regression and only selecting variables pertaining to CL III UAVs and types of missiles associated with each resulted in a model that easily identifies interactions among these specific variables. The actual versus predicted plot in Figure 25 portrays similar characteristics found in the larger model detailed in the previous section. The  $R^2$  is smaller (0.51) in this model as expected since eliminating the majority of the factors cannot add to the accuracy of the model.

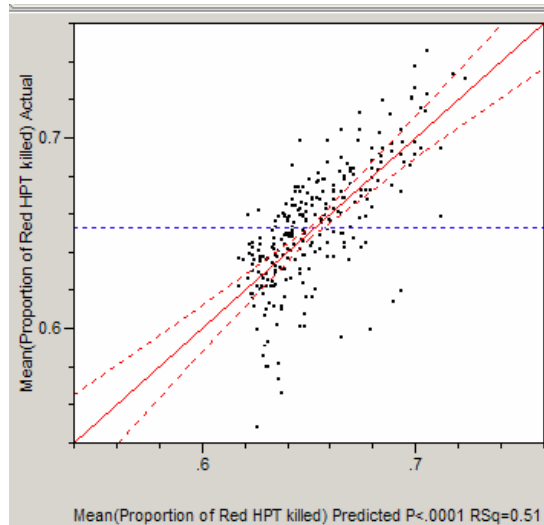

Figure 25. Regression Model (Interaction Measured by HPTs)

This process leads to a more important fact outlined in Figure 26, that the non-parallel lines clearly identifies significant interactions between the number of battalion level UAVs and armed battalion level UAVs. There are two added variables “mean UAV with Hellfire Missiles,” and the “mean proportion of payload.” These additional columns (variables) added to the raw data are a measuring device used to assist in Data Mining procedures. The bottom left cell of Figure 26 shows two lines labeled as “0” and “1.” The “0” represents unarmed UAVs, and the “1” identifies armed UAVs. Following the  $x$ -axis, from left to right, we observe that the mean proportion of HPTs killed ( $y$ -axis) climbs much higher with an increased number of armed UAVs over that of unarmed UAVs. The entirety of this smaller model appears in Appendix C, “Interactions,” and supports the observations portrayed by each of the Figures and Tables of the previous section.

*In an interaction plot, the  $y$ -axes are the response, and each small plot shows the effect of two factors on the response. One factor (associated with the column of the matrix of plots) is on the  $x$ -axis. This factor’s effect shows as the slope of the lines in the plot. The other factor becomes multiple prediction profiles (lines) as it varies from low to high. This factor shows its effect on the response as the vertical separation of the profile lines. If there is an interaction, then the slopes are different for the different profile lines.<sup>95</sup>*

<sup>95</sup> Sall, p. 421.

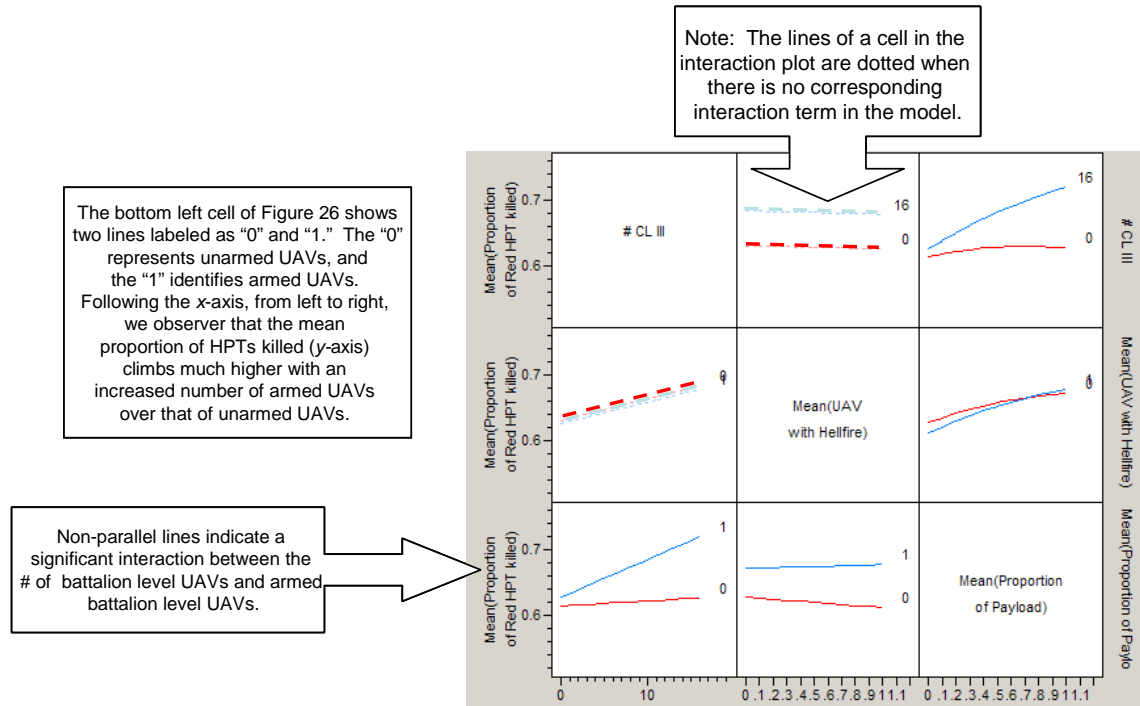

Figure 26. Interaction Plot of CL III UAVs Armed with Munitions

When studying the previous section’s Tables and Figures, notice the slightly decreased *F*-ratio as well as the decreased parameter estimates of the CL I and III UAVs when comparing the 450-second regression model to the 900-second regression model (Refer to Tables 14, 15, and 16). Observing the simulation model reminds the reader that this vignette does not model the entire battle, and that the vignette does not simulate a lead up to all the military units arriving at their attack position. Rather, the vignette opens with each asset already in its attack position. The scenario has a 2.6 by 2.6 square kilometer battlefield. Observing the scenario in the “play” mode reveals that each of the CL III armed UAVs, detect, classify, and almost immediately fire upon Red HPTs at the beginning of each run. Therefore, as the battle continues, the big punch depleting the enemy force up front, possibly leaves less need for the CL III UAVs at the end of the battle. The proportion of Red HPTs killed over time performs this measurement. The similarities among Tables 14 and 15 identify a significant effect in killing Red HPTs when deploying armed UAVs.

Recall that the analysis of surviving Blue Dismounts at 900 seconds into the battle revealed less need for CL III UAVs at that particular time of the battle (Table 17). However, the significant interactions among “Hellfire missiles on Warrior” and “CL III UAVs,” and that of “APKWS missiles on CL III UAVs” and “CL III UAVs” in the full model suggests that providing armed UAVs under the CAB’s control proves beneficial to the survival of Blue Dismounts. In addition, performing similar analysis, applying a standard least squares analysis reinforces the interaction of specific factors as outlined in Figure 27. The interactions identified within multiple cells of Figure 27 reveal that armed UAVs (denoted by “1”) help the mission. With respect to this MOE, armed UAVs increase the survival proportion of Blue Dismounts ( $y$ -axis) and unarmed UAVs lowers the number of Blue Dismounts surviving when reading each  $x$ -axis from left to right.

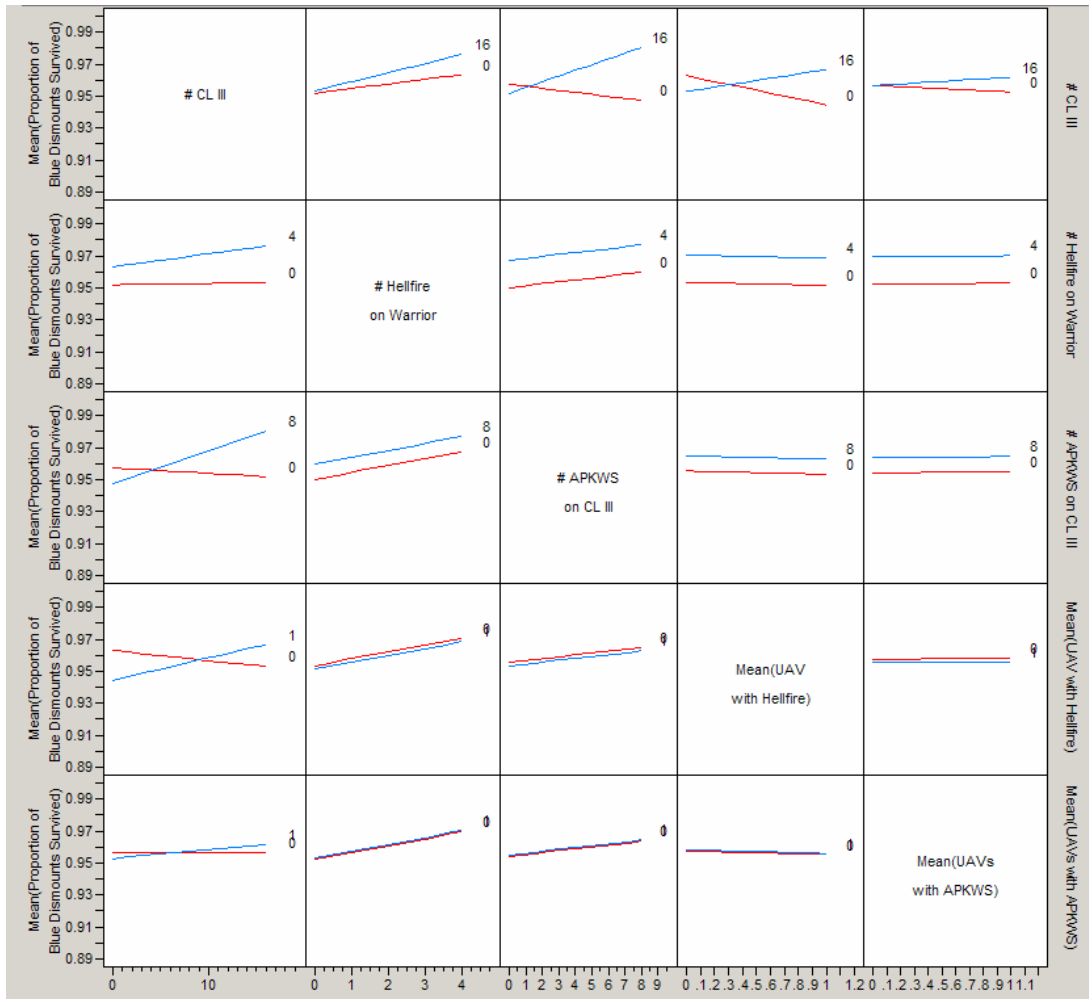

Figure 27. Additional Interaction Plot

- e. *Is it better to arm Warrior UAVs with Hellfire missiles at the CAB level, or to use APKWS 2.75 inch guided rockets with M151 HE warheads attached to the CL III UAVs?*

Noticeably, armed UAVs appear significant to mission accomplishment as measured by both MOEs. The question of which type of missile is better to use is not quite as clear. What appears evident is that both types of missiles do materialize as significant depending upon the application. The higher  $F$ -ratios in Table 14 identify the APKWS missiles more significant than Hellfire missiles as measured by the proportion of HPTs killed at 450 seconds. This holds true for all the single factors, interaction of these factors, and their quadratic effects as well. Therefore, the APKWS missiles tend to provide more benefit to the mission immediately upon the start of the battle. As the battle moves on, Hellfire missiles become more significant. This is explained possibly

because APKWS is better to use in denser urban locations in order to minimize unintentional destruction of nearby buildings. As the battle starts in this scenario, the APKWS missiles engage HPTs masked by urban buildings and obstacles at a rapid rate. As the battle continues, the HPTs are destroyed while the UAVs have fired their entire payload. With Hellfire missiles, the UAVs fired at a steadier rate and at targets possibly less hidden. Many of the same hidden HPTs in the urban environment were possibly destroyed by other FCS platforms later in the scenario. The Hellfire missiles possibly maintained their significance later in the battle due to their steady rate of fire toward the remaining HPTs.

The regression tree in Figure 22 identifies Hellfire missiles as having greater significance than that of the APKWS as measured by the proportion of HPTs killed later in the battle at 900 seconds. Table 17 again identifies Hellfire missiles and their interaction terms as having greater significance as measured by the proportion of Blue Dismounts survived at 900 seconds. Looking at each of the interaction plots for both MOEs, the proportion of payload is clearly significant for the battalion level UAVs. A closer look at the percentiles of the means in the interaction plots for each appears negligible when trying to determine a winner.

## **VI. CONCLUSIONS AND RECOMMENDATIONS FOR FUTURE STUDY**

*"PER ANGUSTA AD AUGUSTA"  
(Through Difficulties To Things Of Honor)  
218TH FIELD ARTILLERY REGIMENT*

This chapter contains a summary of conclusions and gained insight from the data analysis. Following the summary of conclusions and gained insight section of this chapter are some recommendations for future study.

### **A. SUMMARY OF CONCLUSIONS AND GAINED INSIGHT**

The summary of conclusions and gained insight has two sections: Data Analysis Conclusions and Modeling and DOE Methodology Findings. The division separates aspects of the entire research that may have varying weighted values depending on the reader.

#### **1. Data Analysis Conclusions**

The underlying questions of this research ask how many UAVs are needed, and how will armed UAVs affect mission performance? Initial observations portrayed three things:

- The enemy and terrain (two elements of METT-T) provide greater significance to the mission outcome than the number and capability of UAVs at any level.
- The tactical employment, and capabilities of each type of UAV, provides greater significance to the CAB's mission accomplishment than does the actual numbers of UAVs at each level.
- The joined platform capabilities within the FCS is so robust, that eliminating an entire platform category, such as all the UAVs from the battle space, has little effect on the CAB's ability to still maintain 95% of its Dismount population while destroying 90% of the enemy HPTs.

Identifying outliers and modifying the parameter levels within the DOE to reflect a very strong enemy steered the final analysis. This change to the parameter values portrayed an enemy situation greater than four times the strength of the original CASTFOREM Red Force order of battle.

Final analysis, employing a strong Red Force order of battle, and a dense urban terrain environment showed that:

- 11 or more battalion level UAVs provide the FCS's ability to act quickly and decisively by bringing the biggest punch against the enemy as measured by both the proportion of HPTs killed and the proportion of Blue Dismounts Survived.
- The model portrays the CAB's increased lethality against the HPTs, while minimizing Blue Dismount deaths when adding precision munitions to CAB UAV assets.
- The CAB needs the CL III UAV for the deep fight and preparation of the battlefield by destroying the HPTs.
- Once the battlefield is prepared and the Dismounts arrive, then the CL I UAVs are more significant because they provide the local situational awareness (over the next hill) to these Dismounts.
- The APKWS missiles tend to provide more benefit to the mission immediately upon the start of the battle.
- As the battle moves on, Hellfire missiles become more significant as measured by the proportion of HPTs killed at 900 seconds.
- Hellfire missiles also seem to provide more application as measured by the proportion of Blue Dismounts survived at 900 seconds. However, at 900 seconds there is already a large loss to the Red Force.
- Each tactical team benefits when deployed with between one and three platoon level UAVs. The benefit of adding one platoon level UAV per team



increases the overall CAB survival proportion of Blue Dismounts by almost one percent.

- Need at least one CL II UAV per tactical team. The exact number of CL II UAVs is still unknown from this thesis.
- Lower class UAVs provide the eyes “over the next hill” for Dismounts. Operators need to balance the tactical flight pattern in order to cover as much ground as possible while minimally loitering over detected targets.

The quantitative values identifying the number of UAVs needed are for those currently flying within a critical 2-hour window. A logistician still needs to determine how many UAVs are needed in reserve due to maintenance schedules and recovery assets.

The thesis and analysis determined an abundance of outcomes. The data analysis responds quantifiably to the questions posed within this research. These answers afford UAV insight to the operational analysis and the military community. However, this section would be incomplete if the research failed to mention the insight drawn from both the modeling and DOE methodologies. The ABS community benefits from the advance techniques outlined within each of these methodologies.

## **2. Modeling and DOE Methodology Findings**

Paramount to all modeling conclusions is the need to catalog ABM vignettes and detailed methodologies outlining the parameter values used within each scenario. At the October 2005 Military Operations Research Society (MORS) Workshop, *Agent-Based Models and Other Analytic Tools in Support of Stability Operations*, the author established the importance of such cataloging. Models, including MANA, are not widely accepted beyond the research community. This is possibly because decision makers are not aware of the vast scenarios already built by such models. An easily assessable library consisting of MANA scenarios and parameter methodologies may assist in fostering this needed acceptance.

Spreadsheet modeling offers a perfect way to capture modeling methodologies. Spreadsheet modeling provides quick set up, flexibility, and an effortlessness cataloging capability of each scaled parameter. The scaling is important since the operator defines

each MANA battlefield parameter. Again, cataloging efforts yield decision makers with a history of scenarios, while offering analysts references to adopt similar aspects into their own models. This also fosters the ability to build ABM vignettes in even a quicker amount of time, without losing accuracy.

Accuracy and resolution are two different entities. The MANA run time can become extremely slow if the operator defines the model with too much resolution. An example of this is providing agents with sensor and weapon capabilities across the entire terrain map. This modeling approach may not be of best interest to the modeler even if the real life scaling permits it. The 2.6 by 2.6 square kilometer battle space of this scenario is small enough for certain platforms to potentially range the entire playing field. However, maximizing their sensor and weapon ranges slows the model run time almost to a halt. The modeler should consider the terrain and environment prior to setting an agent's maximum range. In this scenario, certain line of sight platforms can sense and engage targets past 2.6 kilometers in a desert. However, the mountains and MOUT terrain of this scenario precludes most line of sight weapons to at most 500 meters or less. Shortening the maximum weapon engagement range to only 500 meters (96 pixels) decreased the run time to a desired speed for analysis purposes without losing accuracy.

The author found the Tiller application as an excellent tool to build a DOE with minimal factors. The large number of factors combined with their correlated and lockstep association to each multiple MANA squads having the same characteristics called for additional programming using object-oriented programming. The author recommends that the Project Albert staff adds the programming code used in this thesis to the Tiller application. Professor Paul Sanchez, Naval Postgraduate School, is the author, and point of contact for this code. This code will facilitate the Tiller application of larger experimental designs.

While the author believes this as a beneficial exploration, discoveries must remain within the context of its domain, agent-based simulation. Generally, ABS is an exploratory tool yielding analysis based from low-resolution model output. The author maintains that the modeled scenario is free of major flaws and modeling errors.

However, the conclusions drawn are from *only* one modeled vignette, and research addressing additional vignettes will assist in the final development of the entire FCS.

## **B. RECOMMENDATIONS FOR FUTURE STUDY**

As the research unfolded, a multitude of tangential and parallel topics came into light for future study. One particular area of study is to compare and contrast the data analysis output from this thesis to conclusions drawn from the original CASTFOREM vignette at TRAC-WSMR. Though the CASTFOREM vignette did not model armed UAVs, the 20 factors chosen within the DOE provide a multitude of data and analysis output outlined by each of the full regression models in Appendix C and Chapter V. A comparison of each simulation model about identical vignettes may bridge the process of validating and verifying agent-based simulations (ABS) for future DOD use in planning and analysis operational phases. In addition, future study of the same vignette modeled in other agent-based models could provide insight to the ABS community as a whole.

This analysis drew from a CAB(-) asset. Due to limiting the number of agents within the scenario, the author omitted the modeling of all Unmanned Ground Vehicles (UGVs), certain command and control platforms, and all logistic platforms. The FCS is very robotic in nature, and further study on each of the robotic platforms may provide additional insight prior to fielding. Possibly the simplest of any follow-on study, may be to perform an analysis of UGVs in lieu of UAVs by changing the parameters and capabilities of all UAV modeled agents to represent that of UGVs in the MANA model.

Additionally, the existing modeled CAB(-) may be lifted out of this scenario and placed in a completely new vignette representing a different tactical environment to see if the same CAB is capable of performing a wide array of tactical missions. The procedure is simple to perform by obtaining a digital version of the XML code from the author, or by following the spreadsheet modeling techniques in Appendix A outlining all modeled parameters. Slight changes may be necessary if the vignette scaling is different or to change routes of march.

Concluded is the necessity to prepare the battlefield for the Infantry's arrival. This begs the question of what tactical deployment procedures and assets can better

prepare the MOUT battle space for the arrival of dismounts, such that their survival is closer to 100 percent. Also concluded, is the benefit of battalion level CL III UAVs (or Warrior UAVs under battalion control) carrying and deploying precision munitions. The idea of armed UAVs changes the weight and payload balance requirements of each UAV. An additional analysis of the balance between munitions, sensors, and fuel can establish future building requirement of the FCS UAVs.

Similarly, there was a 5% loss of Blue Dismounts occurring at the end of a 2-hour fight with a more random enemy, as posed by the robust DOE. There was the same 5% loss within the first 15 minutes of a fight when posed against a stronger enemy. This raises the author's eyebrow and suggests that military leaders should devise a system minimizing casualties within the initial stages of a fight when up against a strong enemy situation.

Though at least one CL II UAVs per team is deemed significant in the conclusions, there is an absence regarding the overall estimate of the number of company level UAVs needed within a CAB. A nonlinear optimization model, using the parameter estimates and the regression models in Appendix C may provide additional insight and identify this exact number of company level UAVs. This nonlinear optimization problem will also confirm the number of platoon and battalion level UAVs determined in this thesis.

This research concluded that between one and three CL I, at least one CL II, and 11 CL III UAVs improve mission performance in this scenario. A cost-benefit-estimation analysis on the regression models in Appendix C would help to identify the trade-offs between applying different combinations of UAVs and other FCS platforms within this and other operational settings.

## **APPENDIX A. MANA SPREADSHEET MODELING**

The appendix provides the reader with the modeling methodology details used to facilitate the model development process implemented within this simulation technique. Each part of this appendix shows a snapshot of modeling spreadsheets built with Excel. Spreadsheet modeling describes the approach implemented to transform real world data into scaled MANA parameters. The spreadsheet modeling also offers a cataloging approach to capture everything needed to replicate the scenario, or to adopt future scenarios as well with minimal changes to the scaling process.

# A. SCALING: CONFIGURE BATTLEFIELD SETTINGS

### CONFIGURE BATTLEFIELD SETTINGS

**MAP SCALE**

	X	Y	JUSTIFICATION
Number of Cells:	500	500	square of
Real World Range Min:	7070	4545	2600 meters
Real World Range Max:	7330	4805	2600 meters

Max 2600

Manage New Contact By: **Agent Location** (Speedier - fog of war)

When Agent is Shot Remove Corresponding Map Contacts By: **Underlying Contact ID** (Speedier - fog of war)

Contact Aggregation Radius: **1.00** (grids) prevents unnecessary clutter of id locations  
**2** meters

LOS Mode: **Advanced**

Real World Elevation Range: Min = **0** Max = **255**

Terrain Effect Range: **1** (grids) affects speed of model - higher = slower  
**5** meters

**Edit Terrain Properties**

	Going	Cover	Conceal	Red	Green	Blue
BilliardTable	1.00	0.00	0.00	0	0	0
Wall	0.00	1.00	1.00	192	192	192
Hilltop	0.90	0.00	0.00	64	64	64
Road	0.90	0.00	0.00	255	255	0
LightBush	0.60	0.10	0.30	10	250	10
DenseBush	0.20	0.30	0.90	40	180	40
Water	0.10	0.00	0.00	51	102	204
City	0.50	0.60	0.60	255	200	0
Inside Building	0.90	0.90	0.90	250	250	100

New Edit Delete Close

### ALGORITHM TAB - SAME FOR ALL UNITS

Move Selection: **Stephen Algorithm**

Best Move: **Precision**

Move Precision: **200**

General Movement Settings:

- Multiple Agents in Cell
- Diagonal Motion Correction
- Navigate Obstacles
- Squad Moves Together
- Going affects speed and Terrain affects LOS

### Calculations

Hours In Scenario	Minutes In Scenario	Seconds In Scenario	Steps in Scenario	steps/min
2	120	7200	7,200	60

1 second per 1 step

m on X axis of Terrain Map: 2600  
 m on Y axis of Terrain: 2600  
 Total m<sup>2</sup> in Map: 6760000

meters per grid square: 5.2  
 Grid Squares on X axis: 500  
 Grid Squares on Y axis: 500  
 Total Grid Squares in: 250000

2.8846154

general speed conversion

sec	1	steps	1	grids	500	km	2.6
inf	mech	16	60	80	140	cas	300
						helo	140

Can't model CAS at 1000, so assume stationary  
 Assume Helo travels only at 60 knots for model

General speed conversions

	1.6 km	1 hour	1 min	1 sec	500 grids	=	conversion	mana input / 100
Dismounts	1.6 km	1 hour	1 min	1 sec	500 grids	=	0.08547 grids	9
Ground Vehicles	16 km	1 hour	1 min	1 sec	500 grids	=	0.854701 grids	85
	16 km	1 hour	1 min	1 sec	500 grids	=	1 step	
UAV CL I	60 km	1 hour	1 min	1 sec	500 grids	=	3.205128 grids	321
	60 km	1 hour	1 min	1 sec	500 grids	=	1 step	
UAV CL II and Helo	80 km	1 hour	1 min	1 sec	500 grids	=	4.273504 grids	427
	80 km	1 hour	1 min	1 sec	500 grids	=	1 step	
UAV CL III	140 km	1 hour	1 min	1 sec	500 grids	=	7.478632 grids	748
	140 km	1 hour	1 min	1 sec	500 grids	=	1 step	
CAS	300 km	1 hour	1 min	1 sec	500 grids	=	16.02564 grids	1000
	300 km	1 hour	1 min	1 sec	500 grids	=	1 step	

## B. MODEL UNIT SUMMARY

PLAYERS			WEAPON 1 (Subclass of Weapon 1)				WEAPON 2				AGGREGATION				
Unit #	UNIT TYPE / Squad	Squad Threat Level	Squad Classifications		Weapon 1 Target Classifications		Weapon 2 Target Classifications		Aggregation: 1 icon (agent) to X real agents						
			Priority Target Class for Weapon 1	Min Threat Level	Max Threat Level	Priority Target Class for Weapon 2	Min Threat Level	Max Threat Level	Priority Target Class for Weapon 2	Min Threat Level	Max Threat Level				
1 - 1	Red BMP-3	200	130	160	100	800	100	800	100	800	1 to 2				
2 - 2	Red 82 Mortars	100	100	all but 100	30	800	100	800	13016017014	3	800	1 to 2			
3 - 3	Red SA-16 Infantryman	200	200	all but 200	900	900	200	900				1 to 1			
4 - 4	Red RPG-7	3	160	100	100	800	100	800				1 to 2			
5 - 5	Red AT-7	3	160	100	100	800	100	800				1 to 1			
6 - 6	Red Scout	1	100	140	120	160	130	3	99			1 to 1			
7 - 7	Red RPK74	1	100	140	120	160	130	3	99			1 to 1			
8 - 8	Red AK-M Infantryman	1	100	140	120	160	130	3	99			1 to 1			
9 - 9	Red SVD	1	100	140	120	160	130	3	99			1 to 1			
10 - 10	Red APC	2	100	140	120	160	130	3	99			1 to 1			
11 - 11	Red T72	3	160	130	100	800	100	800				1 to 2			
12 - 12	Blue NLOS Motor Sec	1	1	2	3	30	800	2	3	1	30	800	1 to 2		
13 - 13	Blue NLOS Cannon Plt	1	1	2	3	30	800	3	2	1	30	800	1 to 3		
14 - 14	Blue NLOS LF Plt	1	1	2	3	30	800	3	2	1	30	800	1 to 3		
15 - 15	Blue ICY Platoon	1	2	1	2	3	30	800	3	2	1	30	800	1 to 6	
16 - 16	Blue MCS Platoon	1	6	6	160	200	Guided xm36 120mm	3	100				1 to 5		
17 - 17	Blue ARV-A	1	6	6	130	100	MK44 30 mm	1	2	3	3	200	1 to 3		
18 - 18	Blue ARV-AL	1	6	6	130	100	Guided xm36 120mm	1	2	3	3	200	1 to 3		
19 - 19	Blue ARV-ASTA	1	6	6	130	100	MK44 30 mm	2	1				1 to 1		
20 - 20	Blue UAV CL1	4	3	12	200	900	xm307 25 mm	1	2				1 to 1		
21 - 21	Blue UAV CL2	4	3	12	200	900	xm307 25 mm	1	2				1 to 1		
22 - 22	Blue UAV CL3	1	12	12	200	900	Guided Hellfire	3	2	1	100	800	1 to 1		
23 - 23	Blue RASV	1	3	3	150	100	xm307 25 mm	1	2				1 to 1		
24 - 24	Blue RASV	1	3	3	150	100	xm307 25 mm	1	2				1 to 3		
25 - 25	Blue Infantryman	1	54	54	100	3	m16	1	3				1 to 3		
26 - 26	Blue Machine Gunner M2-42	1	10	10	100	3	m240B 7.62mm	1	2	3	3	800	1 to 1		
27 - 27	Blue CAS	1	1	1	210	900	m230 / 30 mm	3	2	1	100	800	1 to 48		
28 - 28	Blue Apache	1	2	2	210	900	m230 / 30 mm	3	2	1	100	800	1 to 3		
totals		33	262	280											

notes: Aggregation is dependent upon platoon sizes.  
 IE: 1 icon of a NLOS Motor Section represents 2 real world Motor Tubes  
 Weapon 3 is a subclass of Weapon 1. Weapon 3 represents a different type of projectile fired from the same tube of weapon 1.

# C. MOVEMENT RATES

## MOVEMENT CALCULATOR FOR ALL GROUND VEHICLES

Base Movement Rate (kmph) **16** 16000 (meters per hour) 2.75  
 Relative movement to tactic speed

tacticle	100% increase	200% increase	max
100%	200%	400%	550%

**Armored/Mechanized Movement Rates: Ideal Terrain (meters per min)**

	Adjustment Factor	tacticle	100% increase	200% increase	max
Unencumbered	1.00	267	533	1,067	1,467
Light Combat Load	0.98	261	523	1,045	1,437
Full Combat Load	0.89	237	475	949	1,305
Heavy Load	0.78	208	416	832	1,144

**Armored/Mechanized Movement Rates: Ideal Terrain (feet per min)**

	Adjustment Factor	tacticle	100% increase	200% increase	max
Unencumbered		875	1,749	3,499	4,811
Light Combat Load		857	1,714	3,429	4,714
Full Combat Load		778	1,557	3,114	4,281
Heavy Load		682	1,364	2,729	3,752

**Armored/Mechanized Movement Rates: Ideal Terrain (meters per sec)**

		tacticle	100% increase	200% increase	max
Unencumbered		4.4	8.9	17.8	24.4
Light Combat Load		4.4	8.7	17.4	24.0
Full Combat Load		4.0	7.9	15.8	21.8
Heavy Load		3.5	6.9	13.9	19.1

**Armored/Mechanized Movement Rates: Ideal Terrain (feet per sec)**

		tacticle	100% increase	200% increase	max
Unencumbered		14.6	29.2	58.3	80.2
Light Combat Load		14.3	28.6	57.1	78.6
Full Combat Load		13.0	25.9	51.9	71.4
Heavy Load		11.4	22.7	45.5	62.5

**Armored/Mechanized Infantry Movement Rates: Ideal Terrain (grids per step)**

		tacticle	100% increase	200% increase	max
Unencumbered		0.9	1.7	3.4	4.7
Light Combat Load		0.8	1.7	3.4	4.6
Full Combat Load		0.8	1.5	3.0	4.2
Heavy Load		0.7	1.3	2.7	3.7

**Adapted From FM90-31 - Ch4**  
**Table IV-5. Unopposed Movement Rates**

TYPE TERRAIN	DISMOUNTED INFANTRY	ARMORED/MECHANIZED
Unrestricted	4 kmph (Day) 3.2 kmph (Night)	24 kmph (Day) 24 kmph (Night with lights/passive)
Restricted	2.4 kmph (Day) 1.6 kmph (Night)	16 kmph (Day) 8 kmph (Night, blacked out)
Severely Restricted	1.0 kmph (Day) 0.1 to 0.5 kmph (Night)	1.0 kmph (Day) 0.1 to 0.5 kmph (Night)

Adjusted Speed = Target Zone (average rate) **1.20**  
 3.28 feet = 1 meter

Notes: Picked Restricted movement rates due to traveling through urban area  
 Scenario occurs at day in combat, and mounted vehicles have sensor devices that allow traveling at optimal speeds

Ground Vehicle Different State Value Settings	% of Adjusted Movement Speed	MANA Input Speed
Default movement Rate	100%	1.20 <b>120</b>
Reach Waypoint	10%	0.12 <b>12</b>
Taken Shot (for primary or secondary)	0%	- <b>0</b>
(judgement call based on platforms)	50%	0.60 <b>60</b>
ability to fire at 0, 50%, 60% or full speed)	60%	0.72 <b>72</b>
	100%	1.20 <b>120</b>
Shot At	150%	1.80 <b>180</b>
Run Start (if applied)	0%	- <b>0</b>
Reach Final Waypoint	1%	0.01 <b>1</b>

ROUND(DXX\*10,1)\*10

## MOVEMENT CALCULATOR FOR DISMOUNTS

Base Movement Rate (kmph) **1.6** 1600 (meters per hour) 8.8  
 rounded Relative movement to walking speed

Walk	Jog	Run	Sprint
100%	200%	400%	550%

**Dismounted Infantry Movement Rates: Ideal Terrain (meters per min)**

	Adjustment Factor	Walk	Jog	Run	Sprint
Unencumbered	1.00	27	53	107	147
Light Combat Load	0.90	24	48	96	132
Full Combat Load	0.50	13	27	53	73
Heavy Load	0.30	8	16	32	44

**Dismounted Infantry Movement Rates: Ideal Terrain (feet per min)**

	Adjustment Factor	Walk	Jog	Run	Sprint
Unencumbered		87	175	350	481
Light Combat Load		79	157	315	433
Full Combat Load		44	87	175	241
Heavy Load		26	52	105	144

**Dismounted Infantry Movement Rates: Ideal Terrain (meters per sec)**

		Walk	Jog	Run	Sprint
Unencumbered		0.4	0.9	1.8	2.4
Light Combat Load		0.4	0.8	1.6	2.2
Full Combat Load		0.2	0.4	0.9	1.2
Heavy Load		0.1	0.3	0.5	0.7

**Dismounted Infantry Movement Rates: Ideal Terrain (feet per sec)**

		Walk	Jog	Run	Sprint
Unencumbered		1.5	2.9	5.8	8.0
Light Combat Load		1.3	2.6	5.2	7.2
Full Combat Load		0.7	1.5	2.9	4.0
Heavy Load		0.4	0.9	1.7	2.4

**Model Dismounted Infantry Movement Rates: Ideal Terrain (grids per step)**

		Walk	Jog	Run	Sprint
Unencumbered		0.1	0.2	0.3	0.5
Light Combat Load		0.1	0.2	0.3	0.4
Full Combat Load		0.0	0.1	0.2	0.2
Heavy Load		0.0	0.1	0.1	0.1

**Adapted From FM90-31 - Ch4**  
**Table IV-5. Unopposed Movement Rates**

TYPE TERRAIN	DISMOUNTED INFANTRY	ARMORED/MECHANIZED
Unrestricted	4 kmph (Day) 3.2 kmph (Night)	24 kmph (Day) 24 kmph (Night with lights/passive)
Restricted	2.4 kmph (Day) 1.6 kmph (Night)	16 kmph (Day) 8 kmph (Night, blacked out)
Severely Restricted	1.0 kmph (Day) 0.1 to 0.5 kmph (Night)	1.0 kmph (Day) 0.1 to 0.5 kmph (Night)

Adjusted Speed = Target Zone (average rate) **0.09** ← AVERAGE(C22:D23)  
 3.28 feet = 1 meter

Notes: Picked Restricted movement rates due to traveling through urban area  
 Scenario occurs at day in combat, but assuming night speeds because of enemy hide positions, and traveling in dark city allies

Dismounted Different State Value Settings	% of Adjusted Movement Speed	MANA Input Speed
Default movement Rate Red	100%	0.09 <b>9</b>
Default movement Rate Blue	0%	- <b>0</b>
Reach Final Waypoint	100%	0.09 <b>9</b>
Taken Shot Red	60%	0.05 <b>5</b>
Taken Shot Blue	0%	- <b>0</b>
Refueled by Anyone	100%	0.09 <b>9</b>

ROUND(DXX\*10,1)\*10



# D. SENSE AND DETECT

## UAV Platforms

Intent: Replicate the Likelihood of Detection graph from TM 3-22-5-SW for each UAV classes I, II, and III  
 Integration of Unmanned Vehicles into Maritime Missions  
 TM 3-22-5-SW  
 Department of the Navy, Office of the Chief of Naval Operations  
 p 2-4

1 foot = 0.3048 meters

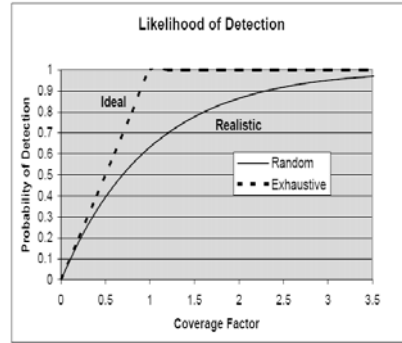

Predetermined Table Values Converting Real World Metrics to MANA Units

	Meters		Meters				Grid	Classify (MANA INPUT)				
		Grid										
UAV CL I flying at 500 ft	106.7	21	13.34	26.68	53.35	106.7	3	5	10	21		
350 ft foot print with a 30 degree field of view flying at 500 ft			P(det)	0.2	0.5	0.8	1	P(det)	0.2	0.5	0.8	1.0
			Meters	24.77	49.54	99.09	198.2	Grid	5	10	19	38
UAV CL II flying at 1000 ft	198.2	38										
650 ft foot print with a 30 degree field of view flying at 1000 feet			P(det)	0.2	0.5	0.8	1	P(det)	0.2	0.5	0.8	1.0
			Meters	95.27	190.5	381.1	762.2	Grid	18	37	73	147
CL III flying at 2500 ft	762.2	147										
2500 ft foot print with a 45 degree field of view flying at 2500 ft			P(det)	0.2	0.5	0.8	1	P(det)	0.2	0.5	0.8	1.0

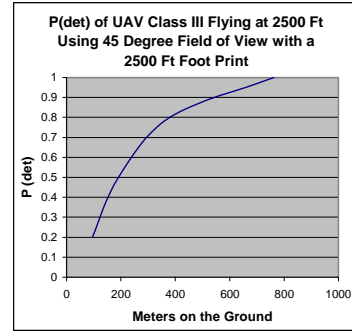
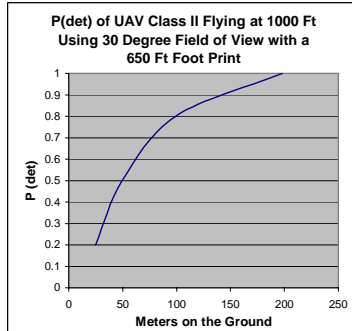
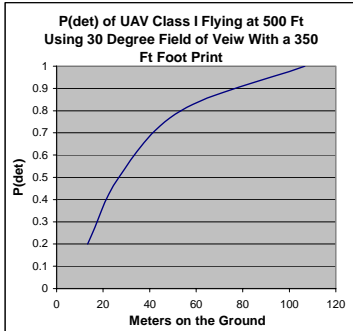

**Ground and Other Air (non UAV) Platforms**

Range	Numerical Value	Meters Grids											
Short	= 1	150	29	Meters	100	125	150	Grid	19	24	29		
		P(det)	0.9	0.8	0.7	P(det)	0.9	0.8	0.7				
Medium	= 2	250	48	Meters	150	200	250	Grid	29	38	48		
		P(det)	0.9	0.8	0.7	P(det)	0.9	0.8	0.7				
Long	= 3	500	96	Meters	300	400	500	Grid	58	77	96		
		P(det)	0.9	0.8	0.7	P(det)	0.9	0.8	0.7				
Short-Medium	1<x<2	200	38	Meters	150	175	200	Grid	29	34	38		
		P(det)	0.9	0.8	0.7	P(det)	0.9	0.8	0.7				
Medium-Long	2<x<3	350	67	Meters	250	300	350	Grid	48	58	67		
		P(det)	0.9	0.8	0.7	P(det)	0.9	0.8	0.7				
Extra Long	<3	1300	250	Meters	700	900	1100	1300	Grid	135	173	212	250
		P(det)	0.9	0.8	0.7	0.6	P(det)	0.9	0.8	0.7	0.6		

	Sensor type based off of C4ISR																	Adjusted Average Value Per Squad	
	short	medium	long	multi function ka band radar	AITR	acoustic	emitter mapping	remote	EO	IR	TD	CM	RADAR Warning	Plum Dect	Standoff Chem Det	SIGNINT	Combat ID		mast sensor
Red BMP-3		1											1						2.06667
Red 82 Mortors	1																		1
Red SA-16 Infantryman	1																		1
Red RPG-7		1																	2
Red AT-7		1																	2
Red Scout			1						1										3.06667
Red RPK-74		1																	2
Red AK-M Infantryman	1																		1
Red SVD		1																	2
Red APC	1									1			1						1.13333
Red T72		1							1				1						2.13333
Blue NLOS Mortor Sec	1			1	1														1.13333
Blue NLOS Cannon Pit	1			1	1														1.13333
Blue NLOS LS Pit	1																		1
Blue ICV Platoon		1		1	1														2.13333
Blue MCS Platoon		1		1	1														2.13333
Blue ARV-A		1		1	1	1													2.2
Blue ARV-A(L)		1		1	1	1													2.13333
Blue ARV-RSTA		1		1	1	1	1												2.33333
Blue UAV CL 1			1						1	1	1								3.2
Blue UAV CL 2			1						1	1	1								3.2
Blue UAV CL 3			1		1				1	1		1	1	1	1	1	1		3.6
Blue R&SV			1	1	1				1	1									3.33333
Blue Infantryman	1							1	1									1	1
Blue MachineGunner M240b	1																		1
Blue CAS			1	1						1									3.13333
Blue Apache			1	1						1									3.13333
column	1	2	3	4	5	6	7	8	9	10	11	12	13	14	15	16	17	18	





ID	Name of Agent	Description	State	Summary	Time in state	Enemies	Combat	Enemy Threat 1	Enemy Threat 2	Enemy Threat 3	Other Friends	Neutral	Unknowns	Friends	Neutral	Unknowns	Advantage	Location	Threat	Agent Class	Movement Speed	No Hits to Kill	Shield	Amount Thickness	Weapon Radius	Sensor Class Range	Sensor Detect Range	Flare Usage Rate	Reheat Trigger Range	Prob Reheat Friend	Prob Reheat Enemy	Prob Reheat Neutral
12-12	Blue NLOS Major Sec	HO - Major (P/R) HP - D	1. Default State	Start state and Default fallback state	0															140	12	120	75	1	0	0	0					
			2. Reach Waypoint	Agent state when any waypoint is reached	100																	140	12	120	75	1	0	0	0	0	0	
13-13	Blue NLOS Cannon Pri		1. Default State	Start state and Default fallback state	0															170	0	100	100	1	0	0	0	0	0	0		
			3. Taken Shot (Pri)	Agent state when agent has fired its primary weapon at an enemy (may not have hit target)	15																	170	0	100	100	1	0	0	0	0	0	0
14-14	Blue NLOS LS Pri		1. Default State	Start state and Default fallback state	0															170	0	100	100	1	0	0	0	0	0	0		
			3. Taken Shot (Pri)	Agent state when agent has fired its primary weapon at an enemy (may not have hit target)	60																	170	0	100	100	1	0	0	0	0	0	0
15-15	Blue MCV Platoon		1. Default State	Start state and Default fallback state	0															200	0	120	20	24	1	0	0	0	0	0		
			3. Taken Shot (Pri)	Agent state when agent has fired its primary weapon at an enemy (may not have hit target)	200																	200	0	120	20	24	1	0	0	0	0	0
16-16	Blue MCV Platoon		1. Default State	Start state and Default fallback state	0															100	0	120	30	30	1	0	0	0	0	0		
			3. Taken Shot (Pri)	Agent state when agent has fired its primary weapon at an enemy (may not have hit target)	100																	100	0	120	30	30	1	0	0	0	0	0
17-17	Blue ATV-A		1. Default State	Start state and Default fallback state	0															130	0	120	30	30	1	0	0	0	0	0		
			3. Taken Shot (Pri)	Agent state when agent has fired its primary weapon at an enemy (may not have hit target)	130																	130	0	120	30	30	1	0	0	0	0	0

Case ID	Entity	State	Start State and Default fallback state	Transitions	Values	Other
18-18	Blue ARV-A(L)	1 Default State	Start state and Default fallback state Agent state when agent has fired its primary weapon at an enemy (may not have hit target) Agent state when agent has fired its secondary weapon at an enemy (may not have hit target) Agent state when shot at by an enemy's primary weapon (may not have been hit) Agent state when shot at by an enemy's secondary weapon (may not have been hit) Agent state when injured (shot at and hit) Agent state when final waypoint is reached Squad state at the beginning of a run (can be used as delay)	2 Reach Waypoint	130	
		3 Take Shot (Ph)		130		
		4 Take Shot (Sec)		130		
		5 Shot At (Ph)		130		
		19 Injured		130		
		35 Reach Final Waypoint		130		
		36 Run Start		130		
		no selection		130		
		no selection		130		
		no selection		130		
no selection	130					
19-19	Blue ARV-RSTA	1 Default State	Start state and Default fallback state Agent state when agent has fired its primary weapon at an enemy (may not have hit target) Agent state when agent has fired its secondary weapon at an enemy (may not have hit target) Agent state when shot at by an enemy's primary weapon (may not have been hit) Agent state when shot at by an enemy's secondary weapon (may not have been hit) Agent state when injured (shot at and hit) Agent state when final waypoint is reached	2 Reach Waypoint	130	
		3 Take Shot (Ph)		130		
		4 Take Shot (Sec)		130		
		5 Shot At (Ph)		130		
		19 Injured		130		
		35 Reach Final Waypoint		130		
		no selection		130		
		no selection		130		
		no selection		130		
		no selection		130		
20-23	Blue UAV CL 1	1 Default State	Start state and Default fallback state	no selection	0	
		no selection		0		
		no selection		0		
		no selection		0		
		no selection		0		
		no selection		0		
		no selection		0		
		no selection		0		
		no selection		0		
		no selection		0		
24-27	Blue UAV CL 2	1 Default State	Start state and Default fallback state	no selection	0	
		no selection		0		
		no selection		0		
		no selection		0		
		no selection		0		
		no selection		0		
		no selection		0		
		no selection		0		
		no selection		0		
		no selection		0		



# F. COMMUNICATION CHARACTERISTICS

Item #	Device	Type	Notes	Range(meters)	range (model_grid)	Capacity (msgs/sec)	capacity (model_step)	Queue Buffer Size	Latency (sec)	latency (model)	Self	Reliab.	100	MxAge	Rank Filter	Include	Delivery (Guaranteed of F-N-F)
1	Cellphone or equivalent	VHF	Limited Reliability	2,000	385	1	1	2	10	10	120	70	100	30	High	SETC	F-N-F
2	Basic Radio or equivalent	UHF	LOS	50	10	1	1	2	10	10	120	70	100	30	High	SET	F-N-F
3	Personal Role Radio (PRR) or equivalent	UHF	Intra-Team Communications	500	96	1	1	2	10	10	120	93	100	30	High	SNETC	F-N-F
4	PRC 148 or equivalent	VHF/UHF	Platoon - Squad - Team C2 - CAS Control	6,500	500	1	1	2	10	10	120	93	100	30	High	SNETC	F-N-F
5	JTRS Cluster(8 channel) or equivalent	Digital	Future Internet Networked Protocol System (Joint Tactical Radio System)	50,000	500	8	8	16	10	10	120	93	100	30	High	SNETC	F-N-F
6	JTRS Cluster(4 channel) or equivalent	Digital	Networked Protocol System (Joint Tactical Radio System)	50,000	500	4	4	8	10	10	120	93	100	30	High	SNETC	F-N-F
7	JTRS Cluster 5 SFF-D-E-G or equivalent	Digital	Future Internet Networked Protocol System (Joint Tactical Radio System)	50,000	500	5	5	10	10	10	120	98	100	30	High		F-N-F
8	PRC 117 or equivalent	UHF / Satellite Communications	Squad - Plat - HHQ CAS/Fires Control (OTH Digital)	11,500	500	1	2	2	10	10	120	93	100	30	High	SNETC	F-N-F

notes: call waiting time to make call every 2 min max hold time until decide to call back

1 transmission at a time not used in my model

FOR MY MODEL THESE COMMS ARE ESSENTIAL TO THE COMBAT INTERIOR EFFECTS

Number	Squad	With Radio Capabilities or Similarities to:
1	Red BMP-3	6
2	Red 82 Mortors	4
3	Red SA-16 Infantryman	1
4	Red RPG-7	1
5	Red AT-7	4
6	Red Scout	4
7	Red RPK-74	2
8	Red AK-M Infantryman	4
9	Red SVD	1
10	Red APC	6
11	Red T72	6
12	Blue NLOS Mortor Sec	5
13	Blue NLOS Cannon Pit	5
14	Blue NLOS LS Pit	7
15	Blue ICV Platoon	5
16	Blue MCS Platoon	5
17	Blue ARV-A	6
18	Blue ARV-AL	6
19	Blue ARV-RSTA	6
20	Blue UAV CL 1	7
21	Blue UAV CL 2	7
22	Blue UAV CL 3	7
23	Blue R&SV	5
24	Blue Infantryman	3
25	Blue MachineGunner M2	3
26	Blue CAS	8
27	Blue Apache	8

Notes:  
 Blue Force Radio reference from FCS UA Design Concept Baseline Descriptions UA-001-01-050124  
 Blue Force CAS and Apache referenced from pilots currently stationed at Naval Postgraduate School academic year 2005  
 Red Force Radio designed to be equivalent to Blue Force capabilities

## BLUE FORCE

Type	From Squad	To Squad	Type	LINK (Y/N)	#	DEVICE	Range	Capacity	Buffer	Latency	Self	Reliab.	Acc.	MxAge	Rank Filter	Include	Delivery
Blue NLOS Mortor Sec	12		#N/A	n	5												
Blue NLOS Cannon Pit	13		#N/A	n	5												
Blue NLOS LS Pit	14		#N/A	n	7												
Blue ICV Platoon	15	12	Blue NLOS Mortor Sec	y	5	JTRS Cluster(8 channel) or equivalent	500	8	16	10	120	93	100	30	High	SNETC	F-N-F
Blue ICV Platoon	15	13	Blue NLOS Cannon Pit	y	5	JTRS Cluster(8 channel) or equivalent	500	8	16	10	120	93	100	30	High	SNETC	F-N-F
Blue ICV Platoon	15	16	Blue MCS Platoon	y	5	JTRS Cluster(8 channel) or equivalent	500	8	16	10	120	93	100	30	High	SNETC	F-N-F
Blue MCS Platoon	16	14	Blue NLOS LS Pit	y	5	JTRS Cluster(8 channel) or equivalent	500	8	16	10	120	93	100	30	High	SNETC	F-N-F
Blue MCS Platoon	16	23	Blue UAV CL 1	y	5	JTRS Cluster(8 channel) or equivalent	500	8	16	10	120	93	100	30	High	SNETC	F-N-F
Blue ARV-A	17	15	Blue ICV Platoon	y	6	JTRS Cluster(4 channel) or equivalent	500	4	8	10	120	93	100	30	High	SNETC	F-N-F
Blue ARV-A	17	24	Blue UAV CL 2	y	6	JTRS Cluster(4 channel) or equivalent	500	4	8	10	120	93	100	30	High	SNETC	F-N-F
Blue ARV-AL	18	16	Blue MCS Platoon	y	6	JTRS Cluster(4 channel) or equivalent	500	4	8	10	120	93	100	30	High	SNETC	F-N-F
Blue ARV-RSTA	19	16	Blue MCS Platoon	y	6	JTRS Cluster(4 channel) or equivalent	500	4	8	10	120	93	100	30	High	SNETC	F-N-F
Blue UAV CL 1	20	15	Blue ICV Platoon	y	7	JTRS Cluster 5 SFF-D-E-G or equivalent	500	5	10	10	120	98	100	30	High	0	F-N-F
Blue UAV CL 2	24	16	Blue MCS Platoon	y	3	Personal Role Radio (PRR) or equivalent	96	1	2	10	120	93	100	30	High	SNETC	F-N-F
Blue UAV CL 3	28	23	Blue UAV CL 1	y	8	PRC 117 or equivalent	500	2	2	10	120	93	100	30	High	SNETC	F-N-F
Blue R&SV	29	14	Blue NLOS LS Pit	y	8	PRC 117 or equivalent	500	2	2	10	120	93	100	30	High	SNETC	F-N-F
Blue R&SV	29	26	Blue UAV CL 2	y	8	PRC 117 or equivalent	500	2	2	10	120	93	100	30	High	SNETC	F-N-F
Blue R&SV	29	27	Blue UAV CL 2	y	8	PRC 117 or equivalent	500	2	2	10	120	93	100	30	High	SNETC	F-N-F
Blue Infantryman	30	15	Blue ICV Platoon	y	8	PRC 117 or equivalent	500	2	2	10	120	93	100	30	High	SNETC	F-N-F
Blue MachineGunner M2	31	15	Blue ICV Platoon	y	8	PRC 117 or equivalent	500	2	2	10	120	93	100	30	High	SNETC	F-N-F
Blue CAS	32		#N/A	n	8												
Blue Apache	33		#N/A	n	8												

add to Latency an additional 20 seconds to all NLOS Cannon and NLOS Launch Systems take into account time of flight and another 10 seconds for computation procedures  
 add to Latency an additional 45 seconds to all NLOS Mortars Latency to take into account time of flight and another 10 seconds for computational procedures



**RED FORCE**

Intra-Squad Comms Delay	
Squad Threat Persistence	30
Fuse Unknowns	No
Fuse Time	-
Fuse Radius	-

Agent Memory 30 seconds

min link Rank	low
Inorganic Threat Persistence	30
Fuse Unknowns on Inorg map	No
Fuse Time	-
Fuse Radius	-
Outbound Comm Link	X

Type	From Squad	To Squad	Type	LINK (Y/N)	#	DEVICE	Range	Capacity	Buffer	Latency	Self	Reliab.	Acc.	MxAge	Rank Filter	Include	Delivery
Red BMP-3	1		#NA	n	6												
Red 82 Mortars	2		#NA	n	4												
Red SA-16 Infantryman	3		#NA	n	1												
Red RPG-7	4		#NA	n	1												
Red AT-7	5	11	Red T72	y	4	PRC 148 or equivalent	500	1	2	10	120	93	100	30	High	SNETC	F-N-F
Red Scout	6	1	Red BMP-3	y	4	PRC 148 or equivalent	500	1	2	10	120	93	100	30	High	SNETC	F-N-F
Red Scout	6	2	Red 82 Mortars	y	4	PRC 148 or equivalent	500	1	2	10	120	93	100	30	High	SNETC	F-N-F
Red Scout	6	4	Red RPG-7	y	4	PRC 148 or equivalent	500	1	2	10	120	93	100	30	High	SNETC	F-N-F
Red Scout	6	5	Red AT-7	y	4	PRC 148 or equivalent	500	1	2	10	120	93	100	30	High	SNETC	F-N-F
Red Scout	6	9	Red SVD	y	4	PRC 148 or equivalent	500	1	2	10	120	93	100	30	High	SNETC	F-N-F
Red Scout	6	11	Red T72	y	4	PRC 148 or equivalent	500	1	2	10	120	93	100	30	High	SNETC	F-N-F
Red RPK-74	7		#NA	n	2												
Red AK-M Infantryman	8	1	Red BMP-3	y	4	PRC 148 or equivalent	500	1	2	10	120	93	100	30	High	SNETC	F-N-F
Red AK-M Infantryman	8	2	Red 82 Mortars	y	4	PRC 148 or equivalent	500	1	2	10	120	93	100	30	High	SNETC	F-N-F
Red AK-M Infantryman	8	39	Red T72	y	4	PRC 148 or equivalent	500	1	2	10	120	93	100	30	High	SNETC	F-N-F
Red SVD	9		#NA	n	1												
Red APC	10	2	Red 82 Mortars	y	6	JTRS Cluster(4 channel) or equivalent	500	4	8	10	120	93	100	30	High	SNETC	F-N-F
Red APC	10		#NA	n	6												
Red T72	11		#NA	n	6												

add to Latency an additional 45 seconds to all Mortars Latency to take into account time of flight and another 10 seconds for computational procedures

## G. WEAPON CHARACTERISTICS

Max Terrain Dimension  
 # CELLS in maximum dimension  
 Steps per Minute  
 Steps per Second

**2600** Meters  
**500** # GRIDS  
**60** Steps  
**1** Steps

**5.200** Meters per grid  
**5.689** Yds per grid  
**17.066** Feet per grid

TABLE A

Weapon Specs

Platform	Weapon	Min Effective Range (m)	Max Effective Range (m)	Max weapon Range	Shot Radius (m)	Max Targets/min	Carried Rounds	{High Rate of Fire / min}
Blue NLOS Mortar Sec	120 mm BLOS guided munition	500	12000	15000	60	2	62	24
	xm307 25mm	1	450	2000	1	10	300	250
Blue NLOS Cannon Pit	155 mm std	500	30000	30000	50	4	24	10
	155 mm guided (heavy targets only)	500	30000	30000	50	4	24	10
Blue NLOS LS Pit	payload assit mod (PAM)	500	40000	40000	50	1	15	1
Blue ICV Platoon	MK44 30 mm	1	2000	6000	1	10	320	400
	M240B 7.62mm	1	1800	3725	1	10	1200	200
Blue MCS Platoon	Guided xm36 120mm	40	2000	4000	15	4	27	4
	xm307 25mm	1	450	2000	1	10	300	250
Blue ARV-A	MK44 30 mm	1	2000	6000	1	10	320	400
	M240B 7.62mm	1	1800	3725	1	10	1200	200
Blue ARV-A(L)	xm307 25 mm	1	450	2000	1	10	300	250
	Javelin Anti Tank Missile	75	2000	2000	5	2	2	2
Blue ARV-RSTA	xm307 25 mm	1	450	2000	1	10	300	250
Blue UAV CL 3	Guided Hellfire	500	7000	8000	30	16	4	16
	APKWS	500	6000	6500	10	4	6	4
Blue R&SV	xm307 25 mm	1	450	2000	1	10	300	250
Blue Infantryman	m16	1	550	3600	1	10	1260	16
Blue MachineGunner M2	m240B 7.62mm	1	1800	3725	1	10	1200	200
Blue CAS	m230 / 30 mm	1	1830	6000	1	10	1200	625
	Guided LOCAAS	100	100000	100000	50	1	16	1
Blue Apache	m230 / 30 mm	1	1830	6000	1	10	1200	625
	Guided Hellfire	500	7000	8000	30	16	16	16
Red BMP-3	2A-42 /30 mm	1	4000	unk	5	4	500	15
	Guided 2A-70M100mm tube firing AT12 guided stabber	100	5500	unk	15	4	50	3
Red 82 Mortars	82 mm Mortar	1000	4000	4000	15	4	65	10
	ak m/47 rifle	1	300	1000	1	10	240	600
Red SA-16 Infantryman	Guided SA-16 Surface to Air Missile	500	3500	5000	5	2	2	2
Red RPG-7	anti tank grenade launcher	50	500	920	5	6	6	6
Red AT-7	anti tank missile	40	500	1000	5	2	2	2
Red Scout	ak m/47 rifle	1	300	1000	1	10	240	600
Red RPK-74	rpk 74 light machine gun	1	450	2500	1	10	1000	150
Red AK-M Infantryman	ak m / 47 rifle	1	300	1000	1	10	240	600
Red SVD	SVD 7.62 sniper	1	1300	3800	1	1	10	30
Red APC	2A-42 /30 mm	1	300	2500	1	10	240	100
	rpk 74 light machine gun	1	450	2500	1	10	1000	150
Red T72	2A-46 /125mm	50	2120	10000	15	4	60	8
	rpk 74 light machine gun	1	450	2500	1	10	1000	150

**1**      **0.5**      **0**

Maximum effective range is the maximum range within which a weapon is effective against its intended target.

interpret to be 50% kill rate

TABLE B

Weapon		Effects in Grid Range	Pkill at Max Grid Range	Grid Shot Radius	engagmnt/tep	Targets / 100	time in shot taken state
Blue NLOS Mortor Sec	120 mm BLOS guided munition	500	1	12	0.03	100	30
0	xm307 25mm	87	0	0	0.17	100	6
Blue NLOS Cannon Plt	155 mm std	500	1	10	0.07	100	15
0	155 mm guided (heavy targets only)	500	1	10	0.07	100	15
Blue NLOS LS Plt	payload assit mod (PAM)	500	1	10	0.02	100	60
Blue ICV Platoon	MK44 30 mm	385	1	0	0.17	100	6
0	M240B 7.62mm	346	1	0	0.17	100	6
Blue MCS Platoon	Guided xm36 120mm	385	1	3	0.07	100	15
0	xm307 25mm	87	0	0	0.17	100	6
Blue ARV-A	MK44 30 mm	385	1	0	0.17	100	6
0	M240B 7.62mm	346	1	0	0.17	100	6
Blue ARV-A(L)	xm307 25 mm	87	0	0	0.17	100	6
0	Javelin Anti Tank Missile	385	1	1	0.03	100	30
Blue ARV-RSTA	xm307 25 mm	87	0	0	0.17	100	6
Blue UAV CL 3	Guided Hellfire	500	1	6	0.27	100	4
0	APKWS	500	1	2	0.07	100	15
Blue R&SV	xm307 25 mm	87	0	0	0.17	100	6
Blue Infantryman	m16	106	1	0	0.17	100	6
Blue MachineGunner	m240B 7.62mm	346	1	0	0.17	100	6
Blue CAS	m230 / 30 mm	352	1	0	0.17	100	6
0	Guided LOCAAS	500	1	10	0.02	100	60
Blue Apache	m230 / 30 mm	352	1	0	0.17	100	6
0	Guided Hellfire	500	1	6	0.27	100	4
Red BMP-3	2A-42 /30 mm	500	1	1	0.07	100	15
0	Guided 2A-70M100mm tube firing	500	1	3	0.07	100	15
Red 82 Mortors	82 mm Mortar	500	1	3	0.07	100	15
0	ak m/47 rifle	58	0	0	0.17	100	6
Red SA-16 Infantryman	Guided SA-16 Surface to Air Missile	500	1	1	0.03	100	30
Red RPG-7	anti tank grenade launcher	96	1	1	0.10	100	10
Red AT-7	anti tank missile	96	1	1	0.03	100	30
Red Scout	ak m/47 rifle	58	0	0	0.17	100	6
Red RPK-74	rpk 74 light machine gun	87	0	0	0.17	100	6
Red AK-M Infantryman	ak m / 47 rifle	58	0	0	0.17	100	6
Red SVD	SVD 7.62 sniper	250	1	0	0.02	100	60
Red APC	2A-42 /30 mm	58	0	0	0.17	100	6
0	rpk 74 light machine gun	87	0	0	0.17	100	6
Red T72	2A-46 /125mm	408	1	3	0.07	100	15
0	rpk 74 light machine gun	87	0	0	0.17	100	6

RANGE PROFILE FOR MAP (MANA conversion for Kinetic Weapon Factors only)

TABLE C

max req 2600

Note: simply highlight last column and expand to right to cover additional distance or change Real world values to desired values

MANA values if modeled as Kinetic Energy Weapon

Weapon	Real World	0	25	50	300	450	501	750	1000	1500	2000	2600
	GRID	0	5	10	58	87	96	144	192	288	385	500
Blue NLOS Mortor Sec	120 mm BLOS guided munition	0.00	0.00	0.00	0.00	0.00	1.00	1.00	1.00	1.00	1.00	1.00
0	xm307 25mm	0.92	0.92	0.89	0.78	0.72	0.68	0.53	0.40	0.17	0.00	0.00
Blue NLOS Cannon Plt	155 mm std	0.00	0.00	0.00	0.00	0.00	1.00	1.00	0.99	0.98	0.98	0.96
0	155 mm guided (heavy targets only)	0.00	0.00	0.00	0.00	0.00	1.00	1.00	0.99	0.98	0.98	0.96
Blue NLOS LS Plt	payload assit mod (PAM)	0.00	0.00	0.00	0.00	0.00	1.00	1.00	0.99	0.99	0.98	0.97
Blue ICV Platoon	MK44 30 mm	1.00	1.00	0.98	0.92	0.88	0.87	0.80	0.74	0.62	0.51	0.39
0	M240B 7.62mm	1.00	1.00	0.99	0.92	0.87	0.86	0.79	0.73	0.58	0.46	0.29
Blue MCS Platoon	Guided xm36 120mm	0.00	0.00	1.00	0.93	0.89	0.88	0.82	0.76	0.63	0.51	0.35
0	xm307 25mm	0.92	0.92	0.89	0.78	0.72	0.68	0.53	0.40	0.17	0.00	0.00
Blue ARV-A	MK44 30 mm	1.00	1.00	0.98	0.92	0.88	0.87	0.80	0.74	0.62	0.51	0.39
0	M240B 7.62mm	1.00	1.00	0.99	0.92	0.87	0.86	0.79	0.73	0.58	0.46	0.29
Blue ARV-A(L)	xm307 25 mm	0.92	0.92	0.89	0.78	0.72	0.68	0.53	0.40	0.17	0.00	0.00
0	Javelin Anti Tank Missile	0.00	0.00	0.00	0.94	0.90	0.89	0.82	0.77	0.63	0.51	0.00
Blue ARV-RSTA	xm307 25 mm	0.92	0.92	0.89	0.78	0.72	0.68	0.53	0.40	0.17	0.00	0.00
Blue UAV CL 3	Guided Hellfire	0.00	0.00	0.00	0.00	0.00	1.00	1.00	1.00	1.00	1.00	1.00
0	APKWS											
Blue R&SV	xm307 25 mm	0.92	0.92	0.89	0.78	0.72	0.68	0.53	0.40	0.17	0.00	0.00
Blue Infantryman	m16	0.94	0.94	0.91	0.77	0.70	0.67	0.54	0.43	0.23	0.11	0.03
Blue MachineGunner	m240B 7.62mm	1.00	1.00	0.99	0.92	0.87	0.86	0.79	0.73	0.58	0.46	0.29
Blue CAS	m230 / 30 mm	1.00	1.00	0.98	0.91	0.87	0.85	0.78	0.72	0.59	0.48	0.36
0	Guided LOCAAS	1.00	1.00	1.00	1.00	1.00	1.00	1.00	1.00	0.99	0.99	0.99
Blue Apache	m230 / 30 mm	1.00	1.00	0.98	0.91	0.87	0.85	0.78	0.72	0.59	0.48	0.36
0	Guided Hellfire	0.00	0.00	0.00	0.00	0.00	1.00	1.00	1.00	1.00	1.00	1.00
Red BMP-3	2A-42 /30 mm	1.00	1.00	0.99	0.96	0.94	0.94	0.91	0.88	0.81	0.75	0.68
0	Guided 2A-70M100mm tube firing	0.00	0.00	0.00	0.98	0.97	0.96	0.94	0.92	0.87	0.83	0.77
Red 82 Mortors	82 mm Mortar	0.00	0.00	0.00	0.00	0.00	0.00	0.00	0.00	0.92	0.84	0.73
0	ak m/47 rifle	0.92	0.92	0.89	0.73	0.56	0.50	0.23	0.00	0.00	0.00	0.00
Red SA-16 Infantryman	Guided SA-16 Surface to Air Missile	0.00	0.00	0.00	0.00	0.00	1.00	0.97	0.94	0.87	0.80	0.69
Red RPG-7	anti tank grenade launcher	0.00	0.00	1.00	0.71	0.54	0.48	0.20	0.00	0.00	0.00	0.00
Red AT-7	anti tank missile	0.00	0.00	0.98	0.73	0.58	0.52	0.26	0.02	0.00	0.00	0.00
Red Scout	ak m/47 rifle	0.92	0.92	0.89	0.73	0.56	0.50	0.23	0.00	0.00	0.00	0.00
Red RPK-74	rpk 74 light machine gun	0.91	0.91	0.89	0.78	0.72	0.69	0.54	0.43	0.23	0.10	0.00
Red AK-M Infantryman	ak m / 47 rifle	0.92	0.92	0.89	0.73	0.56	0.50	0.23	0.00	0.00	0.00	0.00
Red SVD	SVD 7.62 sniper	0.99	0.99	0.97	0.88	0.82	0.80	0.71	0.63	0.47	0.34	0.20
Red APC	2A-42 /30 mm	0.92	0.92	0.89	0.73	0.56	0.50	0.23	0.00	0.00	0.00	0.00
0	rpk 74 light machine gun	0.91	0.91	0.89	0.78	0.72	0.69	0.54	0.43	0.23	0.10	0.00
Red T72	2A-46 /125mm	0.00	0.00	1.00	0.93	0.90	0.88	0.82	0.76	0.64	0.54	0.41
0	rpk 74 light machine gun	0.91	0.91	0.89	0.78	0.72	0.69	0.54	0.43	0.23	0.10	0.00

Note: Table C reflects flexible data values, for simplified changes to the model if needed. Weapons finally modeled as Area Fire weapons are reflected in Table D.

TABLE D  
 Area Fire Weapon Data Determined by Real World Blast Radius and Pk is determined by Carleton Function  
 MANA values if modeled as Area Fire Weapon

Platform	Target Type	b	real world range	0	20	40	60	
NLOS M	light target	51	MANA units	0	4	8	12	
			1	0.925988	0.735228	0.500553		
			heavy target	36	1	0.856997	0.539408	0.249352
			1	0.856997	0.539408	0.249352		
NLOS C/LS	light target	43	real world range	0	16.66667	33.33333	50	
			MANA units	0	3	6	10	
			1	0.927636	0.740476	0.508627		
			heavy target	30	1	0.856997	0.539408	0.249352
guided xm36	light target	13	real world range	0	5	10	15	
			MANA units	0	1	2	3	
			1	0.928705	0.743893	0.513924		
			heavy target	9	1	0.856997	0.539408	0.249352
guided 82mm	light target	13	real world range	0	5	10	15	
			MANA units	0	1	2	3	
			1	0.928705	0.743893	0.513924		
			heavy target	9	1	0.856997	0.539408	0.249352

$$p(\text{hit}) = e^{\left(-\frac{r^2}{2b^2}\right)}$$

Carleton Function





## H. ARMOR AND CONCEALMENT

	Armor Thickness						MANA Value = 75% of the proportion value to the max value	Concealment					MANA VALUE
	Categories							HITL and Signature Management					
	ballistic protection	active measures	passive measures	threat warning receivers	countermine	body armor	Human In The Loop ie using terrain or cammo	None	level 1	level 2	changed % for modeling purposes		
Red BMP-3	1	2	2	1	1	1						30	
Red 82 Mortors	0	1	0	1	0	1			1			20	
Red SA-16 Infantryman	0	0	0	0	0	1						10	
Red RPG-7	0	0	0	0	0	1						10	
Red AT-7	0	0	0	0	0	1						10	
Red Scout	0	0	0	0	0	1						10	
Red RPK-74	0	0	0	0	0	1				2	x	60	
Red AK-M Infantryman	0	0	0	1	0	1						10	
Red SVD	0	0	0	0	0	1						10	
Red APC	2	1	2	2	1	0						43	
Red T72	1	2	2	1	1	1						43	
Blue NLOS Mortor Sec	4	2	3	3	1	1			1			20	
Blue NLOS Cannon Pit	4	1	3	3	1	1						20	
Blue NLOS LS Pit	0	0	0	0	0	1						100	
Blue ICV Platoon	3	1	3	3	2	1						70	
Blue MCS Platoon	4	1	3	3	2	1						75	
Blue ARV-A	3	2	2	1	1	1						54	
Blue ARV-A(L)	2	1	0	1	1	1						32	
Blue ARV-RSTA	3	2	2	1	1	1						54	
Blue UAV CL 1	0	0	0	0	0	0						0	
Blue UAV CL 2	0	0	0	0	0	0						0	
Blue UAV CL 3	3	2	3	3	1	1						70	
Blue R&SV	0	0	0	1	0	2						16	
Blue Infantryman	0	0	0	1	0	2						16	
Blue MachineGunner M240b	0	1	2	0	0	0						16	
Blue CAS	0	1	2	1	0	0						100	
Blue Apache	0	1	2	1	0	0						100	
	consisting of these individual capabilities												
	Auto Cannon	Integrate APS	CBRN	LWR	AT Mine Protection								
	HMG	Smoke Grenades	EMP	MWR (UV)	AO Mine Protection								
	HE Frag	Smart Top Attack	Fixed Wavelength Laser	NBC Warning	Internal Critical Component Ballistic Prot								
	Top Attack	EM Armor	Fire Extinguishers	JCAD Chem Point Det									
	14.5mm all around	LVOSS Smoke Dispensing	Fire Suppression										
	152 mm HE Frag	Local SA	ERA										

THIS PAGE INTENTIONALLY LEFT BLANK



## APPENDIX B. DOE MODELING

### A. DOE SPREADSHEET MODELING

This appendix outlines the crossed NOLH DOE. There exist three spreadsheet models within this appendix. The first is the factor description and is similar to that of Table 13. It outlines both the controlled and uncontrolled noise factors creating the robust design. The second spreadsheet is a NOLH coded spreadsheet for 17-22 factors detailing the factor levels used at each of the 129 design points.<sup>96</sup> The third spreadsheet is a design file, similar to the second, but adds the additional 9 correlated factors to each of the UAV p(det) factors, but at extended ranges. The design file is the final crossed NOLH DOE with 258 design points.

Factor Number	Model Values				Converted MANA Values		
	Potential Controlled Factors	Effecting Modeled Squad Units	Low Level	High Level	Mana factor	Mana Low	Mana High
1	number of UAVs CL I per team	20,21,22,23	0	6	UAV CL I	0	6
2	number of UAVs CL II per team	24,25,26,27	0	6	UAV CL II	0	6
3	number of UAVs CL III	28	0	16	UAV CL III	0	16
4	number of Hellfire missiles in UAV Warrior	28	0	4	Rounds	0	4
5	number of APKWS missiles in UAV CL III	28	0	8	Rounds	0	8
6	sensor range P(det) UAV CL I	20,21,22,23	0%	2%	Sensor Cababilities	0	2000
7	sensor range P(det) UAV CL II	24,25,26,27	0%	2%	Sensor Cababilities	0	2000
8	sensor range P(det) UAV CL III	28	0%	2%	Sensor Cababilities	0	2000
9	Agents desire to go after enemy UAV CL I and II	20,21,22,23, 24,25,26,27	0	20	Agent SA Enemies	0	20
10	Agents desire to go to next way point UAV CL I and II	20,21,22,23, 24,25,26,27	0	20	Agent SA Next Way Point	0	20
11	Agents desire to go after enemy UAV CL III	28	0	20	Agent SA Next Way Point	0	20
12	Agents desire to go to next way point UAV CL III	28	0	20	Agent SA Next Way Point	0	20
13	UAV CL I flying speed (kmph)	20,21,22,23	60	80	speed	261	427
14	UAV CL II flying speed (kmph)	24,25,26,27	80	100	speed	427	534
15	UAV CL III flying speed (kmph)	28,	80	140	speed	427	748
<b>Potential Noise Factors</b>							
16	number of initial enemy high pay off targets	1,2,3,6,10, 11	1	12	No. of agents	1	12
17	map editor city cover and concealment	all	1%	100%	all	0.01	1
18	map editor inside building cover and concealment	all	1%	100%	all	0.01	1
19	Communication Reliability due to inclement weather	20-28	0.75	1	reliability	75	100
20	UAV Concealment	20-28	0	0.9	concealment	0	90

<sup>96</sup> NOLH 17-22 Factors, coded by Professor Susan Sanchez, Naval Postgraduate School, Monterey, California.





## Second Half of Crossed NOLH DOE (APKWS Portion)

1	3	6	0	3	1000	4000	7000	9000	1000	4000	7000	9000	2000	5000	8000	10000	11	19	15	15	329	534	725	8	0.844	0.530	97.461	86	
5	2	7	0	1	1000	4000	7000	9000	1000	4000	7000	9000	0	3000	6000	8000	10	18	12	311	538	600	10	0.906	0.578	90.234	66		
3	5	0	0	3	2000	5000	8000	10000	2000	5000	8000	10000	0	3000	6000	8000	12	11	9	316	519	745	9	0.956	0.448	90.988	56		
4	9	5	0	4	2000	5000	8000	10000	0	3000	6000	8000	1000	4000	7000	9000	5	9	8	299	532	643	12	0.809	0.309	89.648	70		
3	4	11	0	1	1000	4000	7000	9000	1000	4000	7000	9000	0	3000	6000	8000	20	13	2	0.875	0.70	570	2	0.875	0.70	570	2		
2	12	0	1	0	3000	6000	8000	10000	0	3000	6000	8000	0	3000	6000	8000	5	2	4	20	332	479	527	5	0.922	0.875	93.945	66	
3	0	14	0	3	2000	5000	8000	10000	2000	5000	8000	10000	0	3000	6000	8000	6	14	10	2	301	498	577	6	0.914	0.344	89.766	25	
3	4	14	0	3	2000	5000	8000	10000	2000	5000	8000	10000	0	3000	6000	8000	6	4	10	2	380	457	535	6	0.469	0.094	99.219	52	
6	0	4	0	1	0	3000	6000	8000	1000	4000	7000	9000	0	3000	6000	8000	15	17	15	5	258	455	739	10	0.781	0.377	90.422	17	
0	6	8	0	3	1000	4000	7000	9000	1000	4000	7000	9000	0	3000	6000	8000	4	3	10	2	340	440	720	6	0.727	0.695	86.459	33	
0	6	8	0	3	1000	4000	7000	9000	1000	4000	7000	9000	0	3000	6000	8000	12	17	3	11	282	451	688	11	0.719	0.211	82.422	0	
6	6	4	0	1	2000	5000	8000	10000	1000	4000	7000	9000	0	3000	6000	8000	10	6	5	13	289	474	698	7	0.686	0.192	79.263	6	
3	2	15	0	3	1000	4000	7000	9000	0	3000	6000	8000	1000	4000	7000	9000	13	18	0	4	363	505	530	2	0.766	0.828	86.523	43	
5	1	15	0	1	0	3000	6000	8000	2000	5000	8000	10000	1000	4000	7000	9000	4	8	0	6	356	527	542	3	0.872	0.484	87.306	22	
2	3	16	0	4	0	3000	6000	8000	0	3000	6000	8000	0	3000	6000	8000	20	16	17	15	287	483	522	2	0.626	0.109	78.516	41	
4	6	16	0	1	1000	4000	7000	9000	2000	5000	8000	10000	1000	4000	7000	9000	5	8	19	12	298	460	510	2	0.864	0.377	90.268	25	
1	1	3	0	0	1000	4000	7000	9000	1000	4000	7000	9000	0	3000	6000	8000	15	11	12	14	310	493	622	8	0.477	0.773	89.288	27	
6	2	0	3	0	3000	6000	8000	0	3000	6000	8000	1000	4000	7000	9000	15	11	5	1	3	335	482	432	6	0.359	0.447	87.897	21	
1	5	5	0	2	0	3000	6000	8000	1000	4000	7000	9000	0	3000	6000	8000	5	18	6	10	341	530	447	8	0.056	0.414	84.57	28	
2	1	13	0	4	1000	4000	7000	9000	1000	4000	7000	9000	2000	5000	8000	10000	2	13	3	20	283	475	690	2	0.109	0.684	99.805	34	
1	2	10	0	3	0	3000	6000	8000	0	3000	6000	8000	1000	4000	7000	9000	19	11	3	12	262	480	633	5	0.172	0.817	96.875	31	
1	4	12	0	3	1000	4000	7000	9000	2000	5000	8000	10000	1000	4000	7000	9000	1	18	10	1	363	470	683	7	0.164	0.235	85.313	35	
4	4	16	0	2	1000	4000	7000	9000	2000	5000	8000	10000	1000	4000	7000	9000	20	8	13	3	366	458	638	4	0.023	0.445	91.016	19	
2	1	7	0	3	2000	5000	8000	10000	1000	4000	7000	9000	1000	4000	7000	9000	9	16	11	9	291	438	442	10	0.336	0.814	93.268	6	
6	0	7	0	1	1000	4000	7000	9000	1000	4000	7000	9000	2000	5000	8000	10000	13	6	13	7	264	448	547	11	0.148	0.938	84.375	89	
1	4	4	0	0	3000	6000	8000	1000	4000	7000	9000	1000	4000	7000	9000	6	17	9	14	318	485	550	7	0.462	0.133	85.684	75		
6	6	6	0	1	2000	5000	8000	10000	1000	4000	7000	9000	2000	5000	8000	10000	20	1	6	16	330	430	590	9	0.211	0.313	85.938	75	
2	3	12	0	3	1000	4000	7000	9000	0	3000	6000	8000	1000	4000	7000	9000	5	9	1	1	295	469	432	2	0.438	0.883	79.523	68	
4	3	16	0	4	1000	4000	7000	9000	1000	4000	7000	9000	2000	5000	8000	10000	11	7	6	3	302	502	748	1	0.362	0.836	82.813	49	
3	4	15	0	1	1000	4000	7000	9000	1000	4000	7000	9000	2000	5000	8000	10000	16	0	15	14	338	591	663	4	0.388	0.297	75.977	53	
0	2	0	4	4	1000	4000	7000	9000	2000	5000	8000	10000	1000	4000	7000	9000	18	19	10	15	325	549	633	5	0.038	0.336	79	83	
5	2	2	0	4	1000	4000	7000	9000	1000	4000	7000	9000	0	3000	6000	8000	7	7	10	18	19	315	497	693	3	0.25	0.32	84.18	54
2	6	1	0	6	0	3000	6000	8000	2000	5000	8000	10000	2000	5000	8000	10000	11	8	5	7	277	485	615	3	0.313	0.547	91.25	89	
0	2	10	0	6	2000	5000	8000	10000	1000	4000	7000	9000	0	3000	6000	8000	8	16	5	2	422	485	655	8	0.422	0.584	92.724	61	
0	2	10	0	6	2000	5000	8000	10000	1000	4000	7000	9000	1000	4000	7000	9000	12	0	4	15	345	452	575	7	0.305	0.47	85.547	74	
2	6	15	0	6	0	3000	6000	8000	1000	4000	7000	9000	2000	5000	8000	10000	14	2	12	8	309	476	475	7	0.403	0.969	81.445	82	
6	14	0	6	0	3000	6000	8000	10000	2000	5000	8000	10000	0	3000	6000	8000	14	2	12	8	470	576	625	7	0.313	0.471	85.938	82	
2	3	1	0	6	1000	4000	7000	9000	1000	4000	7000	9000	0	3000	6000	8000	17	5	17	1	387	450	688	1	0.063	0.563	98.242	32	
3	4	3	0	6	1000	4000	7000	9000	1000	4000	7000	9000	2000	5000	8000	10000	4	14	18	4	342	485	628	4	0.188	0.477	85.938	23	
1	0	8	0	7	1000	4000	7000	9000	2000	5000	8000	10000	1000	4000	7000	9000	17	7	7	16	281	484	738	4	0.133	0.889	99.609	40	
5	3	10	0	5	0	3000	6000	8000	1000	4000	7000	9000	0	3000	6000	8000	18	2	1	17	289	480	618	2	0.188	0.477	85.938	23	
1	0	13	0	8	0	3000	6000	8000	1000	4000	7000	9000	0	3000	6000	8000	18	7	4	1	382	516	487	8	0.195	0.039	88.281	42	
5	1	13	0	8	0	3000	6000	8000	1000	4000	7000	9000	0	3000	6000	8000	18	7	4	1	382	516	487	8	0.195	0.039	88.281	42	
3	5	13	0	8	2000	5000	8000	10000	1000	4000	7000	9000	2000	5000	8000	10000	9	15	12	13	327	517	472	9	0.297	0.781	91.602	27	
4	2	1	0	6	2000	5000	8000	10000	2000	5000	8000	10000	0	3000	6000	8000	19	16	11	12	286	515	497	1	0.274	0.921	85.841	26	
5	1	2	0	6	1000	4000	7000	9000	0	3000	6000	8000	1000	4000	7000	9000	19	16	11	12	286	515	497	1	0.274	0.921	85.841	26	
5	5	2	0	6	1000	4000	7000	9000	2000	5000	8000	10000	1000	4000	7000	9000	14	16	4	0	353	4	633	4	0.033	0.564	92.724	61	
5	5	15	0	7	0	3000	6000	8000	1000	4000	7000	9000	0	3000	6000	8000	15	11	1	6	370	520	585	3	0.859	0.758	92.817	44	
0	4	9	0	4	1000	4000	7000	9000	0	3000	6000	8000	1000	4000	7000	9000	10	19	9	18	295	481	670	6	0.656	0	77.344	8	
5	5	13	0	8	1000	4000	7000	9000	1000	4000	7000	9000	0	3000	6000	8000	13	20	10	2	312	487	680	11	0.711	0.945	84.961	30	
4	2	2	0	5	1000	4000	7000	9000	2000	5000	8000	10000	1000	4000	7000	9000	13	11	11	6	287	465	486	4	0.797	0.546	91.602	27	
1	5	7	0	8	1000	4000	7000	9000	1000	4000	7000	9000	0	3000	6000	8000	3	6	4	16	381	535	595	4	0.313	0.629	92.969	60	
2	2	14	0	4	2000	5000	8000	10000																					

## B. TILLER

The Tiller, Version 0.7.0.0, Copyright 2004 Referentia Systems Incorporated, is a product developed in support of Project Albert and the Marine Corps Warfighting Laboratory. Its primary purpose is to prepare model XML scenarios for Data Farming. In addition, it provides DOE options such as the Random Latin Hypercube coded by Professor Paul Sanchez, Naval Postgraduate School, and a Nearly Orthogonal Latin Hypercube coded by Professor Susan Sanchez, Naval Postgraduate School. The final output of the Tiller is a usable *study.xml* file containing the chosen DOE for running at any computer cluster facility. To choose factors for Data Farming, first select specific squad values from the *Scenario Information* window. Second, drag and drop these specific values into the *Scenario Variables to be Data Farmed* window. The author used the Tiller to build a skeleton *study.xml* file once, and performed further XML manipulation solely with the rapid process of Ruby Scripting.

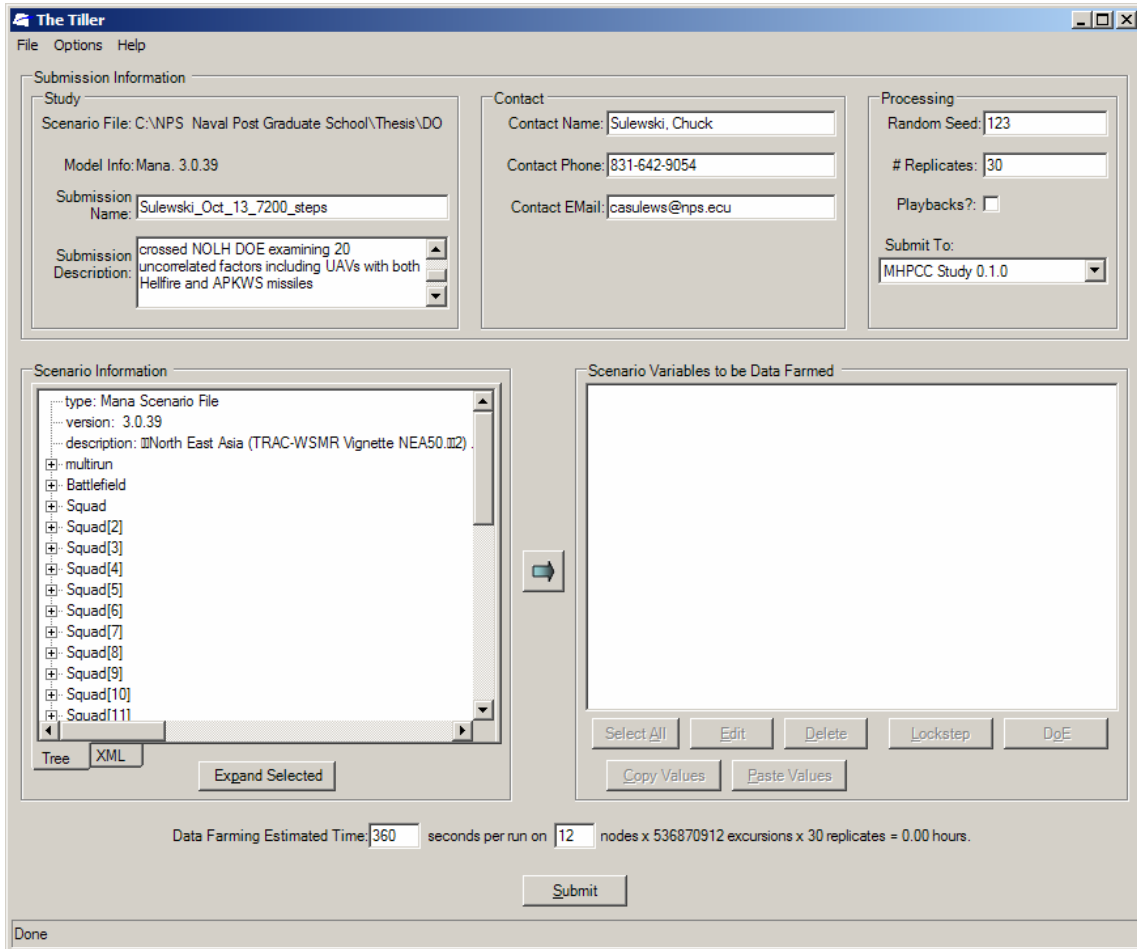

## C. RUBY SCRIPTING

Figure 28 identifies the *PatchExcursion.rb* Ruby code written by Paul Sanchez that modifies the skeleton Tiller *study.xml* file for all DOE iterations performed. A Notepad application provides simple viewing of the code. Figure 29 identifies the scripting typed by a user within a Command Prompt Window to execute the *PatchExcursion.rb* Ruby code. Table 19 identifies all the steps the user needs to execute to modify a skeleton Tiller *study.xml* file for use by the MHPCC.

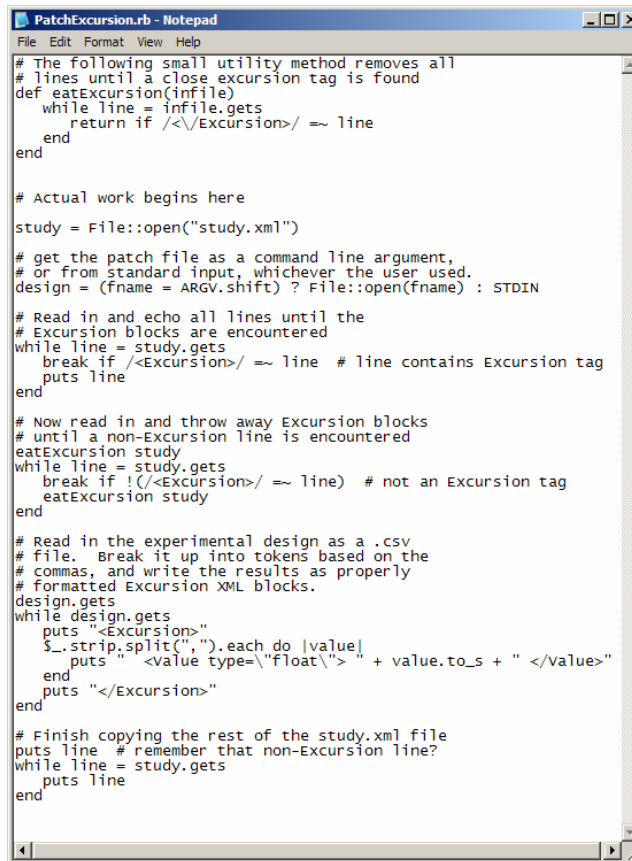

```
File Edit Format View Help
# The following small utility method removes all
# lines until a close excursion tag is found
def eatExcursion(infile)
  while line = infile.gets
    return if /</Excursion>/ =~ line
  end
end

# Actual work begins here
study = File::open("study.xml")

# get the patch file as a command line argument,
# or from standard input, whichever the user used.
design = (fname = ARGV.shift) ? File::open(fname) : STDIN

# Read in and echo all lines until the
# Excursion blocks are encountered
while line = study.gets
  break if /<Excursion>/ =~ line # line contains Excursion tag
  puts line
end

# Now read in and throw away Excursion blocks
# until a non-Excursion line is encountered
eatExcursion study
while line = study.gets
  break if !(/<Excursion>/ =~ line) # not an Excursion tag
  eatExcursion study
end

# Read in the experimental design as a .csv
# file. Break it up into tokens based on the
# commas, and write the results as properly
# formatted Excursion XML blocks.
design.gets
while design.gets
  puts "<Excursion>"
  $.strip.split(",").each do |value|
    puts " <value type='float'> " + value.to_s + " </value>"
  end
  puts "</Excursion>"
end

# Finish copying the rest of the study.xml file
puts line # remember that non-Excursion line?
while line = study.gets
  puts line
end
```

Figure 28. Ruby PatchExcursion.rb Code <sup>97</sup>

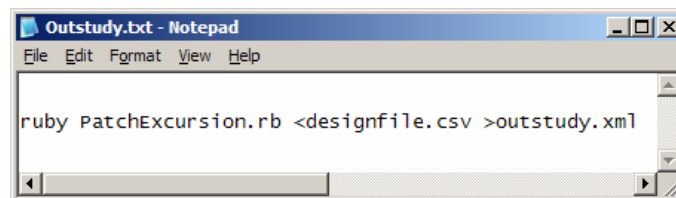

```
File Edit Format View Help

ruby PatchExcursion.rb <designfile.csv >outstudy.xml
```

Figure 29. Ruby Scripting Command

<sup>97</sup> PatchExcursion.rb, coded by Professor Paul Sanchez, Naval Postgraduate School, Monterey, California.

1. Open the Tiller, and ensure Ruby is loaded onto the running PC.
2. Browse to File/Open/Scenario File (The MANA *basecase.xml* file scenario location).
3. To create a skeleton *study.xml* file, double click on the appropriate factor within each squad (platform) from the “Scenario Information” window. Each factor will then appear in the “Scenario Variables to be Data Farmed” window. Else drag and drop from one window to the other. Once all factors are selected, double click on the submit button, and a *study.xml* file will be saved automatically in the same directory as the *basecase.xml* file.
4. Create a *designfile.csv* from the crossed NOLH DOE with 258 design points, and save the *.csv* file in the same location as *study.xml* file created by the Tiller. (The intent is to create columns consisting of the factor name and the values for each design point, or excursion, directly below each column heading name.)
5. Write and then save a copy of *PatchExcursion.rb* in the same folder as the skeleton *study.xml* file created by the Tiller (Refer to Figure 28).
6. Open a command window.
7. Change the directory within the command window to the same as that of the folder that contains a copy of *PathExcursion.rb*, *study.xml*, and *designfile.csv*.
8. Write the scripting code outlined in Figure 29 and press enter. (At this time, the ruby code reads the *designfile.csv* containing the DOE and merges each design point into the skeleton file created by the tiller.)
9. The *outstudy.xml* file automatically appears in the same directory.
10. Rename the *outstudy.xml* file to *study.xml* overwriting the old *study.xml*. This is necessary because the original *study.xml* file is only a skeleton file, and does not include the complete DOE. The *outstudy.xml* includes the completed DOE—but has the wrong name. See step 12.
11. Recreate a Zip folder of the current working directory.
12. Submit an email to MHPCC at [isaac@mhpcc.hpc.mil](mailto:isaac@mhpcc.hpc.mil) attaching the Zip file and wait. The computer cluster searches the zip folder for the specific file names outlined within this table. The zip folder must contain the *basecase.xml*, *terrain.bmp*, and *elevation.bmp* from the ABS, and the DOE scripted within the *study.xml*.

Table 19. Table of Instruction to Modify a Skeleton *study.xml* File

THIS PAGE INTENTIONALLY LEFT BLANK



## APPENDIX C. ADDITIONAL DATA ANALYSIS

The purpose of this appendix is streamline the Data Analysis chapter of this thesis. Figures follow in the same order as outlined in Chapter V. The fitted models determined by means of multiple regression help identify the number of UAVs (or any other parameter outlined within the DOE). In each instance, the model is in the form:

$$\hat{y} = \hat{\beta}_0 + \sum_{i=1}^k \hat{\beta}_i x_i + \sum_{i=k+1}^{2k} \hat{\beta}_i x_i^2 + \sum_{i=1}^{k-1} \sum_{j>i} \hat{\beta}_{i,j} x_i x_j$$

where

$$\hat{y} = MOE$$

$$\hat{\beta}_0 = \text{intercept}$$

$$\hat{\beta}_i = \text{parameter estimate}$$

$$x_i = \text{parameter (or factors)}$$

and where applicable

$$\sum_{i=k+1}^{2k} \hat{\beta}_i x_i^2 = \text{quadratic terms}$$

$$\sum_{i=1}^{k-1} \sum_{j>i} \hat{\beta}_{i,j} x_i x_j = \text{interaction terms}$$

## A. INITIAL OBSERVATIONS

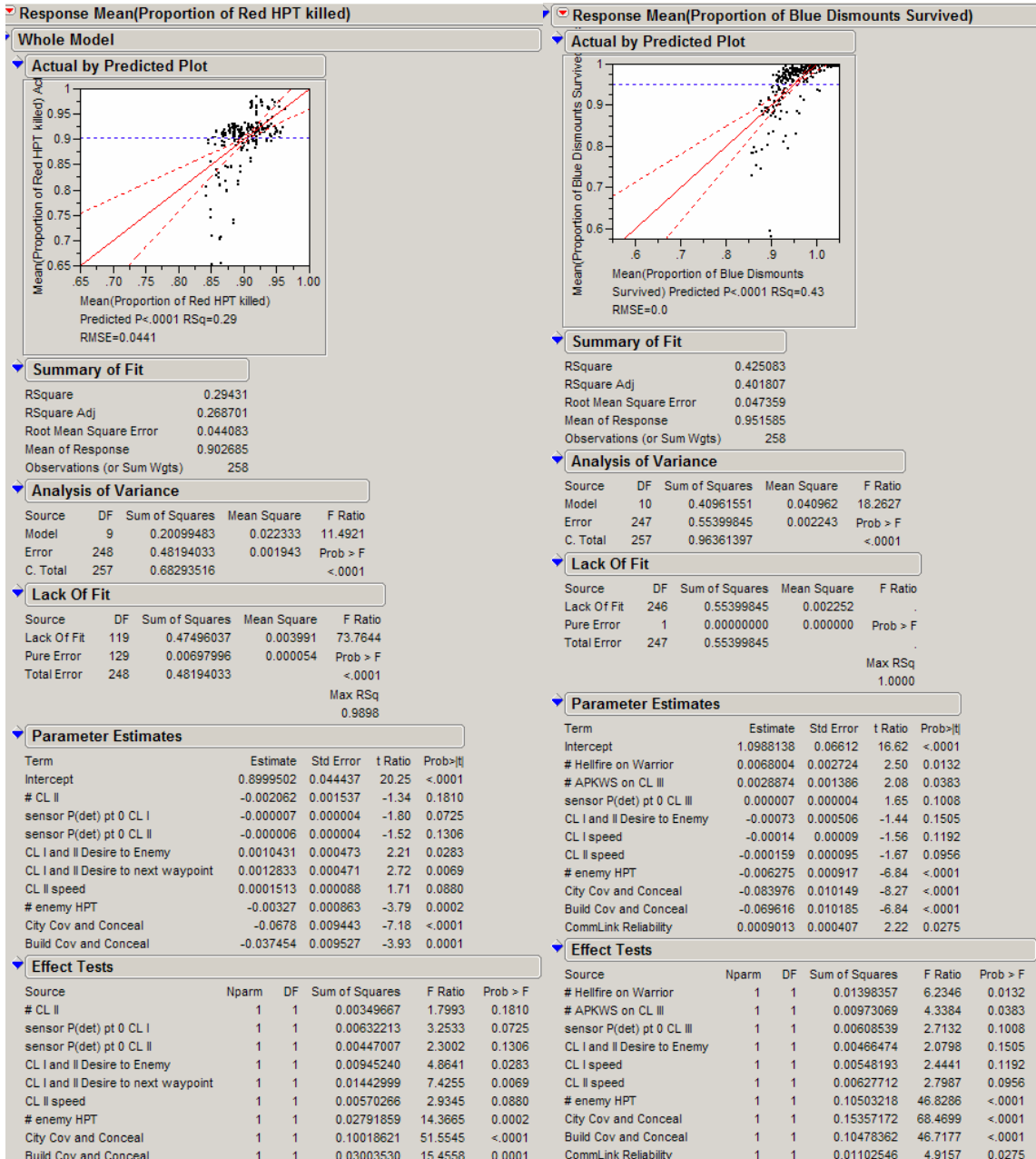
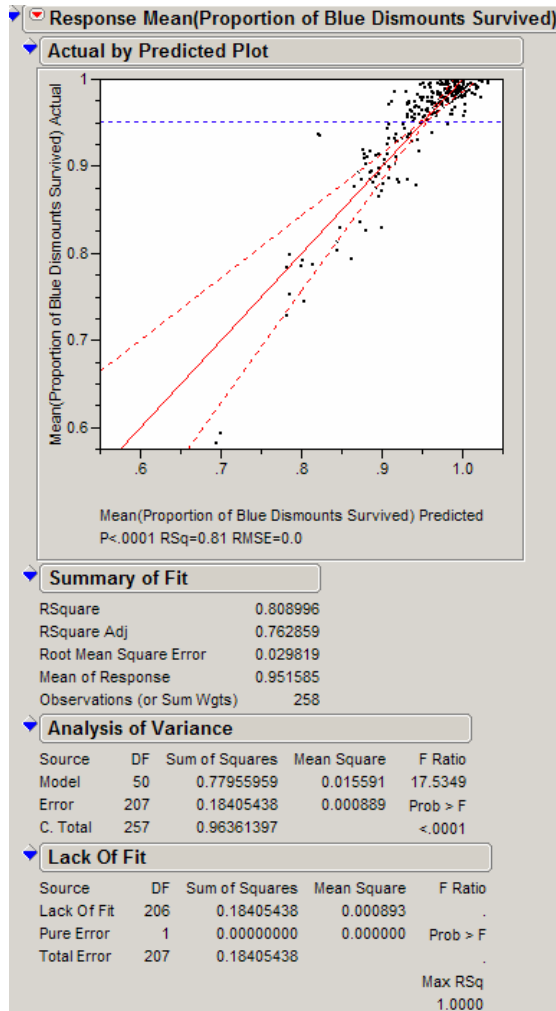

Figure 30. Multiple Regression Output for Initial Analysis of Robust DOE

(Note: This page contains Multiple Regression Models *without* Interactions, to view the Multiple Regression Model *with* Interactions mentioned in the Initial Observations section of Chapter V, refer to the next three pages.)

Multiple Regression Model *with* Interactions, as mentioned in the Initial Observations section of Chapter V: MOE - Proportion of Blue Dismounts Survived



(Note: An interesting note is that performing a multiple regression with interactions between factors raised the  $R^2$  to 0.80, suggesting an improved fitted model from that portrayed in Figure 13 (or Figure 30 in Appendix A). With interactions applied to the model, the Effect Test output, similar to Figure 13, was too large for the main body of the thesis. The output for this model is located here in Appendix C, “Initial Observations.” This improved model was similar to the first in that the most significant factors are those that are uncontrolled by the Blue Force. Refer to the next two pages, to view the Parameter Estimates, and the Effects Test supporting this improved model with an increased  $R^2 = 0.80$ .)

Parameter Estimates				
Term	Estimate	Std Error	t Ratio	Prob> t
Intercept	1.1611908	0.044631	26.02	<.0001
# CL I	0.001251	0.001046	1.20	0.2330
# CL II	0.0001063	0.001044	0.10	0.9190
# CL III	0.0001214	0.000399	0.30	0.7611
# Hellfire on Warrior	0.010843	0.00301	3.60	0.0004
# APKWS on CL III	0.0036567	0.000956	3.82	0.0002
sensor P(det) pt 0 CL I	-0.000002	0.000003	-0.78	0.4336
sensor P(det) pt 0 CL II	-0.000002	0.000003	-0.73	0.4668
sensor P(det) pt 0 CL III	0.0000056	0.000003	2.09	0.0380
CL I and II Desire to Enemy	-0.0007	0.000321	-2.18	0.0303
CL III Desire to next waypoint	-0.000097	0.00032	-0.30	0.7622
CL I speed	-0.000139	0.000057	-2.45	0.0153
CL II speed	-0.000166	0.00006	-2.76	0.0062
CL III speed	-0.000022	0.00002	-1.12	0.2620
# enemy HPT	-0.006268	0.000586	-10.70	<.0001
City Cov and Conceal	-0.084487	0.006402	-13.20	<.0001
Build Cov and Conceal	-0.071716	0.006482	-11.06	<.0001
CommLink Reliability	0.0008348	0.000257	3.25	0.0014
UAV Flying Concealment	0.0001205	0.000072	1.68	0.0945
(# CL I-3.00775)*(sensor P(det) pt 0 CL III-1007.75)	-0.000005	0.000002	-2.43	0.0160
(# CL I-3.00775)*(City Cov and Conceal-0.50003)	-0.008028	0.005103	-1.57	0.1172
(# CL I-3.00775)*(UAV Flying Concealment-45.0078)	-0.000266	0.000045	-5.94	<.0001
(# CL II-3.00775)*(CL I and II Desire to Enemy -10.0155)	0.0003068	0.000218	1.41	0.1611
(# CL II-3.00775)*(CommLink Reliability-87.5)	0.0005691	0.000193	2.94	0.0036
(# CL III-8.06202)*(# Hellfire on Warrior-1.00775)	0.0003881	0.000312	1.24	0.2153
(# CL III-8.06202)*(CL III Desire to next waypoint-10.0155)	0.0001042	0.000083	1.26	0.2089
(# CL III-8.06202)*(CL I speed-317.504)	-0.000032	0.000013	-2.38	0.0182
(sensor P(det) pt 0 CL I-1007.75)*(City Cov and Conceal-0.50003)	0.000049	0.000014	3.42	0.0008
(sensor P(det) pt 0 CL I-1007.75)*(Build Cov and Conceal-0.50003)	-0.000041	0.00001	-4.07	<.0001
(sensor P(det) pt 0 CL I-1007.75)*(UAV Flying Concealment-45.0078)	2.8173e-7	1.329e-7	2.12	0.0353
(sensor P(det) pt 0 CL II-1007.75)*(Build Cov and Conceal-0.50003)	-0.000022	0.000013	-1.74	0.0828
(sensor P(det) pt 0 CL III-1007.75)*(CL I and II Desire to Enemy -10.0155)	-0.000002	7.383e-7	-3.19	0.0016
(sensor P(det) pt 0 CL III-1007.75)*(CL I speed-317.504)	4.7162e-7	1.236e-7	3.82	0.0002
(sensor P(det) pt 0 CL III-1007.75)*(CL II speed-480.504)	1.8751e-7	1.244e-7	1.51	0.1331
(sensor P(det) pt 0 CL III-1007.75)*(City Cov and Conceal-0.50003)	-0.000023	0.00001	-2.31	0.0218
(CL I and II Desire to Enemy -10.0155)*(CL III Desire to next waypoint-10.0155)	-0.000521	0.000071	-7.33	<.0001
(CL I and II Desire to Enemy -10.0155)*(CL III speed-587.504)	0.000031	0.000006	5.20	<.0001
(CL III Desire to next waypoint-10.0155)*(CommLink Reliability-87.5)	-0.000096	0.000048	-2.01	0.0463
(CL I speed-317.504)*(CommLink Reliability-87.5)	0.0000363	0.000009	4.07	<.0001
(CL II speed-480.504)*(City Cov and Conceal-0.50003)	-0.000881	0.000254	-3.47	0.0006
(# enemy HPT-6.50388)*(City Cov and Conceal-0.50003)	-0.023168	0.00275	-8.42	<.0001
(# enemy HPT-6.50388)*(Build Cov and Conceal-0.50003)	-0.012156	0.002634	-4.62	<.0001
(City Cov and Conceal-0.50003)*(UAV Flying Concealment-45.0078)	-0.001089	0.000295	-3.70	0.0003
(CommLink Reliability-87.5)*(UAV Flying Concealment-45.0078)	-0.000025	0.000013	-1.98	0.0494
(# CL III-8.06202)*(# CL III-8.06202)	-0.000198	0.000124	-1.60	0.1104
(# Hellfire on Warrior-1.00775)*(# Hellfire on Warrior-1.00775)	-0.002267	0.001576	-1.44	0.1519
(sensor P(det) pt 0 CL III-1007.75)*(sensor P(det) pt 0 CL III-1007.75)	9.0143e-9	4.952e-9	1.82	0.0701
(CL I and II Desire to Enemy -10.0155)*(CL I and II Desire to Enemy -10.0155)	0.000253	0.000097	2.60	0.0100
(CL I speed-317.504)*(CL I speed-317.504)	-0.000007	0.000003	-2.66	0.0085
(City Cov and Conceal-0.50003)*(City Cov and Conceal-0.50003)	-0.336967	0.039568	-8.52	<.0001
(Build Cov and Conceal-0.50003)*(Build Cov and Conceal-0.50003)	-0.211595	0.033862	-6.25	<.0001

(Parameter Estimates for Multiple Regression Model *with* Interactions  
MOE - Proportion of Blue Dismounts Survived)

Effect Tests					
Source	Nparm	DF	Sum of Squares	F Ratio	Prob > F
# CL I	1	1	0.00127243	1.4311	0.2330
# CL II	1	1	0.00000923	0.0104	0.9190
# CL III	1	1	0.00008242	0.0927	0.7611
# Hellfire on Warrior	1	1	0.01154040	12.9791	0.0004
# APKWS on CL III	1	1	0.01300417	14.6254	0.0002
sensor P(det) pt 0 CL I	1	1	0.00054743	0.6157	0.4336
sensor P(det) pt 0 CL II	1	1	0.00047264	0.5316	0.4668
sensor P(det) pt 0 CL III	1	1	0.00387786	4.3613	0.0380
CL I and II Desire to Enemy	1	1	0.00423052	4.7579	0.0303
CL III Desire to next waypoint	1	1	0.00008163	0.0918	0.7622
CL I speed	1	1	0.00532129	5.9847	0.0153
CL II speed	1	1	0.00678689	7.6330	0.0062
CL III speed	1	1	0.00112472	1.2649	0.2620
# enemy HPT	1	1	0.10189297	114.5957	<.0001
City Cov and Conceal	1	1	0.15486073	174.1669	<.0001
Build Cov and Conceal	1	1	0.10885106	122.4213	<.0001
CommLink Reliability	1	1	0.00938069	10.5502	0.0014
UAV Flying Concealment	1	1	0.00250939	2.8222	0.0945
# CL I*sensor P(det) pt 0 CL III	1	1	0.00524688	5.9010	0.0160
# CL I*City Cov and Conceal	1	1	0.00220098	2.4754	0.1172
# CL I*UAV Flying Concealment	1	1	0.03142085	35.3380	<.0001
# CL II*CL I and II Desire to Enemy	1	1	0.00175862	1.9779	0.1611
# CL II*CommLink Reliability	1	1	0.00770154	8.6617	0.0036
# CL III*Hellfire on Warrior	1	1	0.00137355	1.5448	0.2153
# CL III*CL III Desire to next waypoint	1	1	0.00141289	1.5890	0.2089
# CL III*CL I speed	1	1	0.00503814	5.6662	0.0182
sensor P(det) pt 0 CL I*City Cov and Conceal	1	1	0.01037132	11.6643	0.0008
sensor P(det) pt 0 CL I*Build Cov and Conceal	1	1	0.01470243	16.5353	<.0001
sensor P(det) pt 0 CL I*UAV Flying Concealment	1	1	0.00399345	4.4913	0.0353
sensor P(det) pt 0 CL II*Build Cov and Conceal	1	1	0.00270226	3.0391	0.0828
sensor P(det) pt 0 CL III*CL I and II Desire to Enemy	1	1	0.00905398	10.1827	0.0016
sensor P(det) pt 0 CL III*CL I speed	1	1	0.01294656	14.5606	0.0002
sensor P(det) pt 0 CL III*CL II speed	1	1	0.00202161	2.2736	0.1331
sensor P(det) pt 0 CL III*City Cov and Conceal	1	1	0.00474793	5.3398	0.0218
CL I and II Desire to Enemy *CL III Desire to next waypoint	1	1	0.04776693	53.7219	<.0001
CL I and II Desire to Enemy *CL III speed	1	1	0.02407386	27.0751	<.0001
CL III Desire to next waypoint*CommLink Reliability	1	1	0.00357489	4.0206	0.0463
CL I speed*CommLink Reliability	1	1	0.01470892	16.5426	<.0001
CL II speed*City Cov and Conceal	1	1	0.01070242	12.0367	0.0006
# enemy HPT*City Cov and Conceal	1	1	0.06309559	70.9616	<.0001
# enemy HPT*Build Cov and Conceal	1	1	0.01893747	21.2984	<.0001
City Cov and Conceal*UAV Flying Concealment	1	1	0.01214959	13.6643	0.0003
CommLink Reliability*UAV Flying Concealment	1	1	0.00347523	3.9085	0.0494
# CL III*CL III	1	1	0.00228592	2.5709	0.1104
# Hellfire on Warrior*Hellfire on Warrior	1	1	0.00183886	2.0681	0.1519
sensor P(det) pt 0 CL III*sensor P(det) pt 0 CL III	1	1	0.00294683	3.3142	0.0701
CL I and II Desire to Enemy *CL I and II Desire to Enemy	1	1	0.00601749	6.7677	0.0100
CL I speed*CL I speed	1	1	0.00626958	7.0512	0.0085
City Cov and Conceal*City Cov and Conceal	1	1	0.06448469	72.5238	<.0001
Build Cov and Conceal*Build Cov and Conceal	1	1	0.03471806	39.0463	<.0001

(Effect Tests for Multiple Regression Model *with* Interactions  
MOE - Proportion of Blue Dismounts Survived)

## B. THE EARLY FIGHT

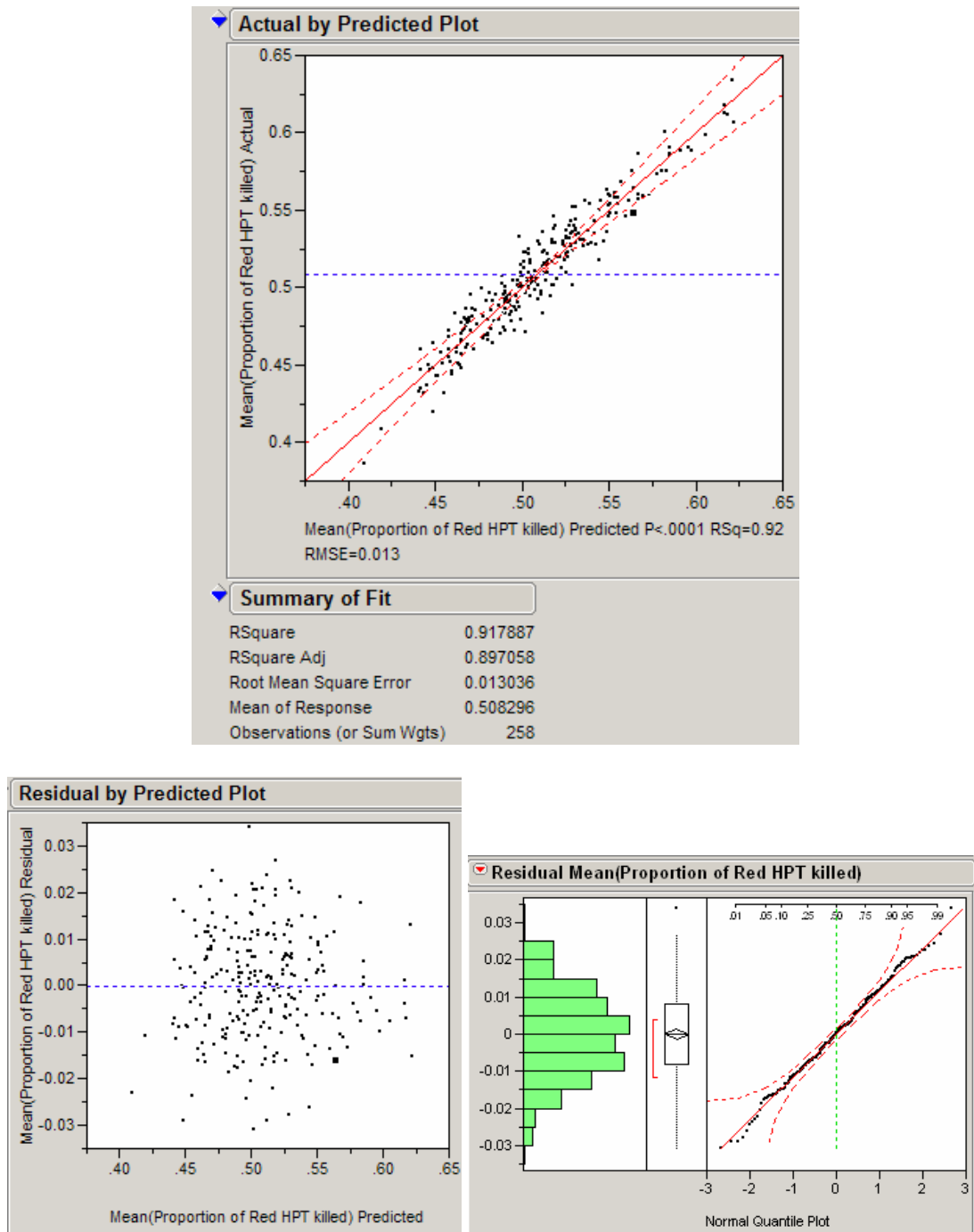

Figure 31. Regression Model (Proportion of HPTs Killed at 450 seconds)

(Note: Refer to the next two pages to view the Parameter Estimates and the Effects Test)

▼ Parameter Estimates

Term	Estimate	Std Error	t Ratio	Prob> t
Intercept	0.4444102	0.016684	26.64	<.0001
# CL I	0.0055595	0.000461	12.07	<.0001
# CL II	0.0023292	0.000459	5.07	<.0001
# CL III	0.0045383	0.000174	26.01	<.0001
# Hellfire on Warrior	0.0174158	0.001267	13.74	<.0001
# APKWS on CL III	0.013698	0.000849	16.13	<.0001
sensor P(det) pt 0 CL I	-5.862e-9	0.000001	-0.00	0.9960
sensor P(det) pt 0 CL II	-0.000004	0.000001	-3.43	0.0007
sensor P(det) pt 0 CL III	0.0000022	0.000001	1.84	0.0676
CL I and II Desire to Enemy	0.0007289	0.000141	5.17	<.0001
CL I and II Desire to next waypoint	0.0012903	0.000142	9.09	<.0001
CL III Desire to Enemy	0.0003835	0.000141	2.71	0.0072
CL III Desire to next waypoint	0.0005838	0.000141	4.13	<.0001
CL I speed	5.9667e-8	0.000025	0.00	0.9981
CL II speed	-0.000081	0.000026	-3.07	0.0024
CL III speed	-0.000021	0.000009	-2.40	0.0175
Mean(UAV with Hellfire)	0.0011694	0.004132	0.28	0.7774
(# CL I-3.00775)*(# CL III-8.06202)	0.0005517	0.00014	3.93	0.0001
(# CL I-3.00775)*(# Hellfire on Warrior-1.00775)	-0.000615	0.000772	-0.80	0.4268
(# CL I-3.00775)*(sensor P(det) pt 0 CL III-1007.75)	-0.000002	9.54e-7	-2.20	0.0289
(# CL I-3.00775)*(CL III Desire to next waypoint-10.0155)	-0.000114	0.000102	-1.11	0.2668
(# CL I-3.00775)*(CL II speed-480.504)	0.0000386	0.000016	2.45	0.0150
(# CL I-3.00775)*(Mean(UAV with Hellfire)-0.43798)	0.0038036	0.001973	1.93	0.0553
(# CL II-3.00775)*(CL I and II Desire to Enemy -10.0155)	0.0001492	0.000093	1.60	0.1110
(# CL II-3.00775)*(CL I and II Desire to next waypoint-10.0155)	0.0002932	0.000089	3.28	0.0012
(# CL II-3.00775)*(CL II speed-480.504)	0.0000269	0.000018	1.50	0.1353
(# CL II-3.00775)*(Mean(UAV with Hellfire)-0.43798)	0.0015566	0.00092	1.69	0.0923
(# CL III-8.06202)*(# Hellfire on Warrior-1.00775)	0.0016845	0.000255	6.62	<.0001
(# CL III-8.06202)*(# APKWS on CL III-2.0155)	0.0012277	0.000106	11.56	<.0001
(# CL III-8.06202)*(CL III Desire to next waypoint-10.0155)	0.0000794	0.000035	2.26	0.0249
(# CL III-8.06202)*(CL I speed-317.504)	0.0000182	0.000006	3.13	0.0020
(# CL III-8.06202)*(CL II speed-480.504)	-0.000014	0.000008	-1.82	0.0701
(# CL III-8.06202)*(CL III speed-587.504)	0.0000024	0.000002	1.25	0.2115
(# CL III-8.06202)*(Mean(UAV with Hellfire)-0.43798)	0.0013046	0.000784	1.66	0.0976
(# Hellfire on Warrior-1.00775)*(CL III Desire to next waypoint-10.0155)	0.0000224	0.000215	0.10	0.9169
(# Hellfire on Warrior-1.00775)*(CL III speed-587.504)	0.0000119	0.000007	1.67	0.0956
(# APKWS on CL III-2.0155)*(sensor P(det) pt 0 CL III-1007.75)	9.2042e-7	4.722e-7	1.95	0.0527
(# APKWS on CL III-2.0155)*(CL III Desire to next waypoint-10.0155)	0.0001244	0.000083	1.50	0.1344
(sensor P(det) pt 0 CL I-1007.75)*(CL I and II Desire to next waypoint-10.0155)	-4.494e-7	2.09e-7	-2.15	0.0327
(sensor P(det) pt 0 CL I-1007.75)*(CL III Desire to Enemy-10.0155)	-4.714e-7	2.673e-7	-1.76	0.0793
(sensor P(det) pt 0 CL II-1007.75)*(CL II speed-480.504)	-9.789e-8	5.174e-8	-1.89	0.0599
(sensor P(det) pt 0 CL III-1007.75)*(CL III Desire to next waypoint-10.0155)	3.6402e-7	1.997e-7	1.82	0.0698
(CL I and II Desire to Enemy -10.0155)*(CL I and II Desire to next waypoint-10.0155)	-0.000195	0.000029	-6.81	<.0001
(CL I and II Desire to Enemy -10.0155)*(CL II speed-480.504)	0.0000247	0.000005	4.68	<.0001
(CL I and II Desire to next waypoint-10.0155)*(Mean(UAV with Hellfire)-0.43798)	-0.000376	0.000289	-1.30	0.1949
(CL III Desire to Enemy-10.0155)*(Mean(UAV with Hellfire)-0.43798)	-0.00039	0.000288	-1.35	0.1777
(CL III Desire to next waypoint-10.0155)*(Mean(UAV with Hellfire)-0.43798)	0.001323	0.000657	2.01	0.0454
(CL II speed-480.504)*(CL III speed-587.504)	-5.99e-7	3.157e-7	-1.90	0.0592
(# CL I-3.00775)*(# CL I-3.00775)	-0.002452	0.00034	-7.22	<.0001
(# CL II-3.00775)*(# CL II-3.00775)	-0.001384	0.000337	-4.11	<.0001
(# APKWS on CL III-2.0155)*(# APKWS on CL III-2.0155)	-0.001325	0.000215	-6.16	<.0001
(CL III Desire to next waypoint-10.0155)*(CL III Desire to next waypoint-10.0155)	-0.000064	0.000033	-1.92	0.0557
(CL II speed-480.504)*(CL II speed-480.504)	0.0000049	0.000001	4.19	<.0001

(Proportion of HPTs Killed at 450 seconds)

Effect Tests					
Source	Nparm	DF	Sum of Squares	F Ratio	Prob > F
# CL I	1	1	0.02476311	145.7277	<.0001
# CL II	1	1	0.00436808	25.7056	<.0001
# CL III	1	1	0.11495625	676.5027	<.0001
# Hellfire on Warrior	1	1	0.03210211	188.9168	<.0001
# APKWS on CL III	1	1	0.04419072	260.0566	<.0001
sensor P(det) pt 0 CL I	1	1	4.24802e-9	0.0000	0.9960
sensor P(det) pt 0 CL II	1	1	0.00200084	11.7747	0.0007
sensor P(det) pt 0 CL III	1	1	0.00057353	3.3752	0.0676
CL I and II Desire to Enemy	1	1	0.00453516	26.6888	<.0001
CL I and II Desire to next waypoint	1	1	0.01403848	82.6147	<.0001
CL III Desire to Enemy	1	1	0.00125017	7.3571	0.0072
CL III Desire to next waypoint	1	1	0.00289570	17.0408	<.0001
CL I speed	1	1	9.7634e-10	0.0000	0.9981
CL II speed	1	1	0.00160575	9.4496	0.0024
CL III speed	1	1	0.00097541	5.7401	0.0175
Mean(UAV with Hellfire)	1	1	0.00001361	0.0801	0.7774
# CL I*# CL III	1	1	0.00262190	15.4296	0.0001
# CL I*# Hellfire on Warrior	1	1	0.00010775	0.6341	0.4268
# CL I*sensor P(det) pt 0 CL III	1	1	0.00082231	4.8392	0.0289
# CL I*CL III Desire to next waypoint	1	1	0.00021068	1.2398	0.2668
# CL I*CL II speed	1	1	0.00102309	6.0208	0.0150
# CL I*Mean(UAV with Hellfire)	1	1	0.00063128	3.7150	0.0553
# CL I*CL I and II Desire to Enemy	1	1	0.00043533	2.5619	0.1110
# CL I*CL I and II Desire to next waypoint	1	1	0.00183127	10.7768	0.0012
# CL I*CL II speed	1	1	0.00038213	2.2488	0.1353
# CL I*Mean(UAV with Hellfire)	1	1	0.00048603	2.8602	0.0923
# CL II*# Hellfire on Warrior	1	1	0.00743845	43.7743	<.0001
# CL II*# APKWS on CL III	1	1	0.02270333	133.6062	<.0001
# CL II*CL III Desire to next waypoint	1	1	0.00086755	5.1054	0.0249
# CL II*CL I speed	1	1	0.00166339	9.7888	0.0020
# CL II*CL II speed	1	1	0.00056333	3.3152	0.0701
# CL II*CL III speed	1	1	0.00026691	1.5707	0.2115
# CL II*Mean(UAV with Hellfire)	1	1	0.00047071	2.7701	0.0976
# Hellfire on Warrior*CL III Desire to next waypoint	1	1	0.00000185	0.0109	0.9169
# Hellfire on Warrior*CL III speed	1	1	0.00047631	2.8030	0.0956
# APKWS on CL III*sensor P(det) pt 0 CL III	1	1	0.00064554	3.7989	0.0527
# APKWS on CL III*CL III Desire to next waypoint	1	1	0.00038388	2.2591	0.1344
sensor P(det) pt 0 CL I*CL I and II Desire to next waypoint	1	1	0.00078562	4.6233	0.0327
sensor P(det) pt 0 CL I*CL III Desire to Enemy	1	1	0.00052860	3.1107	0.0793
sensor P(det) pt 0 CL II*CL II speed	1	1	0.00060837	3.5802	0.0599
sensor P(det) pt 0 CL III*CL III Desire to next waypoint	1	1	0.00056453	3.3222	0.0698
CL I and II Desire to Enemy *CL I and II Desire to next waypoint	1	1	0.00789132	46.4394	<.0001
CL I and II Desire to Enemy *CL II speed	1	1	0.00371778	21.8787	<.0001
CL I and II Desire to next waypoint*Mean(UAV with Hellfire)	1	1	0.00028738	1.6912	0.1949
CL III Desire to Enemy*Mean(UAV with Hellfire)	1	1	0.00031087	1.8295	0.1777
CL III Desire to next waypoint*Mean(UAV with Hellfire)	1	1	0.00068849	4.0516	0.0454
CL II speed*CL III speed	1	1	0.00061164	3.5994	0.0592
# CL I*# CL I	1	1	0.00884721	52.0647	<.0001
# CL II*# CL II	1	1	0.00287236	16.9034	<.0001
# APKWS on CL III*# APKWS on CL III	1	1	0.00644602	37.9340	<.0001
CL III Desire to next waypoint*CL III Desire to next waypoint	1	1	0.00062928	3.7032	0.0557
CL II speed*CL II speed	1	1	0.00298046	17.5396	<.0001

(Proportion of HPTs Killed at 450 seconds)



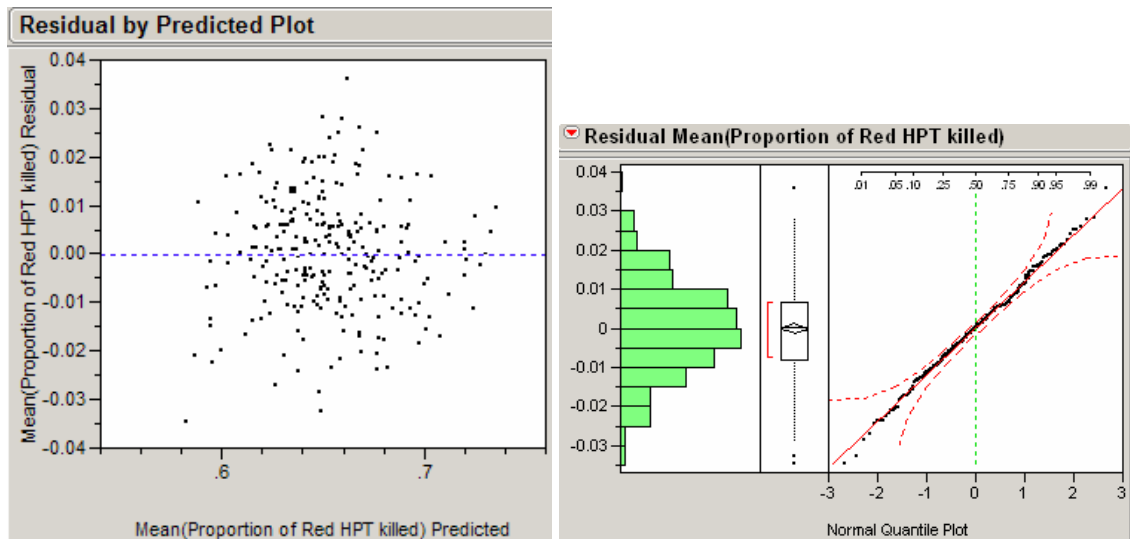
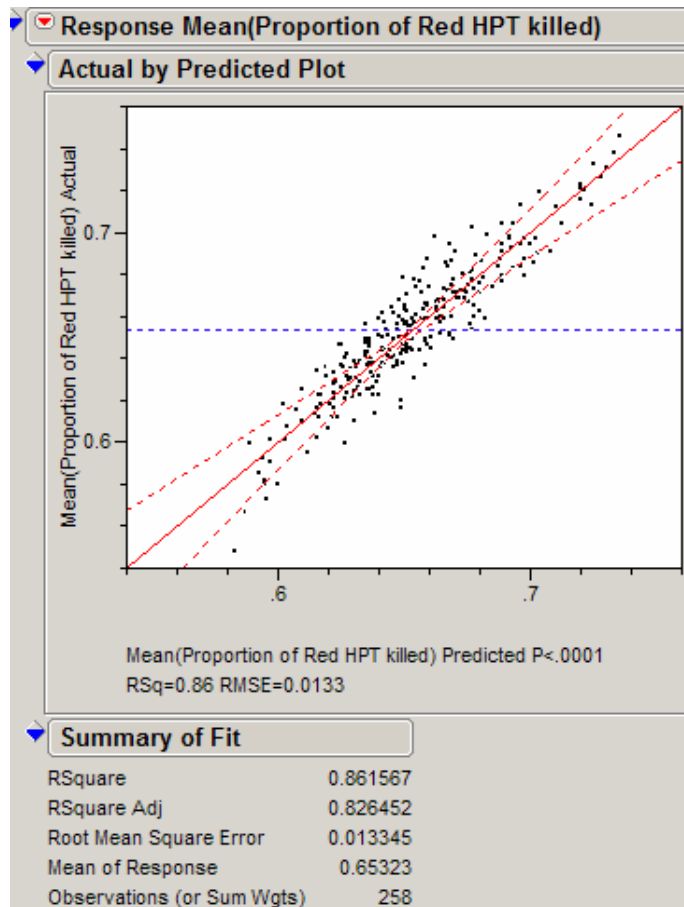

Figure 32. Regression Model (Proportion of HPTs Killed at 900 seconds)

(Note: Refer to the next two pages to view the Parameter Estimates and the Effects Test)

Parameter Estimates				
Term	Estimate	Std Error	t Ratio	Prob> t
Intercept	0.6067803	0.015409	39.38	<.0001
# CL I	0.0032887	0.000475	6.92	<.0001
# CL II	0.0034677	0.00047	7.38	<.0001
# CL III	0.0032533	0.00018	18.02	<.0001
# Hellfire on Warrior	0.0144575	0.00126	11.48	<.0001
# APKWS on CL III	0.0087121	0.001646	5.29	<.0001
sensor P(det) pt 0 CL II	-0.000002	0.000001	-1.40	0.1641
sensor P(det) pt 0 CL III	0.0000034	0.000001	2.87	0.0045
CL I and II Desire to Enemy	0.000645	0.000144	4.49	<.0001
CL I and II Desire to next waypoint	0.0010726	0.000145	7.41	<.0001
CL III Desire to next waypoint	0.000523	0.000144	3.62	0.0004
CL II speed	-0.000062	0.000027	-2.30	0.0226
CL III speed	-0.000013	0.000009	-1.38	0.1684
Mean(UAV with Hellfire)	-0.002192	0.004595	-0.48	0.6338
Mean(UAVs with APKWS)	-0.000704	0.006122	-0.11	0.9086
(# CL I-3.00775)*(# CL III-8.06202)	0.0006059	0.000158	3.84	0.0002
(# CL I-3.00775)*(sensor P(det) pt 0 CL II-1007.75)	-0.000001	0.000001	-1.38	0.1680
(# CL I-3.00775)*(sensor P(det) pt 0 CL III-1007.75)	-0.000002	0.000001	-2.06	0.0408
(# CL I-3.00775)*(CL III Desire to next waypoint-10.0155)	-0.000214	0.000105	-2.03	0.0437
(# CL II-3.00775)*(# CL III-8.06202)	-0.000337	0.000132	-2.54	0.0117
(# CL II-3.00775)*(sensor P(det) pt 0 CL II-1007.75)	-0.000002	8.391e-7	-2.09	0.0379
(# CL II-3.00775)*(CL III Desire to next waypoint-10.0155)	-0.000361	0.000121	-3.00	0.0031
(# CL III-8.06202)*(# Hellfire on Warrior-1.00775)	0.0010314	0.000261	3.95	0.0001
(# CL III-8.06202)*(# APKWS on CL III-2.0155)	0.0005105	0.000147	3.48	0.0006
(# CL III-8.06202)*(CL III Desire to next waypoint-10.0155)	0.0000789	0.000036	2.17	0.0309
(# CL III-8.06202)*(CL III speed-587.504)	0.0000028	0.000002	1.22	0.2229
(# CL III-8.06202)*(Mean(UAV with Hellfire)-0.43798)	0.0029541	0.00095	3.11	0.0021
(# CL III-8.06202)*(Mean(UAVs with APKWS)-0.46899)	0.0028044	0.000956	2.93	0.0037
(# APKWS on CL III-2.0155)*(CL I and II Desire to next waypoint-10.0155)	0.0000449	0.000055	0.81	0.4161
(# APKWS on CL III-2.0155)*(CL III Desire to next waypoint-10.0155)	0.0001369	0.000087	1.57	0.1178
(# APKWS on CL III-2.0155)*(CL III speed-587.504)	-0.000005	0.000004	-1.27	0.2051
(sensor P(det) pt 0 CL II-1007.75)*(sensor P(det) pt 0 CL III-1007.75)	-4.465e-9	2.318e-9	-1.93	0.0555
(sensor P(det) pt 0 CL II-1007.75)*(CL II speed-480.504)	-1.613e-7	5.144e-8	-3.14	0.0020
(sensor P(det) pt 0 CL II-1007.75)*(CL III speed-587.504)	-3.825e-8	1.656e-8	-2.31	0.0219
(sensor P(det) pt 0 CL III-1007.75)*(CL III Desire to next waypoint-10.0155)	1.3602e-7	2.161e-7	0.63	0.5298
(sensor P(det) pt 0 CL III-1007.75)*(CL II speed-480.504)	-4.718e-8	6.621e-8	-0.71	0.4769
(sensor P(det) pt 0 CL III-1007.75)*(CL III speed-587.504)	-3.188e-8	1.513e-8	-2.11	0.0364
(sensor P(det) pt 0 CL III-1007.75)*(Mean(UAV with Hellfire)-0.43798)	-0.000004	0.000002	-1.67	0.0956
(CL I and II Desire to Enemy -10.0155)*(CL I and II Desire to next waypoint-10.0155)	-0.000144	0.000028	-5.20	<.0001
(CL I and II Desire to Enemy -10.0155)*(CL II speed-480.504)	0.0000286	0.000006	4.90	<.0001
(CL I and II Desire to Enemy -10.0155)*(Mean(UAV with Hellfire)-0.43798)	0.0007858	0.000579	1.36	0.1761
(CL I and II Desire to Enemy -10.0155)*(Mean(UAVs with APKWS)-0.46899)	0.0010113	0.000573	1.77	0.0789
(CL I and II Desire to next waypoint-10.0155)*(CL II speed-480.504)	0.0000153	0.000006	2.56	0.0113
(CL III Desire to next waypoint-10.0155)*(Mean(UAV with Hellfire)-0.43798)	0.0011439	0.000439	2.61	0.0098
(CL II speed-480.504)*(CL III speed-587.504)	-8.396e-7	3.395e-7	-2.47	0.0142
(# CL I-3.00775)*(# CL I-3.00775)	-0.001664	0.000399	-4.17	<.0001
(# CL II-3.00775)*(# CL II-3.00775)	-0.001502	0.000369	-4.07	<.0001
(# CL III-8.06202)*(# CL III-8.06202)	-0.000056	0.000053	-1.07	0.2875
(# APKWS on CL III-2.0155)*(# APKWS on CL III-2.0155)	-0.000719	0.000337	-2.13	0.0341
(CL I and II Desire to next waypoint-10.0155)*(CL I and II Desire to next waypoint-10.0155)	-0.000092	0.000032	-2.87	0.0046
(CL III Desire to next waypoint-10.0155)*(CL III Desire to next waypoint-10.0155)	-0.000125	0.000035	-3.58	0.0004
(CL II speed-480.504)*(CL II speed-480.504)	0.0000026	0.000001	2.25	0.0257
(CL III speed-587.504)*(CL III speed-587.504)	3.211e-7	1.353e-7	2.37	0.0185

(Proportion of HPTs Killed at 900 seconds)

Effect Tests					
Source	Nparm	DF	Sum of Squares	F Ratio	Prob > F
# CL I	1	1	0.00853640	47.9356	<.0001
# CL II	1	1	0.00968946	54.4105	<.0001
# CL III	1	1	0.05785708	324.8926	<.0001
# Hellfire on Warrior	1	1	0.02345870	131.7308	<.0001
# APKWS on CL III	1	1	0.00498656	28.0017	<.0001
sensor P(det) pt 0 CL II	1	1	0.00034719	1.9496	0.1641
sensor P(det) pt 0 CL III	1	1	0.00146814	8.2442	0.0045
CL I and II Desire to Enemy	1	1	0.00358574	20.1355	<.0001
CL I and II Desire to next waypoint	1	1	0.00977570	54.8948	<.0001
CL III Desire to next waypoint	1	1	0.00233264	13.0988	0.0004
CL II speed	1	1	0.00093998	5.2784	0.0226
CL III speed	1	1	0.00034018	1.9103	0.1684
Mean(UAV with Hellfire)	1	1	0.00004053	0.2276	0.6338
Mean(UAVs with APKWS)	1	1	0.00000236	0.0132	0.9086
# CL I*# CL III	1	1	0.00262517	14.7415	0.0002
# CL I*sensor P(det) pt 0 CL II	1	1	0.00034094	1.9145	0.1680
# CL I*sensor P(det) pt 0 CL III	1	1	0.00075466	4.2378	0.0408
# CL I*CL III Desire to next waypoint	1	1	0.00073363	4.1197	0.0437
# CL I*# CL III	1	1	0.00115118	6.4643	0.0117
# CL I*sensor P(det) pt 0 CL II	1	1	0.00077707	4.3636	0.0379
# CL I*CL III Desire to next waypoint	1	1	0.00159820	8.9746	0.0031
# CL III*# Hellfire on Warrior	1	1	0.00278067	15.6146	0.0001
# CL III*# APKWS on CL III	1	1	0.00216089	12.1343	0.0006
# CL III*CL III Desire to next waypoint	1	1	0.00084122	4.7238	0.0309
# CL III*CL III speed	1	1	0.00026612	1.4944	0.2229
# CL III*Mean(UAV with Hellfire)	1	1	0.00172124	9.6655	0.0021
# CL III*Mean(UAVs with APKWS)	1	1	0.00153274	8.6070	0.0037
# APKWS on CL III*CL I and II Desire to next waypoint	1	1	0.00011822	0.6639	0.4161
# APKWS on CL III*CL III Desire to next waypoint	1	1	0.00043927	2.4667	0.1178
# APKWS on CL III*CL III speed	1	1	0.00028776	1.6159	0.2051
sensor P(det) pt 0 CL II*sensor P(det) pt 0 CL III	1	1	0.00066072	3.7102	0.0555
sensor P(det) pt 0 CL II*CL II speed	1	1	0.00175164	9.8362	0.0020
sensor P(det) pt 0 CL II*CL III speed	1	1	0.00095045	5.3372	0.0219
sensor P(det) pt 0 CL III*CL III Desire to next waypoint	1	1	0.00007053	0.3961	0.5298
sensor P(det) pt 0 CL III*CL II speed	1	1	0.00009043	0.5078	0.4769
sensor P(det) pt 0 CL III*CL III speed	1	1	0.00079008	4.4367	0.0364
sensor P(det) pt 0 CL III*Mean(UAV with Hellfire)	1	1	0.00049931	2.8039	0.0956
CL I and II Desire to Enemy *CL I and II Desire to next waypoint	1	1	0.00482058	27.0696	<.0001
CL I and II Desire to Enemy *CL II speed	1	1	0.00427016	23.9788	<.0001
CL I and II Desire to Enemy *Mean(UAV with Hellfire)	1	1	0.00032824	1.8432	0.1761
CL I and II Desire to Enemy *Mean(UAVs with APKWS)	1	1	0.00055530	3.1182	0.0789
CL I and II Desire to next waypoint*CL II speed	1	1	0.00116506	6.5423	0.0113
CL III Desire to next waypoint*Mean(UAV with Hellfire)	1	1	0.00120958	6.7923	0.0098
CL II speed*CL III speed	1	1	0.00108913	6.1160	0.0142
# CL I*# CL I	1	1	0.00309483	17.3788	<.0001
# CL II*# CL II	1	1	0.00295241	16.5790	<.0001
# CL III*# CL III	1	1	0.00020249	1.1371	0.2875
# APKWS on CL III*# APKWS on CL III	1	1	0.00080995	4.5482	0.0341
CL I and II Desire to next waypoint*CL I and II Desire to next waypoint	1	1	0.00146404	8.2212	0.0046
CL III Desire to next waypoint*CL III Desire to next waypoint	1	1	0.00228035	12.8052	0.0004
CL II speed*CL II speed	1	1	0.00089935	5.0502	0.0257
CL III speed*CL III speed	1	1	0.00100324	5.6336	0.0185

(Proportion of HPTs Killed at 900 seconds)

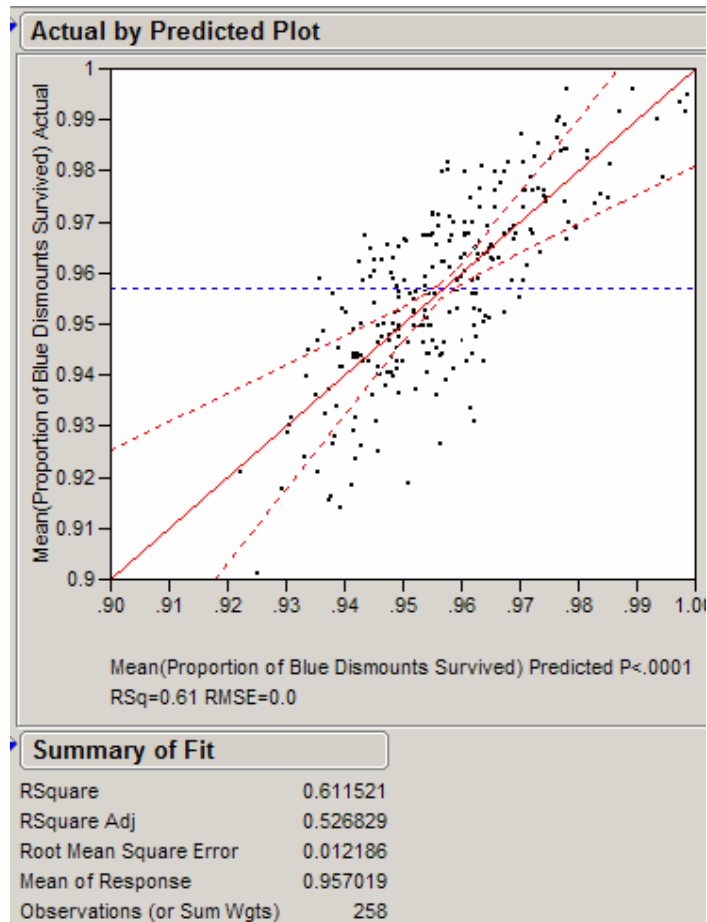

Figure 33. Regression Model (Proportion of Dismounts Survived at 900 seconds)

(Note: Refer to the next two pages to view the Parameter Estimates and the Effects Test)

Parameter Estimates				
Term	Estimate	Std Error	t Ratio	Prob> t
Intercept	0.9470148	0.014976	63.23	<.0001
# CL I	0.0022151	0.000429	5.16	<.0001
# CL II	-0.001024	0.000428	-2.39	0.0176
# CL III	0.0002931	0.000164	1.79	0.0751
# Hellfire on Warrior	0.0044275	0.001147	3.86	0.0002
# APKWS on CL III	0.0007367	0.000516	1.43	0.1549
sensor P(det) pt 0 CL I	6.5653e-8	0.000001	0.06	0.9519
sensor P(det) pt 0 CL II	7.1694e-7	0.000001	0.66	0.5086
sensor P(det) pt 0 CL III	-9.714e-7	0.000001	-0.89	0.3757
CL I and II Desire to Enemy	0.0000276	0.000131	0.21	0.8339
CL I and II Desire to next waypoint	0.0012759	0.000132	9.64	<.0001
CL III Desire to Enemy	-0.000167	0.000131	-1.28	0.2033
CL III Desire to next waypoint	-0.000045	0.000131	-0.34	0.7305
CL I speed	0.0000117	0.000023	0.50	0.6148
CL II speed	-0.000025	0.000025	-1.01	0.3128
Mean(UAV with Hellfire)	-0.000914	0.004085	-0.22	0.8233
Mean(UAVs with APKWS)	0.0044578	0.003714	1.20	0.2314
(# CL I-3.00775)*(sensor P(det) pt 0 CL III-1007.75)	-0.000001	7.62e-7	-1.73	0.0855
(# CL I-3.00775)*(CL I and II Desire to next waypoint-10.0155)	0.0003595	0.000076	4.72	<.0001
(# CL I-3.00775)*(CL III Desire to Enemy-10.0155)	0.00015	0.000082	1.82	0.0703
(# CL I-3.00775)*(CL I speed-317.504)	0.0000491	0.000015	3.30	0.0011
(# CL II-3.00775)*(# APKWS on CL III-2.0155)	0.0005754	0.000159	3.63	0.0004
(# CL II-3.00775)*(CL III Desire to Enemy-10.0155)	-0.000221	0.000098	-2.25	0.0257
(# CL II-3.00775)*(CL I speed-317.504)	-0.000026	0.000015	-1.76	0.0807
(# CL II-3.00775)*(CL II speed-480.504)	-0.000072	0.000016	-4.37	<.0001
(# CL III-8.06202)*(# Hellfire on Warrior-1.00775)	0.0007959	0.00016	4.97	<.0001
(# CL III-8.06202)*(# APKWS on CL III-2.0155)	0.0003299	0.000086	3.82	0.0002
(# CL III-8.06202)*(CL III Desire to next waypoint-10.0155)	0.0001204	0.000033	3.68	0.0003
(# Hellfire on Warrior-1.00775)*(sensor P(det) pt 0 CL II-1007.75)	-0.000001	8.515e-7	-1.37	0.1712
(# Hellfire on Warrior-1.00775)*(CL I and II Desire to Enemy -10.0155)	-0.00022	0.0001	-2.20	0.0288
(# Hellfire on Warrior-1.00775)*(CL I and II Desire to next waypoint-10.0155)	-0.000209	0.0001	-2.08	0.0386
(sensor P(det) pt 0 CL I-1007.75)*(CL III Desire to next waypoint-10.0155)	-4.395e-7	2.574e-7	-1.71	0.0893
(sensor P(det) pt 0 CL I-1007.75)*(Mean(UAV with Hellfire)-0.43798)	0.0000104	0.000004	2.36	0.0192
(sensor P(det) pt 0 CL I-1007.75)*(Mean(UAVs with APKWS)-0.46899)	0.0000122	0.000004	2.80	0.0056
(sensor P(det) pt 0 CL I-1007.75)*(CL I speed-317.504)	-5.093e-8	3.301e-8	-1.54	0.1244
(sensor P(det) pt 0 CL II-1007.75)*(CL II speed-480.504)	-8.985e-8	4.687e-8	-1.92	0.0566
(sensor P(det) pt 0 CL III-1007.75)*(CL III Desire to Enemy-10.0155)	3.7147e-7	2.245e-7	1.65	0.0995
(sensor P(det) pt 0 CL III-1007.75)*(CL III Desire to next waypoint-10.0155)	5.6055e-7	2.07e-7	2.71	0.0073
(CL I and II Desire to Enemy -10.0155)*(CL I speed-317.504)	-0.00001	0.000005	-2.03	0.0436
(CL I and II Desire to next waypoint-10.0155)*(CL III Desire to next waypoint-10.0155)	0.0000401	0.000026	1.54	0.1242
(CL III Desire to Enemy-10.0155)*(CL II speed-480.504)	-0.00002	0.000005	-3.67	0.0003
(CL III Desire to Enemy-10.0155)*(Mean(UAVs with APKWS)-0.46899)	-0.000486	0.000263	-1.85	0.0658
(CL III Desire to next waypoint-10.0155)*(Mean(UAV with Hellfire)-0.43798)	-0.000402	0.000271	-1.48	0.1397
(# CL II-3.00775)*(# CL II-3.00775)	-0.00096	0.000318	-3.02	0.0028
(# CL III-8.06202)*(# CL III-8.06202)	0.0000958	0.000043	2.23	0.0266
(sensor P(det) pt 0 CL I-1007.75)*(sensor P(det) pt 0 CL II-1007.75)	-3.072e-9	1.758e-9	-1.75	0.0820
(CL III Desire to next waypoint-10.0155)*(CL III Desire to next waypoint-10.0155)	-0.000094	0.000029	-3.21	0.0015

(Proportion of Dismounts Survived at 900 seconds)

Effect Tests					
Source	Nparm	DF	Sum of Squares	F Ratio	Prob > F
# CL I	1	1	0.00395259	26.6190	<.0001
# CL II	1	1	0.00084982	5.7232	0.0176
# CL III	1	1	0.00047518	3.2001	0.0751
# Hellfire on Warrior	1	1	0.00221210	14.8976	0.0002
# APKWS on CL III	1	1	0.00030263	2.0381	0.1549
sensor P(det) pt 0 CL I	1	1	0.00000054	0.0036	0.9519
sensor P(det) pt 0 CL II	1	1	0.00006511	0.4385	0.5086
sensor P(det) pt 0 CL III	1	1	0.00011701	0.7880	0.3757
CL I and II Desire to Enemy	1	1	0.00000655	0.0441	0.8339
CL I and II Desire to next waypoint	1	1	0.01380635	92.9799	<.0001
CL III Desire to Enemy	1	1	0.00024182	1.6286	0.2033
CL III Desire to next waypoint	1	1	0.00001766	0.1190	0.7305
CL I speed	1	1	0.00003772	0.2540	0.6148
CL II speed	1	1	0.00015201	1.0238	0.3128
Mean(UAV with Hellfire)	1	1	0.00000742	0.0500	0.8233
Mean(UAVs with APKWS)	1	1	0.00021391	1.4406	0.2314
# CL I*sensor P(det) pt 0 CL III	1	1	0.00044334	2.9857	0.0855
# CL I*CL I and II Desire to next waypoint	1	1	0.00330957	22.2885	<.0001
# CL I*CL III Desire to Enemy	1	1	0.00049154	3.3103	0.0703
# CL I*CL I speed	1	1	0.00162097	10.9166	0.0011
# CL II*APKWS on CL III	1	1	0.00195475	13.1644	0.0004
# CL II*CL III Desire to Enemy	1	1	0.00074921	5.0456	0.0257
# CL II*CL I speed	1	1	0.00045740	3.0804	0.0807
# CL II*CL II speed	1	1	0.00283011	19.0596	<.0001
# CL III*Hellfire on Warrior	1	1	0.00366544	24.6852	<.0001
# CL III*APKWS on CL III	1	1	0.00216560	14.5844	0.0002
# CL III*CL III Desire to next waypoint	1	1	0.00200730	13.5183	0.0003
# Hellfire on Warrior*sensor P(det) pt 0 CL II	1	1	0.00027995	1.8853	0.1712
# Hellfire on Warrior*CL I and II Desire to Enemy	1	1	0.00071918	4.8434	0.0288
# Hellfire on Warrior*CL I and II Desire to next waypoint	1	1	0.00064315	4.3313	0.0386
sensor P(det) pt 0 CL I*CL III Desire to next waypoint	1	1	0.00043273	2.9142	0.0893
sensor P(det) pt 0 CL I*Mean(UAV with Hellfire)	1	1	0.00082674	5.5678	0.0192
sensor P(det) pt 0 CL I*Mean(UAVs with APKWS)	1	1	0.00116278	7.8308	0.0056
sensor P(det) pt 0 CL II*CL I speed	1	1	0.00035334	2.3796	0.1244
sensor P(det) pt 0 CL II*CL II speed	1	1	0.00054562	3.6745	0.0566
sensor P(det) pt 0 CL III*CL III Desire to Enemy	1	1	0.00040657	2.7380	0.0995
sensor P(det) pt 0 CL III*CL III Desire to next waypoint	1	1	0.00108860	7.3313	0.0073
CL I and II Desire to Enemy *CL I speed	1	1	0.00061199	4.1215	0.0436
CL I and II Desire to next waypoint*CL III Desire to next waypoint	1	1	0.00035383	2.3829	0.1242
CL III Desire to Enemy*CL II speed	1	1	0.00199786	13.4548	0.0003
CL III Desire to Enemy*Mean(UAVs with APKWS)	1	1	0.00050784	3.4201	0.0658
CL III Desire to next waypoint*Mean(UAV with Hellfire)	1	1	0.00032639	2.1981	0.1397
# CL II*CL II	1	1	0.00135397	9.1184	0.0028
# CL III*CL III	1	1	0.00074055	4.9873	0.0266
sensor P(det) pt 0 CL II*sensor P(det) pt 0 CL II	1	1	0.00045346	3.0539	0.0820
CL III Desire to next waypoint*CL III Desire to next waypoint	1	1	0.00153248	10.3206	0.0015

(Proportion of Dismounts Survived at 900 seconds)

## C. INTERACTIONS

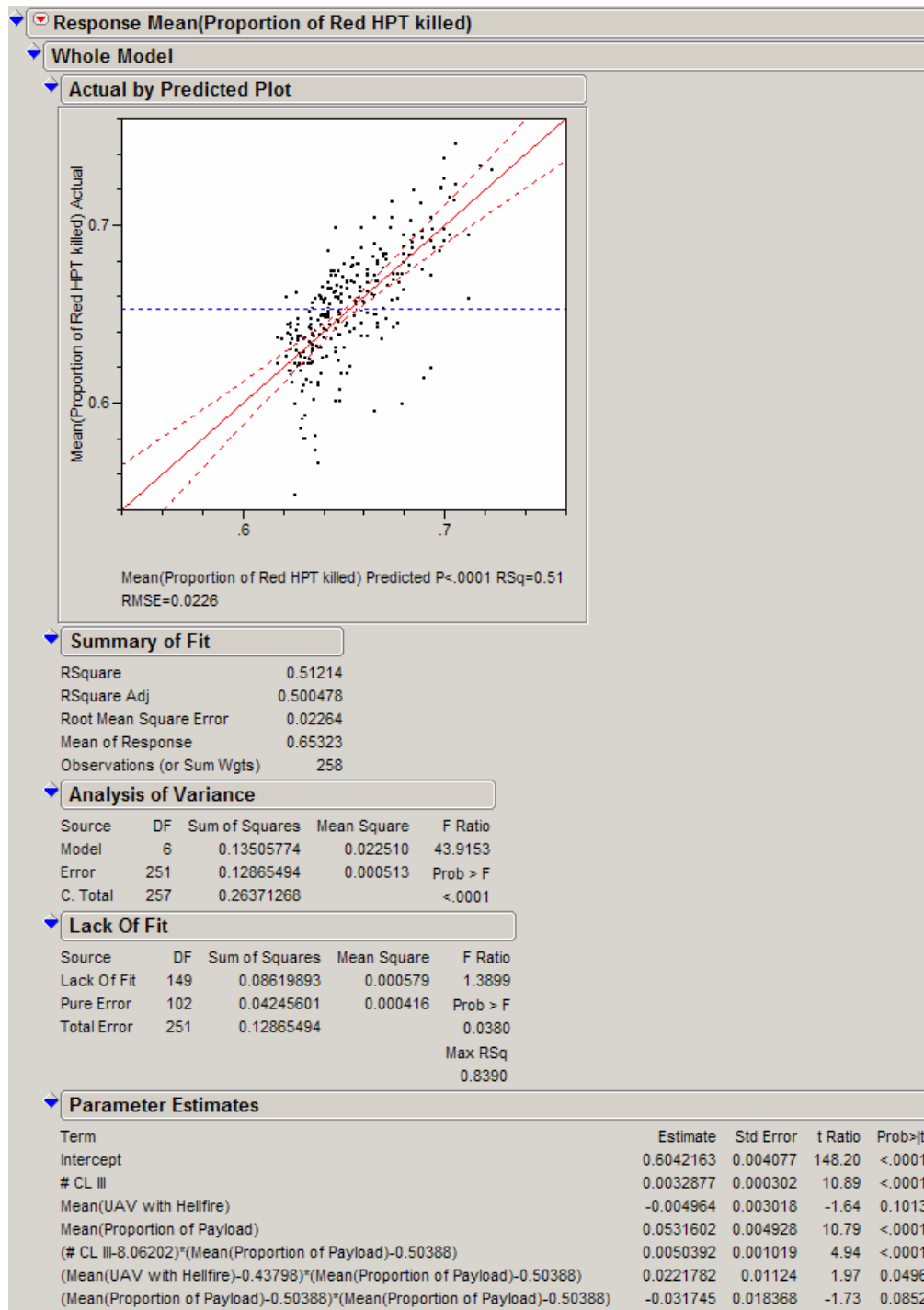

Figure 34. Determine Interactions Model, MOE: Proportion of HPTs Killed

(Note: Refer to the next page for the Effects Test and the Interaction Profiles)

**Effect Tests**

Source	Nparm	DF	Sum of Squares	F Ratio	Prob > F
# CL III	1	1	0.06078875	118.5961	<.0001
Mean(UAV with Hellfire)	1	1	0.00138657	2.7051	0.1013
Mean(Proportion of Payload)	1	1	0.05963941	116.3538	<.0001
# CL III*Mean(Proportion of Payload)	1	1	0.01252380	24.4334	<.0001
Mean(UAV with Hellfire)*Mean(Proportion of Payload)	1	1	0.00199542	3.8930	0.0496
Mean(Proportion of Payload)*Mean(Proportion of Payload)	1	1	0.00153095	2.9868	0.0852

**Residual by Predicted Plot**

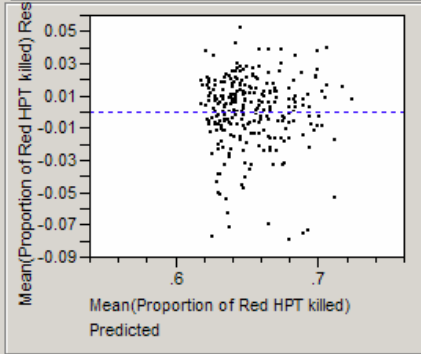

**Interaction Profiles**

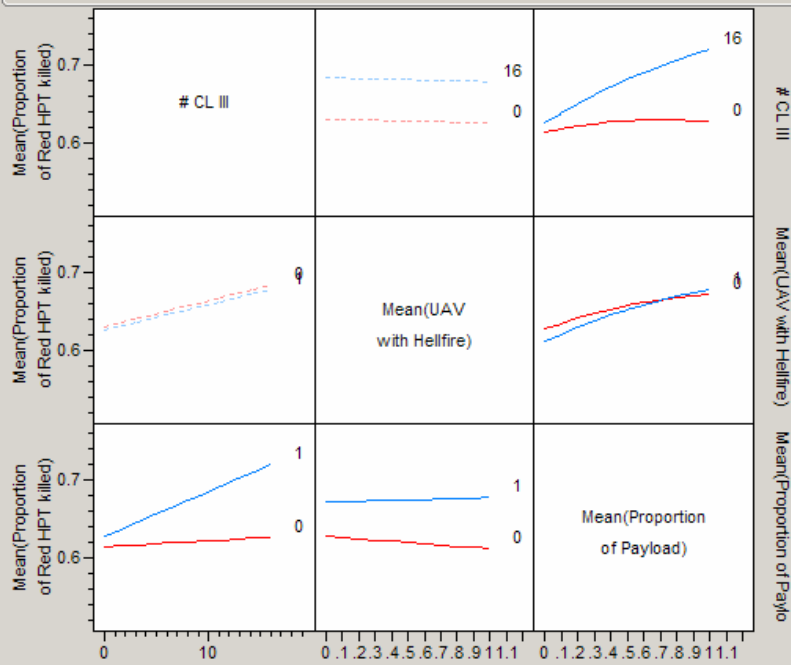



## LIST OF REFERENCES

Boeing, *Future Combat Systems*, Retrieved 15 November 2005 from the World Wide Web at <http://www.boeing.com/defense-space/ic/fcs/bia/about.html>

Boeing, *Future Combat Systems*, Retrieved 5 August 2005 from the World Wide Web at <http://www.boeing.com/defense-space/ic/fcs/bia/about.html>

Boeing, *Future Combat Systems*, Retrieved 5 August 2005 from the World Wide Web at <http://www.boeing.com/defense-space/ic/fcs/bia/about.html>

Brigade and Below Scenario (BBS) slide show, March 2005, provided by Mr. Tom Loncarich, TRAC-WSMR during office visit 25 June 2005.

Cioppa, Thomas M., *Efficient Nearly Orthogonal and Space-Filling Experimental Designs for High-Dimensional Complex Models*, (PhD. Dissertation, Operations Research Department, Naval Postgraduate School, Monterey, CA), 2002.

Department of Defense, Memorandum for Secretaries of the Military Departments, Subject: Unmanned Aircraft Systems (UAS) Roadmap, 2005 -2015, 4 August 2005.

Department of the Navy, Office of the Chief of Naval Operations, Integration of Unmanned Vehicles into Maritime Missions, TM 3-22-5-SW, chap. 2, p. 4.

Devore, Jay L., *Probability and Statistics for Engineering and the Sciences, Sixth Edition*, (Brooks/Cole, 2004), pp. 497-587.

Examining the Army's Future Warrior, Force-on-Force Simulation of Candidate Technologies, Rand Arroyo Center, 2004, p. xi.

FAS Military Analysis Network, *AH-64 Apache*, Retrieved 22 September 2005, from the World Wide Web at <http://www.fas.org/man/dod-101/sys/ac/ah-64.htm>

FAS Military Analysis Network, *AT-7*, Retrieved 23 September 2005, from the World Wide Web at <http://www.fas.org/man/dod-101/sys/land/row/at-7.htm>

FAS Military Analysis Network, *BTR-80*, Retrieved 11 October 2005, from the World Wide Web at <http://www.fas.org/man/dod-101/sys/land/row/btr-80.htm>

FAS Military Analysis Network, *Joint Strike Fighter*, Retrieved 22 September 2005, from the World Wide Web at <http://www.fas.org/man/dod-101/sys/ac/jsf.htm>

FAS Military Analysis Network, *Mortars*, Retrieved 23 September 2005, from the World Wide Web at <http://www.fas.org/man/dod-101/sys/land/mortars.htm>

FAS Military Analysis Network, *SA-16 Gimlet*, Retrieved 23 September 2005, from the World Wide Web at <http://www.fas.org/man/dod-101/sys/missile/row/sa-16.htm>

FAS Military Analysis Network, *T-72*, Retrieved 23 September 2005, from the World Wide Web at <http://www.fas.org/man/dod-101/sys/land/row/t72tank.htm>

Federation of American Scientists, Retrieved 22 September, from the World Wide Web at <http://www.fas.org/main/home.jsp> .

Galligan, David P., Mark A. Anderson, Michael K. Lauren, *Map Aware, Non-Uniform Automata version 3.0*, New Zealand Defense Technology, July 2004.

Global Security.org *Future Combat Systems*, Retrieved 17 November 2005 from the World Wide Web at <http://www.globalsecurity.org/military/systems/ground/images/fcs-2005armymodernization.jpg>

Global Security.org *Future Combat Systems*, Retrieved 3 August 2005 from the World Wide Web at <http://www.globalsecurity.org/military/systems/ground/fcs.htm>

Global Security.org, *Future Combat Systems – Background*, Retrieved 28 June 2005 from the World Wide Web at <http://www.globalsecurity.org/military/systems/ground/fcs-back.htm>

Global Security.org, *Future Combat Systems*, Retrieved 1 August 2005 from the World Wide Web at <http://www.globalsecurity.org/military/systems/ground/fcs.htm>

Global Security.org, *Hellfire, Getting the Most from a Lethal Weapon System*, Retrieved 7 October 2005 on the World Wide Web at <http://www.globalsecurity.org/military/library/news/1998/01/1helfire.pdf>

Grant, Greg, "Army picks General Atomics for ERMP program," Army Times, 8 Aug 2005, Retrieved 11 October 2005 from the World Wide Web at <http://www.armytimes.com/story.php?f=1-292925-1021240.php>

Hand, David, Heikki Mannila, and Padhraic Smyth, *Principles of Data Mining*, (MIT Press, Cambridge, Massachusetts, 2001), p. 53.

Headquarters United States Army Training and Doctrine Command (Director Futures Center), Memorandum for U.S. Army TRADOC Analysis Center, Fort Leavenworth, KS, 9 July 2004.

Interview with Thomas Lancarich, Senior Operations Research Analyst, Chief, Scenario Integration & Methodology Development Division, TRADOC Analysis Center-White Sands Missile Range, New Mexico, 25 June 2005.

Interview with Jeffrey Schamburg, LTC, Director, TRADOC Analysis Center-Monterey, Naval Postgraduate School, Monterey California, 15 August 2005.

JMP IN, *JMP 5.5.2 Help Command*, SAS Institute Inc, 2004.

*JMP Start Statistics, A Guide to Statistics and Data Analysis using JMP and JMP IN Software, Third Edition*, (SAS Institute Inc. 2005) p. 245.

JMP, The Statistical Discovery Software, referenced 18 October 2005 on the World Wide Web at [http://www.jmp.com/product/jmp5\\_brochure.pdf](http://www.jmp.com/product/jmp5_brochure.pdf)

Kenneth Munson, *Jane's Unmanned Aerial Vehicles and Targets: Issue Twenty-Three*, (Alexandria: Jane's Information Group Inc, 2004), p. 20.

Lester W. Grau, *For All Seasons: The Old But Effective RPG-7 Promises to Haunt the Battlefields of Tomorrow*, Foreign Military Studies Office, Fort Leavenworth, KS Retrieved 23 September 2005 from the World Wide Web at <http://www.g2mil.com/RPG.htm>

Lloyd Brown, Thomas Cioppa, and Thomas Lucas, "Agent-Based Simulations Supporting Military Analysis," Phalnex, April 2004.

Lucas, Thomas, OA4655 Combat Modeling, Naval Postgraduate School, lecture presentation: Entity-level Attrition: Some Phit and Pkill Algorithms.

Montgomery, Douglas, Elizabeth Peck, and Geoffrey Vining, *Introduction to Linear Regression Analysis, Third Edition*, (John Wiley and Sons, Inc, 2001), p. 516.

Naval Postgraduate School, NOLH 17-22 Factors, coded by Professor Susan Sanchez, Monterey, California. Retrieved 15 August 2005 from the World Wide Web at [http://nps.blackboard.com/webapps/portal/frameset.jsp?tab=courses&url=/bin/common/course.pl?course\\_id=3888\\_1](http://nps.blackboard.com/webapps/portal/frameset.jsp?tab=courses&url=/bin/common/course.pl?course_id=3888_1)

Naval Postgraduate School, PatchExcursion.rb, coded by Professor Paul Sanchez, Monterey, California.

Naval Postgraduate School Thesis, An Analysis of Degraded Communications in the Army's Future Force using Agent Based Modeling, Joseph M. Lindquist, June 2004, pp. 2-3.

Naval Postgraduate School Thesis, Comparison of a Distributed Operations Force to a Traditional Force in Urban Combat, Michael Babilot, September 2005, Excel Spreadsheet.

Peter P. Perla, The Art of War-Gamming, United States Naval Institute, Annapolis, Maryland, 1990, p. 15.

Presentation to the CSA on the FCS *Brigade Combat Team Operational & Organizational Plan*, by US Army Futures Center, TRADOC, 7 October 2005.

Retrieved 23 September 2005 from the World Wide Web at [http://www.sovietarmy.com/small\\_arms/rpk-74.html](http://www.sovietarmy.com/small_arms/rpk-74.html)

Stephen Cambone, Kenneth Krieg, Peter Pace, Linton Wells, Unmanned Aircraft System Roadmap 2005-2015, Department of Defense, 4 August 2005, p. 1.

Thomas Lancarich, Senior Operations Research Analyst, Chief, Scenario Integration & Methodology Development Division, TRADOC Analysis Center-White Sands Missile Range, New Mexico *North East Asia Vignettes (Vignette NEA50.2) FCS BN(-) attack vs enemy stronghold of city, May 2005.*

Unit of Action Maneuver Battle Lab, *Change 1, to Joint Requirements Oversight Council (JROC) – approved Future Combat Systems (FCS) Operational Requirements Document (ORD)*, June 2004, Fort Knox, KY 40121, Annex E.

Unit of Action Maneuver Battle Lab, *Change 3, to TRADOC Pamphlet 525-3-90 O&O, The United States Future Force Operational and Organizational Plan Maneuver Unit of Action (DRAFT)*, 30 July 2004, Fort Knox, KY 40121, section 3.2, p.18.

Unit of Action Maneuver Battle Lab, TRADOC Pam 525-3-90, Future Force Operational and Organization Plan, Maneuver Unit Action, with Change 3, Fort Knox, KY, 30 July 2004.

United States Department of Defense, *Predator UAV Proves its Worth*, Retrieved 10 August 2005 from the World Wide Web at <http://usmilitary.about.com/cs/afweapons/a/preditor.htm>

US Army Material Systems Analysis Activity (US AMSAA), Army Future Combat Systems Unit of Action Systems Book Version 3.0, 22 May 2003.

US Army Material Systems Analysis Activity (US AMSAA), FCS UA Design Concept Baseline Description (UA-001-01-050124), 3 March 2005.

US Army Training and Doctrine Command, *The Army Future Force: Decisive 21<sup>st</sup> Century Landpower Strategically Responsive Full Spectrum Dominate*. pp. 4-5.

W3C, Extensible Markup Language, referenced 18 October 2005 from the World Wide Web at <http://www.w3.org/XML/>

Wikipedia.org, Ruby Programming Language, referenced 18 October 2005 on the World Wide Web at [http://en.wikipedia.org/wiki/Ruby\\_programming\\_language](http://en.wikipedia.org/wiki/Ruby_programming_language)

Zaloga, Steven J. *BMP Infantry Combat Vehicle*, 2nd Ed, Concord Publications, 1990, Hong Kong.

THIS PAGE INTENTIONALLY LEFT BLANK

## INITIAL DISTRIBUTION LIST

1. Defense Technical Information Center  
Ft. Belvoir, Virginia
2. Dudley Knox Library  
Naval Postgraduate School  
Monterey, California
3. Professor Thomas Lucas  
Naval Postgraduate School  
Monterey, CA
4. LTC Jeffrey Schamburg  
TRAC-MTRY  
Monterey, CA
5. Dr. Gary Horne  
USMC Project Albert  
Quantico, VA
6. COL Gary Krahn  
Department of Mathematical Sciences  
United States Military Academy  
West Point, NY
7. Joseph Lindquist  
Department of Mathematical Sciences  
United States Military Academy  
West Point, NY
8. Charles A. Sulewski  
Naval Postgraduate School  
Monterey, CA
9. Thomas Loncarich  
TRAC-WSMR  
White Sands Missile Range, NM
10. Dr. Lucy Nowell  
Advanced Research & Development Activity  
Ft. Meade, MD

11. Dr. Francis Hughes  
Defense Intelligence Agency  
Bolling AFB, Washington, DC

12. Heather A. McMonagle  
National Security Agency  
Ft. Meade, MD

13. Dawn M. Dentato  
Somers High School  
Somers, NY

14. Michael Landin  
FDIC Analysis Division  
Ft. Sill, OK