

UNCLASSIFIED



WATERTOWN ARSENAL LABORATORY

REPORT

NO. WAL 762/582(c)

TECHNICAL INFORMATION SECTION
DEVELOPMENT & PROOF SERVICES
WATERTOWN ARSENAL

METALLURGICAL EXAMINATION OF SOVIET 45MM, 57MM, AND 85MM
APHE PROJECTILES, FMAM 1121, 1935, AND 2175

BY

C. A. RIDDLE
Physical Science Aide

A. HURLICH
Metallurgist

UNCLASSIFIED

DATE 6 August 1952

WATERTOWN ARSENAL
WATERTOWN, MASS.

SECURITY INFORMATION

APPROVED FOR PUBLIC RELEASE;
DISTRIBUTION IS UNLIMITED

Report Documentation Page

Form Approved
OMB No. 0704-0188

Public reporting burden for the collection of information is estimated to average 1 hour per response, including the time for reviewing instructions, searching existing data sources, gathering and maintaining the data needed, and completing and reviewing the collection of information. Send comments regarding this burden estimate or any other aspect of this collection of information, including suggestions for reducing this burden, to Washington Headquarters Services, Directorate for Information Operations and Reports, 1215 Jefferson Davis Highway, Suite 1204, Arlington VA 22202-4302. Respondents should be aware that notwithstanding any other provision of law, no person shall be subject to a penalty for failing to comply with a collection of information if it does not display a currently valid OMB control number.

| | | | | | |
|---|------------------------------------|-------------------------------------|---|--|---------------------------------|
| 1. REPORT DATE 06 AUG 1952 | | 2. REPORT TYPE N/A | | 3. DATES COVERED - | |
| 4. TITLE AND SUBTITLE Metallurgical Examination of Soviet 45mm, 57mm, and 85mm APHE Projectiles FMAM 1121, 1935, and 2175 | | | | 5a. CONTRACT NUMBER | |
| | | | | 5b. GRANT NUMBER | |
| | | | | 5c. PROGRAM ELEMENT NUMBER | |
| 6. AUTHOR(S) | | | | 5d. PROJECT NUMBER | |
| | | | | 5e. TASK NUMBER | |
| | | | | 5f. WORK UNIT NUMBER | |
| 7. PERFORMING ORGANIZATION NAME(S) AND ADDRESS(ES) Watertown Arsenal, Watertown, MA | | | | 8. PERFORMING ORGANIZATION REPORT NUMBER | |
| 9. SPONSORING/MONITORING AGENCY NAME(S) AND ADDRESS(ES) | | | | 10. SPONSOR/MONITOR'S ACRONYM(S) | |
| | | | | 11. SPONSOR/MONITOR'S REPORT NUMBER(S) | |
| 12. DISTRIBUTION/AVAILABILITY STATEMENT Approved for public release, distribution unlimited | | | | | |
| 13. SUPPLEMENTARY NOTES | | | | | |
| 14. ABSTRACT | | | | | |
| 15. SUBJECT TERMS | | | | | |
| 16. SECURITY CLASSIFICATION OF: | | | 17. LIMITATION OF ABSTRACT UU | 18. NUMBER OF PAGES 42 | 19a. NAME OF RESPONSIBLE PERSON |
| a. REPORT unclassified | b. ABSTRACT unclassified | c. THIS PAGE unclassified | | | |



DEPARTMENT OF THE ARMY
US ARMY RESEARCH, DEVELOPMENT AND ENGINEERING COMMAND
ARMY RESEARCH LABORATORY
ABERDEEN PROVING GROUND MD 21005-5066

AMSRD-ARL-O-IO-SC (APG) (380)

28 October 2005

MEMORANDUM FOR SEE DISTRIBUTION

SUBJECT: Distribution Statement - Watertown Arsenal Laboratory
Report No. 762/582

1. Reference: Watertown Arsenal Laboratory Report No. 762/582, "Metallurgical Examination of Soviet 45MM, 57MM, and 85MM APHE Projectiles, FMAM 1121, 1935, and 2175" by C. A. Riddle and A. Hurleigh, 6 August 1952, UNCLASSIFIED.

2. Subject matter experts and the Army Research Laboratory Security/CI Office have determined that the subject report may be released to the public. Request that you mark all of your copies of the document with the following distribution statement:

APPROVED FOR PUBLIC RELEASE; DISTRIBUTION IS UNLIMITED

3. Questions should be directed to Mr. Douglas J. Kingsley at telephone 410-278-6960.

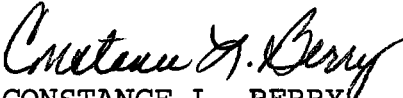
CONSTANCE L. BERRY
Team Leader
Security/CI Office

ARL-APG DISTRIBUTION

Chief, Materials Division, WMRD
ATTN: Dr. Steve McKnight

Chief, ARL Technical Library - APG
ATTN: Ms. L. LeTendre

~~CONFIDENTIAL~~

~~CONFIDENTIAL~~

TITLE

METALLURGICAL EXAMINATION OF SOVIET 45MM, 57MM, and 85MM
APHE PROJECTILES, FMAM 1121, 1935, and 2175

Report Number: WAL 762/582(c)

O. O. Project Number: TB3-0035

C. A. RIDDLE
PHYSICAL SCIENCE AIDE

A. HURLICH
METALLURGIST

TECHNICAL INFORMATION SECTION
DEVELOPMENT & PROOF SERVICES
ARLINGTON HALL

~~CONFIDENTIAL~~

~~CONFIDENTIAL~~

WATERTOWN ARSENAL LABORATORY

6 August 1952

Authorized by: ORDTB
O. O. Project Number: TB3-0035
Report Number: WAL 762/582(c)
Priority: 2A
Title of O. O. Project: Evaluation of Captured Enemy Ordnance Materiel
Filing Title: Armor-Piercing Projectiles, Foreign

TITLE

METALLURGICAL EXAMINATION OF SOVIET 45MM, 57MM, and 85MM
APHE PROJECTILES, FMAM 1121, 1935, and 2175

OBJECT

To conduct a metallurgical examination of the subject projectiles and to evaluate their design, manufacture, and performance characteristics.

SUMMARY

Complete engineering drawings were made of each projectile after which they were subjected to metallurgical examination including chemical analyses, hardness surveys, and macroscopic and microscopic examination of all components. The bodies of the shot were made from medium carbon manganese silicon-chromium steel. The 45MM and 85MM shot were machined from bar-stock while the ogive of the 57MM shot was hot formed. The 45MM and 57MM shot were uniformly heat treated to a hardness of approximately Rockwell C 50-55 while the 85MM shot was decrementally hardened from Rockwell C 46-50 at the nose to Rockwell C 25 at the base. All shot bodies were deeply notched circumferentially above or below the bourrelet, the two smaller caliber shot with two notches and the 85MM shot with one notch. The nose of the 45MM shot was flat with slightly rounded edges, that of the 57MM shot was knob shaped while the 85MM shot had a conventional ogival nose. The 45MM and 57MM shot were fitted with deep drawn low carbon steel ogival windshields which were crimped into grooves knurled into the forward end of the shot. The 45MM shot was fitted with a single copper rotating band and the 57MM and 85MM shot with double copper rotating bands. All band seats were undercut from 15° to 20°.

~~CONFIDENTIAL~~

~~CONFIDENTIAL~~

CONCLUSIONS

1. The design and metallurgical characteristics of the three Soviet shot are radically different from American projectiles in the following particulars:

a. The 45MM and 57MM shot are very blunt nosed and are fitted with windshields. These shot were probably designed for maximum effectiveness against moderately thin highly sloped armor targets and may have been designed for moderately low velocity guns.

b. All shot are deeply V-notched circumferentially above or below the bourrelet region, presumably to localize fracture during armor penetration to the notched zone. The reasons for this may be twofold; to accelerate fracture against sloped armor targets against which blunt nosed shot are most effective, and to prevent fracture of the explosive cavities to maintain high order detonations after armor penetration.

c. The carbon contents of the subject Soviet shot are in the range of 0.32 - 0.38% as compared to 0.50 - 0.60% carbon employed in domestic shot steels. The result of the lower carbon content is to lower the maximum hardness of the shot to the range of Rockwell C 50-55 as compared to Rockwell C 60 for American shot.

2. The methods of manufacture of the Soviet shot stress simplicity and economy in production practices. Coarse machining with heavy cuts are characteristic of all Soviet shot examined. Fine finishes are reserved for bearing surfaces such as bourrelets. It would appear that close dimensional control is also reserved for bearing and mating surfaces only.

3. The 85MM APHE shot was poorly heat treated in that the decremental hardening procedure which was employed resulted in brittle structures in the base of the shot.

~~CONFIDENTIAL~~

~~CONFIDENTIAL~~

4. It is estimated that the 45MM and 57MM APHE shot are effective against undermatching armor targets at angles up thru 60° obliquity while the 85MM APHE shot is effective against slightly undermatching armor at all angles of attack up thru 60° obliquity and against somewhat overmatching armor at 0° to 30° obliquity. The smaller caliber shot would probably perform poorly against moderately to greatly overmatching armor at moderate obliquities of attack.

C. A. Riddle

C. A. RIDDLE
Physical Science Aide

A. Hurlich

A. HURLICH
Metallurgist

APPROVED:

J. F. Sullivan

J. F. SULLIVAN
Deputy Director of Laboratory

~~CONFIDENTIAL~~

~~CONFIDENTIAL~~

INITIAL DISTRIBUTION OF THIS REPORT

| | | | |
|----|---|---|--|
| 25 | Office, Chief of Ordnance ORDGU-IN Collection and Dissemination Section | 1 | Commanding Officer Detroit Arsenal Centerline, Mich. |
| 1 | ORDTX-AR Executive Library | | Commanding General Aberdeen Proving Ground Maryland |
| 1 | Commanding Officer Frankford Arsenal Philadelphia, Pa. | 1 | Dev. and Proof Service |
| | | 1 | Ballistic Research Lab. |
| 1 | Commanding Officer Picatinny Arsenal Dover, New Jersey | 1 | Commandant, Ordnance School |
| | | 1 | Ordnance Intelligence Officer |
| | | 1 | The Ordnance Board Explosive Ordnance Disposal Division |
| 1 | Commanding Officer Watervliet Arsenal Watervliet, N. Y. | 1 | Chief, Bureau of Ordnance Department of Navy Washington 25, D. C. |
| | Watertown Arsenal Watertown, Mass. | 5 | Central Air Documents Office U. B. Building Dayton 2, Ohio Attn: CADO-D |
| 1 | Laboratory File | | |
| 3 | Extra Copies | | |

Approving Authority:

Ordnance Corps Technical Instruction 200-1-51 dated 4 May 1951
and change 1 thereto.

~~CONFIDENTIAL~~

INTRODUCTION

At the request of the Office, Chief of Ordnance¹, three Soviet APHE projectiles captured in the Korean theatre of operations were submitted to this Arsenal by Picatinny Arsenal² for metallurgical examination. These shot were identified as follows:

- 45MM, APHE-T, MOD. UBR-243Z, FMAM 1121
- 57MM, APHE-T, MOD. UBZR-271, FMAM 1935
- 85MM, APHE, MOD. UBR-365K, FMAM 2175

The shot as received at the Watertown Arsenal were inerted and without fuzes.

TEST PROCEDURE

The projectiles were visually examined to determine significant design features and all markings on them were recorded. After photographing the shot, their dimensions were measured for the preparation of engineering drawings.

A longitudinal slice was cut through the center of each projectile and was surface ground for hardness and macroetch testing. Specimens for chemical analysis and microscopic examination were cut from various regions of the shot components, including shot bodies, windshields, and rotating bands.

DATA AND DISCUSSION

A. Visual Observations

The general appearance of the three shot are shown in Figures 1, 3, and 5. The body of the 45MM shot was unpainted and no other protective coating was evident. The 57MM shot had a coating of dark olive drab paint from the nose to below the bourrelet, the remaining section being unpainted. Except for the rotating bands and bourrelet, the 85MM shot was completely covered with dark olive drab paint. Coarse machining marks were visible on the bodies of all shot except

-
1. Letter file O. O. 386. 3/5, Wtn 386. 3/546R, see Appendix A.
 2. Letter file ORDBB-T 386. 3/6-21, Wtn 386. 3/552R, see Appendix A.

for the area of the bourrelets which had finely ground finishes. The circumferential notches and cannelures showed evidence of particularly rough machining, making accurate measurement of their dimensions difficult.

The following markings were observed on the projectiles; all markings being stamped into the metal except where painting is indicated:

45MM APHE-T Mod UBR-243Z

18
Forward of Foremost Notch

15
Between Notches

ground section
with hardness
impression

244



33
-42

3

Between Bourrelet & Rotating Band

441 - 42

On Rotating Band

2 5
7 1

On Boat-tail Section

49

On Base

57MM APHE-T Mod UBZR-271

80
F, 7 (i)

H-K
^^ L

On Ogive Section Behind Windshield
(Black Painted Letters)

BP7-271 57

Behind Rear Notch

(Small Letters Stamped, Large Letters Black Paint)

~~CONFIDENTIAL~~

AB6 M

Rear of Rotating Band

Я Ё

Between Rear Rotating Band and Cannelure

85MM APHE Mod UBR-365K

A-IX ^ 522
M A-U 27-49

On Ogive (Black Paint)

3A77
-49

BP-365K ⁴⁴X₃₂ + 21

Between Notch and Foremost Rotating Band
(Small Letters Stamped, Large Letters Black Paint)

+ 3

On Foremost Rotating Band

И ЯХ У у f

On Rear Rotating Band

Behind Rear Rotating Band

KU U
HU U
AФ P
AK

J L

Black Paint → + → 0
37

On Boat-tail Section

3
~~CONFIDENTIAL~~

The shot gave the general impression of having been made with the aim of avoiding all fine machining and close adherence to dimensions except where it was absolutely necessary. The identification and inspection markings were very crudely stamped into or painted on the surfaces of the shot.

B. Design Features

1. Windshields

The windshields of the 45MM and the 57MM shot are crimped into cannelures between knurled ridges at the forward end of the shot; there being a single cannelure in the case of the 45MM shot and a double one in the case of the 57MM shot, see Figures 2 and 4 respectively. This method of windshield attachment is practical and gives a secure joint especially with blunt nosed projectiles of the subject types.

2. Shot Bodies

The geometrical design of the subject projectile bodies is considerably different from that of domestic monobloc steel shot, as can be seen from Figures 1 thru 6. Projectiles with blunt noses such as the 45MM and 57MM shot are particularly effective against under-matching³ armor targets at all obliquities of attack, especially when they are designed for guns having low muzzle velocities (less than 2500 ft/sec). Blunt nosed projectiles promote the penetration of armor by the plugging mechanism, wherein a disc of the armor is displaced ahead of the projectile. In the case of undermatching armor, it requires less energy to perforate the armor by plugging it than by pushing the metal aside in a ductile manner, especially when the hardness of the armor is relatively high. Blunt nosed shot are much less effective than ogival shot against overmatching armor targets, particularly at low obliquities of attack.

The 85MM shot has a single radius ogival nose which is tangent to the side of the shot at the bourrelet and which comes to a sharp point. This nose shape is similar to that of the American 90MM AP T33 shot, except that the latter shot has a secant rather than a tangent ogive.

3. Undermatching armor is plate which is thinner than the diameter of the attacking projectile.

The nose of the 85MM shot has a caliber radius⁴ of 1.45 as compared to 1.50 for the 90MM AP T33 shot. However, because of its tangent ogive, the Soviet 85MM shot is somewhat sharper nosed than the American 90MM shot.

All three Soviet shot, as well as many other Soviet shot which have been previously examined, have deep circumferential grooves machined into their bodies. The 45MM shot had two deep V-notches both forward of the bourrelet, with the rear notch at the forward edge of the bourrelet. In this shot, the forward edge of the V was sloped at 45° while the rear edge was parallel to the base, see Figure 2. In the case of the 57MM shot, both edges of the V groove were sloped at 45°, making a 90° angle with a radius at the root, see Figure 4. The bourrelet of this shot lies between the two notches. The 85MM shot had one deep groove of a still different design, note Figure 6, which was placed approximately 1/4 inch below the bourrelet.

It has been inferred that the function of the circumferential grooves in Soviet shot is to locate the region of subsequent fracture of the shot during the penetration of armor. It has been determined that highly sloped armor targets may be more effectively defeated by shot whose noses undergo fracture, permitting the blunt body section which remains to punch through the armor. Under this condition of attack, (highly sloped armor) shot whose noses remain intact tend to ricochet off the armor. Thus the notching of ogival shot promotes their fracture to form blunt nosed projectiles when attacking sloped armor targets. Against normal and low obliquity targets, the bending moment may be insufficient to fracture the shot, and they will penetrate in an intact condition which promotes best shot efficiency against such targets.

The above explanation is not, however, completely adequate to explain the notching of blunt nosed shot like the 45MM and 57MM projectiles which are already effective for attacking highly sloped armor targets. The second reason for notching the forward sections of APHE shot may be to confine fracture during armor penetration to the solid nose section of the shot, thus keeping the explosive cavity intact to permit high order detonations of the body section after it perforates the armor.

4. Caliber radius is the ratio of the radius of the ogive to the diameter (caliber) of the shot.

The above two reasons for notching steel shot; to promote nose fracture against highly sloping armor targets, and to insure an intact explosive cavity capable of a subsequent high order detonation appear to be the only logical explanations for the notches observed so frequently in Soviet shot. The very wide variations which have been observed in the shape, size, position, and number of notches in Soviet shot lead one to believe that either the manufacturer is permitted complete freedom of selection in this regard, which does not appear too likely, or that the Soviets use production shot for conducting research and development work and evaluate the success or failure of a particular shot design by how it acquits itself on the battlefield. It is known that the Germans did this to some extent during World War II, and it is entirely possible that the Soviets are conducting research and development in this manner, with Korea being used for field trials.

Experiments performed in this country with notched shot have not, to date, demonstrated them to be sufficiently advantageous against a variety of targets to justify the practice of notching steel armor-piercing projectiles.

The 45MM and 85MM shot are boat-tailed in a manner similar to that employed in some early World War II and now obsolete American shot.

3. Rotating Bands

Detailed dimensions of the rotating bands and the band seats of the three shot are shown in Figures 2, 4, and 6. The security of the band seating is demonstrated by the deep impressions of the band seat knurling into the bands, see Figure 11. The band seats were all undercut from 15° to 20° at both edges, resulting in a very firm attachment of the bands, as was noted by the difficulty encountered in removing the bands for chemical analysis, hardness testing, and microscopic examination.

The band seat scoring in the 57MM and 85MM shot was produced by knurling two parallel series of indentations into the band seat. In the 45MM shot, the band seat knurling consists of one set of parallel grooves sloped approximately $1-1/2^{\circ}$ from the longitudinal axis of the projectile.

C. Metallurgical Characteristics

1. Shot Bodies

a. Chemical Composition

The bodies of all three shot were made from medium carbon, manganese-silicon-chromium steels of very similar compositions, see Table I. Although the evidence provided by the subject three shot is, of course, extremely limited, there seems to be no indication of selection of alloy content consistent with hardenability requirements to harden through sections of varying size. As a matter of fact, the largest shot, the 85MM APHE, has the lowest carbon and total alloy content. In domestic practice, it is usual to employ higher alloy steels for shot of larger caliber in order to obtain full hardening of the heavier sections. The low carbon content of the subject shot is noteworthy. In American practice, it is common to employ alloy steels having carbon contents of 0.50-0.60% in order to harden the shot to Rockwell C 60 upon quenching. Steels with 0.32-0.38% carbon harden to Rockwell C 52-55 upon complete transformation to martensite.

Manganese-silicon-chromium steels containing approximately 1.5% silicon have been widely observed in Soviet ordnance materiel, being used in gun components, armor, and armor-piercing shot. The low molybdenum content indicates that this element is present only as a residual rather than as an alloying element. Molybdenum is very widely employed in this country in ordnance materiel to minimize or avoid temper embrittlement, being used in quantities in the range of 0.20 to 0.60%. Since this element is almost a specific for avoidance of embrittlement, its absence in Soviet ordnance materiel may safely be taken as an indication of its strategic nature in the Soviet metal supply.

b. Hardness Tests

Rockwell C hardness surveys were made on ground longitudinal cross-sectional slices cut from each shot, and the results are shown in Figures 8, 9, and 10. The 45MM and 57MM shot were heat treated to relatively uniform hardness over the entire shot, averaging Rockwell C 52 and 54 respectively. The 85MM shot shows evidence of decremental hardening, averaging approximately Rockwell C 47 from the tip of the nose down to the lower rotating band, from which region the hardness decreases rapidly to approximately Rockwell C 26 at the base.

~~CONFIDENTIAL~~

As expected from the lower carbon content and relatively low alloy content, and hence reduced hardenability for the cross-section involved, the hardness of the 85MM shot decreases from surface to center; dropping from Rockwell C 50 along the cylindrical surface to approximately Rockwell C 44 in the center of the shot.

The hardness patterns of the subject shot are radically different from those of domestic shot. In American practice, shot are heat treated to the maximum hardness obtainable (Rockwell C 60 and higher) and then differentially tempered to have hardnesses of approximately Rockwell C 59 at the bourrelet and gradually dropping to Rockwell C 45 at the base. It has been found that lowering the hardness of shot noses below Rockwell C 60 results in more extensive shatter of the shot against armor, as well as a reduction in the velocity of impact at which shatter initiates.

The reduced hardness of the 45MM and 57MM shot is understandable, since an effort was obviously made to increase the toughness of these shot since the blunt nose shape of these shot make shatter almost inevitable against heavy armor targets and at high terminal velocities. In the case of the 85MM shot, however, the low overall hardness should detract from the penetration performance of this ogival nosed shot.

c. Macroetch Tests

Hot acid macroetched longitudinal cross-sections of the three Soviet shot are shown in Figure 7. These sections were etched in a hot solution of 50% concentrated hydrochloric acid and 50% water. The quality of the steel employed for all three shot is moderately poor as indicated by the heavy concentration of long stringers. The 45MM and 85MM shot were obviously completely machined from bar stock, while the 57MM shot shows evidence of having been hot nosed prior to final machining, as seen from the inward tapering of the stringers in the nose of this shot.

While it is common practice in this country and abroad to machine small caliber armor-piercing shot from bar stock, it is considered best practice to hot forge or press the noses of medium and large caliber shot to provide the best mechanical and metallurgical properties in such shot. Projectiles of the size of the 85MM shot are more generally hot nosed prior to finish machining.

~~CONFIDENTIAL~~

d. Microscopic Examination

Specimens obtained from locations of the shot bodies shown in Figures 8, 9, and 10 were polished, etched, and microscopically studied.

The 45MM shot has an essentially martensitic microstructure throughout, with some bainite in the middle of the cylindrical section of the body forward of the explosive cavity, see Figure 12. The 57MM shot has a similar microstructure, except with a greater amount of martensite and less bainite in the mid-section, see Figure 13. The more completely martensitic structure of this shot is consistent with its higher carbon and alloy content as compared to the other shot.

The 85MM shot exhibits greater amounts of oxide type non-metallic stringers, as shown in some of the photomicrographs of Figure 14. No areas of this shot show completely martensitic microstructures, although the nose section is more fully hardened than any other zone, see Figure 14B. The microstructure at the center of the shot at the bourrelet shows large amounts of bainite and ferrite, Figure 14F, which are indicative of slack quenching or insufficient alloy content to harden fully through the cross-section. As previously indicated, the alloy content of this shot is borderline with respect to hardenability. The largely ferritic and pearlitic microstructure at the base of the 85MM shot, Figure 14H, as well as the low hardness of this region of the shot indicate that the shot was differentially quenched, probably by immersing the nose and the body of the shot into the liquid coolant, and allowing the base section to cool in air.

This method of decrementally hardening shot is the least desirable way of accomplishing a differential hardness pattern since the base ends up in a brittle, though soft, condition. The optimum method of producing a differential hardness pattern is to first fully harden the shot to a martensitic microstructure, and then differentially base temper to soften this region without lowering the hardness of the nose. This latter method of heat treatment produces a shot that becomes progressively softer and tougher towards the base and insures that the body and base section remains intact during armor penetration.

~~CONFIDENTIAL~~

2. Windshield

a. Chemical Composition

The windshields of the blunt nosed 45MM and 57MM shot were made from low carbon unalloyed steel, as shown by the analyses listed in Table I. The chemical compositions of both windshields are typical of those of rimmed steel, which is widely used for deep drawn parts in both this country and abroad.

b. Hardness Tests

Because of the thinness of the windshields, their hardnesses were measured with the Rockwell Superficial Hardness Tester, using the "15-T" Scale. The following results were obtained:

| <u>Windshield from</u> | <u>Rockwell 15-T Hardness</u> | <u>Brinell Hardness(converted)</u> |
|------------------------|-----------------------------------|--|
| 45MM APHE | 87.5, 88.0, 87.5 | 159 |
| 57MM APHE | 83.0 | 123 |

The somewhat higher hardness of the windshield from the 45MM shot is consistent with the higher carbon and manganese content of this component.

c. Microscopic Examination

The microstructures of both windshields consist of moderately fine grained ferrite with scattered spheroidized carbides, see Figures 15A, B, C, and D. The absence of evidence of cold working indicates that the windshields were annealed after cold drawing, presumably to avoid difficulty in subsequent crimping to the shot noses.

3. Rotating Bands

a. Chemical Composition

The analyses of the rotating bands from the 57MM and 85MM shot are shown in Table I. Insufficient material was available from the band of the 45MM shot to analyze this component since a one-

~~CONFIDENTIAL~~

half section of the shot was returned to Picatinny Arsenal, but the rotating band from this shot was obviously either pure copper or only slightly alloyed copper.

The rotating bands on the 57MM shot were made of a 4.5% nickel-copper alloy similar in composition to rotating bands extensively used in this country prior to World War II. When nickel became scarce because of its more extensive use in more critical applications, nickel was eliminated from rotating bands in favor of either pure copper or copper alloys with less strategic alloying elements. The rotating bands on the 85MM shot are made of commercially pure copper and are usual for this application.

b. Hardness Tests

The hardnesses of the rotating bands were measured with the Vickers Diamond Pyramid Hardness Tester using a 2-1/2 Kg. load with the following results:

| <u>Shot</u> | <u>Vickers Diamond Hardness</u> | <u>Average Vickers Hardness</u> | <u>Brinell Hardness (converted)</u> |
|-------------|--|---------------------------------|-------------------------------------|
| 45MM | 114, 111, 118, 111, 118, 116, 111, 115, 120, 125, 126, 118 | 117 | 108 |
| 57MM | 111, 127, 134, 133, 136, 121, 122, 126, 126, 128, 128 | 126.5 | 114 |
| 85MM | 110, 104, 111, 106, 110, 107, 104, 110, 110, 113 | 108 | 100 |

The above hardnesses are typical of cold worked copper and copper alloys.

c. Microscopic Examination

The microstructures of the rotating bands from the three shot are quite similar, consisting of fine grains with evidence of twinning and cold working, see Figures 14I, 15E, and 15F.

~~CONFIDENTIAL~~

GENERAL CONSIDERATIONS

The subject Soviet shot were produced from a medium carbon, manganese-silicon-chromium steel which has been widely observed in Soviet ordnance materiel. The use of steels containing approximately 1.5% silicon as an alloying element appears to be characteristic of Soviet practice. High silicon steels melted in this country are generally found to be quite dirty, having large amounts of silicate and oxide type inclusions. Although Soviet high silicon steels employed as armor have been found to be very clean on occasion, the quality of the steel employed for the subject shot was rather poor as evidenced upon hot acid macroetching.

The geometrical design of the shot are radically different from general American practice, as is also the hardness pattern and carbon content of the shot. The smaller caliber shot are designed with blunt noses intended for the defeat of thin highly sloped armor or possibly for use under conditions of extremely low temperature when armor tends to become more brittle and less resistant to shock impact. All shot are V-notched circumferentially at various locations from forward of the bourrelet to below the bourrelet, ostensibly to confine fracture of the shot during armor penetration to the undercut area. The wide variation in the execution of the notching may indicate considerable battle-field experimentation along this line by the Soviets.

The hardness patterns of the subject shot are considered poor according to American standards, and the heat treatment of the 85MM shot to produce a decrementally hardened shot was accomplished by an undesirable procedure.

The shot were manufactured with an eye towards minimization of production costs and simplification of procedures; using coarse machine tools taking heavy cuts, with only contact areas such as the bourrelet receiving fine machine finishes.

It is expected that the 45MM and 57MM shot will perform satisfactorily against such targets as 1" to 2" thick armor sloped at angles up to 60° obliquity, but will be very poor against 3" and 4" armor at normal and moderate obliquities of attack. The 85MM shot will probably perform almost as well as the American 90MM AP T33 shot against mild targets such as 2" at 45° to 60° obliquity and 3" to 4" armor at 0° to 30° obliquity, but will probably not be as effective as the 90MM AP T33 shot against more severe targets.

TABLE I

Chemical Compositions of Soviet 45MM, 57MM, and 85MM APHE Projectiles,
FMAM 1121, 1935, and 2175

| Projectile | Composition | | | | | | | | |
|------------|-----------------------|-----------|-----------|-----------|-----------|-----------|-----------|-----------|-----------|
| | <u>SHOT BODIES</u> | | | | | | | | |
| | <u>C</u> | <u>Mn</u> | <u>Si</u> | <u>S</u> | <u>P</u> | <u>Ni</u> | <u>Cr</u> | <u>Mo</u> | <u>V</u> |
| 45MM | .365 | .93 | 1.37 | .018 | .037 | Nil | 1.32 | .06 | Nil |
| 57MM | .38 | .98 | 1.64 | .027 | .022 | .09 | 1.42 | .03 | Nil |
| 85MM | .32 | .92 | 1.41 | .034 | .029 | .22 | 1.17 | .03 | Nil |
| | <u>WINDSHIELDS</u> | | | | | | | | |
| | <u>C</u> | <u>Mn</u> | <u>Si</u> | <u>S</u> | <u>P</u> | <u>Ni</u> | <u>Cr</u> | <u>Mo</u> | <u>V</u> |
| 45MM* | .115 | .47 | - - | .027 | .023 | - | - | - | - |
| 57MM | .09 | .29 | .01 | .035 | .018 | .09 | .18 | .03 | Nil |
| | <u>ROTATING BANDS</u> | | | | | | | | |
| | <u>Cu</u> | <u>Mn</u> | <u>Sn</u> | <u>Pb</u> | <u>Fe</u> | <u>Al</u> | <u>Ni</u> | <u>P</u> | <u>Zn</u> |
| 57MM | 95.03 | .13 | Nil | .02 | .13 | Nil | 4.48 | .014 | Trace |
| 85MM | 99.90 | Nil | Nil | Trace | Trace | Nil | Nil | Nil | Nil |

*Insufficient material available for more complete analysis.

CONFIDENTIAL

~~CONFIDENTIAL~~



PROJECTILE
WATERTOWN ARSENAL LABORATORY
BASE VIEW
SOVIET 45MM APHE-T MOD. UBR 2432 PROJECTILE. WTN.751-1944

~~CONFIDENTIAL~~

FIGURE I

CONFIDENTIAL

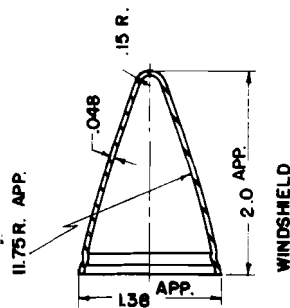
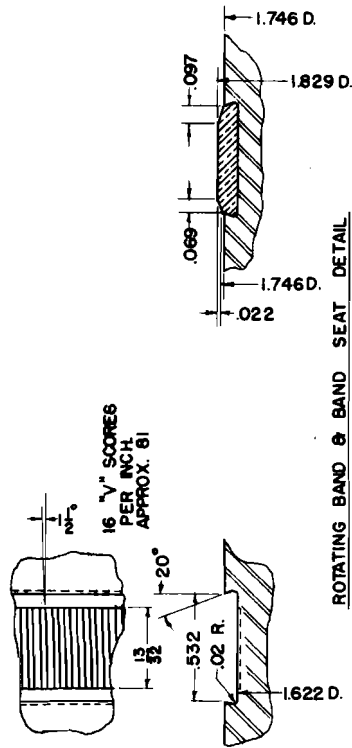
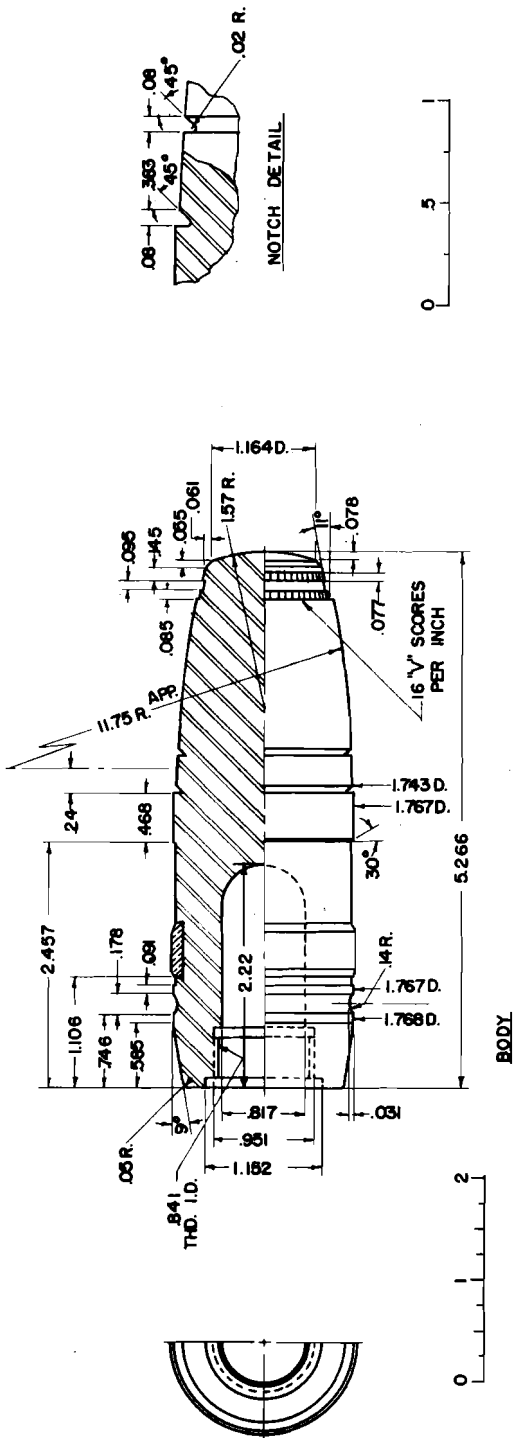

ROTATING BAND & BAND SEAT DETAIL.

FMAM 1121
SOVIET 45MM. APHE-T MOD. UBR-243Z PROJECTILE.

CONFIDENTIAL

WATERTOWN ARSENAL, LABORATORY
CONFIDENTIAL

WTN.630-11,752

FIGURE 2

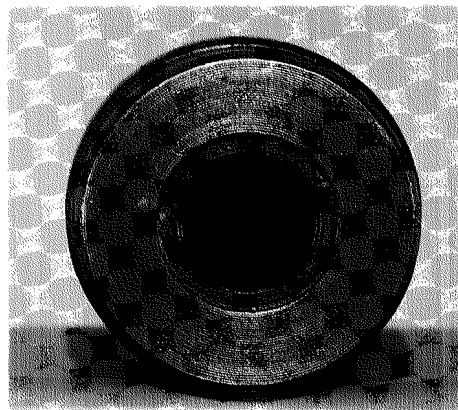

PROJECTILE BASE VIEW
WATERTOWN ARSENAL LABORATORY
SOVIET 57MM APHE-T MOD. UBZR 27N PROJECTILE. WTN.751-1946

FIGURE 3

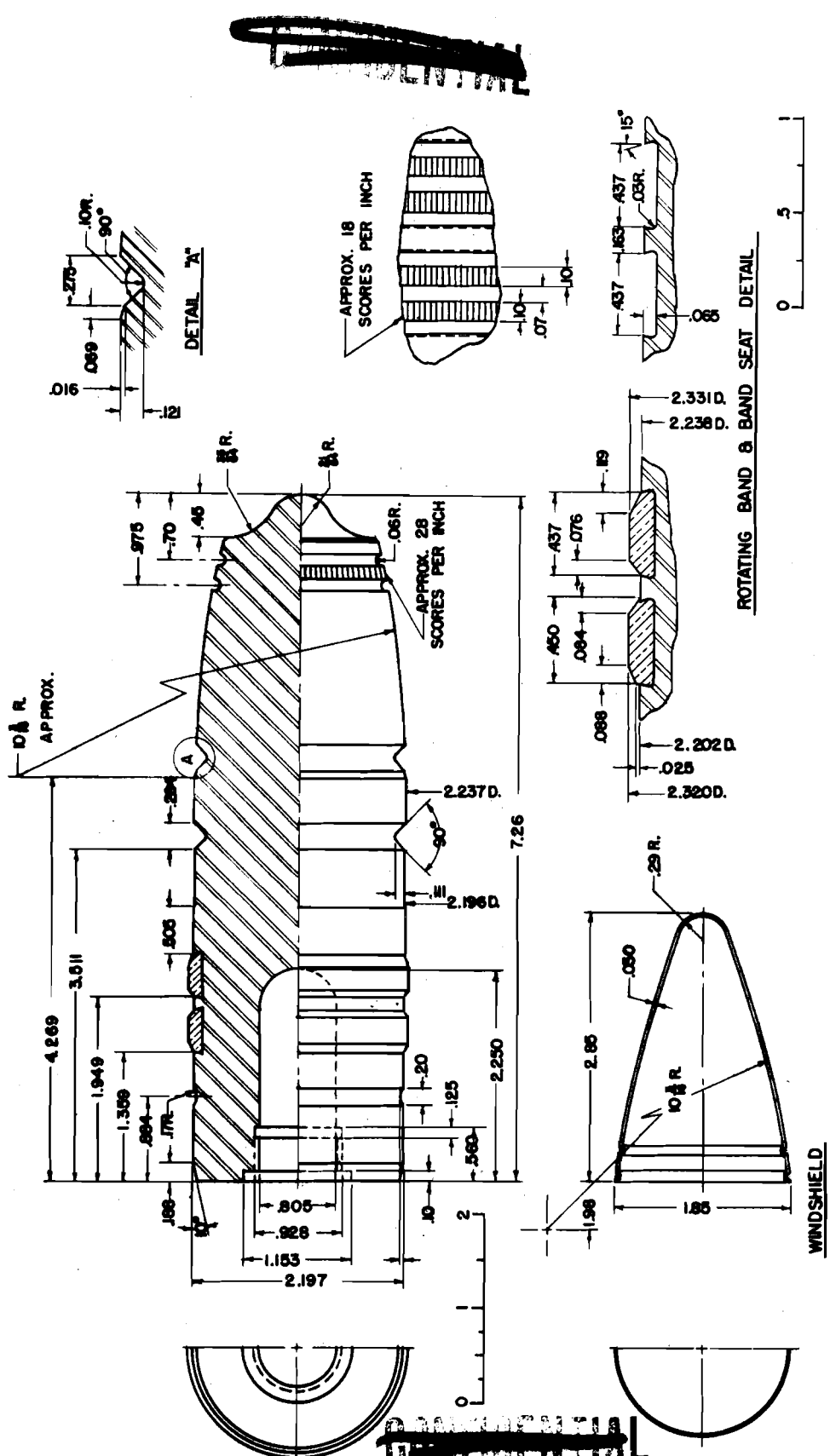

SOVIET 57MM APHE-T MOD. UBZR-271 PROJECTILE (FMAM-1935)

FIGURE 4 WATERTOWN ARSENAL LABORATORY CONFIDENTIAL WTN.63D-11,512

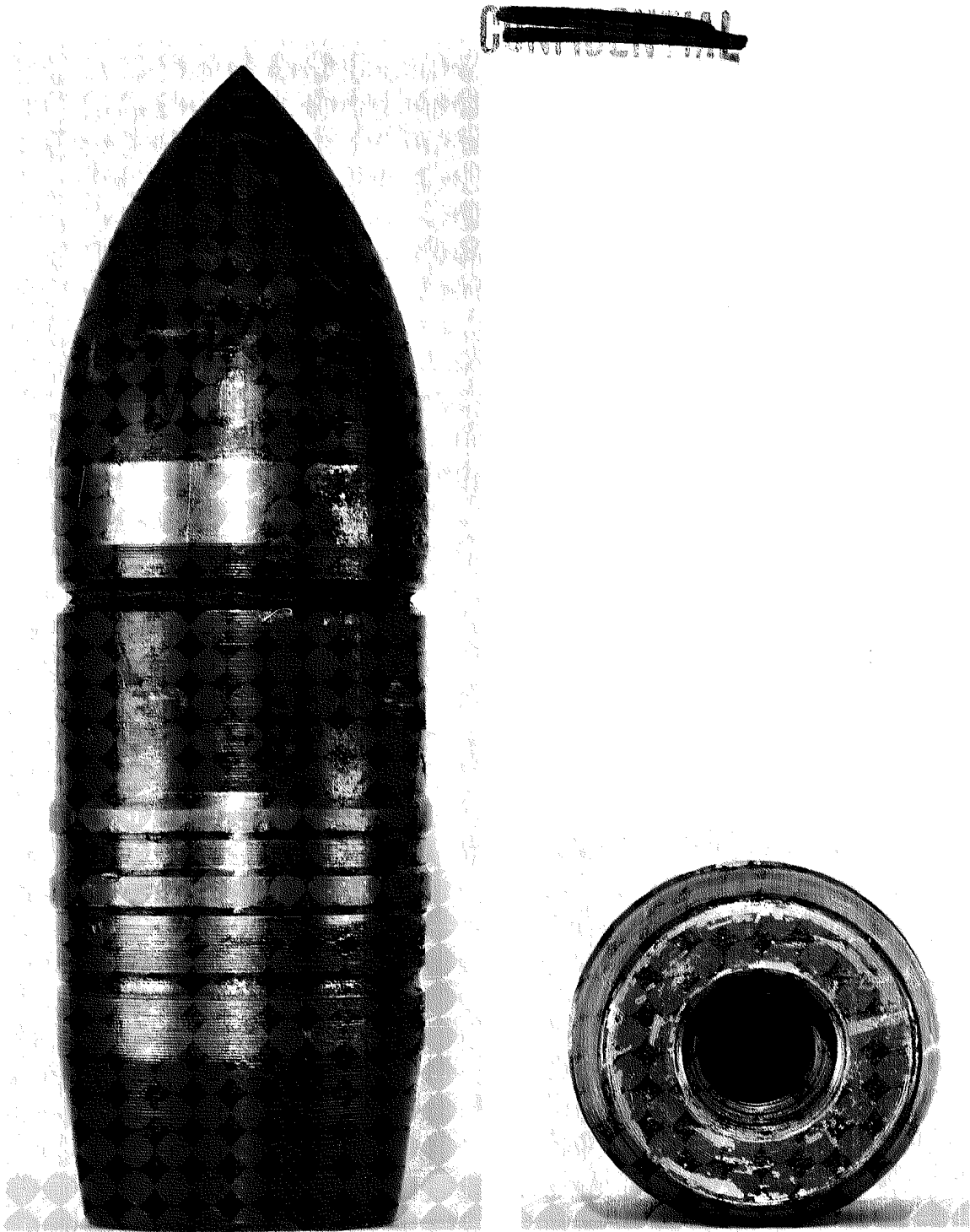

PROJECTILE

BASE VIEW

W A T E R T O W N A R S E N A L L A B O R A T O R Y

SOVIET 85MM APHE MOD. UBR 365K PROJECTILE.

WTN.751-1948

FIGURE 5

~~CONFIDENTIAL~~

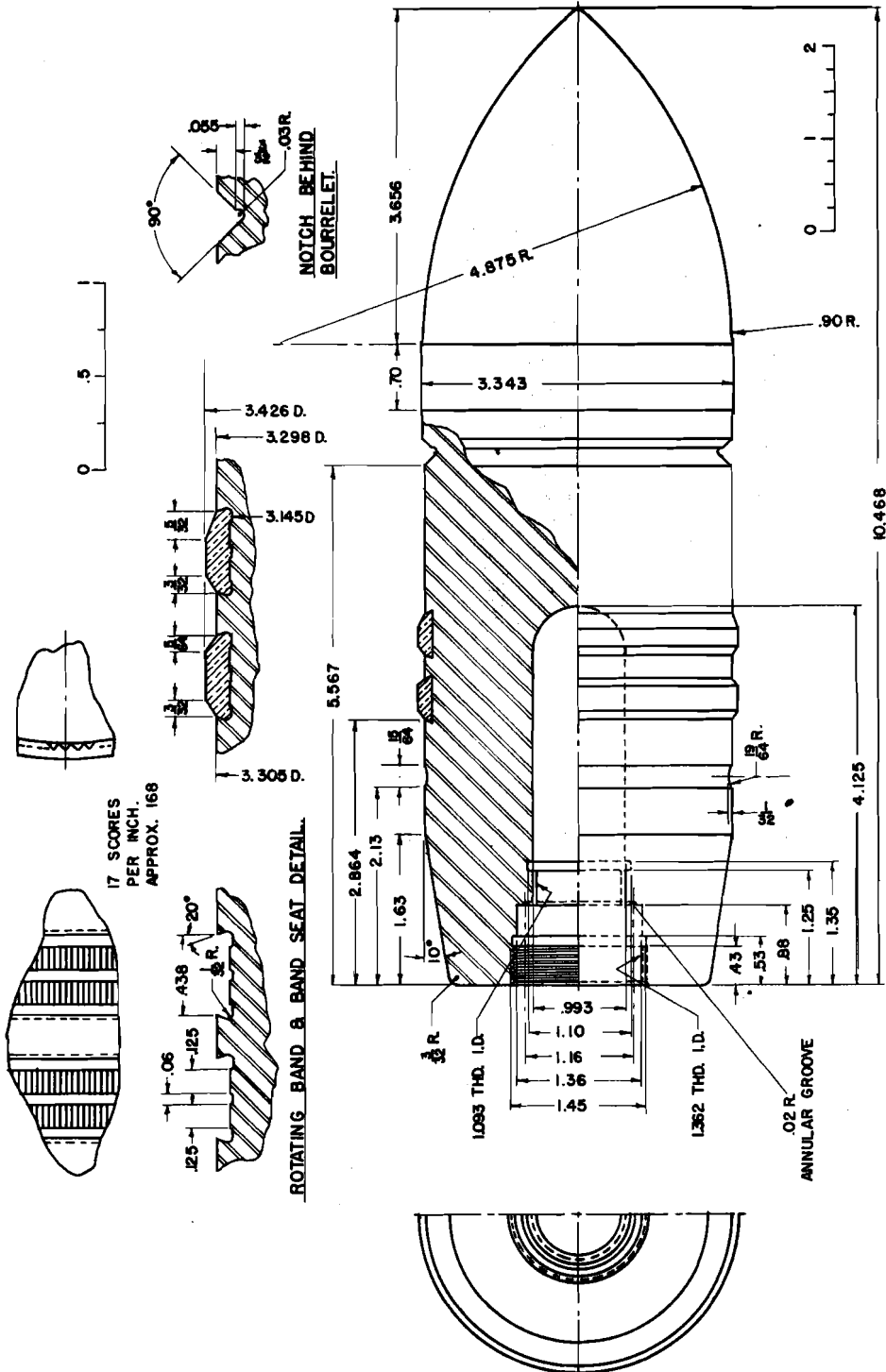

SOVIET 85MM APHE MOD. UBR-365K PROJECTILE.

FIGURE 6

WATERTOWN ARSENAL LABORATORY
CONFIDENTIAL

WTN.639-11,753

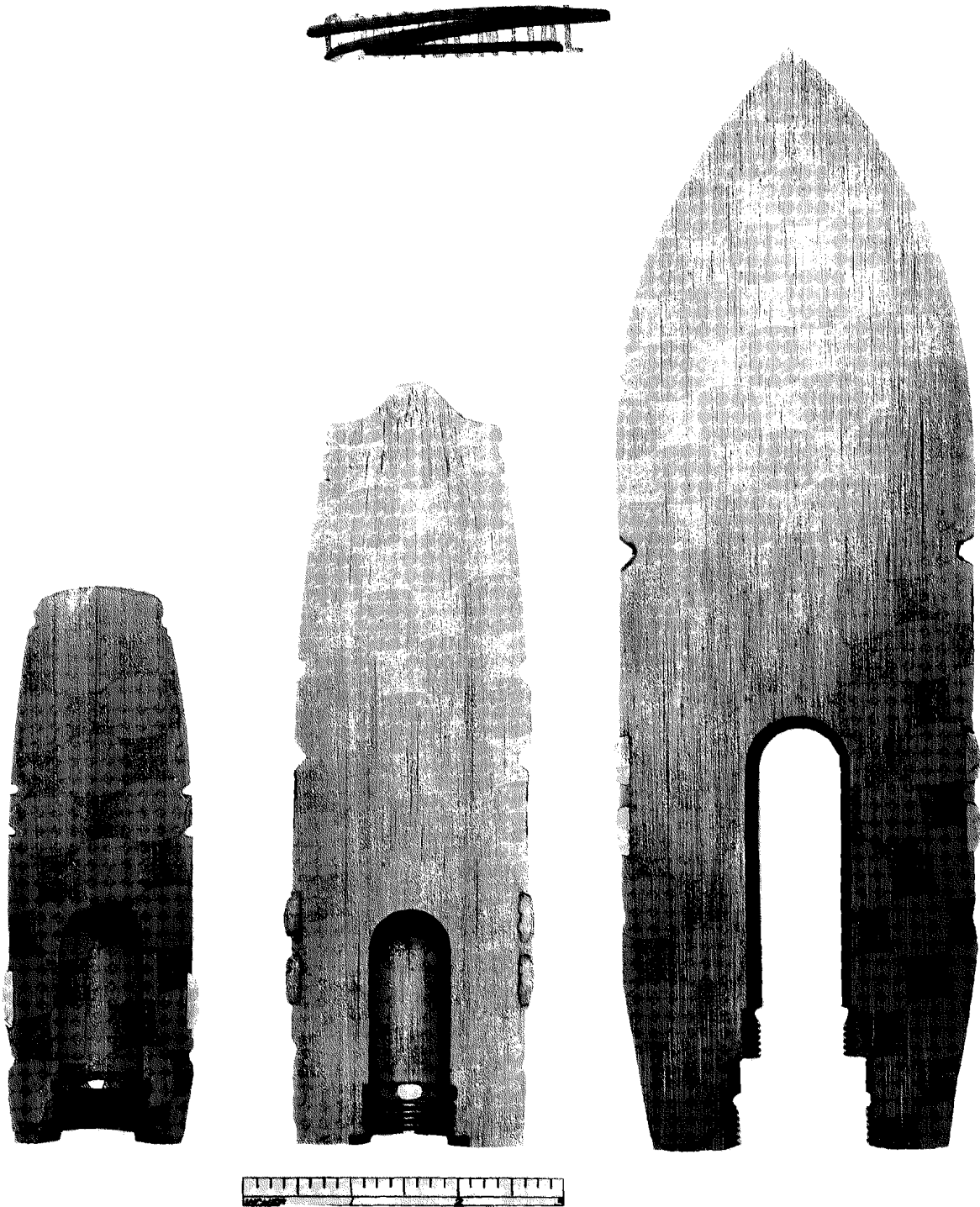

45MM APHE-T MOD.
UBR 342Z

57MM APHE-T MOD.
UBZR 271

85MM APHE MOD.
UBR 365K

WATERTOWN ARSENAL LABORATORY

SECTIONS OF SOVIET APHE PROJECTILES SHOWING HOT ACID MACROETCHED STRUCTURE OF STEEL BODIES
WTN.751-1986

FIGURE 7

~~CONFIDENTIAL~~

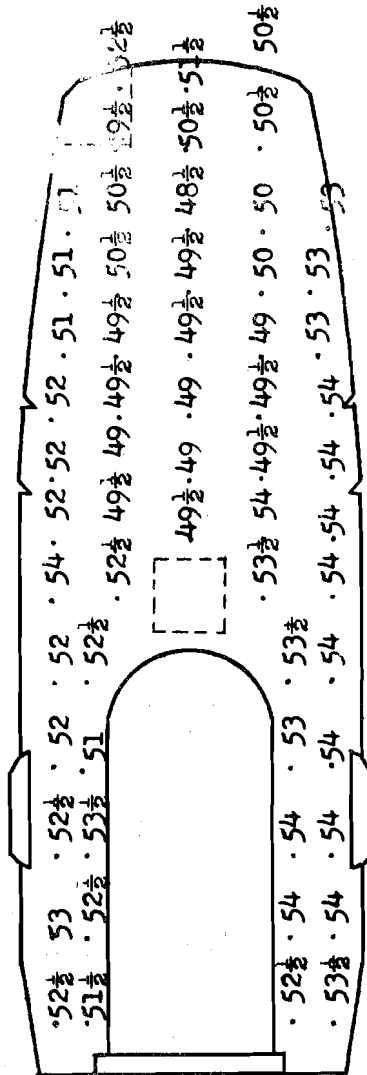

ROCKWELL C HARDNESS PATTERN ON BODY OF SOVIET 45MM APHE-T PROJECTILE MOD. UBR-243Z (FMAM 1121) AND LOCATION OF SPECIMENS FOR MICROSCOPIC EXAMINATION.

~~CONFIDENTIAL~~

~~CONFIDENTIAL~~

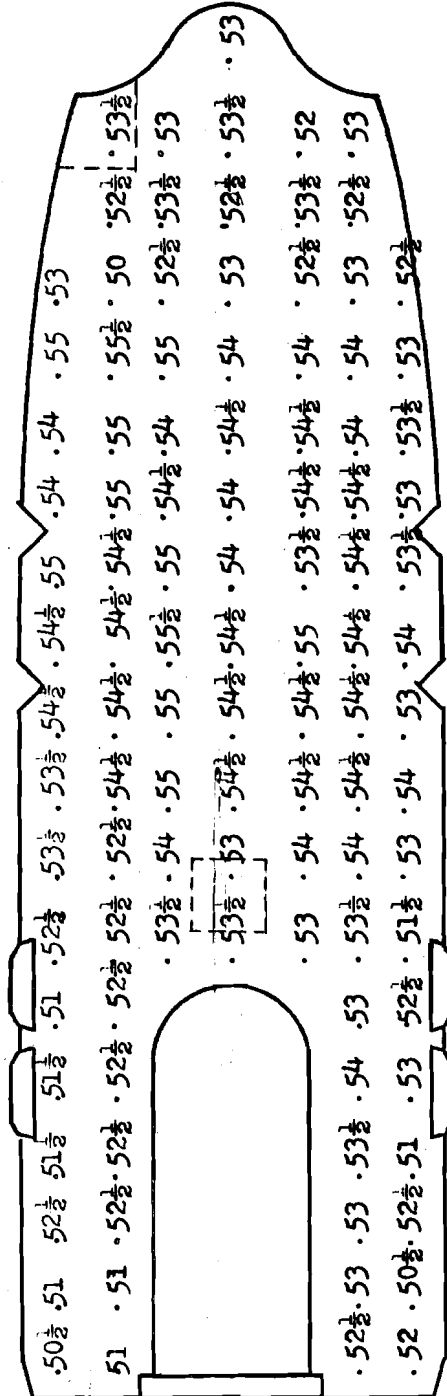

TECHNICAL INFORMATION SECTION
DEVELOPMENT & PROOF SERVICES
MEMBER PROVING GROUP

ROCKWELL C HARDNESS PATTERN ON BODY OF SOVIET 57MM APHE-T PROJECTILE MOD. UBZR-271 (FMAM 1935) AND LOCATION OF SPECIMENS FOR MICROSCOPIC EXAMINATION.

~~CONFIDENTIAL~~

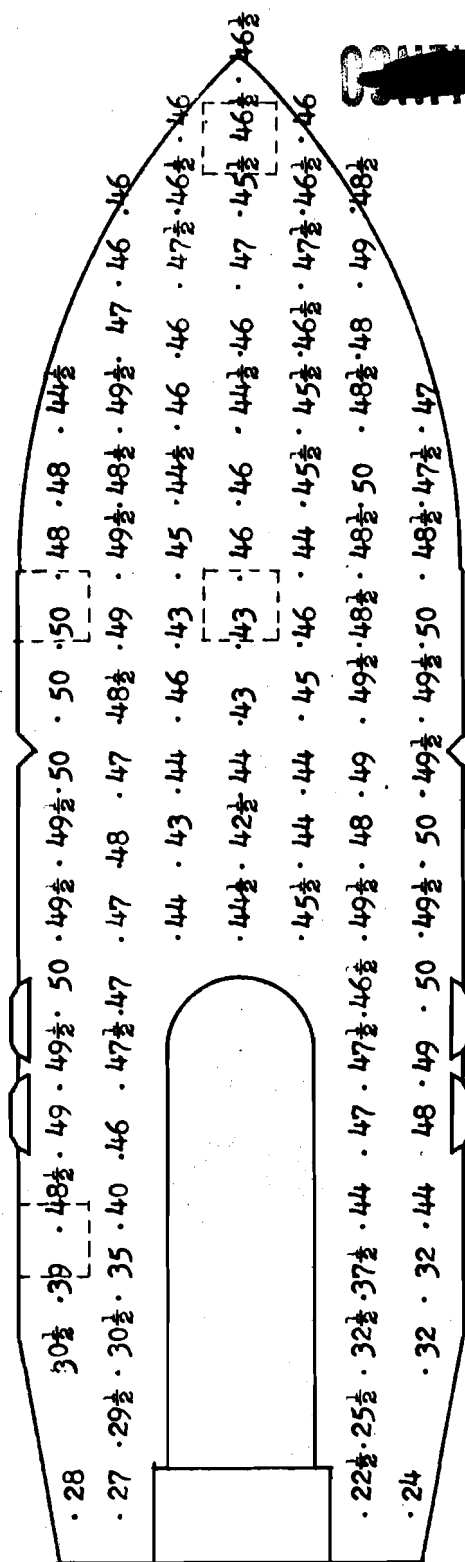

CONFIDENTIAL

ROCKWELL C HARDNESS PATTERN ON BODY OF SOVIET 85MM APHE-T PROJECTILE MOD. UBR-365K (FMAM 2175) AND LOCATION OF SPECIMENS FOR MICROSCOPIC EXAMINATION.

CONFIDENTIAL

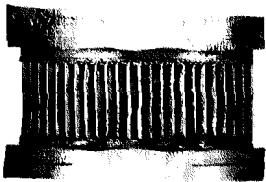

BAND SEAT



ROTATING BAND

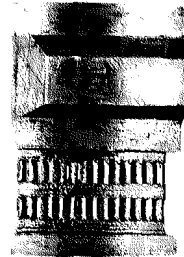

BAND SEAT



ROTATING BAND

45MM APHE-T MOD UBR 243Z PROJECTILE
(FMAM 1121)

57MM APHE-T MOD UBZR 271 PROJECTILE
(FMAM 1935)

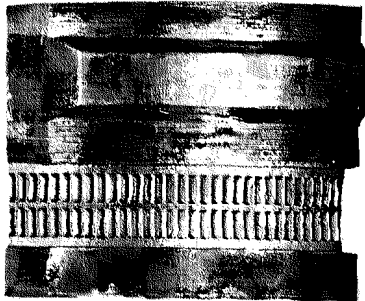

BAND SEAT



ROTATING BAND

85MM APHE MOD UBR 365K PROJECTILE
(FMAM 2175)

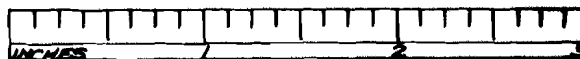

WATERTOWN ARSENAL LABORATORY

BAND SEAT DETAILS OF SOVIET APHE-T PROJECTILES AND INSIDE VIEW OF ROTATING BAND SHOWING
KNURLING. MAG. XI WTN. 751-1994



~~CONFIDENTIAL~~

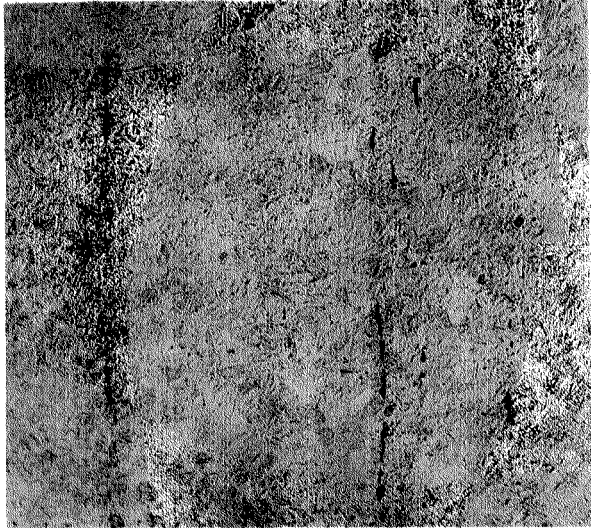

X100 -A- PICRAL
FORWARD CORNER OF PROJECTILE NOSE— FINE
SEGREGATIONS OF INCLUSIONS, SOME BANDING.

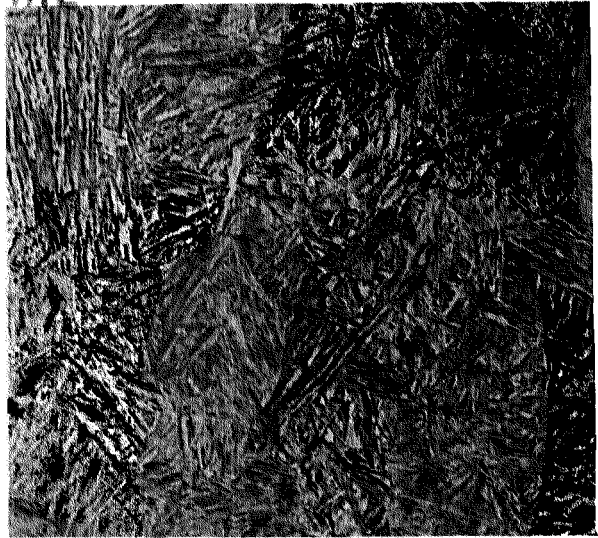

X1000 -B- PICRAL
FORWARD CORNER OF PROJECTILE NOSE— SAME
AREA AS A. MARTENSITIC STRUCTURE.



X100 -C- PICRAL
FORWARD OF EXPLOSIVE CAVITY— FINE
SEGREGATIONS OF INCLUSIONS, SOME BANDING.



X1000 -D- PICRAL
FORWARD OF EXPLOSIVE CAVITY— SAME AREA
AS C. MARTENSITE AND MODERATE AMOUNT
OF BAINITE.

MICROSTRUCTURE OF BODY OF SOVIET 45MM APHE-T MOD. UBR-243Z PROJECTILE. FMAM 1121.

~~CONFIDENTIAL~~

~~CONFIDENTIAL~~



X100 -A- PICRAL
FORWARD CORNER OF PROJECTILE NOSE--
SHOWS SHORT ELONGATED INCLUSIONS AND
FINE GRAINED STRUCTURE.



X1000 -B- PICRAL
FORWARD CORNER OF PROJECTILE NOSE--
SAME AREA AS A. MARTENSITIC STRUCTURE.

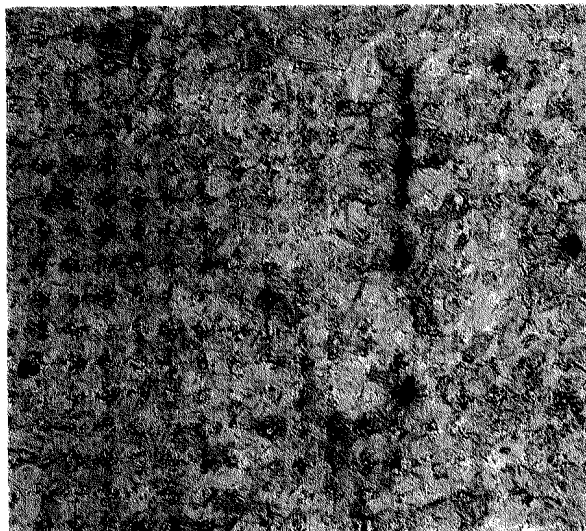

X100 -C- PICRAL
FORWARD OF EXPLOSIVE CAVITY-- OXIDE
TYPE INCLUSIONS AND FINE GRAINED
STRUCTURE.

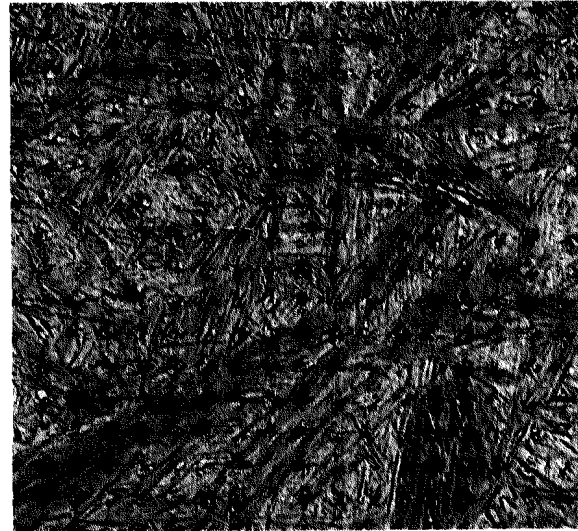

X1000 -D- PICRAL
FORWARD OF EXPLOSIVE CAVITY-- SAME AREA
AS C. MARTENSITE WITH TRACE OF BAINITE.

MICROSTRUCTURE OF BODY OF SOVIET 57MM APHE-T MOD. UBZR-271 PROJECTILE, FMAM 1935.

~~CONFIDENTIAL~~

~~CONFIDENTIAL~~

Figure 14

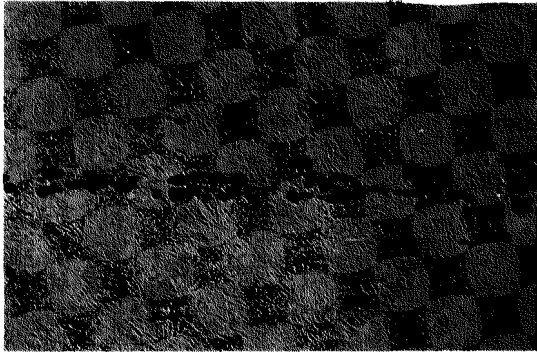

X100 -A- PICRAL
FORWARD CORNER OF PROJECTILE NOSE—
OXIDE TYPE INCLUSIONS AND FINE
GRAINED STRUCTURE.

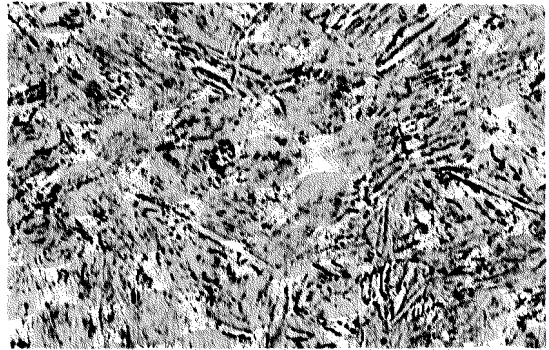

X1000 -B- PICRAL
FORWARD CORNER OF PROJECTILE NOSE—
SAME LOCATION AS A. SOME BAINITE IN
MARTENSITIC MATRIX.

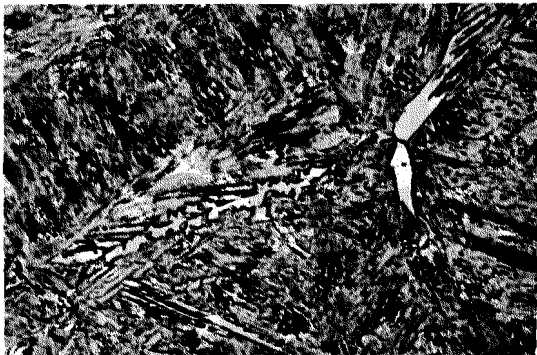

X1000 -C- PICRAL
SURFACE OF PROJECTILE AT BOURRELET—
SMALL AMOUNT OF BAINITE AND FERRITE
IN A MARTENSITIC MATRIX CONTAINING
SOME UNDISSOLVED CARBIDES. SAME AREA AS C.

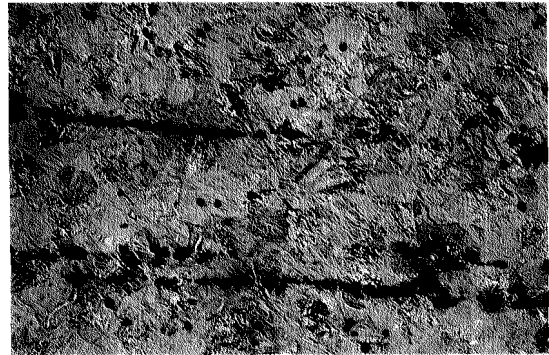

X100 -D- PICRAL
CENTER OF PROJECTILE AT BOURRELET—
BAD SEGREGATIONS OF OXIDE TYPE
INCLUSIONS.



X100 -E- PICRAL
2 INCHES FROM BASE— BAD SEGREGATIONS
OF OXIDE TYPE INCLUSIONS.



X1000 -F- PICRAL
2 INCHES FROM BASE— SAME LOCATION AS
G. FERRITE AND PEARLITE STRUCTURE.

MICROSTRUCTURE OF BODY AND ROTATING BAND OF SOVIET 85MM APHE-T MOD. UBR-365K PROJECTILE. FMAM 2175.

~~CONFIDENTIAL~~



X100 -C- PICRAL
 SURFACE OF PROJECTILE AT BOURRELET-
 STREAKS OF FINE ELONGATED INCLUSIONS.



X1000 -F- PICRAL
 CENTER OF PROJECTILE AT BOURRELET-
 SAME LOCATION AS E. SOME MARTENSITE
 WITH LARGE AMOUNT OF BAINITE AND FERRITE.



X100 -I- $\text{NH}_4\text{OH}, \text{H}_2\text{O}_2$
 COPPER ROTATING BAND- FINE GRAINED
 STRUCTURE SHOWING EVIDENCE OF
 COLD WORKING.

~~CONFIDENTIAL~~

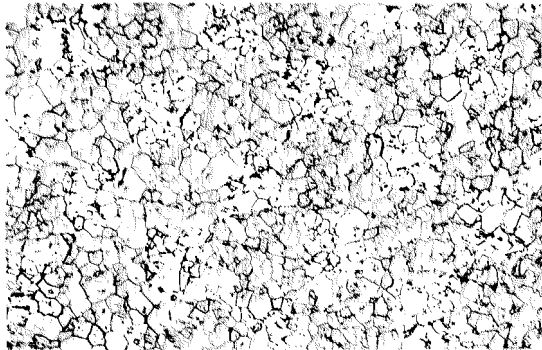

X100 -A- PICRAL
45MM WINDSHIELD- LOW CARBON STEEL.
FINE FERRITE GRAIN.



X1000 -B- PICRAL
45MM WINDSHIELD- SAME AREA AS A
SHOWING SPHEROIDIZED CARBIDES.

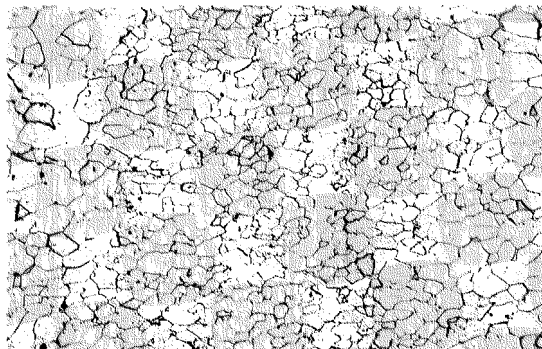

X100 -C- PICRAL
57MM WINDSHIELD- LOW CARBON STEEL.
FINE GRAINED FERRITE.



X1000 -D- PICRAL
57MM WINDSHIELD- SAME AREA AS C
SHOWING SPHEROIDIZED CARBIDES IN
STRUCTURE.



X100 -E- $\text{NH}_4\text{OH}, \text{H}_2\text{O}_2$
45MM ROTATING BAND- FINE GRAINED
COPPER, PARTIALLY COLD WORKED.



X100 -F- $\text{NH}_4\text{OH}, \text{H}_2\text{O}_2$
57MM ROTATING BAND- FINE GRAINED
COPPER, PARTIALLY COLD WORKED.

MICROSTRUCTURE OF WINDSHIELDS AND ROTATING BANDS OF SOVIET 45MM APHE-T MOD. UBR-243Z (FMAM 1121) AND 57MM APHE-T MOD. UBZR-271 (FMAM 1935) PROJECTILES.

~~CONFIDENTIAL~~

~~CONFIDENTIAL~~

APPENDIX A

Letter file ORDBB-T 386.3/6-21, WTN 386.3/552(r), dated 11 April 1951.

Letter file O. O. 386.3/5, WTN 386.3/546(r), dated 5 January 1951.

~~CONFIDENTIAL~~

COPY - 18 March 1952 - aed

Ordnance Corps
PICATINNY ARSENAL
Dover, New Jersey

In Reply
Refer to: ORDBB-T 386.3/6-21

RECORD
ABSchilling/fg/3170

11 April 1951

SUBJECT: Metallurgical Examination of Soviet Artillery Ammunition

To: Commanding Officer
Watertown Arsenal
Watertown, Mass.

1. Reference is made to the attached directive from the Chief of Ordnance to Picatinny Arsenal, Subject: Soviet Ammunition, 5 January 1951, O. O. 386.3/5 (ORDBB 386.3/6).

2. Inerted projectiles as listed on the directive and referred to in paragraph 2 are being forwarded by freight to your Arsenal for Metallurgical Examination in compliance with the directive referred to. Each projectile has been labelled with the FMAM number for purpose of identification.

3. In addition to the projectiles listed on the directive, 1 - 85mm HVAP-T MOD. UBR-365P FMAM 2176 (Soviet) and 1 - 85mm APHE MOD UBR-365K, FMAM 2175 (Soviet) projectile are included in the shipment for metallurgical examination.

4. Additional information relating to the rounds, not listed on the directive, has been received and should be used in the titles of the reports. This information follows:

- FMAM 2178 45mm HVAP-T MOD. UBR 243P Proj. (Soviet)
- FMAM 1121 45mm APHE-T MOD. UBR 243Z Proj. (Soviet)
- FMAM 1935 57mm APHE-T MOD. UBZR-271 Proj. (Soviet)
- FMAM 2228 57mm HVAP-T MOD. UBR-271P Proj. (Soviet)

ORDBB-T

SUBJECT: Metallurgical Examination of Soviet Artillery Ammunition

5. There is inclosed marked copy of Photograph M-37979 showing certain diameter dimensions obtained, prior to sectioning the projectile, to assist in the preparation of the dimensional drawing referred to in paragraph 6. The flats cut on the aluminum nose of Items FMAM-2228 and FMAM-2176 were made at this Arsenal to facilitate disassembly and were not, therefore on the projectile when received.

6. It is requested that a report of the results, including a dimensional drawing be forwarded upon completion and that the report number and title be furnished this Arsenal as soon as available for incorporation as a reference in technical reports being prepared on the complete rounds.

7. It is also requested that a three-quarter section of the projectiles, except the 57mm HVAP-T, FMAM-2228 item, be returned to this Arsenal upon completion of the examination. Return of a one-half section of the 57mm HVAP-T, FMAM-2228 Projectile and as much of the carbide cores of all HVAP-T projectiles as remains available after the examination has been completed is desired.

FOR THE COMMANDING OFFICER:

(C. R. Dutton)

2 Incls

1. Copy of ltr (ORDBB 386.3/6)
2. Photo M-37979

C. R. DUTTON
Col, Ord Corps
Assistant

COPY - 18 March 1952 - aed

RECORD

ORDTA

LSMichael/bw/53401

5 January 1951

TO: Commanding Officer
Picatinny Arsenal
Dover, New Jersey

1. Arrangements have been made to ship to your arsenal, one round each of the following Soviet ammunition items which were captured in Korea:

- a. Shell, Semi-Fixed, 122-mm, How. M38, FMAM 1608
- b. C/R, 45-mm, HVAP-T, FMAM, 2178
- c. C/R, 45-mm, APHE-T, FMAM, 1121
- d. C/R, 45-mm, HE-T, W/PD Fuze, KTM-1, FMAM-1120
- e. C/R, 85-mm, HE, Model UO-365 W/Fuze T5
- f. C/R, 57-mm, API-T, Model UBZR-271
- g. C/R, 57-mm, HVAP-T, Model UBR-271P
- h. C/R, 57-mm, HE, Model UO-271
- i. Projectile, 122-mm, HE, Model OF-471N
- j. Prop. Chg. (Cased) 122-mm, ZHN-471

2. Your arsenal is requested to examine the items listed above and to prepare reports thereon in accordance with established procedure. This office is particularly interested in obtaining detailed information regarding the armor piercing projectiles in Items 1b, 1c, 1f and 1g. After all explosive material has been removed and drawings of the projectiles have been made, all the projectiles should be forwarded to Watertown Arsenal for hardness survey and metallurgical examination. The Watertown Arsenal findings should be included in your arsenal's formal reports.

3. The requested activity should be conducted under Project TA1-3500.

BY COMMAND OF MAJOR GENERAL FORD:

CC: Watertown Arsenal

W. L. BELL, Jr.
Col, Ord Corps
Assistant

~~CONFIDENTIAL~~

~~CONFIDENTIAL~~

INITIAL DISTRIBUTION OF THIS REPORT

| | | | |
|----|---|---|--|
| 25 | Office, Chief of Ordnance ORDGU-IN Collection and Dissemination Section | 1 | Commanding Officer Detroit Arsenal Centerline, Mich. |
| 1 | ORDTX-AR Executive Library | | Commanding General Aberdeen Proving Ground Maryland |
| 1 | Commanding Officer Frankford Arsenal Philadelphia, Pa. | 1 | Dev. and Proof Service |
| | | 1 | Ballistic Research Lab. |
| | | 1 | Commandant, Ordnance School |
| | | 1 | Ordnance Intelligence Officer |
| 1 | Commanding Officer Picatinny Arsenal Dover, New Jersey | 1 | The Ordnance Board Explosive Ordnance Disposal Division |
| | | | |
| 1 | Commanding Officer Watervliet Arsenal Watervliet, N. Y. | 1 | Chief, Bureau of Ordnance Department of Navy Washington 25, D. C. |
| | | | |
| | Watertown Arsenal Watertown, Mass. | 5 | Central Air Documents Office U. B. Building Dayton 2, Ohio Attn: CADO-D |
| 1 | Laboratory File | | |
| 3 | Extra Copies | | |

Approving Authority:

Ordnance Corps Technical Instruction 200-1-51 dated 4 May 1951
and change 1 thereto.

~~CONFIDENTIAL~~